

**N94- 36409**

*1-27*

*1-13*

## **DEVELOPMENTS IN CARBON MATERIALS**

**Timothy D. Burchell**

Leader, Carbon Materials Technology Group  
Oak Ridge National Laboratory  
Building 4508, MS 6088  
P. O. Box 2008  
Oak Ridge, Tennessee 37831-6088

Telephone 615-576-8595



# DEVELOPMENTS IN CARBON MATERIALS

Timothy D. Burchell  
Leader, Carbon Materials Technology Group  
Oak Ridge National Laboratory

## DEVELOPMENTS IN CARBON MATERIALS

### Overview of Presentation

The following carbon-based materials will be reviewed and their applications discussed:

- The Fullerenes
- Graphite (synthetic or manufactured)
- Activated carbon fibers
- Carbon-carbon composites

Carbon R&D activities at ORNL will be emphasized.

## DEFINITION OF TERMS

### SYNTHETIC GRAPHITE

A MATERIAL CONSISTING OF GRAPHITIC CARBON WHICH HAS BEEN OBTAINED BY GRAPHITIZING NON-GRAPHITIC CARBON.

### CARBON-CARBON COMPOSITES

A CARBON FIBER REINFORCED CARBON MATRIX MATERIAL IN WHICH THE FIBER AND/OR MATRIX MAY BE GRAPHITIC (GRAPHITE-GRAPHITE COMPOSITE)

# FULLERENES

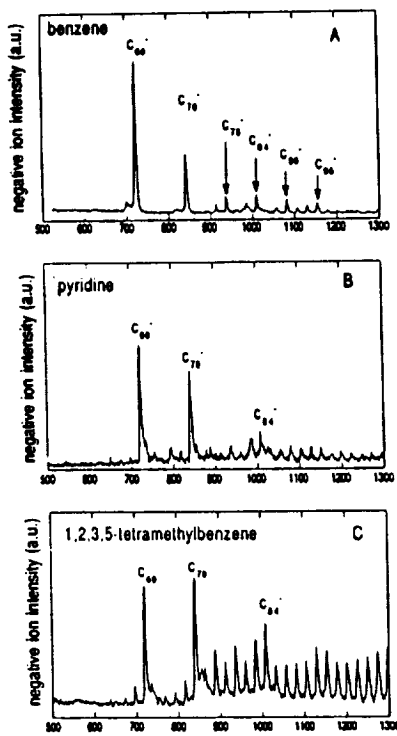
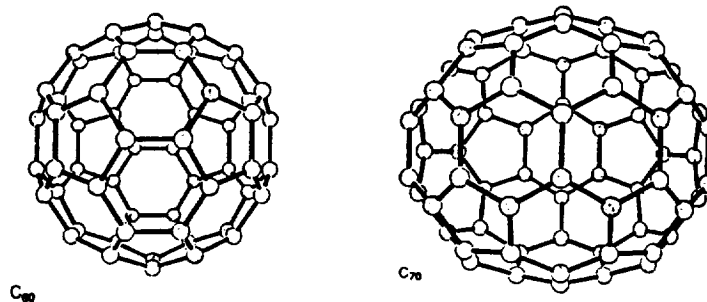
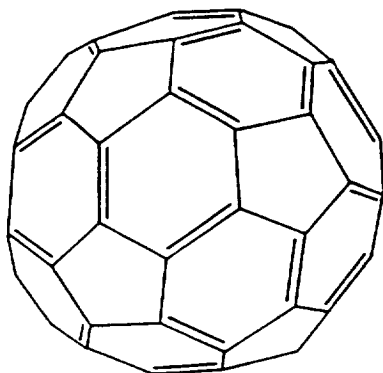

Fig. 4. Laser desorption TOF mass spectra of soot extracts resulting from sequential extractions with (A) benzene, (B) pyridine, and (C) 1,2,3,5-tetramethylbenzene. The spectra are plotted on the same mass scale for comparison.

# THE FULLERENES



# THE FULLERENES



Lowest energy Kekulé structure of soccer ball  $C_{60}$ .  
Reprinted by permission for *Nature* vol. 329, pp. 529-531;  
copyright © 1987 MacMillan Magazines Limited.

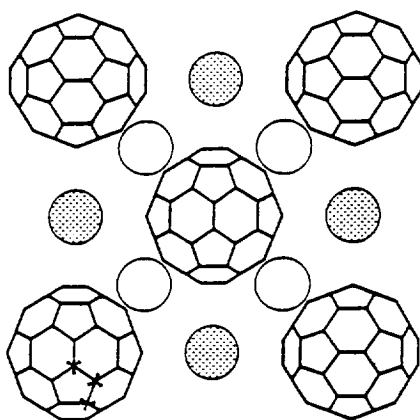

Structure of the  $A_1C_{60}$  superconductors. The open and hatched spheres represent the alkali atom at tetrahedral and octahedral sites, respectively. Note the two possible orientations of the  $C_{60}$  molecules and the three inequivalent carbon sites (marked by arrows on the molecule in the lower left corner) as described in the text. After P. Stephens *et al.*[22]

## Potential Applications of the Fullerenes

- Pharmaceutical
- Tribological (lubricant)
- Super conductor
- Thermal insulator

# SYNTHETIC GRAPHITE

## What is Graphite?

- An allotropic form of carbon
- Hexagonal 2D crystal structure
- Layered crystal planes
- Highly anisotropic
- Conductor in plane, insulator across planes
- A fun material to work with!

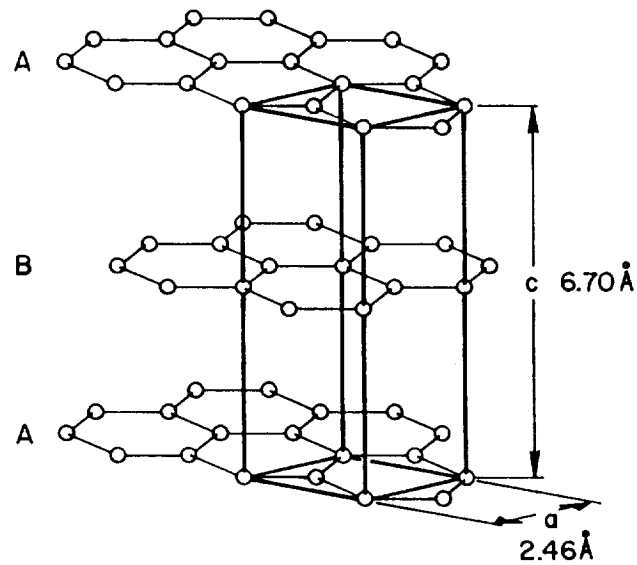

# THE MAJOR PROCESSING STAGES IN THE MANUFACTURE OF CONVENTIONAL ARTIFICIAL GRAPHITES

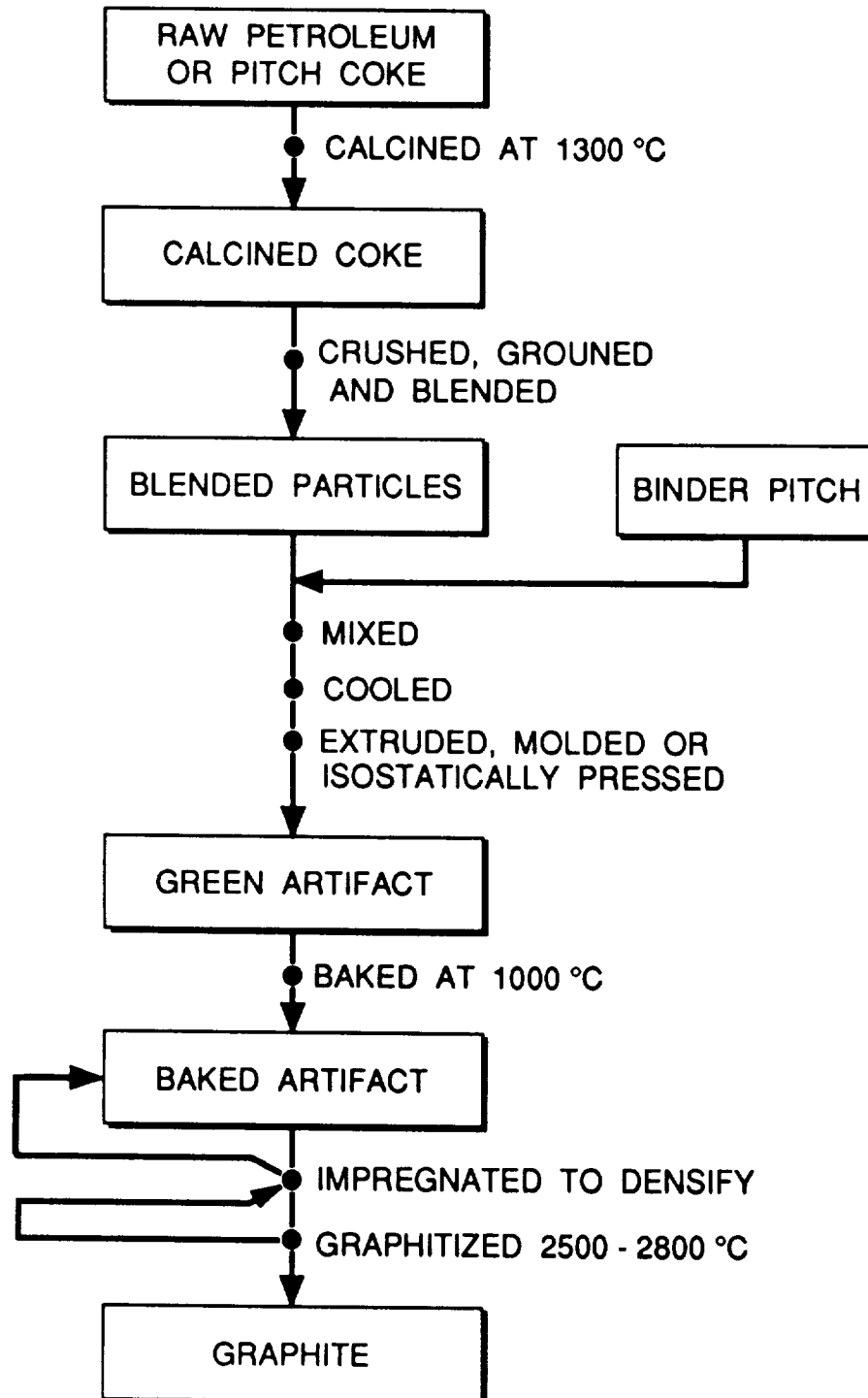

## Graphite Possesses Unique Properties

- High temperature stability
- High electrical and thermal conductivity
- Chemically inert
- Strength increases with temperature
- Processible and machinable to all forms and sizes

## Applications of Graphite

- Arc furnace electrodes
- Resistance heating elements
- Crucibles and boats (semiconductor industry)
- Rocket motor throats, missile nose tips
- EDM electrodes
- Seals and bearings
- Electric motor brushes
- Metal refining and casting
- Nuclear moderator



# The CMT Group Is Developing A Design Data Base For the Graphite Core Of The MHTGR

## Modular High-Temperature Gas-Cooled Reactor With Steam Cycle Power Conversion

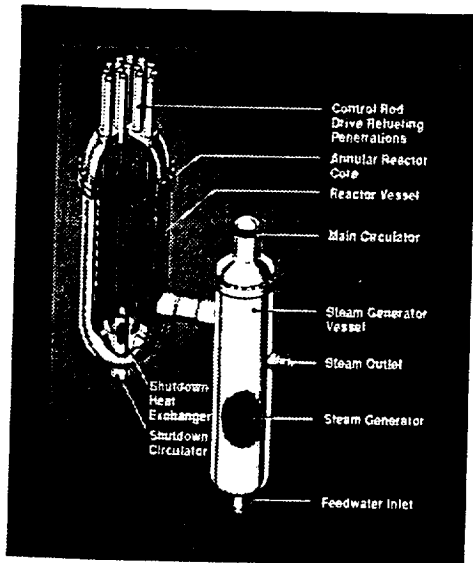

## Graphite Data Base Development

- Effects of reactor environment on graphite properties
  - Neutron irradiation
  - He coolant chemistry and oxidation
  - Temperature and pressure
- Strength, strain to failure
  - Elastic constants
  - Fatigue behavior
  - Fracture mechanics data
  - Thermal physical properties
  - Oxidation behavior and mechanisms
- C/C composite control rod development

# ACTIVATED CARBON FIBERS

## Activated Carbons are a Broad Family of Carbon Materials

- Coal-derived carbons
- Almond shells
- Olive pits, peach pits
- Charcoal
- AC from waste paper
- Activated carbon fibers

## Applications of Activated Carbons

- Gas separation
- Air filtration
- Water filtration
- Solvent recovery
- Military suiting
- Molecular sieves

## Activated Carbon Fibers (ACF)

- ACF can be derived from pitch (coal tar or petroleum), polyacrylonitrile (PAN), or rayon precursors
- Fibers are loosely consolidated into a felt, mat or woven cloth, or rigid porous monolith
- Product is thermally activated at temperatures in the range 700-1000°C in steam

### TYPICAL CARBON FIBER STRUCTURES

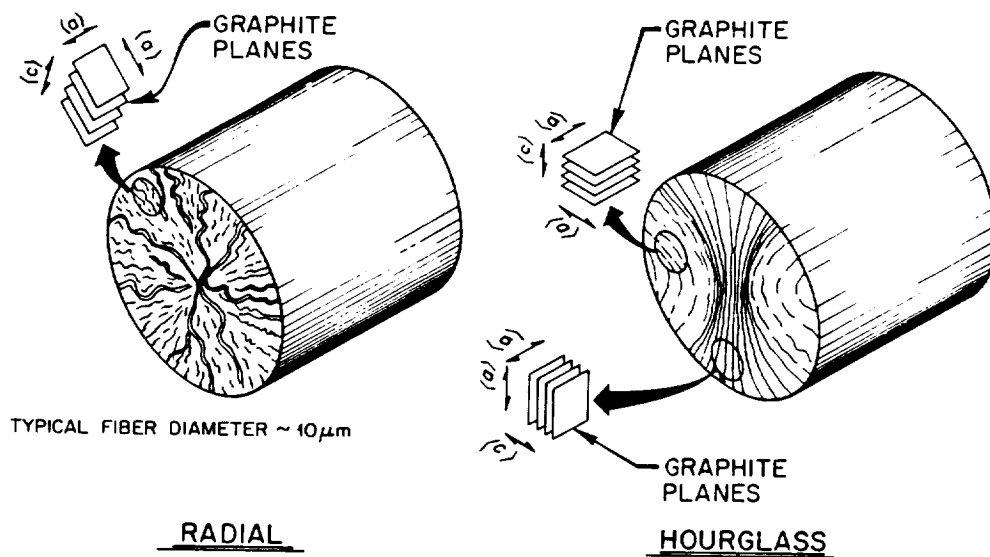

G.M. Pennock et al.  
CARBON, Vol. 31,  
p. 596, 597 1993

## Carbon Fiber Composite Molecular Sieve

At ORNL we have developed a rigid, monolithic-activated carbon material named a carbon fiber composite molecular sieve. The material retains the advantages of ACF and, additionally, overcomes problems associated with granular activated carbons.

**Hydrogen Separation Is Widely Achieved Using Pressure Swing Adsorption Systems**

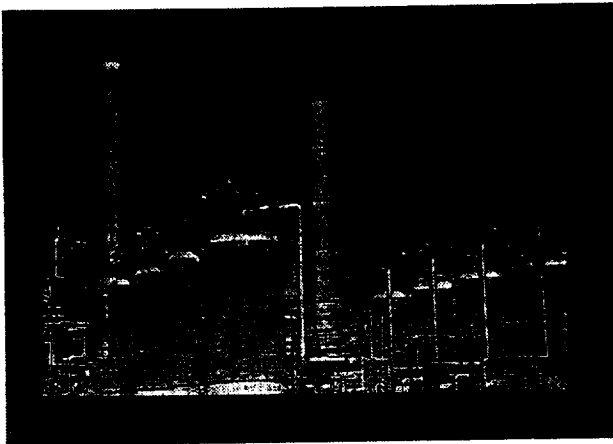

**UOP Polybed PSA Unit treats gas streams from reformer hydrogen plant to produce 66 million SCFD of hydrogen.**

## Gas Separation Is Widely Achieved Using Pressure Swing Adsorption Systems

*"Although there is some room for improvements in the pressure swing adsorption process, the potential gains in process economics in the future are likely to come from the development of new and improved adsorbents."*

- R. V. Jasra, N. V. Choudary, and S. G. T. Bhat  
Research Center, Indian Petrochemicals Corp.  
In their review "Separation of Gases by Pressure Swing Adsorption", Separation Science and Technology, Vol. 26, pp. 885-930, 1991.

## CMT Group Has Developed A Novel Adsorbent/Molecular Sieve Based On Carbon Fibers

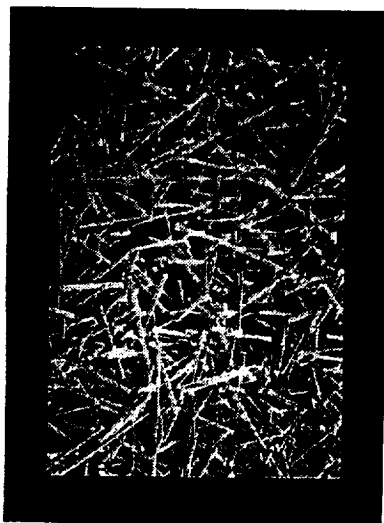

### Carbon Fiber Composite Molecular Sieve

- High adsorption/desorption rates
- High active surface area
- Microporous [5-10 Å] fibers

Applications: Gas separation, gas storage, air filtration, pressure swing adsorption systems

## Activated Carbon Fibers Adsorb And Desorb More Rapidly Than Granular Activated Carbon

- $\text{CCl}_4$  adsorption rate is twice that of granular carbon
- >10 times higher adsorption/desorption rates reported for toluene and methane

### Carbon Tetrachloride Adsorption Rates

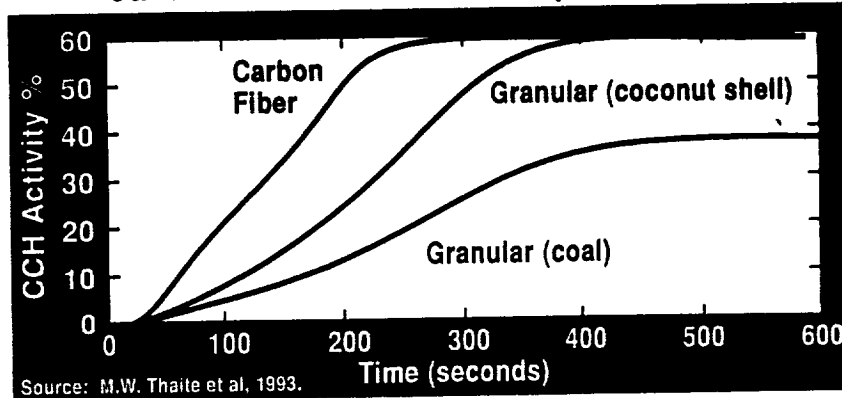

## ORNL Activated Carbon Fiber Composites Have Very High Active Surface Areas

### $\text{N}_2$ BET Surface Areas Of Materials That Have Well-known Molecular Sieve Properties

Molecular Sieve	$\text{N}_2$ ( $\text{m}^2/\text{g}$ )
Linde 5 Å zeolite	316
Linde 4 Å zeolite	35
Linde 3 Å zeolite	11.6
Carbosieve	1040
Saranchar	900
Pitch fiber CFCMS (non-optimal condition)	>1,650

- Active surface areas up to  $1670 \text{ m}^2/\text{g}$  have been achieved with ORNL CFCs
- Carbon fiber active surface areas  $> 2000 \text{ m}^2/\text{g}$  and  $10 \text{ \AA}$  pore width have been reported (OSAKA Gas)

# ORNL Carbon Fiber Composites Have High Active Surface Area And Are Very Microporous

ORNL - UK2 CFCMS Material

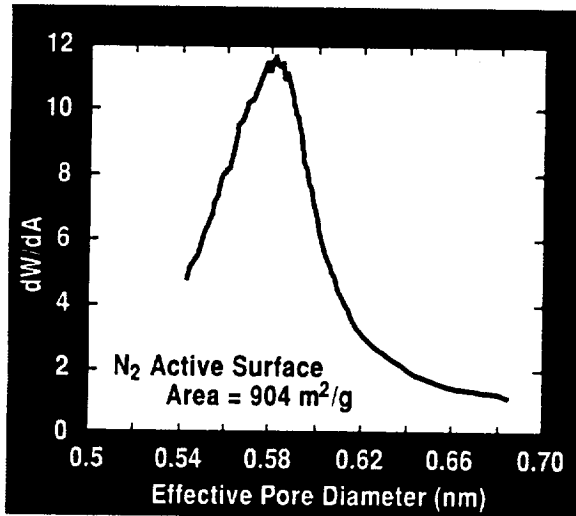

- Narrow pore size distribution
- Pore size centered at  $\sim 6 \text{ \AA}$  pore width
- High active surface area ( $904 \text{ m}^2/\text{g}$ )
- Active surface areas  $>2000 \text{ m}^2/\text{g}$  possible

SEPARATION OF  $\text{CO}_2$  &  $\text{CH}_4$  By CFCMS (STP)  
(Initial composition 50vol%  $\text{CO}_2$  and  $\text{CH}_4$ )

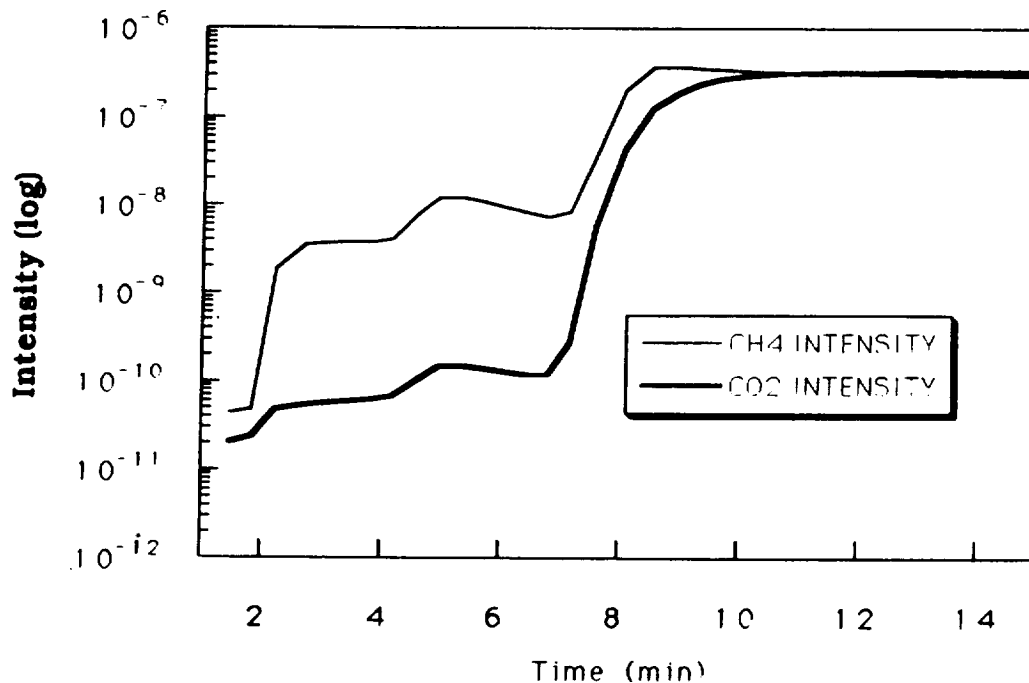

Carbon: CFCMS-48; BET= $822 \text{ m}^2/\text{g}^{-1}$ ,  $L=0.74 \text{ nm}$

## Summary And Conclusions

- **ORNL/UKCAER have developed a monolithic adsorbent carbon based on carbon fibers**
- **Gross macroporosity and microporosity can be controlled through processing variables**
- **Activated carbon fibers have adsorption rates greater than twice that of conventional activated carbons**
- **Very high active surface areas can be developed in carbon fibers (OSAKA gas report  $>2000 \text{ m}^2/\text{g}$  ( $\text{N}_2$ ) ASA, 10 Å pore width)**
- **Narrow micropore size distributions can be achieved in the range 5-10 Å**
- **A monolithic activated carbon material has significant advantages over granular activated materials for use in pressure swing adsorption equipment, such as the elimination of channelling, by-pass flows and pressure drops**



# CARBON-CARBON COMPOSITES

## FLOW DIAGRAM FOR A TYPICAL CARBON / CARBON COMPOSITE PRODUCTION PROCESS

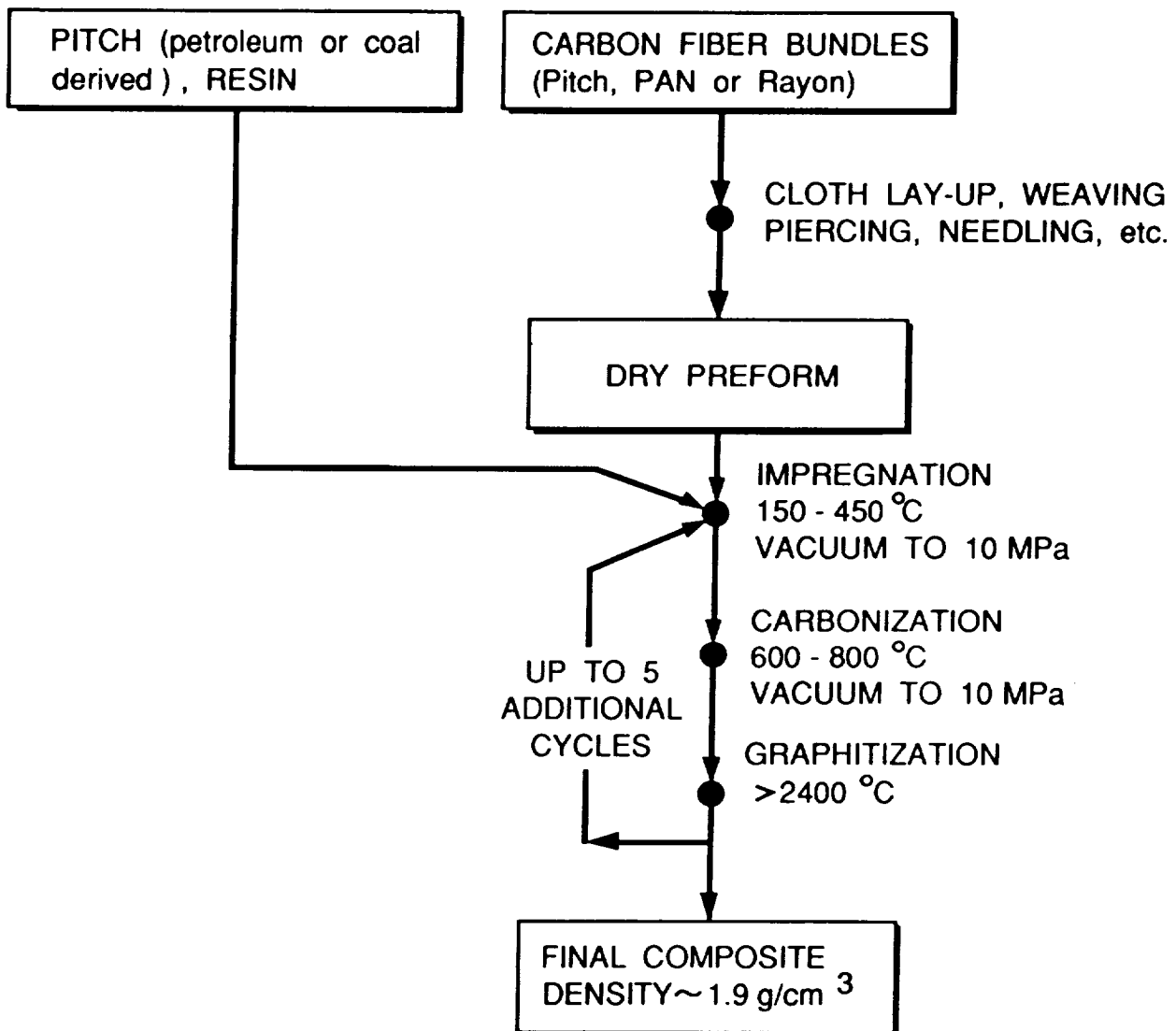

**THE STRUCTURE OF AN ORTHOGONAL CARBON - CARBON COMPOSITE SHOWING THE THREE MUTUALLY PERPENDICULAR FIBER REINFORCEMENT DIRECTIONS ( x, y, and z )**

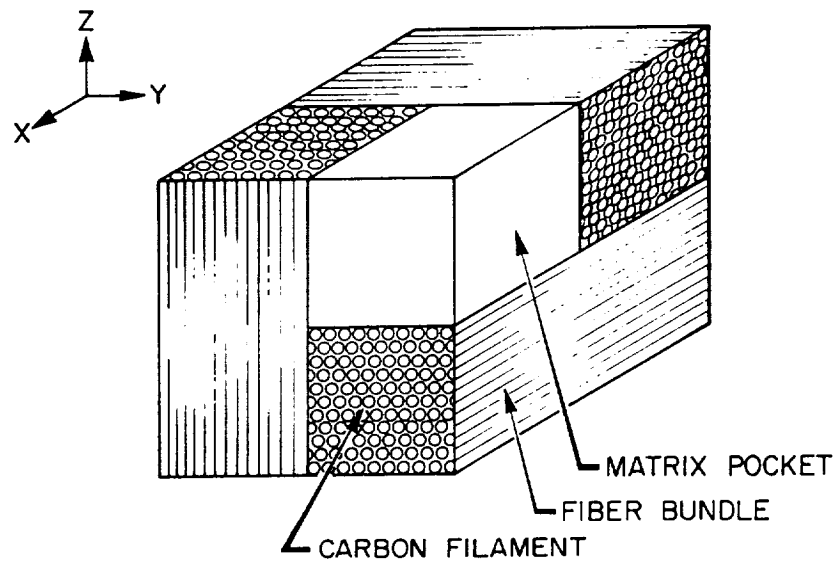

## Applications of Carbon-Carbon Composites

- Reentry vehicle nose tips
- Rocket motor throats and nozzles
- Exit cones
- Aircraft brakes
- Thermal protection
- Thermal management systems
- Fusion reactor first wall armor

## Carbon-Carbon Composites for Fusion Energy Devices

ORNL has an active program to develop high-thermal conductivity, carbon-carbon composites for plasma facing components in tokamak fusion reactors. Moreover, we are investigating the effects of neutron damage on the structure and properties of carbon-carbon composites.

### **CMT Group Is Leading The Development Of Neutron Irradiation Tolerant C/C Composite Materials For Fusion Energy First Wall Applications**

#### **Joint European Torus**

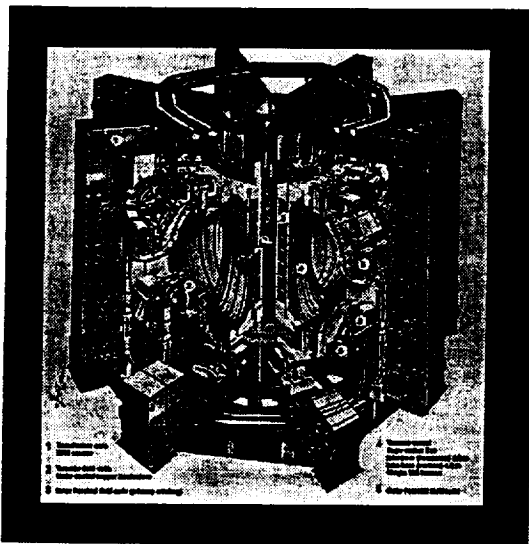

#### **First Wall C/C Composites**

- **Neutron damage**
  - Dimensional stability
  - Effects on thermal conductivity
- **Development of high thermal conductivity uni-directional C/C composite**

# THE MAJOR PLASMA FACING COMPONENTS OF A TOKOMAK FUSION DEVICE

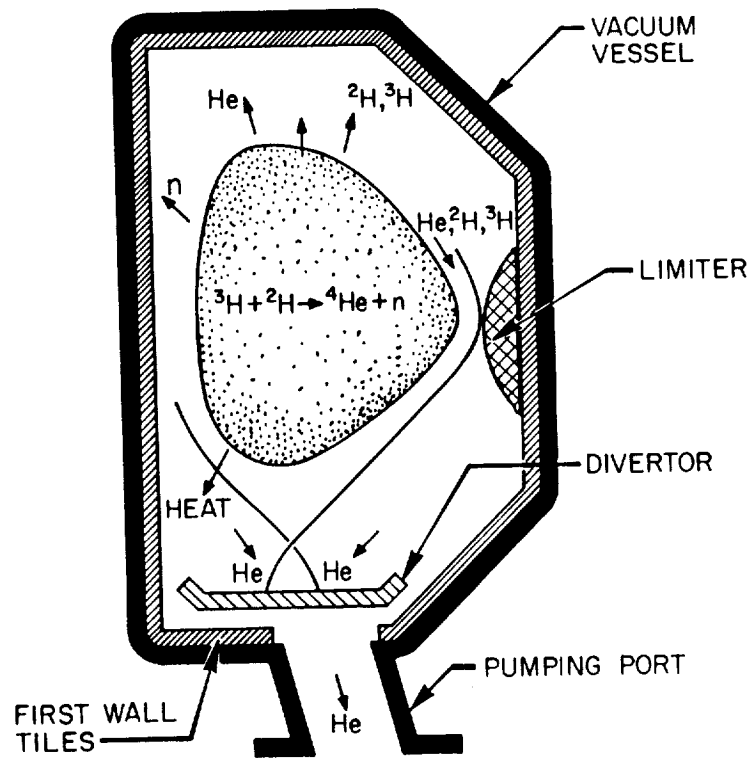

## Carbon Materials Are Widely Used For Tokomak First Wall Armor

JT-60U  
(Japan)

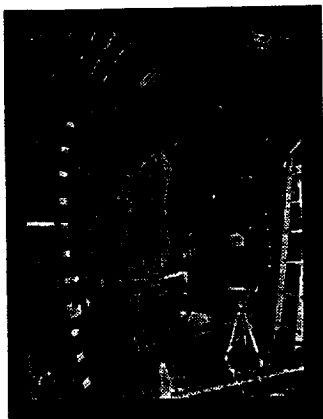

JET  
(England)

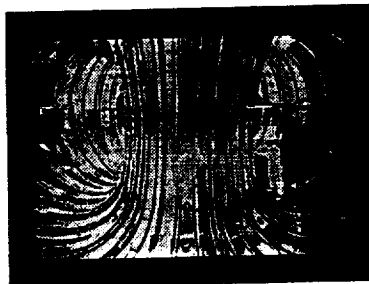

TFTR  
(USA)



# PLASMA FACING COMPONENTS

## MATERIALS REQUIREMENTS

- LOW ATOMIC NUMBER
- HIGH THERMAL CONDUCTIVITY
- GOOD THERMAL SHOCK RESISTANCE
- EROSION RESISTANT (PLASMA SPUTTERING)
- ADEQUATE STRENGTH AND STIFFNESS TO WITHSTAND ELECTROMAGNETIC FORCES DURING DISRUPTIONS
- RESISTANT TO IRRADIATION DAMAGE

## RADIATION DAMAGE IN GRAPHITE

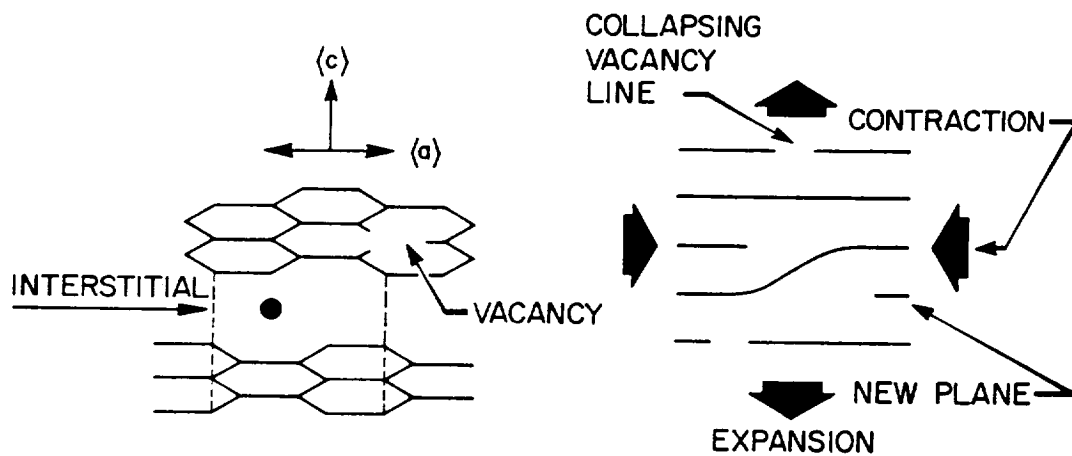

## TYPICAL CARBON FIBER STRUCTURES

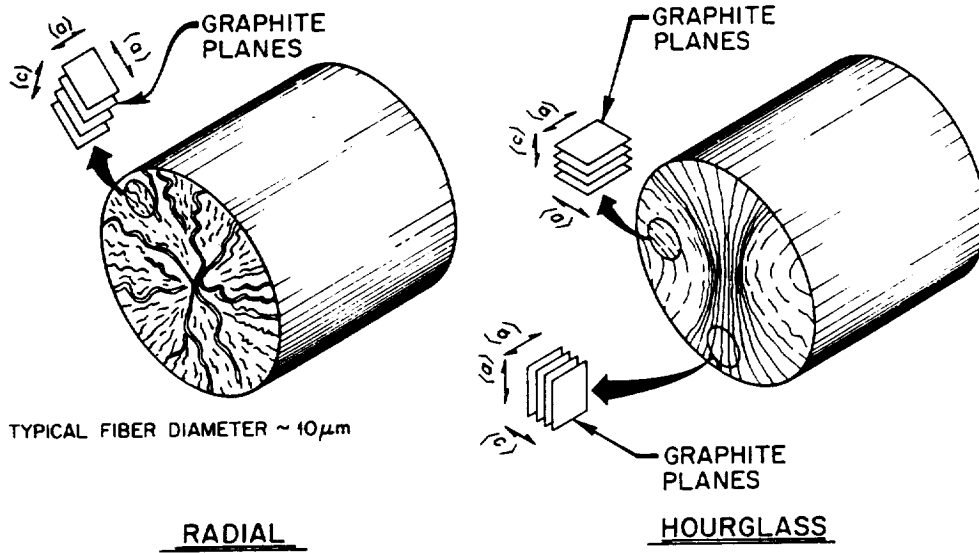

G.M. Pennock et al.  
 CARBON, Vol. 31,  
 p. 596, 597 1993

## MICROSTRUCTURAL INTERPRETATIONS OF IRRADIATION INDUCED DIMENSIONAL CHANGES IN 1D C/C COMPOSITES

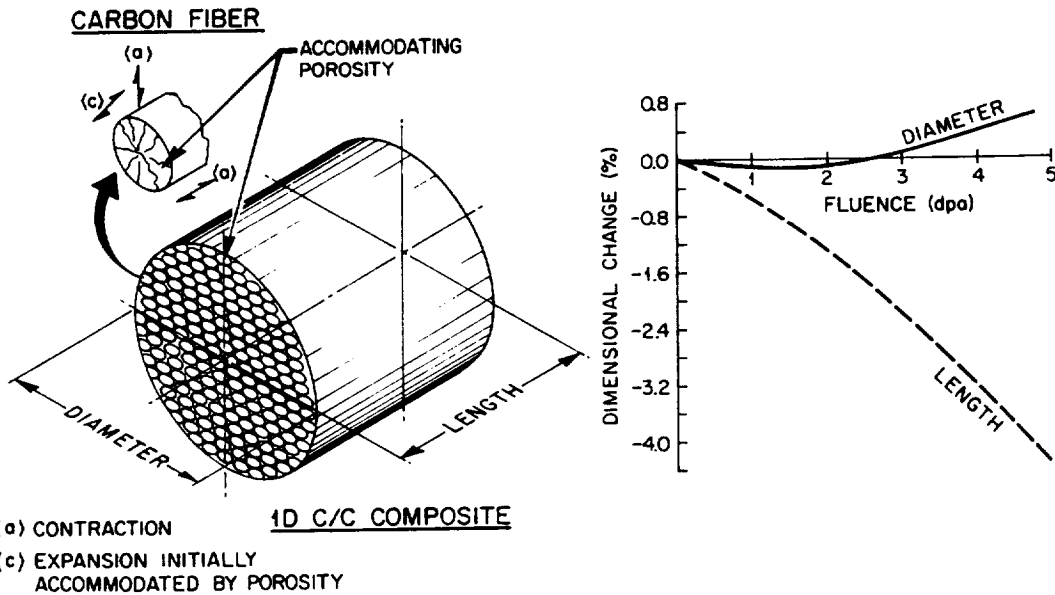

## MICROSTRUCTURAL INTERPRETATIONS OF IRRADIATION INDUCED DIMENSIONAL CHANGES IN 2D C/C COMPOSITES

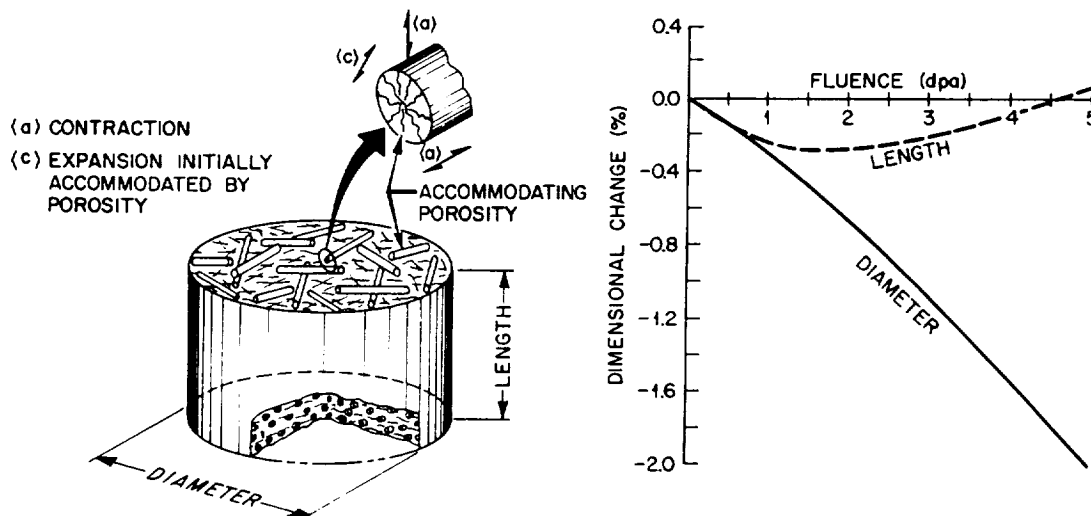

### Developments in Carbon Materials Recommended Texts for Carbon Materials

#### *Introduction to Carbon Science*

Harry Marsh  
Published Butterworth & Co., Ltd., 1989  
ISBN 0-408-03837-3

#### *Carbon Fibers*

J. B. Donnett and R. P. Bansal  
2nd Edition, Published Marcel Dekker  
New York, 1992

#### *The Industrial Graphite Engineering Handbook*

UCAR Carbon Company, 1991  
(39 Old Ridgebury Road, Danbury, CT 06817-0001)

## More Advanced Text:

### *Physics of Graphite*

B. T. Kelly  
Published Applied Science, 1981  
ISBN 0-85334-960-6

### *Adsorption, Surface Area, and Porosity*

S. J. Gregg and K. S. W. Sing  
2nd Edition, Published Academic Press, 1982



# **LIQUIDS THAT TAKE ONLY MILLISECONDS TO TURN INTO SOLIDS**

**John A. Marshall**

School of Industry and Technology  
East Carolina University  
Greenville, North Carolina 27858

Telephone 919-757-6705



## Liquids That Take Only Milliseconds to Turn into Solids

John A. Marshall, PhD  
School of Industry and Technology  
East Carolina University  
Greenville, North Carolina 27858

### KEY WORDS:

Electrorheology, electrorheological fluid, fluid power transmission, hydraulics.

### PREREQUISITE KNOWLEDGE:

The student should understand the elementary concepts of magnetism. A basic understanding of fluid flow would be helpful.

### OBJECTIVE:

To observe the unusual characteristics of electrorheological fluids. To understand how these fluids change from a liquid to a solid. To understand the potential power transmission advantages of these fluids.

### EQUIPMENT AND SUPPLIES:

- 1) Plastic bottle containing electrorheological fluid.
- 2) Energizing probe
- 3) Personal safety equipment
- 4) Paper towels
- 5) Pen

### INTRODUCTION:

Electrorheological fluids change their flow characteristics when subject to an electrical field. Response, which takes only milliseconds, is in the form of a progressive gelling that is proportional to field strength. With no field present, the fluid flows as freely as hydraulic oil (Korane, 1991).

Electrorheological fluids represent a maturing technology that has the potential to widen the performance range of automated electromechanical and electrohydraulic equipment. Research and ongoing developments are refining this technology and experts predict an important future for these fluids.

#### Importance of Electrorheological Fluids:

Current automation capabilities are not advanced enough to build a robot that could play tennis. Even though cameras and computers could direct the robot towards a ball, robots move in an awkward, lumbering fashion because conventional hydraulic valves cannot keep pace with the commands of the computerized controllers.

With electrorheological fluid technology, this type of response time is possible. This technology will allow devices that can operate instantly and without mechanical valves. Increased productivity and better product quality through more dependable and responsive automated equipment is just a small part of what this maturing technology can deliver.

#### How Electrorheological Fluid Functions:

Electrorheological fluids are composed of two primary components. They are the carrier fluid and the suspended particles. The carrier fluid needs to be a good insulator, compatible with the materials they contact. Typical particle materials include polymers, minerals, and ceramics (Scott, 1984).

When an electrical field is applied across the fluid, positive and negative charges on the particles respond by separating, so each particle then has a positive end and a negative end. Particles of the electrorheological fluid then link together in the same manner that the north pole of one magnet is attracted to the south pole of another magnet (Duclos, 1988).

When the electrical field is removed, the particle attraction is no longer present. The fluid then begins flowing freely. Please see Figures 1 and 2.

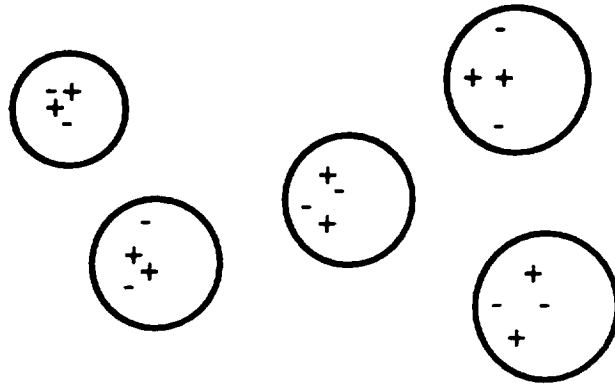

Figure 1 - No electrical field present, charges are random, no particle attraction.

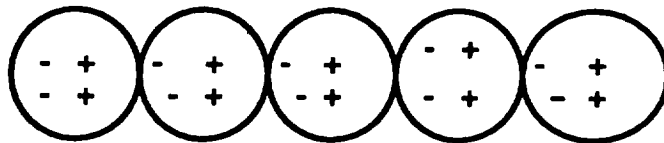

Figure 2 - Probe energizing the fluid, particles linked together.

### Potential Applications:

Electrorheological fluids can change from solids to liquids so fast they will work well with fast-acting computers. These characteristics suggest a number of unusual engineering applications such as fluid clutches and vibration isolators (Duclos, 1988).

According to Hans Conrad, professor of materials science and engineering at North Carolina State University, electrorheological fluids will lead to a whole new generation of brakes, automatic transmissions, actuator devices, hydraulic valves, pump parts, and motors (Conrad, 1992).

### PROCEDURE:

#### Safety Considerations:

1. Be very careful to avoid being shocked by the energizing probe.
2. Protective eye wear is mandatory for all those in the lab area.
3. Do not allow the electrorheological fluid to touch anyone's skin or clothing.
4. Obtain a "Material Data Safety Sheet" on the fluid from the supplier. Read the sheet completely and ask questions relating to any information you do not understand.

#### Electrorheological Fluid Preparation:

1. Check the cap on the plastic bottle containing the fluid and make sure it is securely tightened.
2. Shake the bottle to distribute the stratified particles evenly within the fluid.
3. Set the bottle down on the lab bench and carefully remove the top.

### Observing Electrorheological Fluid as a Liquid:

1. Slowly insert the probe into the container of fluid until the metal rods are submerged approximately two inches below the surface of the fluid.
2. Slowly withdraw the probe from the fluid and hold it slightly above the bottle. Observe what happens to the electrorheological fluid on the metal rods of the probe.
3. Set the probe on a paper towel and record your observations.

### Observing Electrorheological Fluid as a Gelled Solid:

1. Slowly insert the probe into the container of fluid until the metal rods are submerged approximately two inches below the surface of the fluid.
2. Press and hold down the button on the top of the probe.
3. Slowly withdraw the probe from the fluid and hold it slightly above the bottle. Observe the status of the electrorheological fluid on the metal rods of the probe.
4. With the probe slightly above the fluid level in the bottle, release the button (de-energizing the probe) and observe what happens to the electrorheological fluid on the metal rods of the probe.
5. Set the probe down on a paper towel and record your observations.

## **SAMPLE DATE SHEET:**

Record below the characteristics of the fluid when the probe was not energized:

Record below the characteristics of the fluid when the probe was energized:

## **INSTRUCTOR NOTES:**

1. When the probe was removed from the fluid without being energized, students should have observed the fluid flowing off the metal rods and back into bottle. The fluid will flow as easily as oil.
2. When the probe was removed from the fluid while being energized, students should have observed a gelling of the fluid around the rods of the probe.
3. De-energizing the probe will cause the gelled electrorheological fluid to liquify and drip into the bottle.

## **REFERENCES:**

Korane, K.: Putting ER Fluids To Work. Machine Design, May 9, 1991, pp. 52-57.

Scott, D.: Amazing Hardening Fluids Open a New World of Hydraulic Drives. Popular Science, April 1984, pp. 42-46.

Duclos, T.G.: Electrorheological Fluids and Devices. Automotive Engineering, December 1988, pp.45-48.

Conrad, H.: The Impact of ER Fluids. Compressed Air Magazine, March 1992, pp. 14-17.