

# Measurements of Unsteady Pressure and Structural Response for an Elastic Supercritical Wing

---

*Clinton V. Eckstrom, David A. Seidel, and Maynard C. Sandford  
Langley Research Center • Hampton, Virginia*

This publication is available from the following sources:

NASA Center for AeroSpace Information  
800 Elkrige Landing Road  
Linthicum Heights, MD 21090-2934  
(301) 621-0390

National Technical Information Service (NTIS)  
5285 Port Royal Road  
Springfield, VA 22161-2171  
(703) 487-4650

## Abstract

*Results are presented which define unsteady flow conditions associated with the high-dynamic structural response of a high-aspect-ratio, elastic, supercritical wing at transonic speeds. The wing was tested in the Langley Transonic Dynamics Tunnel with a heavy gas test medium. The supercritical wing, designed for a cruise lift coefficient of 0.53 at a Mach number  $M = 0.80$ , experienced the high-dynamic structural response from  $M = 0.90$  to  $0.94$  with the maximum response occurring at  $M \approx 0.92$ . At the maximum response condition of the wing, the forcing function appears to be the oscillatory chordwise movement of strong shocks located on the upper and lower surfaces of the wing in conjunction with flow separation on the lower surface of the wing in the trailing-edge cove region.*

## Introduction

The elastic, supercritical wing discussed in this report was the full-scale right semispan of the second aeroelastic research wing (ARW-2) from the Drones for Aerodynamic and Structural Testing (DAST) program (ref. 1). This research wing was designed to be flight tested to investigate the use of active control systems for maneuver load alleviation, gust load alleviation, and flutter suppression. The structural design of the wing was based on an iterative procedure, which took into account the load and the stiffness reduction benefits provided by the active control systems. This integrated design process resulted in a wing with increased flexibility. A delay in the planned flight-test program provided an opportunity to use the instrumented right semispan of the wing as a flexible model for tests in the Langley Transonic Dynamics Tunnel (TDT). The purpose of the test, which was performed in a heavy gas (R-12), was to verify systems operation, to measure surface-pressure variations on the wing because of forced oscillations of the outboard aileron control surface, and to verify that no unexpected behavior would occur within the planned flight envelope. This test is part of a series of tests to measure unsteady transonic aerodynamic flow characteristics on various wing planforms and airfoil shapes (ref. 2). The test reported herein is the first in the series with a flexible wing as the test article.

In preparation for flight tests of this flexible wing, there were wind tunnel tests of a structurally stiff 0.237-scale model of the flight wing and drone fuselage (refs. 3 and 4). These scale-model tests showed that the drag-divergence Mach number  $M$  for this supercritical wing configuration occurs from  $M = 0.81$  to  $M = 0.83$ . Drag divergence is an indicator that strong shock waves are beginning to form

on the airfoil. The flight envelope for the vehicle was placarded at  $M = 0.86$  because of unstable pitching-moment characteristics measured on the scale model at  $M > 0.86$ .

During the first wind tunnel test of this elastic wing (ref. 5), a region of high-dynamic structural response characterized by wing first-bending motion was unexpectedly encountered near  $M = 0.90$ . Consequently, further tests for measurement of steady surface-pressure, static wing deflections (refs. 6 and 7), and unsteady surface pressure associated with control surface oscillation (ref. 8) were limited to  $M = 0.88$  or less to prevent possible damage to the wing, which was still considered to be a flight article. Although a change in flow characteristics at Mach numbers greater than drag divergence was expected, the large-amplitude response motion of the wing was not anticipated. Prior to the first wind tunnel test of the flexible wing, flutter predictions by linear analysis methods indicated that flutter would occur at dynamic pressures greater than 600 psf, whereas tests were limited to dynamic pressures less than 400 psf. Because linear analysis methods were used, the flutter predictions did not extend into the transonic speed range.

After the first wind tunnel test was completed, the planned flight-test program was canceled. As a result, a second wind tunnel test was performed to explore the region of large-amplitude response of the wing and to define the unsteady flow conditions forcing this response (refs. 9 and 10). The second test showed that the response of the wing occurred in a narrow Mach number region centered near  $M = 0.92$  and that the response increased in magnitude as the test dynamic pressure  $q$  was increased.

The purpose of this paper is to present measurements of motions of the wing and surface pressures

for selected test conditions from the second wind tunnel test. Wingtip accelerometer and wing-root strain gage bridge time-history measurement data are presented with corresponding standard deviation calculations to show the region and the magnitude of the structural response of the wing. Detailed wing surface-pressure coefficient time-history plots are presented to show frequency, magnitude, non-sinusoidal character, and spanwise variation of the flow over the surface of the wing. More conventional chordwise pressure distributions as a function of test dynamic pressure  $q$  and test angle of attack  $\alpha$  are also presented. An extensive frequency domain analysis effort was performed to further define the characteristics of the surface-pressure measurements of the wing and to relate them to the measured response of the wing. Because the results of this effort were inconclusive, wing surface-pressure power spectral density (PSD) results have not been included in this report. Although the oscillation of the wing is shown to be associated with the development of separated flow, the oscillation mechanism has not been explained. However, the oscillating flow characteristics are described in detail to provide a database for further evaluation.

This report presents results from only a portion of the completed tests. The results presented are intended to define the unsteady flow conditions that existed over the range of Mach numbers where high-dynamic structural response of the wing was observed. Additional test activities not reported herein attempted to reduce the dynamic response of the wing. In one test, the outboard control surface was deflected to either  $6^\circ$  or  $-6^\circ$  (ref. 9). In a second test, a spanwise fence was installed on the lower surface of the wing (ref. 9). References 11 and 12 report the use of the outboard control surface with a feedback control system in an attempt to actively control the motion of the wing.

## Symbols and Abbreviations

ARW-2	aeroelastic research wing
$C_p$	pressure coefficient
$C_p^*$	critical pressure coefficient, two-dimensional value
$C_{p_{rms}}$	pressure coefficient variance or standard deviation value
$c$	local chord
$c_l$	section lift coefficient
DAST	Drones for Aerodynamic and Structural Testing program

ESP	electronically scanned pressure
$g$	acceleration due to gravity, $32.2 \text{ ft/sec}^2$
$M, M_\infty$	free-stream Mach number
PSD	power spectral density
$q$	free-stream dynamic pressure, psf
$Re$	Reynolds number based on mean aerodynamic chord length of 1.96 ft
rms	root mean square
TDT	Langley Transonic Dynamics Tunnel
$t/c$	airfoil thickness ratio
$X$	streamwise distance from wing leading edge at centerline of fuselage, in.
$x/c$	streamwise fraction of local chord
$Y$	spanwise distance from centerline of fuselage, in.
$z/c$	vertical fraction of local chord
$\alpha$	angle of attack, deg
$\eta$	fraction of semispan
2-D	two dimensional
3-D	three dimensional

The following symbols are used in the computer-generated tables and figures:

CP	pressure coefficient
ETA	fraction of semispan
G	acceleration due to gravity, $32.2 \text{ ft/sec}^2$
MAX	maximum value of measurements
MEAN	average value of measurements
MIN	minimum value of measurements
MV	millivolts
RANGE	maximum value to minimum value
SGB	output of strain gage bridge, mV
SIGMA	standard deviation, positive square root of variance, root-mean-square (rms) quantity
$X$	streamwise distance from wing leading edge at centerline of fuselage, in.
$X/C$	fraction of local chord
$Y$	spanwise distance from centerline of fuselage, in.

## Test Item and Procedures

### Research Wing

The right semispan of the full-scale wing and a half-body fuselage were used as the test model. They are shown mounted on the TDT test section sidewall in figure 1. Wing planform and dimensional data are presented in figure 2. Excluding the inboard trailing-edge extension, the model had a full span aspect ratio of 10.3 and a taper ratio of 0.40. The supercritical wing model had a semispan length of 9.5 ft and a leading-edge sweep angle of  $28.8^\circ$ . The half-body fuselage had a 25-in-diameter cylindrical cross section with ogive nose and tail sections.

This ARW-2 wing design originated from an early supercritical wing model developed for energy efficient flight. It was designed for a cruise lift coefficient of 0.53 at  $M = 0.80$ . The angle of attack for cruise flight was approximately  $1.35^\circ$ . For a vehicle weight of 2350 lb, the cruise altitude was 46 800 ft at a flight dynamic pressure of 126.4 psf.

The desired shape of the wing for cruise flight incorporated three airfoil shapes. The first airfoil shape defined the inboard wing and fuselage juncture at  $\eta = 0.106$  where the airfoil thickness ratio ( $t/c$ ) was 0.144. The second airfoil shape defined the midspan where the inboard trailing-edge extension ends at  $\eta = 0.426$  with  $t/c = 0.120$ . The third airfoil shape defined the wingtip at  $\eta = 1.000$  with  $t/c = 0.106$ . Straight-line interpolation along a constant percent chord defined the airfoil shape at locations between the three specified airfoils. Coordinates for the three cruise shape airfoils are presented in table 1.

With a flexible wing, it is necessary to use a multistep process to define a fabrication or jig shape that will result in the desired shape of the wing for cruise flight conditions. For the ARW-2 flexible wing, the scale-model surface-pressure measurements of the wing were used to predict the full-scale aerodynamic loads (ref. 4). These aerodynamic loads and a  $1g$  constant were then applied to a structural analysis model of the wing that included structural stiffness and mass characteristics of the wing and mass information for nonstructural components. The calculated deformation of the wing for the cruise condition was then subtracted from the cruise shape to define the jig shape for the wing. Jig shape airfoil coordinates as calculated and as measured after fabrication are listed in reference 13 for 10 semispan stations.

The frequency response characteristics measured in still air for the wing structure are shown in figure 3. The four nodal frequencies in figure 3 are listed

in order of increasing frequency; these include the wing first-bending mode, the wing second-bending mode, the fore and aft in-plane mode, and the wing first-torsion mode. The four frequencies are 8.1, 29.7, 39.9, and 62.6 Hz, respectively. Additional information on the wing structure, the wing mode shapes, and the frequencies is presented in reference 13.

Numerical calculations for comparison of pressure distributions with data presented herein should be based on the fabricated airfoil shapes and must address static deformation of the wing under loading (ref. 13). Time accurate calculations should also include mass and frequency effects.

### Instrumentation

Locations of the surface-pressure measurement orifices and the accelerometers are presented in the wing planform shown in figure 2. The surface pressures of the wing were measured with a separate electronically scanned pressure (ESP) transducer module measurement system for each orifice row (ref. 14). Each ESP module contained 32 pressure transducers, all of which had a common reference pressure port. For this test setup, the reference pressure was the tunnel static pressure. The surface orifices of the wing (0.040-in. diameter) were connected to the pressure transducers by matched metal and plastic tubes with inner diameters of 0.040 in. The total length of each metal and plastic tube was 18 in. The surface pressure was measured with 16 orifices on both the upper and lower surface of the wing at the inboard orifice row and 15 orifices each on both the upper and lower surfaces of the wing at the other five orifice rows for a total of 182 surface-pressure measurements. An additional eight *in situ* pressure transducers were located next to some of the orifices at  $\eta = 0.871$  for calibration, as noted in reference 13. For this report, only surface-pressure measurement data from the outboard three orifice rows ( $\eta = 0.707$ , 0.871, and 0.972) were used.

Vertical response motion of the wing was measured by 10 accelerometers located along the front and rear spars of the wing; the distribution is shown in figure 2. The locations are listed in table 2. Only data from accelerometers 9 and 10 were used for this report. The wing was also equipped with several calibrated strain gage bridges to measure shear, bending-moment, and torsion loads (ref. 15). For the wind tunnel tests, four strain gage bridges were used. Strain gage bridges 1 and 2 were on the front spar, and strain gage bridges 3 and 4 were on the rear spar. All bridges were near the wing root, and their locations are listed in table 2. Only data from strain gage bridge 4 were used for this report. Strain gage

bridge 4 had individual gages located on the upper and lower spar caps (two each); therefore, the bridge was primarily sensitive to bending-moment loads.

### Data Acquisition

For flight-test purposes, the wing was equipped with a digital 10-bit pulse code modulation (PCM) encoder system for telemetric transmission of data from the wing to a receiving station on the ground. This encoder system was used to acquire most of the wing instrumentation data for the wind tunnel test. The sampling sequence of the encoder consisted of a major data frame divided into eight minor frames. Pressure measurements from the three outboard orifice rows were sampled in each minor frame, which resulted in 250 samples per sec. Pressure measurements from the three inboard orifice rows were sampled only once in each major frame for 31.25 samples per sec. For this report, only data recorded at 250 samples per sec were used. The encoder system sampled the measurements sequentially rather than all at the same instant. The sequential sampling arrangement had a small effect on the phase relationship between measurements. At 250 samples per sec, the first measurement within one frame of data was recorded as much as 0.004 sec before the last measurement within the same frame. This sequential sampling system resulted in phase errors from  $0.01^\circ$  per Hz to  $1.4^\circ$  per Hz; the phase error depended on the location of the signals in the sampling lineup. For the data presented herein, no corrections were made for the sequential sampling delays between measurements. Also, corrections were not made for magnitude and phase errors that might result from the short length of the tubes used to connect the surface orifices of the wing to the pressure transducers.

Data from the six outboard accelerometers and the four strain gage bridges were taken at 250 samples per sec. Structural response measurements of the wing presented herein are from the two wingtip accelerometers (9 and 10) and the wing-root bending-moment strain gage bridge (SGB 4). Surface-pressure measurements of the unsteady flow over the wing presented herein were obtained at 250 samples per sec from the three outboard orifice rows. The strain gage bridge signals and accelerometer 9 and 10 signals were filtered with a cutoff frequency of 25 Hz before being encoded and transmitted on the PCM system.

### Wind Tunnel

The model was tested in the Langley Transonic Dynamics Tunnel (TDT), which is a closed-circuit

continuous-flow tunnel with a 16-ft-square test section with cropped corners and slots in all four walls (ref. 16). Mach number and dynamic pressure can be varied simultaneously or independently; either air or a heavy gas (R-12) can be used as the test medium. The heavy gas R-12 was used for the tests reported herein.

### Tests

The Mach number range for the tests reported herein begins at the design cruise speed of  $M = 0.80$  and increases to  $M = 0.96$ . The semirigid scale-model tests of this supercritical wing configuration indicated a drag divergence at  $M = 0.81$  to  $0.83$  (ref. 3). Drag divergence is an indicator of the development of strong shock waves on the surface of the wing. These same semirigid scale-model tests indicated a severe pitch-up problem beginning at  $M = 0.86$ ; therefore, the maximum speed for flight tests was placarded to that Mach number. The high-dynamic response of the wing was observed at  $M = 0.90$  to  $M = 0.94$ , which was well above the normal operating speed for this aircraft configuration; however, most aircraft are required to show that they are free from flutter to speeds 1.2 times the design dive speed. For these tests,  $M = 0.96$  represents 1.2 times the design cruise speed, and the high-dynamic response of the wing did occur within this speed range. Although the high-dynamic response observed for this research wing is not considered to be conventional flutter (bending and torsion interaction), the response was sufficiently large to warrant further investigation.

The supercritical wing was tested at three different tunnel stagnation pressure levels. At each stagnation pressure level, the speed of the tunnel was increased until the desired Mach number was reached. As a result, the test dynamic pressure  $q$  increased slightly during each run as a function of Mach number, as shown in figure 4. Although the dynamic pressure was not constant, the runs at the three different tunnel stagnation pressure levels are referred to as the low  $q$ , medium  $q$ , and high  $q$  conditions. At  $M = 0.92$  the low  $q$  was 78.4 psf, medium  $q$  was 153.3 psf, and high  $q$  was 317.8 psf. Figure 4 also shows the region where the high-dynamic response of the wing was observed and measured and the predicted linear theory flutter boundary, which is located at a much higher dynamic pressure level.

A list of conditions for the low  $q$ , medium  $q$ , and high  $q$  tests reported herein are presented in table 3. For the low  $q$  condition, data acquired at  $\alpha = 0^\circ$  are presented for five Mach numbers. For the medium  $q$  and high  $q$  conditions, data are presented for seven

Mach numbers. For the medium  $q$  conditions, the angle of attack was varied from  $\alpha = -2^\circ$  to  $2^\circ$  in increments of  $1^\circ$ . For the high  $q$  conditions, the primary angle of attack was  $\alpha = 0^\circ$ , although a few test points were obtained at  $\alpha = -1^\circ$  and  $1^\circ$ , as listed in table 3.

## Wing Response Measurements

### Accelerometers

Statistical data (mean, maximum, minimum, and standard deviation) for wingtip accelerometers 9 and 10 for a 10-sec measurement interval are shown in tables 4, 5, and 6 for the low  $q$ , medium  $q$ , and high  $q$  tests, respectively, for all conditions listed in table 3. Examples of measurement time histories for accelerometers 9 and 10 are shown in figure 5 for a 4-sec time interval for all Mach numbers for the medium  $q$  and high  $q$  conditions with the model at  $\alpha = 0^\circ$ . Signals from accelerometers 9 and 10 were subjected to low pass filtering with a cutoff frequency of 25 Hz. Plots of the standard deviation from tables 4, 5, and 6 for accelerometers 9 and 10 are presented in figure 6 for  $\alpha = 0^\circ$ . A PSD analysis for each test condition with  $\alpha = 0^\circ$  was also performed using a 10.24-sec record of wingtip leading-edge data from accelerometer 9. For each test condition, the maximum accelerometer PSD value in the 8-Hz to 10-Hz range was established. These peak PSD values, normalized to a maximum of 1.0, are presented in figure 7 as a function of Mach number for each of the three dynamic pressure test levels. The results presented in figure 7 are consistent with those shown in figure 6; both sets of results indicate that the largest wingtip accelerations shifted from  $M = 0.94$  for the low  $q$  condition to  $M = 0.90$  to  $0.92$  for the high  $q$  condition when the model was at  $\alpha = 0^\circ$ .

The dynamic response measured by the wingtip accelerometers was greater for  $\alpha = -1^\circ$  and  $1^\circ$  than for  $\alpha = 0^\circ$  (tables 5 and 6). The largest dynamic response of the wing occurred for the high  $q$  condition at  $M = 0.92$  at  $\alpha = -1^\circ$  (table 6 tab point 311). A corresponding measurement for  $\alpha = 1^\circ$  was not attempted because of concern for model structural safety.

Results from a peak-hold, frequency response analysis of the wingtip leading-edge accelerometer signal (accelerometer 9) for the high  $q$  condition are presented in figure 8. These results illustrate the frequency range, the rapid growth, and the equally rapid decay of the response of the wing as Mach number was increased from  $M = 0.80$  to  $0.96$ . The results presented in figure 8 were taken in real time during tests with intervals of several minutes for each data

set. The time interval is longer than the 10-sec data intervals used for results in figures 6 and 7.

The accelerometer standard deviations (fig. 6) and the frequency response analysis results (fig. 7) indicate the following: no significant wingtip motion occurred at  $M = 0.80$  and  $M = 0.85$ ; for the high dynamic pressure test condition, the maximum wingtip response occurred from  $M = 0.90$  to  $0.92$  with a significant decrease at  $M = 0.94$ ; for the low  $q$  and medium  $q$  conditions, the maximum response of the wingtip occurred from  $M = 0.92$  to  $0.94$ ; and at  $M = 0.96$ , the motion of the wingtip had essentially subsided for all three dynamic pressure test conditions. The accelerometer peak-hold frequency analyses (fig. 8) show that the frequencies for the large response motions of the wingtip were in the 8-Hz to 10-Hz range, which indicates that the motions of the wing were predominately composed of wing first-bending mode motion.

### Strain Gage Bridges

Statistical data for 10-sec measurement intervals for the rear spar bending-moment strain gage bridge (SGB 4) are presented in tables 7, 8, and 9 for the low  $q$ , medium  $q$ , and high  $q$  conditions, respectively, for all test conditions listed in table 3. Examples of SGB 4 measurement time histories for the medium  $q$  condition at  $\alpha = 0^\circ$  for a 4-sec interval show oscillation amplitude and frequency characteristics (fig. 9). For the  $M = 0.80$ ,  $0.85$ , and  $0.88$  measurements, the bending-moment load measured by SGB 4 increases with Mach number (fig. 9). At  $M = 0.90$ , the bending-moment load has dropped slightly, and higher amplitude response oscillations are seen. At  $M = 0.92$  and  $M = 0.94$ , the loading level has dropped significantly, and it can be observed that 0.5- to 1.0-sec bursts of low frequency wing bending-moment motions are occurring. At  $M = 0.96$ , the bending-moment loading is very low, and the amplitude of oscillations has decreased significantly.

The mean, maximum, and minimum values from SGB 4 measurements listed in tables 7, 8, and 9 for  $\alpha = 0^\circ$  are presented in figure 10 as a function of test Mach number. The SGB 4 mean value data indicates the total loading on the wing. The difference between the maximum value and the minimum value measured over the 10-sec time interval indicates the measurement range that occurs because of loading oscillations. The SGB 4 standard deviation values presented in figure 11 indicate the dynamic-structural response of the wing was similar to that indicated by the wingtip accelerometer measurements, as shown in figure 6.

## Flow Visualization

Wool tufts were placed on the upper and lower surfaces of the wing for several tests to visualize the flow patterns on the wing. These tests were separate from those used to obtain surface-pressure measurements. The tufts were placed on eight span stations located at  $\eta = 0.517, 0.558, 0.635, 0.671, 0.761, 0.816, 0.905,$  and  $0.938$  (fig. 12). The tufts were glued to the wing surface, with each having a free-moving section 1 in. long. On the six inboard span stations the tufts were located every 10 percent of the local chord starting at 10 percent of the chord. On the two outboard span stations, the tufts were located between 10 percent and 90 percent chord at every 20 percent of the local chord location.

Figure 13 lists the regions of separated flow on the wing, as indicated by the tuft data for  $M = 0.85$  to  $0.96$  at  $\alpha = 0^\circ$  for medium  $q$  conditions. Figure 13 also shows sketches of the separated flow regions defined by the tufts. Flow separation on the upper surface is first indicated at  $M = 0.88$ . The region of separated flow then expands upstream and outboard as the Mach number increases to  $M = 0.94$  and then remains constant to  $M = 0.96$ . Flow separation on the lower surface is initially indicated at  $M = 0.90$ . The region of separated flow expands upstream and outboard as Mach number increases to  $M = 0.94$ . At  $M = 0.96$ , the region of separated flow on the lower surface decreases and moves downstream and inboard.

## Unsteady Pressure Measurements

Surface-pressure measurements were recorded for each of the test conditions of table 3. These unsteady pressure measurements are shown as follows: (1) pressure measurement statistical data are presented in tables 10, 11, and 12 for all the test conditions listed in table 3, (2) pressure measurement time-history plots are presented in figures 14, 15, and 16 for all test conditions at  $\alpha = 0^\circ$  in table 3, and (3) chordwise pressure distributions of mean values with measurement ranges are presented in figures 17, 18, and 19 for test conditions at  $\alpha = 0^\circ$  in table 3. The data presented in tables 10, 11, and 12 are the computed measurement mean value, the maximum value, the minimum value, and the standard deviation for each of the pressure coefficients for the 10-sec analysis interval. The surface-pressure measurement time-history plots in figures 14, 15, and 16 are presented for a 0.5-sec interval for each orifice location. The mean value chordwise pressure distributions and the measurement ranges in figures 17, 18, and 19 are a portion of the statistical data from tables 10, 11, and 12.

## Surface-Pressure Measurement Time Histories

Examples of time-history plots of 0.5-sec interval pressure coefficients are presented in figures 14, 15, and 16 for the low  $q$ , medium  $q$ , and high  $q$  conditions, respectively. The columns of time-history measurements in each figure are for the three outboard orifice rows, where high sample rate measurements were obtained. The measurements show that, at some test conditions, there are significant spanwise variations in unsteady pressures as well as chordwise variations. As indicated in the figures, the upper 15 pressure measurements in each column are from the wing upper surface and the lower 15 from the wing lower surface.

In figures 14, 15, and 16 at the left edge of each of the inboard station ( $\eta = 0.707$ ) pressure coefficient time-history records, the zero pressure coefficient location is given as well as a diagonal line from the zero pressure coefficient level to the value for the first data point in the time-history record. Similarly, at the right edge of each pressure coefficient time record (all three semispan stations), the diagonal line goes from the last measurement value in the record to the zero level and is followed by the  $x/c$  position.

No pressure measurements are given for the first three orifice locations on the lower surface at spanwise station  $\eta = 0.707$  because they were found to be invalid. To show the relationship between local pressure oscillations and the oscillatory motion of the wing as measured by the bending-moment strain gage bridge on the rear spar, the output of SGB 4 is included in figures 14, 15, and 16. For the wing first-bending mode, wing-root bending moment is expected to be proportional to wing deflection. Increased SGB 4 output indicates increased upward bending-moment load.

## Chordwise Pressure Distributions

Chordwise pressure distributions for the upper- and lower-surface mean values of the three outboard orifice stations and the ranges for the upper- and lower-surface measurements are presented in figures 17, 18, and 19 for the low  $q$ , medium  $q$ , and high  $q$  conditions, respectively. The mean values and the range of minimum and maximum values for a 10-sec interval for each test condition are listed in tables 10, 11, and 12. The range of values was selected as the method to show the pressure variations because of the nonperiodic form of the pressure variations at several locations. The upper- and lower-surface-pressure measurement ranges are shown separately to prevent overlapping of data.



## Flow Separation

The mean value chordwise pressure distributions and measurement ranges of figures 17, 18, and 19 can also give information on the occurrence of flow separation. The typical practice is to infer the state of the flow from the mean pressure measurements at a few key locations. For this supercritical airfoil, the upper-surface pressure coefficient curve should cross from above (negative value) to below the zero line (positive value) near  $x/c = 0.95$  for attached flow conditions. Good examples of pressure distributions are shown in figure 18(a), where the upper-surface trailing-edge measurements for all three semispan stations are well below the zero line. Trailing-edge separated flow conditions are definitely indicated if the upper-surface trailing-edge pressure measurement at  $x/c = 0.99$  approaches or crosses to the upper side of the zero line. An example of the mean value upper-surface trailing-edge pressure measurement approaching the zero line is shown in figure 18(d) for  $M = 0.90$  at  $\eta = 0.707$ . Note that the range indicates that the measurement has crossed to the upper side of the zero line on at least one occasion. Figure 18(g) shows an example of upper-surface flow separation along the trailing edge at all three semispan stations.

For the wing lower surface, attached flow in the trailing-edge cove region of the supercritical airfoil from  $x/c = 0.60$  to  $0.975$  produces a positive pressure coefficient profile below the zero line, as shown in figures 17, 18, and 19 for  $M = 0.80, 0.85,$  and  $0.88$ . When the flow on the lower surface separates, the pressure coefficients for the cove region move up toward, or across and above the zero line. Localized flow separation in the front portion of the lower-surface cove region often occurs prior to flow separation over the entire cove region. An example is shown in figure 18(e) for measurements at  $\eta = 0.707$ . For attached flow, the lower-surface measurement at  $x/c = 0.66$  should be below the zero line, and the measurement at  $x/c = 0.74$  should be farther below the zero line. These lower-surface measurements at  $x/c = 0.66$  and  $0.74$  indicate a localized flow separation bubble at the leading edge of the cove region with attached flow farther toward the trailing edge, particularly at the last two measurement locations. A schematic of flow with a separation bubble is given in figure 20. Figures 14, 15, and 16, which present pressure coefficient time histories, can also be evaluated for flow separation with the techniques described above.

## Discussion of Results

Chordwise pressure distribution plots showing mean value (time-averaged) data are the most common way of presenting measured surface-pressure data of the wing. If the measurement range is included with the mean value data, it can alert the observer to unsteady flow and its location in the pressure distribution. Corresponding time-history plots of measured surface-pressure coefficients of the wing provide an indication of the cyclic nature, the magnitude, and the frequency variation of individual measurements. The following paragraphs discuss correlating results from the pressure measurements (the time-history plots and the chordwise pressure distributions) and the dynamic response of the wing as observed visually and as measured by a wingtip accelerometer and a wing-root strain gage bridge for each of the test Mach numbers.

### Mach 0.80

Data were recorded at  $M = 0.80$ , which is the wing design Mach number, for the medium  $q$  and high  $q$  conditions. At this Mach number, the wing exhibited little or no significant dynamic response. However, the pressure coefficient time-history measurements (figs. 15(a) and 16(a)) did show that there is a large region of high-frequency unsteady flow on the upper surface of the wing (from  $x/c = 0.29$  to  $0.74$  at  $\eta = 0.707$  and from  $x/c = 0.30$  to  $0.57$  at  $\eta = 0.871$ ). No coherent low-frequency content is noticeable in the pressure measurements, and no significant motion of the wing is indicated by the SGB 4 trace (fig. 9) or by the accelerometer trace (fig. 5), nor was any observed visually. The corresponding chordwise pressure distribution mean value data are presented in figure 18(a) for the medium  $q$  condition and in figure 19(a) for the high  $q$  condition. The largest measurement ranges occur at the inboard station ( $\eta = 0.707$ ) with ranges of lesser magnitude at the outboard station ( $\eta = 0.972$ ). The data shown in figures 15(a), 16(a), 18(a), and 19(a) are for  $\alpha = 0^\circ$ , whereas the design cruise angle of attack for the wing was about  $1.5^\circ$ . A comparison of the inboard upper-surface-pressure coefficient standard deviation data for  $\alpha = 0^\circ, 1.0^\circ,$  and  $2.0^\circ$  for the medium  $q$  condition (tables 11(o), 11(v), and 11(cc)) indicates that the amount of upper-surface flow unsteadiness was similar, but the magnitude increased as the angle of attack was increased. Because  $M = 0.80$  was the design cruise Mach number for this supercritical wing, this region of flow unsteadiness was not expected,

although it did not seem to cause any significant response motion of the wing.

### Mach 0.85

The dynamic response of the wing increased little at  $M = 0.85$  over that experienced at  $M = 0.80$  (figs. 5 through 11). However, there is evidence from the pressure measurements of the development of a strong shock on the upper surface of the wing for all span stations at all three test conditions (low  $q$ , medium  $q$ , and high  $q$ ). The time-history measurements of pressure coefficients for  $M = 0.85$  (figs. 14(a), 15(b), and 16(b)) show a large vertical separation between measurement traces (e.g., fig. 14(a) from  $x/c = 0.74$  to 0.82 at  $\eta = 0.707$ ) which is characteristic of the steep pressure gradient associated with a strong shock. The shock location moves progressively forward for the middle ( $\eta = 0.871$ ) and outboard ( $\eta = 0.972$ ) orifice rows. As the test dynamic pressure is increased, the shock location at each spanwise station moves forward, the pressure change across the shock decreases, and the flow unsteadiness increases. (Compare figs. 14(a), 15(b), and 16(b).) These changes with increased dynamic pressure are believed to result from a decrease in local angle of attack for the supercritical wing. The decreased angle of attack occurs with bending and twist deformation as test dynamic pressure, and therefore wing loading, increases. The levels of loading of the wing for each test condition, as measured by the wing-root bending-moment strain gage bridge, are shown in figure 10.

The chordwise pressure distribution and measurement range data for low  $q$ , medium  $q$ , and high  $q$  conditions at  $M = 0.85$  show shock locations on the upper surface and regions of large flow unsteadiness on both the upper and lower surfaces (figs. 17(a), 18(b), and 19(b)). The measurement ranges are particularly large for the upper-surface shock locations at all three span stations. At  $M = 0.85$ , there was no indication of flow separation. Also, there was no large wing response motion measured (figs. 6 and 11) or observed visually.

### Mach 0.88

At  $M = 0.88$ , data were recorded only for the medium  $q$  and high  $q$  conditions. The pressure coefficient time histories for  $M = 0.88$  show that large-amplitude pressure variations occurred at several orifice locations at each spanwise location (figs. 15(c) and 16(c)). The strong shock locations on the upper surface are readily observable. The large vertical spikes in the pressure traces for  $x/c = 0.74$  at  $\eta = 0.707$ ,  $x/c = 0.68$  at  $\eta = 0.871$ , and  $x/c = 0.43$

at  $\eta = 0.972$  occur when the shock periodically moves across these locations. The frequency of the shock oscillation (fig. 15(c)) appears to be about 15 Hz, whereas the wing bending-moment frequency is about 9 to 10 Hz. The bending-moment frequency can be seen better in figure 9, which gives a longer time interval record for SGB 4 than what appears in figure 15(c). (At  $M = 0.94$ , larger motion of the wing is experienced; the shock frequency decreases and is more clearly associated with the oscillatory motion of the wing (fig. 15(f)). At  $M = 0.88$ , a large pressure gradient on the lower surface of the wing at the outboard orifice row ( $\eta = 0.972$ ) between  $x/c = 0.29$  and 0.36 indicates the existence of a strong shock. A strong shock on the lower surface at the two more inboard stations ( $\eta = 0.707$  and 0.871) is not as obvious, although large pressure oscillations exist across several orifice locations ( $x/c = 0.30$  to 0.57 for  $\eta = 0.871$ ). For the medium  $q$  condition (fig. 15(c)), there are many orifice locations where large-amplitude pressure oscillations occur, but the increase in motion of the wing from  $M = 0.85$  to 0.88 was moderate, as shown by the wing response motion data (figs. 6 and 11). For the high  $q$  condition, the unsteady pressure oscillations on the lower surface of the wing were much larger, and a correspondingly greater increase in measured response motion of the wing from  $M = 0.85$  to 0.88 occurred, as shown in figures 6 and 11.

The chordwise pressure distribution data for  $M = 0.88$  also show that the upper-surface measurement ranges are largest at and near the shock location (figs. 18(c) and 19(c)). For the lower surface of the wing, the range of measured pressure variations is quite large in the midchord region ( $x/c = 0.30$  to 0.51), which may represent shock movement over a large fraction of the chord. Both the trailing-edge pressure coefficient measurements and the observation of the wool tufts at medium  $q$  condition indicated that the flow remained attached in the outboard region of the wing for this Mach number. Although the pressure measurement ranges are very large at  $M = 0.88$ , the wing experienced only a moderate increase in response motion as mentioned earlier.

### Mach 0.90

At  $M = 0.90$ , the response of the wing increased significantly for all test conditions, and it was at or near the maximum response for the high  $q$  condition. The pressure coefficient time histories for  $M = 0.90$  show the continued existence of a strong shock on the upper surface of the wing and the development of a strong shock on the lower surface of

the wing at the inboard ( $\eta = 0.707$ ) and outboard ( $\eta = 0.972$ ) stations (figs. 14(b), 15(d), and 16(d)). On the lower surface at the middle spanwise station  $\eta = 0.871$  for the low  $q$  condition, there appears to be an oscillating weak shock (fig. 14(b)). Also at  $\eta = 0.871$ , a strong shock appears to be developing for the medium  $q$  condition (fig. 15(d)), and at the high  $q$  condition, a strong shock has developed, although it is oscillating across the  $x/c = 0.51$  orifice location (fig. 16(d)). The trailing-edge upper- and lower-surface pressures at  $M = 0.90$  are relatively stable for all spanwise stations at all dynamic pressure test conditions; however, the high  $q$  condition at the inboard station  $\eta = 0.707$  lower-surface measurements from  $x/c = 0.52$  to  $0.97$  show large-amplitude pressure variations (fig. 16(d)). These lower-surface-pressure fluctuations are believed to result from the development of a flow separation bubble that extends roughly from  $x/c = 0.66$  to  $x/c = 0.82$  in the trailing-edge cove region.

The time-history pressure measurements at the medium  $q$  conditions that indicate attached flow (fig. 15(d)) are different from the tuft measurement results shown in figure 13. These tuft measurement results indicate flow separation on the upper-surface trailing edge for all three pressure measurement span stations and on the lower surface at the inboard station,  $\eta = 0.707$ . The surface-pressure measurements and the tuft measurements were taken on separate test runs to assure that the tufts did not interfere with the pressure measurements. It is possible that the tufts may cause flow separation to occur slightly earlier than it would occur for the clean wing because the tufts are surface mounted and will cause some flow disturbance.

The mean value pressure distributions for  $M = 0.90$  show noticeable differences in profile for the low  $q$ , medium  $q$ , and high  $q$  conditions (figs. 17(b), 18(d), and 19(d)). At the low  $q$  condition, the upper-surface-pressure coefficients are higher than those of the lower surface over the entire chord (fig. 17(b)). At the medium  $q$  condition, the upper- and lower-surface mean value pressure coefficients are about equal over the first 40 percent of the chord (fig. 18(d)). For the high  $q$  condition, the lower-surface-pressure coefficients are higher in magnitude than those of the upper surface over the forward portion of the chord (fig. 19(d)). This difference in pressure coefficients is a strong indication that the flexible wing has experienced increased upward bending deflection with increased test dynamic pressure, which for this aft swept wing, effectively results in nose-down twist. Additional nose-down twist occurs because of the aft

chord loading, which is typical of the supercritical airfoil.

For  $M = 0.90$ , the pressure measurement ranges show large amplitudes at the strong shock locations for both upper and lower surfaces. For the high  $q$  condition, at the inboard orifice row  $\eta = 0.707$ , the upward shift of the pressure coefficients in the lower-surface cusp region from  $x/c = 0.66$  to  $x/c = 0.82$  indicate the existence of a flow separation bubble in this region (fig. 19(d)).

The motion of the wing at  $M = 0.90$ , as indicated by the SGB 4 time-history traces in figures 14(b), 15(d), and 16(d), the accelerometer data in figures 6 and 7, and the SGB 4 data in figure 11, shows a significant increase for the high  $q$  condition when compared with the low  $q$  and medium  $q$  conditions. This increase in motion of the wing is consistent with the beginning of flow separation on the lower surface of the wing in the aft cusp region. For the high  $q$  condition, the wingtip motion was visually observed to be very large, which was consistent with the instrument measurements.

### Mach 0.92

At  $M = 0.92$ , the observed wingtip motions were at or near maximum for each of the dynamic pressure test conditions (figs. 6, 7, and 11). For the high  $q$  condition, the wingtip motions were large enough to cause concern for the structural safety of the wing. The time-history measurements of pressure coefficients at  $M = 0.92$  show large-amplitude pressure oscillations associated with strong shocks on both the upper and lower surfaces of the wing at all three semispan stations (figs. 14(c), 15(e), and 16(e)).

The mean pressure coefficient distributions at  $M = 0.92$  show the strong shock locations and the associated large measurement ranges on both the upper and lower surfaces of the wing (figs. 17(c), 18(e), and 19(e)). These mean pressure distributions also indicate the existence of some flow separation at the upper-surface trailing edge, the development of a lower-surface flow separation bubble at the inboard station for the low  $q$  and medium  $q$  conditions, and the increase in size of the flow separation region for the high  $q$  condition. At the inboard station  $\eta = 0.707$ , the flow appears to be separated at the upper-surface trailing edge for all three test conditions. For the midwing station  $\eta = 0.871$ , the upper-surface trailing-edge flow appears to be separated for the low  $q$  condition, but it is attached for the medium  $q$  and high  $q$  conditions. On the lower surface of the wing, a separation bubble exists in the aft cusp region at the inboard and midwing stations

( $\eta = 0.707$  and  $\eta = 0.871$ ) for all three test conditions. However, the size of the separation region increases from a single orifice location ( $x/c = 0.66$  at  $\eta = 0.707$  and  $x/c = 0.68$  at  $\eta = 0.871$ ) for the low  $q$  condition to a much larger area ( $x/c = 0.66$  to  $0.90$  at  $\eta = 0.707$  and  $x/c = 0.68$  to  $0.91$  at  $\eta = 0.871$ ) for the high  $q$  condition. The variations in flow separation at the inboard and midwing span stations for the low  $q$ , medium  $q$ , and high  $q$  conditions are consistent with a decrease in local angle of attack because of twist for the flexible wing as test dynamic pressure is increased. At the farthest outboard semispan station  $\eta = 0.972$ , the flow appears to remain attached for all three dynamic pressure test conditions, although large-amplitude pressure variations existed on the lower surface for the high  $q$  condition.

The SGB 4 time histories for  $M = 0.92$  show a significant increase in oscillation amplitude for the low  $q$  and medium  $q$  conditions over that experienced at  $M = 0.90$  (figs. 14(c) and 15(e)). For the high  $q$  condition, the oscillation in the SGB 4 measurement remained at approximately the same high level as for the  $M = 0.90$  case (fig. 16(e)). These SGB 4 measurement relationships are also shown in figure 11.

#### Mach 0.94

The wing motion decreased significantly from  $M = 0.92$  to  $M = 0.94$  for the high  $q$  condition, whereas for the medium  $q$  or low  $q$  conditions, the wing motions remained at about the same level (figs. 6, 7, and 11). The pressure coefficient time-history measurements at  $M = 0.94$  for the low  $q$  and medium  $q$  conditions show that a separation bubble exists on the lower surface, continuously or intermittently, for all three spanwise stations (figs. 14(d) and 15(f)). For the high  $q$  condition (fig. 16(f)), the flow has completely separated in the lower-surface cusp region for the two inboard spanwise stations ( $\eta = 0.707$  and  $\eta = 0.871$ ); at the outboard station ( $\eta = 0.972$ ), the size of the separation bubble has increased significantly ( $x/c = 0.70$  to  $x/c = 0.90$ ). The associated pressure oscillations in this region are greatly reduced for the high  $q$  condition from those of the low  $q$  and medium  $q$  conditions where the flow is separated at the beginning of the cove region but reattaches near the trailing edge. For the low  $q$  condition, the steep pressure gradient associated with a strong shock is not observable for the outboard orifice row ( $\eta = 0.972$ ) for either the upper or lower surface, although the largest pressure oscillations are at the outboard station (fig. 14(d)).

The mean pressure coefficient distributions for  $M = 0.94$  show that significant continuous flow sep-

aration exists on both the upper and lower surfaces (figs. 17(d), 18(f), and 19(f)). At the low  $q$  condition, the mean value chordwise pressure distribution for the outboard span station ( $\eta = 0.972$ ) does not show the steep pressure gradient associated with a strong shock in the aft chord region, but rather it shows a region where the measurement range is quite large (fig. 17(d)). Data for the medium  $q$  condition show large measurement ranges associated with shock locations as well as indications of separated flow on the upper surface and in the lower-surface cove region at all semispan stations (fig. 18(f)). At the high  $q$  condition, the data show that flow separation exists on the upper and lower surfaces at all semispan stations with small measurement ranges for the inboard and midwing stations, except at shock locations (fig. 19(f)). At  $M = 0.94$ , the motion of the wing as observed and measured by SGB 4 and accelerometer 9 was significantly decreased for the high  $q$  condition, but it remained comparable to that at  $M = 0.92$  for the low  $q$  and medium  $q$  conditions.

#### Mach 0.96

At  $M = 0.96$ , the motion of the wing as measured by the wingtip accelerometer and the wing-root strain gage bridge and as observed visually had substantially decreased for all dynamic pressure test conditions; therefore, it was no longer a concern with regard to safety of the wing. The time-history measurements of pressure coefficients for  $M = 0.96$  show that trailing-edge flow separation has occurred on both the upper and lower surfaces of the wing for all span stations and all dynamic pressure test conditions (figs. 14(e), 15(g), and 16(g)). The SGB 4 measurement traces show very little oscillation, and as previously described, motion of the wing had almost completely subsided. The mean pressure coefficient chordwise distributions at  $M = 0.96$  show separated flow conditions on the upper-surface trailing edge and all through the cove region on the lower surface (figs. 17(e), 18(g), and 19(g)). There was very minimal response motion of the wing at this Mach number for all three dynamic pressure test conditions.

#### Summary

The buildup in dynamic response of the wing for each dynamic pressure test condition is associated with the development of strong shocks, first on the upper surface of the wing and then on the lower surface of the wing. The maximum dynamic response of the wing appears to be associated with the development of a flow separation bubble on the lower surface of the wing in the trailing-edge cove region ( $x/c = 0.60$  to  $0.80$ ). The flow separation bubble appears first at the more inboard semispan

station ( $\eta = 0.707$ ) and moves outboard with increasing Mach number. The motion of the wing decreases significantly as soon as the flow separation on the lower surface extends all the way to the trailing edge at the more inboard span stations. This generally correlates with flow separation at the upper-surface trailing edge. Because of changes in wing shape (bending and twist) with loading, the dynamic response buildup and decay occurred at slightly lower Mach numbers for the high  $q$  condition than for the low  $q$  and medium  $q$  conditions.

### Effects of Wing Loading and Flexibility

The chordwise pressure distributions in figures 17, 18, and 19 showed the most significant unsteady flow conditions occurred on the outboard portion of the wing. It was mentioned in the discussion for the  $M = 0.85$  test conditions that changes of local angle of attack occurred as a function of test dynamic pressure because of wing bending and twist deformation caused by aerodynamic loading. A comparison of mean value chordwise pressure distributions for the low  $q$ , medium  $q$ , and high  $q$  conditions for the model at  $\alpha = 0^\circ$  are presented in figure 21(a) for the upper surface of the wing and in figure 21(b) for the lower surface of the wing for each Mach number test condition. The figures show differences that are believed to occur primarily because of the deformation of the wing with loading. It is acknowledged that as the test dynamic pressure is increased for any given Mach number, the test Reynolds number also increases, as shown in table 3.

For the upper surface of the wing, the largest changes in chordwise mean pressure distributions for the three test dynamic pressures are at  $M = 0.85$  for the forward portion of the chord and  $M = 0.92$  to  $M = 0.96$  for the shock location on the aft portion of the chord (fig. 21(a)). At  $M = 0.92$ , the large shift forward in shock location at  $\eta = 0.707$  occurs at the high  $q$  condition. For span station  $\eta = 0.871$ , the shock location for the medium  $q$  condition is farther aft than for the low  $q$  and high  $q$  conditions. This is true at span station  $\eta = 0.871$  for  $M = 0.88$  through  $M = 0.96$ , whereas for the inboard station ( $\eta = 0.707$ ) and outboard station ( $\eta = 0.972$ ), the medium  $q$  upper-surface data fall on or between the high  $q$  and low  $q$  data. Note that for  $M = 0.80$  and  $M = 0.88$ , no low  $q$  data are available.

For the lower surface of the wing, the most significant changes occur in the aft cove region where flow becomes separated as Mach number and test dynamic pressure are increased (fig. 21(b)). Flow separation is indicated first at the inboard station  $\eta = 0.707$  for the high  $q$  condition at  $M = 0.90$ . At

$M = 0.92$ , flow separation in the cove region is indicated at both  $\eta = 0.707$  and  $\eta = 0.871$ . At  $M = 0.96$ , the mean pressure distributions indicate that the flow is separated in the cove region for all three test dynamic pressures.

### Effects of Angle-of-Attack Changes

The effects of changes in angle of attack on the chordwise distribution of pressure coefficient mean values for the three spanwise station orifice rows at each Mach number are presented in figure 22(a) for the upper surface of the wing and in figure 22(b) for the lower surface of the wing. All data presented in figure 21 are for the medium dynamic pressure test condition with a range from  $\alpha = -2^\circ$  to  $2^\circ$  in increments of  $1^\circ$ . Because the wing is flexible, changes in loading of the wing with changes in the angle of attack of the model will also result in changes in wing bending and twist deformation.

The primary changes in the mean value pressure distributions on the wing upper surface occur on the forward portion of the chord with increasing negative pressure as angle of attack is increased, as would be expected (fig. 22(a)). At  $M = 0.80$ , evidence of a strong shock on the upper surface occurs only at the highest angle of attack ( $\alpha = 2^\circ$ ). At  $M = 0.85$ , a strong shock on the upper surface is evident at  $\alpha = 1^\circ$  and  $\alpha = 2^\circ$ .

For the lower surface of the wing the changes in leading-edge pressures are inversely proportional to angle of attack, as expected (fig. 22(b)). Strong shocks occur on the lower surface at  $M = 0.88$  for  $\alpha = -2^\circ$  and  $-1^\circ$ . At  $M = 0.92$ , strong shocks occur on the lower surface for all angles of attack tested, and flow separation is indicated in the lower-surface cove region ( $x/c > 0.6$ ) for the inboard stations for the more negative angles of attack.

### Comparison With Rigid Two-Dimensional Model Test Data

Measurements similar to measurements presented herein were made for surface-pressure fluctuations measured on a two-dimensional (2-D), rigid, conventional NACA 0012 airfoil section and on an early supercritical airfoil section (DSMA 523), and they are reported in reference 17. Figures 23 and 24, which are reproduced from reference 17, show carpet plots of pressure coefficient fluctuation (rms) values for these models as a function of chord position and Mach number. A similar presentation for the ARW-2 flexible three-dimensional (3-D) model is shown in figure 25 for data measured on the upper surface of the wing at semispan station  $\eta = 0.871$  for the

medium  $q$  conditions and  $\alpha = 2^\circ$  to give the closest correlation in lift coefficients between the different sets of data. The ARW-2 data are standard deviation (rms) values from tables 11(cc) and 11(ii). A more direct comparison between data for 2-D models and 3-D swept wing models would result if the Mach number for the swept wing model was multiplied by the cosine of the wing sweep angle. For the ARW-2 model, this comparison was more difficult because the model was tapered, which makes the local sweep angle different at each chord position. For example, the leading-edge sweep angle is  $28.8^\circ$ , but the midchord sweep angle is  $25.0^\circ$ .

The data for the 2-D rigid NACA 0012 airfoil indicate that the maximum pressure fluctuations occur at the shock region, which moves slightly aft as Mach number is increased (fig. 23). Also, the data for the NACA 0012 airfoil show an increase in pressure fluctuation behind the shock for the higher Mach number conditions, which indicates separated flow for those test conditions. The data for the 2-D rigid DSMA 523 supercritical airfoil also indicate that the maximum pressure fluctuations are at the shock region (fig. 24). The shock location moved much farther aft with increased Mach number for the DSMA 523 airfoil than for the NACA 0012 airfoil. The data for the DSMA 523 airfoil also show an increase in pressure fluctuations, which indicates separated flow behind the shock at higher Mach number conditions. The data for the 3-D flexible ARW-2 supercritical wing section also show the largest pressure fluctuations in the shock region (fig. 25). The shock region for the ARW-2 section is far forward at  $M = 0.80$ , but it moved back significantly at  $M = 0.85$  and then moved back in smaller increments as Mach number is increased farther. For the ARW-2 section, the pressure fluctuations are largest at  $M = 0.88$  and  $M = 0.90$  for  $\alpha = 2^\circ$ . The increase in pressure fluctuations behind the shock, which indicates separated flow, is present for  $M = 0.90$  and higher, as shown in figure 25. A comparison of the pressure fluctuations of all the models shows that the magnitude of pressure fluctuation at the shock region is similar for the rigid 2-D airfoils and the 3-D flexible ARW-2 model.

## Concluding Remarks

A high-aspect-ratio, flexible, supercritical wing was tested in the Langley Transonic Dynamics Tunnel to investigate a region of high-dynamic response of the wing that occurred in the transonic speed range. Accelerometer measurements indicated that significant wingtip motions occurred between test Mach numbers  $M = 0.90$  and  $M = 0.94$  with peak

response occurring at about  $M = 0.92$ . Tests at different test dynamic pressure levels  $q$  revealed that the Mach number region at which wing high-dynamic response was experienced remained nearly the same, but that the magnitude of wingtip motion increased as the test dynamic pressure was increased.

Surface-pressure measurements were obtained as part of the effort to define the unsteady flow conditions forcing the wing motion. These data are presented as tables of statistical data, pressure measurement time histories, and plots of chordwise pressure coefficients. The pressure measurement time histories show the magnitude and the frequency of the unsteady pressure oscillations, whereas flow separation was more easily determined from the chordwise pressure distributions.

The time-history measurements revealed that some high-frequency unsteady flow existed at the wing design cruise Mach number  $M = 0.80$ , although no significant wing motion occurred. As the Mach number was increased to  $M = 0.88$ , the upper surface of the wing developed steady supersonic flow over the forward portion of the chord. This flow was followed by a strong shock whose location oscillated across at least one pressure measurement orifice location. Although the measured pressure variations were large at  $M = 0.88$ , the wing experienced only moderate response motion. As the Mach number was increased to  $M = 0.92$ , the wing developed supersonic flow over the forward portion of the chord that was followed by strong shocks on both the upper and lower surfaces. The pressure variations with the largest amplitude occurred at the strong shock locations with smaller variations primarily aft of the shock in the trailing-edge region, particularly on the lower surface of the wing. At the high dynamic pressure test condition for  $M = 0.92$ , the wing motion was of sufficient magnitude to cause concern for the structural safety of the wing. When the test Mach number was increased to  $M = 0.96$ , the pressure measurements exhibited very small dynamic variations, and the motion of the wing essentially disappeared.

The maximum dynamic response of the wing appears to be associated with the development of a flow separation bubble on the lower surface of the wing in the trailing-edge cove region. The flow separation bubble appears first at the more inboard fraction of the semispan ( $\eta = 0.707$ ) and increases in length and also moves outboard with increasing Mach number. For the high  $q$  condition, the separation bubble appears first at  $M = 0.90$ , whereas for the low  $q$  and medium  $q$  conditions, it appears first at  $M = 0.92$ . This difference is attributed to increased loading of the wing for the high  $q$  condition and therefore a

difference in wing shape (twist). At  $M = 0.96$ , with wing motion subsided, flow separation had occurred at the upper-surface trailing edge. On the lower surface, the flow had changed from a flow separation bubble to a complete separation from the forward edge of the cove region to the trailing edge of the wing.

NASA Langley Research Center  
Hampton, VA 23681-0001  
August 11, 1994

## References

1. Murrow, H. N.; and Eckstrom, C. V.: Drones for Aerodynamic and Structural Testing (DAST)—A Status Report. *J. Aircr.*, vol. 16, no. 8, Aug. 1979, pp. 521-526.
2. Sandford, M. C.; Ricketts, R. H.; and Hess, R. W.: *Recent Transonic Unsteady Pressure Measurements at the NASA Langley Research Center*. NASA TM-86408, 1985.
3. Byrdson, Thomas A.; and Brooks, Cuyler W., Jr.: *Wind Tunnel Investigation of Longitudinal and Lateral-Directional Stability and Control Characteristics of a 0.237-Scale Model of a Remotely Piloted Research Vehicle With a Thick, High-Aspect-Ratio Supercritical Wing*. NASA TM-81790, 1980.
4. Byrdson, Thomas A.; and Brooks, Cuyler W., Jr.: *Wind-Tunnel Investigation of Aerodynamic Loading on a 0.237-Scale Model of a Remotely Piloted Research Vehicle With a Thick, High-Aspect-Ratio Supercritical Wing*. NASA TM-84614, 1983.
5. Seidel, David A.; Sandford, Maynard C.; and Eckstrom, Clinton V.: Measured Unsteady Transonic Aerodynamic Characteristics of an Elastic Supercritical Wing. *J. Aircr.*, vol. 24, no. 4, Apr. 1987, pp. 225-230.
6. Sandford, Maynard C.; Seidel, David A.; and Eckstrom, Clinton V.: *Steady Pressure Measurements on an Aeroelastic Research Wing (ARW-2)*. NASA TM-109046, Feb. 1994.
7. Byrdson, Thomas A.; Adams, Richard R.; and Sandford, Maynard C.: *Close-Range Photogrammetry Measurement of Static Deflections for an Aeroelastic Supercritical Wing*. NASA TM-4194, 1990.
8. Seidel, David A.; Sandford, Maynard C.; and Eckstrom, Clinton V.: *Unsteady-Pressure and Dynamic-Deflection Measurements on an Aeroelastic Supercritical Wing*. NASA TM-4278, 1991.
9. Seidel, David A.; Eckstrom, Clinton V.; and Sandford, Maynard C.: Transonic Region of High Dynamic Response Encountered on an Elastic Supercritical Wing. *J. Aircr.*, vol. 26, no. 9, Sept. 1989, pp. 870-875.
10. Eckstrom, Clinton V.; Seidel, David A.; and Sandford, Maynard C.: Unsteady Pressure and Structural Response Measurements on an Elastic Supercritical Wing. *J. Aircr.*, vol. 27, no. 1, Jan. 1990, pp. 75-80.
11. Adams, William M., Jr.; Tiffany, Sherwood H.; and Bardusch, Richard E.: Active Suppression of an "Apparent Shock Induced Instability." *A Collection of Technical Papers, Part 2A: AIAA/ASME 28th Structures, Structural Dynamics and Materials Conference*, Apr. 1987, pp. 491-505. (Available as AIAA-87-0881.)
12. Seidel, David A.; Adams, William M., Jr.; Eckstrom, Clinton V.; and Sandford, Maynard C.: Investigation and Suppression of High Dynamic Response Encountered on an Elastic Supercritical Wing. *Transonic Unsteady Aerodynamics and Aeroelasticity 1987*. NASA CP-3022, Part 2, 1989, pp. 427-448.
13. Sandford, Maynard C.; Seidel, David A.; Eckstrom, Clinton V.; and Spain, Charles V.: *Geometrical and Structural Properties of an Aeroelastic Research Wing*. NASA TM-4110, 1989.
14. Chapin, William G.: *Dynamic-Pressure Measurements Using an Electronically Scanned Pressure Module*. NASA TM-84650, 1983.
15. Eckstrom, C. V.: *Loads Calibrations of Strain Gage Bridges on the DAST Project Aeroelastic Research Wing (ARW-2)*. NASA TM-87677, 1986.
16. Reed, Wilmer H., III: *Aeroelasticity Matters: Some Reflections on Two Decades of Testing in the NASA Langley Transonic Dynamics Tunnel*. NASA TM-83210, 1981.
17. Roos, Frederick W.: Shock Oscillation and Pressure Fluctuation Measurements on Supercritical and Conventional Airfoils. *Advanced Technology Airfoil Research*, Volume 2, NASA CP-2046, 1978, pp. 201-219.

Table 1. Design Streamwise Airfoil Coordinates for Cruise Mach Number of 0.80

$x/c$	$z/c$		$x/c$	$z/c$	
	Upper surface	Lower surface		Upper surface	Lower surface
Wing and fuselage junction at $\eta = 0.106$			0.47000	0.04688	-0.08386
0.00000	-0.00166	-0.00166	.48000	.04585	-.08316
.00200	.00960	-.01321	.49000	.04480	-.08246
.00500	.01579	-.01923	.50000	.04377	-.08154
.01000	.02257	-.02612	.51000	.04263	-.08064
.02000	.03129	-.03453	.52000	.04149	-.07964
.03000	.03642	-.04011	.53000	.04035	-.07853
.04000	.04046	-.04457	.54000	.03911	-.07743
.05000	.04358	-.04843	.55000	.03787	-.07613
.06000	.04619	-.05178	.56000	.03663	-.07482
.07000	.04839	-.05483	.57000	.03529	-.07342
.08000	.05029	-.05768	.58000	.03395	-.07202
.09000	.05200	-.06033	.59000	.03261	-.07052
.10000	.05339	-.06278	.60000	.03127	-.06902
.11000	.05457	-.06502	.61000	.02983	-.06753
.12000	.05556	-.06716	.62000	.02839	-.06593
.13000	.05645	-.06910	.63000	.02695	-.06434
.14000	.05723	-.07094	.64000	.02551	-.06275
.15000	.05791	-.07267	.65000	.02398	-.06116
.16000	.05849	-.07420	.66000	.02264	-.05957
.17000	.05897	-.07563	.67000	.02090	-.05799
.18000	.05945	-.07693	.68000	.01926	-.05649
.19000	.05972	-.07818	.69000	.01762	-.05503
.20000	.05990	-.07930	.70000	.01599	-.05366
.21000	.05997	-.08032	.71000	.01436	-.05228
.22000	.06004	-.08124	.72000	.01262	-.05091
.23000	.06001	-.08205	.73000	.01089	-.04965
.24000	.05998	-.08276	.74000	.00915	-.04848
.25000	.05985	-.08337	.75000	.00732	-.04732
.26000	.05971	-.08398	.76000	.00549	-.04616
.27000	.05948	-.08449	.77000	.00366	-.04509
.28000	.05925	-.08489	.78000	.00183	-.04414
.29000	.05892	-.08530	.79000	-.00009	-.04327
.30000	.05859	-.08561	.80000	-.00202	-.04241
.31000	.05826	-.08591	.81000	-.00395	-.04165
.32000	.05782	-.08622	.82000	-.00597	-.04098
.33000	.05739	-.08642	.83000	-.00799	-.04042
.34000	.05686	-.08663	.84000	-.01001	-.03995
.35000	.05632	-.08674	.85000	-.01203	-.03958
.36000	.05568	-.08684	.86000	-.01404	-.03931
.37000	.05505	-.08685	.87000	-.01584	-.03913
.38000	.05442	-.08685	.88000	-.01806	-.03904
.39000	.05368	-.08676	.89000	-.02006	-.03914
.40000	.05294	-.08666	.90000	-.02206	-.03917
.41000	.05221	-.08647	.91000	-.02406	-.03947
.42000	.05137	-.08616	.92000	-.02605	-.03987
.43000	.05053	-.08586	.93000	-.02804	-.04036
.44000	.04970	-.08546	.94000	-.03002	-.04104
.45000	.04876	-.08496	.95000	-.03200	-.04182
.46000	.04782	-.08446	.96000	-.03398	-.04269



Table 1. Continued

$x/c$	$z/c$		$x/c$	$z/c$	
	Upper surface	Lower surface		Upper surface	Lower surface
Wing and fuselage junction at $\eta = 0.106$			0.43000	0.05939	-0.05952
0.97000	-0.03596	-0.04375	.44000	.05937	-.05913
.98000	-.03792	-.04501	.45000	.05935	-.05865
.99000	-.03987	-.04647	.46000	.05924	-.05816
1.00000	-.04182	-.04811	.47000	.05913	-.05758
Planform break at $\eta = 0.426$			.48000	.05901	-.05690
0.00000	-0.00436	-0.00436	.49000	.05880	-.05621
.00200	.00499	-.01319	.50000	.05859	-.05543
.00500	.00990	-.01822	.51000	.05837	-.05454
.01000	.01483	-.02312	.52000	.05816	-.05366
.02000	.02111	-.02925	.53000	.05784	-.05267
.03000	.02559	-.03359	.54000	.05753	-.05159
.04000	.02896	-.03682	.55000	.05721	-.05050
.05000	.03165	-.03935	.56000	.05680	-.04922
.06000	.03403	-.04156	.57000	.05639	-.04793
.07000	.03611	-.04348	.58000	.05597	-.04655
.08000	.03800	-.04520	.59000	.05546	-.04506
.09000	.03968	-.04672	.60000	.05494	-.04357
.10000	.04126	-.04813	.61000	.05433	-.04198
.11000	.04265	-.04935	.62000	.05371	-.04040
.12000	.04393	-.05056	.63000	.05310	-.03871
.13000	.04522	-.05168	.64000	.05238	-.03702
.14000	.04640	-.05269	.65000	.05167	-.03523
.15000	.04749	-.05361	.66000	.05085	-.03344
.16000	.04847	-.05443	.67000	.05004	-.03155
.17000	.04946	-.05524	.68000	.04913	-.02966
.18000	.05034	-.05595	.69000	.04821	-.02777
.19000	.05113	-.05667	.70000	.04730	-.02588
.20000	.05191	-.05728	.71000	.04629	-.02399
.21000	.05260	-.05790	.72000	.04527	-.02210
.22000	.05329	-.05841	.73000	.04416	-.02021
.23000	.05397	-.05883	.74000	.04304	-.01832
.24000	.05456	-.05924	.75000	.04183	-.01643
.25000	.05514	-.05966	.76000	.04062	-.01454
.26000	.05563	-.05997	.77000	.03940	-.01265
.27000	.05612	-.06028	.78000	.03809	-.01086
.28000	.05660	-.06050	.79000	.03678	-.00917
.29000	.05698	-.06072	.80000	.03537	-.00758
.30000	.05737	-.06093	.81000	.03395	-.00599
.31000	.05765	-.06105	.82000	.03244	-.00450
.32000	.05794	-.06106	.83000	.03093	-.00311
.33000	.05823	-.06108	.84000	.02942	-.00183
.34000	.05851	-.06109	.85000	.02781	-.00064
.36000	.05888	-.06102	.86000	.02620	.00035
.37000	.05907	-.06093	.87000	.02449	.00114
.38000	.05915	-.06085	.88000	.02277	.00172
.39000	.05924	-.06066	.89000	.02096	.00221
.40000	.05933	-.06047	.90000	.01915	.00249
.41000	.05941	-.06019	.91000	.01724	.00258
.42000	.05940	-.05991	.92000	.01533	.00236

Table 1. Continued

$x/c$	$z/c$		$x/c$	$z/c$	
	Upper surface	Lower surface		Upper surface	Lower surface
Planform break at $\eta = 0.426$			0.38000	0.04988	-0.05608
0.93000	0.01332	0.00195	.39000	.05014	-.05572
.94000	.01131	.00133	.40000	.05041	-.05535
.95000	.00921	.00042	.41000	.05068	-.05495
.96000	.00710	-.00079	.42000	.05091	-.05449
.97000	.00489	-.00220	.43000	.05108	-.05399
.98000	.00258	-.00392	.44000	.05125	-.05349
.99000	.00017	-.00593	.45000	.05142	-.05290
1.00000	-.00234	-.00813	.46000	.05155	-.05230
Wingtip at $\eta = 1.000$			.47000	.05162	-.05162
0.00000	-0.01350	-0.01350	.48000	.05168	-.05088
.00200	-.00506	-.02081	.49000	.05173	-.05009
.00500	-.00074	-.02531	.50000	.05176	-.04926
.01000	.00356	-.02946	.51000	.05179	-.04834
.02000	.00925	-.03467	.52000	.05176	-.04741
.03000	.01327	-.03823	.53000	.05170	-.04639
.04000	.01640	-.04088	.54000	.05164	-.04533
.05000	.01899	-.04295	.55000	.05156	-.04420
.06000	.02127	-.04472	.56000	.05141	-.04295
.07000	.02332	-.04625	.57000	.05125	-.04163
.08000	.02518	-.04758	.58000	.05108	-.04020
.09000	.02690	-.04878	.59000	.05088	-.03874
.10000	.02845	-.04981	.60000	.05062	-.03721
.11000	.02989	-.05077	.61000	.05033	-.03564
.12000	.03128	-.05167	.62000	.05004	-.03401
.13000	.03261	-.05247	.63000	.04974	-.03235
.14000	.03384	-.05317	.64000	.04935	-.03068
.15000	.03503	-.05383	.65000	.04895	-.02892
.16000	.03612	-.05440	.66000	.04846	-.02715
.17000	.03715	-.05490	.67000	.04796	-.02529
.18000	.03814	-.05536	.68000	.04744	-.02342
.19000	.03904	-.05576	.69000	.04685	-.02156
.20000	.03993	-.05612	.70000	.04625	-.01962
.21000	.04073	-.05648	.71000	.04563	-.01768
.22000	.04162	-.05675	.72000	.04494	-.01574
.23000	.04232	-.05698	.73000	.04421	-.01380
.24000	.04302	-.05715	.74000	.04342	-.01186
.25000	.04372	-.05731	.75000	.04259	-.00992
.26000	.04438	-.05744	.76000	.04170	-.00799
.27000	.04498	-.05751	.77000	.04080	-.00605
.28000	.04558	-.05754	.78000	.03982	-.00421
.29000	.04614	-.05757	.79000	.03883	-.00240
.30000	.04664	-.05755	.80000	.03780	-.00062
.31000	.04711	-.05748	.81000	.03671	.00101
.32000	.04758	-.05738	.82000	.03559	.00255
.33000	.04804	-.05722	.83000	.03440	.00398
.34000	.04844	-.05705	.84000	.03321	.00532
.35000	.04881	-.05688	.85000	.03193	.00655
.36000	.04918	-.05662	.86000	.03063	.00765
.37000	.04955	-.05635	.87000	.02925	.00855

Table 1. Concluded

$x/c$	$z/c$		$x/c$	$z/c$	
	Upper surface	Lower surface		Upper surface	Lower surface
Wingtip at $\eta = 1.000$			0.94000	0.01856	0.00972
0.88000	0.02786	0.00931	.95000	.01685	.00899
.89000	.02644	.00991	.96000	.01506	.00803
.90000	.02496	.01030	.97000	.01318	.00687
.91000	.02344	.01050	.98000	.01120	.00541
.92000	.02186	.01046	.99000	.00905	.00366
.93000	.02024	.01023	1.00000	.00680	.00164

Table 2. Location of Accelerometers and Strain Gage Bridges

Instrument	X, in.	Y, in.
Accelerometer 1	19.17	22.78
Accelerometer 2	30.06	22.78
Accelerometer 3	38.85	61.52
Accelerometer 4	47.35	61.52
Accelerometer 5	49.25	82.00
Accelerometer 6	57.43	84.10
Accelerometer 7	54.19	91.72
Accelerometer 8	60.96	92.00
Accelerometer 9	61.95	107.00
Accelerometer 10	67.65	107.00
Strain gage bridge 1	19.76	23.36
Strain gage bridge 2	19.76	23.36
Strain gage bridge 3	28.31	19.54
Strain gage bridge 4	28.31	19.54

Table 3. Test Conditions

Tab point	Mach number	$q$ , psf	$Re$	$\alpha$ , deg
Low dynamic pressure test conditions				
43	0.85	69.4	$1.33 \times 10^{-6}$	0.0
47	.90	75.7	1.38	0
51	.92	78.5	1.40	0
52	.94	81.1	1.41	0
53	.96	83.5	1.43	0
Medium dynamic pressure test conditions				
123	0.80	123.6	$2.43 \times 10^{-6}$	-2.0
124	.85	135.2	2.52	-2.0
125	.88	142.3	2.56	-2.0
126	.90	147.0	2.59	-2.0
128	.92	151.4	2.62	-2.0
130	.94	156.1	2.64	-2.0
132	.96	160.3	2.66	-2.0
240	.80	123.8	2.47	-1.0
245	.85	136.3	2.55	-1.0
248	.88	144.5	2.60	-1.0
251	.90	148.5	2.61	-1.0
254	.92	153.3	2.64	-1.0
257	.94	158.6	2.67	-1.0
260	.96	163.4	2.70	-1.0
91	.80	123.6	2.41	0
92	.85	135.3	2.49	0
94	.88	143.0	2.53	0
96	.90	148.0	2.55	0
98	.92	152.5	2.58	0
100	.94	157.0	2.60	0
101	.96	161.7	2.63	0
239	.80	122.6	2.46	1.0
243	.85	134.6	2.54	1.0
247	.88	142.2	2.58	1.0
250	.90	147.4	2.61	1.0
253	.92	153.1	2.64	1.0
256	.94	158.2	2.67	1.0
259	.96	162.9	2.70	1.0
105	.80	125.9	2.41	2.0
106	.85	137.9	2.50	2.0
107	.88	145.7	2.54	2.0
109	.90	150.7	2.57	2.0
111	.92	154.8	2.60	2.0
113	.94	159.7	2.62	2.0
114	.96	163.3	2.64	2.0

Table 3. Concluded

Tab point	Mach number	$q$ , psf	$Re$	$\alpha$ , deg
High dynamic pressure test conditions				
303	0.85	290.0	$5.27 \times 10^{-6}$	-1.0
304	.88	303.7	5.35	-1.0
310	.90	318.4	5.39	-1.0
311	.92	325.6	5.42	-1.0
195	.80	260.2	4.96	0
196	.85	283.4	5.11	0
197	.88	297.9	5.19	0
199	.90	308.6	5.25	0
202	.92	317.8	5.28	0
204	.94	328.3	5.33	0
205	.96	336.7	5.37	0
302	.85	287.7	5.23	1.0
306	.88	301.6	5.31	1.0
307	.90	316.3	5.40	1.0

Table 4. Accelerometer Statistical Data for Low Dynamic Pressure Test Conditions

Tab point	$M$	$q$ , psf	$\alpha$ , deg	Accelerometer	Mean, $g$ unit	Maximum, $g$ unit	Minimum, $g$ unit	Standard deviation, $g$ unit
43	0.85	69.4	0	9	-0.045	4.839	-4.483	1.537
				10	.010	4.327	-5.103	1.480
47	.90	75.7	0	9	-.038	5.708	-6.932	2.194
				10	.021	6.787	-6.825	2.256
51	.92	78.4	0	9	-.058	8.236	-7.169	2.322
				10	-.006	8.181	-7.481	2.445
52	.94	81.1	0	9	-.026	6.735	-7.248	2.526
				10	.026	7.033	-7.481	2.622
53	.96	83.4	0	9	-.032	3.496	-3.614	1.214
				10	.013	3.425	-2.889	.998

Table 5. Accelerometer Statistical Data for Medium Dynamic Pressure Test Conditions

Tab point	$M$	$q$ , psf	$\alpha$ , deg	Accelerometer	Mean, $g$ unit	Maximum, $g$ unit	Minimum, $g$ unit	Standard deviation, $g$ unit
123	0.80	123.6	-2.0	9	-0.043	4.523	-5.036	1.534
				10	.019	4.409	-4.939	1.479
124	.85	135.2	-2.0	9	-.045	4.918	-5.668	1.703
				10	.019	4.491	-4.939	1.613
125	.88	142.3	-2.0	9	-.035	6.893	-8.117	2.092
				10	.019	6.623	-8.547	2.137
126	.90	147.0	-2.0	9	-.046	11.238	-11.988	3.746
				10	.045	11.297	-11.581	4.058
128	.92	151.4	-2.0	9	-.003	11.791	-13.094	4.066
				10	.094	11.543	-12.647	4.110
130	.94	156.1	-2.0	9	.007	12.031	-10.010	3.944
				10	.064	11.876	-13.052	3.988
132	.96	160.3	-2.0	9	-.030	6.577	-8.828	2.383
				10	.049	6.623	-6.333	2.242
240	.80	123.8	-1.0	9	-.014	4.839	-5.826	1.748
				10	-.031	5.475	-4.775	1.679
245	.85	136.3	-1.0	9	-.026	5.392	-5.115	1.922
				10	-.038	6.459	-6.087	1.921
248	.88	144.5	-1.0	9	-.034	5.629	-6.774	1.966
				10	-.059	6.459	-6.989	2.143
251	.90	148.5	-1.0	9	-.008	10.211	-10.092	3.685
				10	-.008	11.461	-11.417	3.954
254	.92	153.3	-1.0	9	-.064	14.556	-16.491	5.608
				10	-.054	14.659	-16.665	6.015
257	.94	158.6	-1.0	9	-.009	8.239	-8.275	2.646
				10	-.044	6.951	-6.989	2.380
260	.96	163.4	-1.0	9	-.055	5.869	-5.668	1.968
				10	-.056	8.017	-6.169	2.141
91	.80	123.6	0	9	.020	5.076	-4.878	1.684
				10	.048	4.819	-4.857	1.651
92	.85	135.3	0	9	-.003	4.523	-5.352	1.697
				10	.044	5.721	-5.267	1.822
94	.88	143.0	0	9	-.025	6.340	-7.248	2.267
				10	.064	6.623	-7.235	2.462
96	.90	148.0	0	9	.033	8.868	-8.117	2.788
				10	.089	8.837	-8.137	3.026
98	.92	152.5	0	9	.020	10.132	-10.961	3.721
				10	.038	13.839	-12.319	4.137
100	.94	157.0	0	9	-.008	10.843	-11.277	3.636
				10	.042	12.527	-10.679	3.907
101	.96	161.7	0	9	.008	7.209	-7.011	2.347
				10	.089	6.869	-7.727	2.463
239	.80	122.6	1.0	9	.007	5.155	-5.826	1.735
				10	.049	5.475	-5.267	1.752
243	.85	134.6	1.0	9	-.036	5.945	-5.905	1.918
				10	-.047	5.639	-6.907	1.965
247	.88	142.2	1.0	9	-.019	7.130	-5.905	2.076
				10	-.035	6.295	-7.809	2.185
250	.90	147.4	1.0	9	-.016	9.105	-8.986	3.413
				10	.119	11.051	-9.859	3.762



Table 5. Concluded

Tab point	$M$	$q$ , psf	$\alpha$ , deg	Accelerometer	Mean, $g$ unit	Maximum, $g$ unit	Minimum, $g$ unit	Standard deviation, $g$ unit
253	0.92	153.1	1.0	9	-0.007	12.821	-14.358	5.326
				10	-.012	13.757	-16.501	5.815
256	.94	158.2	1.0	9	-.034	9.661	-9.302	3.244
				10	-.060	11.707	-10.187	3.108
259	.96	162.9	1.0	9	-.058	6.814	-5.747	1.838
				10	-.035	5.311	-4.939	1.787
105	.80	125.9	2.0	9	.018	4.760	-6.221	1.760
				10	.063	6.541	-5.595	1.634
106	.85	137.9	2.0	9	.047	6.656	-5.589	1.810
				10	.071	7.115	-6.497	1.878
107	.88	145.7	2.0	9	.019	8.394	-10.171	2.330
				10	.068	10.067	-9.613	2.529
109	.90	150.7	2.0	9	.019	10.448	-9.144	3.520
				10	.075	11.461	-11.417	3.858
111	.92	154.8	2.0	9	.022	9.263	-9.539	3.054
				10	.089	10.477	-9.449	3.338
113	.94	159.7	2.0	9	.013	9.342	-9.460	2.990
				10	.086	9.493	-10.433	3.222
114	.96	163.3	2.0	9	.013	5.234	-4.641	1.544
				10	.068	5.311	-5.185	1.636

Table 6. Accelerometer Statistical Data for High Dynamic Pressure Test Conditions

Tab point	$M$	$q$ , psf	$\alpha$ , deg	Accelerometer	Mean, $g$ unit	Maximum, $g$ unit	Minimum, $g$ unit	Standard deviation, $g$ unit
303	0.85	290.0	-1.0	9	-0.154	8.710	-10.487	2.837
				10	-.098	11.707	-12.073	3.236
304	.88	303.7	-1.0	9	-.126	11.317	-11.751	3.920
				10	-.072	13.019	-12.237	4.419
310	.90	318.4	-1.0	9	-.092	21.824	-19.177	6.099
				10	-.046	21.793	-16.747	6.727
311	.92	325.6	-1.0	9	-.089	32.015	-32.133	11.343
				10	-.065	33.765	-38.559	12.476
195	.80	260.2	0	9	-.067	7.683	-7.648	2.659
				10	.038	8.427	-8.875	2.790
196	.85	283.4	0	9	-.059	8.631	-8.512	2.790
				10	.040	9.083	-9.531	2.912
197	.88	297.9	0	9	-.064	12.344	-11.356	3.750
				10	.035	12.199	-13.139	4.219
199	.90	308.6	0	9	-.053	17.716	-16.017	5.331
				10	.027	16.053	-16.419	5.848
202	.92	317.8	0	9	-.082	15.662	-16.175	5.333
				10	.005	17.693	-17.567	5.852
204	.94	328.3	0	9	-.085	10.448	-10.250	2.921
				10	.005	10.559	-12.237	3.248
205	.96	336.7	0	9	-.080	7.051	-6.458	2.200
				10	.019	7.607	-7.399	2.359
302	.85	287.7	1.0	9	-.125	9.579	-11.672	3.330
				10	.050	12.035	-12.073	3.637
306	.88	301.6	1.0	9	-.119	15.978	-13.331	4.631
				10	-.046	16.463	13.713	5.236
307	.90	316.3	1.0	9	-.104	19.217	-20.678	6.961
				10	.043	18.267	-20.929	7.598

Table 7. Strain Gage Bridge 4 Statistical Data for Low Dynamic Pressure Test Conditions

Tab point	$M$	$q$ , psf	$\alpha$ , deg	Mean, mV	Maximum, mV	Minimum, mV	Standard deviation, mV
43	0.85	69.4	0	5.528	5.830	5.195	0.117
47	.90	75.7	0	4.771	5.407	4.180	.208
51	.92	78.4	0	3.580	4.265	2.953	.247
52	.94	81.1	0	2.201	2.827	1.515	.255
53	.96	83.4	0	1.200	1.388	1.050	.054

Table 8. Strain Gage Bridge 4 Statistical Data for Medium Dynamic Pressure Test Conditions

Tab point	$M$	$q$ , psf	$\alpha$ , deg	Mean, mV	Maximum, mV	Minimum, mV	Standard deviation, mV
123	0.80	123.6	-2.0	3.041	3.207	2.869	0.063
124	.85	135.2	-2.0	3.035	3.292	2.742	.099
125	.88	142.3	-2.0	2.667	3.038	2.234	.135
126	.90	147.0	-2.0	2.020	2.700	1.304	.281
128	.92	151.4	-2.0	.281	1.304	-.600	.357
130	.94	156.1	-2.0	-.577	.119	-1.403	.292
132	.96	160.3	-2.0	-2.260	-1.869	-2.630	.156
240	.80	123.8	-1.0	5.342	5.534	5.153	.076
245	.85	136.3	-1.0	5.927	6.253	5.618	.109
248	.88	144.5	-1.0	5.622	6.126	5.153	.162
251	.90	148.5	-1.0	7.041	8.029	6.084	.356
254	.92	153.3	-1.0	3.384	4.688	2.065	.529
257	.94	158.6	-1.0	1.375	1.854	.838	.179
260	.96	163.4	-1.0	-.089	.204	-.473	.117
91	.80	123.6	0	7.576	7.860	7.310	.086
92	.85	135.3	0	8.501	8.875	8.241	.106
94	.88	143.0	0	8.980	9.425	8.537	.170
96	.90	148.0	0	8.064	8.706	7.480	.247
98	.92	152.5	0	6.267	7.141	5.322	.333
100	.94	157.0	0	4.225	5.068	3.419	.335
101	.96	161.7	0	2.386	2.953	1.896	.102
239	.80	122.6	1.0	9.635	9.891	9.298	.091
243	.85	134.6	1.0	11.774	12.048	11.498	.112
247	.88	142.2	1.0	12.118	12.513	11.752	.157
250	.90	147.4	1.0	11.145	12.048	10.314	.321
253	.92	153.1	1.0	8.743	10.018	7.395	.483
256	.94	158.2	1.0	5.736	6.337	5.153	.224
259	.96	162.9	1.0	4.399	4.645	4.138	.081
105	.80	125.9	2.0	12.173	12.471	11.921	.098
106	.85	137.9	2.0	15.098	15.432	14.797	.110
107	.88	145.7	2.0	14.823	15.432	14.205	.180
109	.90	150.7	2.0	13.870	14.882	12.809	.363
111	.92	154.8	2.0	11.943	12.682	11.075	.283
113	.94	159.7	2.0	9.218	9.891	8.368	.252
114	.96	163.3	2.0	7.439	7.776	7.141	.109

Table 9. Strain Gage Bridge 4 Statistical Data for High Dynamic Pressure Test Conditions

Tab point	$M$	$q$ , psf	$\alpha$ , deg	Mean, mV	Maximum, mV	Minimum, mV	Standard deviation, mV
303	0.85	290.0	-1.0	7.225	7.564	6.718	0.141
304	.88	303.7	-1.0	6.394	7.183	5.618	.263
310	.90	318.4	-1.0	4.237	5.491	2.784	.497
311	.92	325.6	-1.0	1.950	4.645	-.938	1.143
195	.80	260.2	0	12.000	12.344	11.583	.117
196	.85	283.4	0	12.610	12.979	12.175	.127
197	.88	297.9	0	11.938	12.767	11.033	.284
199	.90	308.6	0	9.409	10.694	8.241	.451
202	.92	317.8	0	6.381	7.649	5.322	.482
204	.94	328.3	0	3.661	4.265	3.080	.223
205	.96	336.7	0	2.606	2.911	2.234	.103
302	.85	287.7	1.0	17.444	18.012	16.828	.176
306	.88	301.6	1.0	17.143	18.097	15.813	.351
307	.90	316.3	1.0	11.866	13.402	10.525	.573

Table 10. Pressure Coefficient Statistical Data for Low Dynamic Pressure Test Conditions

(a) Tab point 43,  $M = 0.85$ ,  $q = 69.4$  psf,  $\alpha = 0^\circ$

ETA=.707					ETA=.707				
X/C	MEAN	MAX	MIN	SIGMA	X/C	MEAN	MAX	MIN	SIGMA
.025	-.578	-.664	-.512	.020					
.087	-.652	-.725	-.601	.022					
.148	-.728	-.818	-.646	.021					
.209	-.692	-.744	-.575	.013	.209	-.302	-.412	-.234	.022
.294	-.664	-.754	-.605	.019	.294	-.364	-.476	-.282	.032
.350	-.731	-.820	-.670	.018	.350	-.348	-.462	-.259	.029
.407	-.756	-.850	-.699	.020	.407	-.415	-.601	-.304	.036
.463	-.798	-.934	-.731	.015	.463	-.418	-.536	-.314	.030
.519	-.800	-.889	-.740	.019	.519	-.269	-.362	-.165	.031
.579	-.858	-.974	-.798	.021	.579	-.175	-.285	-.050	.024
.659	-.865	-.962	-.762	.022	.659	.083	.012	.140	.022
.739	-.757	-.915	-.261	.084	.739	.264	.143	.322	.016
.819	-.161	-.361	-.057	.032	.819	.374	.265	.441	.019
.899	-.038	-.131	.020	.024	.899	.463	.367	.515	.012
.990	.109	-.001	.172	.022	.974	.351	.227	.428	.020

ETA=.871					ETA=.871				
X/C	MEAN	MAX	MIN	SIGMA	X/C	MEAN	MAX	MIN	SIGMA
.025	-.518	-.617	-.466	.013	.025	-.145	-.261	-.104	.021
.084	-.765	-.860	-.712	.014	.084	-.279	-.411	-.229	.018
.143	-.751	-.864	-.718	.017	.143	-.349	-.423	-.292	.023
.202	-.745	-.796	-.692	.027	.202	-.321	-.398	-.269	.023
.301	-.747	-.852	-.693	.016	.301	-.331	-.487	-.247	.030
.354	-.766	-.822	-.693	.017	.354	-.327	-.413	-.237	.028
.407	-.726	-.839	-.688	.023	.407	-.335	-.432	-.252	.029
.460	-.779	-.879	-.708	.019	.460	-.335	-.445	-.246	.027
.513	-.851	-.945	-.766	.022	.513	-.291	-.395	-.202	.024
.566	-.888	-1.002	-.715	.030	.566	-.236	-.354	-.104	.032
.680	-.540	-.820	-.164	.131	.680	.053	-.019	.103	.017
.742	-.229	-.504	-.100	.061	.742	.146	.047	.206	.016
.830	-.074	-.202	.005	.021	.830	.372	.281	.426	.019
.910	-.028	-.141	.014	.033	.910	.416	.333	.462	.020
.990	.148	.047	.201	.012	.975	.258	.159	.305	.013

ETA=.972					ETA=.972				
X/C	MEAN	MAX	MIN	SIGMA	X/C	MEAN	MAX	MIN	SIGMA
.025	-.766	-.843	-.695	.016	.025	-.278	-.371	-.186	.026
.092	-.787	-.871	-.744	.013	.092	-.251	-.386	-.186	.043
.126	-.834	-.900	-.776	.014	.126	-.353	-.475	-.250	.025
.227	-.842	-.938	-.716	.024	.227	-.425	-.543	-.340	.031
.294	-.780	-.855	-.702	.018	.294	-.375	-.514	-.263	.028
.362	-.696	-.819	-.145	.086	.362	-.269	-.431	-.124	.042
.430	-.278	-.744	-.120	.096	.430	-.229	-.396	-.137	.031
.497	-.185	-.297	-.071	.029	.497	-.201	-.330	-.125	.027
.565	-.208	-.360	-.136	.028	.565	-.117	-.221	-.065	.020
.632	-.225	-.345	-.138	.028	.632	.032	-.056	.124	.023
.700	-.217	-.303	-.148	.024	.700	.141	.080	.227	.022
.767	-.170	-.251	-.080	.022	.767	.282	.213	.339	.018
.835	-.118	-.241	-.061	.020	.835	.361	.267	.421	.022
.902	-.034	-.127	.023	.018	.902	.360	.267	.421	.023
.990	.099	-.005	.168	.026	.973	.213	.140	.264	.017

Table 10. Continued

(b) Tab point 47,  $M = 0.90$ ,  $q = 75.7$  psf,  $\alpha = 0^\circ$

ETA=.707					ETA=.707				
X/C	MEAN	MAX	CP UPPER MIN	SIGMA	X/C	MEAN	MAX	CP LOWER MIN	SIGMA
.025	-.429	-.515	-.376	.017					
.087	-.533	-.596	-.505	.012					
.148	-.623	-.705	-.570	.017					
.209	-.583	-.660	-.527	.016	.209	-.436	-.518	-.378	.017
.294	-.606	-.691	-.577	.014	.294	-.557	-.658	-.503	.020
.350	-.656	-.729	-.591	.017	.350	-.586	-.679	-.516	.022
.407	-.689	-.779	-.617	.017	.407	-.742	-.845	-.619	.024
.463	-.742	-.856	-.716	.014	.463	-.709	-.899	-.333	.096
.519	-.759	-.837	-.701	.016	.519	-.311	-.581	-.151	.074
.579	-.798	-.892	-.755	.017	.579	-.163	-.304	-.046	.033
.659	-.822	-.905	-.744	.023	.659	.057	-.036	.129	.019
.739	-.691	-.861	-.354	.080	.739	.224	.131	.272	.018
.819	-.222	-.447	-.145	.034	.819	.345	.266	.404	.018
.899	-.124	-.236	-.051	.022	.899	.436	.359	.494	.015
.990	.005	-.114	.090	.023	.974	.292	.231	.346	.016

ETA=.871					ETA=.871				
X/C	MEAN	MAX	CP UPPER MIN	SIGMA	X/C	MEAN	MAX	CP LOWER MIN	SIGMA
.025	-.350	-.427	-.289	.018	.025	-.266	-.359	-.167	.016
.084	-.607	-.698	-.563	.010	.084	-.423	-.519	-.376	.016
.143	-.644	-.680	-.591	.020	.143	-.468	-.531	-.435	.017
.202	-.625	-.705	-.586	.017	.202	-.449	-.530	-.388	.016
.301	-.682	-.760	-.635	.014	.301	-.508	-.593	-.373	.022
.354	-.715	-.800	-.683	.012	.354	-.560	-.700	-.378	.048
.407	-.664	-.768	-.630	.021	.407	-.525	-.654	-.325	.061
.460	-.705	-.783	-.648	.015	.460	-.495	-.636	-.294	.051
.513	-.783	-.866	-.749	.018	.513	-.435	-.671	-.163	.080
.566	-.828	-.918	-.786	.015	.566	-.236	-.530	-.073	.078
.680	-.637	-.821	-.428	.067	.680	.026	-.040	.094	.021
.742	-.349	-.623	-.207	.052	.742	.131	.018	.213	.017
.830	-.147	-.257	-.043	.030	.830	.351	.280	.412	.019
.910	-.089	-.200	.013	.043	.910	.389	.305	.447	.018
.990	.058	-.051	.138	.028	.975	.213	.123	.257	.022

ETA=.972					ETA=.972				
X/C	MEAN	MAX	CP UPPER MIN	SIGMA	X/C	MEAN	MAX	CP LOWER MIN	SIGMA
.025	-.571	-.659	-.523	.019	.025	-.388	-.509	-.315	.025
.092	-.620	-.705	-.542	.022	.092	-.348	-.469	-.262	.021
.126	-.695	-.779	-.642	.014	.126	-.459	-.527	-.390	.023
.227	-.749	-.837	-.701	.012	.227	-.544	-.637	-.474	.020
.294	-.781	-.876	-.736	.013	.294	-.639	-.747	-.540	.024
.362	-.747	-.842	-.659	.026	.362	-.526	-.653	-.372	.040
.430	-.708	-.819	-.636	.019	.430	-.471	-.670	-.008	.139
.497	-.666	-.780	-.434	.048	.497	-.079	-.396	.026	.053
.565	-.332	-.694	-.034	.138	.565	-.058	-.179	.059	.036
.632	-.099	-.316	-.007	.033	.632	.057	-.051	.137	.026
.700	-.100	-.183	-.017	.033	.700	.167	.095	.230	.022
.767	-.072	-.163	.017	.027	.767	.303	.218	.333	.016
.835	-.048	-.127	.039	.022	.835	.362	.268	.409	.016
.902	.020	-.070	.090	.024	.902	.361	.268	.409	.021
.990	.118	.018	.176	.022	.973	.232	.151	.288	.013

Table 10. Continued

(c) Tab point 51,  $M = 0.92$ ,  $q = 78.5$  psf,  $\alpha = 0^\circ$

ETA=.707					ETA=.707				
X/C	MEAN	MAX	MIN	SIGMA	X/C	MEAN	MAX	MIN	SIGMA
.025	-.384	-.475	-.340	.021	.209	-.449	-.522	-.410	.015
.087	-.507	-.575	-.465	.012	.294	-.562	-.657	-.528	.019
.148	-.596	-.658	-.572	.021	.350	-.612	-.678	-.566	.016
.209	-.563	-.637	-.508	.015	.407	-.771	-.859	-.728	.015
.294	-.592	-.667	-.557	.016	.463	-.860	-.933	-.802	.014
.350	-.635	-.703	-.570	.017	.519	-.856	-.932	-.779	.020
.407	-.674	-.774	-.596	.016	.579	-.617	-.792	-.335	.065
.463	-.723	-.826	-.691	.019	.659	-.118	-.261	.011	.040
.519	-.750	-.830	-.699	.015	.739	.127	-.009	.217	.031
.579	-.783	-.883	-.728	.016	.819	.276	.145	.346	.026
.659	-.816	-.896	-.762	.018	.899	.382	.282	.433	.026
.739	-.712	-.853	-.409	.069	.974	.266	.179	.334	.021
.819	-.253	-.499	-.162	.058					
.899	-.143	-.228	-.071	.025					
.990	-.031	-.154	.065	.029					

ETA=.871					ETA=.871				
X/C	MEAN	MAX	MIN	SIGMA	X/C	MEAN	MAX	MIN	SIGMA
.025	-.312	-.390	-.256	.017	.025	-.296	-.369	-.254	.015
.084	-.561	-.630	-.499	.018	.084	-.443	-.547	-.409	.015
.143	-.591	-.656	-.527	.020	.143	-.537	-.605	-.489	.016
.202	-.594	-.681	-.543	.019	.202	-.511	-.603	-.398	.021
.301	-.657	-.734	-.613	.014	.301	-.528	-.620	-.478	.014
.354	-.698	-.795	-.682	.012	.354	-.603	-.676	-.543	.018
.407	-.661	-.764	-.631	.023	.407	-.639	-.722	-.586	.016
.460	-.704	-.799	-.626	.015	.460	-.727	-.812	-.614	.017
.513	-.766	-.836	-.723	.012	.513	-.656	-.776	-.563	.026
.566	-.807	-.886	-.759	.017	.566	-.571	-.754	-.357	.053
.680	-.554	-.770	-.346	.071	.680	-.133	-.298	.026	.063
.742	-.318	-.557	-.200	.041	.742	.061	-.170	.135	.041
.830	-.178	-.248	-.087	.022	.830	.305	.206	.355	.017
.910	-.148	-.239	-.010	.024	.910	.325	.249	.386	.022
.990	-.009	-.094	.065	.031	.975	.159	.076	.227	.022

ETA=.972					ETA=.972				
X/C	MEAN	MAX	MIN	SIGMA	X/C	MEAN	MAX	MIN	SIGMA
.025	-.510	-.593	-.461	.016	.025	-.428	-.537	-.351	.028
.092	-.567	-.636	-.523	.019	.092	-.366	-.475	-.320	.019
.126	-.659	-.730	-.620	.014	.126	-.483	-.553	-.420	.019
.227	-.716	-.786	-.677	.013	.227	-.579	-.659	-.525	.017
.294	-.755	-.823	-.711	.013	.294	-.681	-.766	-.632	.020
.362	-.763	-.834	-.724	.012	.362	-.650	-.766	-.540	.022
.430	-.745	-.856	-.680	.033	.430	-.609	-.715	-.532	.019
.497	-.690	-.798	-.642	.014	.497	-.510	-.653	-.043	.069
.565	-.618	-.757	-.296	.074	.565	-.171	-.334	.057	.072
.632	-.256	-.581	-.030	.084	.632	.025	-.163	.155	.057
.700	-.069	-.222	.030	.040	.700	.144	.005	.222	.039
.767	-.020	-.114	.059	.022	.767	.254	.122	.322	.029
.835	.005	-.099	.061	.026	.835	.299	.146	.372	.028
.902	.056	-.046	.153	.023	.902	.316	.213	.395	.025
.990	.113	-.004	.192	.025	.973	.223	.102	.299	.017

Table 10. Continued

(d) Tab point 52,  $M = 0.94$ ,  $q = 81.1$  psf,  $\alpha = 0^\circ$

ETA=.707					ETA=.707				
X/C	MEAN	MAX	CP UPPER MIN	SIGMA	X/C	MEAN	MAX	CP LOWER MIN	SIGMA
.025	-.363	-.460	-.308	.018					
.087	-.481	-.536	-.429	.015					
.148	-.573	-.637	-.553	.021					
.209	-.554	-.637	-.492	.011	.209	-.414	-.484	-.375	.015
.294	-.578	-.646	-.539	.017	.294	-.523	-.615	-.490	.018
.350	-.623	-.681	-.595	.015	.350	-.578	-.656	-.547	.014
.407	-.656	-.728	-.620	.014	.407	-.746	-.832	-.705	.013
.463	-.700	-.800	-.669	.018	.463	-.820	-.903	-.776	.013
.519	-.724	-.782	-.676	.013	.519	-.834	-.903	-.797	.015
.579	-.760	-.855	-.705	.014	.579	-.890	-.987	-.807	.023
.659	-.804	-.888	-.760	.015	.659	-.388	-.538	-.275	.039
.739	-.749	-.848	-.525	.026	.739	-.260	-.359	-.184	.024
.819	-.385	-.527	-.179	.043	.819	-.143	-.247	-.031	.032
.899	-.185	-.285	-.091	.030	.899	.051	-.043	.167	.031
.990	-.072	-.192	-.001	.025	.974	.132	.023	.237	.028

ETA=.871					ETA=.871				
X/C	MEAN	MAX	CP UPPER MIN	SIGMA	X/C	MEAN	MAX	CP LOWER MIN	SIGMA
.025	-.303	-.377	-.270	.017	.025	-.251	-.335	-.201	.015
.084	-.541	-.610	-.483	.017	.084	-.410	-.485	-.352	.014
.143	-.575	-.635	-.531	.020	.143	-.500	-.585	-.451	.011
.202	-.580	-.659	-.503	.017	.202	-.509	-.584	-.451	.016
.301	-.647	-.710	-.593	.014	.301	-.508	-.600	-.463	.011
.354	-.682	-.770	-.660	.011	.354	-.586	-.654	-.547	.017
.407	-.653	-.739	-.610	.016	.407	-.625	-.699	-.567	.015
.460	-.691	-.773	-.648	.011	.460	-.712	-.786	-.680	.015
.513	-.755	-.831	-.700	.017	.513	-.789	-.854	-.751	.011
.566	-.793	-.878	-.735	.020	.566	-.842	-.944	-.730	.031
.680	-.518	-.724	-.357	.059	.680	-.523	-.687	-.394	.037
.742	-.325	-.496	-.259	.036	.742	-.399	-.506	-.301	.028
.830	-.209	-.306	-.151	.020	.830	.162	-.089	.261	.048
.910	-.189	-.254	-.121	.019	.910	.230	.109	.308	.024
.990	-.055	-.157	.041	.018	.975	.108	.052	.157	.018

ETA=.972					ETA=.972				
X/C	MEAN	MAX	CP UPPER MIN	SIGMA	X/C	MEAN	MAX	CP LOWER MIN	SIGMA
.025	-.491	-.574	-.447	.015	.025	-.381	-.475	-.317	.023
.092	-.550	-.615	-.507	.018	.092	-.339	-.417	-.288	.016
.126	-.634	-.707	-.600	.015	.126	-.458	-.535	-.407	.016
.227	-.692	-.761	-.655	.013	.227	-.558	-.638	-.508	.013
.294	-.736	-.819	-.688	.012	.294	-.673	-.741	-.612	.018
.362	-.744	-.808	-.701	.009	.362	-.666	-.764	-.632	.014
.430	-.739	-.850	-.680	.034	.430	-.654	-.781	-.582	.031
.497	-.687	-.794	-.643	.021	.497	-.608	-.720	-.501	.024
.565	-.657	-.754	-.478	.043	.565	-.438	-.613	-.234	.056
.632	-.397	-.651	-.207	.070	.632	-.269	-.422	-.092	.043
.700	-.192	-.326	-.038	.044	.700	-.170	-.352	.005	.050
.767	-.095	-.215	.015	.043	.767	-.062	-.203	.075	.044
.835	-.041	-.163	.059	.034	.835	.017	-.144	.229	.055
.902	.020	-.109	.149	.033	.902	.100	-.035	.272	.044
.990	.078	-.088	.186	.040	.973	.150	.035	.269	.036



Table 10. Concluded

(e) Tab point 53,  $M = 0.96$ ,  $q = 83.5$  psf,  $\alpha = 0^\circ$

ETA=.707					ETA=.707				
X/C	MEAN	MAX	MIN	SIGMA	X/C	MEAN	MAX	MIN	SIGMA
.025	-.341	-.404	-.299	.012					
.087	-.459	-.540	-.396	.015					
.148	-.539	-.619	-.517	.009					
.209	-.538	-.598	-.478	.010	.209	-.380	-.448	-.321	.012
.294	-.553	-.627	-.523	.014	.294	-.497	-.577	-.456	.008
.350	-.596	-.661	-.557	.014	.350	-.541	-.616	-.510	.013
.407	-.633	-.706	-.602	.014	.407	-.698	-.787	-.643	.015
.463	-.674	-.777	-.650	.012	.463	-.774	-.836	-.733	.015
.519	-.694	-.759	-.656	.013	.519	-.797	-.876	-.753	.018
.579	-.731	-.809	-.684	.013	.579	-.892	-.958	-.841	.014
.659	-.792	-.862	-.737	.014	.659	-.918	-.969	-.863	.013
.739	-.763	-.844	-.697	.014	.739	-.619	-.751	-.518	.036
.819	-.636	-.743	-.342	.053	.819	-.344	-.407	-.281	.013
.899	-.325	-.445	-.256	.034	.899	-.210	-.286	-.164	.016
.990	-.199	-.310	-.104	.026	.974	-.067	-.165	.001	.019

ETA=.871					ETA=.871				
X/C	MEAN	MAX	MIN	SIGMA	X/C	MEAN	MAX	MIN	SIGMA
.025	-.295	-.366	-.262	.015	.025	-.206	-.282	-.152	.017
.084	-.522	-.592	-.469	.015	.084	-.363	-.428	-.320	.016
.143	-.550	-.617	-.515	.015	.143	-.451	-.525	-.416	.013
.202	-.556	-.640	-.510	.018	.202	-.461	-.524	-.417	.011
.301	-.627	-.689	-.595	.012	.301	-.463	-.538	-.427	.016
.354	-.662	-.726	-.640	.008	.354	-.548	-.614	-.510	.011
.407	-.633	-.718	-.593	.014	.407	-.587	-.657	-.551	.014
.460	-.671	-.751	-.629	.009	.460	-.677	-.743	-.639	.010
.513	-.738	-.806	-.700	.017	.513	-.739	-.809	-.709	.014
.566	-.809	-.872	-.753	.012	.566	-.825	-.896	-.771	.015
.680	-.782	-.870	-.661	.017	.680	-.923	-.992	-.890	.013
.742	-.632	-.775	-.419	.060	.742	-.918	-.998	-.866	.013
.830	-.301	-.405	-.233	.039	.830	-.460	-.546	-.426	.015
.910	-.288	-.375	-.225	.019	.910	-.171	-.259	-.109	.023
.990	-.161	-.238	-.110	.024	.975	-.057	-.112	-.010	.013

ETA=.972					ETA=.972				
X/C	MEAN	MAX	MIN	SIGMA	X/C	MEAN	MAX	MIN	SIGMA
.025	-.475	-.557	-.434	.011	.025	-.324	-.396	-.286	.017
.092	-.539	-.618	-.492	.015	.092	-.298	-.384	-.238	.017
.126	-.614	-.686	-.582	.014	.126	-.415	-.478	-.374	.015
.227	-.667	-.718	-.636	.013	.227	-.523	-.578	-.472	.013
.294	-.717	-.795	-.668	.013	.294	-.632	-.699	-.594	.015
.362	-.724	-.805	-.680	.009	.362	-.628	-.699	-.571	.014
.430	-.733	-.825	-.660	.023	.430	-.721	-.801	-.672	.014
.497	-.682	-.749	-.645	.022	.497	-.776	-.848	-.614	.021
.565	-.687	-.753	-.588	.020	.565	-.788	-.897	-.638	.040
.632	-.532	-.675	-.373	.049	.632	-.765	-.859	-.538	.041
.700	-.360	-.511	-.231	.045	.700	-.648	-.810	-.443	.064
.767	-.265	-.371	-.148	.040	.767	-.473	-.614	-.343	.043
.835	-.210	-.287	-.115	.026	.835	-.353	-.438	-.225	.029
.902	-.153	-.230	-.043	.031	.902	-.218	-.311	-.140	.028
.990	-.102	-.249	.017	.036	.973	-.076	-.234	.034	.039

Table 11. Pressure Coefficient Statistical Data for Medium Dynamic Pressure Test Conditions

(a) Tab point 123,  $M = 0.80$ ,  $q = 123.6$  psf,  $\alpha = -2^\circ$

ETA=.707					ETA=.707				
X/C	MEAN	MAX	CP UPPER MIN	SIGMA	X/C	MEAN	MAX	CP LOWER MIN	SIGMA
.025	-.154	-.214	-.099	.017					
.087	-.387	-.461	-.293	.017					
.148	-.410	-.483	-.318	.022					
.209	-.301	-.364	-.228	.018	.209	-.456	-.546	-.332	.034
.294	-.367	-.452	-.228	.036	.294	-.468	-.555	-.337	.034
.350	-.386	-.461	-.278	.031	.350	-.482	-.585	-.371	.032
.407	-.438	-.563	-.293	.037	.407	-.504	-.615	-.365	.032
.463	-.443	-.568	-.325	.037	.463	-.472	-.577	-.368	.028
.519	-.409	-.541	.085	.045	.519	-.332	-.410	-.243	.025
.579	-.430	-.570	-.303	.039	.579	-.206	-.279	-.134	.020
.659	-.341	-.442	-.118	.029	.659	.018	-.036	.064	.016
.739	-.356	-.452	-.255	.030	.739	.166	.112	.227	.013
.819	-.249	-.317	-.189	.019	.819	.256	.194	.293	.013
.899	-.108	-.187	-.060	.016	.899	.335	.280	.376	.015
.990	.144	.081	.178	.014	.974	.305	.243	.355	.014

ETA=.871					ETA=.871				
X/C	MEAN	MAX	CP UPPER MIN	SIGMA	X/C	MEAN	MAX	CP LOWER MIN	SIGMA
.025	-.099	-.151	-.052	.013	.025	-.726	-.822	-.646	.019
.084	-.305	-.361	-.264	.007	.084	-.596	-.656	-.554	.014
.143	-.301	-.350	-.255	.015	.143	-.560	-.619	-.516	.017
.202	-.318	-.377	-.275	.016	.202	-.540	-.603	-.038	.023
.301	-.317	-.389	-.236	.023	.301	-.441	-.532	-.337	.032
.354	-.334	-.424	-.222	.030	.354	-.410	-.502	-.291	.031
.407	-.368	-.488	-.149	.026	.407	-.396	-.516	-.300	.029
.460	-.398	-.494	-.274	.029	.460	-.393	-.490	.069	.028
.513	-.399	-.505	-.160	.037	.513	-.311	-.386	-.088	.026
.566	-.423	-.538	-.309	.034	.566	-.218	-.299	-.131	.021
.680	-.347	-.435	-.109	.024	.680	.026	-.027	.276	.016
.742	-.297	-.368	-.226	.021	.742	.122	.056	.175	.015
.830	-.166	-.233	-.102	.018	.830	.301	.226	.347	.011
.910	-.087	-.143	-.041	.014	.910	.345	.286	.402	.014
.990	.148	.084	.185	.013	.975	.265	.220	.302	.010

ETA=.972					ETA=.972				
X/C	MEAN	MAX	CP UPPER MIN	SIGMA	X/C	MEAN	MAX	CP LOWER MIN	SIGMA
.025	-.305	-.376	-.238	.021	.025	-.850	-.933	-.771	.026
.092	-.367	-.412	-.298	.020	.092	-.465	-.562	-.337	.036
.126	-.417	-.494	-.312	.026	.126	-.446	-.581	-.300	.039
.227	-.342	-.423	-.242	.026	.227	-.391	-.455	-.341	.017
.294	-.286	-.357	-.171	.023	.294	-.317	-.378	-.252	.019
.362	-.291	-.380	-.198	.023	.362	-.248	-.334	-.176	.024
.430	-.286	-.364	-.196	.024	.430	-.262	-.356	-.182	.022
.497	-.224	-.243	-.158	.016	.497	-.217	-.277	-.148	.019
.565	-.221	-.304	-.137	.024	.565	-.128	-.230	-.069	.019
.632	-.220	-.273	-.098	.020	.632	-.001	-.069	.061	.017
.700	-.195	-.258	-.112	.021	.700	.134	.084	.180	.015
.767	-.148	-.200	-.076	.019	.767	.248	.185	.298	.012
.835	-.071	-.139	-.008	.016	.835	.291	.245	.346	.014
.902	-.029	-.093	.020	.016	.902	.309	.257	.358	.015
.990	.110	.037	.161	.016	.973	.221	.160	.272	.015

Table 11. Continued

(b) Tab point 124,  $M = 0.85$ ,  $q = 135.2$  psf,  $\alpha = -2^\circ$ 

ETA=.707					ETA=.707				
X/C	MEAN	MAX	CP UPPER MIN	SIGMA	X/C	MEAN	MAX	CP LOWER MIN	SIGMA
.025	-.119	-.169	-.078	.013					
.087	-.391	-.446	-.357	.014					
.148	-.444	-.491	-.391	.014					
.209	-.318	-.369	-.270	.016	.209	-.669	-.773	-.329	.066
.294	-.409	-.489	-.336	.020	.294	-.431	-.756	-.234	.088
.350	-.436	-.498	-.357	.019	.350	-.518	-.756	-.274	.056
.407	-.504	-.579	-.333	.021	.407	-.601	-.790	-.372	.071
.463	-.551	-.610	-.349	.023	.463	-.517	-.755	-.337	.059
.519	-.562	-.647	-.278	.049	.519	-.344	-.476	-.235	.036
.579	-.554	-.765	-.213	.107	.579	-.202	-.291	-.098	.026
.659	-.354	-.674	-.172	.069	.659	.030	-.033	.085	.018
.739	-.371	-.646	-.181	.061	.739	.175	.115	.233	.016
.819	-.249	-.355	-.146	.032	.819	.266	.138	.319	.017
.899	-.091	-.158	-.015	.019	.899	.353	.293	.407	.015
.990	.154	.086	.201	.014	.974	.323	.260	.389	.016
ETA=.871					ETA=.871				
X/C	MEAN	MAX	CP UPPER MIN	SIGMA	X/C	MEAN	MAX	CP LOWER MIN	SIGMA
.025	-.064	-.112	-.022	.014	.025	-.761	-.818	-.711	.013
.084	-.310	-.368	-.279	.013	.084	-.756	-.839	-.679	.023
.143	-.314	-.358	-.258	.017	.143	-.708	-.780	-.646	.025
.202	-.344	-.411	-.304	.015	.202	-.612	-.750	-.498	.042
.301	-.347	-.461	-.227	.030	.301	-.533	-.746	-.322	.079
.354	-.368	-.467	-.203	.032	.354	-.443	-.729	-.240	.066
.407	-.412	-.484	-.252	.029	.407	-.453	-.669	-.261	.055
.460	-.504	-.602	-.275	.050	.460	-.436	-.653	-.269	.058
.513	-.503	-.737	-.212	.105	.513	-.329	-.489	-.192	.043
.566	-.471	-.773	-.197	.095	.566	-.214	-.299	-.107	.027
.680	-.360	-.540	-.216	.054	.680	.039	-.012	.089	.016
.742	-.296	-.427	-.194	.035	.742	.132	.078	.174	.014
.830	-.154	-.226	-.093	.022	.830	.294	.231	.342	.015
.910	-.063	-.131	-.011	.014	.910	.344	.288	.394	.016
.990	.154	.103	.196	.013	.975	.272	.226	.314	.013
ETA=.972					ETA=.972				
X/C	MEAN	MAX	CP UPPER MIN	SIGMA	X/C	MEAN	MAX	CP LOWER MIN	SIGMA
.025	-.278	-.344	-.204	.020	.025	-.839	-.894	-.799	.014
.092	-.370	-.441	-.298	.013	.092	-.714	-.847	-.308	.096
.126	-.496	-.566	-.375	.026	.126	-.557	-.774	-.364	.084
.227	-.458	-.615	-.297	.056	.227	-.479	-.637	-.364	.039
.294	-.330	-.535	-.156	.056	.294	-.328	-.488	-.217	.035
.362	-.315	-.476	-.155	.051	.362	-.257	-.384	-.108	.041
.430	-.311	-.486	-.179	.046	.430	-.277	-.378	-.166	.034
.497	-.231	-.364	-.170	.029	.497	-.226	-.306	-.122	.027
.565	-.232	-.367	-.087	.037	.565	-.127	-.196	-.050	.022
.632	-.225	-.329	-.143	.027	.632	.008	-.050	.082	.018
.700	-.195	-.302	-.103	.026	.700	.146	.089	.215	.015
.767	-.142	-.208	-.070	.023	.767	.255	.208	.298	.013
.835	-.063	-.127	.006	.017	.835	.297	.237	.356	.017
.902	-.015	-.085	.044	.018	.902	.319	.261	.366	.012
.990	.126	.046	.185	.018	.973	.226	.184	.286	.015

Table 11. Continued

(c) Tab point 125,  $M = 0.88$ ,  $q = 142.3$  psf,  $\alpha = -2^\circ$

ETA=.707					ETA=.707				
X/C	MEAN	MAX	MIN	SIGMA	X/C	MEAN	MAX	MIN	SIGMA
.025	-.110	-.161	-.074	.011					
.087	-.393	-.448	-.352	.010					
.148	-.423	-.467	-.371	.010					
.209	-.336	-.375	-.304	.010	.209	-.739	-.785	-.698	.011
.294	-.428	-.489	-.368	.016	.294	-.814	-.860	-.766	.013
.350	-.441	-.486	-.388	.012	.350	-.852	-.916	-.768	.016
.407	-.505	-.562	-.452	.015	.407	-.943	-1.004	-.353	.030
.463	-.536	-.605	-.481	.016	.463	-.519	-1.079	-.175	.210
.519	-.545	-.603	-.494	.017	.519	-.216	-.380	-.103	.036
.579	-.671	-.740	-.617	.014	.579	-.128	-.242	-.025	.031
.659	-.673	-.727	-.396	.027	.659	.046	-.019	.106	.018
.739	-.392	-.834	-.123	.142	.739	.189	.110	.234	.017
.819	-.181	-.350	-.077	.038	.819	.297	.254	.352	.014
.899	-.056	-.138	.022	.023	.899	.401	.339	.446	.013
.990	.155	.094	.191	.013	.974	.354	.296	.394	.017

ETA=.871					ETA=.871				
X/C	MEAN	MAX	MIN	SIGMA	X/C	MEAN	MAX	MIN	SIGMA
.025	-.041	-.095	.004	.009	.025	-.726	-.777	-.688	.011
.084	-.304	-.349	-.265	.008	.084	-.825	-.873	-.798	.010
.143	-.312	-.364	-.269	.011	.143	-.825	-.868	-.792	.011
.202	-.348	-.391	-.315	.010	.202	-.804	-.851	-.763	.012
.301	-.398	-.482	-.338	.024	.301	-.789	-.840	-.592	.019
.354	-.424	-.481	-.306	.021	.354	-.815	-.950	-.179	.139
.407	-.394	-.460	-.338	.020	.407	-.398	-.911	-.136	.179
.460	-.492	-.536	-.441	.012	.460	-.307	-.729	-.134	.072
.513	-.636	-.688	-.563	.013	.513	-.268	-.571	-.100	.062
.566	-.738	-.805	-.339	.033	.566	-.172	-.321	-.053	.035
.680	-.367	-.759	-.119	.130	.680	.066	.001	.120	.017
.742	-.240	-.516	-.098	.057	.742	.160	.088	.217	.016
.830	-.125	-.227	-.051	.026	.830	.345	.290	.396	.014
.910	-.040	-.099	.015	.019	.910	.378	.324	.425	.013
.990	.165	.111	.211	.014	.975	.295	.239	.334	.012

ETA=.972					ETA=.972				
X/C	MEAN	MAX	MIN	SIGMA	X/C	MEAN	MAX	MIN	SIGMA
.025	-.244	-.303	-.194	.017	.025	-.781	-.823	-.746	.012
.092	-.342	-.395	-.308	.010	.092	-.809	-.866	-.756	.019
.126	-.481	-.526	-.453	.011	.126	-.816	-.895	-.748	.020
.227	-.557	-.608	-.512	.012	.227	-.812	-.878	-.705	.023
.294	-.596	-.670	-.409	.038	.294	-.582	-.831	-.059	.161
.362	-.539	-.647	-.148	.077	.362	-.070	-.402	.047	.060
.430	-.362	-.669	-.097	.141	.430	-.179	-.384	.006	.056
.497	-.190	-.444	-.088	.042	.497	-.184	-.303	-.078	.035
.565	-.195	-.385	-.046	.048	.565	-.109	-.187	-.022	.026
.632	-.207	-.338	-.072	.035	.632	.021	-.047	.091	.019
.700	-.181	-.274	-.059	.032	.700	.154	.109	.216	.014
.767	-.130	-.198	-.043	.024	.767	.286	.234	.332	.013
.835	-.051	-.120	.006	.018	.835	.348	.288	.413	.014
.902	-.010	-.068	.054	.018	.902	.362	.311	.398	.021
.990	.121	.032	.200	.018	.973	.233	.175	.272	.015

Table 11. Continued

(d) Tab point 126,  $M = 0.90$ ,  $q = 147.0$  psf,  $\alpha = -2^\circ$

ETA=.707					ETA=.707				
X/C	MEAN	MAX	MIN	SIGMA	X/C	MEAN	MAX	MIN	SIGMA
.025	-.112	-.167	-.072	.013					
.087	-.384	-.446	-.352	.009					
.148	-.427	-.475	-.394	.013					
.209	-.345	-.385	-.306	.012	.209	-.712	-.759	-.675	.010
.294	-.463	-.497	-.426	.012	.294	-.800	-.844	-.764	.012
.350	-.469	-.517	-.423	.012	.350	-.841	-.887	-.803	.010
.407	-.525	-.568	-.485	.012	.407	-.956	-1.007	-.925	.011
.463	-.568	-.622	-.525	.011	.463	-1.027	-1.079	-.671	.024
.519	-.579	-.630	-.525	.014	.519	-.324	-.508	-.216	.035
.579	-.661	-.716	-.621	.013	.579	-.223	-.334	-.112	.034
.659	-.677	-.727	-.632	.013	.659	-.106	-.260	.030	.042
.739	-.726	-.831	-.166	.118	.739	.053	-.111	.154	.040
.819	-.176	-.338	-.063	.037	.819	.206	.008	.305	.039
.899	-.026	-.122	.034	.021	.899	.343	.165	.444	.040
.990	.137	.068	.185	.016	.974	.331	.216	.405	.029
ETA=.871					ETA=.871				
X/C	MEAN	MAX	MIN	SIGMA	X/C	MEAN	MAX	MIN	SIGMA
.025	-.044	-.091	-.008	.011	.025	-.668	-.715	-.629	.010
.084	-.316	-.373	-.292	.012	.084	-.781	-.833	-.747	.010
.143	-.300	-.352	-.272	.010	.143	-.795	-.840	-.766	.010
.202	-.355	-.403	-.329	.010	.202	-.790	-.848	-.750	.012
.301	-.487	-.542	-.435	.014	.301	-.779	-.838	-.749	.013
.354	-.460	-.538	-.393	.020	.354	-.909	-.955	-.848	.015
.407	-.463	-.528	-.398	.017	.407	-.872	-.930	-.821	.015
.460	-.476	-.519	-.426	.015	.460	-.906	-1.000	-.248	.098
.513	-.602	-.653	-.207	.015	.513	-.321	-.689	-.108	.067
.566	-.725	-.779	-.666	.015	.566	-.150	-.346	-.028	.049
.680	-.708	-.794	-.187	.069	.680	.080	-.046	.139	.021
.742	-.455	-.821	-.095	.173	.742	.171	.097	.223	.018
.830	-.094	-.196	.000	.029	.830	.356	.292	.405	.013
.910	-.001	-.084	.063	.021	.910	.394	.338	.435	.014
.990	.158	.059	.216	.019	.975	.299	.231	.346	.013
ETA=.972					ETA=.972				
X/C	MEAN	MAX	MIN	SIGMA	X/C	MEAN	MAX	MIN	SIGMA
.025	-.247	-.305	-.188	.018	.025	-.733	-.784	-.697	.013
.092	-.330	-.346	-.286	.011	.092	-.770	-.826	-.708	.018
.126	-.465	-.509	-.415	.011	.126	-.791	-.854	-.724	.020
.227	-.539	-.589	-.507	.011	.227	-.823	-.874	-.778	.014
.294	-.620	-.672	-.576	.010	.294	-.863	-.934	-.745	.034
.362	-.634	-.685	-.567	.023	.362	-.709	-.885	-.039	.142
.430	-.651	-.730	-.259	.027	.430	-.132	-.664	.055	.105
.497	-.566	-.727	-.133	.121	.497	-.031	-.160	.069	.036
.565	-.180	-.713	.037	.128	.565	-.022	-.119	.077	.033
.632	-.105	-.266	.016	.041	.632	.063	-.009	.149	.023
.700	-.114	-.241	.004	.041	.700	.175	.117	.244	.017
.767	-.091	-.180	.005	.028	.767	.300	.250	.345	.015
.835	-.022	-.092	.054	.022	.835	.354	.303	.412	.015
.902	.006	-.054	.064	.020	.902	.370	.289	.398	.020
.990	.126	.077	.205	.019	.973	.241	.193	.287	.015

Table 11. Continued

(e) Tab point 128,  $M = 0.92$ ,  $q = 151.4$  psf,  $\alpha = -2^\circ$

ETA=.707					ETA=.707				
X/C	MEAN	MAX	MIN	SIGMA	X/C	MEAN	MAX	MIN	SIGMA
.025	-.137	-.186	-.093	.013	.209	-.656	-.703	-.621	.009
.087	-.376	-.410	-.342	.009	.294	-.747	-.787	-.720	.007
.148	-.456	-.495	-.428	.009	.350	-.809	-.850	-.780	.009
.209	-.358	-.408	-.319	.010	.407	-.927	-.967	-.899	.010
.294	-.467	-.506	-.437	.009	.463	-.992	-1.037	-.958	.009
.350	-.491	-.537	-.456	.009	.519	-.630	-1.003	-.300	.153
.407	-.571	-.621	-.540	.011	.579	-.362	-.475	-.260	.029
.463	-.589	-.627	-.545	.014	.659	-.362	-.453	-.265	.025
.519	-.586	-.635	-.555	.011	.739	-.351	-.459	-.108	.034
.579	-.659	-.707	-.626	.010	.819	-.244	-.418	.031	.059
.659	-.702	-.741	-.660	.009	.899	-.007	-.199	.251	.069
.739	-.819	-.865	-.681	.011	.974	.181	-.009	.359	.057
.819	-.274	-.375	-.212	.022					
.899	-.171	-.234	-.083	.020					
.990	-.011	-.139	.089	.034					

ETA=.871					ETA=.871				
X/C	MEAN	MAX	MIN	SIGMA	X/C	MEAN	MAX	MIN	SIGMA
.025	-.075	-.123	-.031	.013	.025	-.576	-.623	-.539	.012
.084	-.341	-.385	-.306	.008	.084	-.689	-.726	-.655	.011
.143	-.332	-.387	-.264	.016	.143	-.720	-.768	-.685	.009
.202	-.331	-.367	-.296	.009	.202	-.728	-.753	-.705	.009
.301	-.485	-.537	-.464	.011	.301	-.726	-.765	-.704	.009
.354	-.528	-.570	-.488	.011	.354	-.863	-.893	-.836	.009
.407	-.542	-.605	-.490	.011	.407	-.843	-.892	-.810	.009
.460	-.555	-.594	-.493	.015	.460	-.919	-.960	-.891	.009
.513	-.611	-.658	-.576	.012	.513	-.955	-1.001	-.924	.009
.566	-.762	-.801	-.724	.012	.566	-.512	-1.023	-.347	.113
.680	-.750	-.795	-.714	.011	.680	-.331	-.437	-.224	.037
.742	-.764	-.855	-.451	.054	.742	-.222	-.356	-.039	.046
.830	-.180	-.261	-.095	.020	.830	.179	-.003	.339	.049
.910	-.098	-.188	.014	.029	.910	.381	.281	.458	.022
.990	.067	-.049	.151	.031	.975	.270	.213	.314	.018

ETA=.972					ETA=.972				
X/C	MEAN	MAX	MIN	SIGMA	X/C	MEAN	MAX	MIN	SIGMA
.025	-.280	-.341	-.217	.019	.025	-.653	-.690	-.617	.011
.092	-.333	-.394	-.289	.011	.092	-.684	-.745	-.619	.018
.126	-.451	-.495	-.415	.011	.126	-.709	-.761	-.658	.016
.227	-.529	-.572	-.504	.009	.227	-.769	-.814	-.744	.011
.294	-.608	-.641	-.560	.010	.294	-.866	-.908	-.839	.009
.362	-.680	-.734	-.643	.015	.362	-.821	-.883	-.766	.024
.430	-.718	-.766	-.663	.014	.430	-.792	-.870	-.562	.039
.497	-.748	-.799	-.695	.015	.497	-.335	-.543	-.167	.056
.565	-.782	-.829	-.658	.018	.565	-.145	-.307	.039	.053
.632	-.261	-.639	-.080	.071	.632	-.030	-.221	.133	.051
.700	-.097	-.199	.015	.037	.700	.076	-.089	.215	.047
.767	-.018	-.130	.061	.026	.767	.167	.036	.289	.039
.835	.033	-.042	.088	.019	.835	.215	.036	.353	.047
.902	.048	-.018	.108	.019	.902	.249	.092	.374	.037
.990	.132	.041	.199	.024	.973	.202	.085	.301	.031

Table 11. Continued

(f) Tab point 130,  $M = 0.94$ ,  $q = 156.1$  psf,  $\alpha = -2^\circ$

ETA=.707					ETA=.707				
X/C	MEAN	MAX	CP UPPER MIN	SIGMA	X/C	MEAN	MAX	CP LOWER MIN	SIGMA
.025	-.144	-.192	-.101	.013					
.087	-.369	-.420	-.343	.011					
.148	-.437	-.469	-.404	.008					
.209	-.350	-.395	-.331	.008	.209	-.607	-.659	-.579	.009
.294	-.447	-.479	-.424	.008	.294	-.709	-.752	-.677	.009
.350	-.474	-.509	-.443	.009	.350	-.761	-.813	-.722	.010
.407	-.553	-.591	-.535	.009	.407	-.876	-.915	-.850	.008
.463	-.586	-.631	-.551	.011	.463	-.945	-.984	-.929	.008
.519	-.584	-.616	-.549	.008	.519	-.957	-1.005	-.643	.022
.579	-.650	-.696	-.618	.009	.579	-.441	-.815	-.315	.058
.659	-.681	-.718	-.662	.008	.659	-.399	-.473	-.314	.024
.739	-.798	-.839	-.727	.009	.739	-.398	-.479	-.332	.024
.819	-.299	-.386	-.240	.022	.819	-.385	-.473	-.294	.029
.899	-.240	-.294	-.171	.015	.899	-.248	-.379	-.073	.045
.990	-.142	-.245	-.046	.027	.974	-.053	-.187	.170	.059
ETA=.871					ETA=.871				
X/C	MEAN	MAX	CP UPPER MIN	SIGMA	X/C	MEAN	MAX	CP LOWER MIN	SIGMA
.025	-.086	-.142	.082	.012	.025	-.515	-.557	-.488	.013
.084	-.335	-.373	-.318	.008	.084	-.631	-.681	-.589	.011
.143	-.336	-.386	-.299	.010	.143	-.671	-.710	-.641	.009
.202	-.325	-.368	-.298	.010	.202	-.678	-.718	-.649	.009
.301	-.488	-.541	-.440	.016	.301	-.679	-.718	-.647	.007
.354	-.513	-.553	-.484	.007	.354	-.809	-.844	-.777	.010
.407	-.530	-.576	-.498	.008	.407	-.796	-.842	-.762	.010
.460	-.555	-.608	-.521	.012	.460	-.876	-.919	-.842	.008
.513	-.601	-.627	-.570	.011	.513	-.913	-.949	-.885	.008
.566	-.749	-.776	-.712	.008	.566	-.988	-1.025	-.725	.016
.680	-.740	-.771	-.703	.009	.680	-.460	-.532	-.380	.027
.742	-.754	-.840	-.549	.040	.742	-.394	-.475	-.310	.030
.830	-.207	-.276	-.161	.015	.830	-.122	-.314	.125	.061
.910	-.159	-.205	-.113	.015	.910	.325	.008	.444	.065
.990	-.033	-.116	.044	.021	.975	.254	.153	.315	.021
ETA=.972					ETA=.972				
X/C	MEAN	MAX	CP UPPER MIN	SIGMA	X/C	MEAN	MAX	CP LOWER MIN	SIGMA
.025	-.287	-.342	-.199	.017	.025	-.598	-.633	-.563	.014
.092	-.328	-.382	-.292	.012	.092	-.621	-.667	-.567	.017
.126	-.445	-.491	-.402	.015	.126	-.649	-.693	-.593	.015
.227	-.504	-.543	-.477	.008	.227	-.719	-.766	-.687	.010
.294	-.586	-.633	-.565	.008	.294	-.824	-.858	-.802	.009
.362	-.663	-.723	-.634	.010	.362	-.833	-.868	-.777	.007
.430	-.704	-.754	-.676	.010	.430	-.793	-.844	-.740	.019
.497	-.738	-.775	-.707	.011	.497	-.593	-.787	-.310	.080
.565	-.782	-.815	-.572	.013	.565	-.313	-.506	-.101	.061
.632	-.345	-.608	-.158	.068	.632	-.200	-.352	-.009	.050
.700	-.190	-.285	-.112	.022	.700	-.093	-.261	.066	.049
.767	-.124	-.234	-.028	.029	.767	.004	-.132	.136	.040
.835	-.053	-.144	.051	.029	.835	.065	-.113	.285	.056
.902	-.013	-.129	.105	.031	.902	.112	-.036	.249	.047
.990	.072	-.102	.193	.034	.973	.127	-.006	.292	.044

Table 11. Continued

(g) Tab point 132,  $M = 0.96$ ,  $q = 160.3$  psf,  $\alpha = -2^\circ$

ETA=.707					ETA=.707				
X/C	MEAN	MAX	CP UPPER MIN	SIGMA	X/C	MEAN	MAX	CP LOWER MIN	SIGMA
.025	-.185	-.231	-.143	.010					
.087	-.384	-.420	-.355	.008					
.148	-.436	-.468	-.415	.005					
.209	-.357	-.395	-.333	.008	.209	-.549	-.586	-.520	.008
.294	-.418	-.456	-.402	.008	.294	-.661	-.701	-.638	.006
.350	-.456	-.496	-.420	.010	.350	-.724	-.758	-.692	.009
.407	-.530	-.576	-.510	.006	.407	-.824	-.870	-.806	.007
.463	-.582	-.614	-.548	.008	.463	-.894	-.926	-.872	.008
.519	-.579	-.621	-.557	.007	.519	-.909	-.947	-.894	.007
.579	-.648	-.689	-.624	.007	.579	-.994	-1.018	-.977	.006
.659	-.670	-.699	-.645	.007	.659	-.834	-1.038	-.572	.103
.739	-.780	-.817	-.763	.008	.739	-.544	-.589	-.500	.013
.819	-.463	-.673	-.343	.053	.819	-.506	-.569	-.460	.015
.899	-.318	-.374	-.276	.013	.899	-.402	-.465	-.337	.019
.990	-.264	-.335	-.217	.017	.974	-.234	-.301	-.138	.024
ETA=.871					ETA=.871				
X/C	MEAN	MAX	CP UPPER MIN	SIGMA	X/C	MEAN	MAX	CP LOWER MIN	SIGMA
.025	-.129	-.160	-.106	.009	.025	-.427	-.464	-.396	.008
.084	-.382	-.417	-.363	.010	.084	-.531	-.562	-.506	.007
.143	-.385	-.429	-.355	.011	.143	-.588	-.635	-.567	.008
.202	-.347	-.392	-.302	.013	.202	-.613	-.644	-.588	.008
.301	-.480	-.517	-.458	.006	.301	-.621	-.664	-.595	.009
.354	-.495	-.527	-.472	.006	.354	-.740	-.778	-.713	.007
.407	-.511	-.550	-.485	.007	.407	-.718	-.765	-.698	.008
.460	-.563	-.603	-.539	.007	.460	-.816	-.852	-.798	.007
.513	-.594	-.621	-.566	.008	.513	-.851	-.893	-.830	.005
.566	-.728	-.766	-.704	.008	.566	-.923	-.966	-.901	.008
.680	-.740	-.772	-.718	.008	.680	-1.024	-1.059	-.953	.008
.742	-.821	-.862	-.797	.007	.742	-.638	-.934	-.497	.074
.830	-.318	-.381	-.247	.019	.830	-.457	-.514	-.399	.015
.910	-.277	-.334	-.234	.015	.910	-.365	-.439	-.249	.022
.990	-.194	-.246	-.146	.014	.975	-.172	-.253	.032	.031
ETA=.972					ETA=.972				
X/C	MEAN	MAX	CP UPPER MIN	SIGMA	X/C	MEAN	MAX	CP LOWER MIN	SIGMA
.025	-.319	-.365	-.290	.010	.025	-.527	-.548	-.503	.009
.092	-.360	-.405	-.317	.016	.092	-.501	-.563	-.444	.015
.126	-.464	-.499	-.435	.009	.126	-.541	-.588	-.513	.012
.227	-.500	-.540	-.476	.007	.227	-.652	-.692	-.626	.007
.294	-.568	-.605	-.539	.006	.294	-.760	-.814	-.737	.008
.362	-.645	-.672	-.618	.007	.362	-.758	-.812	-.745	.007
.430	-.685	-.724	-.659	.008	.430	-.821	-.866	-.788	.005
.497	-.723	-.754	-.700	.005	.497	-.819	-.900	-.701	.033
.565	-.761	-.783	-.740	.009	.565	-.747	-.876	-.447	.064
.632	-.673	-.817	-.345	.086	.632	-.560	-.755	-.309	.063
.700	-.235	-.333	-.176	.026	.700	-.427	-.583	-.275	.051
.767	-.190	-.292	-.133	.026	.767	-.334	-.454	-.215	.032
.835	-.159	-.230	-.096	.017	.835	-.272	-.377	-.044	.041
.902	-.145	-.212	-.082	.018	.902	-.197	-.291	-.035	.035
.990	-.106	-.313	.028	.049	.973	-.104	-.263	.091	.054



Table 11. Continued

(h) Tab point 240,  $M = 0.80$ ,  $q = 123.8$  psf,  $\alpha = -1^\circ$

ETA=.707					ETA=.707				
X/C	MEAN	MAX	CP UPPER MIN	SIGMA	X/C	MEAN	MAX	CP LOWER MIN	SIGMA
.025	-.328	-.406	-.278	.017					
.087	-.517	-.589	-.422	.017					
.148	-.511	-.582	-.403	.023					
.209	-.393	-.446	-.324	.016	.209	-.402	-.468	-.297	.025
.294	-.457	-.546	-.281	.039	.294	-.421	-.505	-.315	.028
.350	-.445	-.539	-.329	.033	.350	-.410	-.517	-.333	.026
.407	-.539	-.681	-.370	.046	.407	-.476	-.556	-.376	.030
.463	-.521	-.664	-.378	.051	.463	-.425	-.510	-.344	.023
.519	-.481	-.660	-.313	.060	.519	-.290	-.372	-.219	.023
.579	-.480	-.674	-.324	.054	.579	-.184	-.253	-.122	.019
.659	-.382	-.525	-.258	.043	.659	.016	-.028	.072	.015
.739	-.374	-.487	-.247	.035	.739	.185	.126	.255	.013
.819	-.271	-.359	-.188	.023	.819	.301	.247	.346	.013
.899	-.112	-.175	-.062	.020	.899	.402	.353	.436	.012
.990	.126	.057	.154	.012	.974	.344	.275	.387	.013
ETA=.871					ETA=.871				
X/C	MEAN	MAX	CP UPPER MIN	SIGMA	X/C	MEAN	MAX	CP LOWER MIN	SIGMA
.025	-.282	-.346	-.247	.014	.025	-.459	-.527	-.395	.018
.084	-.469	-.505	-.422	.009	.084	-.474	-.515	-.428	.014
.143	-.432	-.496	-.373	.015	.143	-.458	-.515	-.413	.014
.202	-.420	-.475	-.373	.017	.202	-.455	-.524	-.379	.018
.301	-.388	-.466	-.287	.030	.301	-.402	-.494	-.299	.027
.354	-.420	-.516	-.271	.039	.354	-.386	-.482	-.285	.025
.407	-.426	-.529	-.304	.035	.407	-.364	-.466	-.265	.025
.460	-.449	-.573	-.312	.039	.460	-.389	-.471	-.317	.026
.513	-.458	-.613	-.255	.049	.513	-.306	-.422	-.233	.020
.566	-.484	-.650	-.328	.044	.566	-.219	-.296	-.142	.021
.680	-.367	-.460	-.276	.027	.680	.014	-.036	.211	.014
.742	-.307	-.376	-.235	.021	.742	.124	.071	.160	.014
.830	-.175	-.238	-.137	.011	.830	.316	.264	.358	.011
.910	-.123	-.180	-.079	.013	.910	.348	.279	.381	.020
.990	.128	.064	.179	.017	.975	.244	.196	.279	.011
ETA=.972					ETA=.972				
X/C	MEAN	MAX	CP UPPER MIN	SIGMA	X/C	MEAN	MAX	CP LOWER MIN	SIGMA
.025	-.515	-.602	-.450	.023	.025	-.614	-.718	-.526	.029
.092	-.489	-.571	-.429	.029	.092	-.408	-.495	-.326	.026
.126	-.515	-.609	-.414	.029	.126	-.397	-.497	-.301	.027
.227	-.407	-.484	-.263	.028	.227	-.394	-.458	-.358	.015
.294	-.342	-.426	-.240	.028	.294	-.330	-.391	-.264	.020
.362	-.333	-.442	-.233	.027	.362	-.258	-.328	-.156	.025
.430	-.313	-.410	-.228	.026	.430	-.281	-.384	-.196	.020
.497	-.251	-.322	-.195	.015	.497	-.213	-.305	-.162	.020
.565	-.253	-.320	-.139	.024	.565	-.145	-.191	-.089	.022
.632	-.249	-.327	-.182	.023	.632	-.044	-.110	.020	.016
.700	-.206	-.269	-.138	.021	.700	.112	.065	.147	.013
.767	-.170	-.225	-.115	.022	.767	.237	.190	.274	.012
.835	-.100	-.173	-.057	.015	.835	.284	.232	.333	.015
.902	-.060	-.111	.001	.015	.902	.289	.239	.339	.014
.990	.074	.006	.144	.016	.973	.206	.153	.236	.013

Table 11. Continued

(i) Tab point 245,  $M = 0.85$ ,  $q = 136.3$  psf,  $\alpha = -1^\circ$

ETA=.707					ETA=.707				
X/C	MEAN	MAX	MIN	SIGMA	X/C	MEAN	MAX	MIN	SIGMA
.025	-.252	-.304	-.213	.013					
.087	-.493	-.535	-.459	.009					
.148	-.504	-.553	-.466	.013					
.209	-.403	-.454	-.368	.014	.209	-.452	-.581	-.283	.053
.294	-.518	-.597	-.445	.020	.294	-.495	-.681	-.323	.070
.350	-.477	-.541	-.413	.016	.350	-.472	-.625	-.328	.045
.407	-.592	-.657	-.541	.015	.407	-.543	-.744	-.367	.069
.463	-.622	-.694	-.564	.016	.463	-.453	-.640	-.300	.049
.519	-.631	-.701	-.537	.021	.519	-.299	-.413	-.186	.033
.579	-.701	-.765	-.460	.023	.579	-.173	-.254	-.087	.025
.659	-.549	-.758	-.209	.138	.659	.026	-.039	.092	.018
.739	-.312	-.557	-.135	.065	.739	.194	.140	.244	.019
.819	-.233	-.378	-.119	.037	.819	.293	.224	.340	.014
.899	-.074	-.146	-.005	.021	.899	.390	.333	.445	.012
.990	.144	.090	.191	.013	.974	.357	.300	.402	.015

ETA=.871					ETA=.871				
X/C	MEAN	MAX	MIN	SIGMA	X/C	MEAN	MAX	MIN	SIGMA
.025	-.226	-.276	-.186	.011	.025	-.547	-.611	-.478	.022
.084	-.485	-.534	-.459	.007	.084	-.592	-.666	-.547	.016
.143	-.442	-.488	-.413	.009	.143	-.547	-.600	-.494	.015
.202	-.449	-.498	-.405	.012	.202	-.543	-.607	-.463	.020
.301	-.491	-.574	-.342	.037	.301	-.512	-.639	-.340	.058
.354	-.503	-.573	-.324	.030	.354	-.440	-.616	-.297	.048
.407	-.489	-.582	-.314	.035	.407	-.420	-.567	-.280	.046
.460	-.540	-.632	-.308	.046	.460	-.443	-.655	-.288	.051
.513	-.588	-.712	-.270	.083	.513	-.339	-.482	-.199	.042
.566	-.601	-.858	-.250	.131	.566	-.222	-.320	-.117	.028
.680	-.363	-.597	-.199	.062	.680	.023	-.020	.067	.016
.742	-.295	-.419	-.175	.038	.742	.132	.078	.186	.015
.830	-.159	-.229	-.098	.016	.830	.316	.264	.362	.014
.910	-.102	-.151	-.045	.015	.910	.339	.293	.372	.010
.990	.149	.084	.202	.016	.975	.252	.203	.278	.012

ETA=.972					ETA=.972				
X/C	MEAN	MAX	MIN	SIGMA	X/C	MEAN	MAX	MIN	SIGMA
.025	-.476	-.534	-.396	.019	.025	-.711	-.786	-.585	.030
.092	-.494	-.544	-.415	.016	.092	-.484	-.589	-.360	.029
.126	-.603	-.654	-.528	.015	.126	-.563	-.655	-.426	.030
.227	-.617	-.742	-.402	.055	.227	-.510	-.635	-.416	.031
.294	-.414	-.633	-.179	.092	.294	-.362	-.560	-.227	.043
.362	-.328	-.503	-.160	.053	.362	-.270	-.428	-.141	.040
.430	-.337	-.499	-.182	.051	.430	-.302	-.414	-.178	.036
.497	-.253	-.356	-.203	.030	.497	-.224	-.329	-.147	.027
.565	-.261	-.366	-.126	.038	.565	-.143	-.213	-.054	.024
.632	-.253	-.350	-.165	.030	.632	-.040	-.099	.031	.018
.700	-.202	-.297	-.086	.027	.700	.122	.071	.184	.013
.767	-.164	-.217	-.080	.024	.767	.238	.198	.287	.013
.835	-.089	-.157	-.052	.017	.835	.276	.224	.328	.013
.902	-.050	-.101	.014	.018	.902	.289	.217	.334	.015
.990	.093	.031	.156	.020	.973	.213	.164	.265	.016

Table 11. Continued

(j) Tab point 248,  $M = 0.88$ ,  $q = 144.5$  psf,  $\alpha = -1^\circ$ 

ETA=.707					ETA=.707				
X/C	MEAN	MAX	MIN	SIGMA	X/C	MEAN	MAX	MIN	SIGMA
.025	-.188	-.250	-.153	.013					
.087	-.447	-.481	-.422	.008					
.148	-.494	-.534	-.464	.008					
.209	-.409	-.440	-.371	.012	.209	-.676	-.732	-.646	.012
.294	-.533	-.576	-.504	.011	.294	-.742	-.806	-.678	.020
.350	-.509	-.559	-.474	.009	.350	-.732	-.797	-.675	.015
.407	-.616	-.669	-.572	.017	.407	-.870	-.940	-.299	.065
.463	-.618	-.667	-.581	.012	.463	-.457	-.984	-.153	.192
.519	-.643	-.685	-.614	.012	.519	-.226	-.414	-.069	.047
.579	-.711	-.771	-.675	.011	.579	-.137	-.251	-.014	.034
.659	-.729	-.776	-.680	.014	.659	.038	-.024	.099	.019
.739	-.786	-.877	-.212	.077	.739	.205	.145	.255	.017
.819	-.196	-.308	-.088	.037	.819	.308	.260	.345	.016
.899	-.029	-.102	.044	.022	.899	.421	.373	.468	.015
.990	.131	.073	.180	.014	.974	.378	.320	.416	.019
ETA=.871					ETA=.871				
X/C	MEAN	MAX	MIN	SIGMA	X/C	MEAN	MAX	MIN	SIGMA
.025	-.147	-.176	-.115	.010	.025	-.604	-.640	-.565	.012
.084	-.433	-.469	-.409	.006	.084	-.696	-.741	-.654	.012
.143	-.391	-.437	-.367	.009	.143	-.727	-.768	-.692	.010
.202	-.412	-.457	-.382	.008	.202	-.737	-.784	-.660	.012
.301	-.542	-.586	-.520	.009	.301	-.700	-.783	-.244	.058
.354	-.570	-.640	-.529	.013	.354	-.617	-.835	-.220	.165
.407	-.561	-.610	-.502	.014	.407	-.422	-.781	-.091	.138
.460	-.589	-.656	-.538	.014	.460	-.435	-.858	-.188	.100
.513	-.658	-.722	-.599	.015	.513	-.343	-.721	-.130	.079
.566	-.788	-.833	-.741	.013	.566	-.201	-.374	-.074	.036
.680	-.696	-.843	-.140	.136	.680	.047	-.008	.110	.016
.742	-.320	-.759	-.080	.108	.742	.156	.099	.227	.017
.830	-.115	-.217	-.030	.024	.830	.334	.272	.388	.015
.910	-.042	-.117	.019	.027	.910	.355	.314	.413	.014
.990	.170	.092	.228	.015	.975	.276	.227	.321	.014
ETA=.972					ETA=.972				
X/C	MEAN	MAX	MIN	SIGMA	X/C	MEAN	MAX	MIN	SIGMA
.025	-.384	-.433	-.338	.013	.025	-.711	-.755	-.679	.012
.092	-.437	-.490	-.392	.013	.092	-.666	-.773	-.508	.037
.126	-.552	-.582	-.522	.011	.126	-.666	-.763	-.499	.026
.227	-.626	-.677	-.593	.011	.227	-.781	-.832	-.637	.021
.294	-.706	-.744	-.646	.012	.294	-.722	-.902	-.263	.113
.362	-.712	-.787	-.283	.035	.362	-.169	-.822	.027	.136
.430	-.623	-.747	-.148	.112	.430	-.205	-.453	-.007	.070
.497	-.270	-.663	-.095	.106	.497	-.183	-.311	-.040	.040
.565	-.172	-.358	-.036	.048	.565	-.119	-.189	-.014	.028
.632	-.191	-.331	-.056	.039	.632	-.020	-.082	.067	.020
.700	-.163	-.280	-.019	.037	.700	.132	.091	.197	.016
.767	-.137	-.205	-.040	.028	.767	.265	.211	.307	.013
.835	-.067	-.136	.013	.018	.835	.302	.249	.359	.020
.902	-.038	-.095	.037	.018	.902	.310	.242	.365	.015
.990	.097	.041	.171	.022	.973	.225	.179	.298	.015

Table 11. Continued

(k) Tab point 251,  $M = 0.90$ ,  $q = 148.5$  psf,  $\alpha = -1^\circ$ 

ETA=.707					ETA=.707				
X/C	MEAN	MAX	MIN	SIGMA	X/C	MEAN	MAX	MIN	SIGMA
.025	-.315	-.362	-.279	.011					
.087	-.507	-.550	-.480	.009					
.148	-.571	-.600	-.543	.010					
.209	-.525	-.564	-.485	.009	.209	-.565	-.617	-.522	.015
.294	-.565	-.618	-.537	.014	.294	-.666	-.716	-.625	.012
.350	-.552	-.590	-.520	.012	.350	-.707	-.752	-.669	.011
.407	-.703	-.745	-.674	.010	.407	-.850	-.903	-.106	.017
.463	-.723	-.780	-.685	.013	.463	-.924	-.980	-.888	.011
.519	-.717	-.771	-.678	.012	.519	-.399	-.807	-.171	.113
.579	-.758	-.808	-.727	.010	.579	-.171	-.277	-.069	.031
.659	-.793	-.837	-.755	.011	.659	-.076	-.215	.048	.044
.739	-.860	-.912	-.453	.048	.739	.063	-.098	.189	.050
.819	-.286	-.371	-.204	.021	.819	.198	.030	.312	.045
.899	-.164	-.264	-.075	.026	.899	.357	.249	.455	.032
.990	.011	-.103	.117	.028	.974	.323	.229	.393	.024
ETA=.871					ETA=.871				
X/C	MEAN	MAX	MIN	SIGMA	X/C	MEAN	MAX	MIN	SIGMA
.025	-.253	-.288	-.218	.014	.025	-.454	-.501	-.403	.012
.084	-.543	-.594	-.513	.010	.084	-.590	-.636	-.563	.010
.143	-.559	-.619	-.516	.014	.143	-.636	-.674	-.613	.012
.202	-.512	-.566	-.469	.017	.202	-.674	-.714	-.642	.011
.301	-.524	-.612	-.474	.020	.301	-.639	-.712	-.549	.023
.354	-.612	-.658	-.574	.011	.354	-.679	-.766	-.601	.018
.407	-.611	-.652	-.582	.010	.407	-.680	-.736	-.616	.017
.460	-.670	-.729	-.638	.012	.460	-.818	-.870	-.439	.020
.513	-.745	-.786	-.702	.011	.513	-.684	-.916	-.161	.196
.566	-.868	-.911	-.821	.013	.566	-.211	-.434	-.060	.047
.680	-.857	-.914	-.820	.011	.680	.016	-.156	.084	.029
.742	-.593	-.903	-.290	.129	.742	.127	-.028	.208	.026
.830	-.218	-.308	-.017	.028	.830	.324	.242	.378	.018
.910	-.125	-.259	-.005	.040	.910	.338	.269	.390	.015
.990	.081	-.079	.186	.035	.975	.233	.141	.289	.021
ETA=.972					ETA=.972				
X/C	MEAN	MAX	MIN	SIGMA	X/C	MEAN	MAX	MIN	SIGMA
.025	-.481	-.537	-.433	.016	.025	-.608	-.661	-.574	.010
.092	-.530	-.607	-.476	.017	.092	-.493	-.576	-.436	.020
.126	-.635	-.683	-.578	.017	.126	-.612	-.649	-.579	.011
.227	-.669	-.751	-.612	.027	.227	-.745	-.785	-.702	.012
.294	-.717	-.771	-.688	.012	.294	-.843	-.901	-.772	.018
.362	-.778	-.824	-.742	.012	.362	-.791	-.884	-.441	.031
.430	-.782	-.843	-.715	.016	.430	-.539	-.863	-.043	.210
.497	-.763	-.834	-.622	.022	.497	-.075	-.207	.021	.035
.565	-.615	-.882	-.093	.182	.565	-.042	-.172	.047	.030
.632	-.132	-.722	.055	.066	.632	.003	-.152	.089	.022
.700	-.038	-.176	.079	.032	.700	.139	-.015	.214	.023
.767	-.065	-.165	.030	.026	.767	.245	.041	.299	.025
.835	-.020	-.084	.073	.024	.835	.266	.062	.350	.028
.902	-.018	-.081	.083	.021	.902	.284	.139	.343	.023
.990	.114	.040	.212	.022	.973	.230	.139	.290	.017

Table 11. Continued

(l) Tab point 254,  $M = 0.92$ ,  $q = 153.3$  psf,  $\alpha = -1^\circ$

ETA=.707					ETA=.707				
X/C	MEAN	MAX	MIN	SIGMA	X/C	MEAN	MAX	MIN	SIGMA
.025	-.215	-.282	-.155	.020					
.087	-.437	-.498	-.397	.010					
.148	-.491	-.536	-.437	.016					
.209	-.410	-.459	-.349	.013	.209	-.630	-.666	-.609	.008
.294	-.499	-.542	-.474	.009	.294	-.752	-.803	-.726	.010
.350	-.492	-.537	-.458	.010	.350	-.710	-.751	-.682	.011
.407	-.637	-.698	-.584	.012	.407	-.877	-.919	-.852	.009
.463	-.640	-.698	-.582	.015	.463	-.946	-.982	-.915	.008
.519	-.648	-.701	-.589	.013	.519	-.418	-.859	-.244	.106
.579	-.683	-.737	-.647	.012	.579	-.273	-.353	-.183	.026
.659	-.711	-.765	-.663	.011	.659	-.277	-.359	-.173	.028
.739	-.814	-.860	-.644	.013	.739	-.181	-.303	.009	.041
.819	-.262	-.347	-.186	.021	.819	-.028	-.187	.177	.055
.899	-.139	-.222	-.050	.022	.899	.205	.007	.396	.057
.990	.028	-.077	.113	.026	.974	.289	.154	.403	.039

ETA=.871					ETA=.871				
X/C	MEAN	MAX	MIN	SIGMA	X/C	MEAN	MAX	MIN	SIGMA
.025	-.163	-.234	-.108	.018	.025	-.513	-.567	-.461	.015
.084	-.447	-.486	-.408	.017	.084	-.636	-.698	-.604	.014
.143	-.417	-.500	-.345	.027	.143	-.673	-.711	-.640	.010
.202	-.391	-.466	-.348	.015	.202	-.705	-.750	-.680	.012
.301	-.506	-.551	-.469	.008	.301	-.718	-.774	-.677	.012
.354	-.588	-.637	-.533	.014	.354	-.795	-.832	-.764	.011
.407	-.566	-.609	-.518	.014	.407	-.775	-.829	-.736	.012
.460	-.621	-.662	-.562	.015	.460	-.902	-.943	-.865	.011
.513	-.691	-.738	-.633	.016	.513	-.706	-.952	-.319	.160
.566	-.807	-.871	-.752	.015	.566	-.296	-.431	-.183	.031
.680	-.795	-.839	-.748	.014	.680	-.188	-.328	.026	.050
.742	-.629	-.874	-.281	.128	.742	-.087	-.243	.153	.066
.830	-.194	-.274	-.099	.027	.830	.171	-.081	.344	.073
.910	-.112	-.216	.006	.037	.910	.271	.074	.377	.046
.990	.091	-.018	.203	.034	.975	.216	.136	.302	.024

ETA=.972					ETA=.972				
X/C	MEAN	MAX	MIN	SIGMA	X/C	MEAN	MAX	MIN	SIGMA
.025	-.383	-.464	-.307	.024	.025	-.624	-.675	-.580	.017
.092	-.438	-.507	-.369	.023	.092	-.619	-.705	-.501	.036
.126	-.528	-.593	-.481	.020	.126	-.646	-.741	-.583	.031
.227	-.592	-.637	-.548	.013	.227	-.763	-.806	-.737	.012
.294	-.677	-.724	-.632	.011	.294	-.874	-.929	-.838	.012
.362	-.739	-.787	-.674	.013	.362	-.800	-.867	-.728	.019
.430	-.746	-.805	-.681	.016	.430	-.703	-.847	-.065	.086
.497	-.760	-.807	-.670	.017	.497	-.132	-.304	.020	.052
.565	-.736	-.854	-.101	.119	.565	-.066	-.237	.093	.043
.632	-.198	-.652	-.006	.091	.632	-.051	-.240	.086	.052
.700	-.036	-.147	.053	.033	.700	.054	-.148	.219	.058
.767	-.020	-.115	.062	.023	.767	.148	-.005	.289	.045
.835	.022	-.058	.094	.021	.835	.182	-.067	.327	.059
.902	.021	-.056	.092	.022	.902	.223	.042	.332	.041
.990	.116	.005	.183	.024	.973	.216	.078	.314	.032

Table 11. Continued

(m) Tab point 257,  $M = 0.94$ ,  $q = 158.6$  psf,  $\alpha = -1^\circ$

ETA=.707					ETA=.707				
X/C	MEAN	MAX	CP UPPER MIN	SIGMA	X/C	MEAN	MAX	CP LOWER MIN	SIGMA
.025	-.231	-.284	-.206	.010					
.087	-.427	-.460	-.406	.005					
.148	-.491	-.530	-.455	.008					
.209	-.448	-.486	-.412	.010	.209	-.579	-.611	-.555	.007
.294	-.484	-.524	-.459	.010	.294	-.697	-.745	-.671	.010
.350	-.473	-.509	-.454	.009	.350	-.670	-.715	-.637	.010
.407	-.617	-.653	-.587	.007	.407	-.833	-.867	-.802	.007
.463	-.651	-.697	-.630	.008	.463	-.886	-.929	-.864	.009
.519	-.644	-.678	-.613	.008	.519	-.895	-.939	-.615	.031
.579	-.679	-.724	-.330	.012	.579	-.370	-.609	-.260	.040
.659	-.714	-.751	-.685	.009	.659	-.365	-.448	-.291	.020
.739	-.804	-.843	-.689	.008	.739	-.322	-.405	-.248	.022
.819	-.342	-.514	-.236	.030	.819	-.300	-.390	-.214	.025
.899	-.251	-.325	-.192	.019	.899	-.199	-.272	-.100	.025
.990	-.164	-.248	-.096	.022	.974	-.089	-.180	.039	.027

ETA=.871					ETA=.871				
X/C	MEAN	MAX	CP UPPER MIN	SIGMA	X/C	MEAN	MAX	CP LOWER MIN	SIGMA
.025	-.194	-.226	-.017	.010	.025	-.425	-.469	-.400	.010
.084	-.467	-.502	-.115	.012	.084	-.560	-.595	-.539	.008
.143	-.486	-.526	-.462	.008	.143	-.603	-.642	-.585	.010
.202	-.459	-.508	-.428	.010	.202	-.648	-.691	-.624	.006
.301	-.479	-.533	-.434	.018	.301	-.664	-.702	-.631	.011
.354	-.547	-.594	-.515	.010	.354	-.734	-.772	-.706	.008
.407	-.546	-.589	-.523	.007	.407	-.724	-.768	-.701	.010
.460	-.613	-.640	-.587	.008	.460	-.852	-.891	-.825	.007
.513	-.686	-.713	-.657	.007	.513	-.887	-.921	-.858	.009
.566	-.798	-.832	-.769	.009	.566	-.745	-.964	-.319	.156
.680	-.794	-.834	-.768	.007	.680	-.379	-.457	-.307	.022
.742	-.841	-.912	-.636	.032	.742	-.352	-.421	-.270	.023
.830	-.281	-.345	-.095	.016	.830	-.303	-.384	-.184	.031
.910	-.242	-.300	-.186	.015	.910	-.217	-.347	-.030	.044
.990	-.076	-.164	.050	.030	.975	-.038	-.167	.143	.044

ETA=.972					ETA=.972				
X/C	MEAN	MAX	CP UPPER MIN	SIGMA	X/C	MEAN	MAX	CP LOWER MIN	SIGMA
.025	-.401	-.449	-.362	.012	.025	-.547	-.573	-.515	.008
.092	-.460	-.524	-.424	.014	.092	-.501	-.573	-.441	.019
.126	-.562	-.607	-.541	.012	.126	-.564	-.597	-.542	.007
.227	-.624	-.681	-.573	.014	.227	-.702	-.735	-.680	.009
.294	-.655	-.700	-.622	.008	.294	-.817	-.855	-.789	.009
.362	-.708	-.750	-.673	.009	.362	-.793	-.850	-.749	.015
.430	-.739	-.779	-.702	.009	.430	-.762	-.876	-.356	.048
.497	-.744	-.803	-.715	.013	.497	-.290	-.574	-.082	.075
.565	-.794	-.837	-.728	.012	.565	-.209	-.354	-.001	.051
.632	-.760	-.846	-.324	.056	.632	-.248	-.390	-.007	.060
.700	-.288	-.664	-.085	.087	.700	-.201	-.390	.051	.065
.767	-.154	-.347	.038	.047	.767	-.169	-.301	.006	.045
.835	-.049	-.192	.080	.043	.835	-.166	-.357	.125	.074
.902	-.028	-.152	.078	.034	.902	-.098	-.251	.108	.059
.990	.011	-.222	.177	.052	.973	.015	-.163	.271	.071

Table 11. Continued

(n) Tab point 260,  $M = 0.96$ ,  $q = 163.4$  psf,  $\alpha = -1^\circ$

ETA=.707					ETA=.707				
X/C	MEAN	MAX	MIN	SIGMA	X/C	MEAN	MAX	MIN	SIGMA
.025	-.222	-.264	-.200	.009					
.087	-.412	-.457	-.394	.006					
.148	-.474	-.514	-.441	.009					
.209	-.438	-.471	-.410	.007	.209	-.520	-.560	-.495	.008
.294	-.491	-.530	-.466	.006	.294	-.641	-.681	-.620	.009
.350	-.467	-.504	-.451	.007	.350	-.627	-.661	-.597	.010
.407	-.600	-.634	-.570	.008	.407	-.768	-.810	-.747	.008
.463	-.633	-.687	-.611	.009	.463	-.829	-.869	-.806	.007
.519	-.638	-.679	-.616	.007	.519	-.852	-.890	-.827	.007
.579	-.651	-.702	-.628	.011	.579	-.953	-.989	-.929	.006
.659	-.688	-.729	-.675	.006	.659	-.820	-1.001	-.533	.109
.739	-.783	-.807	-.764	.008	.739	-.506	-.566	-.436	.015
.819	-.733	-.886	-.412	.087	.819	-.465	-.528	-.421	.014
.899	-.354	-.412	-.294	.018	.899	-.356	-.420	-.306	.016
.990	-.276	-.377	-.220	.017	.974	-.215	-.282	-.143	.022
ETA=.871					ETA=.871				
X/C	MEAN	MAX	MIN	SIGMA	X/C	MEAN	MAX	MIN	SIGMA
.025	-.209	-.251	-.187	.008	.025	-.348	-.388	-.322	.008
.084	-.468	-.508	-.445	.006	.084	-.491	-.522	-.478	.007
.143	-.488	-.521	-.469	.008	.143	-.540	-.567	-.512	.007
.202	-.481	-.515	-.459	.007	.202	-.593	-.627	-.572	.009
.301	-.526	-.556	-.498	.011	.301	-.599	-.635	-.578	.008
.354	-.559	-.598	-.533	.008	.354	-.666	-.706	-.642	.007
.407	-.541	-.593	-.518	.009	.407	-.656	-.691	-.636	.009
.460	-.597	-.621	-.579	.007	.460	-.794	-.832	-.758	.008
.513	-.673	-.703	-.649	.006	.513	-.826	-.852	-.801	.006
.566	-.770	-.797	-.756	.010	.566	-.889	-.924	-.860	.006
.680	-.767	-.788	-.745	.005	.680	-1.011	-1.035	-.993	.006
.742	-.866	-.895	-.842	.006	.742	-.868	-.995	-.555	.094
.830	-.457	-.510	-.411	.013	.830	-.450	-.485	-.424	.012
.910	-.408	-.444	-.367	.011	.910	-.428	-.479	-.391	.011
.990	-.240	-.300	-.202	.014	.975	-.296	-.349	-.266	.011
ETA=.972					ETA=.972				
X/C	MEAN	MAX	MIN	SIGMA	X/C	MEAN	MAX	MIN	SIGMA
.025	-.404	-.446	-.372	.010	.025	-.481	-.522	-.444	.009
.092	-.472	-.519	-.433	.008	.092	-.402	-.470	-.375	.012
.126	-.553	-.588	-.536	.010	.126	-.506	-.536	-.472	.008
.227	-.631	-.661	-.598	.008	.227	-.646	-.681	-.627	.007
.294	-.666	-.711	-.647	.009	.294	-.762	-.808	-.744	.009
.362	-.692	-.727	-.674	.008	.362	-.736	-.759	-.727	.006
.430	-.734	-.777	-.713	.009	.430	-.824	-.850	-.795	.007
.497	-.743	-.789	-.715	.010	.497	-.810	-.871	-.502	.042
.565	-.781	-.812	-.749	.009	.565	-.363	-.631	-.255	.041
.632	-.765	-.810	-.744	.008	.632	-.400	-.542	-.291	.030
.700	-.797	-.842	-.600	.022	.700	-.362	-.503	-.243	.035
.767	-.460	-.783	-.253	.112	.767	-.336	-.441	-.239	.027
.835	-.305	-.427	-.197	.043	.835	-.358	-.531	-.172	.046
.902	-.270	-.382	-.148	.032	.902	-.332	-.418	-.233	.030
.990	-.211	-.487	-.048	.069	.973	-.266	-.411	-.074	.050

Table 11. Continued

(o) Tab point 91,  $M = 0.80$ ,  $q = 123.6$  psf,  $\alpha = 0^\circ$ 

ETA=.707					ETA=.707				
X/C	MEAN	MAX	CP UPPER MIN	SIGMA	X/C	MEAN	MAX	CP LOWER MIN	SIGMA
.025	-.684	-.750	-.622	.017					
.087	-.694	-.739	-.628	.012					
.148	-.675	-.746	-.581	.019					
.209	-.521	-.592	-.443	.019	.209	-.277	-.332	-.203	.019
.294	-.558	-.673	-.393	.044	.294	-.304	-.378	-.215	.022
.350	-.564	-.655	-.430	.037	.350	-.348	-.414	-.271	.021
.407	-.582	-.690	-.378	.047	.407	-.399	-.474	-.321	.022
.463	-.588	-.740	-.410	.061	.463	-.386	-.465	-.313	.021
.519	-.524	-.736	-.346	.075	.519	-.257	-.329	-.204	.020
.579	-.517	-.728	-.348	.062	.579	-.180	-.238	-.119	.017
.659	-.416	-.552	-.313	.038	.659	.049	.007	.093	.015
.739	-.406	-.506	-.309	.031	.739	.188	.140	.227	.012
.819	-.269	-.331	-.217	.020	.819	.308	.250	.363	.013
.899	-.111	-.173	-.060	.014	.899	.378	.337	.433	.010
.990	.119	.053	.150	.016	.974	.295	.245	.344	.013
ETA=.871					ETA=.871				
X/C	MEAN	MAX	CP UPPER MIN	SIGMA	X/C	MEAN	MAX	CP LOWER MIN	SIGMA
.025	-.550	-.603	-.504	.015	.025	-.164	-.235	-.103	.016
.084	-.685	-.734	-.651	.010	.084	-.270	-.333	-.231	.011
.143	-.581	-.650	-.526	.018	.143	-.315	-.366	-.279	.012
.202	-.539	-.593	-.491	.015	.202	-.314	-.371	-.270	.015
.301	-.472	-.594	-.325	.037	.301	-.307	-.364	-.244	.019
.354	-.449	-.568	-.251	.049	.354	-.292	-.361	-.220	.020
.407	-.479	-.598	-.344	.041	.407	-.323	-.398	-.240	.020
.460	-.480	-.617	-.315	.044	.460	-.313	-.378	-.239	.020
.513	-.484	-.660	-.287	.055	.513	-.256	-.319	-.170	.020
.566	-.478	-.657	-.321	.045	.566	-.201	-.255	-.129	.022
.680	-.368	-.492	-.293	.025	.680	.042	-.013	.083	.014
.742	-.306	-.382	-.240	.020	.742	.129	.056	.175	.012
.830	-.176	-.245	-.128	.017	.830	.335	.293	.374	.014
.910	-.067	-.117	-.030	.013	.910	.403	.341	.443	.013
.990	.117	.055	.156	.014	.975	.237	.185	.267	.009
ETA=.972					ETA=.972				
X/C	MEAN	MAX	CP UPPER MIN	SIGMA	X/C	MEAN	MAX	CP LOWER MIN	SIGMA
.025	-.792	-.863	-.724	.021	.025	-.310	-.389	-.211	.023
.092	-.596	-.668	-.497	.023	.092	-.229	-.295	-.154	.019
.126	-.578	-.690	-.466	.036	.126	-.237	-.300	-.173	.021
.227	-.422	-.532	-.296	.036	.227	-.300	-.355	-.256	.014
.294	-.318	-.400	-.214	.026	.294	-.271	-.334	-.221	.016
.362	-.322	-.408	-.254	.031	.362	-.207	-.276	-.118	.023
.430	-.299	-.381	-.226	.025	.430	-.226	-.327	-.138	.019
.497	-.237	-.314	-.200	.011	.497	-.197	-.263	-.119	.019
.565	-.234	-.318	-.151	.023	.565	-.127	-.186	-.069	.019
.632	-.248	-.328	-.182	.021	.632	.013	-.054	.061	.015
.700	-.218	-.272	-.156	.018	.700	.141	.096	.192	.016
.767	-.162	-.227	-.104	.020	.767	.261	.214	.298	.012
.835	-.096	-.153	-.051	.017	.835	.355	.300	.401	.016
.902	-.030	-.079	.020	.014	.902	.360	.297	.398	.014
.990	.097	.023	.133	.014	.973	.226	.172	.269	.014



Table 11. Continued

(p) Tab point 92,  $M = 0.85$ ,  $q = 135.3$  psf,  $\alpha = 0^\circ$

ETA=.707					ETA=.707				
X/C	MEAN	MAX	CP UPPER MIN	SIGMA	X/C	MEAN	MAX	CP LOWER MIN	SIGMA
.025	-.544	-.607	-.503	.012					
.087	-.626	-.675	-.599	.009					
.148	-.687	-.744	-.656	.137					
.209	-.562	-.615	-.504	.013	.209	-.343	-.420	-.237	.028
.294	-.647	-.703	-.601	.012	.294	-.362	-.457	-.233	.034
.350	-.666	-.726	-.598	.016	.350	-.415	-.508	-.286	.036
.407	-.681	-.759	-.591	.021	.407	-.465	-.598	-.319	.041
.463	-.666	-.767	-.571	.022	.463	-.434	-.539	-.311	.035
.519	-.650	-.735	-.545	.029	.519	-.290	-.376	-.186	.028
.579	-.768	-.831	-.626	.020	.579	-.186	-.253	-.061	.023
.659	-.611	-.852	-.234	.147	.659	.052	.006	.138	.017
.739	-.340	-.591	-.191	.051	.739	.198	.154	.259	.017
.819	-.220	-.341	-.133	.031	.819	.312	.254	.357	.014
.899	-.074	-.145	-.015	.018	.899	.374	.320	.421	.015
.990	.135	.074	.175	.013	.974	.301	.237	.339	.013
ETA=.871					ETA=.871				
X/C	MEAN	MAX	CP UPPER MIN	SIGMA	X/C	MEAN	MAX	CP LOWER MIN	SIGMA
.025	-.438	-.486	-.048	.013	.025	-.247	-.321	-.187	.018
.084	-.669	-.708	-.632	.009	.084	-.348	-.423	-.304	.014
.143	-.609	-.656	-.556	.014	.143	-.394	-.442	-.348	.015
.202	-.539	-.595	-.501	.010	.202	-.375	-.431	-.312	.019
.301	-.670	-.717	-.624	.012	.301	-.369	-.496	-.236	.032
.354	-.680	-.730	-.598	.018	.354	-.350	-.445	-.201	.033
.407	-.659	-.752	-.366	.040	.407	-.377	-.469	-.258	.035
.460	-.610	-.714	-.300	.060	.460	-.372	-.499	-.256	.035
.513	-.602	-.773	-.196	.112	.513	-.292	-.402	-.167	.033
.566	-.520	-.857	-.195	.141	.566	-.216	-.297	-.117	.024
.680	-.335	-.552	-.138	.061	.680	.047	.001	.089	.015
.742	-.280	-.400	-.129	.037	.742	.137	.078	.187	.014
.830	-.162	-.223	-.104	.022	.830	.341	.268	.379	.015
.910	-.052	-.107	.013	.014	.910	.406	.364	.497	.012
.990	.142	.077	.182	.013	.975	.256	.207	.294	.013
ETA=.972					ETA=.972				
X/C	MEAN	MAX	CP UPPER MIN	SIGMA	X/C	MEAN	MAX	CP LOWER MIN	SIGMA
.025	-.684	-.737	-.280	.016	.025	-.393	-.477	-.287	.027
.092	-.632	-.727	-.428	.017	.092	-.304	-.384	-.179	.025
.126	-.676	-.732	-.604	.018	.126	-.352	-.453	-.222	.031
.227	-.682	-.764	-.523	.038	.227	-.402	-.468	-.324	.021
.294	-.539	-.704	-.091	.125	.294	-.328	-.408	-.253	.027
.362	-.221	-.526	-.040	.056	.362	-.221	-.331	-.095	.036
.430	-.277	-.462	-.143	.046	.430	-.250	-.364	-.126	.032
.497	-.227	-.338	-.157	.027	.497	-.211	-.292	-.135	.024
.565	-.230	-.354	-.087	.037	.565	-.125	-.210	-.050	.021
.632	-.251	-.353	-.140	.027	.632	.021	-.050	.096	.070
.700	-.216	-.302	-.116	.026	.700	.152	.100	.188	.015
.767	-.157	-.208	-.070	.022	.767	.265	.221	.310	.012
.835	-.087	-.166	-.034	.020	.835	.350	.300	.392	.013
.902	-.021	-.072	.044	.017	.902	.365	.298	.429	.068
.990	.108	.046	.172	.017	.973	.231	.169	.284	.015

Table 11. Continued

(q) Tab point 94,  $M = 0.88$ ,  $q = 143.0$  psf,  $\alpha = 0^\circ$

ETA=.707					ETA=.707				
X/C	MEAN	MAX	CP UPPER MIN	SIGMA	X/C	MEAN	MAX	CP LOWER MIN	SIGMA
.025	-.440	-.488	-.414	.013					
.087	-.572	-.626	-.542	.010					
.148	-.634	-.680	-.597	.009					
.209	-.564	-.605	-.523	.011	.209	-.414	-.508	-.262	.042
.294	-.589	-.629	-.520	.012	.294	-.419	-.573	-.232	.076
.350	-.628	-.663	-.590	.010	.350	-.438	-.615	-.271	.052
.407	-.702	-.755	-.669	.012	.407	-.581	-.697	-.361	.061
.463	-.708	-.762	-.663	.012	.463	-.468	-.749	-.258	.075
.519	-.701	-.755	-.659	.014	.519	-.301	-.439	-.176	.040
.579	-.775	-.834	-.737	.016	.579	-.186	-.262	-.080	.026
.659	-.802	-.842	-.757	.014	.659	.050	-.019	.118	.017
.739	-.591	-.925	-.266	.139	.739	.204	.146	.257	.015
.819	-.189	-.286	-.101	.028	.819	.303	.240	.362	.016
.899	-.048	-.137	.010	.022	.899	.373	.315	.422	.015
.990	.119	.034	.178	.022	.974	.306	.236	.357	.015
ETA=.871					ETA=.871				
X/C	MEAN	MAX	CP UPPER MIN	SIGMA	X/C	MEAN	MAX	CP LOWER MIN	SIGMA
.025	-.329	-.374	-.289	.011	.025	-.339	-.405	-.253	.021
.084	-.593	-.633	-.562	.008	.084	-.454	-.526	-.388	.020
.143	-.572	-.620	-.514	.017	.143	-.464	-.519	-.418	.015
.202	-.494	-.550	-.461	.011	.202	-.428	-.508	-.358	.023
.301	-.618	-.667	-.568	.015	.301	-.447	-.573	-.275	.044
.354	-.636	-.678	-.590	.012	.354	-.401	-.579	-.239	.061
.407	-.668	-.723	-.626	.012	.407	-.407	-.555	-.244	.044
.460	-.665	-.699	-.545	.011	.460	-.440	-.616	-.266	.066
.513	-.766	-.817	-.718	.012	.513	-.319	-.509	-.182	.049
.566	-.846	-.903	-.787	.015	.566	-.215	-.317	-.123	.028
.680	-.559	-.865	-.155	.174	.680	.054	.001	.096	.015
.742	-.225	-.574	-.073	.063	.742	.145	.074	.190	.015
.830	-.080	-.173	-.010	.024	.830	.348	.276	.393	.013
.910	.006	-.063	.062	.020	.910	.408	.370	.457	.014
.990	.158	.085	.197	.014	.975	.270	.231	.314	.011
ETA=.972					ETA=.972				
X/C	MEAN	MAX	CP UPPER MIN	SIGMA	X/C	MEAN	MAX	CP LOWER MIN	SIGMA
.025	-.564	-.613	-.517	.014	.025	-.490	-.604	-.361	.032
.092	-.561	-.614	-.515	.016	.092	-.372	-.448	-.254	.026
.126	-.644	-.692	-.595	.016	.126	-.460	-.562	-.356	.027
.227	-.659	-.710	-.615	.014	.227	-.530	-.602	-.454	.024
.294	-.709	-.764	-.616	.014	.294	-.539	-.726	-.337	.070
.362	-.729	-.812	-.365	.047	.362	-.199	-.512	-.040	.068
.430	-.515	-.752	-.111	.149	.430	-.240	-.382	-.082	.048
.497	-.155	-.503	-.063	.049	.497	-.206	-.338	-.115	.030
.565	-.147	-.323	-.022	.043	.565	-.114	-.173	-.034	.023
.632	-.201	-.321	-.094	.031	.632	.028	-.047	.103	.018
.700	-.181	-.273	-.072	.029	.700	.165	.106	.225	.014
.767	-.132	-.196	-.042	.024	.767	.276	.233	.330	.013
.835	-.063	-.132	-.007	.019	.835	.345	.296	.408	.014
.902	-.011	-.068	.041	.018	.902	.359	.294	.406	.017
.990	.121	.056	.199	.019	.973	.245	.184	.305	.016

Table 11. Continued

(r) Tab point 96,  $M = 0.90$ ,  $q = 148.0$  psf,  $\alpha = 0^\circ$

ETA=.707					ETA=.707				
X/C	MEAN	MAX	CP UPPER MIN	SIGMA	X/C	MEAN	MAX	CP LOWER MIN	SIGMA
.025	-.383	-.436	-.352	.011					
.087	-.522	-.559	-.478	.008					
.148	-.586	-.623	-.543	.009					
.209	-.548	-.597	-.517	.009	.209	-.510	-.563	-.444	.014
.294	-.572	-.632	-.538	.012	.294	-.590	-.645	-.520	.013
.350	-.592	-.641	-.558	.013	.350	-.661	-.714	-.595	.014
.407	-.681	-.730	-.647	.010	.407	-.801	-.859	-.315	.028
.463	-.712	-.761	-.665	.012	.463	-.765	-.933	-.168	.171
.519	-.695	-.742	-.649	.012	.519	-.234	-.506	-.100	.051
.579	-.772	-.819	-.725	.011	.579	-.156	-.286	-.033	.033
.659	-.803	-.861	-.755	.012	.659	.042	-.018	.114	.065
.739	-.711	-.930	-.328	.132	.739	.195	.141	.249	.015
.819	-.235	-.324	-.134	.023	.819	.311	.244	.362	.016
.899	-.102	-.180	-.014	.026	.899	.395	.350	.442	.014
.990	.056	-.037	.137	.025	.974	.303	.252	.357	.016
ETA=.871					ETA=.871				
X/C	MEAN	MAX	CP UPPER MIN	SIGMA	X/C	MEAN	MAX	CP LOWER MIN	SIGMA
.025	-.261	-.315	-.221	.012	.025	-.423	-.478	-.367	.013
.084	-.535	-.578	-.509	.008	.084	-.535	-.594	-.484	.015
.143	-.549	-.599	-.508	.012	.143	-.606	-.661	-.526	.014
.202	-.507	-.544	-.458	.013	.202	-.523	-.624	-.431	.032
.301	-.574	-.624	-.538	.011	.301	-.536	-.591	-.278	.020
.354	-.585	-.619	-.547	.011	.354	-.607	-.666	-.231	.052
.407	-.588	-.652	-.534	.015	.407	-.579	-.753	-.236	.142
.460	-.623	-.676	-.584	.011	.460	-.469	-.794	-.211	.131
.513	-.782	-.826	-.742	.010	.513	-.348	-.673	-.153	.084
.566	-.867	-.929	-.806	.013	.566	-.211	-.341	-.072	.035
.680	-.836	-.884	-.470	.026	.680	.054	.001	.104	.017
.742	-.417	-.768	-.165	.103	.742	.148	.084	.209	.016
.830	-.132	-.228	-.034	.031	.830	.335	.279	.380	.014
.910	-.006	-.122	.060	.029	.910	.397	.321	.442	.015
.990	.126	.034	.203	.024	.975	.255	.189	.303	.016
ETA=.972					ETA=.972				
X/C	MEAN	MAX	CP UPPER MIN	SIGMA	X/C	MEAN	MAX	CP LOWER MIN	SIGMA
.025	-.482	-.534	-.430	.014	.025	-.572	-.633	-.448	.017
.092	-.505	-.570	-.439	.017	.092	-.427	-.492	-.328	.017
.126	-.573	-.657	-.494	.036	.126	-.543	-.614	-.414	.022
.227	-.618	-.664	-.571	.010	.227	-.614	-.701	-.523	.029
.294	-.676	-.727	-.644	.011	.294	-.693	-.773	-.537	.027
.362	-.762	-.821	-.715	.011	.362	-.539	-.735	-.003	.168
.430	-.764	-.832	-.610	.021	.430	-.158	-.599	.018	.083
.497	-.658	-.781	-.108	.092	.497	-.146	-.303	-.015	.048
.565	-.192	-.650	.025	.108	.565	-.094	-.179	.004	.028
.632	-.095	-.237	.006	.032	.632	.032	-.033	.099	.019
.700	-.097	-.215	.004	.036	.700	.169	.126	.229	.014
.767	-.086	-.155	.005	.023	.767	.282	.237	.319	.014
.835	-.031	-.091	.042	.019	.835	.351	.299	.407	.016
.902	.001	-.054	.064	.018	.902	.374	.296	.405	.021
.990	.115	.054	.192	.017	.973	.255	.201	.306	.013

Table 11. Continued

(s) Tab point 98,  $M = 0.92$ ,  $q = 152.5$  psf,  $\alpha = 0^\circ$

ETA=.707					ETA=.707				
X/C	MEAN	MAX	MIN	SIGMA	X/C	MEAN	MAX	MIN	SIGMA
.025	-.361	-.400	-.331	.011					
.087	-.510	-.554	-.464	.009					
.148	-.579	-.627	-.538	.013					
.209	-.536	-.590	-.502	.009	.209	-.509	-.558	-.477	.012
.294	-.570	-.624	-.534	.010	.294	-.585	-.626	-.549	.010
.350	-.589	-.633	-.554	.010	.350	-.648	-.716	-.624	.010
.407	-.661	-.708	-.628	.009	.407	-.832	-.879	-.812	.007
.463	-.710	-.750	-.680	.010	.463	-.897	-.939	-.872	.009
.519	-.705	-.754	-.675	.012	.519	-.890	-.941	-.469	.032
.579	-.760	-.806	-.726	.011	.579	-.301	-.385	-.161	.030
.659	-.791	-.836	-.756	.009	.659	-.140	-.263	.006	.041
.739	-.754	-.925	-.387	.114	.739	.023	-.142	.137	.038
.819	-.264	-.338	-.199	.022	.819	.193	.043	.283	.031
.899	-.160	-.232	-.083	.020	.899	.350	.251	.418	.024
.990	.001	-.093	.088	.027	.974	.293	.210	.358	.021

ETA=.871					ETA=.871				
X/C	MEAN	MAX	MIN	SIGMA	X/C	MEAN	MAX	MIN	SIGMA
.025	-.247	-.294	-.214	.014	.025	-.404	-.452	-.357	.012
.084	-.517	-.561	-.494	.009	.084	-.523	-.565	-.482	.014
.143	-.544	-.593	-.493	.013	.143	-.605	-.653	-.582	.009
.202	-.525	-.587	-.480	.013	.202	-.606	-.653	-.559	.010
.301	-.605	-.657	-.523	.017	.301	-.622	-.696	-.550	.019
.354	-.564	-.636	-.519	.021	.354	-.630	-.692	-.567	.018
.407	-.575	-.622	-.519	.015	.407	-.686	-.731	-.650	.010
.460	-.591	-.634	-.567	.009	.460	-.777	-.839	-.726	.013
.513	-.755	-.802	-.721	.010	.513	-.819	-.873	-.736	.041
.566	-.856	-.924	-.826	.012	.566	-.296	-.661	-.093	.068
.680	-.827	-.881	-.789	.012	.680	-.013	-.177	.212	.050
.742	-.546	-.906	-.264	.137	.742	.098	-.051	.203	.039
.830	-.192	-.269	-.116	.022	.830	.330	.281	.380	.015
.910	-.093	-.201	.023	.037	.910	.390	.335	.441	.017
.990	.055	-.060	.162	.036	.975	.224	.150	.283	.022

ETA=.972					ETA=.972				
X/C	MEAN	MAX	MIN	SIGMA	X/C	MEAN	MAX	MIN	SIGMA
.025	-.453	-.508	-.406	.016	.025	-.545	-.567	-.495	.012
.092	-.496	-.553	-.437	.021	.092	-.415	-.512	-.375	.014
.126	-.601	-.649	-.536	.015	.126	-.540	-.584	-.493	.010
.227	-.635	-.712	-.543	.035	.227	-.662	-.704	-.623	.012
.294	-.644	-.706	-.613	.013	.294	-.774	-.830	-.716	.017
.362	-.727	-.774	-.694	.011	.362	-.751	-.830	-.643	.024
.430	-.764	-.830	-.717	.014	.430	-.750	-.864	-.112	.075
.497	-.772	-.839	-.701	.017	.497	-.186	-.655	.032	.118
.565	-.623	-.823	-.111	.148	.565	-.013	-.162	.086	.035
.632	-.146	-.443	.053	.067	.632	.068	-.021	.143	.020
.700	-.019	-.173	.074	.034	.700	.173	.111	.245	.017
.767	-.014	-.084	.072	.023	.767	.278	.219	.310	.016
.835	.020	-.053	.099	.021	.835	.351	.278	.395	.017
.902	.030	-.052	.107	.019	.902	.366	.276	.393	.020
.990	.113	.052	.175	.018	.973	.247	.196	.286	.059

Table 11. Continued

(t) Tab point 100,  $M = 0.94$ ,  $q = 157.0$  psf,  $\alpha = 0^\circ$

ETA=.707					ETA=.707				
X/C	MEAN	MAX	CP UPPER MIN	SIGMA	X/C	MEAN	MAX	CP LOWER MIN	SIGMA
.025	-.355	-.400	-.321	.011					
.087	-.504	-.549	-.483	.011					
.148	-.586	-.620	-.555	.010					
.209	-.532	-.573	-.498	.011	.209	-.469	-.509	-.419	.013
.294	-.577	-.618	-.552	.010	.294	-.560	-.609	-.533	.009
.350	-.590	-.626	-.560	.009	.350	-.635	-.696	-.584	.015
.407	-.649	-.699	-.621	.008	.407	-.791	-.832	-.767	.008
.463	-.704	-.740	-.672	.010	.463	-.858	-.902	-.825	.007
.519	-.704	-.744	-.667	.010	.519	-.867	-.903	-.827	.009
.579	-.760	-.805	-.728	.008	.579	-.534	-.913	-.312	.110
.659	-.781	-.812	-.757	.009	.659	-.337	-.414	-.267	.019
.739	-.780	-.910	-.476	.083	.739	-.311	-.375	-.240	.020
.819	-.300	-.373	-.227	.019	.819	-.235	-.348	-.048	.042
.899	-.223	-.293	-.159	.023	.899	.002	-.191	.211	.064
.990	-.049	-.145	.020	.025	.974	.202	.049	.348	.047
ETA=.871					ETA=.871				
X/C	MEAN	MAX	CP UPPER MIN	SIGMA	X/C	MEAN	MAX	CP LOWER MIN	SIGMA
.025	-.261	-.308	-.219	.009	.025	-.331	-.381	-.289	.015
.084	-.522	-.556	-.491	.008	.084	-.475	-.514	-.445	.009
.143	-.558	-.608	-.522	.012	.143	-.555	-.600	-.531	.010
.202	-.554	-.593	-.513	.011	.202	-.567	-.612	-.543	.009
.301	-.609	-.669	-.588	.010	.301	-.588	-.652	-.546	.014
.354	-.624	-.675	-.584	.013	.354	-.610	-.661	-.573	.012
.407	-.614	-.682	-.571	.014	.407	-.661	-.699	-.631	.007
.460	-.603	-.659	-.562	.015	.460	-.765	-.804	-.738	.008
.513	-.730	-.779	-.700	.010	.513	-.811	-.848	-.784	.009
.566	-.863	-.908	-.834	.008	.566	-.920	-.962	-.885	.010
.680	-.818	-.856	-.789	.011	.680	-.360	-.443	-.248	.039
.742	-.711	-.903	-.401	.105	.742	-.268	-.390	-.120	.049
.830	-.224	-.296	-.158	.019	.830	.141	-.067	.327	.061
.910	-.129	-.206	-.058	.023	.910	.394	.326	.463	.019
.990	-.005	-.093	.066	.025	.975	.212	.167	.254	.016
ETA=.972					ETA=.972				
X/C	MEAN	MAX	CP UPPER MIN	SIGMA	X/C	MEAN	MAX	CP LOWER MIN	SIGMA
.025	-.466	-.515	-.417	.016	.025	-.485	-.539	-.434	.014
.092	-.521	-.571	-.459	.014	.092	-.371	-.409	-.343	.011
.126	-.608	-.653	-.565	.013	.126	-.506	-.535	-.468	.010
.227	-.681	-.735	-.637	.013	.227	-.622	-.661	-.594	.009
.294	-.677	-.742	-.607	.020	.294	-.743	-.796	-.707	.011
.362	-.710	-.752	-.675	.009	.362	-.734	-.772	-.693	.012
.430	-.768	-.818	-.730	.010	.430	-.795	-.839	-.759	.011
.497	-.798	-.859	-.726	.015	.497	-.793	-.851	-.489	.034
.565	-.748	-.822	-.558	.021	.565	-.253	-.376	-.135	.033
.632	-.422	-.729	-.121	.118	.632	-.141	-.282	.037	.046
.700	-.055	-.226	.061	.042	.700	.008	-.142	.184	.053
.767	.017	-.082	.080	.024	.767	.136	-.020	.268	.048
.835	.058	-.018	.131	.019	.835	.221	.055	.350	.048
.902	.050	-.029	.115	.023	.902	.265	.109	.370	.034
.990	.118	-.026	.192	.028	.973	.213	.113	.289	.025

Table 11. Continued

(u) Tab point 101,  $M = 0.96$ ,  $q = 161.7$  psf,  $\alpha = 0^\circ$

ETA=.707					ETA=.707				
X/C	MEAN	MAX	CP UPPER MIN	SIGMA	X/C	MEAN	MAX	CP LOWER MIN	SIGMA
.025	-.348	-.377	-.181	.011					
.087	-.478	-.522	-.458	.007					
.148	-.568	-.602	-.539	.009					
.209	-.547	-.577	-.515	.007	.209	-.407	-.439	-.374	.009
.294	-.570	-.599	-.546	.009	.294	-.520	-.559	-.497	.007
.350	-.583	-.608	-.554	.006	.350	-.608	-.654	-.577	.008
.407	-.635	-.679	-.614	.007	.407	-.734	-.776	-.712	.007
.463	-.683	-.718	-.653	.010	.463	-.805	-.843	-.780	.007
.519	-.687	-.722	-.647	.009	.519	-.816	-.845	-.792	.007
.579	-.741	-.782	-.717	.007	.579	-.917	-.957	-.897	.006
.659	-.770	-.810	-.745	.008	.659	-.921	-.952	-.743	.021
.739	-.866	-.905	-.840	.007	.739	-.455	-.507	-.419	.012
.819	-.373	-.460	-.275	.023	.819	-.405	-.456	-.370	.012
.899	-.297	-.371	-.230	.021	.899	-.292	-.354	-.206	.018
.990	-.189	-.279	-.119	.021	.974	-.093	-.157	.015	.025

ETA=.871					ETA=.871				
X/C	MEAN	MAX	CP UPPER MIN	SIGMA	X/C	MEAN	MAX	CP LOWER MIN	SIGMA
.025	-.276	-.321	-.245	.011	.025	-.247	-.291	-.202	.010
.084	-.519	-.561	-.497	.007	.084	-.405	-.443	-.043	.011
.143	-.565	-.611	-.538	.008	.143	-.484	-.526	-.459	.006
.202	-.556	-.598	-.531	.009	.202	-.513	-.549	-.461	.008
.301	-.601	-.639	-.581	.009	.301	-.513	-.553	-.484	.010
.354	-.628	-.655	-.600	.008	.354	-.554	-.599	-.524	.009
.407	-.625	-.672	-.597	.009	.407	-.613	-.646	-.591	.007
.460	-.635	-.671	-.598	.010	.460	-.715	-.749	-.685	.007
.513	-.719	-.745	-.691	.008	.513	-.760	-.782	-.740	.004
.566	-.843	-.881	-.820	.007	.566	-.862	-.902	-.848	.008
.680	-.834	-.874	-.809	.008	.680	-.956	-.986	-.934	.006
.742	-.886	-.919	-.465	.025	.742	-.514	-.698	-.436	.041
.830	-.339	-.398	-.254	.018	.830	-.398	-.437	-.354	.012
.910	-.263	-.311	-.200	.016	.910	-.313	-.382	-.194	.027
.990	-.141	-.200	-.057	.021	.975	-.075	-.215	.100	.051

ETA=.972					ETA=.972				
X/C	MEAN	MAX	CP UPPER MIN	SIGMA	X/C	MEAN	MAX	CP LOWER MIN	SIGMA
.025	-.486	-.532	-.447	.012	.025	-.396	-.455	-.331	.018
.092	-.529	-.598	-.500	.009	.092	-.315	-.365	-.279	.009
.126	-.611	-.645	-.580	.009	.126	-.427	-.476	-.390	.012
.227	-.675	-.714	-.650	.008	.227	-.560	-.598	-.533	.008
.294	-.704	-.742	-.676	.009	.294	-.676	-.718	-.654	.010
.362	-.702	-.751	-.676	.010	.362	-.670	-.717	-.640	.009
.430	-.745	-.783	-.719	.009	.430	-.742	-.792	-.715	.009
.497	-.782	-.823	-.758	.008	.497	-.804	-.837	-.782	.005
.565	-.765	-.829	-.702	.020	.565	-.880	-.912	-.857	.009
.632	-.649	-.785	-.407	.063	.632	-.491	-.914	-.351	.096
.700	-.210	-.575	-.052	.060	.700	-.348	-.443	-.243	.028
.767	-.158	-.247	-.027	.028	.767	-.265	-.364	-.170	.030
.835	-.114	-.195	-.039	.023	.835	-.181	-.288	-.035	.036
.902	-.091	-.189	.004	.030	.902	-.089	-.191	.051	.034
.990	-.012	-.204	.113	.041	.973	.022	-.124	.206	.040

Table 11. Continued

(v) Tab point 239,  $M = 0.80$ ,  $q = 122.6$  psf,  $\alpha = 1^\circ$ 

ETA=.707					ETA=.707				
X/C	MEAN	MAX	MIN	SIGMA	X/C	MEAN	MAX	MIN	SIGMA
.025	-.885	-.942	-.813	.018					
.087	-.807	-.877	-.694	.018					
.148	-.855	-.907	-.644	.024					
.209	-.613	-.724	-.464	.051	.209	-.222	-.286	-.142	.020
.294	-.646	-.805	-.397	.070	.294	-.275	-.346	-.209	.020
.350	-.598	-.729	-.403	.058	.350	-.282	-.336	-.221	.019
.407	-.688	-.817	-.460	.058	.407	-.362	-.436	-.282	.025
.463	-.676	-.844	-.440	.078	.463	-.337	-.404	-.264	.020
.519	-.601	-.836	-.373	.103	.519	-.222	-.278	-.152	.019
.579	-.546	-.852	-.327	.082	.579	-.146	-.203	-.083	.017
.659	-.426	-.602	-.289	.046	.659	.036	-.014	.102	.015
.739	-.387	-.506	-.278	.036	.739	.194	.142	.243	.016
.819	-.269	-.363	-.205	.022	.819	.332	.293	.378	.012
.899	-.100	-.177	-.048	.017	.899	.430	.357	.468	.011
.990	.089	.030	.142	.016	.974	.341	.292	.377	.011
ETA=.871					ETA=.871				
X/C	MEAN	MAX	MIN	SIGMA	X/C	MEAN	MAX	MIN	SIGMA
.025	-.783	-.834	-.748	.013	.025	-.006	-.074	.045	.018
.084	-.925	-.984	-.886	.012	.084	-.190	-.256	-.139	.014
.143	-.760	-.846	-.625	.029	.143	-.214	-.269	-.166	.012
.202	-.603	-.686	-.524	.030	.202	-.281	-.354	-.237	.013
.301	-.550	-.793	-.368	.082	.301	-.275	-.348	-.197	.019
.354	-.537	-.725	-.332	.075	.354	-.276	-.359	-.203	.023
.407	-.530	-.677	-.335	.058	.407	-.268	-.340	-.209	.019
.460	-.535	-.690	-.357	.058	.460	-.308	-.377	-.236	.019
.513	-.527	-.735	-.098	.070	.513	-.255	-.317	-.167	.021
.566	-.523	-.738	-.332	.055	.566	-.179	-.229	-.116	.022
.680	-.377	-.508	-.279	.028	.680	.024	-.009	.074	.014
.742	-.311	-.380	-.237	.022	.742	.127	.072	.162	.014
.830	-.175	-.255	-.123	.011	.830	.324	.267	.362	.012
.910	-.107	-.168	-.065	.014	.910	.351	.297	.385	.021
.990	.108	.050	.152	.011	.975	.231	.171	.268	.013
ETA=.972					ETA=.972				
X/C	MEAN	MAX	MIN	SIGMA	X/C	MEAN	MAX	MIN	SIGMA
.025	-1.063	-1.127	-1.001	.017	.025	-.162	-.248	-.084	.024
.092	-.829	-1.022	-.620	.081	.092	-.157	-.231	-.089	.027
.126	-.699	-.799	-.503	.063	.126	-.203	-.290	-.120	.020
.227	-.460	-.643	-.322	.045	.227	-.313	-.362	-.262	.014
.294	-.391	-.488	-.300	.033	.294	-.279	-.338	-.225	.019
.362	-.383	-.475	-.292	.036	.362	-.220	-.273	-.157	.023
.430	-.353	-.457	-.245	.028	.430	-.259	-.329	-.183	.023
.497	-.272	-.354	-.240	.017	.497	-.197	-.265	-.134	.020
.565	-.279	-.380	-.197	.025	.565	-.138	-.208	-.060	.023
.632	-.274	-.360	-.198	.024	.632	-.050	-.111	.006	.017
.700	-.227	-.286	-.140	.020	.700	.099	.038	.149	.015
.767	-.195	-.241	-.116	.018	.767	.223	.178	.263	.013
.835	-.132	-.190	-.087	.019	.835	.281	.220	.336	.016
.902	-.082	-.140	-.027	.017	.902	.283	.227	.328	.011
.990	.056	-.008	.118	.016	.973	.188	.126	.224	.015

Table 11. Continued

(w) Tab point 243,  $M = 0.85$ ,  $q = 134.6$  psf,  $\alpha = 1^\circ$ 

ETA=.707					ETA=.707				
X/C	MEAN	MAX	MIN	SIGMA	X/C	MEAN	MAX	MIN	SIGMA
.025	-.644	-.701	-.583	.018					
.087	-.716	-.759	-.683	.012					
.148	-.813	-.851	-.763	.011					
.209	-.734	-.796	-.672	.014	.209	-.289	-.378	-.155	.026
.294	-.725	-.797	-.656	.019	.294	-.341	-.427	-.215	.031
.350	-.688	-.728	-.625	.013	.350	-.339	-.437	-.227	.031
.407	-.823	-.873	-.782	.012	.407	-.420	-.563	-.270	.037
.463	-.838	-.886	-.768	.015	.463	-.377	-.482	-.240	.029
.519	-.816	-.876	-.761	.018	.519	-.244	-.329	-.151	.028
.579	-.882	-.943	-.801	.016	.579	-.139	-.209	-.064	.021
.659	-.863	-.923	-.600	.030	.659	.051	.001	.106	.018
.739	-.346	-.772	-.202	.061	.739	.228	.168	.274	.015
.819	-.186	-.304	-.108	.028	.819	.346	.279	.396	.015
.899	-.046	-.109	.021	.018	.899	.446	.388	.489	.014
.990	.125	.053	.168	.012	.974	.375	.330	.433	.014
ETA=.871					ETA=.871				
X/C	MEAN	MAX	MIN	SIGMA	X/C	MEAN	MAX	MIN	SIGMA
.025	-.589	-.642	-.551	.012	.025	-.101	-.161	-.054	.019
.084	-.860	-.896	-.807	.012	.084	-.282	-.367	-.233	.016
.143	-.819	-.858	-.770	.010	.143	-.296	-.366	-.245	.016
.202	-.778	-.812	-.732	.011	.202	-.353	-.429	-.296	.016
.301	-.769	-.839	-.675	.017	.301	-.334	-.441	-.207	.029
.354	-.764	-.845	-.686	.024	.354	-.328	-.430	-.211	.029
.407	-.738	-.797	-.680	.014	.407	-.314	-.415	-.204	.030
.460	-.791	-.842	-.716	.016	.460	-.357	-.471	-.240	.033
.513	-.844	-.906	-.774	.019	.513	-.283	-.376	-.190	.027
.566	-.933	-1.017	-.302	.080	.566	-.191	-.273	-.105	.027
.680	-.255	-.449	-.137	.043	.680	.040	-.008	.093	.015
.742	-.223	-.372	-.112	.037	.742	.144	.079	.188	.016
.830	-.144	-.232	-.059	.020	.830	.342	.292	.379	.012
.910	-.102	-.166	-.006	.017	.910	.360	.310	.403	.012
.990	.163	.099	.205	.015	.975	.268	.218	.307	.011
ETA=.972					ETA=.972				
X/C	MEAN	MAX	MIN	SIGMA	X/C	MEAN	MAX	MIN	SIGMA
.025	-.870	-.924	-.822	.013	.025	-.262	-.362	-.172	.027
.092	-.892	-.957	-.813	.017	.092	-.243	-.365	-.145	.025
.126	-.873	-.907	-.830	.013	.126	-.288	-.380	-.187	.027
.227	-.920	-.980	-.828	.016	.227	-.425	-.500	-.369	.020
.294	-.827	-.929	-.208	.058	.294	-.350	-.502	-.256	.033
.362	-.261	-.767	-.098	.078	.362	-.250	-.367	-.143	.037
.430	-.258	-.377	-.133	.039	.430	-.279	-.380	-.114	.032
.497	-.229	-.335	-.153	.022	.497	-.209	-.294	-.122	.026
.565	-.259	-.371	-.115	.037	.565	-.138	-.203	-.068	.025
.632	-.268	-.381	-.167	.029	.632	-.044	-.114	.032	.019
.700	-.221	-.314	-.114	.028	.700	.112	.059	.161	.015
.767	-.190	-.257	-.106	.019	.767	.232	.175	.278	.012
.835	-.127	-.212	-.053	.021	.835	.275	.214	.319	.012
.902	-.082	-.141	.001	.018	.902	.284	.246	.338	.016
.990	.066	-.007	.145	.018	.973	.193	.140	.243	.015



Table 11. Continued

(x) Tab point 247,  $M = 0.88$ ,  $q = 142.2$  psf,  $\alpha = 1^\circ$

ETA=.707					ETA=.707				
X/C	MEAN	MAX	CP UPPER MIN	SIGMA	X/C	MEAN	MAX	CP LOWER MIN	SIGMA
.025	-.500	-.564	-.452	.014					
.087	-.643	-.695	-.622	.008					
.148	-.730	-.770	-.698	.009					
.209	-.653	-.707	-.624	.011	.209	-.348	-.432	-.246	.025
.294	-.698	-.742	-.657	.014	.294	-.406	-.570	-.263	.057
.350	-.666	-.714	-.616	.011	.350	-.401	-.512	-.265	.039
.407	-.790	-.839	-.753	.010	.407	-.516	-.665	-.339	.065
.463	-.810	-.864	-.764	.011	.463	-.429	-.661	-.251	.054
.519	-.808	-.865	-.756	.013	.519	-.282	-.396	-.167	.034
.579	-.860	-.917	-.831	.011	.579	-.162	-.255	-.083	.024
.659	-.880	-.923	-.849	.011	.659	.033	-.024	.088	.018
.739	-.522	-.939	-.313	.127	.739	.210	.147	.259	.017
.819	-.298	-.387	-.152	.029	.819	.324	.264	.362	.015
.899	-.142	-.263	-.017	.035	.899	.422	.355	.463	.016
.990	.048	-.071	.134	.032	.974	.336	.276	.410	.019
ETA=.871					ETA=.871				
X/C	MEAN	MAX	CP UPPER MIN	SIGMA	X/C	MEAN	MAX	CP LOWER MIN	SIGMA
.025	-.463	-.509	-.424	.012	.025	-.206	-.280	-.140	.022
.084	-.722	-.752	-.680	.009	.084	-.366	-.423	-.309	.018
.143	-.730	-.777	-.705	.010	.143	-.403	-.448	-.334	.019
.202	-.696	-.743	-.667	.009	.202	-.436	-.506	-.368	.020
.301	-.712	-.772	-.683	.012	.301	-.437	-.547	-.274	.051
.354	-.753	-.800	-.712	.012	.354	-.382	-.530	-.236	.039
.407	-.732	-.779	-.681	.012	.407	-.385	-.506	-.243	.039
.460	-.749	-.797	-.701	.014	.460	-.442	-.604	-.227	.057
.513	-.826	-.870	-.783	.012	.513	-.331	-.497	-.179	.044
.566	-.941	-.985	-.892	.011	.566	-.215	-.307	-.124	.028
.680	-.751	-.954	-.228	.157	.680	.030	-.020	.076	.016
.742	-.334	-.598	-.131	.051	.742	.138	.075	.191	.016
.830	-.138	-.245	-.043	.028	.830	.333	.277	.370	.013
.910	-.030	-.132	.032	.025	.910	.350	.319	.394	.012
.990	.150	.056	.219	.019	.975	.261	.219	.302	.013
ETA=.972					ETA=.972				
X/C	MEAN	MAX	CP UPPER MIN	SIGMA	X/C	MEAN	MAX	CP LOWER MIN	SIGMA
.025	-.726	-.790	-.681	.015	.025	-.363	-.458	-.252	.033
.092	-.740	-.819	-.695	.018	.092	-.320	-.418	-.223	.027
.126	-.788	-.822	-.761	.010	.126	-.400	-.470	-.274	.030
.227	-.858	-.904	-.819	.011	.227	-.520	-.609	-.448	.021
.294	-.860	-.929	-.805	.014	.294	-.595	-.732	-.389	.054
.362	-.828	-.897	-.726	.024	.362	-.283	-.610	-.085	.088
.430	-.695	-.831	-.162	.132	.430	-.276	-.447	-.082	.051
.497	-.236	-.624	-.096	.076	.497	-.215	-.315	-.116	.033
.565	-.169	-.327	-.036	.042	.565	-.136	-.204	-.052	.025
.632	-.204	-.336	-.108	.032	.632	-.039	-.108	.030	.020
.700	-.180	-.285	-.044	.032	.700	.118	.068	.176	.015
.767	-.164	-.243	-.053	.025	.767	.237	.190	.287	.015
.835	-.102	-.163	-.050	.021	.835	.270	.215	.327	.014
.902	-.074	-.145	.001	.019	.902	.283	.220	.333	.016
.990	.072	.005	.173	.020	.973	.206	.145	.254	.017

Table 11. Continued

(y) Tab point 250,  $M = 0.90$ ,  $q = 147.4$  psf,  $\alpha = 1^\circ$

ETA=.707					ETA=.707				
X/C	MEAN	MAX	MIN	SIGMA	X/C	MEAN	MAX	MIN	SIGMA
.025	-.421	-.472	-.389	.012					
.087	-.586	-.623	-.565	.010					
.148	-.672	-.708	-.639	.009					
.209	-.612	-.648	-.579	.011	.209	-.451	-.489	-.381	.013
.294	-.659	-.704	-.622	.013	.294	-.557	-.607	-.481	.016
.350	-.639	-.689	-.606	.010	.350	-.597	-.661	-.291	.052
.407	-.763	-.809	-.726	.010	.407	-.606	-.793	-.246	.111
.463	-.785	-.833	-.749	.010	.463	-.483	-.836	-.231	.116
.519	-.787	-.834	-.753	.011	.519	-.302	-.591	-.138	.061
.579	-.834	-.885	-.802	.010	.579	-.177	-.279	-.069	.029
.659	-.850	-.890	-.808	.011	.659	.017	-.048	.085	.018
.739	-.754	-.942	-.362	.138	.739	.193	.130	.250	.019
.819	-.309	-.397	-.218	.024	.819	.305	.243	.361	.017
.899	-.195	-.290	-.076	.034	.899	.411	.343	.470	.017
.990	-.035	-.174	.083	.036	.974	.314	.242	.396	.021
ETA=.871					ETA=.871				
X/C	MEAN	MAX	MIN	SIGMA	X/C	MEAN	MAX	MIN	SIGMA
.025	-.374	-.421	-.338	.012	.025	-.284	-.344	-.209	.022
.084	-.642	-.679	-.621	.009	.084	-.449	-.506	-.396	.014
.143	-.662	-.715	-.634	.011	.143	-.456	-.518	-.408	.021
.202	-.637	-.680	-.607	.012	.202	-.509	-.561	-.428	.018
.301	-.661	-.702	-.627	.012	.301	-.535	-.591	-.277	.040
.354	-.713	-.760	-.675	.014	.354	-.515	-.688	-.263	.104
.407	-.699	-.751	-.657	.012	.407	-.445	-.681	-.234	.085
.460	-.739	-.792	-.688	.015	.460	-.532	-.759	-.266	.078
.513	-.799	-.851	-.767	.012	.513	-.420	-.729	-.150	.096
.566	-.914	-.962	-.872	.014	.566	-.233	-.378	-.073	.037
.680	-.888	-.932	-.374	.033	.680	.016	-.042	.085	.019
.742	-.433	-.838	-.257	.087	.742	.129	.059	.184	.018
.830	-.217	-.310	-.090	.031	.830	.322	.267	.369	.015
.910	-.111	-.225	.019	.039	.910	.339	.271	.393	.014
.990	.085	-.019	.175	.031	.975	.233	.165	.291	.019
ETA=.972					ETA=.972				
X/C	MEAN	MAX	MIN	SIGMA	X/C	MEAN	MAX	MIN	SIGMA
.025	-.625	-.680	-.564	.019	.025	-.441	-.541	-.281	.035
.092	-.657	-.718	-.611	.016	.092	-.380	-.474	-.239	.027
.126	-.727	-.758	-.699	.012	.126	-.458	-.559	-.335	.035
.227	-.798	-.849	-.756	.012	.227	-.593	-.671	-.504	.018
.294	-.818	-.872	-.777	.014	.294	-.699	-.754	-.529	.026
.362	-.830	-.865	-.794	.013	.362	-.601	-.769	-.131	.112
.430	-.805	-.861	-.673	.018	.430	-.297	-.784	-.067	.139
.497	-.719	-.839	-.223	.073	.497	-.153	-.340	-.015	.047
.565	-.267	-.806	-.023	.136	.565	-.110	-.197	.011	.031
.632	-.111	-.226	-.006	.032	.632	-.028	-.092	.053	.021
.700	-.101	-.201	.006	.033	.700	.126	.077	.193	.015
.767	-.114	-.189	-.016	.025	.767	.245	.183	.301	.015
.835	-.064	-.121	.025	.019	.835	.272	.207	.340	.016
.902	-.051	-.105	.025	.019	.902	.286	.225	.345	.015
.990	.087	.017	.167	.021	.973	.218	.175	.292	.015

Table 11. Continued

(z) Tab point 253,  $M = 0.92$ ,  $q = 153.1$  psf,  $\alpha = 1^\circ$ 

ETA=.707					ETA=.707				
X/C	MEAN	MAX	MIN	SIGMA	X/C	MEAN	MAX	MIN	SIGMA
.025	-.383	-.443	-.340	.015					
.087	-.549	-.601	-.511	.009					
.148	-.642	-.693	-.615	.007					
.209	-.603	-.657	-.558	.015	.209	-.449	-.506	-.425	.008
.294	-.647	-.690	-.611	.012	.294	-.585	-.640	-.552	.009
.350	-.614	-.663	-.572	.009	.350	-.623	-.672	-.591	.011
.407	-.756	-.803	-.723	.010	.407	-.776	-.820	-.752	.009
.463	-.770	-.814	-.745	.012	.463	-.839	-.883	-.805	.011
.519	-.777	-.826	-.736	.011	.519	-.742	-.883	-.211	.111
.579	-.803	-.852	-.773	.010	.579	-.214	-.322	-.088	.028
.659	-.839	-.892	-.801	.011	.659	-.157	-.267	-.011	.037
.739	-.779	-.930	-.337	.112	.739	-.032	-.199	.137	.049
.819	-.334	-.428	-.175	.030	.819	.118	-.085	.268	.054
.899	-.215	-.314	-.096	.034	.899	.309	.163	.430	.043
.990	-.061	-.178	.046	.036	.974	.289	.199	.381	.028
ETA=.871					ETA=.871				
X/C	MEAN	MAX	MIN	SIGMA	X/C	MEAN	MAX	MIN	SIGMA
.025	-.341	-.394	-.280	.012	.025	-.296	-.355	-.225	.014
.084	-.611	-.654	-.587	.008	.084	-.474	-.511	-.429	.012
.143	-.634	-.689	-.589	.013	.143	-.523	-.570	-.464	.013
.202	-.617	-.667	-.573	.012	.202	-.522	-.564	-.494	.015
.301	-.648	-.707	-.604	.014	.301	-.541	-.593	-.509	.012
.354	-.705	-.767	-.650	.013	.354	-.651	-.697	-.617	.011
.407	-.686	-.735	-.633	.012	.407	-.655	-.702	-.609	.011
.460	-.737	-.796	-.685	.013	.460	-.788	-.844	-.742	.012
.513	-.807	-.855	-.750	.013	.513	-.819	-.877	-.604	.019
.566	-.916	-.970	-.873	.011	.566	-.342	-.896	-.149	.090
.680	-.890	-.967	-.841	.014	.680	-.074	-.284	.037	.047
.742	-.623	-.944	-.350	.127	.742	.054	-.159	.154	.041
.830	-.284	-.345	-.204	.021	.830	.303	.126	.355	.021
.910	-.200	-.299	-.064	.034	.910	.325	.238	.378	.016
.990	.034	-.134	.145	.037	.975	.209	.115	.270	.021
.025	-.575	-.655	-.510	.020	.025	-.461	-.557	-.366	.031
ETA=.972					ETA=.972				
X/C	MEAN	MAX	MIN	SIGMA	X/C	MEAN	MAX	MIN	SIGMA
.092	-.624	-.727	-.554	.018	.092	-.403	-.457	-.343	.017
.126	-.691	-.752	-.640	.014	.126	-.506	-.572	-.436	.023
.227	-.770	-.818	-.717	.013	.227	-.621	-.693	-.589	.011
.294	-.807	-.875	-.737	.015	.294	-.733	-.794	-.669	.016
.362	-.826	-.890	-.765	.014	.362	-.711	-.753	-.660	.013
.430	-.829	-.897	-.784	.013	.430	-.797	-.849	-.650	.018
.497	-.807	-.877	-.729	.014	.497	-.190	-.432	-.038	.039
.565	-.741	-.878	-.225	.116	.565	-.082	-.202	.034	.036
.632	-.220	-.747	-.006	.070	.632	-.061	-.205	.040	.043
.700	-.051	-.229	.065	.041	.700	.056	-.126	.175	.048
.767	-.038	-.138	.018	.022	.767	.138	-.051	.267	.049
.835	.004	-.058	.071	.020	.835	.157	-.091	.304	.058
.902	.001	-.067	.069	.022	.902	.192	-.016	.298	.046
.990	.113	.016	.172	.020	.973	.200	.045	.315	.027

Table 11. Continued

(aa) Tab point 256,  $M = 0.94$ ,  $q = 158.2$  psf,  $\alpha = 1^\circ$

ETA=.707					ETA=.707				
X/C	MEAN	MAX	MIN	SIGMA	X/C	MEAN	MAX	MIN	SIGMA
.025	-.394	-.440	-.340	.011					
.087	-.559	-.603	-.516	.014					
.148	-.623	-.660	-.595	.006					
.209	-.617	-.646	-.593	.008	.209	-.406	-.445	-.378	.008
.294	-.645	-.689	-.602	.010	.294	-.546	-.587	-.523	.007
.350	-.614	-.652	-.587	.009	.350	-.590	-.627	-.561	.010
.407	-.742	-.787	-.721	.007	.407	-.726	-.771	-.695	.010
.463	-.764	-.810	-.743	.008	.463	-.798	-.844	-.779	.009
.519	-.783	-.832	-.745	.010	.519	-.826	-.865	-.800	.008
.579	-.794	-.835	-.769	.008	.579	-.666	-.929	-.301	.149
.659	-.839	-.885	-.807	.009	.659	-.347	-.415	-.280	.019
.739	-.765	-.899	-.348	.100	.739	-.305	-.361	-.238	.018
.819	-.332	-.448	-.181	.038	.819	-.278	-.347	-.204	.020
.899	-.213	-.314	-.126	.031	.899	-.150	-.230	-.057	.028
.990	-.135	-.270	-.053	.030	.974	.012	-.082	.160	.034

ETA=.871					ETA=.871				
X/C	MEAN	MAX	MIN	SIGMA	X/C	MEAN	MAX	MIN	SIGMA
.025	-.357	-.381	-.326	.009	.025	-.212	-.263	-.172	.010
.084	-.631	-.665	-.611	.008	.084	-.417	-.460	-.380	.008
.143	-.638	-.666	-.613	.009	.143	-.462	-.495	-.426	.009
.202	-.621	-.657	-.588	.007	.202	-.512	-.546	-.489	.012
.301	-.666	-.704	-.634	.011	.301	-.515	-.551	-.492	.010
.354	-.712	-.742	-.685	.011	.354	-.612	-.652	-.597	.007
.407	-.688	-.722	-.667	.010	.407	-.619	-.657	-.601	.007
.460	-.742	-.781	-.716	.008	.460	-.753	-.783	-.729	.008
.513	-.806	-.838	-.782	.010	.513	-.798	-.827	-.775	.007
.566	-.916	-.949	-.886	.008	.566	-.885	-.921	-.860	.009
.680	-.906	-.935	-.880	.008	.680	-.376	-.447	-.286	.024
.742	-.724	-.958	-.449	.108	.742	-.326	-.399	-.247	.025
.830	-.351	-.402	-.289	.017	.830	-.226	-.353	-.079	.041
.910	-.272	-.345	-.187	.026	.910	-.024	-.212	.196	.059
.990	-.019	-.175	.073	.034	.975	.132	-.018	.239	.038

ETA=.972					ETA=.972				
X/C	MEAN	MAX	MIN	SIGMA	X/C	MEAN	MAX	MIN	SIGMA
.025	-.589	-.645	-.547	.012	.025	-.357	-.400	-.308	.013
.092	-.659	-.714	-.614	.013	.092	-.340	-.398	-.299	.013
.126	-.691	-.739	-.662	.010	.126	-.430	-.466	-.389	.011
.227	-.765	-.812	-.737	.010	.227	-.571	-.614	-.548	.009
.294	-.820	-.880	-.790	.010	.294	-.703	-.746	-.658	.012
.362	-.840	-.894	-.806	.012	.362	-.680	-.717	-.661	.009
.430	-.833	-.879	-.791	.008	.430	-.782	-.832	-.742	.009
.497	-.824	-.871	-.782	.011	.497	-.379	-.810	-.149	.127
.565	-.799	-.904	-.436	.084	.565	-.208	-.309	-.104	.029
.632	-.343	-.711	-.199	.073	.632	-.249	-.345	-.131	.031
.700	-.196	-.313	-.085	.034	.700	-.194	-.294	-.078	.030
.767	-.132	-.272	-.015	.033	.767	-.147	-.236	-.049	.026
.835	-.064	-.169	.034	.029	.835	-.152	-.279	.070	.040
.902	-.057	-.153	.067	.031	.902	-.115	-.241	.018	.035
.990	-.025	-.265	.123	.051	.973	-.026	-.163	.152	.048

Table 11. Continued

(bb) Tab point 259,  $M = 0.96$ ,  $q = 162.9$  psf,  $\alpha = 1^\circ$

ETA=.707					ETA=.707				
X/C	MEAN	MAX	MIN	SIGMA	X/C	MEAN	MAX	MIN	SIGMA
.025	-.377	-.417	-.341	.010					
.087	-.560	-.607	-.522	.011					
.148	-.597	-.630	-.578	.008					
.209	-.586	-.628	-.566	.008	.209	-.374	-.410	-.356	.010
.294	-.628	-.669	-.606	.008	.294	-.511	-.550	-.488	.006
.350	-.595	-.623	-.570	.008	.350	-.557	-.588	-.534	.006
.407	-.717	-.765	-.701	.007	.407	-.676	-.718	-.655	.006
.463	-.734	-.776	-.700	.009	.463	-.751	-.788	-.736	.007
.519	-.758	-.798	-.724	.009	.519	-.782	-.809	-.767	.007
.579	-.769	-.812	-.748	.007	.579	-.882	-.913	-.863	.007
.659	-.811	-.838	-.795	.010	.659	-.930	-.960	-.851	.008
.739	-.865	-.906	-.810	.010	.739	-.472	-.536	-.416	.015
.819	-.469	-.673	-.338	.053	.819	-.394	-.434	-.359	.013
.899	-.317	-.413	-.219	.028	.899	-.270	-.328	-.223	.014
.990	-.241	-.347	-.168	.023	.974	-.105	-.176	-.015	.025

ETA=.871					ETA=.871				
X/C	MEAN	MAX	MIN	SIGMA	X/C	MEAN	MAX	MIN	SIGMA
.025	-.349	-.391	-.327	.007	.025	-.159	-.189	-.122	.008
.084	-.620	-.657	-.594	.007	.084	-.373	-.414	-.347	.007
.143	-.619	-.647	-.595	.007	.143	-.396	-.447	-.380	.011
.202	-.604	-.649	-.583	.005	.202	-.471	-.508	-.442	.006
.301	-.656	-.684	-.636	.006	.301	-.482	-.524	-.455	.006
.354	-.687	-.721	-.666	.011	.354	-.576	-.602	-.548	.009
.407	-.668	-.702	-.648	.009	.407	-.576	-.606	-.551	.008
.460	-.717	-.759	-.696	.007	.460	-.706	-.740	-.687	.008
.513	-.785	-.814	-.760	.008	.513	-.752	-.783	-.732	.004
.566	-.887	-.922	-.861	.007	.566	-.838	-.874	-.821	.007
.680	-.878	-.909	-.855	.007	.680	-.963	-.987	-.934	.006
.742	-.971	-1.006	-.952	.006	.742	-.927	-.965	-.738	.016
.830	-.465	-.512	-.402	.020	.830	-.416	-.476	-.374	.011
.910	-.420	-.468	-.347	.018	.910	-.392	-.448	-.360	.011
.990	-.231	-.301	-.170	.016	.975	-.263	-.298	-.205	.014

ETA=.972					ETA=.972				
X/C	MEAN	MAX	MIN	SIGMA	X/C	MEAN	MAX	MIN	SIGMA
.025	-.572	-.616	-.542	.010	.025	-.292	-.344	-.254	.013
.092	-.645	-.694	-.618	.008	.092	-.282	-.333	-.238	.011
.126	-.664	-.697	-.644	.008	.126	-.377	-.410	-.357	.007
.227	-.742	-.779	-.726	.008	.227	-.533	-.565	-.510	.006
.294	-.799	-.833	-.768	.008	.294	-.652	-.693	-.629	.008
.362	-.821	-.858	-.804	.008	.362	-.639	-.664	-.609	.007
.430	-.813	-.854	-.790	.007	.430	-.741	-.787	-.721	.007
.497	-.800	-.846	-.782	.009	.497	-.791	-.831	-.766	.008
.565	-.841	-.878	-.815	.007	.565	-.651	-.899	-.256	.136
.632	-.821	-.879	-.625	.029	.632	-.433	-.588	-.314	.040
.700	-.343	-.613	-.249	.044	.700	-.384	-.494	-.264	.036
.767	-.278	-.358	-.181	.026	.767	-.355	-.443	-.272	.027
.835	-.236	-.308	-.165	.020	.835	-.373	-.500	-.195	.040
.902	-.234	-.319	-.148	.024	.902	-.334	-.420	-.234	.028
.990	-.165	-.362	-.027	.047	.973	-.247	-.423	-.053	.054

Table 11. Continued

(cc) Tab point 105,  $M = 0.80$ ,  $q = 125.9$  psf,  $\alpha = 2^\circ$

ETA=.707					ETA=.707				
X/C	MEAN	MAX	CP UPPER MIN	SIGMA	X/C	MEAN	MAX	CP LOWER MIN	SIGMA
.025	-1.124	-1.171	-1.073	.014					
.087	-1.206	-1.273	-1.150	.014					
.148	-1.088	-1.152	-.989	.020					
.209	-.980	-1.062	-.648	.031	.209	-.130	-.185	-.059	.016
.294	-.626	-.811	-.318	.085	.294	-.194	-.264	-.131	.017
.350	-.619	-.809	-.367	.069	.350	-.195	-.280	-.126	.017
.407	-.656	-.872	-.399	.083	.407	-.316	-.384	-.261	.018
.463	-.673	-.853	-.375	.075	.463	-.302	-.362	-.239	.018
.519	-.644	-.886	-.367	.108	.519	-.188	-.241	-.118	.018
.579	-.521	-.894	-.328	.084	.579	-.131	-.182	-.078	.015
.659	-.420	-.556	-.293	.041	.659	.062	.007	.106	.014
.739	-.386	-.511	-.289	.032	.739	.213	.152	.251	.015
.819	-.252	-.353	-.171	.020	.819	.341	.273	.384	.012
.899	-.096	-.170	-.031	.015	.899	.426	.371	.453	.013
.990	.103	.038	.147	.015	.974	.322	.268	.351	.013

ETA=.871					ETA=.871				
X/C	MEAN	MAX	CP UPPER MIN	SIGMA	X/C	MEAN	MAX	CP LOWER MIN	SIGMA
.025	-.975	-1.022	-.939	.011	.025	.147	.087	.202	.014
.084	-1.251	-1.303	-1.222	.008	.084	-.070	-.141	-.012	.014
.143	-1.179	-1.243	-1.068	.019	.143	-.124	-.187	-.086	.013
.202	-1.041	-1.113	-.783	.026	.202	-.196	-.251	-.137	.015
.301	-.429	-.809	-.257	.069	.301	-.207	-.283	-.151	.020
.354	-.499	-.629	-.275	.061	.354	-.204	-.258	-.147	.018
.407	-.584	-.698	-.379	.058	.407	-.220	-.292	-.151	.018
.460	-.555	-.808	-.390	.081	.460	-.251	-.303	-.193	.020
.513	-.512	-.746	-.324	.065	.513	-.211	-.273	-.140	.021
.566	-.505	-.711	-.302	.049	.566	-.158	-.236	-.085	.019
.680	-.367	-.455	-.246	.028	.680	.043	-.013	.109	.017
.742	-.310	-.375	-.222	.024	.742	.128	.055	.187	.017
.830	-.178	-.254	-.126	.019	.830	.335	.288	.381	.014
.910	-.069	-.129	-.001	.014	.910	.373	.321	.406	.014
.990	.105	.040	.154	.017	.975	.212	.155	.236	.013

ETA=.972					ETA=.972				
X/C	MEAN	MAX	CP UPPER MIN	SIGMA	X/C	MEAN	MAX	CP LOWER MIN	SIGMA
.025	-1.211	-1.270	-1.161	.013	.025	.005	-.077	.083	.022
.092	-1.221	-1.314	-1.132	.023	.092	-.049	-.110	.028	.016
.126	-1.017	-1.144	-.444	.108	.126	-.115	-.184	-.046	.020
.227	-.336	-.495	-.222	.044	.227	-.240	-.307	-.181	.013
.294	-.330	-.434	-.224	.033	.294	-.232	-.314	-.175	.018
.362	-.345	-.442	-.263	.035	.362	-.179	-.257	-.102	.021
.430	-.335	-.415	-.250	.026	.430	-.224	-.292	-.150	.019
.497	-.266	-.349	-.224	.033	.497	-.186	-.258	-.117	.019
.565	-.272	-.354	-.203	.024	.565	-.120	-.197	-.053	.019
.632	-.268	-.336	-.208	.020	.632	-.024	-.110	.046	.017
.700	-.228	-.310	-.167	.020	.700	.106	.067	.161	.016
.767	-.190	-.223	-.129	.017	.767	.235	.182	.265	.011
.835	-.124	-.179	-.065	.016	.835	.317	.238	.365	.014
.902	-.079	-.132	-.022	.016	.902	.318	.264	.363	.013
.990	.050	-.018	.117	.017	.973	.187	.141	.237	.016

Table 11. Continued

(dd) Tab point 106,  $M = 0.85$ ,  $q = 137.9$  psf,  $\alpha = 2^\circ$

ETA=.707					ETA=.707				
X/C	MEAN	MAX	MIN	SIGMA	X/C	MEAN	MAX	MIN	SIGMA
.025	-.839	-.889	-.800	.015	.209	-.192	-.259	-.105	.021
.087	-.955	-1.012	-.912	.012	.294	-.248	-.327	-.156	.023
.148	-.914	-.952	-.890	.011	.350	-.277	-.358	-.192	.023
.209	-.901	-.944	-.871	.007	.407	-.342	-.425	-.238	.026
.294	-.903	-.953	-.865	.011	.463	-.329	-.404	-.243	.024
.350	-.865	-.901	-.826	.010	.519	-.209	-.282	-.133	.021
.407	-.926	-.986	-.885	.011	.579	-.132	-.189	-.059	.018
.463	-.971	-1.021	-.944	.011	.659	.068	.019	.122	.015
.519	-.977	-1.033	-.933	.012	.739	.223	.164	.254	.012
.579	-.986	-1.042	-.941	.011	.819	.345	.287	.389	.013
.659	-.982	-1.038	-.810	.020	.899	.432	.388	.475	.011
.739	-.307	-.618	-.150	.062	.974	.347	.295	.383	.019
.819	-.133	-.233	-.067	.021					
.899	-.031	-.104	.023	.018					
.990	.136	.072	.184	.013					

ETA=.871					ETA=.871				
X/C	MEAN	MAX	MIN	SIGMA	X/C	MEAN	MAX	MIN	SIGMA
.025	-.726	-.781	-.692	.008	.025	.045	-.013	.092	.016
.084	-1.004	-1.053	-.979	.010	.084	-.150	-.207	-.102	.014
.143	-.990	-1.036	-.950	.009	.143	-.199	-.249	-.158	.012
.202	-.929	-.989	-.884	.010	.202	-.257	-.307	-.203	.016
.301	-.917	-.956	-.875	.011	.301	-.260	-.326	-.164	.021
.354	-.931	-.975	-.897	.010	.354	-.255	-.336	-.159	.023
.407	-.906	-.965	-.877	.011	.407	-.267	-.357	-.176	.023
.460	-.880	-.922	-.836	.012	.460	-.293	-.364	-.201	.025
.513	-1.006	-1.054	-.964	.011	.513	-.241	-.322	-.152	.023
.566	-1.103	-1.177	-.528	.065	.566	-.173	-.241	-.103	.022
.680	-.214	-.402	-.110	.043	.680	.056	.001	.099	.013
.742	-.167	-.266	-.076	.025	.742	.145	.090	.197	.014
.830	-.111	-.206	-.037	.020	.830	.354	.299	.384	.012
.910	-.044	-.092	.025	.015	.910	.396	.344	.435	.010
.990	.162	.101	.205	.012	.975	.256	.215	.289	.012

ETA=.972					ETA=.972				
X/C	MEAN	MAX	MIN	SIGMA	X/C	MEAN	MAX	MIN	SIGMA
.025	-.965	-1.034	-.934	.011	.025	-.098	-.176	-.017	.023
.092	-1.031	-1.096	-.994	.011	.092	-.120	-.201	-.050	.025
.126	-1.035	-1.094	-.994	.014	.126	-.194	-.269	-.118	.023
.227	-1.050	-1.085	-.998	.012	.227	-.343	-.408	-.293	.018
.294	-.964	-1.036	-.908	.018	.294	-.324	-.400	-.248	.023
.362	-.572	-.956	-.140	.161	.362	-.228	-.338	-.106	.033
.430	-.163	-.429	-.065	.033	.430	-.255	-.344	-.150	.031
.497	-.154	-.217	-.078	.025	.497	-.202	-.287	-.132	.024
.565	-.201	-.323	-.085	.031	.565	-.123	-.179	-.049	.020
.632	-.235	-.320	-.150	.024	.632	-.012	-.087	.055	.068
.700	-.212	-.309	-.114	.025	.700	.125	.073	.184	.017
.767	-.182	-.253	-.105	.018	.767	.245	.204	.292	.012
.835	-.122	-.202	-.059	.018	.835	.319	.269	.372	.016
.902	-.083	-.133	-.033	.017	.902	.326	.279	.370	.013
.990	.067	-.004	.132	.019	.973	.201	.141	.241	.065

Table 11. Continued

(ee) Tab point 107,  $M = 0.88$ ,  $q = 145.7$  psf,  $\alpha = 2^\circ$

ETA=.707					ETA=.707				
X/C	MEAN	MAX	MIN	SIGMA	X/C	MEAN	MAX	MIN	SIGMA
.025	-.669	-.721	-.624	.013	.209	-.267	-.342	-.160	.024
.087	-.792	-.851	-.757	.012	.294	-.313	-.448	-.217	.026
.148	-.804	-.843	-.773	.010	.350	-.368	-.472	-.254	.032
.209	-.794	-.848	-.779	.008	.407	-.443	-.626	-.296	.046
.294	-.798	-.855	-.772	.011	.463	-.417	-.618	-.277	.040
.350	-.791	-.829	-.758	.009	.519	-.275	-.396	-.173	.030
.407	-.853	-.898	-.825	.010	.579	-.180	-.257	-.101	.022
.463	-.901	-.955	-.870	.011	.659	.033	-.031	.091	.016
.519	-.918	-.966	-.164	.018	.739	.193	.131	.241	.015
.579	-.932	-.987	-.891	.010	.819	.320	.260	.356	.014
.659	-.965	-1.018	-.923	.013	.899	.404	.356	.449	.013
.739	-.606	-.860	-.322	.094	.974	.302	.244	.351	.019
.819	-.209	-.329	-.112	.034					
.899	-.098	-.195	-.014	.029					
.990	.051	-.050	.127	.028					

ETA=.871					ETA=.871				
X/C	MEAN	MAX	MIN	SIGMA	X/C	MEAN	MAX	MIN	SIGMA
.025	-.565	-.607	-.523	.011	.025	-.055	-.137	.013	.020
.084	-.844	-.880	-.821	.007	.084	-.240	-.319	-.183	.018
.143	-.833	-.888	-.795	.011	.143	-.292	-.360	-.249	.017
.202	-.798	-.862	-.775	.008	.202	-.343	-.401	-.290	.021
.301	-.809	-.850	-.785	.008	.301	-.344	-.461	-.232	.035
.354	-.847	-.898	-.813	.009	.354	-.326	-.414	-.223	.028
.407	-.821	-.866	-.782	.011	.407	-.353	-.448	-.252	.035
.460	-.802	-.850	-.768	.009	.460	-.385	-.534	-.226	.042
.513	-.926	-.973	-.900	.009	.513	-.309	-.431	-.190	.036
.566	-1.059	-1.103	-1.023	.010	.566	-.215	-.311	-.121	.025
.680	-.547	-.970	-.297	.125	.680	.035	-.023	.222	.016
.742	-.327	-.468	-.168	.040	.742	.132	.073	.187	.014
.830	-.110	-.232	-.022	.030	.830	.341	.272	.375	.011
.910	.007	-.074	.061	.018	.910	.386	.351	.424	.011
.990	.143	.059	.194	.015	.975	.252	.204	.297	.013

ETA=.972					ETA=.972				
X/C	MEAN	MAX	MIN	SIGMA	X/C	MEAN	MAX	MIN	SIGMA
.025	-.809	-.861	-.767	.014	.025	-.198	-.292	-.091	.027
.092	-.859	-.917	-.820	.015	.092	-.192	-.274	-.119	.023
.126	-.869	-.917	-.834	.012	.126	-.269	-.361	-.183	.027
.227	-.932	-.980	-.898	.010	.227	-.448	-.495	-.386	.019
.294	-.935	-.993	-.860	.010	.294	-.511	-.618	-.379	.038
.362	-.859	-.917	-.810	.017	.362	-.293	-.527	-.100	.078
.430	-.808	-.893	-.192	.067	.430	-.261	-.437	-.117	.049
.497	-.236	-.722	-.050	.121	.497	-.218	-.332	-.113	.034
.565	-.097	-.211	.002	.037	.565	-.125	-.195	-.034	.023
.632	-.160	-.241	-.080	.027	.632	-.010	-.083	.076	.019
.700	-.158	-.243	-.058	.027	.700	.135	.081	.198	.016
.767	-.141	-.193	-.065	.022	.767	.256	.205	.300	.013
.835	-.087	-.142	-.031	.018	.835	.323	.267	.377	.012
.902	-.057	-.114	-.007	.018	.902	.335	.277	.399	.014
.990	.091	.031	.160	.017	.973	.217	.157	.264	.015



Table 11. Continued

(ff) Tab point 109,  $M = 0.90$ ,  $q = 150.7$  psf,  $\alpha = 2^\circ$ 

ETA=.707					ETA=.707				
X/C	MEAN	MAX	MIN	SIGMA	X/C	MEAN	MAX	MIN	SIGMA
.025	-.575	-.638	-.533	.013					
.087	-.695	-.743	-.652	.012					
.148	-.742	-.781	-.713	.009					
.209	-.735	-.775	-.708	.009	.209	-.326	-.389	-.237	.017
.294	-.745	-.780	-.712	.011	.294	-.432	-.544	-.254	.036
.350	-.736	-.790	-.710	.010	.350	-.425	-.538	-.281	.044
.407	-.808	-.856	-.775	.009	.407	-.556	-.662	-.354	.046
.463	-.857	-.923	-.829	.010	.463	-.558	-.757	-.256	.090
.519	-.876	-.922	-.843	.011	.519	-.309	-.588	-.144	.057
.579	-.890	-.931	-.850	.010	.579	-.206	-.281	-.119	.026
.659	-.941	-.996	-.869	.017	.659	.006	-.053	.065	.017
.739	-.632	-.866	-.299	.101	.739	.165	.103	.209	.016
.819	-.267	-.400	-.155	.036	.819	.291	.240	.332	.013
.899	-.174	-.258	-.072	.028	.899	.380	.333	.423	.013
.990	-.033	-.105	.055	.026	.974	.265	.212	.339	.016

ETA=.871					ETA=.871				
X/C	MEAN	MAX	MIN	SIGMA	X/C	MEAN	MAX	MIN	SIGMA
.025	-.471	-.518	-.436	.010	.025	-.126	-.180	-.048	.021
.084	-.749	-.794	-.726	.007	.084	-.313	-.380	-.261	.015
.143	-.740	-.779	-.712	.013	.143	-.382	-.432	-.324	.016
.202	-.728	-.761	-.689	.010	.202	-.422	-.494	-.364	.021
.301	-.756	-.791	-.728	.009	.301	-.443	-.544	-.298	.027
.354	-.793	-.845	-.750	.011	.354	-.419	-.550	-.261	.050
.407	-.762	-.814	-.721	.013	.407	-.409	-.574	-.256	.047
.460	-.763	-.821	-.731	.011	.460	-.513	-.665	-.322	.053
.513	-.877	-.929	-.846	.010	.513	-.402	-.694	-.206	.074
.566	-1.005	-1.044	-.978	.010	.566	-.246	-.404	-.140	.034
.680	-.836	-.995	-.403	.125	.680	.013	-.056	.079	.016
.742	-.398	-.719	-.301	.043	.742	.115	.034	.168	.016
.830	-.208	-.296	-.117	.027	.830	.322	.262	.362	.014
.910	-.073	-.167	.023	.028	.910	.369	.315	.410	.012
.990	.065	-.049	.140	.026	.975	.215	.152	.264	.016

ETA=.972					ETA=.972				
X/C	MEAN	MAX	MIN	SIGMA	X/C	MEAN	MAX	MIN	SIGMA
.025	-.710	-.752	-.661	.012	.025	-.263	-.367	-.137	.027
.092	-.761	-.840	-.711	.016	.092	-.251	-.322	-.149	.025
.126	-.789	-.840	-.760	.013	.126	-.346	-.418	-.246	.024
.227	-.860	-.913	-.811	.011	.227	-.496	-.548	-.431	.018
.294	-.872	-.925	-.843	.012	.294	-.627	-.713	-.505	.027
.362	-.847	-.898	-.806	.016	.362	-.547	-.698	-.191	.060
.430	-.800	-.874	-.748	.015	.430	-.386	-.707	-.101	.150
.497	-.753	-.837	-.373	.056	.497	-.168	-.380	-.039	.046
.565	-.225	-.752	.014	.144	.565	-.116	-.212	-.009	.029
.632	-.078	-.197	.006	.028	.632	-.011	-.080	.062	.021
.700	-.096	-.199	.039	.028	.700	.131	.078	.191	.016
.767	-.105	-.175	-.006	.020	.767	.254	.198	.313	.014
.835	-.060	-.125	.041	.019	.835	.330	.281	.399	.013
.902	-.041	-.099	.051	.018	.902	.343	.291	.385	.018
.990	.084	.019	.155	.018	.973	.222	.164	.266	.015

Table 11. Continued

(gg) Tab point 111,  $M = 0.92$ ,  $q = 154.8$  psf,  $\alpha = 2^\circ$ 

ETA=.707					ETA=.707				
X/C	MEAN	MAX	MIN	SIGMA	X/C	MEAN	MAX	MIN	SIGMA
.025	-.520	-.588	-.485	.011					
.087	-.652	-.701	-.612	.012					
.148	-.700	-.739	-.673	.010					
.209	-.701	-.744	-.679	.009	.209	-.388	-.425	-.345	.010
.294	-.717	-.771	-.682	.013	.294	-.496	-.541	-.465	.011
.350	-.707	-.758	-.680	.009	.350	-.607	-.660	-.569	.012
.407	-.778	-.834	-.754	.010	.407	-.707	-.766	-.655	.013
.463	-.827	-.876	-.796	.009	.463	-.778	-.837	-.726	.010
.519	-.845	-.887	-.810	.010	.519	-.794	-.838	-.773	.023
.579	-.863	-.906	-.828	.009	.579	-.227	-.358	-.116	.033
.659	-.923	-.959	-.857	.012	.659	-.042	-.144	.017	.026
.739	-.688	-.900	-.348	.090	.739	.103	-.014	.169	.026
.819	-.300	-.435	-.173	.038	.819	.241	.155	.301	.019
.899	-.223	-.297	-.138	.024	.899	.360	.313	.401	.013
.990	-.089	-.180	-.013	.022	.974	.248	.196	.331	.015
ETA=.871					ETA=.871				
X/C	MEAN	MAX	MIN	SIGMA	X/C	MEAN	MAX	MIN	SIGMA
.025	-.404	-.459	-.369	.008	.025	-.173	-.222	-.129	.012
.084	-.683	-.718	-.652	.008	.084	-.374	-.417	-.335	.009
.143	-.690	-.726	-.661	.008	.143	-.421	-.480	-.386	.012
.202	-.679	-.718	-.648	.011	.202	-.471	-.516	-.424	.010
.301	-.710	-.750	-.688	.010	.301	-.513	-.566	-.482	.010
.354	-.754	-.799	-.719	.010	.354	-.599	-.637	-.558	.013
.407	-.732	-.770	-.702	.011	.407	-.629	-.674	-.571	.014
.460	-.765	-.811	-.734	.010	.460	-.691	-.760	-.626	.020
.513	-.835	-.882	-.802	.012	.513	-.728	-.816	-.624	.080
.566	-.948	-.985	-.931	.008	.566	-.275	-.718	-.114	.074
.680	-.924	-.969	-.619	.021	.680	.001	-.076	.066	.018
.742	-.513	-.802	-.339	.078	.742	.097	.033	.152	.017
.830	-.272	-.346	-.195	.021	.830	.306	.245	.342	.015
.910	-.163	-.244	-.082	.023	.910	.354	.295	.400	.012
.990	-.030	-.117	.056	.025	.975	.172	.115	.224	.016
ETA=.972					ETA=.972				
X/C	MEAN	MAX	MIN	SIGMA	X/C	MEAN	MAX	MIN	SIGMA
.025	-.635	-.689	-.600	.015	.025	-.318	-.381	-.240	.023
.092	-.689	-.761	-.636	.013	.092	-.291	-.359	-.246	.016
.126	-.738	-.796	-.707	.009	.126	-.381	-.430	-.318	.017
.227	-.807	-.856	-.768	.013	.227	-.527	-.568	-.488	.012
.294	-.829	-.878	-.809	.009	.294	-.647	-.694	-.615	.013
.362	-.832	-.874	-.796	.014	.362	-.677	-.726	-.634	.012
.430	-.826	-.874	-.785	.012	.430	-.745	-.816	-.608	.021
.497	-.788	-.837	-.747	.015	.497	-.486	-.794	-.083	.178
.565	-.648	-.811	-.232	.104	.565	-.070	-.218	.038	.040
.632	-.170	-.483	.006	.084	.632	.021	-.101	.084	.021
.700	-.023	-.101	.050	.022	.700	.141	.076	.197	.015
.767	-.048	-.116	.027	.021	.767	.250	.193	.305	.014
.835	-.023	-.087	.052	.020	.835	.330	.263	.377	.014
.902	-.026	-.096	.050	.022	.902	.334	.283	.375	.061
.990	.068	-.037	.140	.020	.973	.212	.137	.270	.016

Table 11. Continued

(hh) Tab point 113,  $M = 0.94$ ,  $q = 159.7$  psf,  $\alpha = 2^\circ$

ETA=.707					ETA=.707				
X/C	MEAN	MAX	CP UPPER MIN	SIGMA	X/C	MEAN	MAX	CP LOWER MIN	SIGMA
.025	-.507	-.547	-.470	.010					
.087	-.655	-.691	-.626	.010					
.148	-.681	-.705	-.663	.007					
.209	-.682	-.711	-.658	.008	.209	-.357	-.400	-.334	.008
.294	-.715	-.737	-.672	.008	.294	-.465	-.503	-.440	.009
.350	-.694	-.724	-.670	.010	.350	-.581	-.618	-.552	.011
.407	-.766	-.797	-.731	.009	.407	-.691	-.743	-.668	.010
.463	-.803	-.827	-.772	.009	.463	-.762	-.800	-.725	.010
.519	-.833	-.860	-.806	.009	.519	-.790	-.813	-.770	.006
.579	-.845	-.857	-.824	.008	.579	-.779	-.898	-.398	.086
.659	-.890	-.929	-.831	.014	.659	-.288	-.340	-.229	.016
.739	-.623	-.873	-.337	.097	.739	-.243	-.302	-.169	.019
.819	-.287	-.444	-.168	.037	.819	-.139	-.233	-.003	.035
.899	-.237	-.332	-.145	.026	.899	.105	-.049	.261	.049
.990	-.120	-.196	-.035	.021	.974	.214	.113	.320	.028
ETA=.871					ETA=.871				
X/C	MEAN	MAX	CP UPPER MIN	SIGMA	X/C	MEAN	MAX	CP LOWER MIN	SIGMA
.025	-.402	-.445	-.379	.012	.025	-.121	-.170	-.079	.013
.084	-.679	-.707	-.653	.007	.084	-.348	-.393	-.314	.010
.143	-.685	-.736	-.651	.010	.143	-.391	-.431	-.352	.009
.202	-.678	-.719	-.640	.009	.202	-.453	-.489	-.433	.007
.301	-.706	-.736	-.677	.011	.301	-.487	-.537	-.455	.010
.354	-.746	-.775	-.708	.009	.354	-.582	-.628	-.552	.009
.407	-.735	-.779	-.703	.010	.407	-.615	-.654	-.587	.011
.460	-.769	-.797	-.743	.009	.460	-.700	-.736	-.672	.010
.513	-.827	-.855	-.799	.008	.513	-.756	-.770	-.739	.009
.566	-.925	-.944	-.903	.009	.566	-.861	-.891	-.826	.008
.680	-.895	-.929	-.402	.047	.680	-.333	-.382	-.223	.024
.742	-.557	-.887	-.339	.093	.742	-.242	-.349	-.095	.038
.830	-.293	-.358	-.223	.019	.830	.123	-.045	.300	.054
.910	-.201	-.259	-.135	.020	.910	.361	.320	.421	.014
.990	-.085	-.169	-.024	.025	.975	.162	.111	.207	.014
ETA=.972					ETA=.972				
X/C	MEAN	MAX	CP UPPER MIN	SIGMA	X/C	MEAN	MAX	CP LOWER MIN	SIGMA
.025	-.622	-.667	-.581	.012	.025	-.257	-.335	-.198	.017
.092	-.684	-.726	-.649	.016	.092	-.246	-.304	-.206	.014
.126	-.720	-.750	-.696	.007	.126	-.345	-.384	-.308	.011
.227	-.798	-.830	-.766	.010	.227	-.501	-.540	-.473	.009
.294	-.822	-.862	-.785	.012	.294	-.629	-.673	-.585	.014
.362	-.843	-.880	-.793	.011	.362	-.652	-.692	-.626	.009
.430	-.834	-.880	-.804	.011	.430	-.741	-.802	-.713	.012
.497	-.803	-.834	-.757	.011	.497	-.804	-.847	-.770	.010
.565	-.713	-.829	-.387	.068	.565	-.327	-.562	-.200	.059
.632	-.315	-.649	-.130	.079	.632	-.225	-.322	-.087	.032
.700	-.114	-.256	.037	.046	.700	-.089	-.203	.063	.041
.767	-.068	-.229	.068	.032	.767	.042	-.074	.209	.044
.835	-.014	-.107	.084	.024	.835	.138	-.002	.321	.047
.902	-.024	-.126	.048	.027	.902	.197	.085	.319	.034
.990	.054	-.164	.157	.033	.973	.161	.068	.284	.029

Table 11. Concluded

(ii) Tab point 114,  $M = 0.96$ ,  $q = 163.3$  psf,  $\alpha = 2^\circ$ 

ETA=.707					ETA=.707				
X/C	MEAN	MAX	CP UPPER MIN	SIGMA	X/C	MEAN	MAX	CP LOWER MIN	SIGMA
.025	-.494	-.525	-.460	.009					
.087	-.647	-.686	-.623	.009					
.148	-.660	-.690	-.638	.008					
.209	-.667	-.705	-.643	.007	.209	-.318	-.359	-.294	.007
.294	-.698	-.731	-.678	.006	.294	-.421	-.461	-.399	.011
.350	-.685	-.730	-.655	.009	.350	-.543	-.572	-.518	.007
.407	-.746	-.790	-.726	.007	.407	-.656	-.705	-.632	.008
.463	-.788	-.830	-.765	.007	.463	-.727	-.772	-.688	.008
.519	-.815	-.862	-.788	.007	.519	-.752	-.784	-.732	.009
.579	-.833	-.880	-.806	.008	.579	-.854	-.888	-.828	.007
.659	-.883	-.930	-.855	.007	.659	-.875	-.910	-.801	.009
.739	-.857	-.928	-.714	.028	.739	-.388	-.437	-.361	.010
.819	-.417	-.542	-.294	.036	.819	-.338	-.377	-.302	.011
.899	-.313	-.389	-.249	.019	.899	-.222	-.288	-.152	.018
.990	-.224	-.318	-.160	.019	.974	-.032	-.113	.058	.026
ETA=.871					ETA=.871				
X/C	MEAN	MAX	CP UPPER MIN	SIGMA	X/C	MEAN	MAX	CP LOWER MIN	SIGMA
.025	-.413	-.456	-.382	.007	.025	-.061	-.111	-.022	.009
.084	-.673	-.712	-.649	.007	.084	-.295	-.340	-.274	.006
.143	-.698	-.730	-.668	.007	.143	-.343	-.377	-.322	.007
.202	-.678	-.703	-.659	.007	.202	-.415	-.445	-.391	.009
.301	-.710	-.740	-.691	.006	.301	-.450	-.491	-.423	.007
.354	-.732	-.769	-.714	.007	.354	-.544	-.582	-.518	.007
.407	-.732	-.773	-.709	.007	.407	-.573	-.617	-.552	.007
.460	-.769	-.800	-.748	.008	.460	-.662	-.699	-.636	.007
.513	-.823	-.868	-.803	.007	.513	-.723	-.753	-.702	.005
.566	-.910	-.944	-.883	.007	.566	-.828	-.861	-.808	.005
.680	-.907	-.951	-.801	.008	.680	-.893	-.925	-.873	.006
.742	-.873	-.975	-.439	.085	.742	-.526	-.770	-.387	.072
.830	-.397	-.482	-.295	.025	.830	-.351	-.392	-.310	.009
.910	-.301	-.363	-.242	.020	.910	-.309	-.356	-.236	.015
.990	-.196	-.264	-.122	.023	.975	-.147	-.223	.016	.033
ETA=.972					ETA=.972				
X/C	MEAN	MAX	CP UPPER MIN	SIGMA	X/C	MEAN	MAX	CP LOWER MIN	SIGMA
.025	-.614	-.653	-.579	.009	.025	-.188	-.238	-.149	.011
.092	-.688	-.732	-.657	.010	.092	-.190	-.244	-.148	.009
.126	-.714	-.755	-.691	.008	.126	-.295	-.333	-.269	.008
.227	-.790	-.833	-.770	.006	.227	-.457	-.495	-.441	.008
.294	-.819	-.865	-.800	.009	.294	-.586	-.626	-.562	.006
.362	-.841	-.871	-.818	.010	.362	-.614	-.655	-.590	.009
.430	-.838	-.882	-.807	.009	.430	-.706	-.752	-.686	.007
.497	-.826	-.869	-.794	.007	.497	-.775	-.818	-.753	.008
.565	-.799	-.842	-.600	.021	.565	-.866	-.893	-.848	.007
.632	-.550	-.800	-.281	.078	.632	-.974	-1.014	-.632	.026
.700	-.284	-.448	-.085	.046	.700	-.424	-.564	-.345	.024
.767	-.225	-.328	-.068	.039	.767	-.344	-.424	-.275	.021
.835	-.164	-.259	-.061	.027	.835	-.253	-.339	-.165	.028
.902	-.151	-.272	-.038	.034	.902	-.143	-.233	-.037	.027
.990	-.067	-.307	.080	.047	.973	.017	-.102	.214	.041

Table 12. Pressure Coefficient Statistical Data for High Dynamic Pressure Test Conditions

(a) Tab point 303,  $M = 0.85$ ,  $q = 290.0$  psf,  $\alpha = -1^\circ$

ETA=.707					ETA=.707				
X/C	MEAN	MAX	CP UPPER MIN	SIGMA	X/C	MEAN	MAX	CP LOWER MIN	SIGMA
.025	-.139	-.183	-.092	.013					
.087	-.428	-.469	-.386	.011					
.148	-.466	-.495	-.419	.009					
.209	-.340	-.392	-.282	.015	.209	-.661	-.752	-.325	.070
.294	-.406	-.472	-.305	.023	.294	-.586	-.708	-.261	.091
.350	-.448	-.492	-.354	.016	.350	-.497	-.803	-.299	.099
.407	-.538	-.591	-.440	.019	.407	-.601	-.819	-.275	.093
.463	-.585	-.651	-.353	.021	.463	-.525	-.819	-.258	.092
.519	-.554	-.635	-.226	.037	.519	-.338	-.520	-.165	.052
.579	-.614	-.736	-.202	.093	.579	-.198	-.287	-.040	.033
.659	-.347	-.722	-.128	.082	.659	.017	-.048	.093	.021
.739	-.343	-.643	-.125	.079	.739	.172	.116	.226	.017
.819	-.239	-.380	-.107	.042	.819	.274	.222	.343	.017
.899	-.076	-.152	.017	.026	.899	.369	.321	.432	.016
.990	.141	.078	.197	.016	.974	.327	.275	.389	.017
ETA=.871					ETA=.871				
X/C	MEAN	MAX	CP UPPER MIN	SIGMA	X/C	MEAN	MAX	CP LOWER MIN	SIGMA
.025	-.040	-.076	.008	.013	.025	-.796	-.829	-.747	.011
.084	-.305	-.335	-.276	.009	.084	-.891	-.937	-.800	.020
.143	-.305	-.351	-.211	.018	.143	-.761	-.822	-.685	.020
.202	-.330	-.385	-.273	.014	.202	-.733	-.909	-.495	.092
.301	-.344	-.442	-.181	.027	.301	-.593	-.730	-.295	.090
.354	-.379	-.461	-.196	.035	.354	-.516	-.799	-.193	.111
.407	-.433	-.504	-.228	.043	.407	-.470	-.749	-.184	.084
.460	-.470	-.582	-.213	.063	.460	-.484	-.726	-.231	.088
.513	-.481	-.637	-.197	.083	.513	-.345	-.551	-.158	.062
.566	-.543	-.774	-.179	.110	.566	-.226	-.343	-.080	.041
.680	-.361	-.566	-.155	.067	.680	.024	-.039	.078	.018
.742	-.295	-.446	-.151	.046	.742	.129	.056	.196	.019
.830	-.152	-.245	-.065	.026	.830	.303	.243	.358	.016
.910	-.083	-.149	.000	.022	.910	.334	.286	.385	.014
.990	.145	.082	.199	.017	.975	.253	.212	.293	.013
ETA=.972					ETA=.972				
X/C	MEAN	MAX	CP UPPER MIN	SIGMA	X/C	MEAN	MAX	CP LOWER MIN	SIGMA
.025	-.220	-.287	-.151	.021	.025	-.843	-.892	-.810	.013
.092	-.379	-.424	-.285	.016	.092	-.831	-.894	-.367	.039
.126	-.478	-.533	-.343	.019	.126	-.766	-.892	-.402	.085
.227	-.507	-.593	-.268	.051	.227	-.512	-.790	-.328	.075
.294	-.383	-.583	-.175	.087	.294	-.330	-.595	-.144	.059
.362	-.345	-.617	-.127	.065	.362	-.280	-.478	-.111	.056
.430	-.322	-.490	-.114	.063	.430	-.293	-.438	-.129	.048
.497	-.245	-.355	-.156	.032	.497	-.249	-.355	-.129	.034
.565	-.230	-.366	-.045	.050	.565	-.141	-.223	-.042	.028
.632	-.246	-.354	-.124	.037	.632	-.027	-.102	.045	.022
.700	-.167	-.288	-.046	.036	.700	.135	.079	.202	.019
.767	-.162	-.246	-.047	.027	.767	.242	.196	.298	.013
.835	-.062	-.117	.013	.020	.835	.299	.242	.370	.017
.902	-.057	-.123	.021	.020	.902	.302	.250	.367	.014
.990	.104	.025	.196	.022	.973	.234	.184	.303	.016

Table 12. Continued

(b) Tab point 304,  $M = 0.88$ ,  $q = 303.7$  psf,  $\alpha = -1^\circ$

ETA=.707					ETA=.707				
X/C	MEAN	MAX	CP UPPER MIN	SIGMA	X/C	MEAN	MAX	CP LOWER MIN	SIGMA
.025	-.144	-.192	-.099	.013					
.087	-.432	-.460	-.409	.008					
.148	-.448	-.484	-.417	.012					
.209	-.347	-.391	-.314	.013	.209	-.694	-.724	-.660	.010
.294	-.459	-.502	-.405	.016	.294	-.811	-.847	-.748	.013
.350	-.466	-.521	-.401	.022	.350	-.760	-.819	-.662	.016
.407	-.546	-.587	-.507	.011	.407	-.897	-.957	-.421	.037
.463	-.608	-.645	-.564	.014	.463	-.684	-1.037	-.207	.225
.519	-.583	-.635	-.516	.017	.519	-.280	-.575	-.140	.052
.579	-.677	-.725	-.594	.018	.579	-.160	-.290	-.043	.034
.659	-.667	-.736	-.162	.070	.659	.014	-.046	.077	.020
.739	-.303	-.763	-.108	.096	.739	.157	.087	.216	.018
.819	-.177	-.345	-.061	.043	.819	.263	.195	.327	.018
.899	-.035	-.145	.045	.028	.899	.364	.306	.430	.017
.990	.145	.098	.194	.015	.974	.326	.269	.406	.018
ETA=.871					ETA=.871				
X/C	MEAN	MAX	CP UPPER MIN	SIGMA	X/C	MEAN	MAX	CP LOWER MIN	SIGMA
.025	-.038	-.079	-.004	.012	.025	-.736	-.767	-.702	.010
.084	-.308	-.353	-.280	.010	.084	-.874	-.906	-.835	.010
.143	-.299	-.336	-.263	.011	.143	-.808	-.845	-.767	.012
.202	-.337	-.374	-.308	.008	.202	-.911	-.944	-.868	.011
.301	-.399	-.500	-.329	.026	.301	-.835	-.892	-.764	.018
.354	-.413	-.464	-.334	.018	.354	-.849	-.901	-.310	.042
.407	-.454	-.516	-.350	.023	.407	-.697	-.891	-.147	.182
.460	-.512	-.572	-.421	.018	.460	-.411	-.903	-.169	.121
.513	-.574	-.626	-.334	.020	.513	-.282	-.592	-.113	.063
.566	-.734	-.789	-.264	.045	.566	-.175	-.305	-.048	.042
.680	-.364	-.754	-.125	.110	.680	.049	-.009	.119	.020
.742	-.260	-.507	-.115	.060	.742	.148	.084	.218	.019
.830	-.116	-.234	-.027	.032	.830	.321	.276	.386	.016
.910	-.043	-.131	.047	.029	.910	.350	.297	.409	.014
.990	.153	.090	.213	.019	.975	.262	.224	.314	.013
ETA=.972					ETA=.972				
X/C	MEAN	MAX	CP UPPER MIN	SIGMA	X/C	MEAN	MAX	CP LOWER MIN	SIGMA
.025	-.220	-.303	-.139	.021	.025	-.782	-.834	-.744	.014
.092	-.353	-.382	-.318	.008	.092	-.806	-.848	-.751	.016
.126	-.477	-.509	-.435	.010	.126	-.819	-.898	-.743	.028
.227	-.553	-.611	-.470	.031	.227	-.883	-.940	-.824	.018
.294	-.530	-.604	-.470	.017	.294	-.830	-1.004	-.201	.161
.362	-.600	-.669	-.179	.048	.362	-.193	-.533	-.018	.071
.430	-.476	-.695	-.097	.163	.430	-.151	-.394	.013	.050
.497	-.216	-.638	-.086	.064	.497	-.168	-.327	-.018	.045
.565	-.181	-.361	.008	.059	.565	-.101	-.195	.025	.032
.632	-.216	-.349	-.065	.045	.632	-.002	-.068	.084	.023
.700	-.149	-.287	-.020	.040	.700	.146	.092	.210	.019
.767	-.147	-.229	-.023	.029	.767	.261	.216	.308	.013
.835	-.048	-.111	.036	.021	.835	.328	.277	.383	.016
.902	-.047	-.106	.026	.020	.902	.320	.280	.368	.014
.990	.105	.030	.182	.022	.973	.236	.187	.312	.016

Table 12. Continued

(c) Tab point 310,  $M = 0.90$ ,  $q = 318.4$  psf,  $\alpha = -1^\circ$ 

ETA=.707					ETA=.707				
X/C	MEAN	MAX	CP UPPER MIN	SIGMA	X/C	MEAN	MAX	CP LOWER MIN	SIGMA
.025	-.190	-.266	-.128	.026					
.087	-.408	-.460	-.384	.013					
.148	-.471	-.531	-.419	.018					
.209	-.394	-.441	-.347	.014	.209	-.656	-.679	-.629	.007
.294	-.481	-.517	-.430	.012	.294	-.762	-.798	-.724	.010
.350	-.510	-.557	-.453	.017	.350	-.761	-.825	-.709	.022
.407	-.601	-.648	-.511	.020	.407	-.883	-.907	-.848	.009
.463	-.607	-.660	-.560	.015	.463	-.954	-1.005	-.456	.061
.519	-.608	-.654	-.557	.014	.519	-.316	-.705	-.193	.052
.579	-.702	-.741	-.659	.011	.579	-.255	-.379	-.154	.034
.659	-.698	-.762	-.259	.077	.659	-.231	-.356	-.066	.042
.739	-.264	-.772	-.103	.091	.739	-.171	-.329	.078	.055
.819	-.118	-.269	-.014	.036	.819	-.069	-.263	.246	.075
.899	-.008	-.106	.071	.024	.899	.116	-.088	.458	.089
.990	.083	-.069	.169	.032	.974	.221	.038	.442	.067
ETA=.871					ETA=.871				
X/C	MEAN	MAX	CP UPPER MIN	SIGMA	X/C	MEAN	MAX	CP LOWER MIN	SIGMA
.025	-.102	-.174	-.042	.021	.025	-.607	-.652	-.550	.017
.084	-.370	-.412	-.326	.016	.084	-.744	-.797	-.678	.020
.143	-.321	-.421	-.235	.045	.143	-.701	-.749	-.664	.013
.202	-.358	-.385	-.334	.007	.202	-.819	-.867	-.788	.011
.301	-.517	-.557	-.472	.014	.301	-.780	-.822	-.740	.011
.354	-.522	-.588	-.442	.029	.354	-.822	-.859	-.783	.011
.407	-.541	-.591	-.470	.020	.407	-.824	-.861	-.772	.012
.460	-.580	-.642	-.509	.024	.460	-.767	-.954	-.254	.170
.513	-.621	-.686	-.547	.024	.513	-.335	-.796	-.144	.069
.566	-.759	-.830	-.690	.021	.566	-.213	-.378	-.084	.043
.680	-.608	-.790	-.141	.157	.680	-.071	-.217	.050	.045
.742	-.269	-.560	-.110	.066	.742	.002	-.186	.138	.054
.830	-.074	-.167	.020	.027	.830	.127	-.099	.300	.064
.910	.017	-.062	.084	.022	.910	.187	-.026	.351	.064
.990	.134	.019	.203	.025	.975	.199	.044	.299	.037
ETA=.972					ETA=.972				
X/C	MEAN	MAX	CP UPPER MIN	SIGMA	X/C	MEAN	MAX	CP LOWER MIN	SIGMA
.025	-.301	-.391	-.213	.028	.025	-.670	-.726	-.629	.014
.092	-.376	-.436	-.309	.019	.092	-.681	-.760	-.520	.034
.126	-.482	-.518	-.437	.014	.126	-.684	-.758	-.529	.031
.227	-.584	-.626	-.540	.013	.227	-.802	-.841	-.764	.013
.294	-.644	-.687	-.598	.013	.294	-.904	-.952	-.854	.014
.362	-.688	-.769	-.600	.031	.362	-.649	-.899	-.235	.186
.430	-.694	-.756	-.625	.023	.430	-.273	-.483	-.067	.047
.497	-.681	-.779	-.153	.083	.497	-.145	-.301	-.023	.044
.565	-.249	-.767	-.009	.164	.565	-.046	-.248	.098	.042
.632	-.088	-.232	.023	.035	.632	-.006	-.234	.131	.044
.700	-.048	-.206	.071	.037	.700	.100	-.131	.243	.055
.767	-.078	-.182	.026	.031	.767	.164	-.029	.277	.057
.835	.002	-.072	.091	.024	.835	.205	-.087	.388	.077
.902	-.008	-.073	.079	.022	.902	.221	-.007	.345	.061
.990	.142	.018	.243	.030	.973	.219	.027	.330	.041

Table 12. Continued

(d) Tab point 311,  $M = 0.92$ ,  $q = 325.6$  psf,  $\alpha = -1^\circ$

ETA=.707					ETA=.707				
X/C	MEAN	MAX	CP UPPER MIN	SIGMA	X/C	MEAN	MAX	CP LOWER MIN	SIGMA
.025	-.248	-.298	-.168	.019					
.087	-.449	-.508	-.381	.018					
.148	-.518	-.567	-.467	.016					
.209	-.458	-.524	-.370	.024	.209	-.611	-.643	-.556	.013
.294	-.466	-.510	-.436	.010	.294	-.699	-.759	-.599	.024
.350	-.519	-.545	-.491	.010	.350	-.707	-.802	-.656	.024
.407	-.622	-.661	-.575	.014	.407	-.845	-.882	-.819	.009
.463	-.643	-.711	-.586	.019	.463	-.945	-.978	-.898	.009
.519	-.633	-.682	-.576	.016	.519	-.528	-.974	-.226	.178
.579	-.717	-.762	-.661	.015	.579	-.327	-.445	-.195	.036
.659	-.515	-.740	-.178	.151	.659	-.328	-.441	-.196	.033
.739	-.201	-.476	-.106	.035	.739	-.306	-.425	-.180	.037
.819	-.133	-.214	-.046	.022	.819	-.270	-.413	-.086	.039
.899	-.087	-.162	-.006	.025	.899	-.146	-.295	.035	.041
.990	-.059	-.210	.043	.032	.974	-.011	-.161	.186	.049

ETA=.871					ETA=.871				
X/C	MEAN	MAX	CP UPPER MIN	SIGMA	X/C	MEAN	MAX	CP LOWER MIN	SIGMA
.025	-.170	-.277	-.046	.038	.025	-.493	-.593	-.404	.032
.084	-.436	-.497	-.350	.028	.084	-.631	-.729	-.558	.029
.143	-.438	-.573	-.251	.060	.143	-.625	-.705	-.565	.019
.202	-.378	-.526	-.299	.052	.202	-.761	-.820	-.710	.014
.301	-.501	-.573	-.462	.014	.301	-.725	-.792	-.633	.025
.354	-.541	-.613	-.460	.018	.354	-.769	-.830	-.680	.026
.407	-.567	-.620	-.492	.020	.407	-.778	-.831	-.613	.022
.460	-.617	-.675	-.529	.022	.460	-.808	-.917	-.248	.129
.513	-.664	-.731	-.573	.024	.513	-.408	-.860	-.187	.131
.566	-.800	-.868	-.705	.024	.566	-.277	-.417	-.146	.041
.680	-.632	-.811	-.203	.173	.680	-.224	-.311	-.118	.032
.742	-.333	-.806	-.150	.116	.742	-.181	-.323	-.029	.042
.830	-.145	-.262	-.036	.034	.830	-.089	-.261	.124	.059
.910	-.062	-.166	.033	.036	.910	-.010	-.218	.244	.074
.990	.044	-.146	.177	.043	.975	.082	-.113	.282	.057

ETA=.972					ETA=.972				
X/C	MEAN	MAX	CP UPPER MIN	SIGMA	X/C	MEAN	MAX	CP LOWER MIN	SIGMA
.025	-.362	-.493	-.209	.044	.025	-.592	-.671	-.519	.024
.092	-.425	-.556	-.313	.042	.092	-.500	-.711	-.338	.093
.126	-.514	-.634	-.417	.049	.126	-.549	-.720	-.470	.056
.227	-.588	-.734	-.523	.036	.227	-.741	-.801	-.682	.018
.294	-.640	-.731	-.585	.019	.294	-.852	-.904	-.776	.020
.362	-.727	-.779	-.619	.022	.362	-.684	-.868	-.219	.163
.430	-.720	-.787	-.633	.022	.430	-.284	-.577	-.148	.043
.497	-.723	-.778	-.365	.041	.497	-.214	-.322	-.093	.035
.565	-.432	-.781	-.109	.178	.565	-.153	-.298	.024	.046
.632	-.168	-.492	-.022	.045	.632	-.152	-.333	.040	.052
.700	-.071	-.201	.053	.041	.700	-.076	-.269	.123	.059
.767	-.050	-.178	.088	.030	.767	-.033	-.204	.170	.048
.835	.022	-.093	.122	.027	.835	-.007	-.233	.248	.068
.902	.012	-.125	.120	.031	.902	.024	-.143	.212	.057
.990	.082	-.182	.253	.054	.973	.100	-.121	.344	.065



Table 12. Continued

(e) Tab point 195,  $M = 0.80$ ,  $q = 260.2$  psf,  $\alpha = 0^\circ$ 

ETA=.707					ETA=.707				
X/C	MEAN	MAX	CP UPPER MIN	SIGMA	X/C	MEAN	MAX	CP LOWER MIN	SIGMA
.025	-.388	-.448	-.305	.021					
.087	-.579	-.636	-.470	.021					
.148	-.552	-.624	-.350	.033					
.209	-.396	-.443	-.302	.021	.209	-.359	-.437	-.227	.029
.294	-.443	-.546	-.201	.054	.294	-.397	-.485	-.272	.033
.350	-.454	-.541	-.268	.047	.350	-.394	-.489	-.266	.031
.407	-.536	-.665	-.268	.065	.407	-.457	-.557	-.313	.036
.463	-.534	-.699	-.305	.072	.463	-.410	-.505	-.294	.031
.519	-.457	-.648	-.186	.084	.519	-.284	-.368	-.171	.028
.579	-.448	-.640	-.185	.072	.579	-.177	-.257	-.094	.023
.659	-.372	-.517	-.209	.051	.659	.016	-.047	.083	.018
.739	-.339	-.488	-.186	.046	.739	.185	.136	.245	.015
.819	-.248	-.335	-.153	.030	.819	.313	.261	.362	.014
.899	-.092	-.156	-.028	.021	.899	.411	.364	.456	.014
.990	.124	.068	.173	.014	.974	.338	.293	.394	.014
ETA=.871					ETA=.871				
X/C	MEAN	MAX	CP UPPER MIN	SIGMA	X/C	MEAN	MAX	CP LOWER MIN	SIGMA
.025	-.287	-.340	-.226	.017	.025	-.454	-.526	-.373	.023
.084	-.473	-.511	-.445	.009	.084	-.467	-.518	-.408	.017
.143	-.415	-.483	-.320	.025	.143	-.398	-.450	-.339	.017
.202	-.404	-.450	-.339	.017	.202	-.452	-.517	-.380	.024
.301	-.375	-.468	-.189	.038	.301	-.396	-.471	-.272	.032
.354	-.396	-.514	-.178	.050	.354	-.386	-.483	-.269	.034
.407	-.434	-.555	-.234	.045	.407	-.358	-.472	-.219	.032
.460	-.450	-.564	-.218	.051	.460	-.397	-.503	-.284	.032
.513	-.443	-.628	-.219	.059	.513	-.307	-.414	-.183	.031
.566	-.481	-.653	-.277	.053	.566	-.222	-.289	-.129	.025
.680	-.367	-.469	-.220	.035	.680	.007	-.037	.068	.016
.742	-.320	-.403	-.215	.027	.742	.113	.063	.176	.016
.830	-.193	-.252	-.121	.020	.830	.314	.271	.361	.013
.910	-.098	-.145	-.042	.016	.910	.332	.291	.388	.013
.990	.147	.105	.201	.014	.975	.243	.203	.281	.012
ETA=.972					ETA=.972				
X/C	MEAN	MAX	CP UPPER MIN	SIGMA	X/C	MEAN	MAX	CP LOWER MIN	SIGMA
.025	-.499	-.571	-.413	.024	.025	-.625	-.734	-.495	.036
.092	-.502	-.574	-.371	.026	.092	-.319	-.389	-.209	.029
.126	-.507	-.614	-.289	.041	.126	-.328	-.427	-.214	.032
.227	-.413	-.536	-.239	.040	.227	-.393	-.447	-.339	.017
.294	-.334	-.433	-.209	.034	.294	-.332	-.395	-.261	.022
.362	-.336	-.448	-.195	.035	.362	-.259	-.349	-.137	.029
.430	-.312	-.406	-.206	.032	.430	-.271	-.350	-.171	.028
.497	-.241	-.335	-.174	.021	.497	-.227	-.307	-.103	.024
.565	-.232	-.329	-.117	.030	.565	-.138	-.200	-.068	.021
.632	-.234	-.304	-.152	.025	.632	-.047	-.107	.023	.019
.700	-.161	-.245	-.072	.026	.700	.108	.049	.167	.017
.767	-.166	-.235	-.098	.023	.767	.226	.185	.272	.013
.835	-.075	-.123	-.013	.018	.835	.280	.221	.344	.016
.902	-.076	-.130	-.010	.017	.902	.285	.231	.340	.014
.990	.085	.021	.166	.021	.973	.216	.166	.265	.016

Table 12. Continued

(f) Tab point 196,  $M = 0.85$ ,  $q = 283.4$  psf,  $\alpha = 0^\circ$ 

ETA=.707					ETA=.707				
X/C	MEAN	MAX	CP UPPER MIN	SIGMA	X/C	MEAN	MAX	CP LOWER MIN	SIGMA
.025	-.298	-.349	-.256	.013					
.087	-.520	-.547	-.499	.007					
.148	-.547	-.609	-.495	.019					
.209	-.417	-.460	-.366	.013	.209	-.410	-.564	-.196	.061
.294	-.516	-.574	-.404	.027	.294	-.489	-.623	-.273	.068
.350	-.469	-.540	-.387	.019	.350	-.473	-.623	-.275	.052
.407	-.583	-.642	-.506	.024	.407	-.553	-.753	-.251	.082
.463	-.617	-.685	-.486	.026	.463	-.467	-.699	-.227	.067
.519	-.603	-.668	-.504	.024	.519	-.305	-.459	-.151	.043
.579	-.728	-.777	-.164	.034	.579	-.183	-.270	-.064	.030
.659	-.437	-.782	-.088	.154	.659	.022	-.043	.102	.021
.739	-.300	-.670	-.067	.075	.739	.189	.137	.250	.017
.819	-.215	-.376	-.066	.041	.819	.301	.252	.351	.014
.899	-.061	-.137	.024	.025	.899	.400	.358	.454	.014
.990	.141	.092	.208	.016	.974	.344	.294	.398	.015
ETA=.871					ETA=.871				
X/C	MEAN	MAX	CP UPPER MIN	SIGMA	X/C	MEAN	MAX	CP LOWER MIN	SIGMA
.025	-.200	-.244	-.152	.014	.025	-.585	-.637	-.503	.023
.084	-.455	-.481	-.427	.008	.084	-.642	-.705	-.578	.020
.143	-.399	-.437	-.354	.010	.143	-.525	-.611	-.458	.027
.202	-.429	-.464	-.388	.012	.202	-.567	-.652	-.424	.037
.301	-.549	-.614	-.229	.060	.301	-.484	-.629	-.256	.073
.354	-.408	-.547	-.176	.061	.354	-.421	-.671	-.210	.060
.407	-.432	-.510	-.233	.028	.407	-.454	-.566	-.245	.048
.460	-.554	-.619	-.248	.043	.460	-.490	-.730	-.230	.092
.513	-.581	-.733	-.170	.115	.513	-.328	-.510	-.103	.057
.566	-.559	-.869	-.195	.152	.566	-.227	-.351	-.064	.037
.680	-.358	-.585	-.159	.072	.680	.018	-.034	.092	.017
.742	-.301	-.469	-.167	.047	.742	.126	.071	.214	.018
.830	-.171	-.270	-.067	.028	.830	.317	.272	.390	.015
.910	-.072	-.140	.000	.021	.910	.341	.286	.400	.014
.990	.161	.109	.216	.017	.975	.260	.222	.294	.012
ETA=.972					ETA=.972				
X/C	MEAN	MAX	CP UPPER MIN	SIGMA	X/C	MEAN	MAX	CP LOWER MIN	SIGMA
.025	-.424	-.488	-.361	.019	.025	-.749	-.790	-.661	.018
.092	-.455	-.502	-.409	.012	.092	-.409	-.461	-.247	.029
.126	-.572	-.619	-.430	.016	.126	-.499	-.576	-.368	.027
.227	-.627	-.710	-.280	.064	.227	-.591	-.703	-.454	.049
.294	-.345	-.715	-.148	.097	.294	-.337	-.541	-.227	.045
.362	-.342	-.491	-.136	.065	.362	-.265	-.446	-.095	.052
.430	-.330	-.507	-.128	.063	.430	-.285	-.423	-.132	.045
.497	-.246	-.357	-.160	.032	.497	-.233	-.332	-.107	.035
.565	-.232	-.375	-.065	.049	.565	-.134	-.228	-.049	.027
.632	-.236	-.349	-.120	.037	.632	-.030	-.099	.053	.022
.700	-.161	-.301	-.028	.035	.700	.128	.069	.213	.020
.767	-.158	-.240	-.048	.028	.767	.240	.201	.287	.013
.835	-.063	-.113	-.005	.020	.835	.291	.228	.354	.016
.902	-.058	-.119	.022	.020	.902	.298	.262	.350	.015
.990	.105	.038	.188	.022	.973	.232	.182	.304	.016

Table 12. Continued

(g) Tab point 197,  $M = 0.88$ ,  $q = 297.9$  psf,  $\alpha = 0^\circ$

ETA=.707					ETA=.707				
X/C	MEAN	MAX	CP UPPER MIN	SIGMA	X/C	MEAN	MAX	CP LOWER MIN	SIGMA
.025	-.266	-.320	-.214	.017					
.087	-.453	-.497	-.434	.007					
.148	-.550	-.585	-.516	.007					
.209	-.416	-.461	-.376	.010	.209	-.549	-.596	-.495	.014
.294	-.513	-.546	-.459	.011	.294	-.640	-.700	-.531	.035
.350	-.531	-.572	-.490	.011	.350	-.699	-.734	-.338	.022
.407	-.601	-.669	-.558	.016	.407	-.686	-.918	-.216	.188
.463	-.646	-.688	-.604	.012	.463	-.438	-.878	-.170	.108
.519	-.629	-.664	-.566	.016	.519	-.296	-.540	-.109	.060
.579	-.711	-.751	-.664	.012	.579	-.176	-.274	-.039	.033
.659	-.735	-.785	-.276	.035	.659	.018	-.047	.085	.021
.739	-.308	-.807	-.110	.098	.739	.180	.124	.238	.017
.819	-.153	-.287	-.045	.034	.819	.287	.228	.334	.015
.899	-.017	-.107	.064	.023	.899	.387	.335	.432	.015
.990	.133	.076	.186	.016	.974	.333	.285	.396	.015

ETA=.871					ETA=.871				
X/C	MEAN	MAX	CP UPPER MIN	SIGMA	X/C	MEAN	MAX	CP LOWER MIN	SIGMA
.025	-.137	-.180	-.098	.013	.025	-.612	-.655	-.557	.016
.084	-.406	-.440	-.389	.008	.084	-.713	-.761	-.664	.017
.143	-.342	-.376	-.319	.008	.143	-.688	-.727	-.630	.013
.202	-.403	-.435	-.381	.006	.202	-.794	-.854	-.518	.049
.301	-.533	-.563	-.499	.009	.301	-.614	-.779	-.231	.069
.354	-.600	-.634	-.544	.014	.354	-.534	-.726	-.135	.145
.407	-.528	-.625	-.462	.017	.407	-.407	-.753	-.120	.114
.460	-.548	-.595	-.430	.016	.460	-.544	-.793	-.225	.092
.513	-.650	-.703	-.370	.020	.513	-.367	-.755	-.109	.116
.566	-.783	-.854	-.214	.039	.566	-.211	-.357	-.072	.043
.680	-.331	-.780	-.086	.110	.680	.031	-.021	.088	.018
.742	-.237	-.434	-.088	.050	.742	.136	.080	.203	.018
.830	-.123	-.226	-.027	.032	.830	.322	.264	.371	.016
.910	-.034	-.109	.036	.024	.910	.348	.290	.399	.015
.990	.171	.110	.229	.017	.975	.270	.229	.314	.012

ETA=.972					ETA=.972				
X/C	MEAN	MAX	CP UPPER MIN	SIGMA	X/C	MEAN	MAX	CP LOWER MIN	SIGMA
.025	-.355	-.418	-.286	.018	.025	-.716	-.752	-.666	.012
.092	-.409	-.454	-.372	.014	.092	-.562	-.754	-.212	.094
.126	-.506	-.542	-.479	.010	.126	-.563	-.729	-.362	.047
.227	-.642	-.669	-.612	.009	.227	-.686	-.793	-.574	.056
.294	-.680	-.716	-.633	.013	.294	-.639	-.883	-.211	.138
.362	-.683	-.764	-.136	.082	.362	-.202	-.782	-.024	.089
.430	-.357	-.755	-.093	.172	.430	-.229	-.444	-.035	.062
.497	-.180	-.375	-.087	.040	.497	-.209	-.346	-.060	.041
.565	-.181	-.362	-.004	.053	.565	-.118	-.217	-.011	.029
.632	-.203	-.344	-.072	.041	.632	-.015	-.088	.074	.023
.700	-.140	-.274	-.009	.038	.700	.140	.083	.208	.019
.767	-.139	-.228	-.029	.029	.767	.254	.209	.302	.014
.835	-.047	-.107	.025	.021	.835	.309	.253	.366	.017
.902	-.045	-.102	.044	.020	.902	.313	.261	.369	.015
.990	.112	.053	.214	.022	.973	.241	.191	.301	.017

Table 12. Continued

(h) Tab point 199,  $M = 0.90$ ,  $q = 308.6$  psf,  $\alpha = 0^\circ$

ETA=.707					ETA=.707				
X/C	MEAN	MAX	MIN	SIGMA	X/C	MEAN	MAX	MIN	SIGMA
.025	-.285	-.320	-.240	.012					
.087	-.471	-.508	-.430	.013					
.148	-.546	-.592	-.510	.014					
.209	-.503	-.537	-.450	.015	.209	-.574	-.615	-.523	.017
.294	-.494	-.527	-.449	.012	.294	-.632	-.665	-.583	.012
.350	-.528	-.558	-.496	.008	.350	-.694	-.720	-.663	.010
.407	-.664	-.697	-.623	.012	.407	-.875	-.908	-.836	.010
.463	-.659	-.710	-.618	.015	.463	-.934	-.959	-.848	.010
.519	-.647	-.686	-.602	.014	.519	-.316	-.694	-.166	.064
.579	-.721	-.765	-.674	.016	.579	-.175	-.291	-.074	.033
.659	-.724	-.786	-.323	.067	.659	-.081	-.206	.030	.041
.739	-.253	-.649	-.106	.066	.739	.028	-.156	.160	.050
.819	-.119	-.237	-.020	.033	.819	.137	-.017	.299	.050
.899	-.001	-.086	.062	.021	.899	.281	.130	.423	.046
.990	.104	-.027	.168	.024	.974	.291	.168	.422	.034

ETA=.871					ETA=.871				
X/C	MEAN	MAX	MIN	SIGMA	X/C	MEAN	MAX	MIN	SIGMA
.025	-.161	-.236	-.094	.022	.025	-.540	-.591	-.479	.017
.084	-.429	-.486	-.386	.018	.084	-.669	-.717	-.618	.015
.143	-.310	-.489	-.232	.044	.143	-.660	-.696	-.614	.010
.202	-.370	-.397	-.286	.011	.202	-.795	-.825	-.755	.012
.301	-.602	-.656	-.482	.033	.301	-.746	-.794	-.650	.015
.354	-.572	-.612	-.537	.010	.354	-.724	-.836	-.565	.037
.407	-.600	-.655	-.519	.022	.407	-.699	-.773	-.467	.036
.460	-.584	-.657	-.508	.024	.460	-.767	-.850	-.228	.063
.513	-.659	-.702	-.604	.014	.513	-.450	-.892	-.095	.165
.566	-.818	-.889	-.738	.020	.566	-.181	-.350	-.059	.039
.680	-.548	-.810	-.129	.179	.680	.031	-.064	.090	.019
.742	-.255	-.567	-.091	.057	.742	.132	.035	.208	.019
.830	-.086	-.178	-.003	.027	.830	.315	.207	.374	.019
.910	.005	-.059	.064	.020	.910	.348	.269	.402	.017
.990	.148	.060	.216	.023	.975	.261	.199	.314	.015

ETA=.972					ETA=.972				
X/C	MEAN	MAX	MIN	SIGMA	X/C	MEAN	MAX	MIN	SIGMA
.025	-.363	-.437	-.281	.025	.025	-.653	-.696	-.607	.014
.092	-.409	-.473	-.359	.017	.092	-.550	-.716	-.334	.066
.126	-.477	-.563	-.440	.017	.126	-.573	-.698	-.479	.043
.227	-.602	-.635	-.568	.009	.227	-.763	-.805	-.714	.014
.294	-.688	-.726	-.645	.012	.294	-.840	-.898	-.700	.019
.362	-.731	-.782	-.675	.017	.362	-.719	-.893	-.070	.183
.430	-.734	-.791	-.421	.022	.430	-.187	-.464	-.028	.060
.497	-.579	-.793	-.096	.159	.497	-.104	-.259	.029	.036
.565	-.159	-.685	.008	.077	.565	-.054	-.168	.042	.034
.632	-.094	-.245	.024	.036	.632	.016	-.062	.106	.022
.700	-.062	-.189	.044	.038	.700	.154	.069	.212	.017
.767	-.086	-.182	.011	.031	.767	.257	.173	.303	.017
.835	-.012	-.080	.059	.023	.835	.308	.181	.371	.021
.902	-.021	-.076	.054	.021	.902	.308	.218	.362	.018
.990	.123	.051	.217	.021	.973	.246	.190	.313	.017

Table 12. Continued

(i) Tab point 202,  $M = 0.92$ ,  $q = 317.8$  psf,  $\alpha = 0^\circ$

ETA=.707					ETA=.707				
X/C	MEAN	MAX	MIN	SIGMA	X/C	MEAN	MAX	MIN	SIGMA
.025	-.292	-.328	-.267	.010					
.087	-.532	-.558	-.483	.013					
.148	-.561	-.607	-.522	.017					
.209	-.514	-.543	-.485	.009	.209	-.516	-.564	-.464	.020
.294	-.526	-.561	-.496	.009	.294	-.594	-.630	-.566	.010
.350	-.554	-.574	-.525	.008	.350	-.645	-.672	-.622	.007
.407	-.660	-.688	-.633	.008	.407	-.832	-.861	-.812	.006
.463	-.714	-.756	-.678	.010	.463	-.901	-.920	-.877	.006
.519	-.690	-.731	-.639	.012	.519	-.640	-.928	-.258	.170
.579	-.744	-.786	-.704	.015	.579	-.292	-.400	-.195	.032
.659	-.426	-.774	-.193	.136	.659	-.286	-.374	-.195	.028
.739	-.196	-.290	-.087	.027	.739	-.241	-.352	-.134	.031
.819	-.141	-.214	-.053	.023	.819	-.172	-.308	-.006	.040
.899	-.090	-.194	-.017	.028	.899	.007	-.125	.191	.049
.990	-.025	-.167	.072	.031	.974	.147	.010	.355	.051

ETA=.871					ETA=.871				
X/C	MEAN	MAX	MIN	SIGMA	X/C	MEAN	MAX	MIN	SIGMA
.025	-.239	-.284	-.179	.016	.025	-.429	-.471	-.380	.013
.084	-.504	-.536	-.466	.010	.084	-.568	-.606	-.538	.011
.143	-.513	-.576	-.448	.019	.143	-.581	-.613	-.551	.010
.202	-.398	-.488	-.306	.027	.202	-.726	-.756	-.700	.009
.301	-.587	-.617	-.558	.009	.301	-.682	-.724	-.607	.016
.354	-.747	-.780	-.701	.012	.354	-.682	-.746	-.614	.019
.407	-.622	-.685	-.553	.021	.407	-.679	-.734	-.639	.019
.460	-.618	-.675	-.568	.014	.460	-.772	-.803	-.744	.009
.513	-.690	-.721	-.637	.011	.513	-.638	-.882	-.208	.169
.566	-.830	-.889	-.780	.021	.566	-.244	-.357	-.100	.036
.680	-.445	-.819	-.235	.132	.680	-.163	-.260	-.051	.034
.742	-.254	-.429	-.160	.033	.742	-.111	-.233	.052	.042
.830	-.101	-.173	-.020	.028	.830	-.013	-.157	.227	.054
.910	-.007	-.119	.079	.032	.910	.060	-.105	.317	.063
.990	.109	-.015	.187	.032	.975	.138	-.015	.305	.044

ETA=.972					ETA=.972				
X/C	MEAN	MAX	MIN	SIGMA	X/C	MEAN	MAX	MIN	SIGMA
.025	-.430	-.489	-.376	.017	.025	-.558	-.601	-.521	.012
.092	-.514	-.581	-.443	.023	.092	-.365	-.472	-.319	.025
.126	-.610	-.666	-.421	.030	.126	-.500	-.525	-.470	.009
.227	-.590	-.768	-.530	.043	.227	-.701	-.737	-.660	.011
.294	-.671	-.727	-.638	.014	.294	-.795	-.828	-.751	.012
.362	-.721	-.765	-.683	.011	.362	-.799	-.845	-.705	.021
.430	-.734	-.795	-.681	.015	.430	-.677	-.867	-.253	.148
.497	-.723	-.770	-.616	.018	.497	-.216	-.318	-.084	.032
.565	-.474	-.811	-.085	.184	.565	-.110	-.249	.013	.041
.632	-.138	-.306	.000	.055	.632	-.058	-.234	.069	.047
.700	-.036	-.178	.065	.039	.700	.063	-.126	.260	.052
.767	-.021	-.102	.048	.024	.767	.148	-.034	.283	.046
.835	.043	-.033	.125	.021	.835	.198	-.015	.394	.058
.902	.037	-.030	.129	.024	.902	.231	.105	.352	.043
.990	.148	.061	.222	.023	.973	.231	.081	.368	.036

Table 12. Continued

(j) Tab point 204,  $M = 0.94$ ,  $q = 328.3$  psf,  $\alpha = 0^\circ$

ETA=.707					ETA=.707				
X/C	MEAN	MAX	CP UPPER MIN	SIGMA	X/C	MEAN	MAX	CP LOWER MIN	SIGMA
.025	-.309	-.344	-.264	.012					
.087	-.520	-.540	-.499	.007					
.148	-.588	-.614	-.567	.005					
.209	-.541	-.566	-.510	.009	.209	-.425	-.465	-.406	.008
.294	-.553	-.580	-.527	.008	.294	-.541	-.569	-.512	.008
.350	-.566	-.588	-.545	.007	.350	-.585	-.607	-.564	.006
.407	-.653	-.677	-.634	.005	.407	-.770	-.791	-.749	.005
.463	-.710	-.732	-.694	.005	.463	-.833	-.854	-.813	.007
.519	-.705	-.723	-.681	.006	.519	-.853	-.877	-.835	.006
.579	-.761	-.787	-.745	.005	.579	-.947	-.963	-.915	.018
.659	-.310	-.553	-.198	.040	.659	-.432	-.514	-.351	.023
.739	-.211	-.302	-.111	.021	.739	-.383	-.465	-.319	.020
.819	-.198	-.266	-.137	.020	.819	-.353	-.431	-.271	.023
.899	-.186	-.263	-.108	.020	.899	-.240	-.345	-.127	.027
.990	-.177	-.339	-.077	.037	.974	-.087	-.191	.063	.037
ETA=.871					ETA=.871				
X/C	MEAN	MAX	CP UPPER MIN	SIGMA	X/C	MEAN	MAX	CP LOWER MIN	SIGMA
.025	-.291	-.323	-.259	.012	.025	-.303	-.345	-.252	.015
.084	-.522	-.561	-.498	.010	.084	-.476	-.515	-.449	.010
.143	-.579	-.609	-.542	.013	.143	-.492	-.511	-.467	.008
.202	-.572	-.599	-.549	.008	.202	-.631	-.655	-.590	.010
.301	-.536	-.578	-.501	.016	.301	-.547	-.594	-.520	.013
.354	-.699	-.722	-.684	.005	.354	-.595	-.621	-.563	.007
.407	-.767	-.801	-.721	.011	.407	-.634	-.656	-.613	.005
.460	-.724	-.757	-.685	.013	.460	-.735	-.757	-.715	.005
.513	-.716	-.746	-.692	.010	.513	-.822	-.848	-.807	.007
.566	-.864	-.886	-.836	.008	.566	-.677	-.947	-.261	.207
.680	-.488	-.798	-.292	.099	.680	-.311	-.407	-.226	.029
.742	-.322	-.394	-.266	.018	.742	-.286	-.366	-.186	.031
.830	-.218	-.293	-.156	.019	.830	-.244	-.360	-.116	.034
.910	-.142	-.208	-.072	.022	.910	-.208	-.315	-.064	.035
.990	-.048	-.161	.029	.025	.975	-.085	-.180	.047	.030
ETA=.972					ETA=.972				
X/C	MEAN	MAX	CP UPPER MIN	SIGMA	X/C	MEAN	MAX	CP LOWER MIN	SIGMA
.025	-.489	-.547	-.421	.018	.025	-.464	-.498	-.409	.012
.092	-.548	-.573	-.520	.008	.092	-.312	-.340	-.293	.007
.126	-.642	-.676	-.613	.009	.126	-.430	-.466	-.402	.010
.227	-.747	-.774	-.717	.009	.227	-.601	-.649	-.548	.015
.294	-.730	-.790	-.682	.018	.294	-.723	-.754	-.679	.010
.362	-.754	-.798	-.714	.015	.362	-.700	-.742	-.677	.010
.430	-.781	-.807	-.744	.010	.430	-.780	-.812	-.758	.009
.497	-.754	-.788	-.708	.010	.497	-.797	-.876	-.265	.107
.565	-.453	-.806	-.239	.131	.565	-.303	-.439	-.158	.042
.632	-.232	-.329	-.142	.025	.632	-.283	-.395	-.150	.033
.700	-.161	-.254	-.068	.028	.700	-.223	-.335	-.081	.036
.767	-.111	-.238	.025	.035	.767	-.178	-.271	-.044	.037
.835	-.026	-.130	.077	.031	.835	-.098	-.274	.127	.055
.902	-.008	-.135	.172	.040	.902	.012	-.148	.167	.047
.990	.078	-.170	.204	.043	.973	.177	.016	.351	.053

Table 12. Continued

(k) Tab point 205,  $M = 0.96$ ,  $q = 336.7$  psf,  $\alpha = 0^\circ$

ETA=.707					ETA=.707				
X/C	MEAN	MAX	CP UPPER MIN	SIGMA	X/C	MEAN	MAX	CP LOWER MIN	SIGMA
.025	-.298	-.336	-.267	.010					
.087	-.496	-.512	-.481	.006					
.148	-.568	-.583	-.553	.005					
.209	-.530	-.557	-.512	.005	.209	-.382	-.401	-.359	.006
.294	-.545	-.565	-.530	.005	.294	-.504	-.530	-.485	.006
.350	-.553	-.573	-.537	.004	.350	-.542	-.566	-.524	.007
.407	-.639	-.660	-.623	.006	.407	-.719	-.746	-.700	.006
.463	-.687	-.713	-.666	.006	.463	-.785	-.808	-.772	.005
.519	-.677	-.695	-.659	.006	.519	-.798	-.820	-.779	.005
.579	-.738	-.758	-.721	.003	.579	-.891	-.910	-.876	.003
.659	-.762	-.783	-.643	.004	.659	-.923	-.934	-.902	.006
.739	-.344	-.580	-.253	.039	.739	-.856	-.911	-.616	.046
.819	-.295	-.369	-.233	.017	.819	-.417	-.451	-.384	.010
.899	-.288	-.339	-.240	.015	.899	-.283	-.321	-.240	.013
.990	-.274	-.372	-.208	.020	.974	-.126	-.192	-.047	.020
ETA=.871					ETA=.871				
X/C	MEAN	MAX	CP UPPER MIN	SIGMA	X/C	MEAN	MAX	CP LOWER MIN	SIGMA
.025	-.301	-.320	-.283	.006	.025	-.218	-.251	-.181	.010
.084	-.540	-.567	-.526	.007	.084	-.407	-.438	-.379	.008
.143	-.582	-.604	-.564	.005	.143	-.428	-.445	-.412	.007
.202	-.572	-.584	-.557	.005	.202	-.552	-.575	-.533	.007
.301	-.530	-.554	-.517	.005	.301	-.488	-.513	-.469	.004
.354	-.640	-.657	-.625	.004	.354	-.556	-.580	-.539	.005
.407	-.679	-.703	-.662	.004	.407	-.585	-.608	-.576	.004
.460	-.725	-.748	-.718	.004	.460	-.682	-.697	-.666	.004
.513	-.734	-.759	-.712	.008	.513	-.768	-.787	-.753	.004
.566	-.847	-.864	-.835	.006	.566	-.877	-.898	-.861	.003
.680	-.862	-.883	-.836	.004	.680	-.947	-.961	-.941	.004
.742	-.632	-.883	-.385	.098	.742	-.916	-.937	-.898	.005
.830	-.337	-.382	-.291	.014	.830	-.456	-.505	-.401	.016
.910	-.300	-.358	-.256	.013	.910	-.397	-.440	-.350	.013
.990	-.207	-.300	-.147	.020	.975	-.245	-.291	-.195	.016
ETA=.972					ETA=.972				
X/C	MEAN	MAX	CP UPPER MIN	SIGMA	X/C	MEAN	MAX	CP LOWER MIN	SIGMA
.025	-.501	-.533	-.472	.009	.025	-.371	-.415	-.301	.017
.092	-.549	-.590	-.517	.014	.092	-.255	-.285	-.218	.008
.126	-.628	-.644	-.608	.005	.126	-.356	-.382	-.325	.008
.227	-.730	-.755	-.715	.005	.227	-.511	-.534	-.487	.004
.294	-.748	-.775	-.728	.006	.294	-.645	-.668	-.637	.005
.362	-.788	-.835	-.758	.013	.362	-.649	-.671	-.629	.007
.430	-.767	-.787	-.751	.004	.430	-.726	-.749	-.707	.004
.497	-.752	-.768	-.737	.003	.497	-.810	-.833	-.791	.004
.565	-.793	-.812	-.786	.004	.565	-.832	-.910	-.385	.091
.632	-.804	-.829	-.540	.021	.632	-.476	-.719	-.343	.046
.700	-.329	-.542	-.227	.043	.700	-.401	-.529	-.291	.041
.767	-.268	-.363	-.202	.024	.767	-.363	-.445	-.275	.027
.835	-.211	-.281	-.154	.018	.835	-.356	-.479	-.215	.039
.902	-.221	-.297	-.147	.022	.902	-.323	-.435	-.197	.033
.990	-.158	-.384	-.004	.050	.973	-.200	-.409	.108	.068

Table 12. Continued

(1) Tab point 302,  $M = 0.85$ ,  $q = 287.7$  psf,  $\alpha = 1^\circ$ 

ETA=.707					ETA=.707				
X/C	MEAN	MAX	CP UPPER MIN	SIGMA	X/C	MEAN	MAX	CP LOWER MIN	SIGMA
.025	-.457	-.491	-.429	.009					
.087	-.636	-.677	-.599	.010					
.148	-.682	-.718	-.647	.010					
.209	-.515	-.599	-.454	.026	.209	-.379	-.445	-.199	.034
.294	-.597	-.638	-.536	.014	.294	-.415	-.561	-.216	.050
.350	-.621	-.659	-.580	.013	.350	-.444	-.571	-.258	.047
.407	-.671	-.748	-.590	.025	.407	-.522	-.718	-.277	.072
.463	-.699	-.743	-.503	.017	.463	-.456	-.647	-.206	.058
.519	-.655	-.742	-.527	.035	.519	-.308	-.440	-.166	.042
.579	-.741	-.820	-.609	.026	.579	-.183	-.266	-.080	.029
.659	-.611	-.825	-.201	.159	.659	.027	-.036	.100	.021
.739	-.308	-.545	-.132	.064	.739	.187	.129	.258	.017
.819	-.223	-.383	-.101	.042	.819	.303	.254	.351	.014
.899	-.071	-.153	.011	.026	.899	.400	.353	.448	.014
.990	.124	.073	.199	.015	.974	.334	.284	.392	.015
ETA=.871					ETA=.871				
X/C	MEAN	MAX	CP UPPER MIN	SIGMA	X/C	MEAN	MAX	CP LOWER MIN	SIGMA
.025	-.337	-.380	-.295	.013	.025	-.406	-.489	-.312	.026
.084	-.563	-.586	-.539	.007	.084	-.524	-.588	-.456	.024
.143	-.451	-.542	-.378	.036	.143	-.477	-.527	-.407	.019
.202	-.495	-.520	-.470	.006	.202	-.499	-.592	-.368	.034
.301	-.648	-.682	-.599	.011	.301	-.444	-.594	-.233	.064
.354	-.601	-.694	-.452	.030	.354	-.420	-.570	-.183	.057
.407	-.577	-.678	-.321	.045	.407	-.410	-.569	-.242	.056
.460	-.587	-.687	-.268	.049	.460	-.434	-.653	-.227	.061
.513	-.608	-.728	-.161	.093	.513	-.325	-.485	-.142	.051
.566	-.607	-.879	-.169	.165	.566	-.221	-.322	-.069	.036
.680	-.351	-.692	-.126	.078	.680	.023	-.033	.079	.018
.742	-.294	-.450	-.128	.051	.742	.128	.063	.198	.019
.830	-.159	-.247	-.072	.029	.830	.317	.262	.367	.015
.910	-.089	-.169	.000	.023	.910	.347	.288	.394	.013
.990	.138	.076	.194	.018	.975	.253	.213	.290	.013
ETA=.972					ETA=.972				
X/C	MEAN	MAX	CP UPPER MIN	SIGMA	X/C	MEAN	MAX	CP LOWER MIN	SIGMA
.025	-.560	-.612	-.510	.014	.025	-.612	-.715	-.473	.033
.092	-.538	-.587	-.495	.014	.092	-.339	-.442	-.201	.042
.126	-.637	-.664	-.586	.011	.126	-.450	-.525	-.272	.037
.227	-.716	-.759	-.395	.021	.227	-.509	-.606	-.423	.027
.294	-.521	-.784	-.091	.178	.294	-.365	-.569	-.206	.052
.362	-.301	-.490	-.086	.066	.362	-.277	-.445	-.099	.051
.430	-.323	-.506	-.145	.063	.430	-.286	-.410	-.111	.046
.497	-.244	-.382	-.127	.035	.497	-.242	-.339	-.130	.034
.565	-.233	-.399	-.040	.052	.565	-.140	-.224	-.042	.028
.632	-.260	-.381	-.125	.037	.632	-.034	-.103	.039	.022
.700	-.178	-.290	-.046	.038	.700	.122	.062	.186	.019
.767	-.178	-.254	-.077	.027	.767	.231	.180	.276	.013
.835	-.081	-.136	-.018	.021	.835	.293	.243	.355	.016
.902	-.071	-.136	-.009	.020	.902	.292	.252	.339	.014
.990	.093	.025	.168	.023	.973	.222	.174	.293	.016



Table 12. Continued

(m) Tab point 306,  $M = 0.88$ ,  $q = 301.6$  psf,  $\alpha = 1^\circ$

ETA=.707					ETA=.707				
X/C	MEAN	MAX	MIN	SIGMA	X/C	MEAN	MAX	MIN	SIGMA
.025	-.379	-.410	-.351	.008					
.087	-.566	-.617	-.537	.011					
.148	-.632	-.663	-.601	.009					
.209	-.564	-.600	-.527	.010	.209	-.457	-.530	-.260	.039
.294	-.552	-.586	-.505	.011	.294	-.541	-.642	-.268	.079
.350	-.604	-.634	-.571	.009	.350	-.469	-.737	-.288	.080
.407	-.715	-.748	-.679	.011	.407	-.612	-.782	-.298	.075
.463	-.704	-.761	-.662	.016	.463	-.566	-.839	-.254	.111
.519	-.684	-.742	-.622	.016	.519	-.319	-.517	-.147	.059
.579	-.784	-.829	-.736	.013	.579	-.190	-.303	-.076	.035
.659	-.784	-.845	-.302	.059	.659	.019	-.046	.101	.021
.739	-.318	-.786	-.138	.083	.739	.177	.117	.235	.017
.819	-.171	-.330	-.067	.036	.819	.291	.237	.353	.015
.899	-.035	-.129	.028	.024	.899	.392	.348	.438	.015
.990	.109	.013	.167	.020	.974	.326	.259	.374	.017

ETA=.871					ETA=.871				
X/C	MEAN	MAX	MIN	SIGMA	X/C	MEAN	MAX	MIN	SIGMA
.025	-.252	-.311	-.206	.015	.025	-.503	-.575	-.382	.027
.084	-.503	-.548	-.469	.014	.084	-.602	-.680	-.537	.023
.143	-.414	-.546	-.299	.036	.143	-.532	-.641	-.454	.032
.202	-.440	-.466	-.394	.007	.202	-.593	-.666	-.446	.028
.301	-.601	-.624	-.572	.009	.301	-.558	-.659	-.278	.068
.354	-.600	-.656	-.538	.020	.354	-.498	-.734	-.215	.105
.407	-.617	-.670	-.566	.013	.407	-.450	-.744	-.166	.084
.460	-.651	-.695	-.588	.016	.460	-.493	-.784	-.199	.095
.513	-.695	-.754	-.618	.017	.513	-.343	-.702	-.136	.071
.566	-.831	-.882	-.574	.020	.566	-.218	-.341	-.071	.042
.680	-.353	-.823	-.103	.125	.680	.032	-.043	.087	.019
.742	-.228	-.499	-.099	.048	.742	.137	.073	.207	.019
.830	-.109	-.212	-.003	.031	.830	.317	.261	.372	.015
.910	-.044	-.137	.047	.030	.910	.349	.299	.406	.014
.990	.153	.085	.215	.018	.975	.263	.215	.310	.013

ETA=.972					ETA=.972				
X/C	MEAN	MAX	MIN	SIGMA	X/C	MEAN	MAX	MIN	SIGMA
.025	-.466	-.521	-.402	.020	.025	-.680	-.731	-.543	.019
.092	-.489	-.531	-.437	.015	.092	-.418	-.474	-.226	.028
.126	-.574	-.593	-.542	.008	.126	-.520	-.616	-.375	.038
.227	-.671	-.701	-.633	.010	.227	-.645	-.771	-.549	.027
.294	-.718	-.748	-.672	.011	.294	-.582	-.832	-.254	.120
.362	-.737	-.823	-.168	.087	.362	-.232	-.631	-.024	.079
.430	-.343	-.758	-.103	.145	.430	-.259	-.486	-.076	.062
.497	-.187	-.405	-.092	.038	.497	-.228	-.341	-.106	.039
.565	-.180	-.346	-.009	.052	.565	-.127	-.214	-.005	.029
.632	-.225	-.358	-.113	.040	.632	-.022	-.099	.055	.022
.700	-.151	-.277	-.026	.039	.700	.134	.076	.200	.019
.767	-.159	-.242	-.057	.028	.767	.241	.200	.287	.013
.835	-.063	-.130	.013	.021	.835	.301	.238	.362	.016
.902	-.059	-.118	.020	.020	.902	.299	.258	.341	.014
.990	.100	.019	.183	.023	.973	.232	.183	.291	.016

Table 12. Concluded

(n) Tab point 307,  $M = 0.90$ ,  $q = 316.3$  psf,  $\alpha = 1^\circ$

ETA=.707					ETA=.707				
X/C	MEAN	MAX	CP UPPER MIN	SIGMA	X/C	MEAN	MAX	CP LOWER MIN	SIGMA
.025	-.368	-.407	-.335	.012					
.087	-.586	-.615	-.561	.010					
.148	-.639	-.675	-.594	.013					
.209	-.580	-.619	-.540	.012	.209	-.470	-.499	-.444	.008
.294	-.594	-.635	-.553	.014	.294	-.549	-.585	-.510	.009
.350	-.627	-.665	-.588	.014	.350	-.672	-.697	-.647	.007
.407	-.712	-.746	-.680	.010	.407	-.834	-.864	-.799	.008
.463	-.759	-.793	-.726	.010	.463	-.939	-.963	-.914	.006
.519	-.738	-.778	-.696	.013	.519	-.519	-.894	-.205	.151
.579	-.810	-.856	-.372	.045	.579	-.247	-.361	-.134	.032
.659	-.355	-.805	-.178	.093	.659	-.172	-.274	-.055	.034
.739	-.210	-.324	-.104	.030	.739	-.077	-.208	.072	.045
.819	-.135	-.259	-.053	.025	.819	.029	-.144	.226	.057
.899	-.070	-.178	.016	.030	.899	.179	.003	.375	.063
.990	.004	-.124	.099	.032	.974	.203	.054	.357	.048
ETA=.871					ETA=.871				
X/C	MEAN	MAX	CP UPPER MIN	SIGMA	X/C	MEAN	MAX	CP LOWER MIN	SIGMA
.025	-.291	-.346	-.235	.017	.025	-.410	-.473	-.318	.023
.084	-.547	-.571	-.512	.008	.084	-.556	-.603	-.506	.016
.143	-.573	-.632	-.520	.021	.143	-.565	-.605	-.513	.014
.202	-.576	-.627	-.518	.016	.202	-.644	-.742	-.544	.053
.301	-.581	-.655	-.515	.023	.301	-.570	-.610	-.522	.012
.354	-.625	-.676	-.541	.021	.354	-.660	-.689	-.617	.011
.407	-.638	-.705	-.572	.025	.407	-.714	-.743	-.664	.011
.460	-.675	-.737	-.619	.021	.460	-.840	-.878	-.774	.013
.513	-.722	-.780	-.662	.023	.513	-.726	-.886	-.256	.141
.566	-.851	-.904	-.804	.016	.566	-.259	-.429	-.123	.049
.680	-.426	-.834	-.187	.142	.680	-.042	-.181	.050	.036
.742	-.248	-.420	-.111	.047	.742	.054	-.106	.157	.043
.830	-.076	-.185	.003	.029	.830	.221	.001	.349	.057
.910	.014	-.086	.073	.022	.910	.285	.081	.392	.049
.990	.129	.030	.193	.024	.975	.236	.114	.306	.022
ETA=.972					ETA=.972				
X/C	MEAN	MAX	CP UPPER MIN	SIGMA	X/C	MEAN	MAX	CP LOWER MIN	SIGMA
.025	-.474	-.556	-.399	.024	.025	-.571	-.633	-.471	.018
.092	-.538	-.606	-.467	.024	.092	-.385	-.419	-.326	.013
.126	-.635	-.686	-.587	.016	.126	-.502	-.549	-.417	.020
.227	-.722	-.793	-.592	.027	.227	-.684	-.735	-.602	.028
.294	-.706	-.780	-.641	.029	.294	-.753	-.843	-.694	.028
.362	-.771	-.818	-.730	.013	.362	-.743	-.821	-.652	.020
.430	-.759	-.826	-.690	.024	.430	-.432	-.803	-.067	.168
.497	-.663	-.779	-.176	.102	.497	-.119	-.241	-.028	.031
.565	-.190	-.777	.029	.126	.565	-.039	-.158	.041	.028
.632	-.083	-.193	.000	.028	.632	.007	-.100	.081	.026
.700	-.037	-.139	.060	.030	.700	.118	-.046	.202	.038
.767	-.077	-.172	.010	.027	.767	.185	.037	.273	.041
.835	.003	-.073	.103	.025	.835	.230	.013	.356	.056
.902	-.007	-.068	.091	.023	.902	.241	.049	.331	.044
.990	.144	.061	.244	.026	.973	.229	.017	.343	.031

ORIGINAL PAGE  
BLACK AND WHITE PHOTOGRAPH

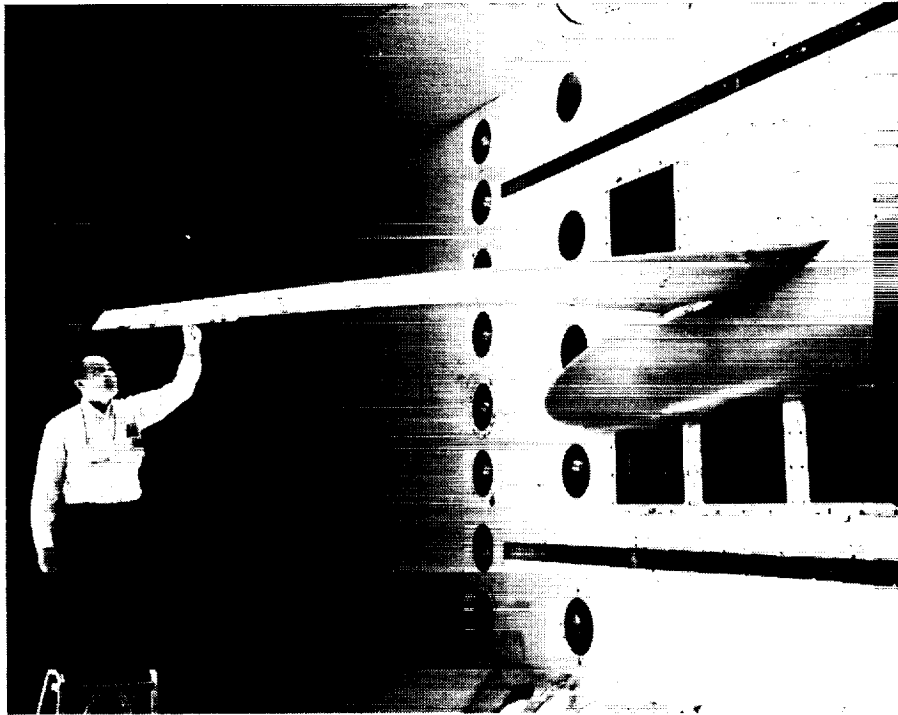

L-83-9881

Figure 1. DAST ARW-2 model mounted in wind tunnel.

NATIONAL AERONAUTICS AND SPACE ADMINISTRATION  
 RESEARCH REPORT 71-191

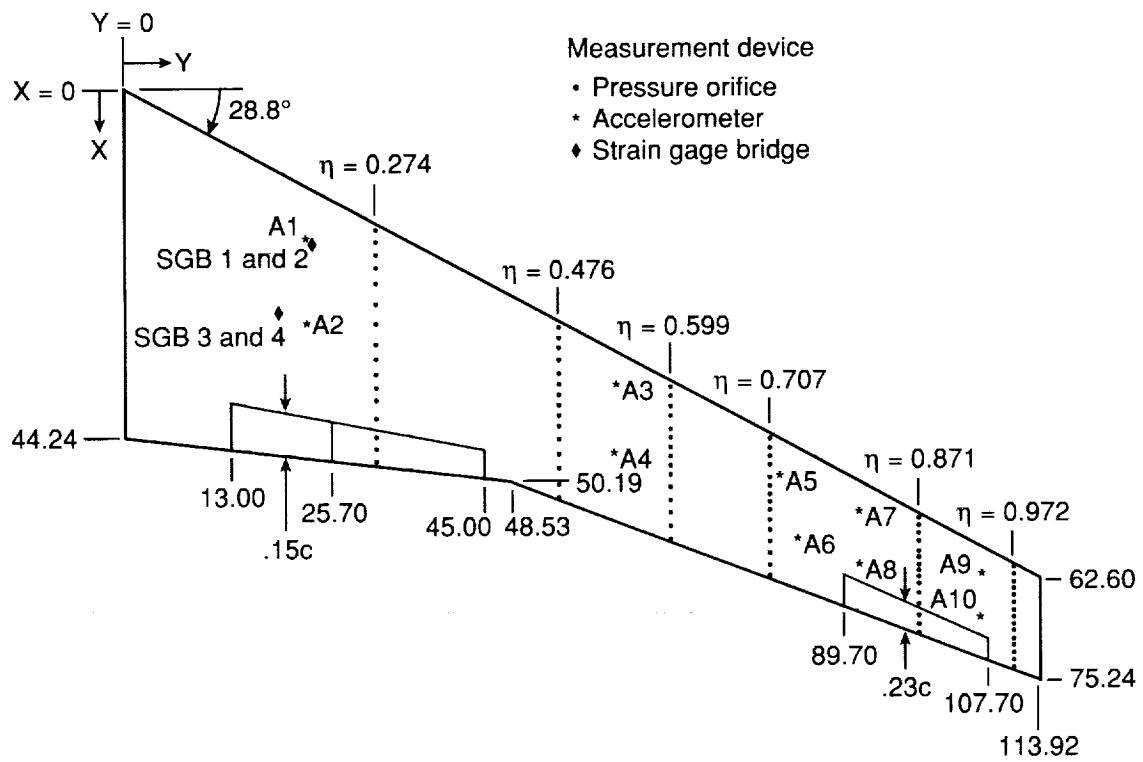

Figure 2. Sketch of wing planform. All dimensions in inches unless otherwise specified.

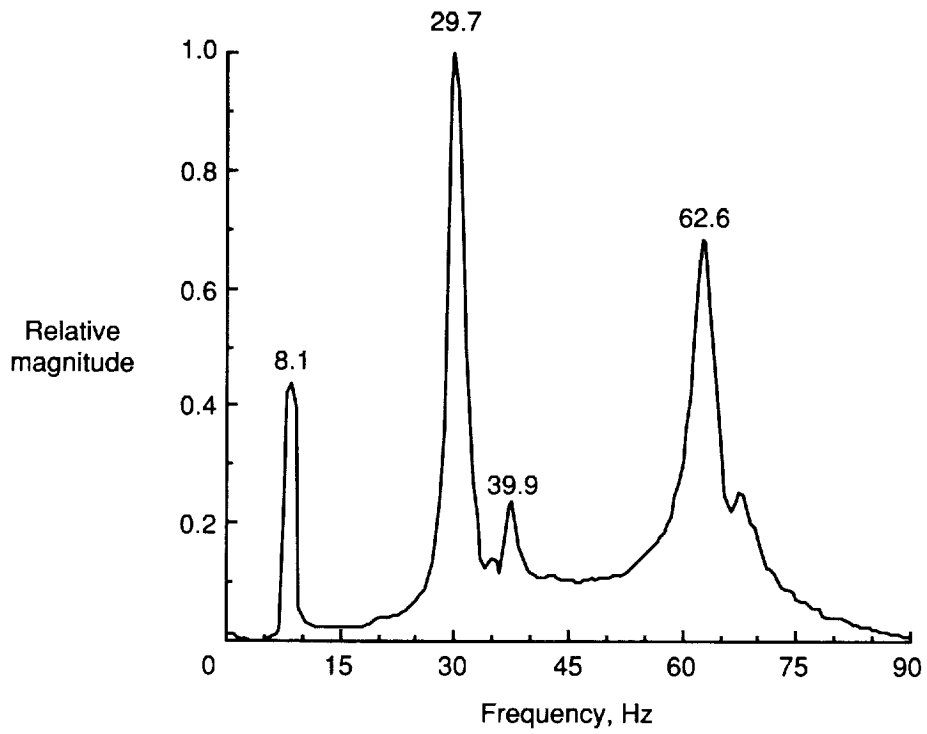

Figure 3. Wing frequency response characteristics measured in still air.

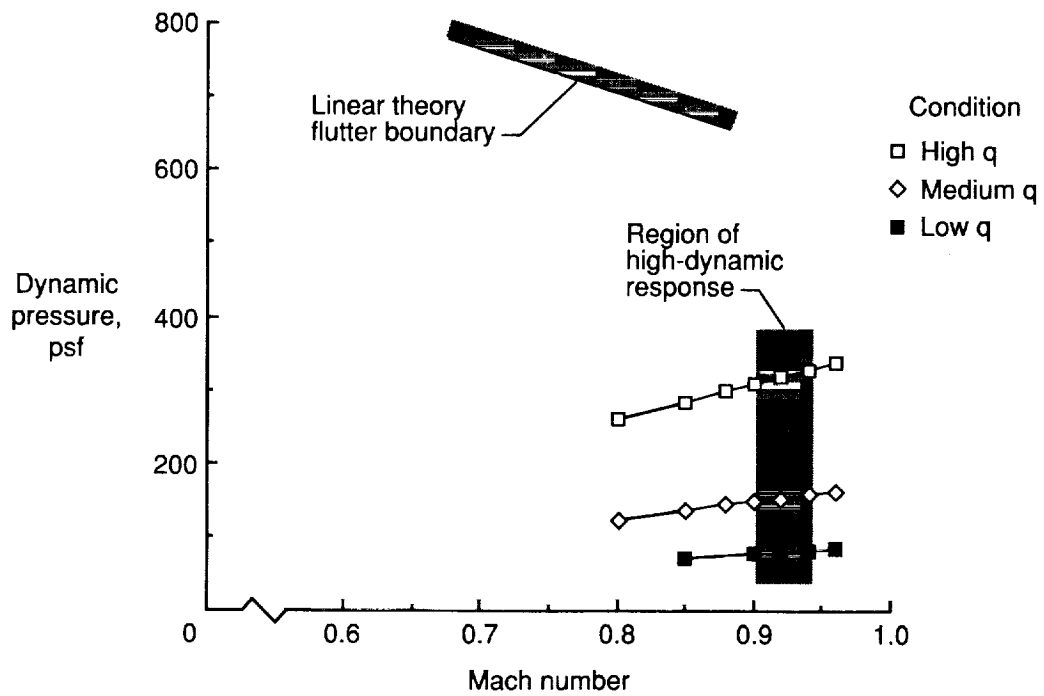
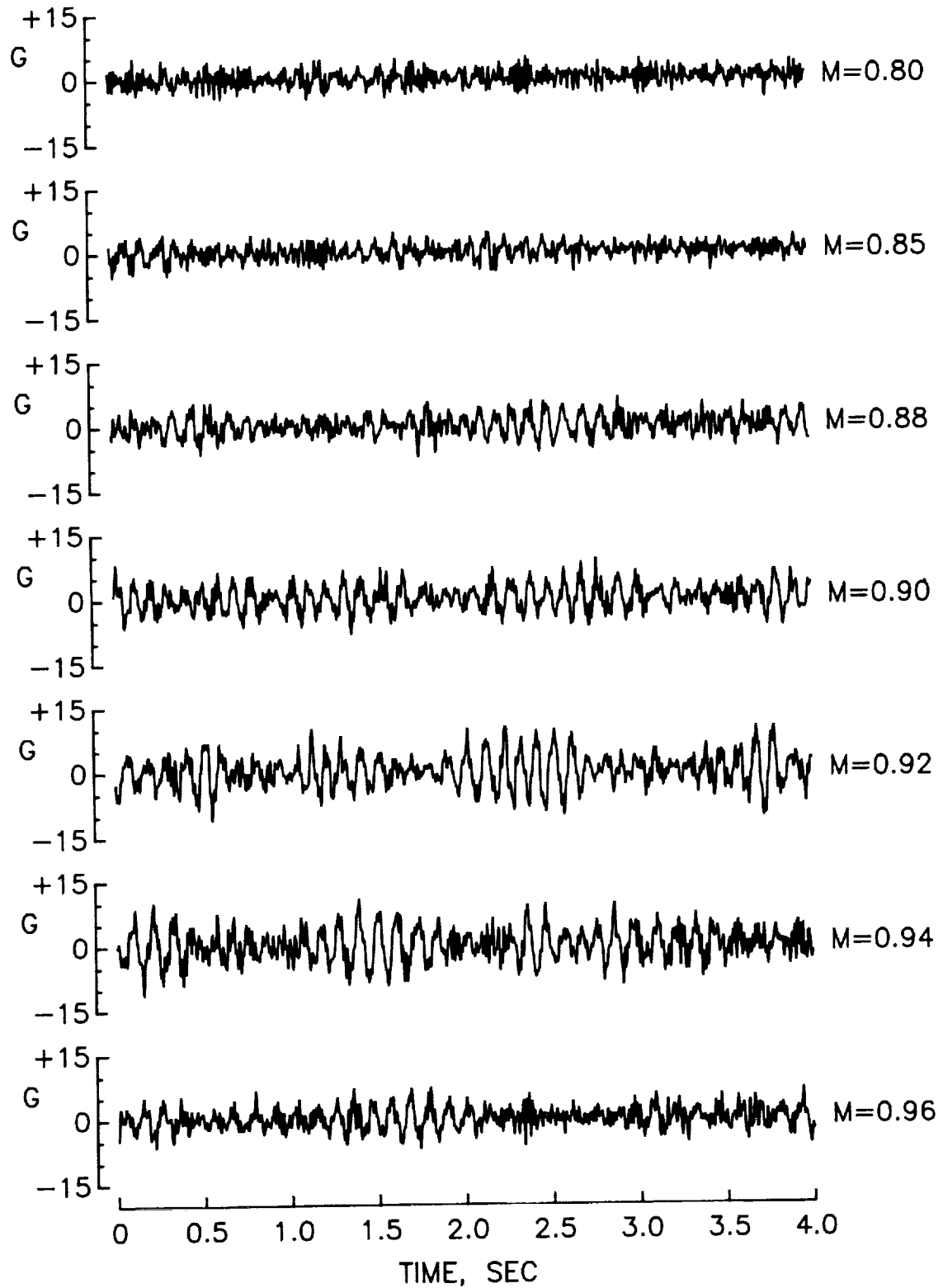
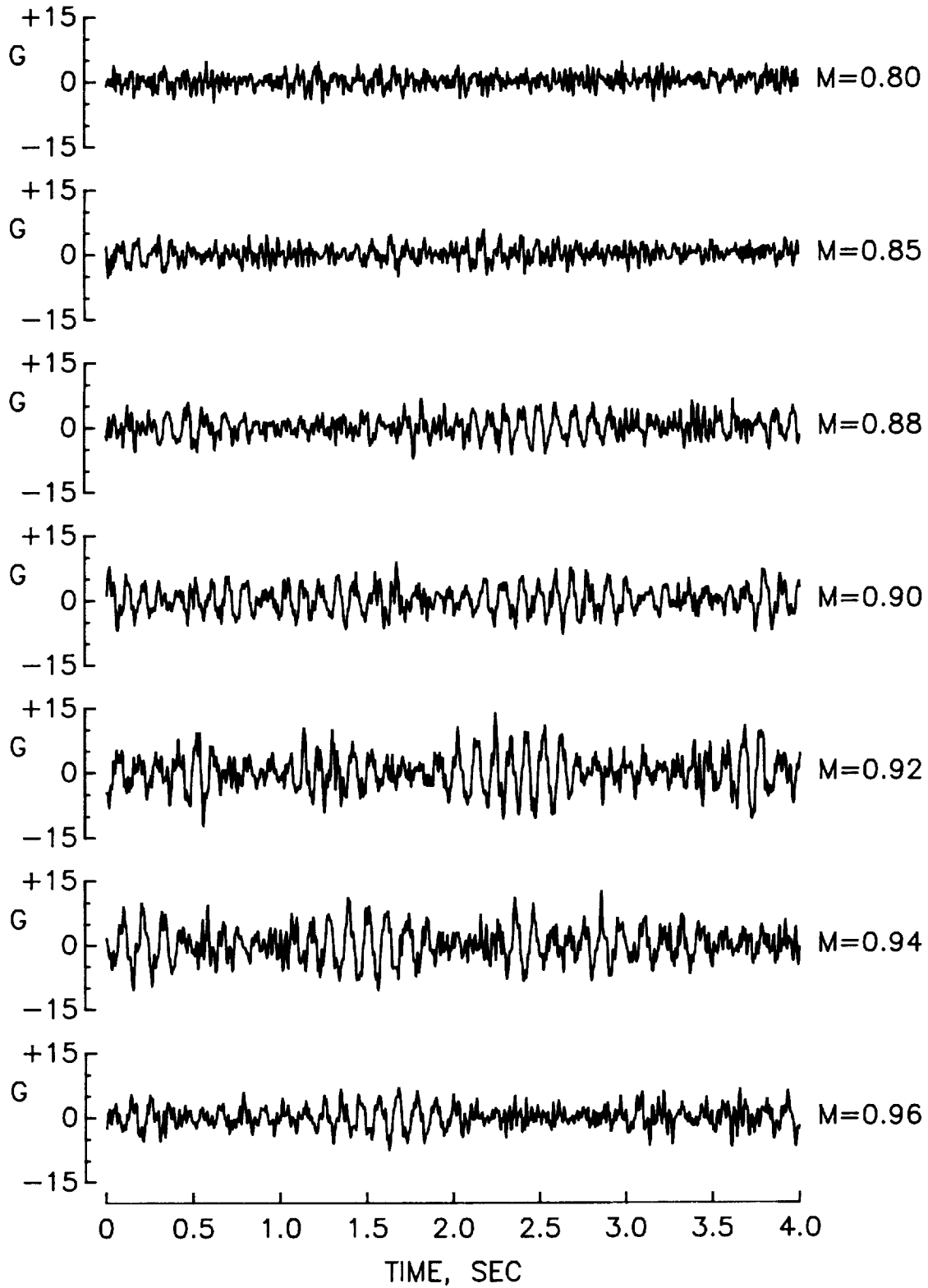

Figure 4. Test conditions.



(a) Data from accelerometer 9 for medium  $q$  conditions.  $\alpha = 0^\circ$ .

Figure 5. Examples of accelerometer time histories.



(b) Data from accelerometer 10 for medium  $q$  conditions.  $\alpha = 0^\circ$ .

Figure 5. Continued.

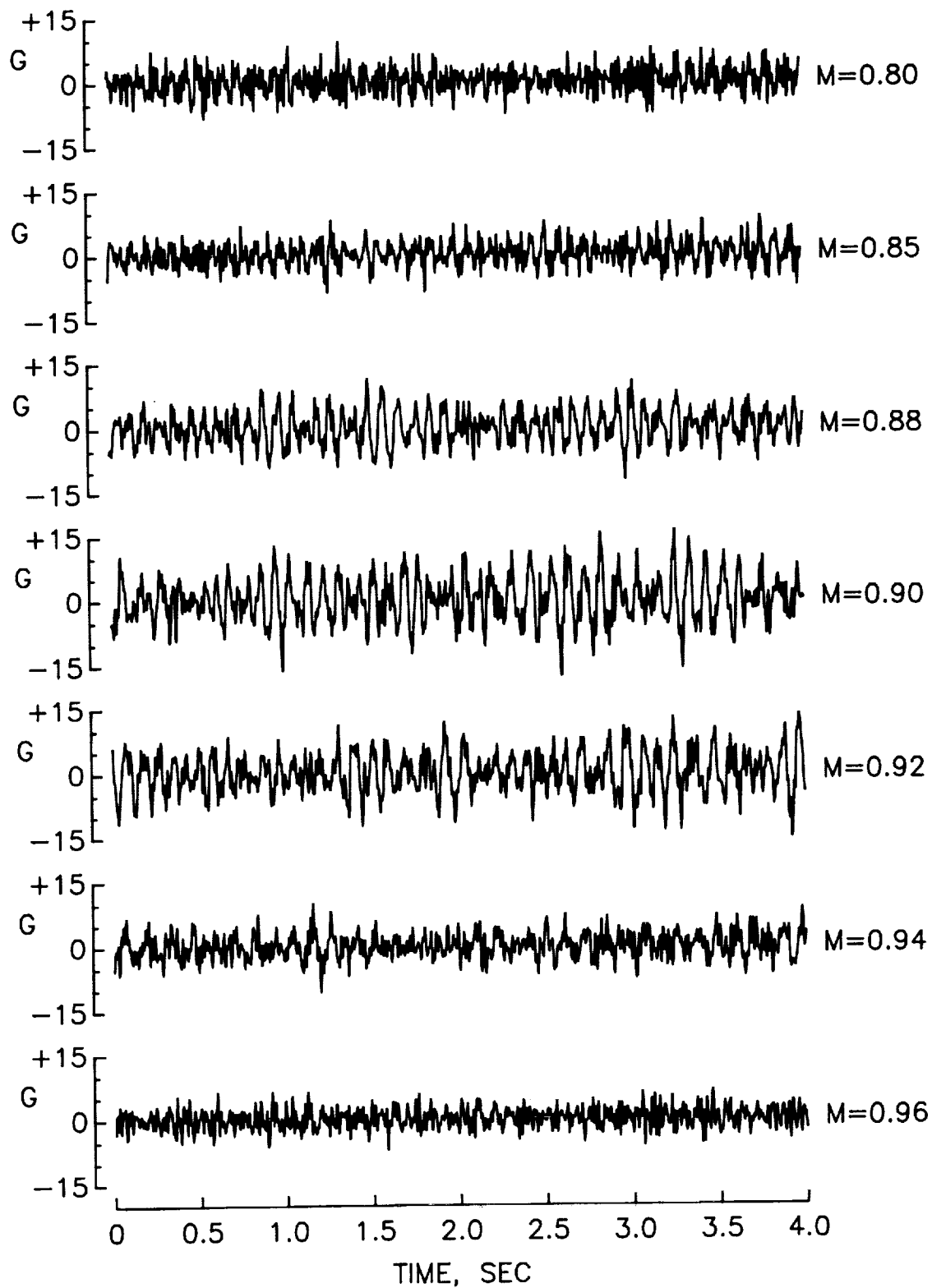

(c) Data from accelerometer 9 for high  $q$  conditions.  $\alpha = 0^\circ$ .

Figure 5. Continued.



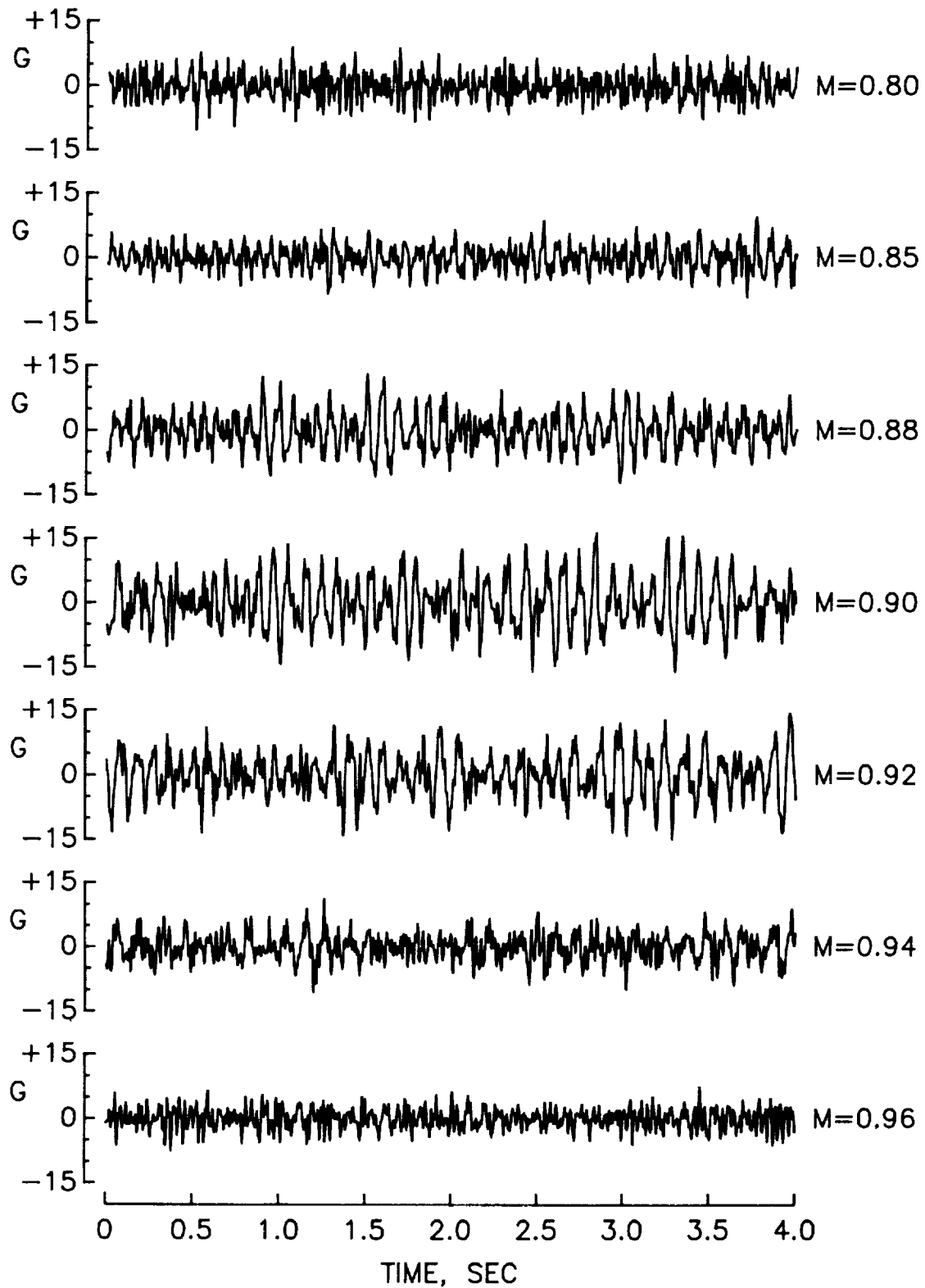

(d) Data from accelerometer 10 for high  $q$  conditions.  $\alpha = 0^\circ$ .

Figure 5. Concluded.

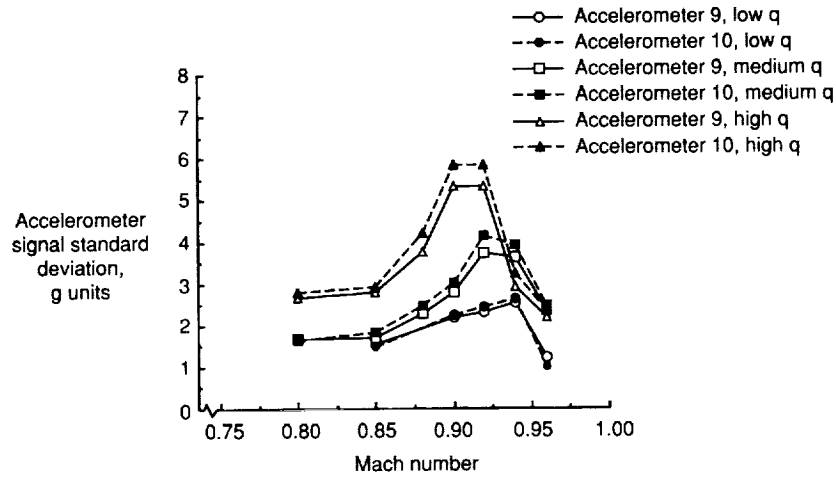

Figure 6. Accelerometer measurement standard deviation data.

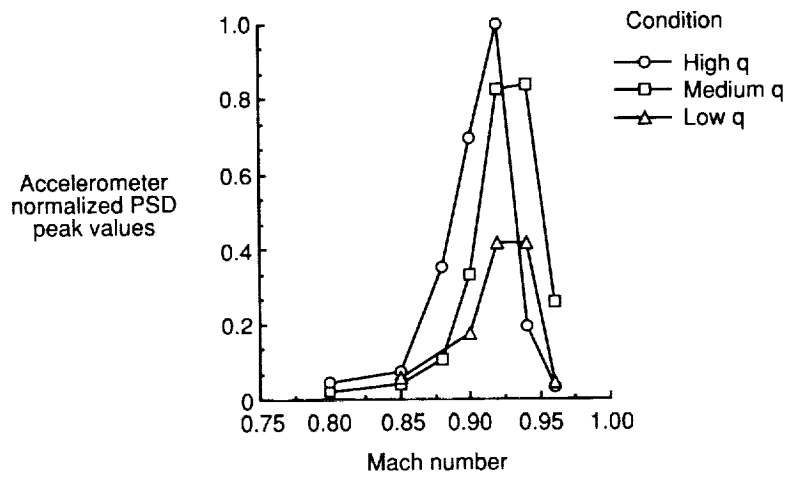

Figure 7. Maximum PSD peak responses from accelerometer 9.

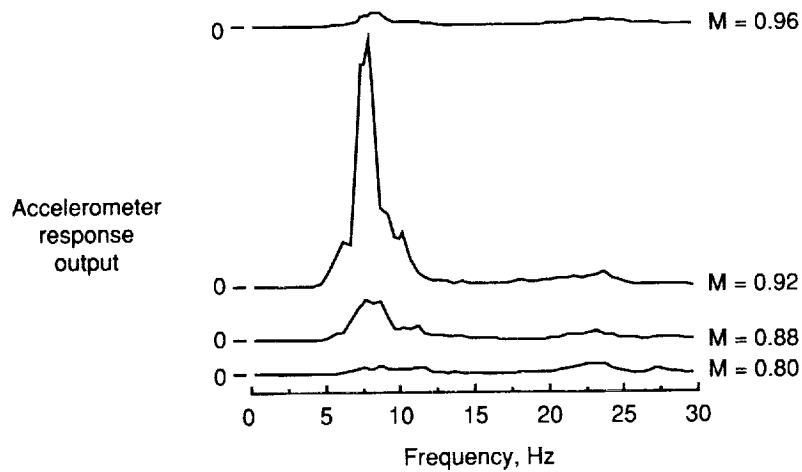

Figure 8. Real-time peak-hold frequency response analysis results for high  $q$  conditions for accelerometer 9 at  $\alpha = 0^\circ$ .

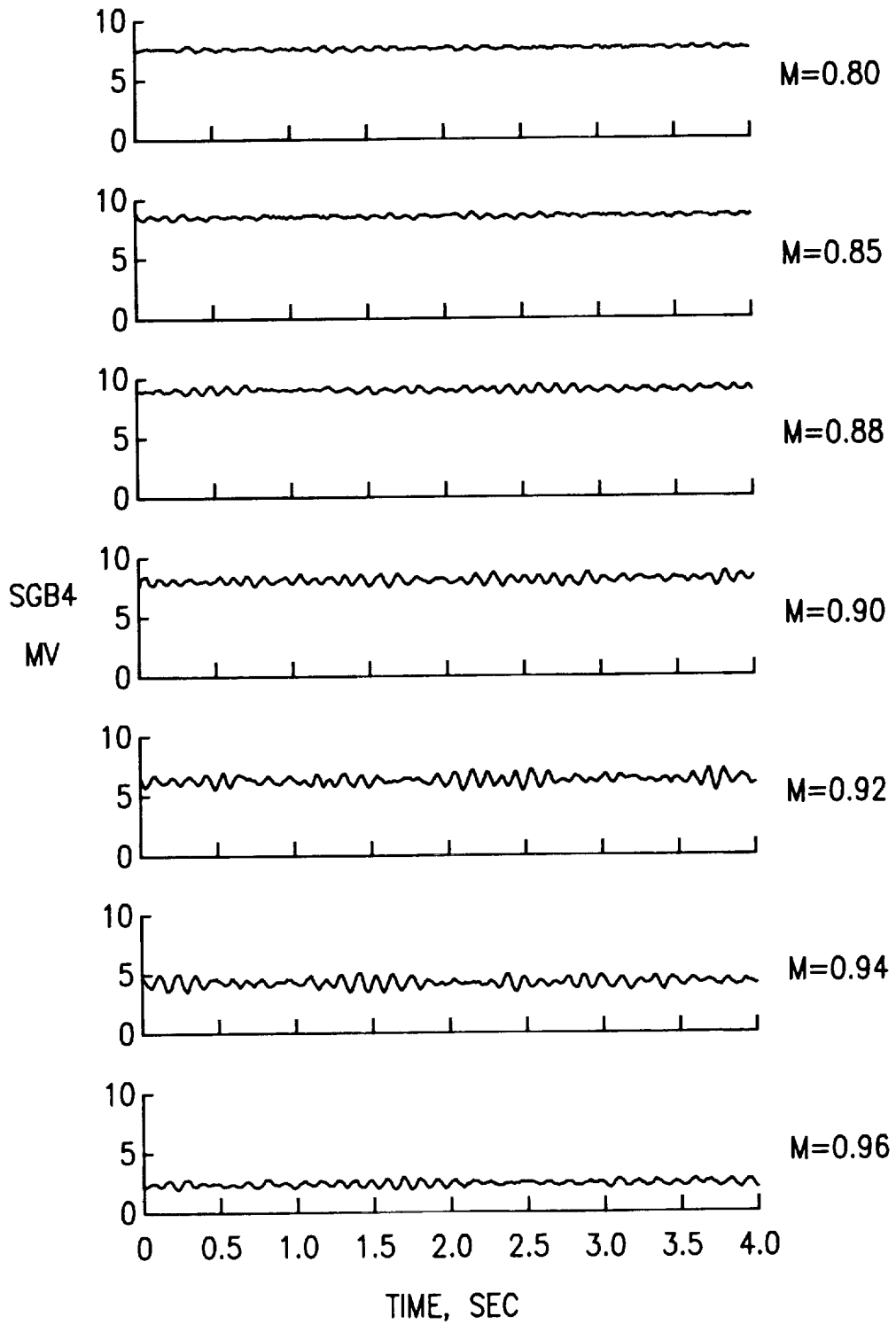

Figure 9. Examples of strain gage bridge 4 measurement time histories for medium  $q$  condition.  $\alpha = 0^\circ$ .

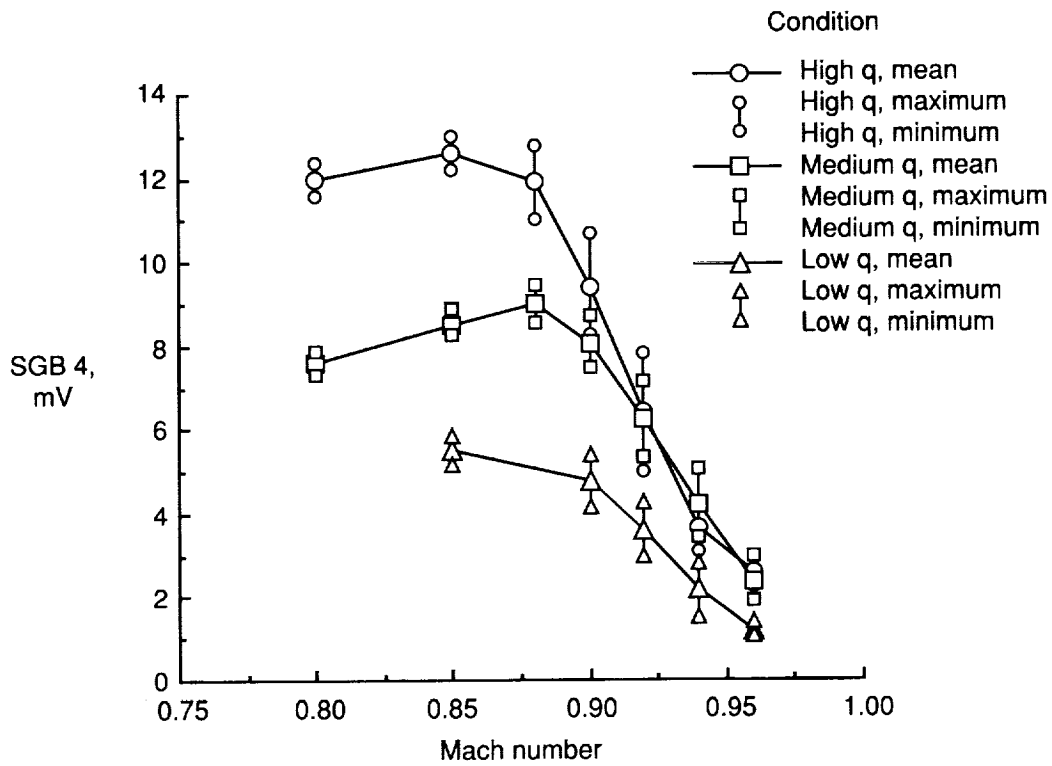

Figure 10. Strain gage bridge 4 mean, minimum, and maximum values for  $\alpha = 0^\circ$ .

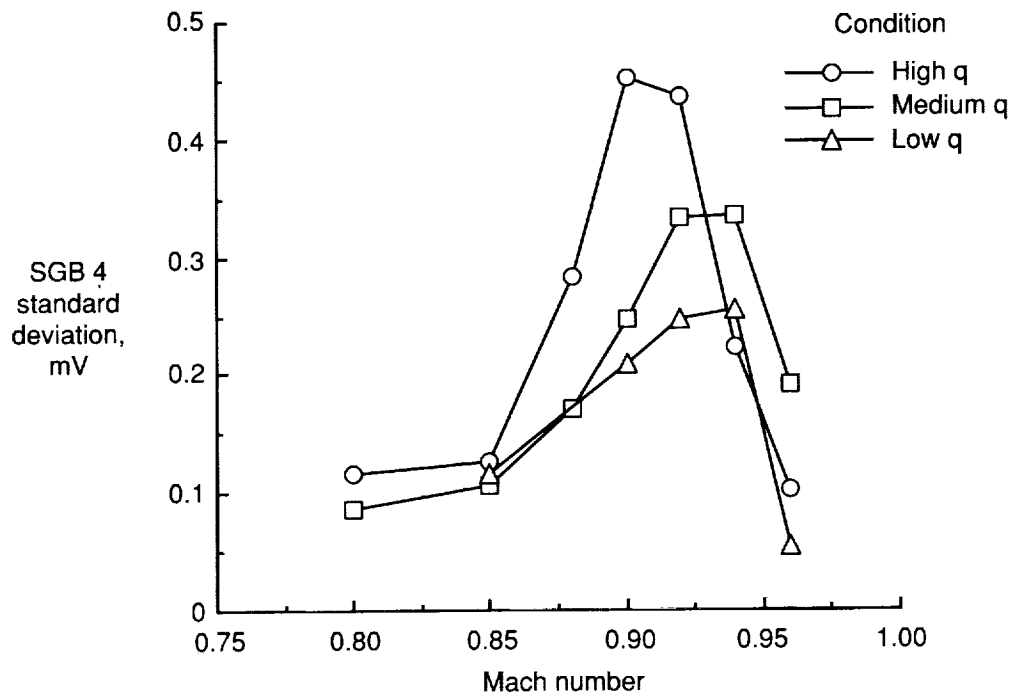
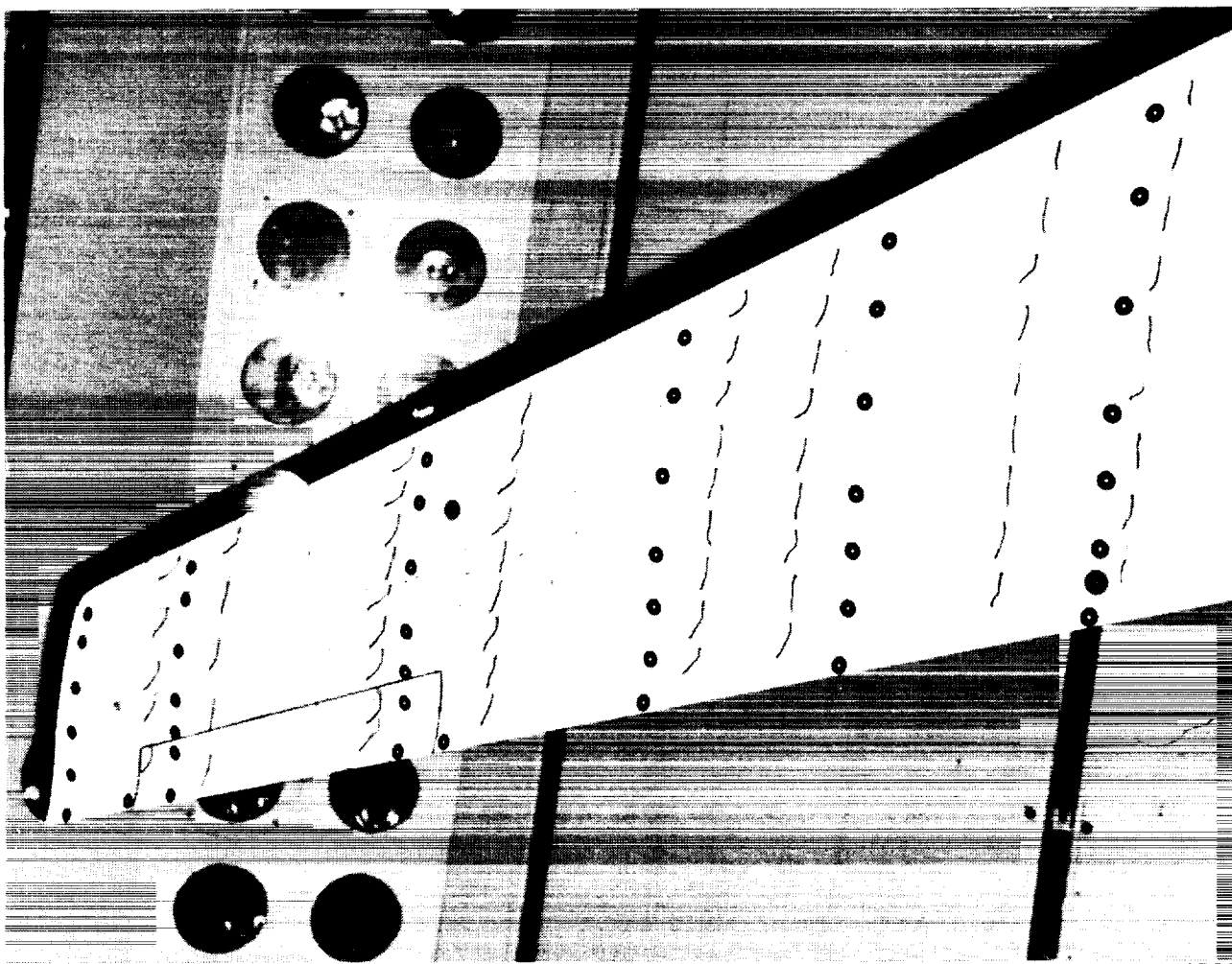

Figure 11. Strain gage bridge 4 standard deviation data.

ORIGINAL PAGE  
BLACK AND WHITE PHOTOGRAPH



I-86-2786

Figure 12. Wool tufts installed on wing lower surface.

M	Upper surface		Lower surface	
	x/c	$\eta$	x/c	$\eta$
0.85				
.88	0.8 to 1.0	0.517 to 0.816		
.90	.7 to 1.0	.517 to .905	0.6 to 1.0	0.635 to 0.761
.92	.7 to 1.0	.517 to .938	.6 to 1.0	.635 to .938
.94	.6 to 1.0	.517 to .938	.5 to 1.0	.635 to .938
.96	.6 to 1.0	.517 to .938	.5 to 1.0	

(a) Region of separated flow.

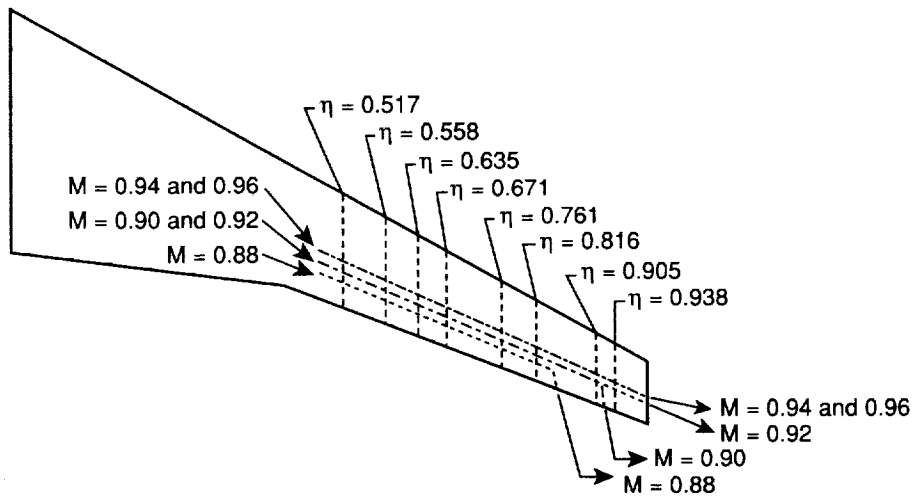

(b) Upper-surface trailing-edge flow separation regions as function of  $M$ .

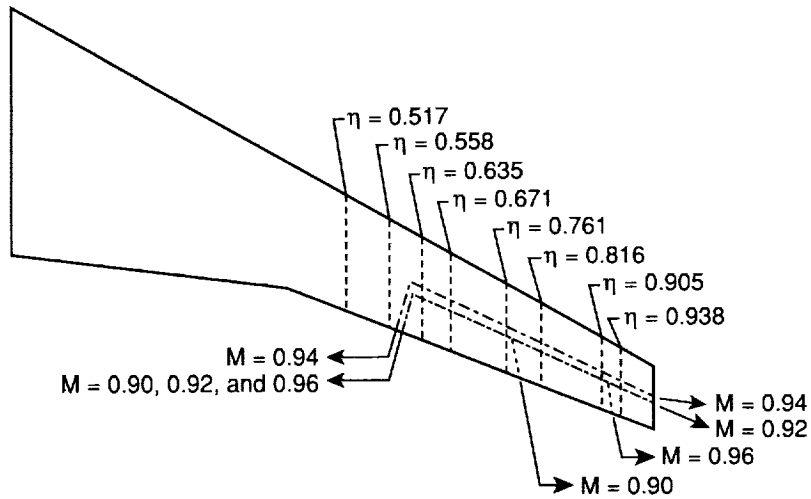

(c) Lower-surface trailing-edge flow separation regions as function of  $M$ .

Figure 13. Separated flow regions shown by wool tufts for medium  $q$  at  $\alpha = 0^\circ$ .

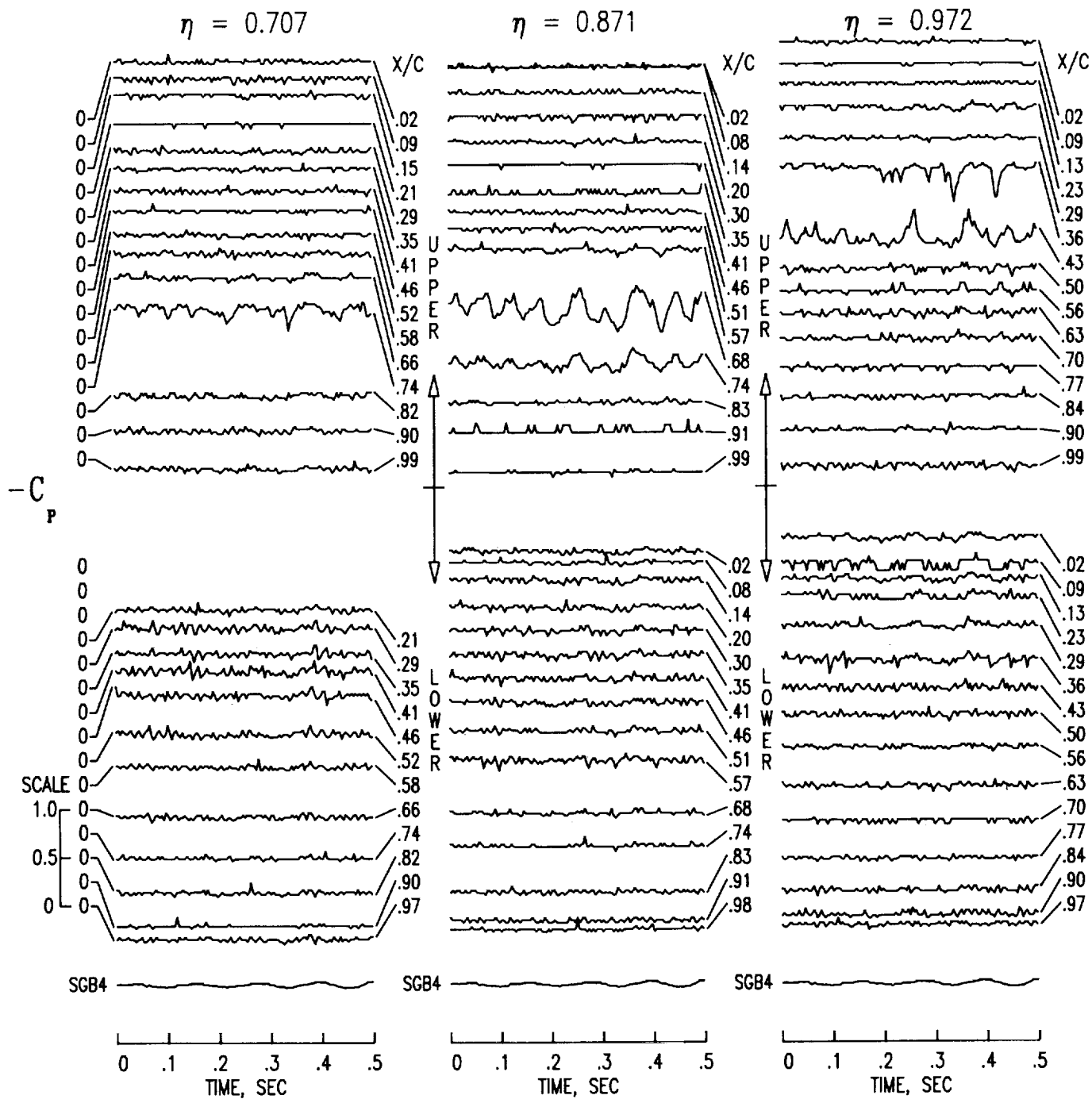

(a) Tab point 43.  $M = 0.85$ ;  $q = 69.4$  psf.

Figure 14.  $C_p$  measurement time histories for low  $q$  conditions at  $\alpha = 0^\circ$ .

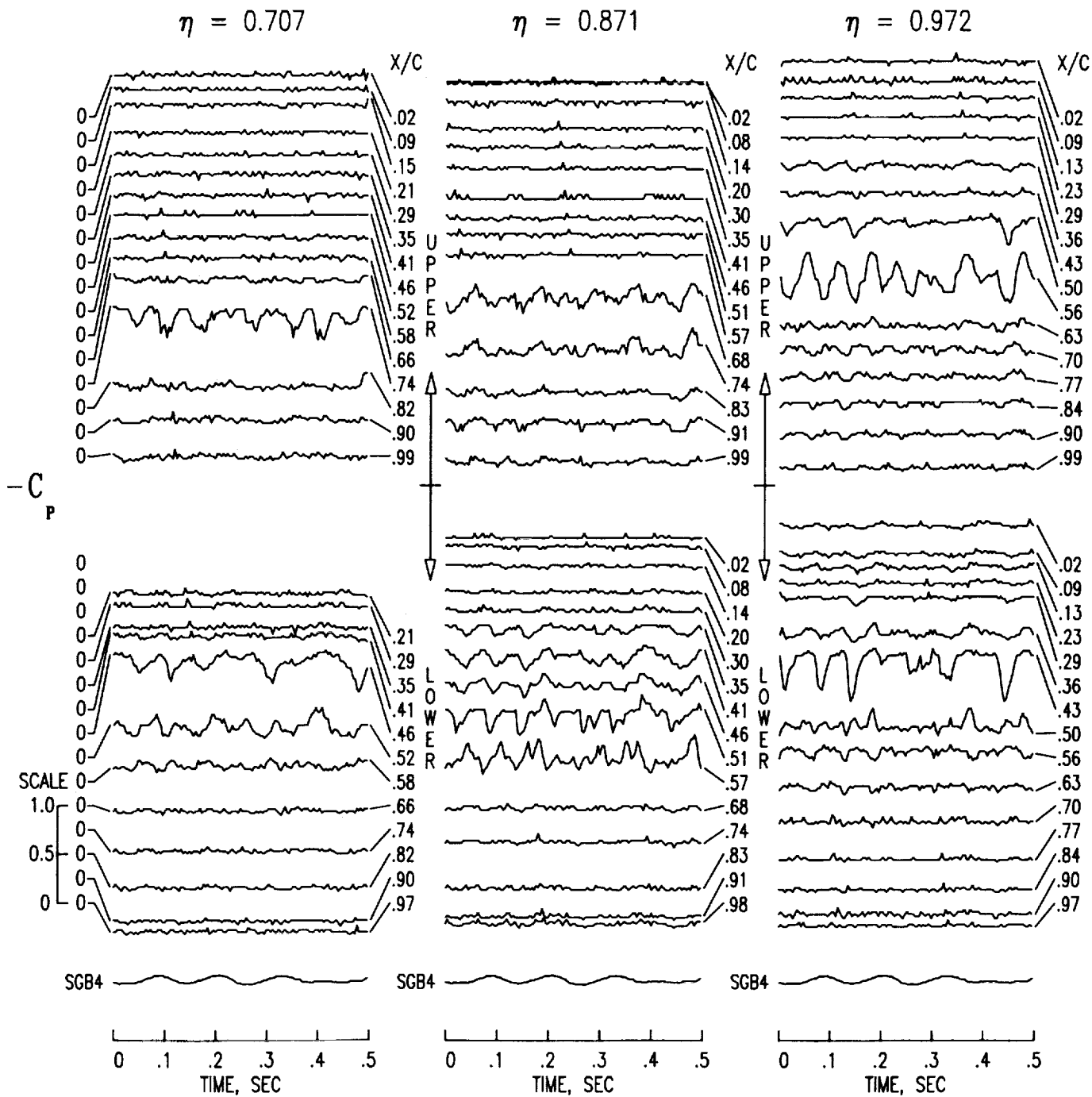

(b) Tab point 47.  $M = 0.90$ ;  $q = 75.7$  psf.

Figure 14. Continued.

1 c-2.



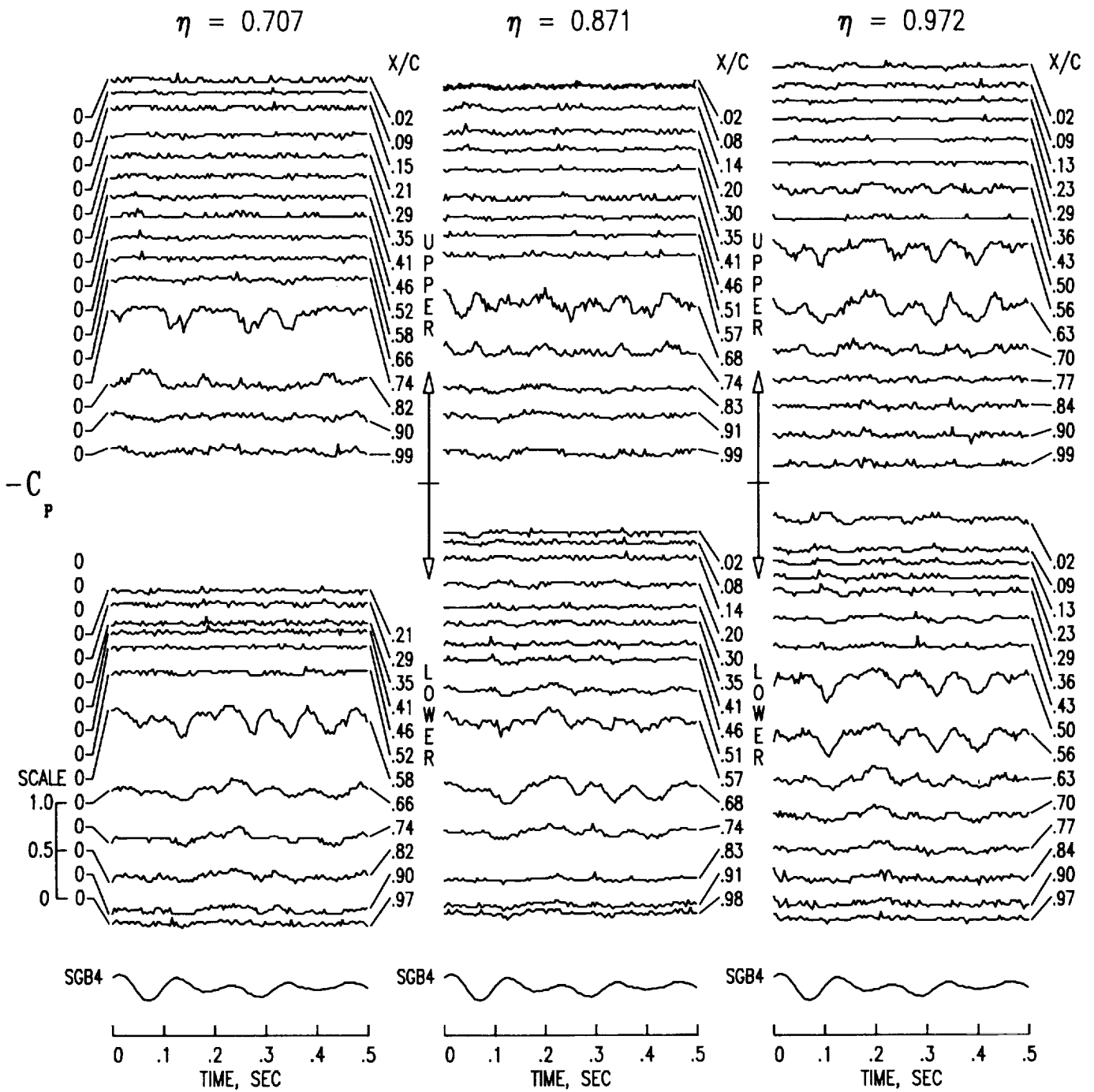

(c) Tab point 51.  $M = 0.92$ ;  $q = 78.5$  psf.

Figure 14. Continued.

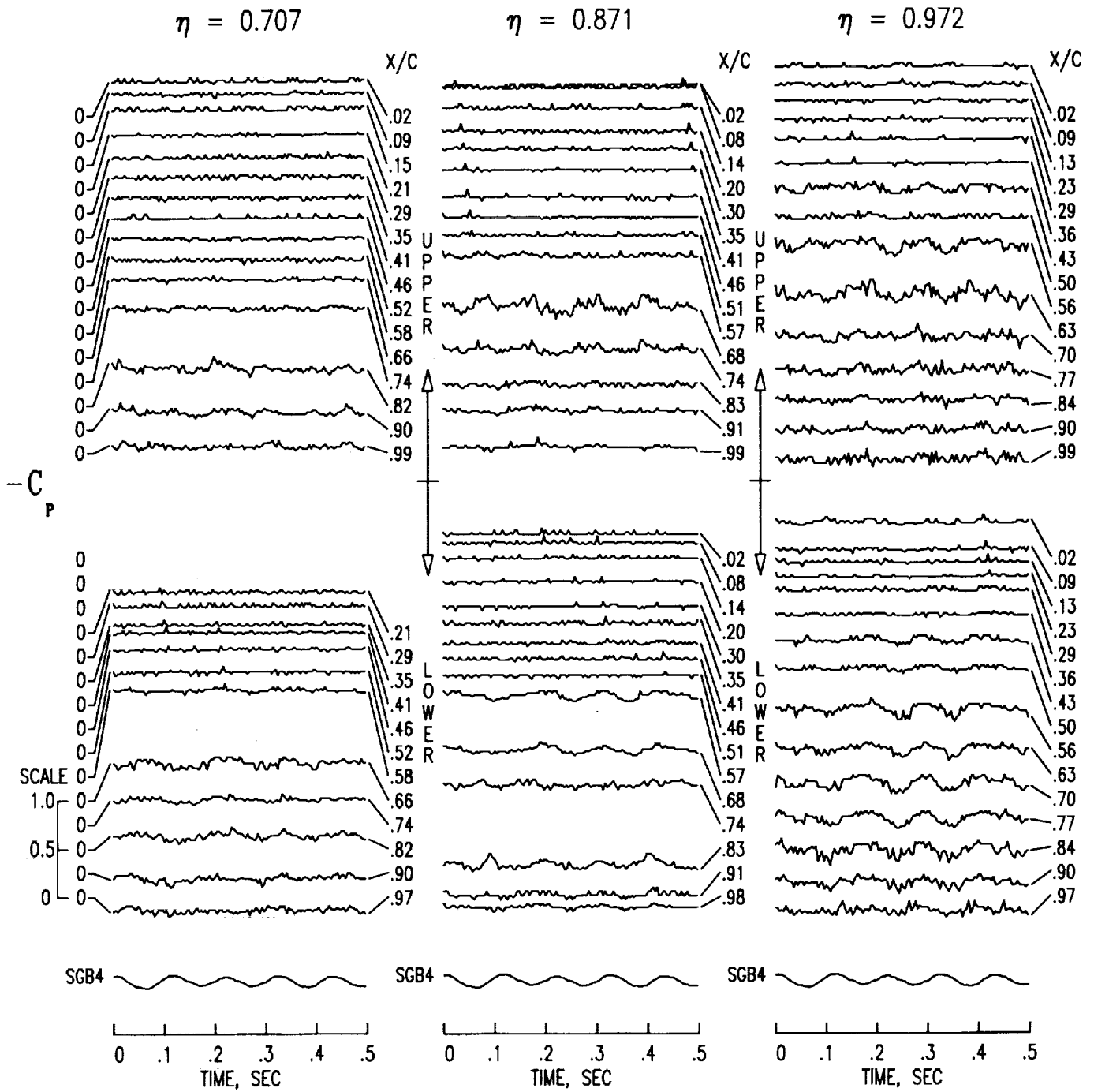

(d) Tab point 52.  $M = 0.94$ ;  $q = 81.1$  psf.

Figure 14. Continued.

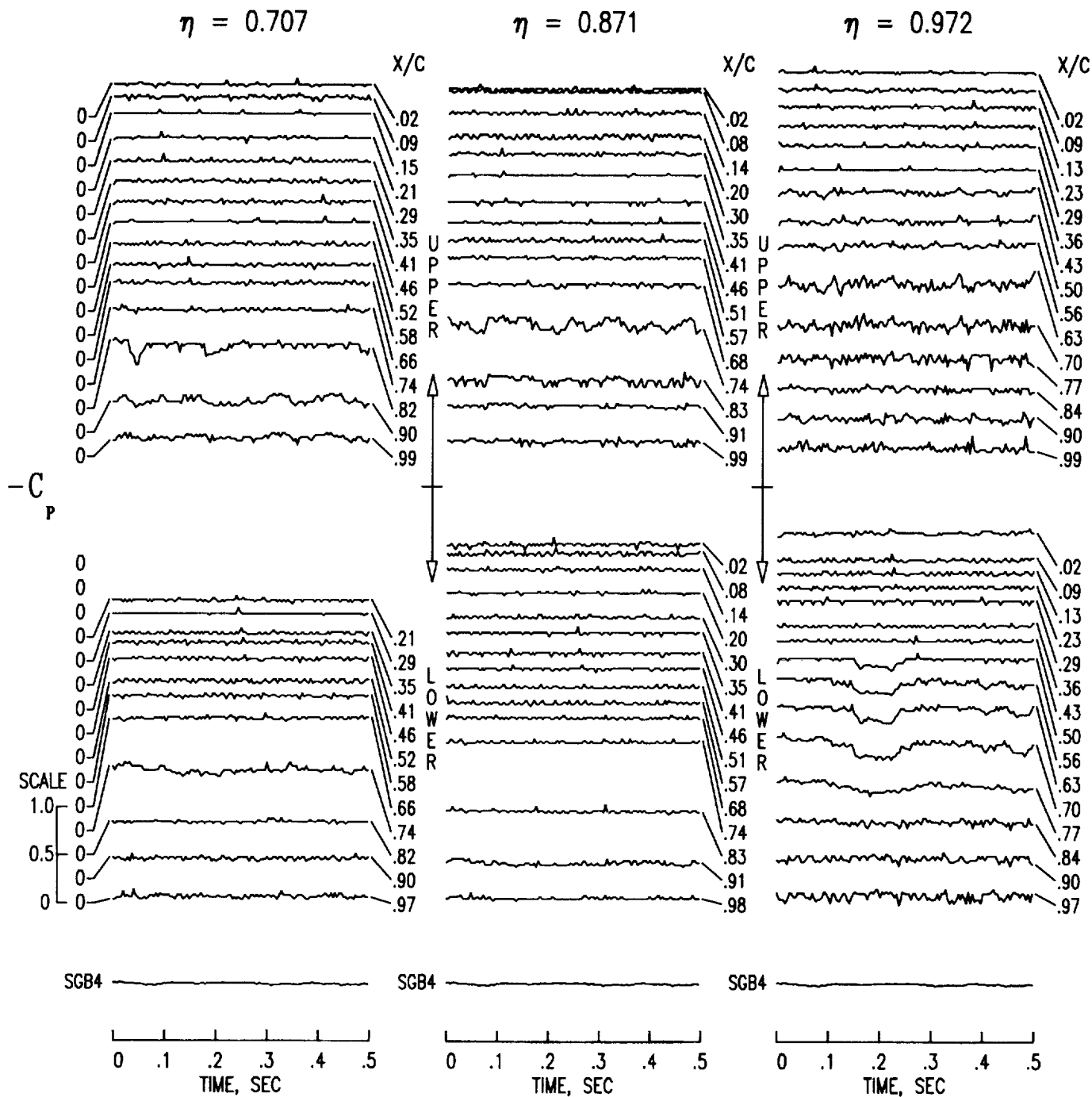

(e) Tab point 53.  $M = 0.96$ ;  $q = 83.5$  psf.

Figure 14. Concluded.

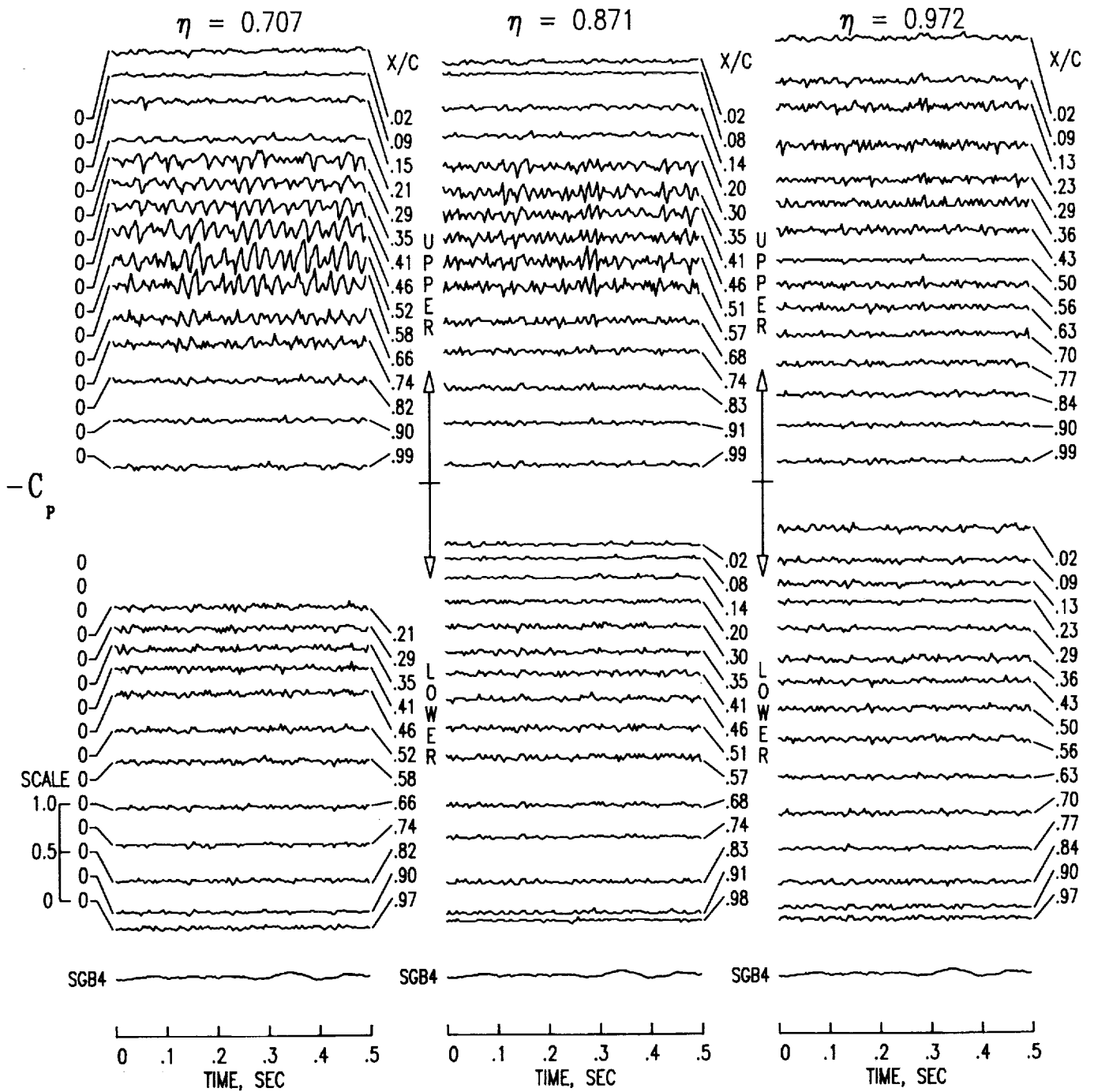

(a) Tab point 91.  $M = 0.80$ ;  $q = 123.6$  psf.

Figure 15.  $C_p$  measurement time histories for medium  $q$  conditions at  $\alpha = 0^\circ$ .

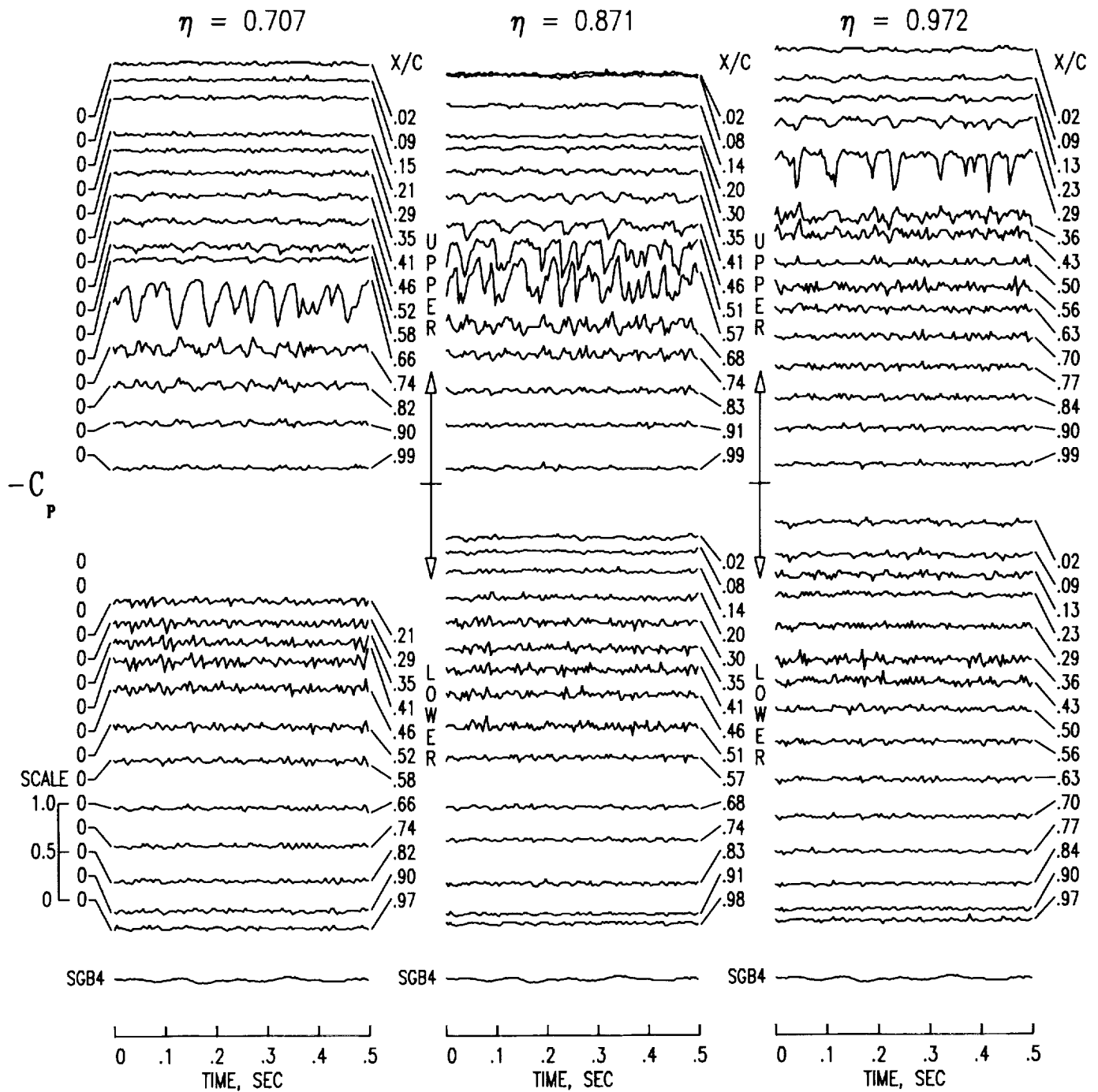

(b) Tab point 92.  $M = 0.85$ ;  $q = 135.3$  psf.

Figure 15. Continued.

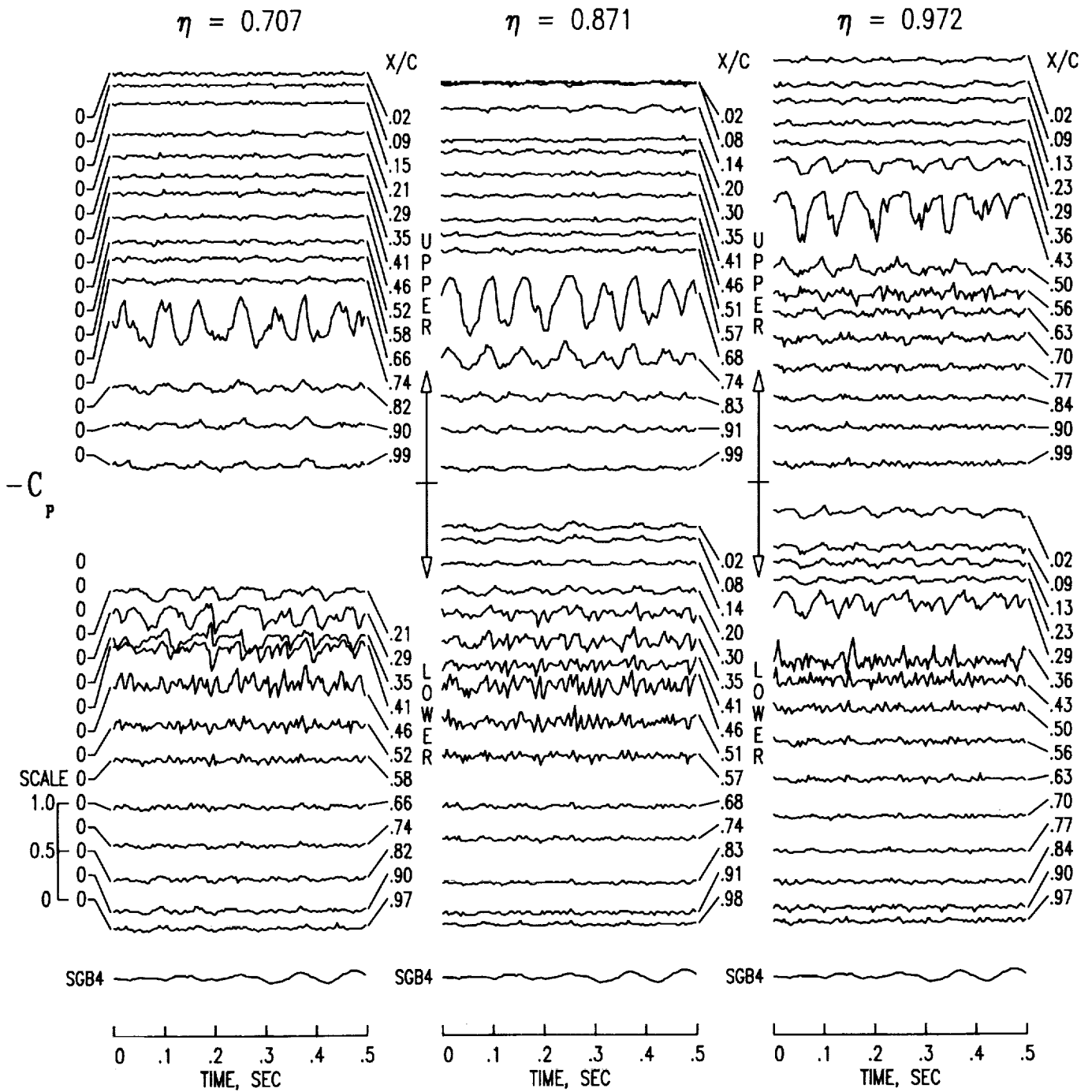

(c) Tab point 94.  $M = 0.88$ ;  $q = 143.0$  psf.

Figure 15. Continued.

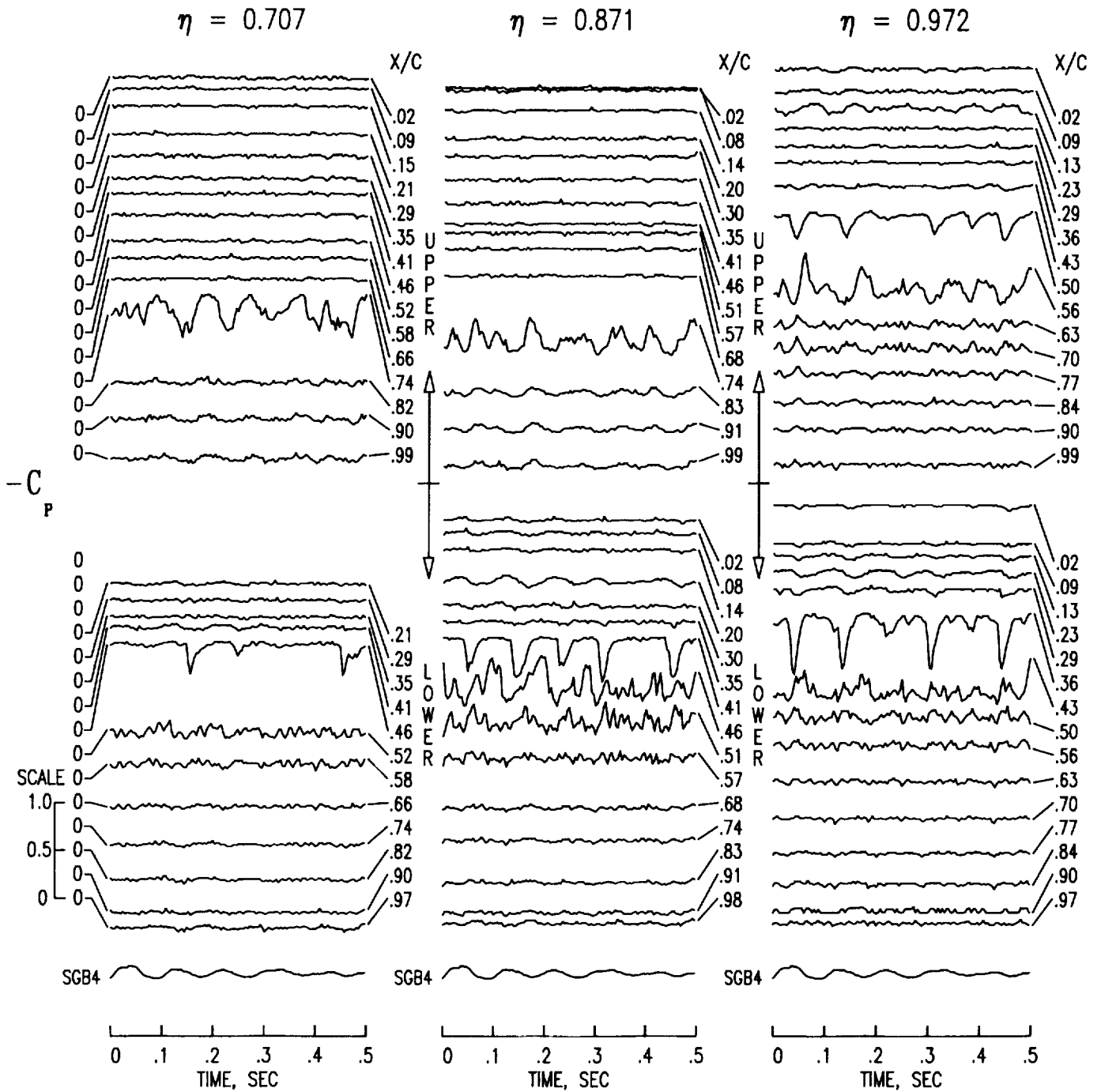

(d) Tab point 96.  $M = 0.90$ ;  $q = 148.0$  psf.

Figure 15. Continued.

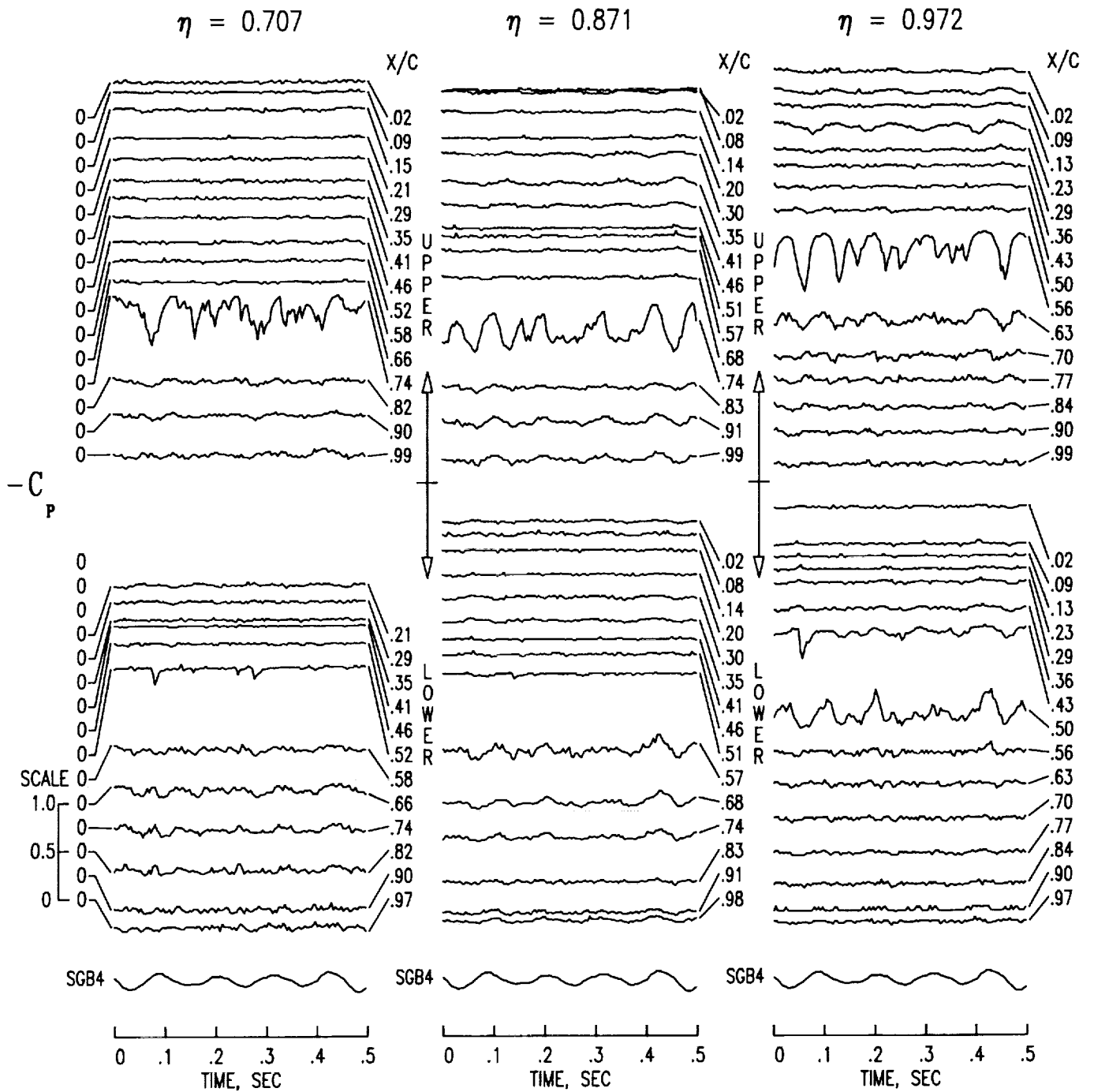

(c) Tab point 98.  $M = 0.92$ ;  $q = 152.5$  psf.

Figure 15. Continued.



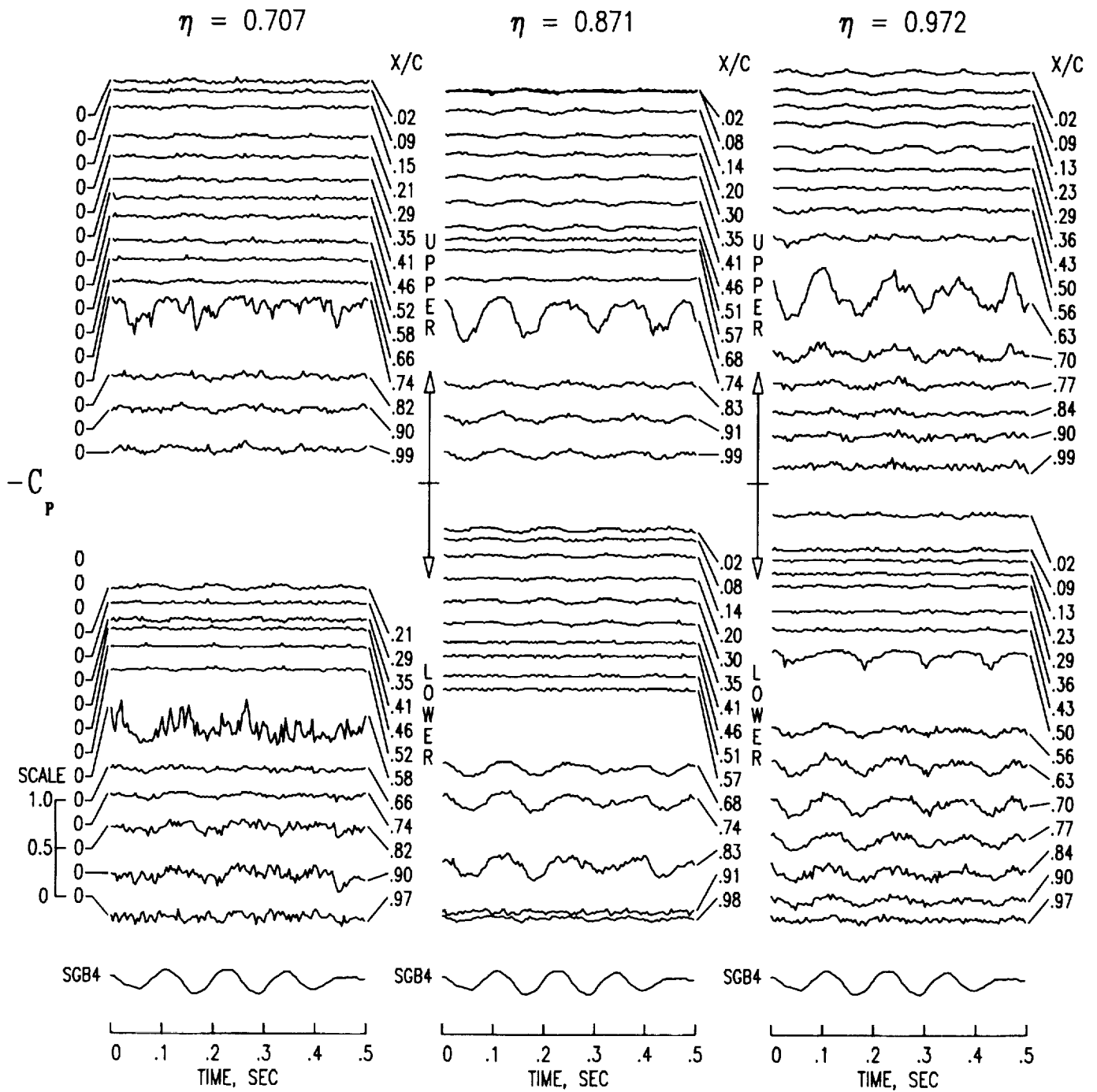

(f) Tab point 100.  $M = 0.94$ ;  $q = 157.0$  psf.

Figure 15. Continued.

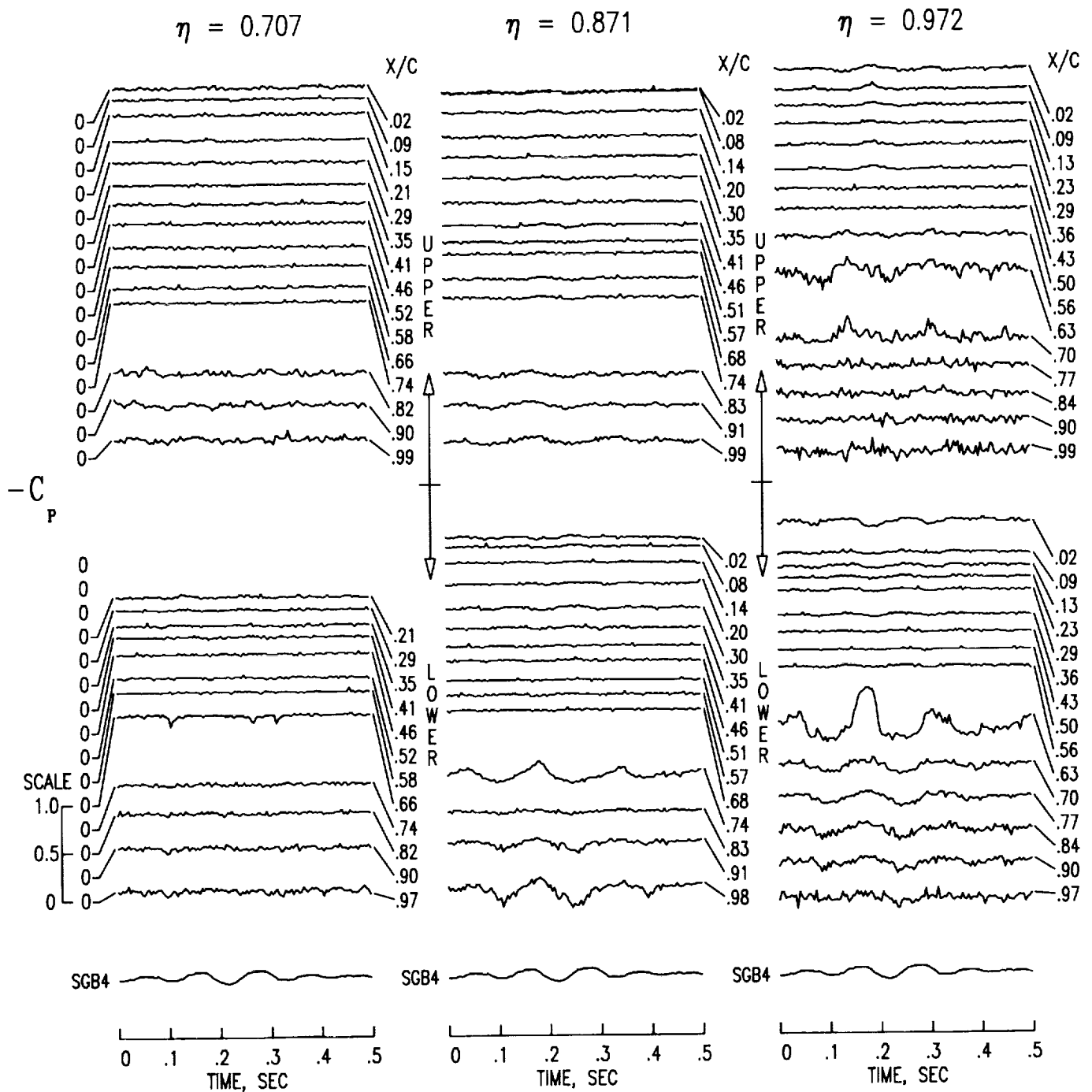

(g) Tab point 101.  $M = 0.96$ ;  $q = 161.7$  psf.

Figure 15. Concluded.

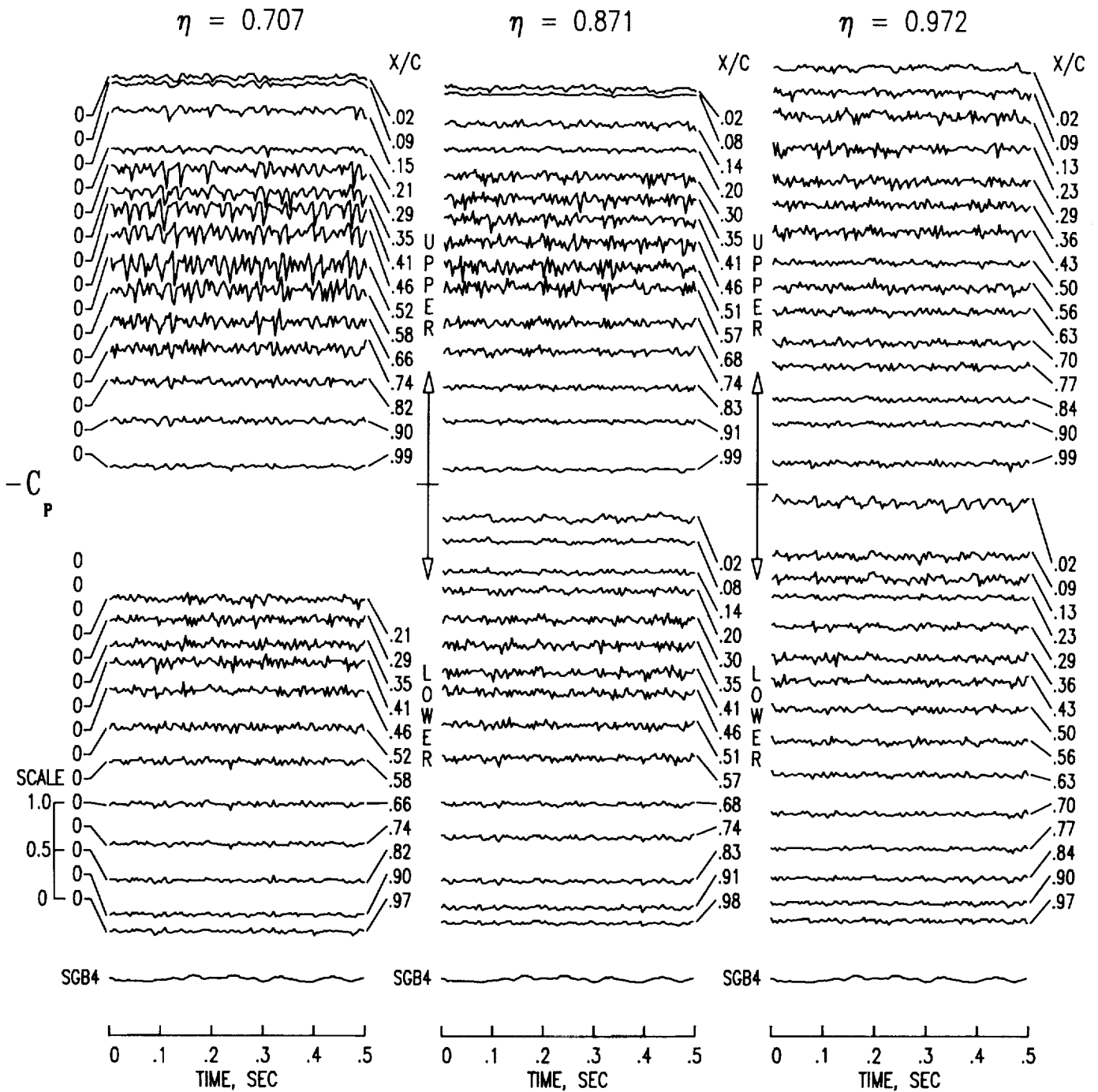

(a) Tab point 195.  $M = 0.80$ ;  $q = 260.2$  psf.

Figure 16.  $C_p$  measurement time histories for high  $q$  conditions at  $\alpha = 0^\circ$ .

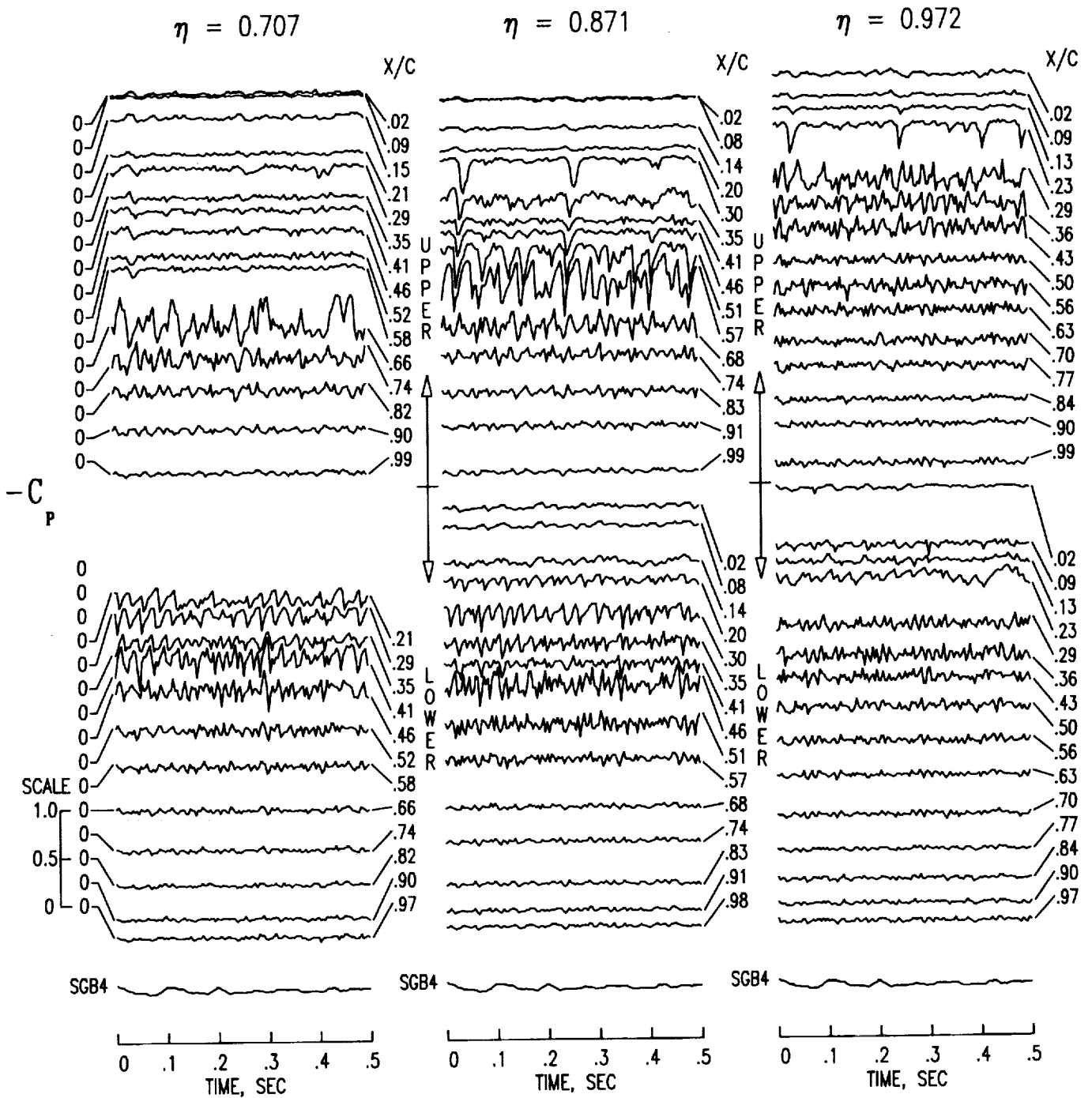

(b) Tab point 196.  $M = 0.85$ ;  $q = 283.4$  psf.

Figure 16. Continued.

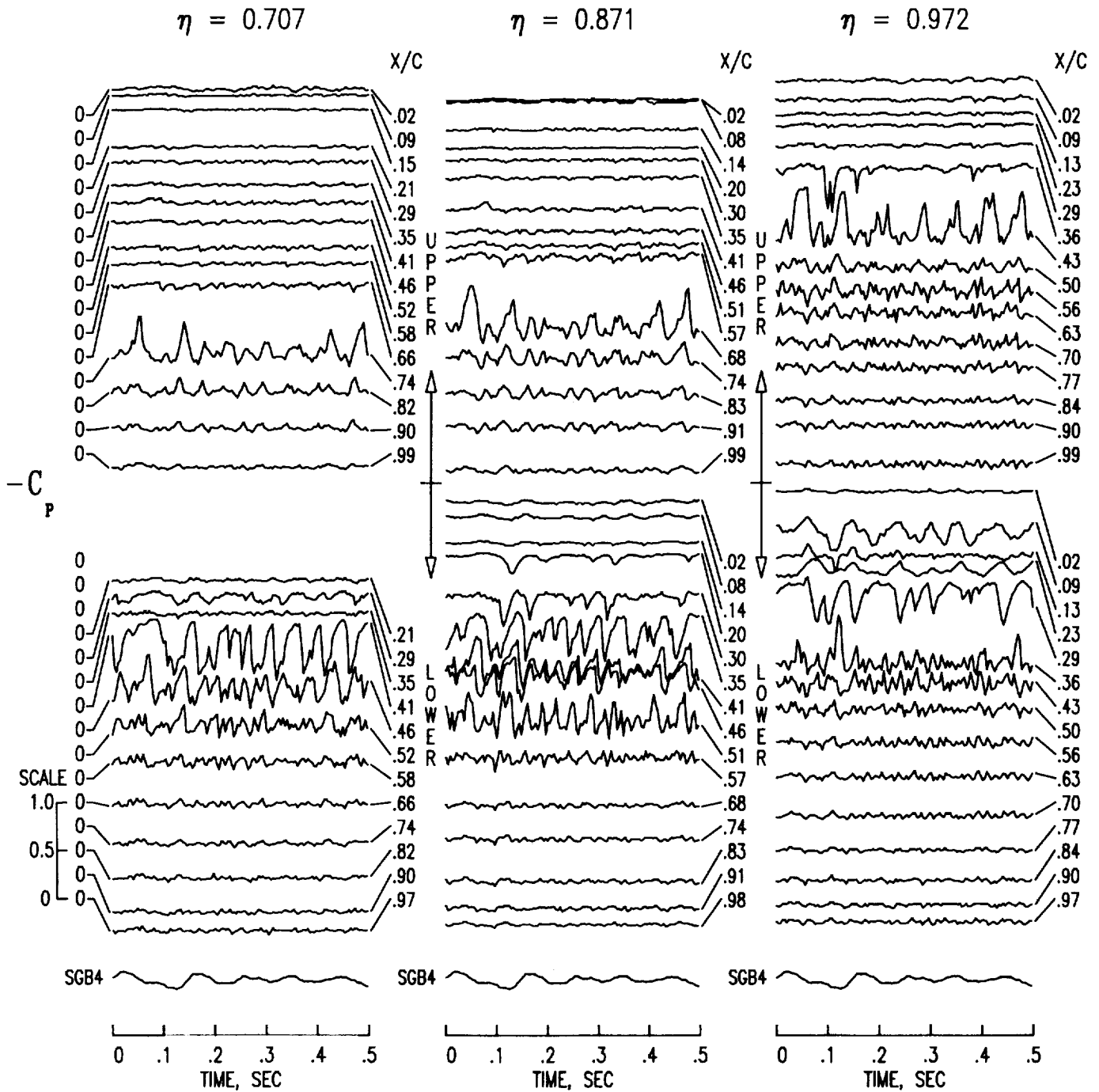

(c) Tab point 197.  $M = 0.88$ ;  $q = 297.9$  psf.

Figure 16. Continued.

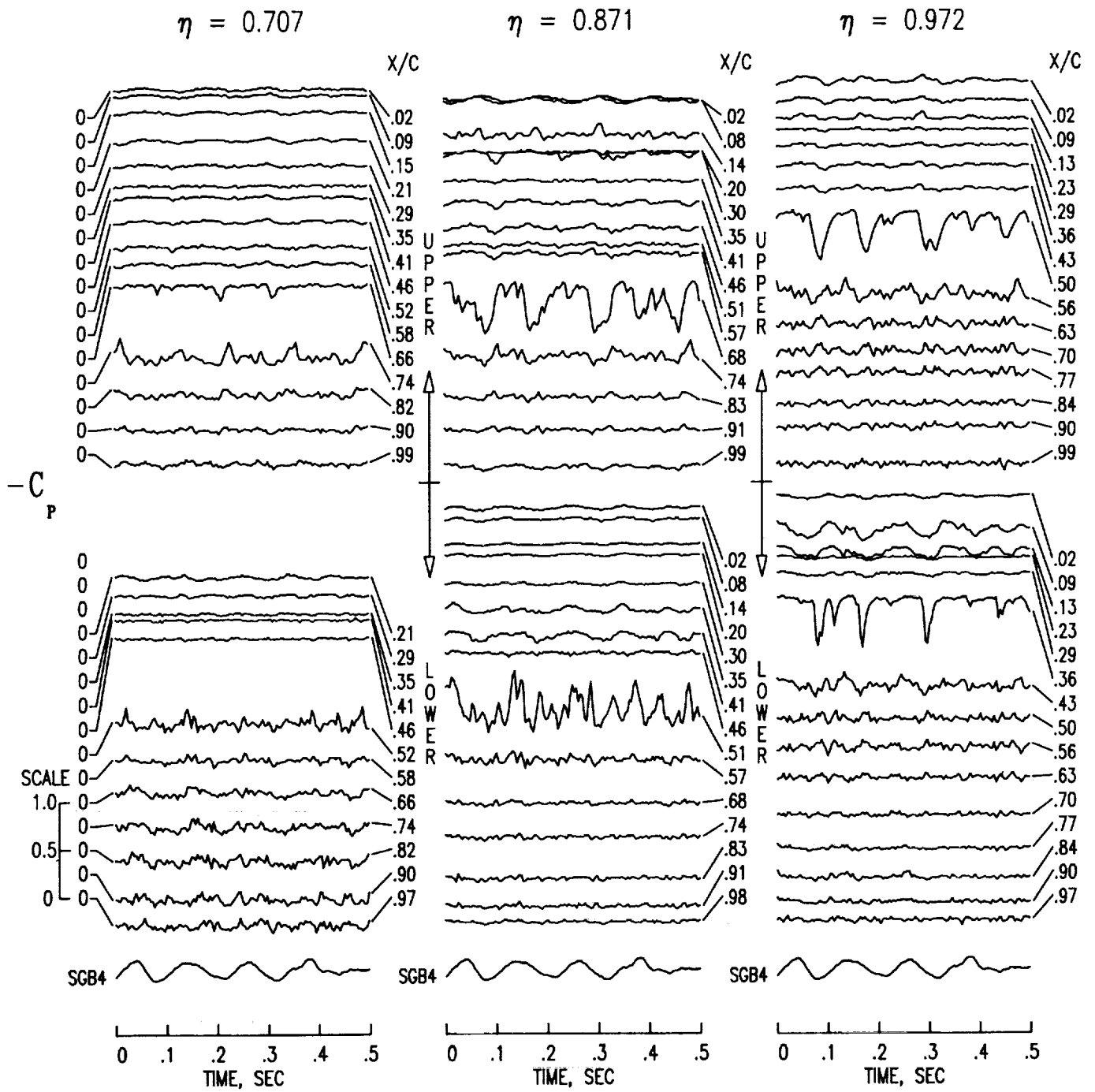

(d) Tab point 199.  $M = 0.90$ ;  $q = 308.6$  psf.

Figure 16. Continued.

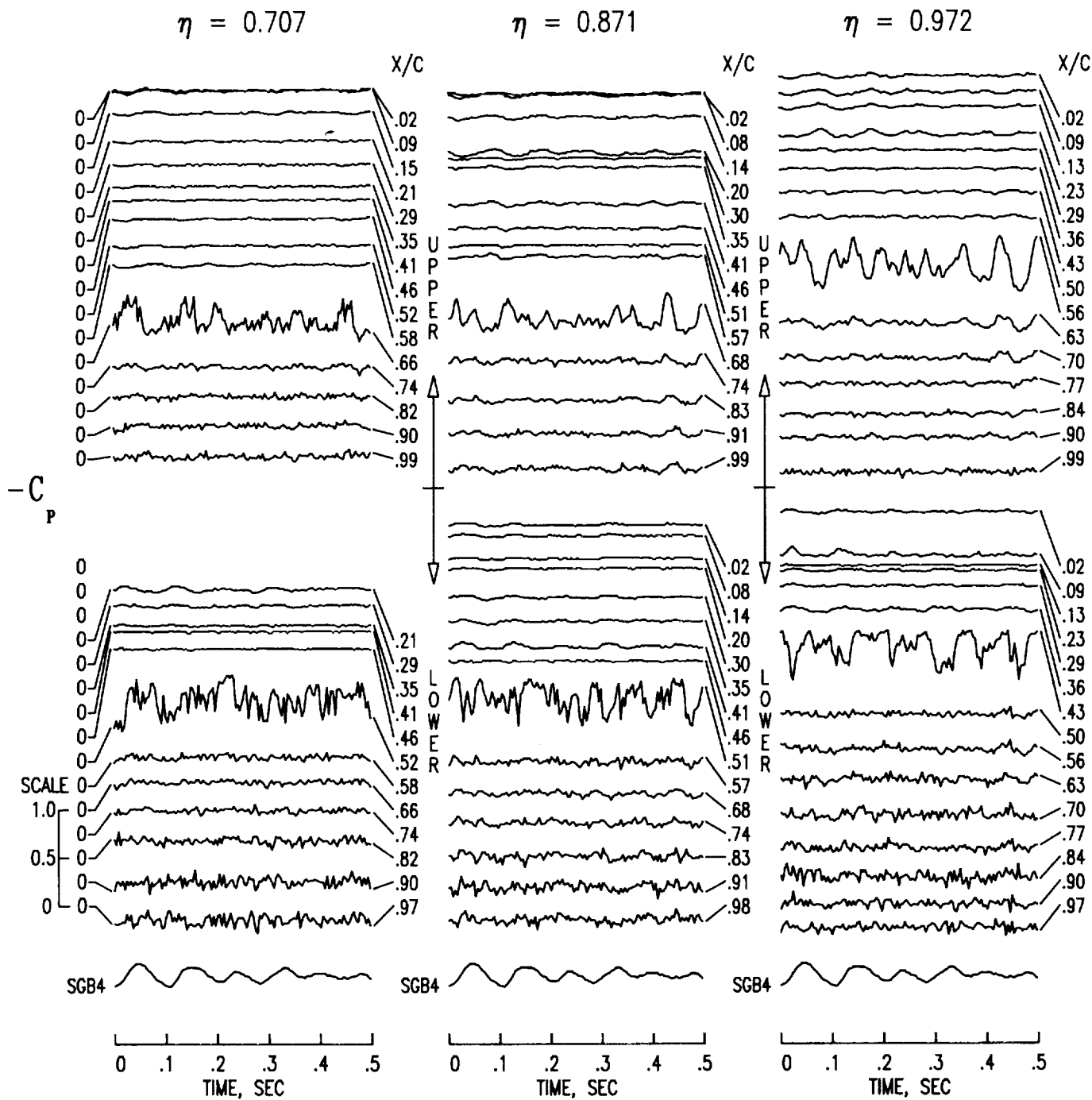

(e) Tab point 202.  $M = 0.92$ ;  $q = 317.8$  psf.

Figure 16. Continued.

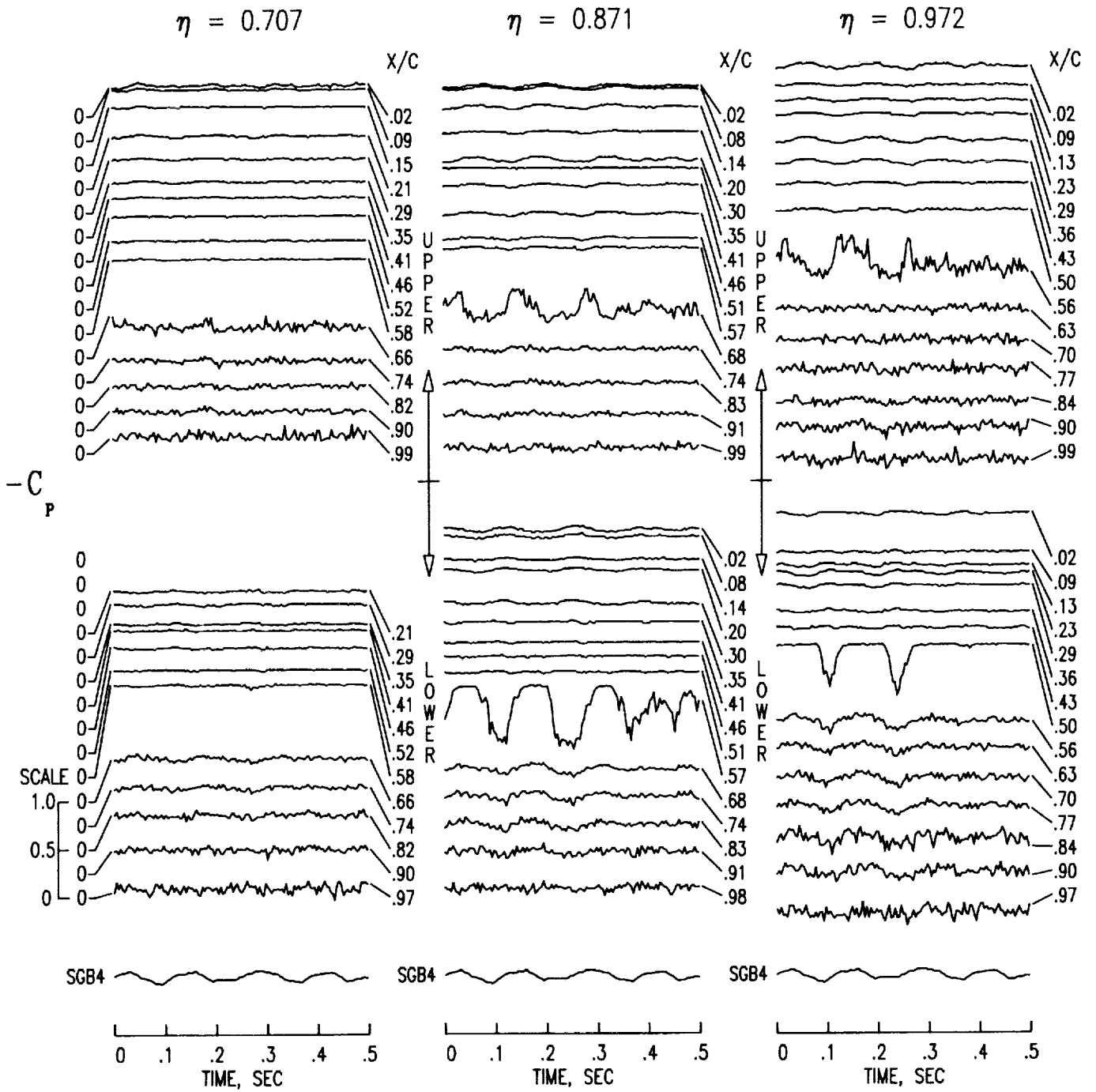

(f) Tab point 204.  $M = 0.94$ ;  $q = 328.3$  psf.

Figure 16. Continued.



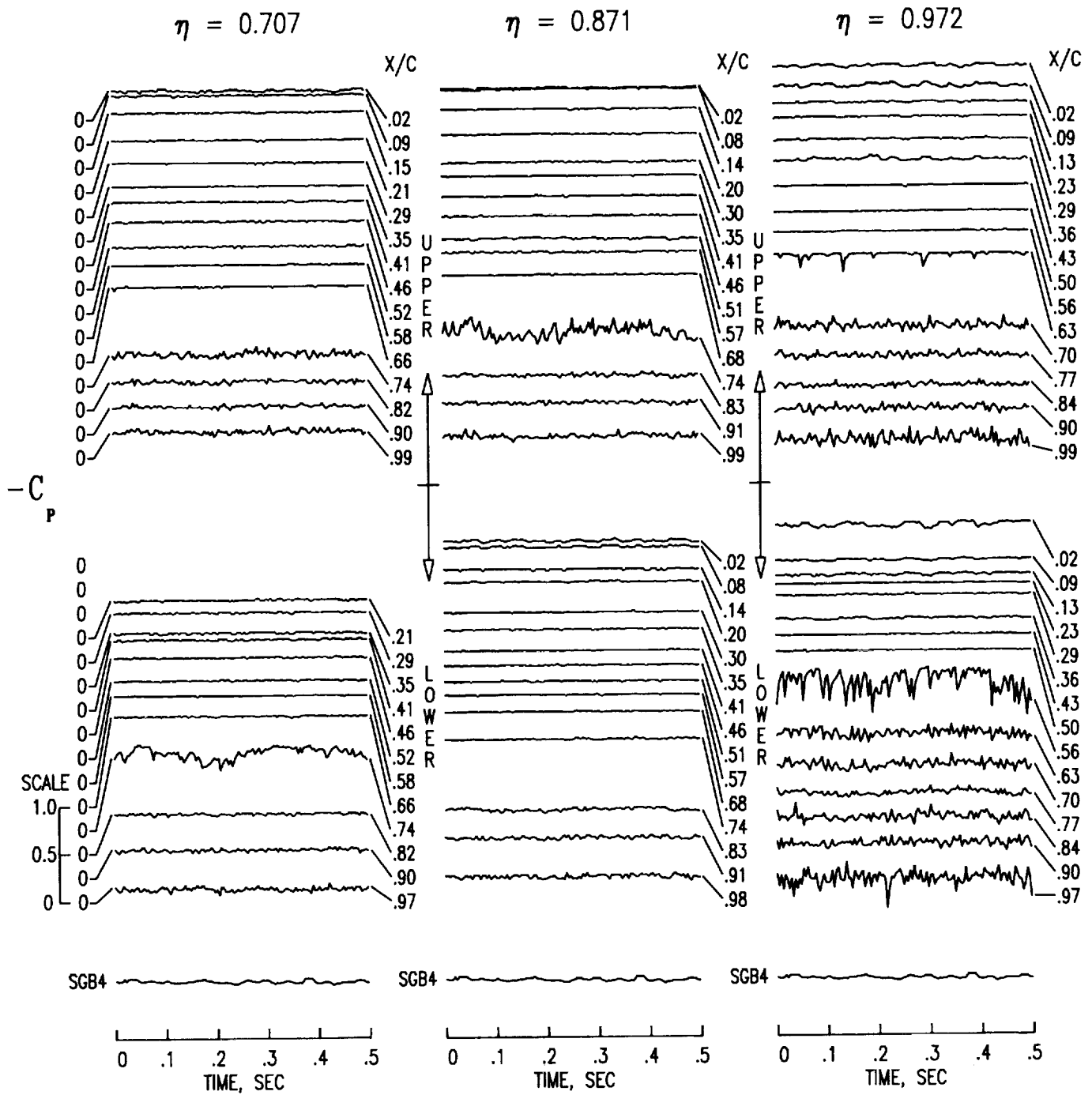

(g) Tab point 205.  $M = 0.96$ ;  $q = 336.7$  psf.

Figure 16. Concluded.

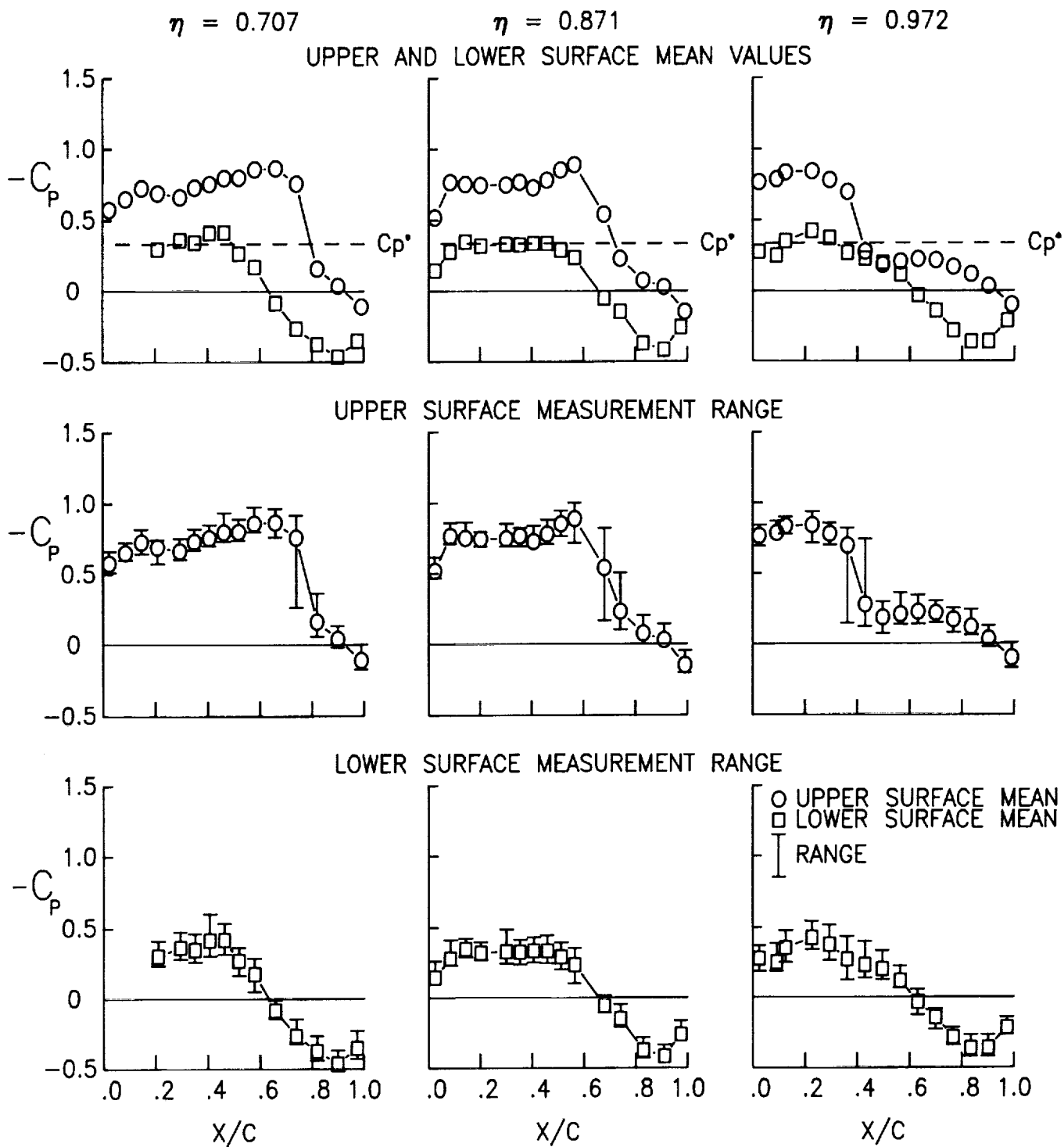

(a) Tab point 43.  $M = 0.85$ ;  $q = 69.4$  psf.

Figure 17. Chordwise pressure distribution data for low  $q$  conditions at  $\alpha = 0^\circ$ .

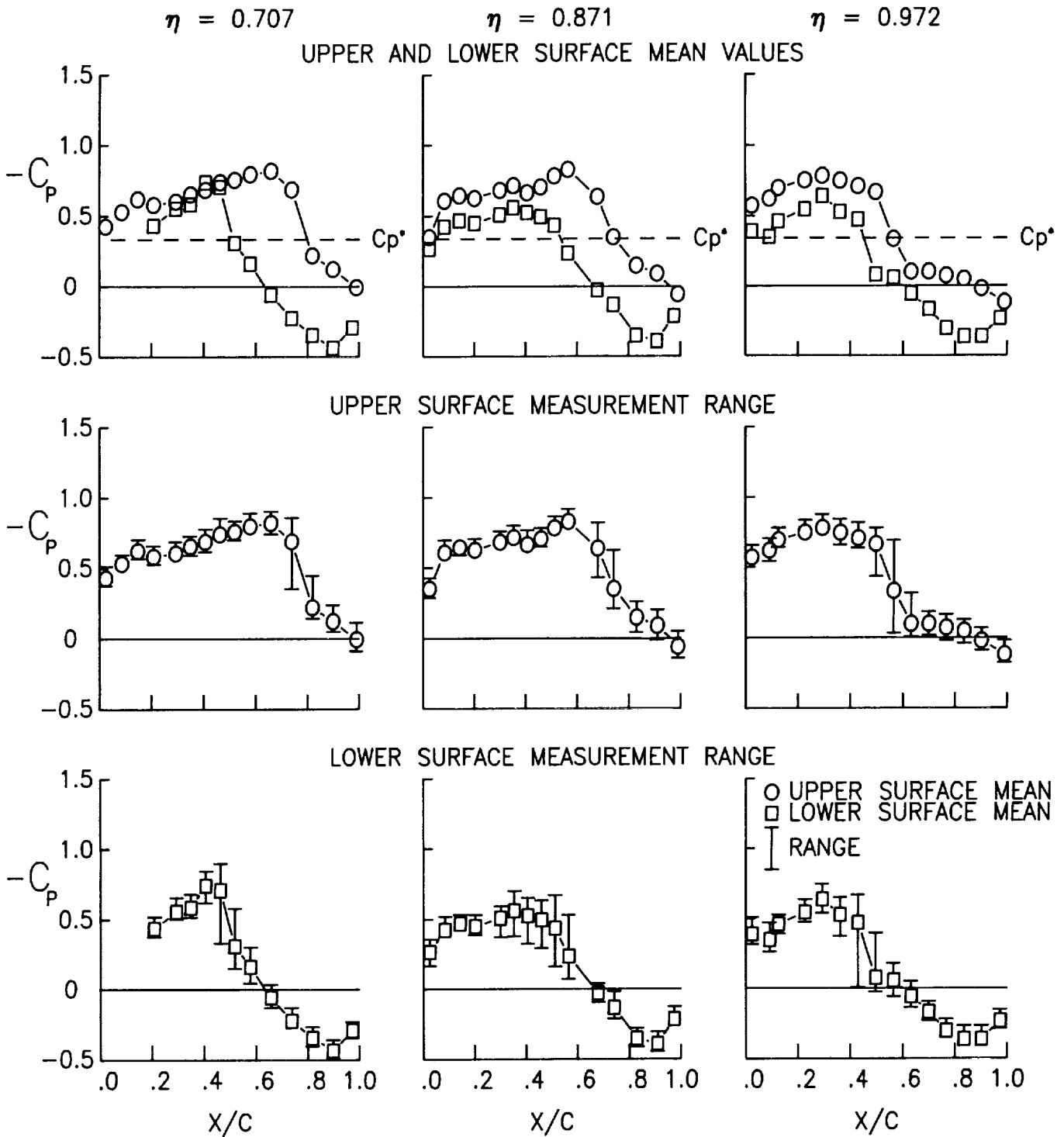

(b) Tab point 47.  $M = 0.90$ ;  $q = 75.7$  psf.

Figure 17. Continued.

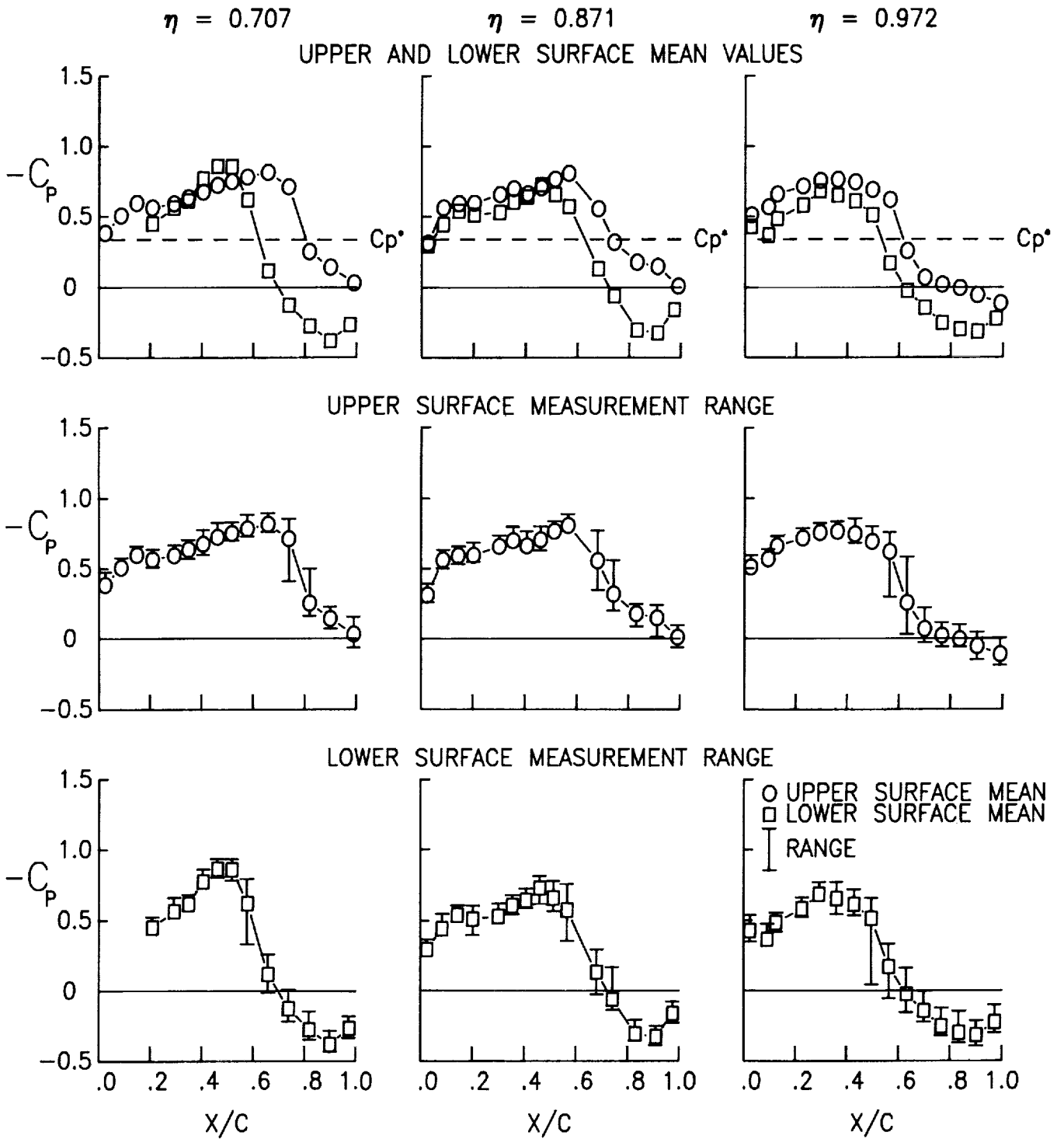

(c) Tab point 51.  $M = 0.92$ ;  $q = 78.5$  psf.

Figure 17. Continued.

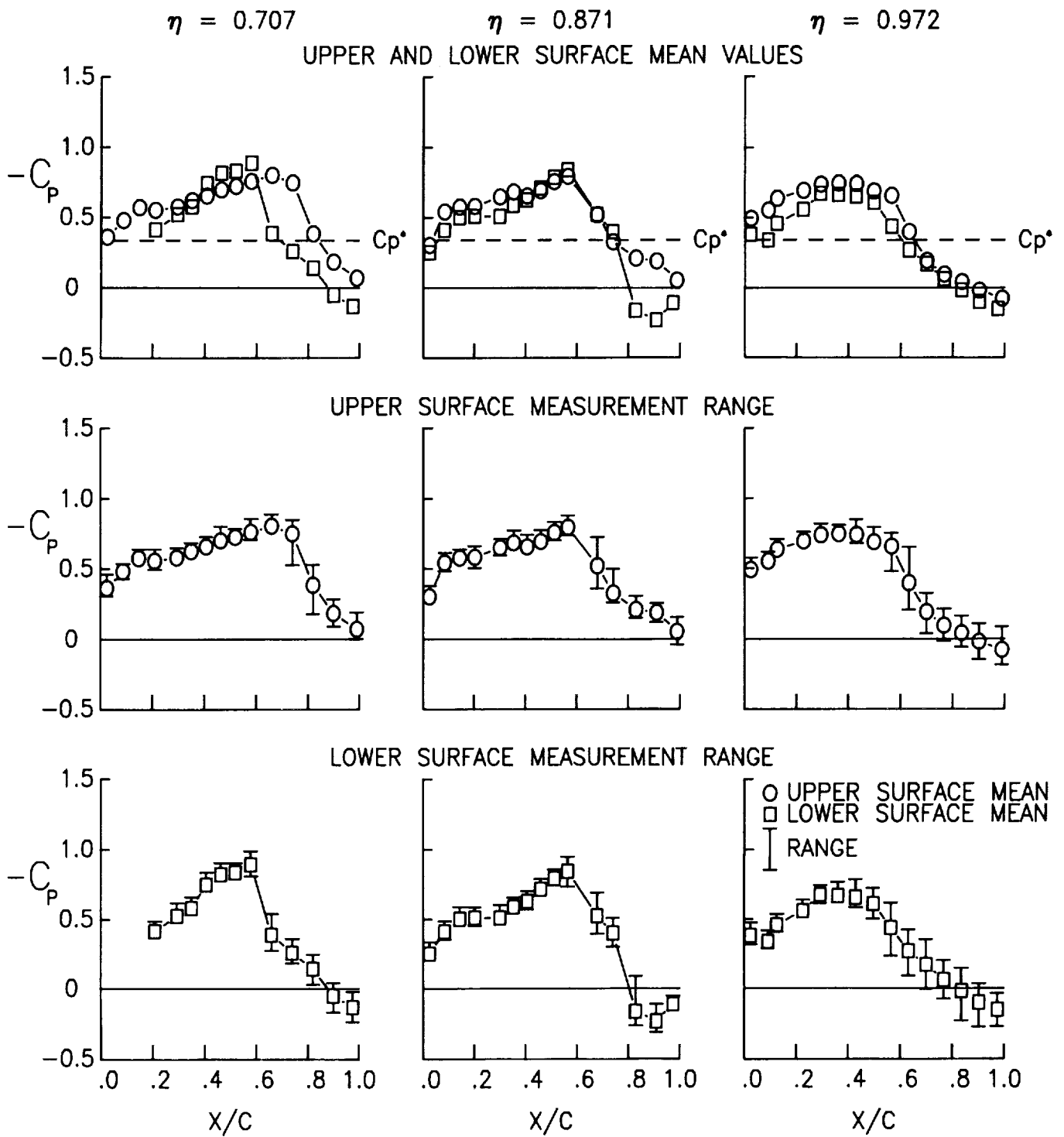

(d) Tab point 52.  $M = 0.94$ ;  $q = 81.1$  psf.

Figure 17. Continued.

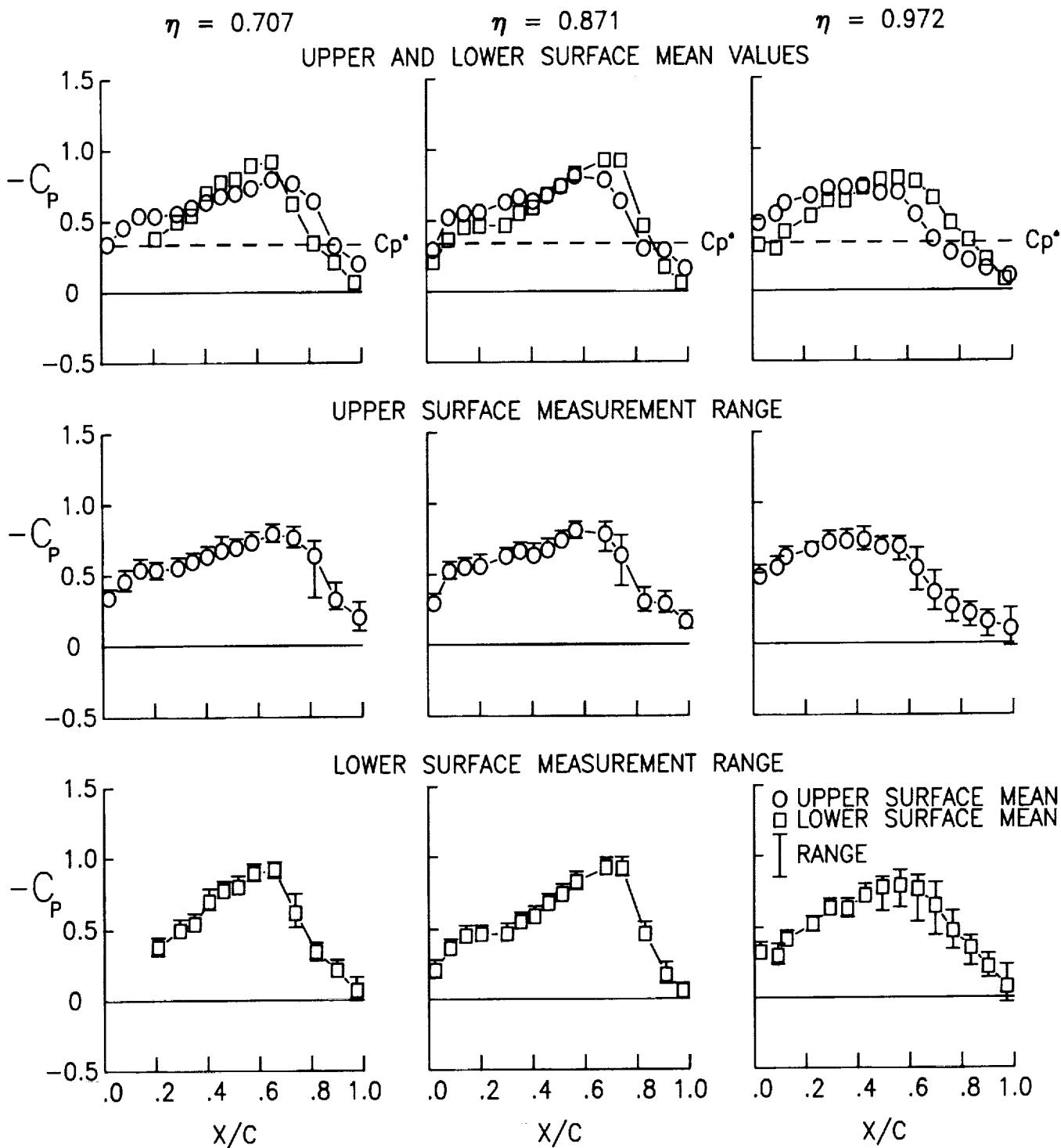

(e) Tab point 53.  $M = 0.96$ ;  $q = 83.5$  psf.

Figure 17. Concluded.

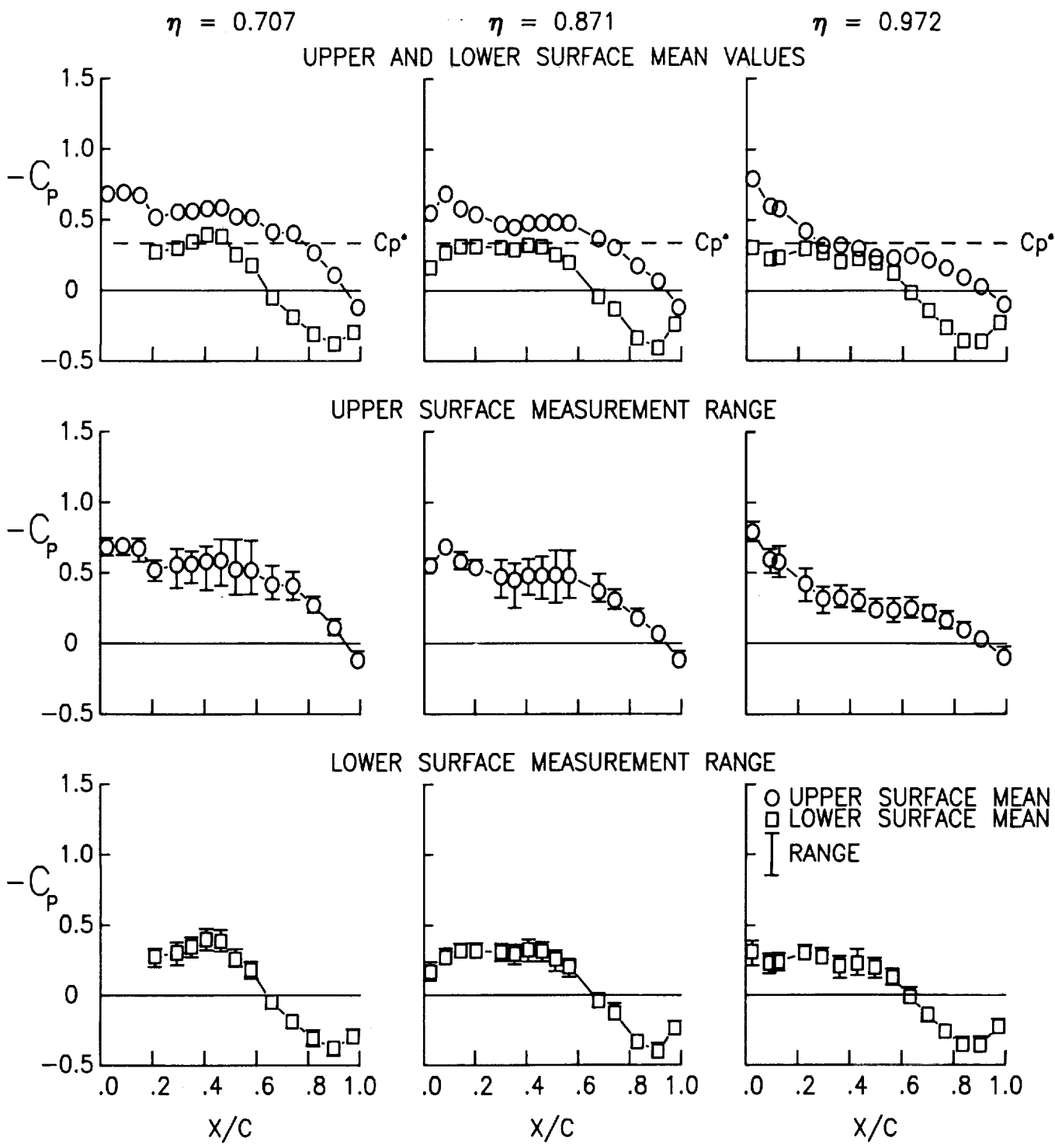

(a) Tab point 91.  $M = 0.80$ ;  $q = 123.6$  psf.

Figure 18. Chordwise pressure distribution data for medium  $q$  conditions at  $\alpha = 0^\circ$ .

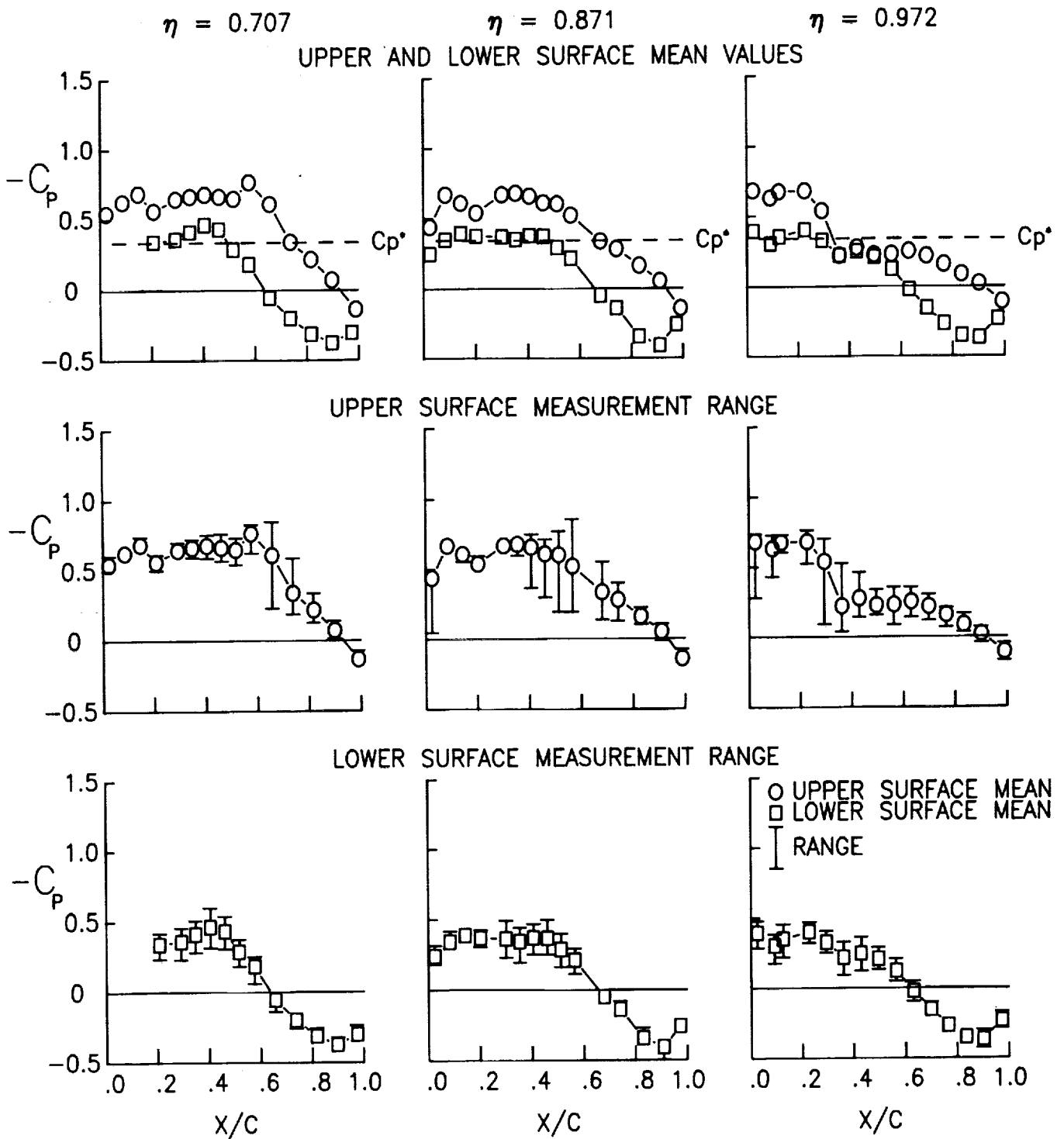

(b) Tab point 92.  $M = 0.85$ ;  $q = 135.3$  psf.

Figure 18. Continued.



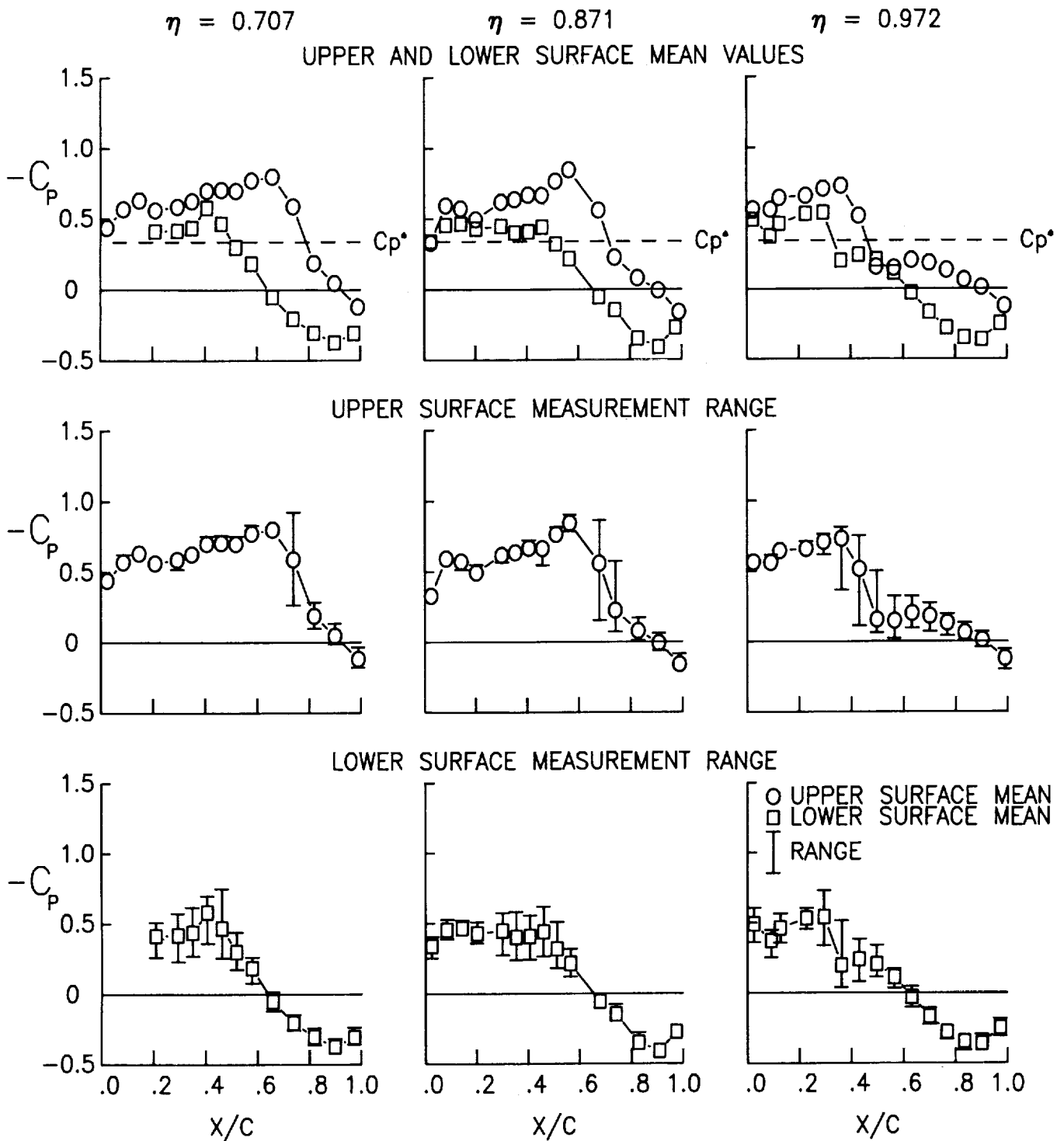

(c) Tab point 94.  $M = 0.88$ ;  $q = 143.0$  psf.

Figure 18. Continued.

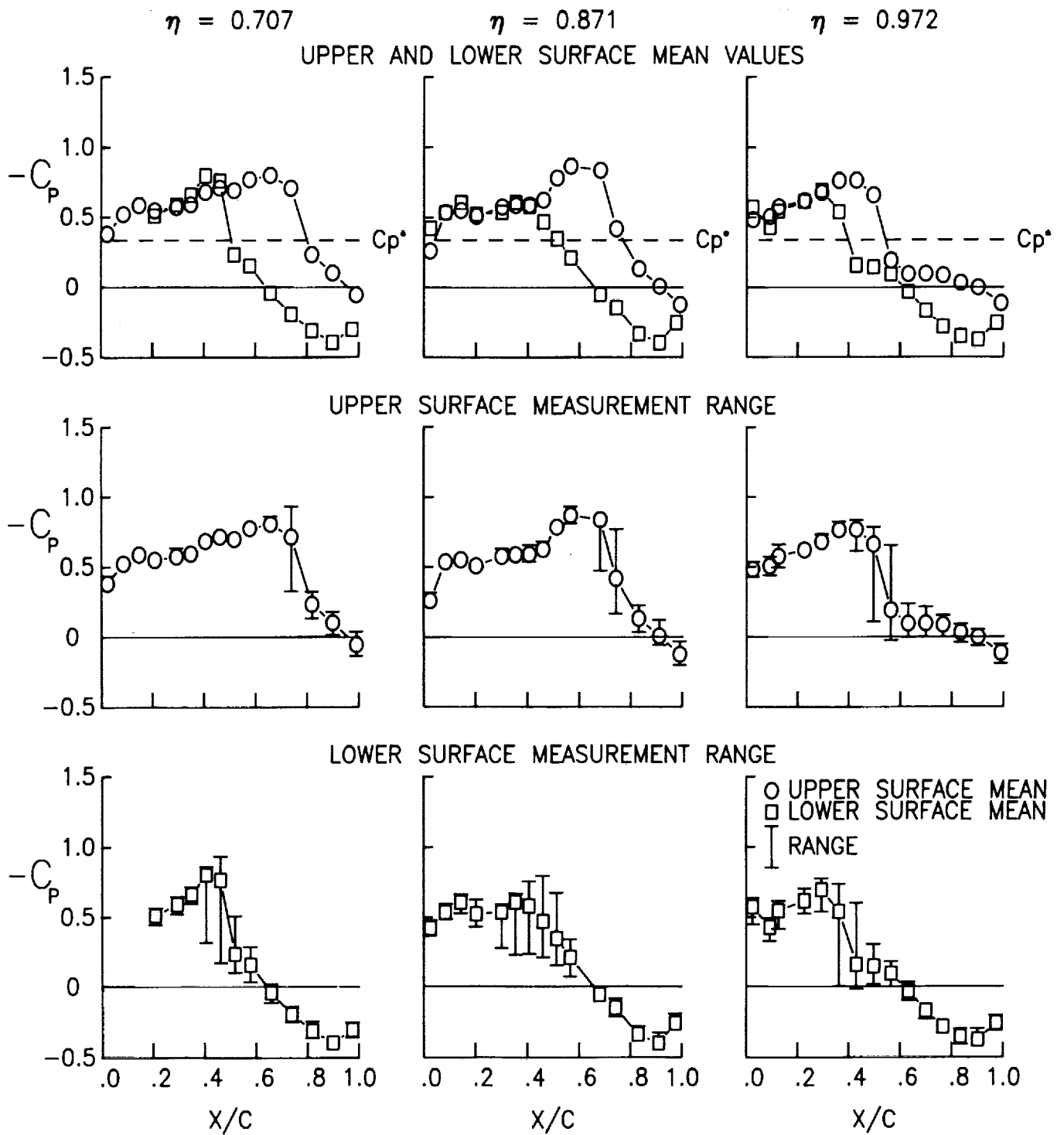

(d) Tab point 96.  $M = 0.90$ ;  $q = 148.0$  psf.

Figure 18. Continued.

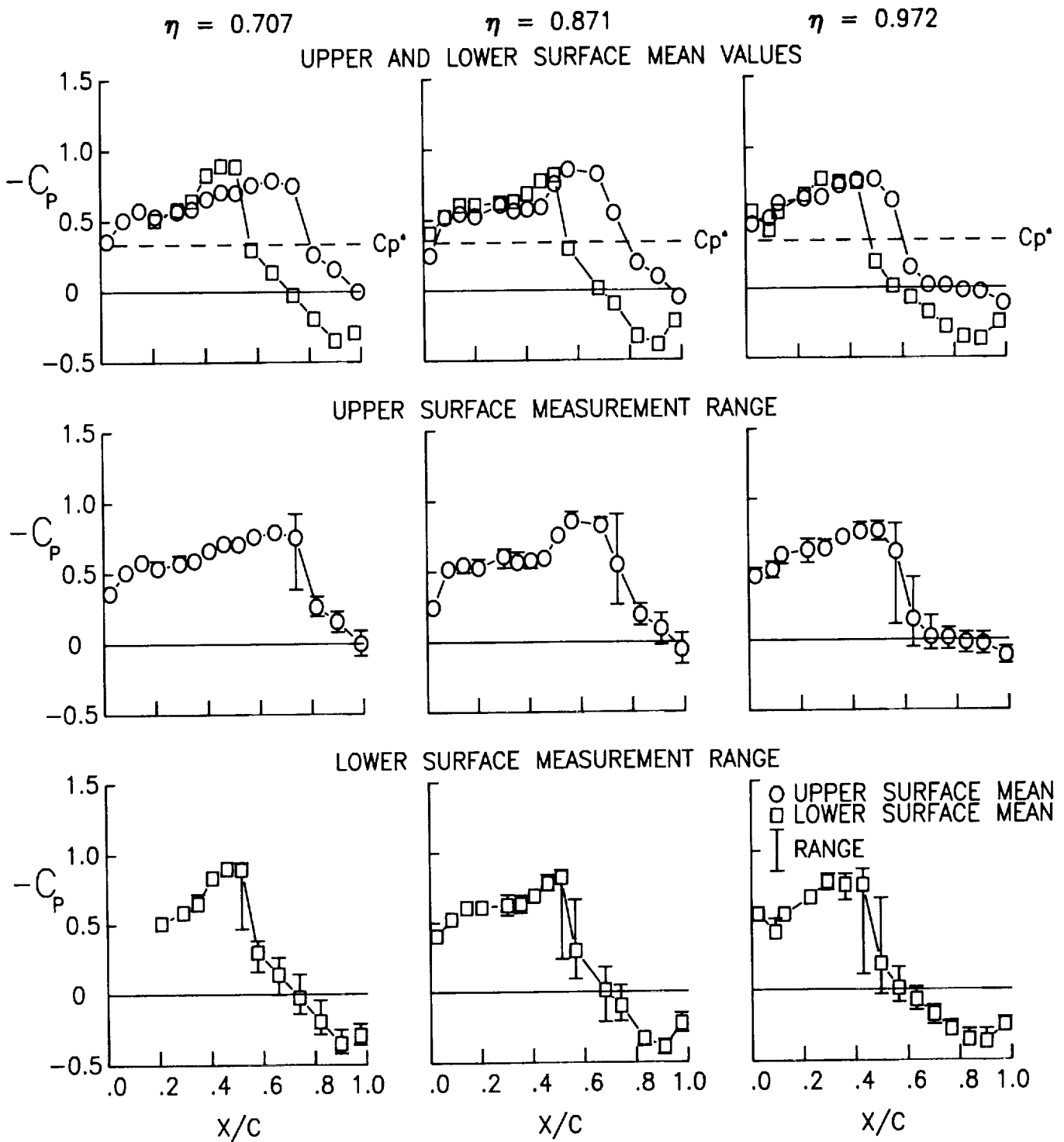

(e) Tab point 98.  $M = 0.92$ ;  $q = 152.5$  psf.

Figure 18. Continued.

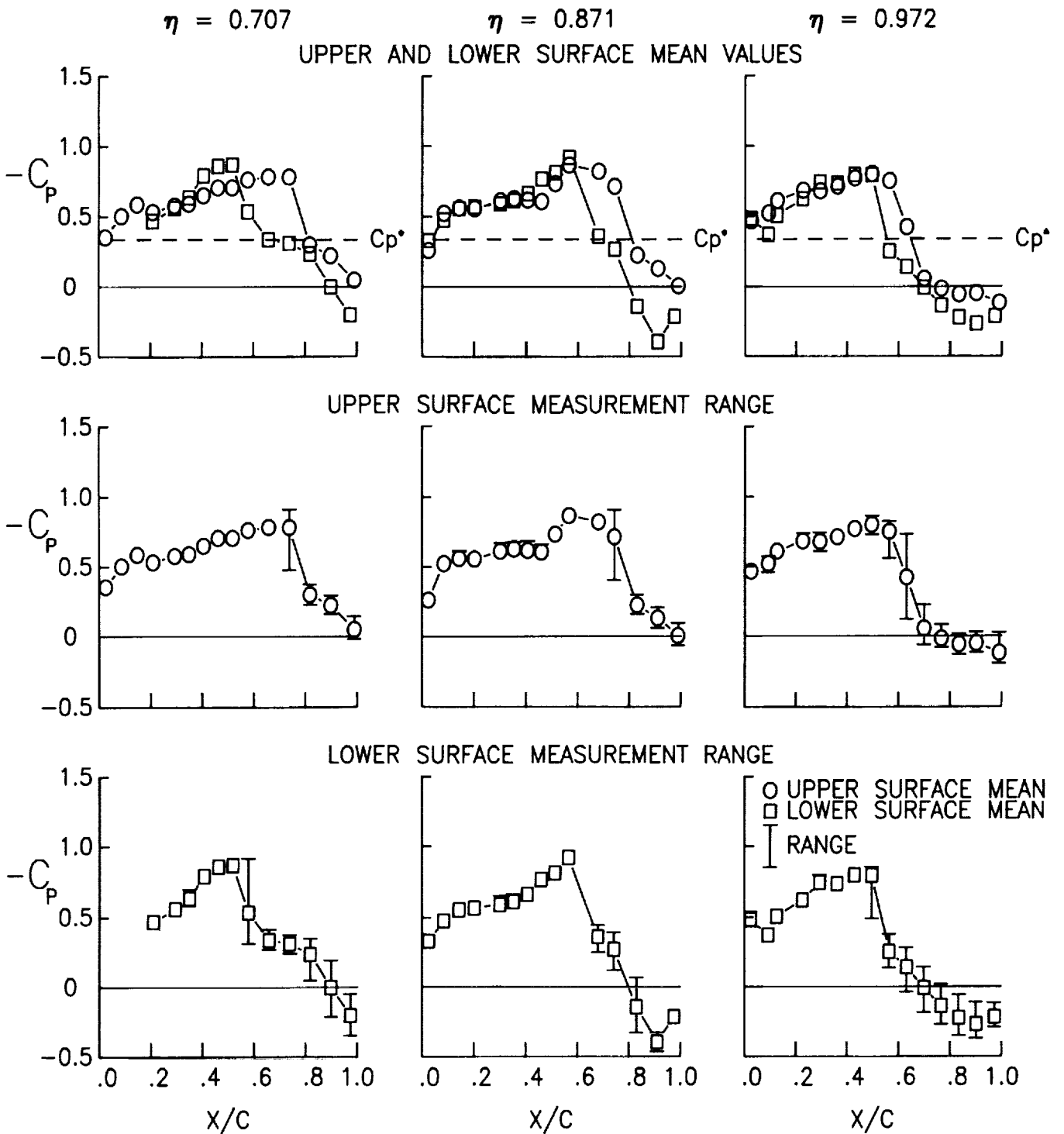

(f) Tab point 100.  $M = 0.94$ ;  $q = 157.0$  psf.

Figure 18. Continued.

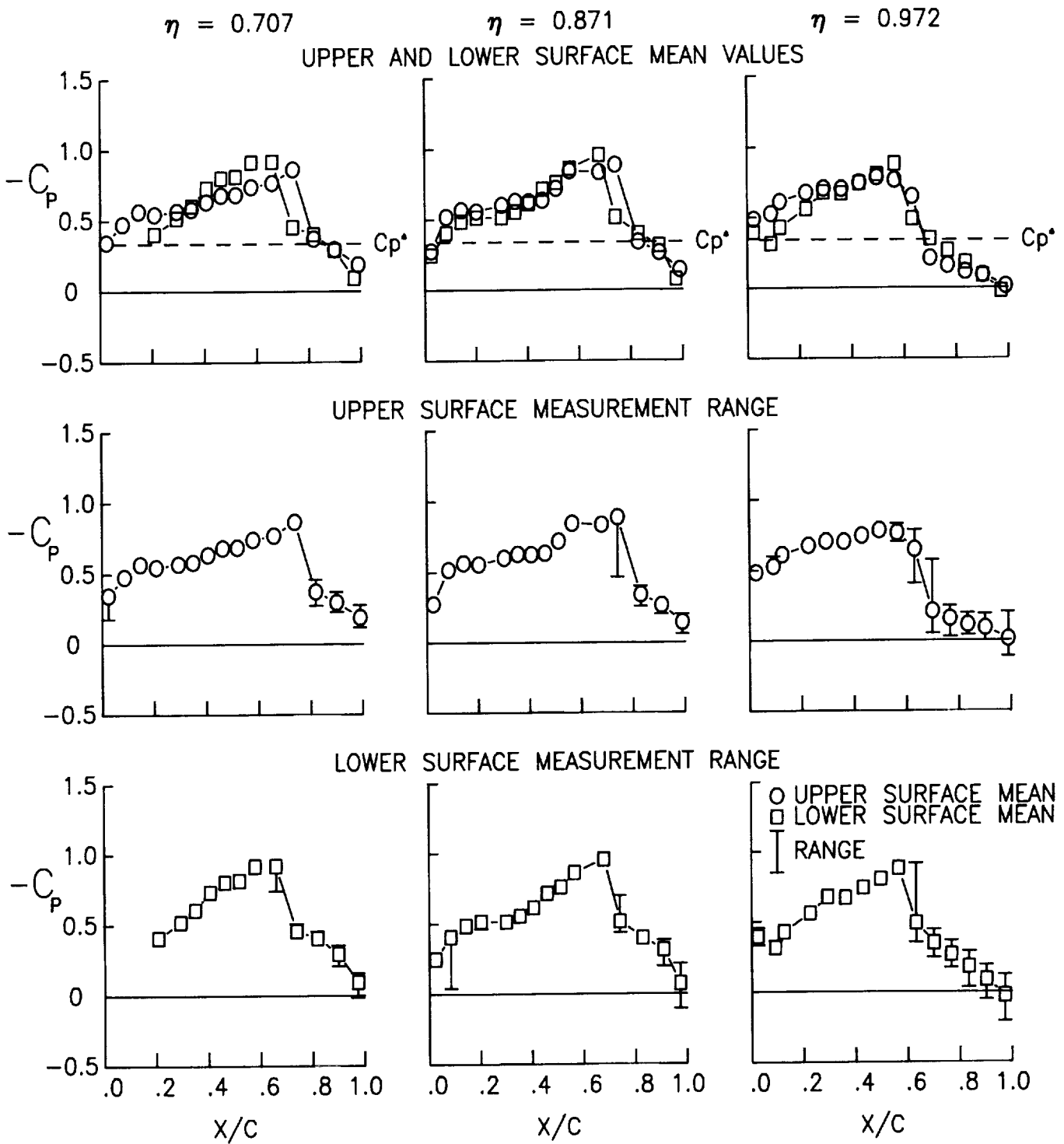

(g) Tab point 101.  $M = 0.96$ ;  $q = 161.7$  psf.

Figure 18. Concluded.

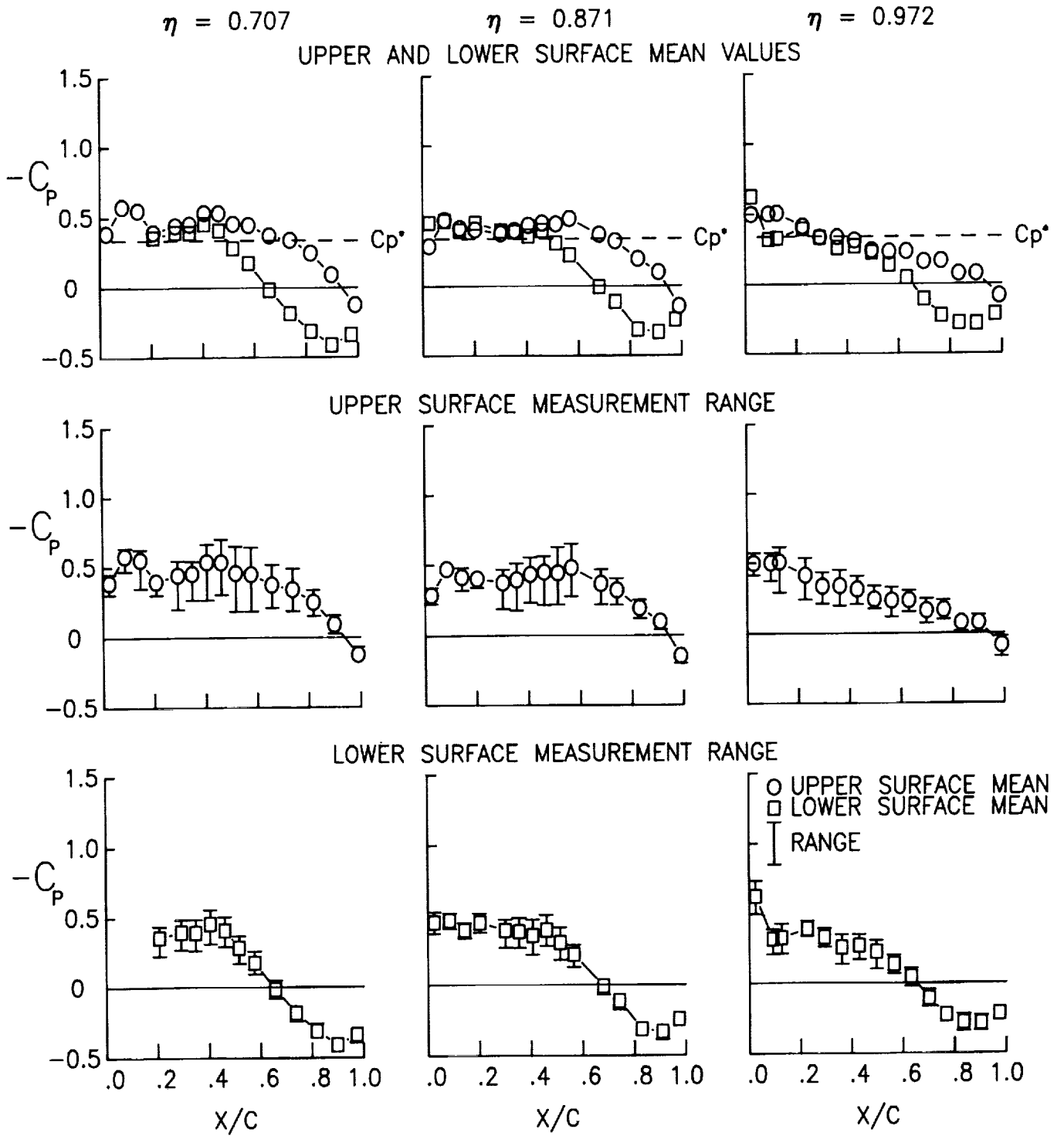

(a) Tab point 195.  $M = 0.80$ ;  $q = 260.2$  psf.

Figure 19. Chordwise pressure distribution data for high  $q$  conditions at  $\alpha = 0^\circ$ .

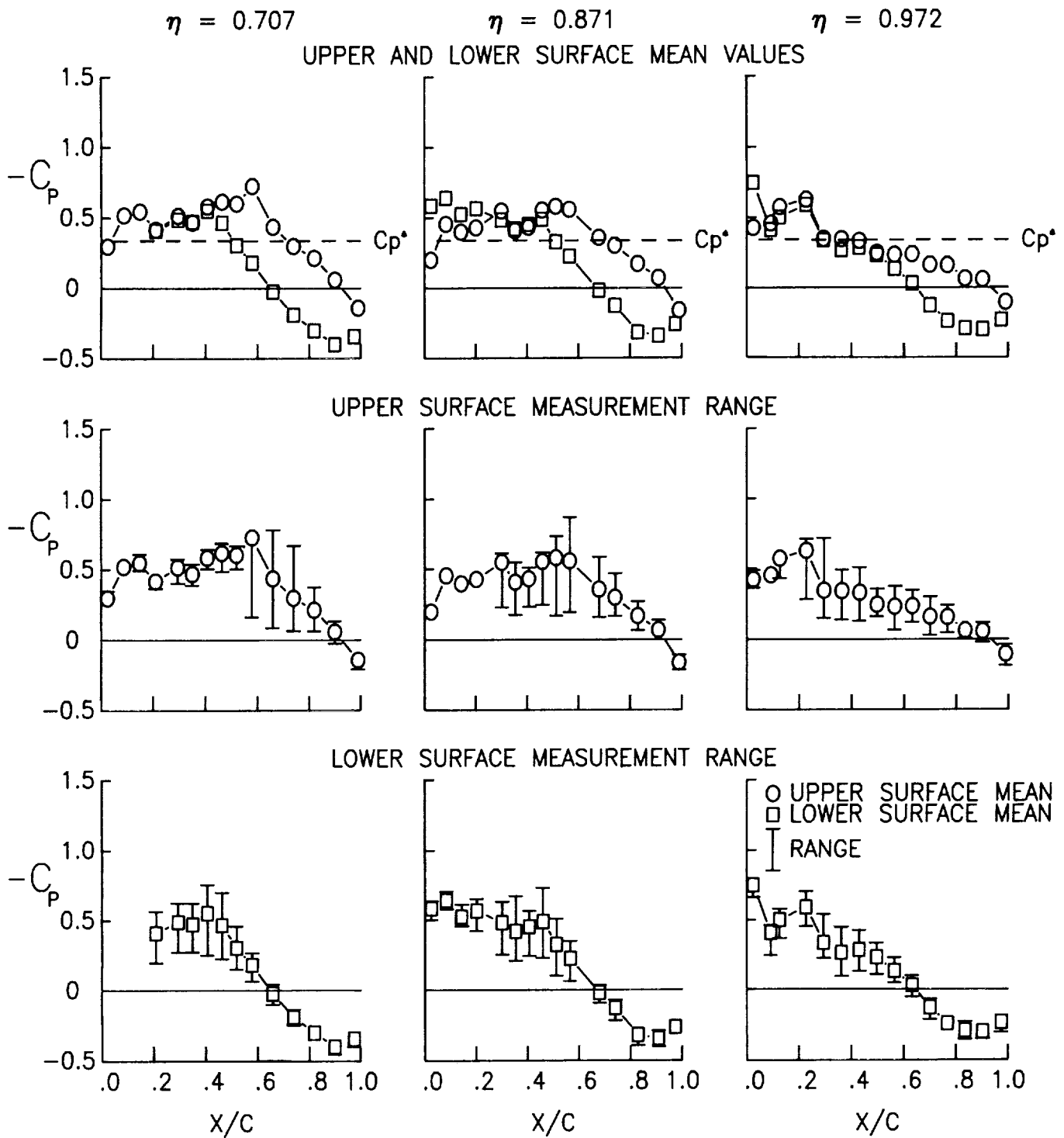

(b) Tab point 196.  $M = 0.85$ ;  $q = 283.4$  psf.

Figure 19. Continued.

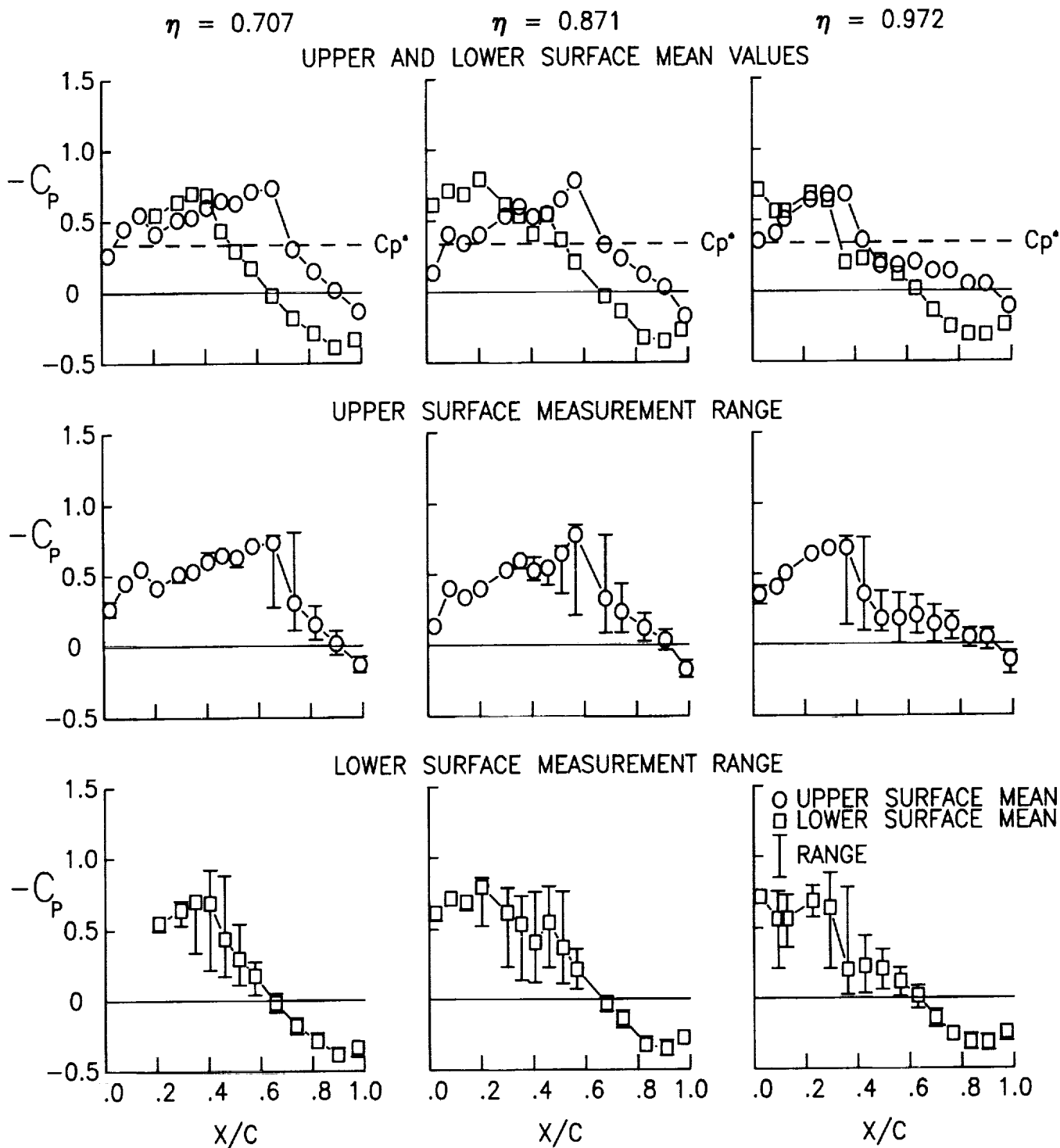

(c) Tab point 197.  $M = 0.88$ ;  $q = 297.9$  psf.

Figure 19. Continued.



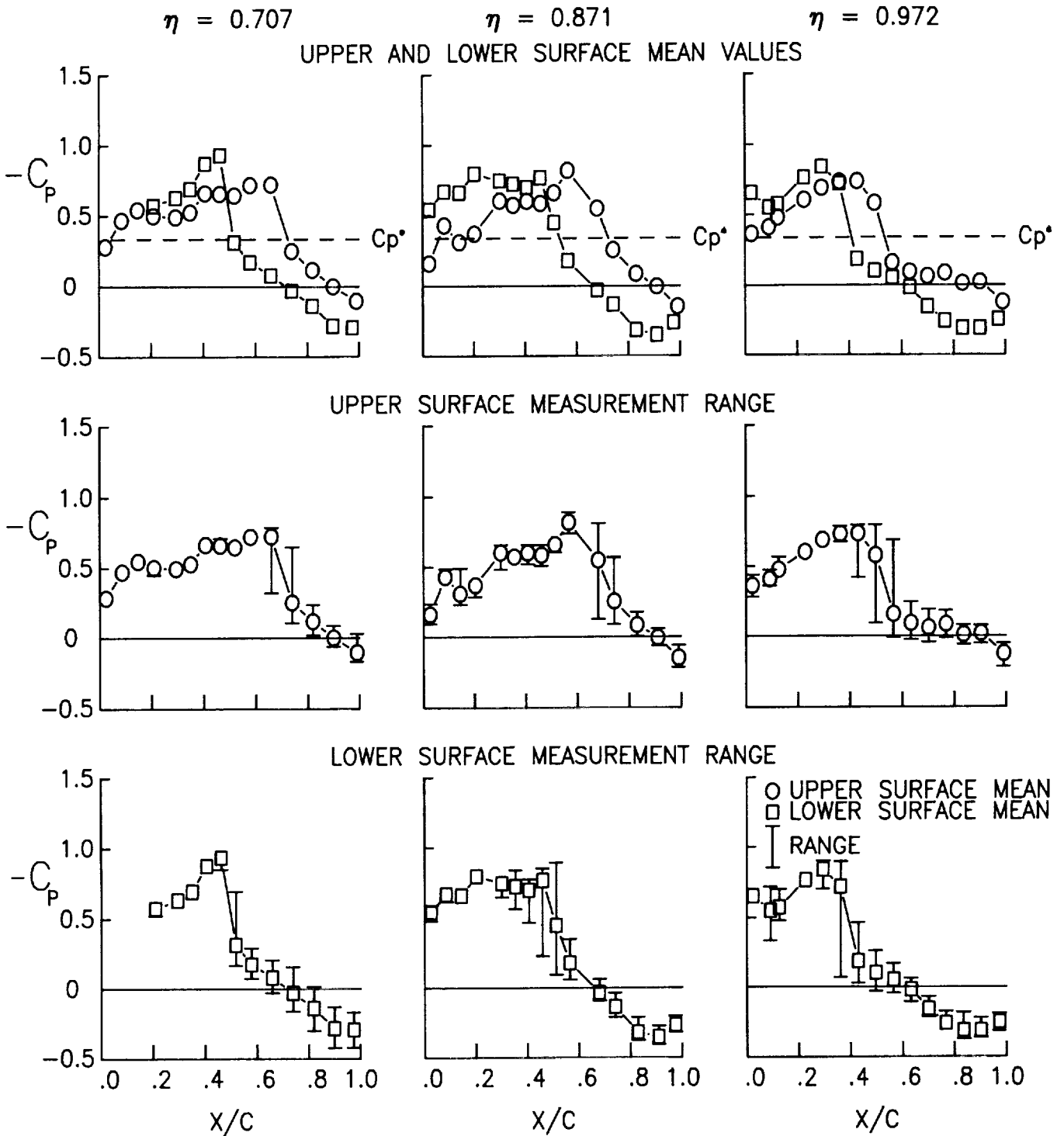

(d) Tab point 199.  $M = 0.90$ ;  $q = 308.6$  psf.

Figure 19. Continued.

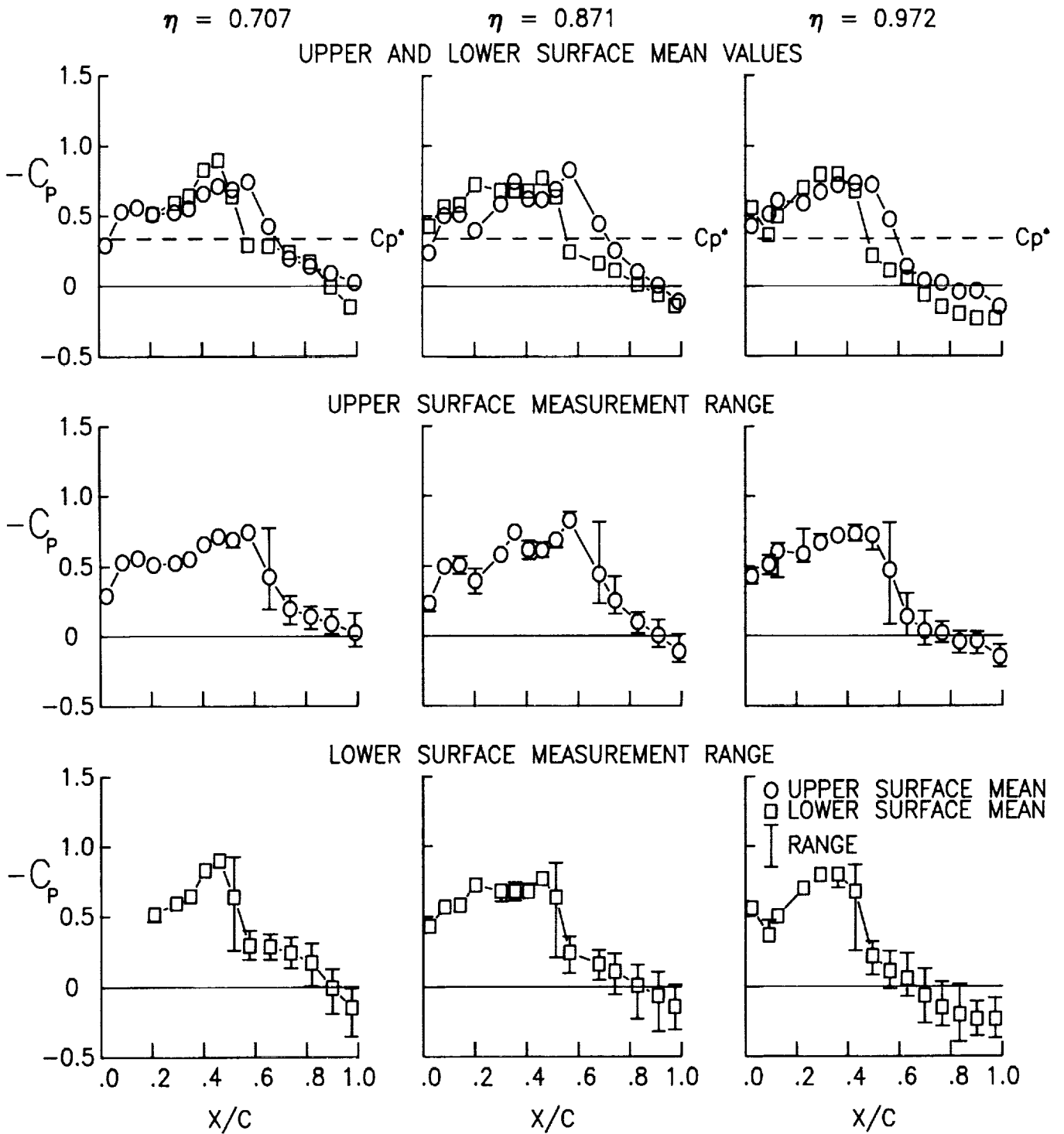

(e) Tab point 202.  $M = 0.92$ ;  $q = 317.8$  psf.

Figure 19. Continued.

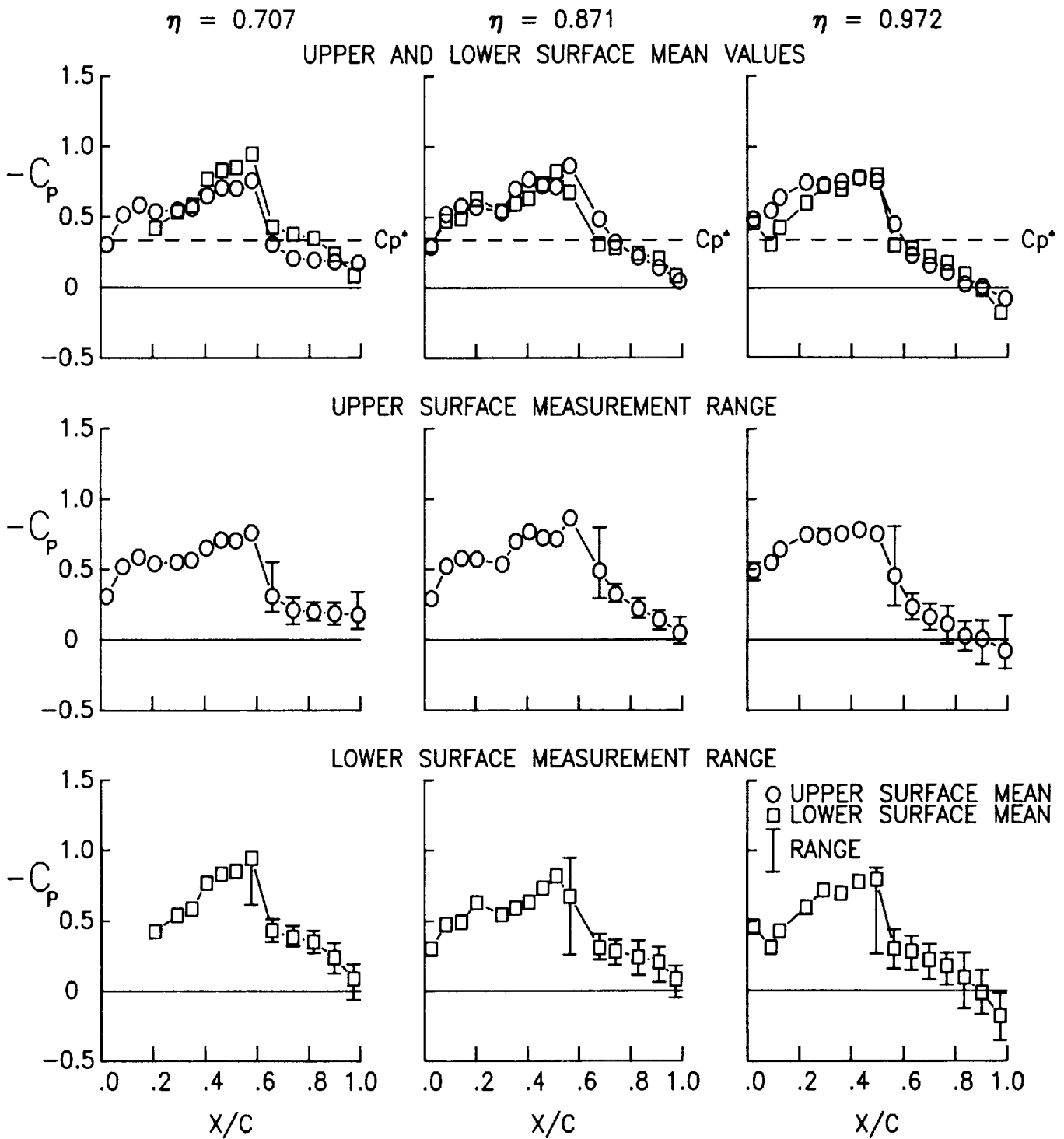

(f) Tab point 204.  $M = 0.94$ ;  $q = 328.3$  psf.

Figure 19. Continued.

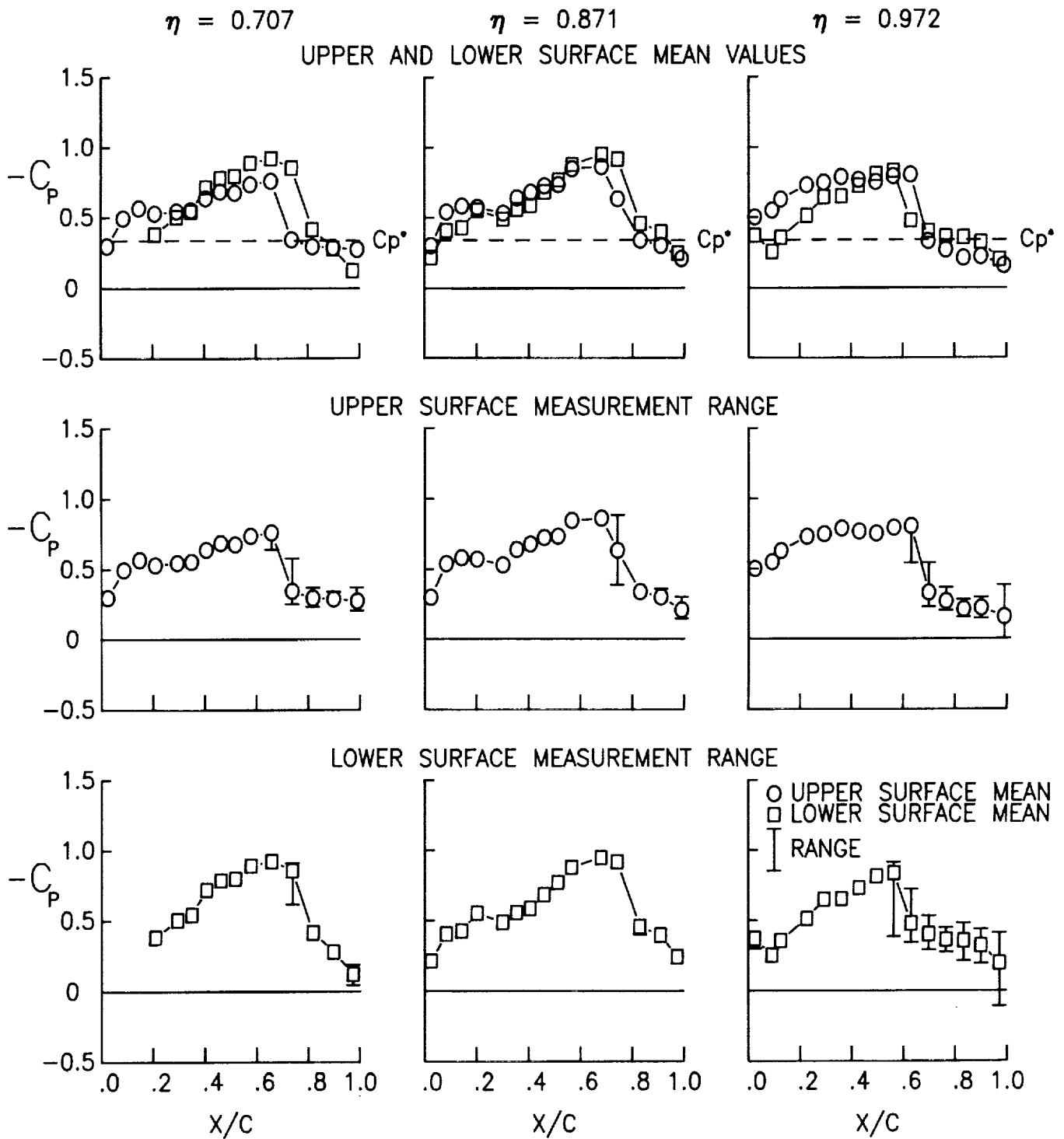

(g) Tab point 205.  $M = 0.96$ ;  $q = 336.7$  psf.

Figure 19. Concluded.

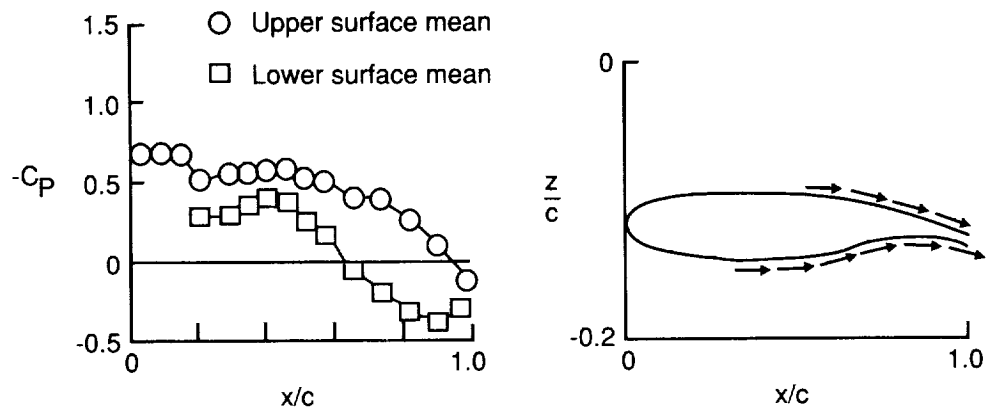

(a) Attached flow.  $M = 0.80$ ;  $\eta = 0.707$ ;  $q = 123.6$  psf. (See fig. 18(a).)

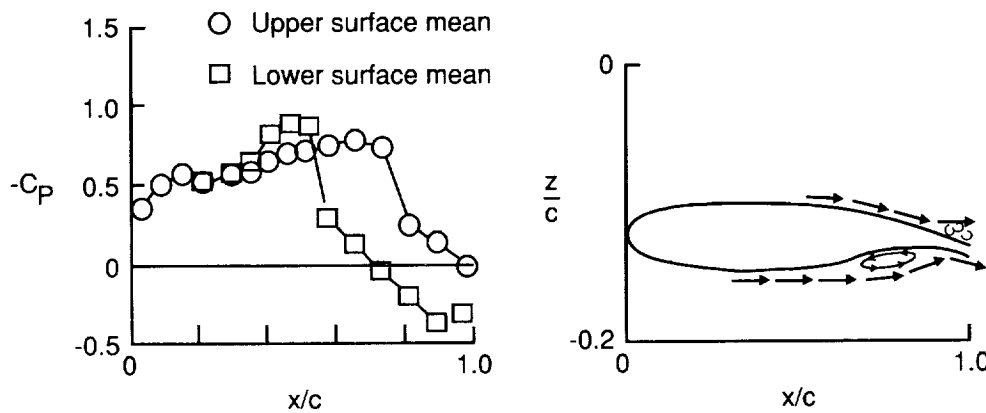

(b) Upper-surface trailing-edge flow separation and separation bubble on lower surface.  $M = 0.92$ ;  $\eta = 0.707$ ;  $q = 152.5$  psf. (See fig. 18(e).)

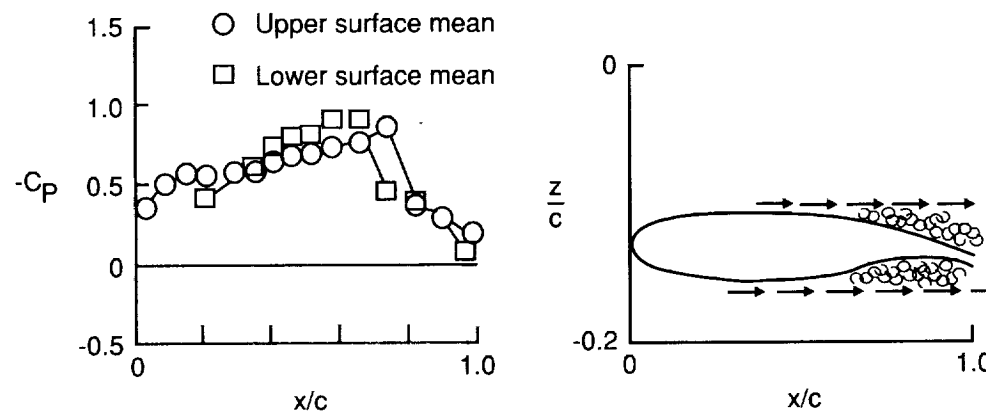

(c) Detached flow on upper and lower surface.  $M = 0.96$ ;  $\eta = 0.707$ ;  $q = 161.7$  psf. (See fig. 18(g).)

Figure 20. Schematic of flow with separation bubble.

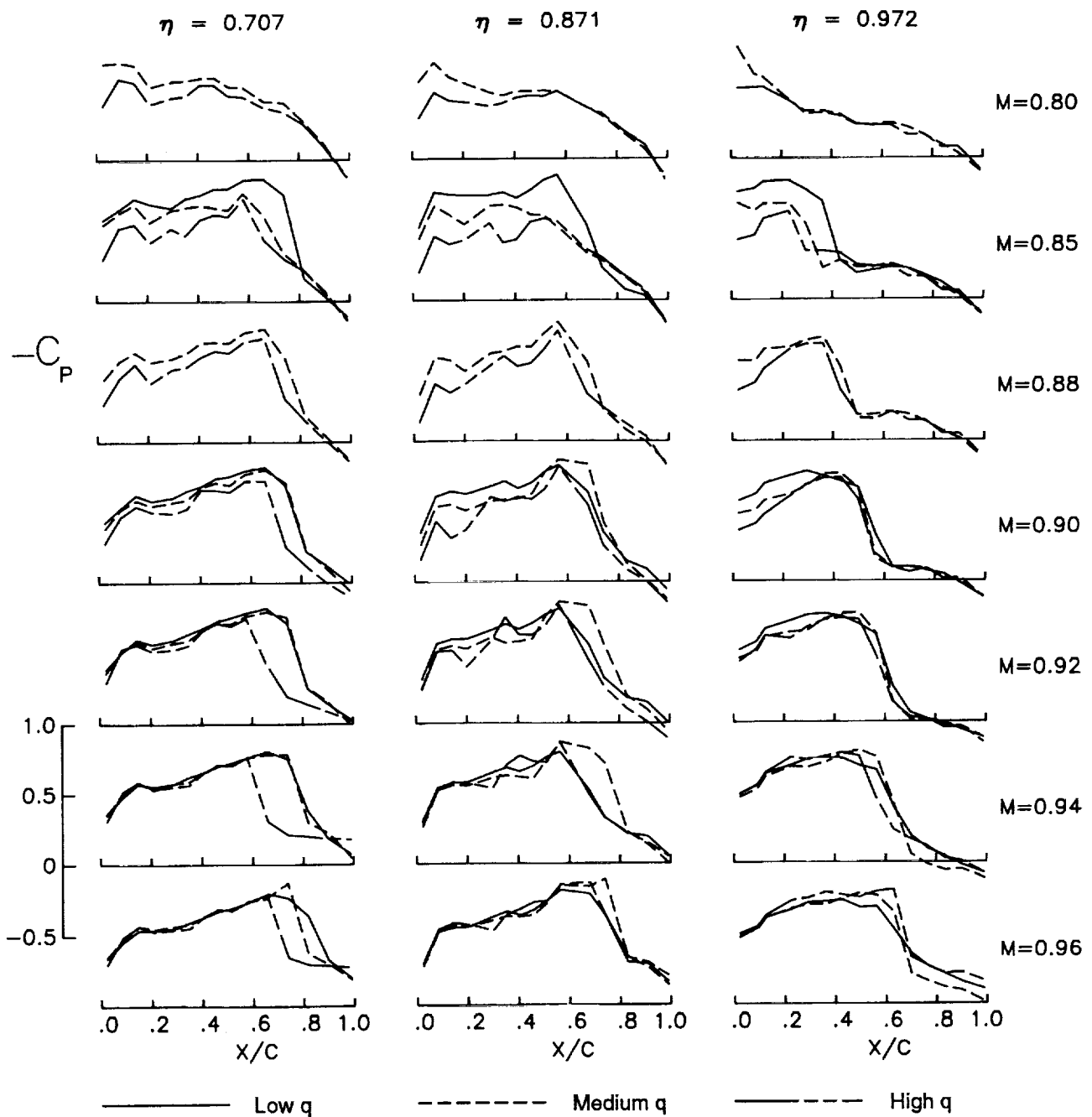

(a) Upper-surface data.

Figure 21. Effect of changes in test dynamic pressure.  $\alpha = 0^\circ$ .

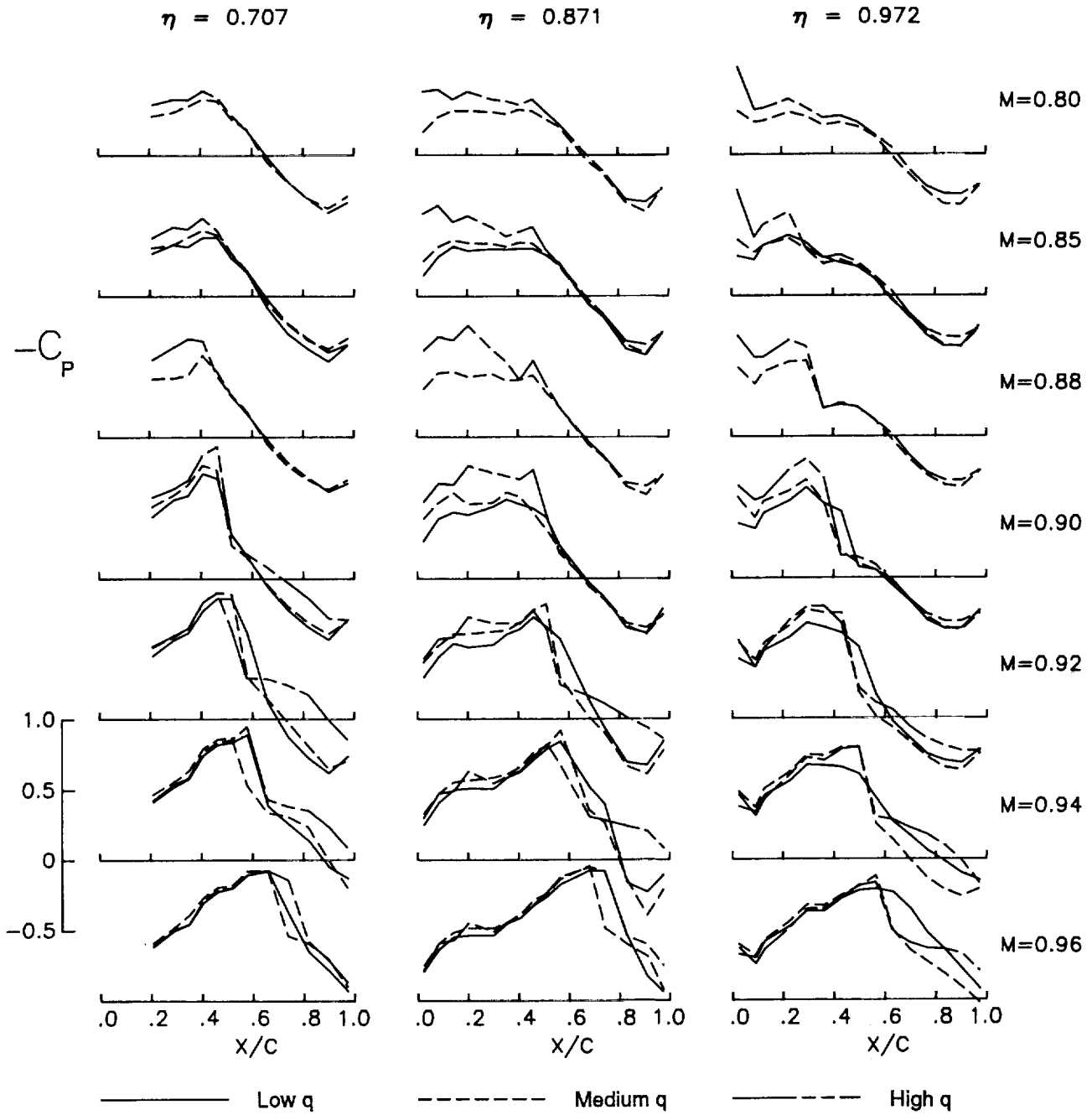

(b) Lower-surface data.

Figure 21. Concluded.

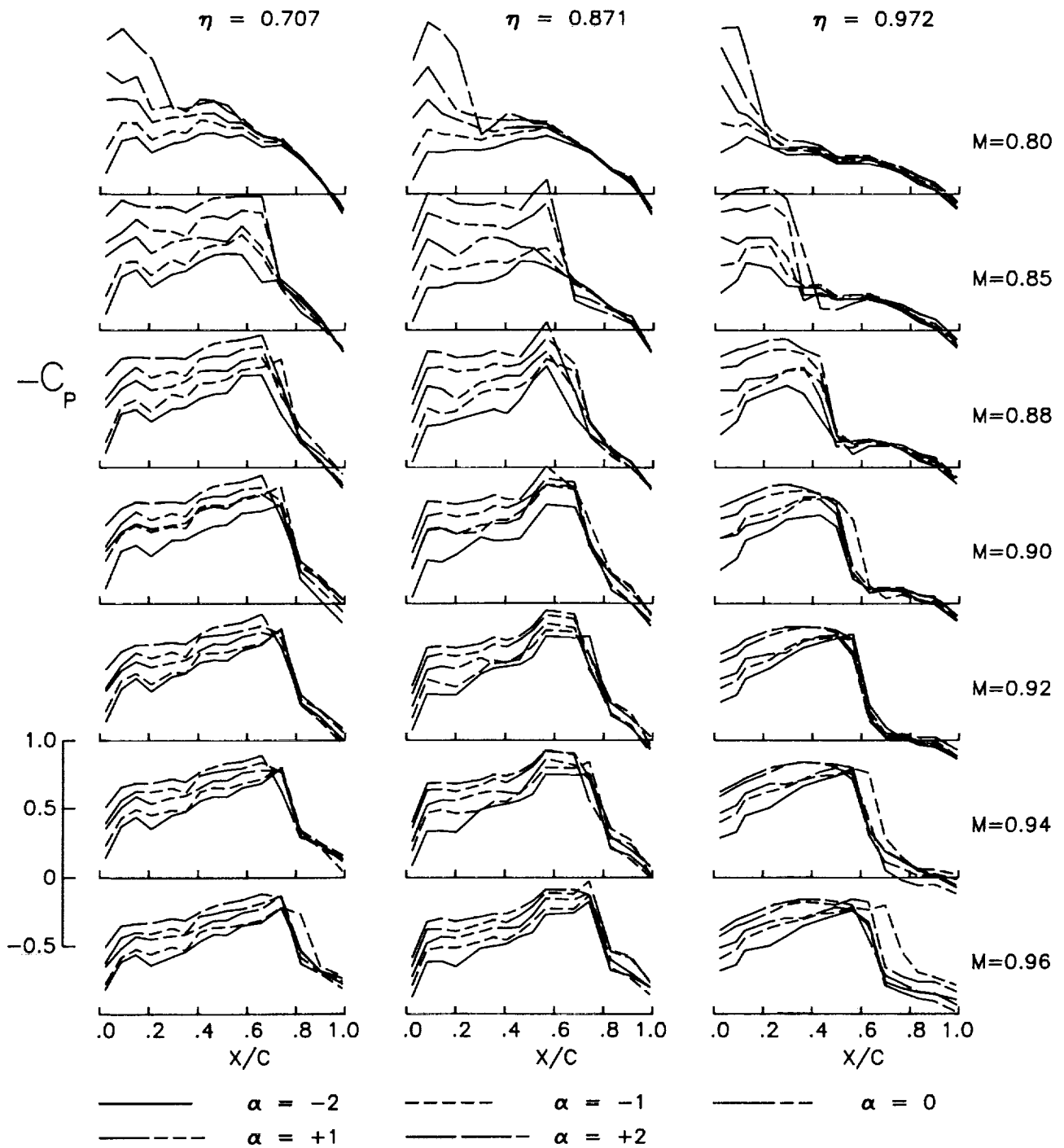

(a) Upper surface.

Figure 22. Pressure coefficient rms values for a 2-D NACA 0012 airfoil section.



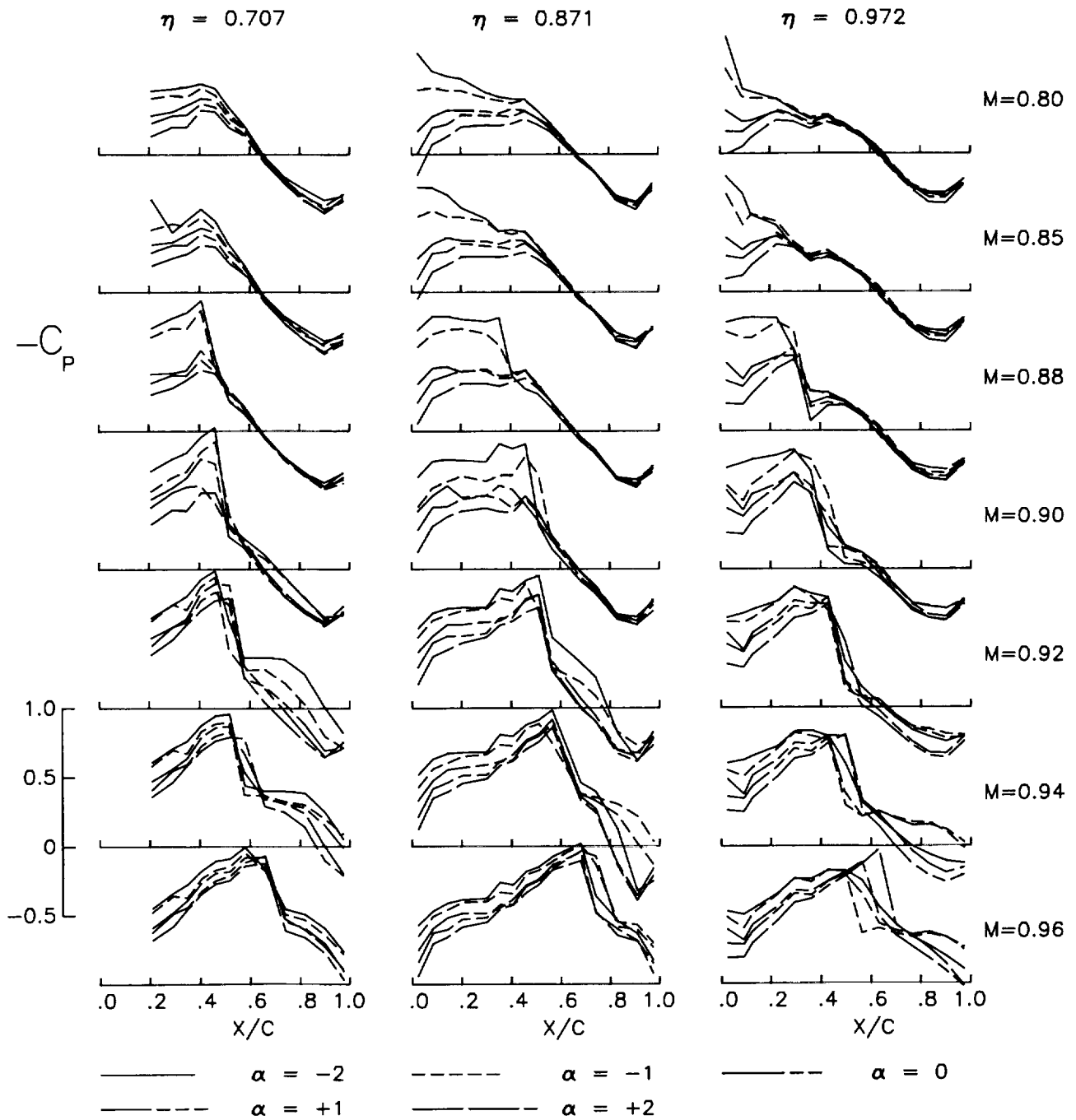

(b) Lower surface.

Figure 22. Concluded.

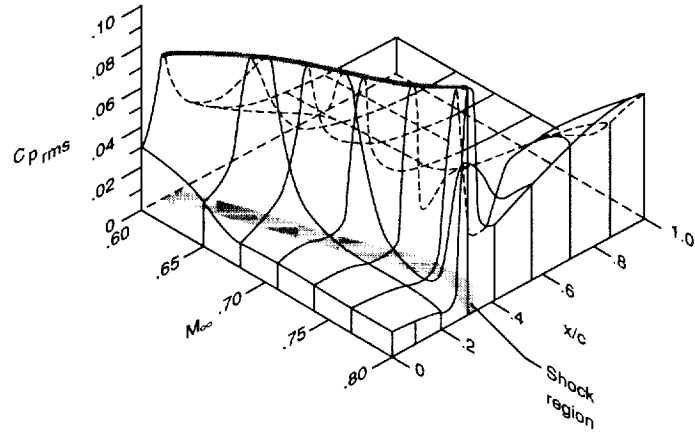

Figure 23. Pressure coefficient rms values for 2-D NACA 0012 airfoil.  $c_l = 0.45$ ; Reynolds number based on chord,  $2 \times 10^6$ . (From ref. 17.)

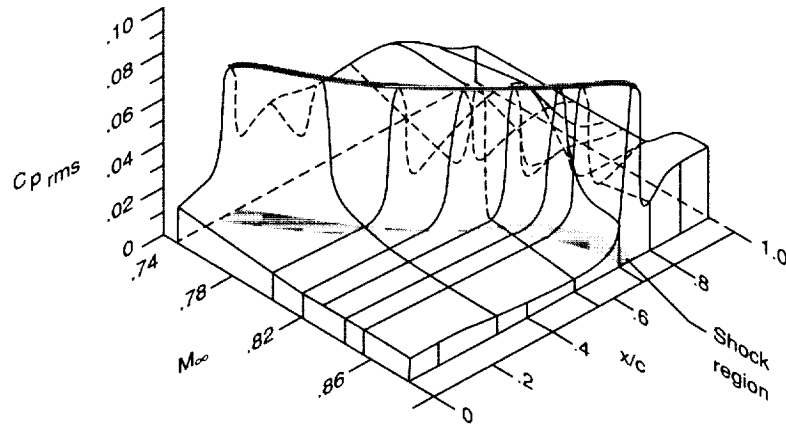

Figure 24. Pressure coefficient rms values for 2-D supercritical DSMA 523 airfoil.  $c_l = 0.55$ ; Reynolds number based on chord,  $2 \times 10^6$ . (From ref. 17.)

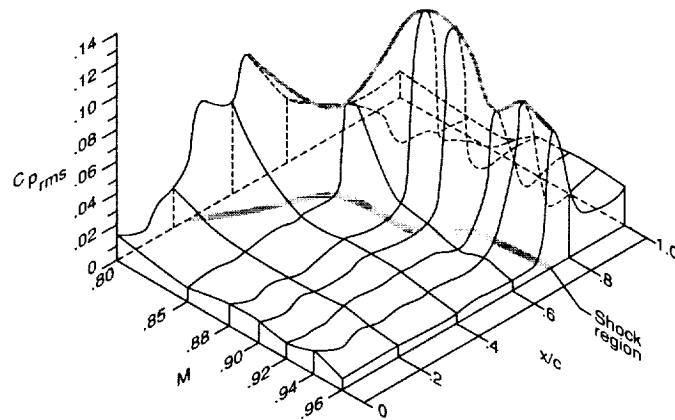

Figure 25. Pressure coefficient rms values for section of 3-D ARW-2 flexible supercritical wing. Leading-edge sweep =  $28.8^\circ$ ;  $Re = 2.6 \times 10^6$ ;  $\alpha = 2^\circ$ ;  $\eta = 0.871$ .

REPORT DOCUMENTATION PAGE			Form Approved OMB No. 0704-0188	
Public reporting burden for this collection of information is estimated to average 1 hour per response, including the time for reviewing instructions, searching existing data sources, gathering and maintaining the data needed, and completing and reviewing the collection of information. Send comments regarding this burden estimate or any other aspect of this collection of information, including suggestions for reducing this burden, to Washington Headquarters Services, Directorate for Information Operations and Reports, 1215 Jefferson Davis Highway, Suite 1204, Arlington, VA 22202-4302, and to the Office of Management and Budget, Paperwork Reduction Project (0704-0188), Washington, DC 20503.				
1. AGENCY USE ONLY(Leave blank)	2. REPORT DATE November 1994	3. REPORT TYPE AND DATES COVERED Technical Paper		
4. TITLE AND SUBTITLE Measurements of Unsteady Pressure and Structural Response for an Elastic Supercritical Wing			5. FUNDING NUMBERS WU 505-63-50-13	
6. AUTHOR(S) Clinton V. Eckstrom, David A. Seidel, and Maynard C. Sandford				
7. PERFORMING ORGANIZATION NAME(S) AND ADDRESS(ES) NASA Langley Research Center Hampton, VA 23681-0001			8. PERFORMING ORGANIZATION REPORT NUMBER L-17073	
9. SPONSORING/MONITORING AGENCY NAME(S) AND ADDRESS(ES) National Aeronautics and Space Administration Washington, DC 20546-0001			10. SPONSORING/MONITORING AGENCY REPORT NUMBER NASA TP-3443	
11. SUPPLEMENTARY NOTES				
12a. DISTRIBUTION/AVAILABILITY STATEMENT  Unclassified-Unlimited  Subject Category 01			12b. DISTRIBUTION CODE	
13. ABSTRACT (Maximum 200 words) Results are presented which define unsteady flow conditions associated with the high-dynamic structural response of a high-aspect-ratio, elastic, supercritical wing at transonic speeds. The wing was tested in the Langley Transonic Dynamics Tunnel with a heavy gas test medium. The supercritical wing, designed for a cruise lift coefficient of 0.53 at a Mach number of 0.80, experienced the high-dynamic structural response from Mach 0.90 to 0.94 with the maximum response occurring at about Mach 0.92. At the maximum response condition of the wing, the forcing function appears to be the oscillatory chordwise movement of strong shocks located on the upper and lower surfaces of the wing in conjunction with flow separation on the lower surface of the wing in the trailing-edge cove region.				
14. SUBJECT TERMS Aeroelasticity; Supercritical wing; Unsteady surface pressure			15. NUMBER OF PAGES 137	
			16. PRICE CODE A07	
17. SECURITY CLASSIFICATION OF REPORT Unclassified	18. SECURITY CLASSIFICATION OF THIS PAGE Unclassified	19. SECURITY CLASSIFICATION OF ABSTRACT Unclassified	20. LIMITATION OF ABSTRACT	

