

110806

31780

P. 8

## SPOT4 MANAGEMENT CENTRE

Yves LABRUNE  
CNES  
18 avenue Edouard Belin  
F - 31055 Toulouse Cedex

X. LABBE, A. ROUSSEL, P. VIELCANET  
CISI  
13 rue Villet  
F - 31029 Toulouse Cedex

### ABSTRACT

In the context of the CNES SPOT4 programme CISI is particularly responsible for the development of the SPOT4 Management Centre, part of the SPOT4 ground control system located at CNES Toulouse (France) designed to provide simultaneous control over two satellites.

The main operational activities are timed to synchronise with satellite visibilities (ten usable passes per day). The automatic capability of this system is achieved through agenda services (sequence of operations as defined and planned by operator). Therefore, the SPOT4 Management Centre offers limited, efficient and secure human interventions for supervision and decision making.

This paper emphasizes the main system characteristics as degree of automation, level of dependability and system parameterization.

### 1. PRESENTATION OF THE SPOT4 SYSTEM

#### 1.1. Introduction

Since the 1977 decision made by the CNES (French Space Agency) to create the SPOT programme, there has been considerable success with the launches and operations of the SPOT1 (February 1986), SPOT2 (January 1990) and SPOT3 (September 1993) satellites.

The SPOT4 programme allows to ensure the continuity of this Earth Observation mission until the beginning of the next century (SPOT4 is planned to be launched in 1997).

#### 1.2. SPOT4 technological aims

The payloads and passengers allow the SPOT4 mission to cover a wide commercial and technological field (eg. remote sensing, telecommunications, study of space environment).

The SPOT4 payloads are composed of :

- two identical HRVIR which are set up in such a way that it is possible both to get a repetitive coverage of the globe, and to form stereoscopic couples by the acquisition of oblique images,

- a new instrument, which is called VGT (vegetation), which mission consists of :

- . studying and surveying vegetation and evaluating renewable resources, mainly in the agriculture field,
- . studying and surveying the change in the continental biosphere at the global scale.

This instrument has been designed in order to observe most emerged land every day, the corresponding data being stored on-board in a mass-memory and transmitted back to the ground in visibility of the Kiruna and Toulouse stations.

The SPOT4 passengers are :

- DORIS (Doppler Orbitography and Radio-positioning Integrated by Satellite) which main purpose is to determine the orbit of the satellite with great accuracy (DORIS package uses an on-board orbit determination function),

- PASTEL which mission will be to transmit HRVIR images by laser optical link via a geostationary satellite (ARTEMIS) operated by the European Space Agency,

-ESBT which aims at experimenting the S band transmission of the housekeeping telemetry via the ARTEMIS satellite,

-PASTEC which mission is to increase the knowledge of the space environment and its influence on the behaviour of the satellite in orbit.

### 1.3. SPOT4 operational aims

According to the evolution of the Earth Remote

Sensing programmes, the realization of the SPOT4 ground segment must take into account more demanding operational requirements : reduced exploitation costs, better monitoring of the system operations (behaviour of satellite and payloads, status of image acquisition), reuse of SPOT4 developments for future programmes, harmonization and standardization of operations by the means of technological choices shared between different control centres, design of multimission software in order to ensure future reuse.

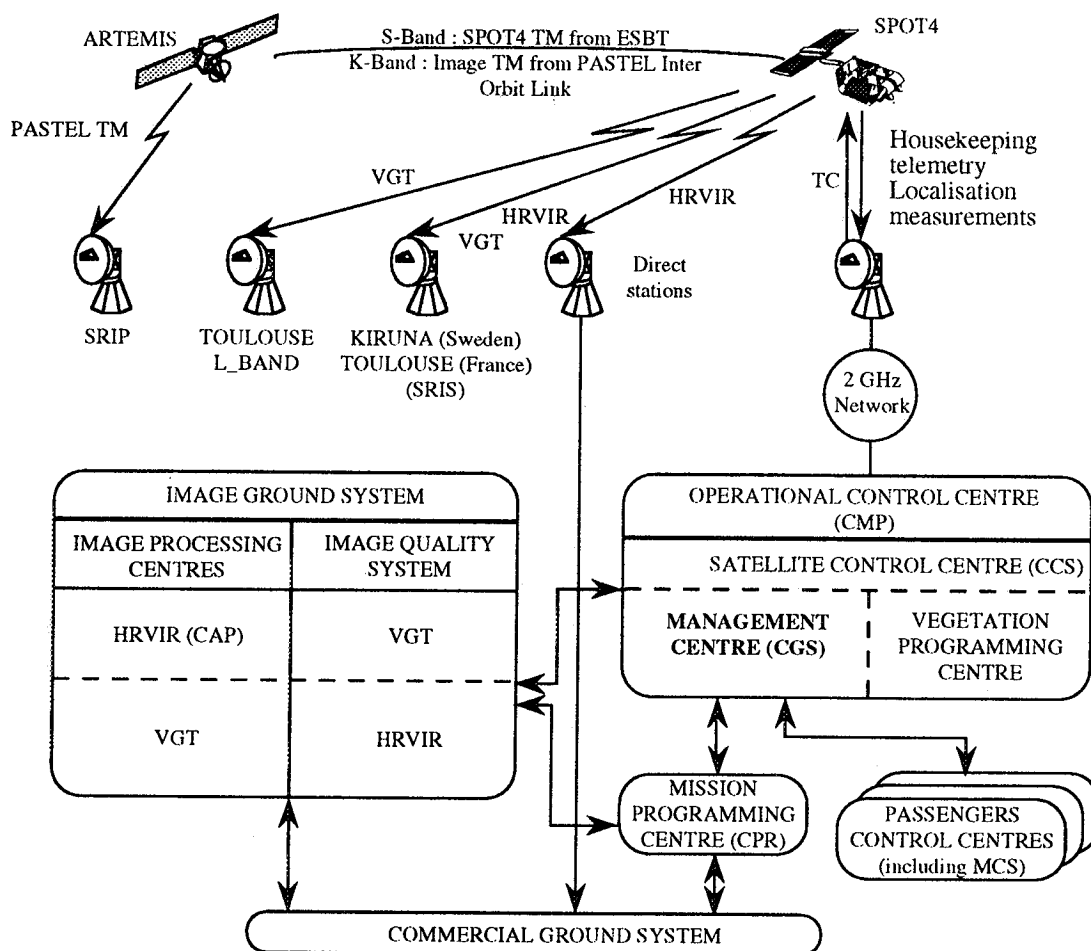

Figure 1 : SPOT4 System

## 2. PRESENTATION OF THE SPOT4 MANAGEMENT CENTRE (CGS)

The Management Centre is the entity of the Operational Control Centre(CMP) in charge of SPOT4 satellite programming and monitoring as shown in figure 1.

### 2.1. Main CGS functions

To perform the CGS mission, activities are divided into two types :

- critical tasks** (eg. satellite commanding and monitoring, payload programming). These tasks follow a scenario which has been predefined; they execute on the Operations computer,
- preparation tasks** (eg. instrument calibration). In order not to overload the critical tasks, these tasks are carried out on a specific computer (Preparation and Evaluation computer).

### 2.2. CGS hardware architecture

#### 2.2.1. Operations computer

This HP 9000 serie computer supports the routine activities and manages the interfaces with the external centres (eg. CPR). Availability and security of the CGS data are granted by storage on mirror disks which can be accessed from both the Operations and the Back-Up computers as shown in figure 2.

#### 2.2.2. Preparation and Evaluation computer

An HP 9000-755 computer is devoted to the specific tasks of operations engineers such as the preparation of non-routine activities on the satellite (eg. manual manoeuvre in degraded modes, spacecraft evaluation). For data retrieval or command execution, it gains access to the Operations computer via a local network.

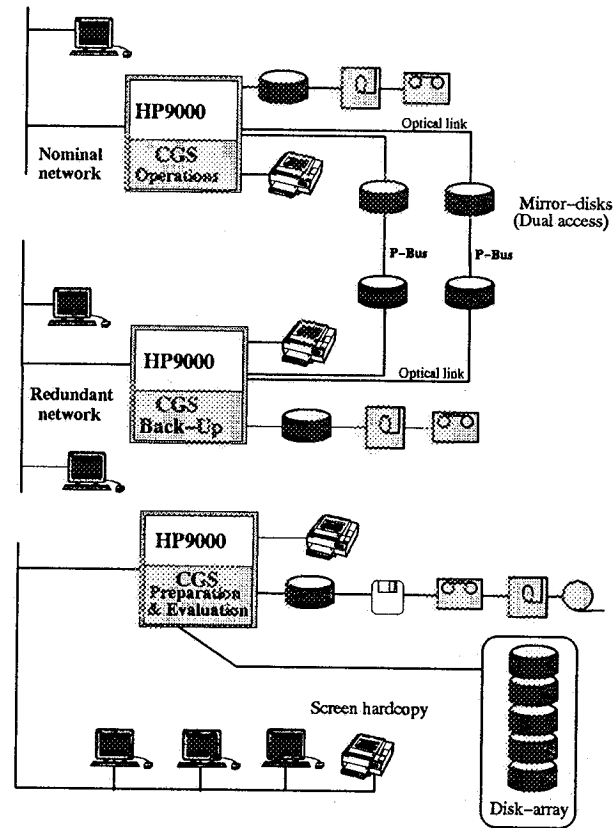

Figure 2 - Hardware Architecture

#### 2.2.3. Back-Up computer

This computer provides redundancy for both the Operations computer and the Preparation and Evaluation computer. The use of mirror disks and operating check-points allows a fast restart with no loss of data.

#### 2.2.4. CGS local network

In order to meet high performance requirements, the local network is divided in sub-networks carrying data specific to each segment. For high availability purposes, redundant schemes were implemented for both computers and sub-networks.

The network failure is avoided through the redundancy of the central router and each sub-network.

### 2.3. Software architecture

The CGS is composed of a set of sub-systems as shown in figure 3 :

- **satellite monitoring sub-system** which is in charge of the management of the satellite technological database and of the housekeeping telemetry off-line monitoring,
- **passenger interface** which sends the passenger commands to the satellite and plans the use of PASTEL and ESBT,
- **flight dynamics sub-system** which is in charge of SPOT4 orbit and attitude determination and control. It computes and prepares the related orbit and attitude manoeuvres,
- **satellite and on-board software management sub-system** which monitors the SPOT4 platform configuration,
- **payload programming and monitoring sub-system** which programs the HRVIR payload according to the commercial requests and the

technological evaluation needs (eg. instruments calibration) and monitors the images acquisition loop (on board command execution, ground acquisition and image archiving).

### 3. MAIN OPERATIONAL FEATURES

#### 3.1. Introduction

The flexible design of the CGS answers variable needs among the various phases of the satellite life :

- launch and orbit positioning phase,
- flight acceptance phase,
- routine phase,
- anomaly mode.

After a brief overview of the CGS nominal operational environment this section presents the specific operational features of these phases and discusses the related implementation options.

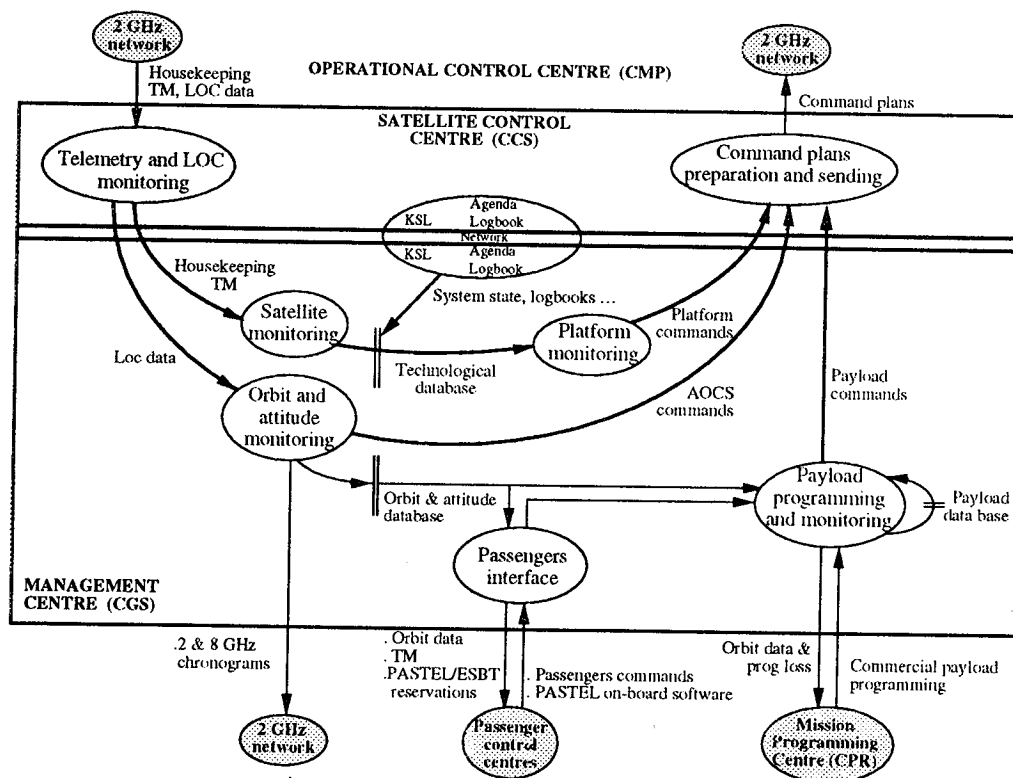

Figure 3 - Management Centre Main Interfaces

### 3.2. General operational environment

The SPOT4 CGS is in operation during working hours from 6 am to 10 pm. Overnight, it should be possible to carry out the operations automatically. The main operating environment of the CGS is the Agenda, presented at SpaceOps'92 (see ref.1).

The Agenda fully supports the automatic execution of the satellite monitoring and control daily plan (no human intervention).

In fact, a CGS daily program involves the execution of 100 tasks, whose average duration is 4 minutes and whose maximum execution time is 20 minutes.

### 3.3. Flight acceptance phase

This operations phase requires the execution of specific treatments on the flight acceptance system configuration (platform and payload configurations set up by operations engineers),

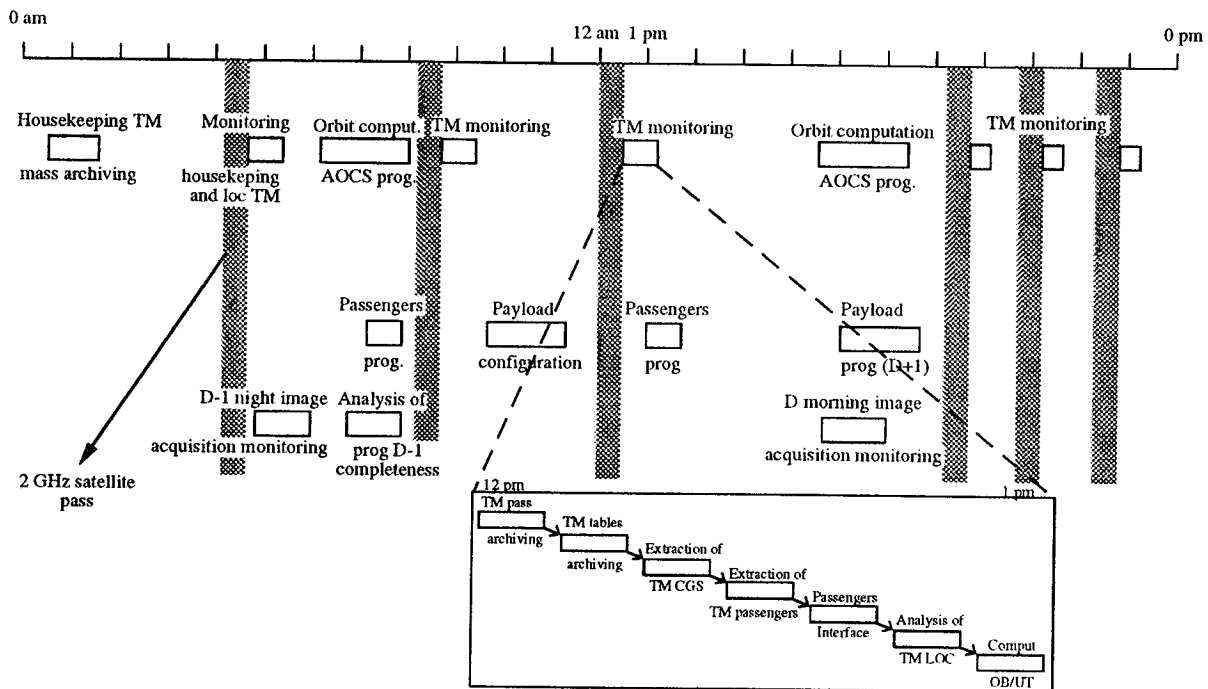

Figure 4 - CGS Daily Activity Plan

This is particularly the case of non critical tasks , run at night, under the autonomous control of the Agenda. The importance of this scheduler also resides in the fact that it can be stopped at any moment to enable the operator to take control on the sequence of operations. Figure 4 shows the first level of a typical daily work program at CGS.

in addition to the routine operations of the CGS.

To configure the platform consists in defining and sending specialized control sequences over the platform equipments. A devoted MMI supports the acceptance tests. This MMI uses the platform configuration status, stored in the satellite data base.

These tests are prepared in the operational qualification phase, thanks to the satellite simulation means. They are then stored in a library for further reuse in a given operation plan. A dedicated MMI allows the modification of those predefined controls, according to the results of the analysis of the housekeeping telemetry.

The payload is configured in order to perform the technological tests and calibration of the payload instruments and equipments. The imaging capability acceptance tests programming is based on the graphical representation of the test ground areas as shown in figure 5. This efficient graphical programming offers strong guarantees of safety and reliability for critical acceptance tests : all operational constraints are integrated in the MMI logics (eg. operational set-up, instrument performance limits, field of view, forbidden sequences).

This is a large improvement in ergonomony and security of the payload programming in technological mode, compared to the previous SPOT generation.

### 3.4. Routine-operations phase

This operations phase is characterized by the maximum automation of the satellite control and monitoring actions. The routine operations are supported by the Operations computer through the Agenda, the Preparation and Evaluation computer being reserved for exceptional actions such as specific queries on the housekeeping telemetry or technological programming for further payload investigation. Significant enhancements have been implemented for SPOT4 CGS, as described in the next sections.

#### 3.4.1. Satellite orbit manoeuvres computation

The satellite manoeuvres computing chain is entirely automated according to the following concepts.

After tracking data acquisition, the orbit is restituted and predicted ; those results are analyzed to check that the predicted values are within the range of acceptable values for the orbit parameters.

If the predicted orbit falls out of the normal range, the satellite manoeuvres are computed according to the rendez-vous concept which smoothes the

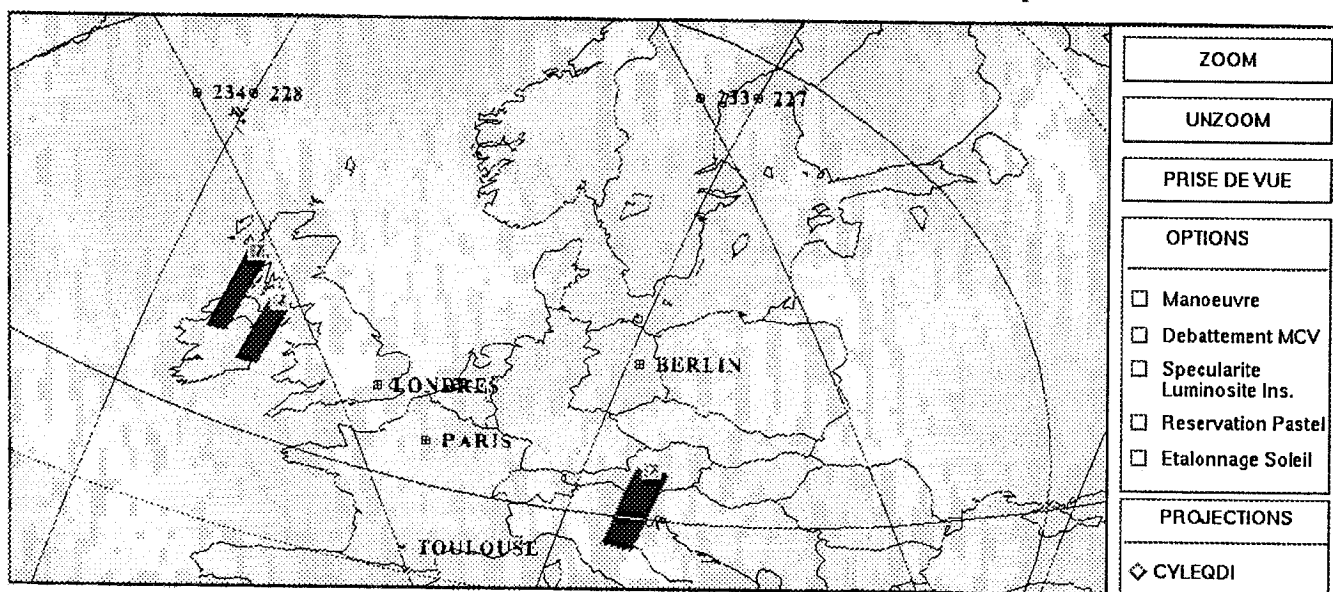

Figure 5 – Payload Acceptance Tests Programming

parameters evolutions and ensures their return to a normal range.

This new computer based strategy minimizes the number of successive orbit correction manoeuvres.

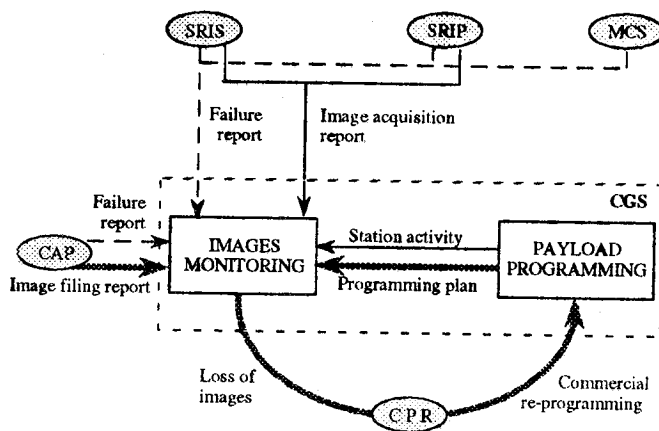

Figure 6 - Control of Image Acquisition Loop

### 3.4.2. Control of image acquisition loop

The image acquisition loop performs the automated monitoring of HRVIR programming, from image acquisition requests at CPR to image archiving within the Image Ground System.

The main goals of this controlled loop are to detect and report the losses of images and therefore it interfaces most of the elements of the ground segment as shown in figure 6 :

- the CPR which manages the user's requests,
- the CGS sub-system which elaborates the payload commands,
- the SPOT and PASTEL image reception stations (SRIS, SRIP),
- the SPOT image archiving center (CAP),
- the ARTEMIS satellite control center (MCS).

The correlation of the planned and achieved activities gives the operator the image loop status. This sub-system generates quantitative measures on the reliability of the ground segment and helps in the necessary reprogramming to satisfy the commercial operator's needs.

### 3.4.3. Parameterization based on satellite configuration

Many CGS operational tasks are parameterized by the satellite reference configuration which is stored in the satellite database under responsibility of the satellite manager. At CGS, a subsystem in charge of satellite configuration maintains an evolutionary version of this information according to operational needs (eg. update of the standard monitoring parameters thresholds).

After validation, these evolutions are centralized by the satellite manager and placed under control for future use by operational tasks.

This mechanism ensures the system operation security (fully controlled and formalized satellite configuration).

### 3.5. Anomaly mode

As part of CGS anomaly recovery procedures, various mechanisms support efficiently the necessary operational analysis in order to resume the execution of the system. The analysis is conducted by satellite and payload engineers.

A significant feature is the computerbased behaviour diagnosis of the flight dynamics sub-system.

When anomalies occur during the satellite orbit determination, like the divergence of successive orbital restitutions, a dedicated MMI displays :

- the probable failure causes,
- a check-up list for every cause,
- the actions related to a specified check-up step.

The MMI also gives access to graphical representations of orbit data and flight dynamics parameters.

Therefore, after detailed analysis, the engineer implements the proposed manual actions for recovering the nominal context of operations.

#### 4. SYNTHESIS

Following the technological success of the first SPOT satellite generation in the mid 80's, the SPOT system has gained important commercial grounds, meeting the requirements of a large number of users throughout the world.

The need for images has grown considerably, and the economic stakes consequently evolve.

The periodic upgrades of the Earth Observation Systems are motivated by the aim to offer the users perennial services at competitive prices.

Due to its new characteristics (eg. levels of standardization and automation), the CGS is one of the basic components of the future ground control system of CNES remote sensing satellites.

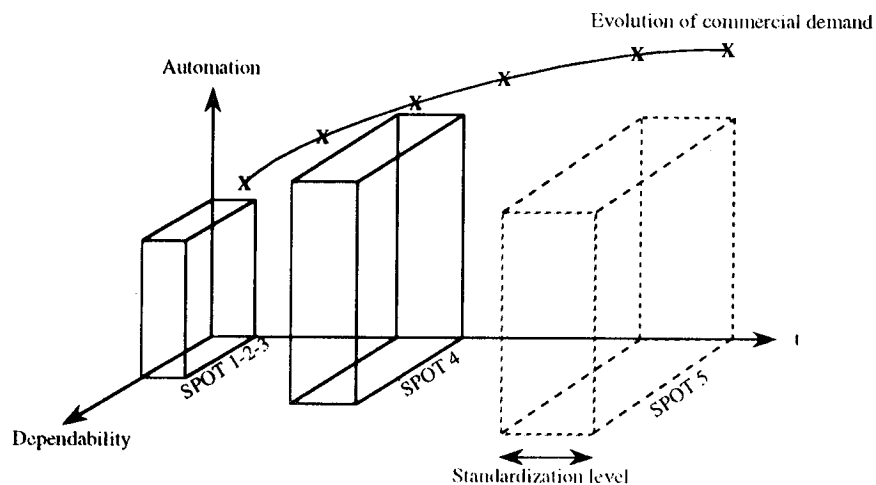

Figure 7 - Evolution of SPOT Main Operational Features

As specified in the introduction, the SPOT4 generation has to offer great improvements both, at technological and operational levels.

To achieve these ambitious goals, the SPOT4 CGS implementation relied on an industrial organization which benefitted from the experience gained on the SPOT 1/2/3 generation in the fields of advanced system engineering, development methodology, technology and quality assurance and control.

The SPOT4 CGS project gave way to the advanced rationalization of the definition and realization of the Management Centre components. These industrial products will ease further reuse and evolutions as sketched in figure 7.

#### REFERENCES

- 1 - PACHOLCZYK, P. 1992  
SPOT satellite family.  
In SpaceOps 1992
- 2 - ZAUCHE, G. 1992  
SPOT4 operational control centre.  
In SpaceOps 1992
- 3 - FRATTER, I. 1992  
Agenda : a task organizer and scheduler.  
In SpaceOps 1992



*comit*

**COSTS OPTIMIZATION FOR OPERATIONS CONCEPTS OF SMALL  
SATELLITE MISSIONS**

Jean-Michel Oberto  
Matra Marconi Space

Paper Not Available

