

A PERSPECTIVE ON SPACE ROBOTICS IN JAPAN

N95-23695

Yoshiaki Ohkami*, Ichiro Nakatani**, Yasufumi Wakabayashi+ and Tsutomu Iwata+

*Dept. of Mechano-Aerospace Engineering, Tokyo Institute of Technology
2-12-1 Ohokayama, Meguro, Tokyo 152 JAPAN
e-mail: ohkami@mes.titech.ac.jp
Tel: 81-3-5734-2644 Fax: 81-3-3729-0628

**The Institute of Space and Astronautical Science (ISAS)
3-1-1 Yoshinodai, Sagami-hara, Kanagawa-ken 229 JAPAN
e-mail: nakatani@net202.newslan.isas.ac.jp
Tel: 81-427-51-3911 Fax: 81-427-51-3988

+Systems Engineering Department, National Space Development Agency
2-1-1, Sengen, Tsukuba, Ibaraki 305 JAPAN
e-mail: ywakaba@rd.tksc.nasda.go.jp
Tel: 81-298-52-2241 Fax: 81-298-52-2247

ABSTRACT

This report summarizes the research and development status and perspective on space robotics in Japan. The R & D status emphasizes the currently on-going projects at NASDA including the JEM Remote Manipulator System (JEMRMS) to be used on the Space Station and the robotics experiments on Engineering Satellite VII (ETS-VII). As future perspective, not only NASDA but also ISAS and other government institutes have been promoting their own research activities on space robotics in order to support widely spread space activities in future. Included are an autonomous satellite retrieval experiment, dexterous robot experiment, on-orbit servicing platform, IVA robot and moon/planetary rovers proposed by NASDA or ISAS and other organizations.

1. INTRODUCTION

NASDA started the development of JEMRMS in 1987 and ETS-VII project in 1993. The ETS-VII robotics experiments will be carried out in 1997 and the JEMRMS in 2000 and the developments of these two robots are in progress. Space robotics is considered one of the most important technologies in space research and development. This is endorsed by a report recently submitted by the Committee at Science and Technology Agency on the long-term vision for space development (English version not available yet). In this report, space robotics is referred as crucial for future space exploitation beyond the turn of the century especially for moon/Mars missions. In addition to the concerns inside the space community, there are many researchers

interested in space robotics as a technical challenge in the area of robotics.

This report summarizes the space programs underway that are directly related to robotics, and secondly overviews the concept studies focusing on the space robotics inside the representative space organizations.

2. SPACE ROBOT RELATED PROJECTS

The space programs that are related to space robotics directly are the following three developed by NASDA: 1) JEMRMS, 2) JFD, and 3) ETS-VII.

2.1 JEMRMS

The manipulator attached to the Japanese Experiment Module (JEM) of the international space station is called JEM Remote Manipulator System (JEMRMS). The JEMRMS consists of a 10-meter main arm and a 1.6-meter small fine arm (SFA). Both arms have 6-DOF and are controlled by on-board crew using two 3-DOF hand controllers. The JEMRMS is currently scheduled to be launched in 2000 with the JEM pressurized module. The baseline configuration of JEM and JEMRMS is shown in Fig. 1.

2.2 JFD

The objective of the JEM Flight Demonstration (JFD) is to verify on-orbit maintainability of the JEM subsystems using JEMRMS and to provide an opportunity for operational experience for on-board crews and ground operators.

A sub-model of JEMRMS SFA will be launched on the shuttle cargo bay and controlled by on-board crews from the aft flight deck. Tasks

such as ORU exchange will be performed. The launch date of the shuttle with the JFD system is currently scheduled in 1997. Fig. 2 shows the concept of the JFD system.

2.3 ETS-VII

The main purpose of Engineering Test Satellite-VII (ETS-VII) shown in Fig.3 is to acquire the basic technology regarding rendezvous docking and space robotics. ETS-VII will be launched in 1997.

3. RESEARCH ACTIVITIES ON SPACE ROBOTICS

A number of researchers are now interested in space robotics in the near future, because there are various technical challenges in this field. NASDA is responsible for R & D in space applications with H-II rocket as launch vehicle, while ISAS is for scientific exploitation with M-V rocket. These two are leading organizations under the coordination of the Space Activities Committee. For future space robotics missions, there should be a tighter cooperation in some cases. In what follows, typical research topics are listed but this is not exhausted or authorized yet.

3.1 Dexterous Robot Experiment Using JEM

A dexterous robot concept is studied in NASDA in order to perform a portion of an astronaut's activities and to enhance on-orbit servicing capability in unmanned space systems. The JEM dexterous robot experiment will study and verify dexterous robot technologies using the JEM exposed facility. The implementation of the experiment is currently targeted in the first decade of the year 2000. Fig. 4 shows the basic concept of the experiment system.

3.2 On-orbit Servicing Platform

An unmanned platform, on which micro-gravity experiments, earth observing missions and other engineering experiments will be conducted, is currently being studied in NASDA. The platform has a robot system on board. Experiment samples and replacement units will be carried to the platform by supply satellites, and a robot arm on the platform will transfer and exchange them. Processed samples will be brought back to the earth by capsules. The concept of the system is shown in Fig. 5.

3.3 Autonomous Satellite Retrieval Experiment

Autonomous Satellite Retrieval Experiment (ASREX) is proposed by ISAS and refers to a space

experiment for retrieving a floating object with tumbling motion using a manipulator aboard a satellite. The tumbling object can be a disabled spacecraft which needs a repair operation. The proposed experiment will proceed as follows (see Fig. 6):

- (1) A chaser is inserted into low earth orbit.
- (2) A dummy target satellite is separated from the chaser using a manipulator aboard the chaser. The target is completely passive without any control capability which simulates a satellite whose functions have stopped.
- (3) When the distance between the target and the chaser gets about 20[km], the chaser searches for the target using a laser radar and tracks it.
- (4) The chaser makes a rendezvous with the target using the onboard guidance computer.
- (5) After the chaser comes within 20[m] from the target, the relative position and the relative attitude are estimated by processing the camera images.
- (6) The onboard manipulator is autonomously operated and the hand grabs the target.
- (7) After controlling the tumbling motion of the target, the manipulator retracts it using a force control algorithm.

For the realization of the autonomous system, many technical issues are to be investigated, and some of them are outlined in section 4.

3.4 IVA ROBOT

To maximize the on-orbit crew time, a concept of an Intra Vehicular Activity (IVA) robot which performs experimental activity or house keeping is an idea. Friendliness to crew members and an interface to experiment equipments are considered to be key technologies for IVA.

4. Research Areas for Future Space Robotics

Major research areas and technology issues related to the future advanced space robotics are listed in the in-house study of ISAS and NASDA. The following items are some of the research areas defined in these studies.

4.1 Laser Radar[1][2]

To hold a tumbling target satellite, the information on 3 dimensional position and attitude of the target with respect to the chaser is needed. A laser radar is the most promising candidate for this purpose. ISAS and NASDA have conducted a basic study on the

long range scanning type laser radar which covers 20[km] range. A breadboard model was developed and evaluated.

4.2 Visual Data Processing[2][3][4]

By processing the image data from the CCD (Coupled Charged Device) camera, the 6 degrees of freedom rotational and translational motion can be identified. Several methods have been proposed, two of which are as follows:

(a) Four of the corner cube reflectors are arranged on each of the target surfaces and by processing the reflected images of the laser radar, the particular surface which faces the chaser is identified. Then, using extended Kalman filter technique, the relative attitude and the relative position are estimated.

(b) Reflective markers are arranged along each of the straight edges of the target and the edges are detected by processing CCD camera images[3]. We have introduced a new algorithm for edge detection, where the CCD camera image is partitioned into small areas and the two parameters which describe the straight line in Hough transformation are statistically processed. In this method, a partially occluded or distorted line can easily be detected. Also, a new method for describing the rotational motion of the target without axis symmetry has been introduced where a rotation with complex nutation motion can be approximately described by superposition of conical motions. The extended Kalman filter is applied based on this simplified model.

4.3 Space Manipulator Control[5][6][7]

Several manipulator control schemes have been proposed.

(a) By introducing sliding mode control for grabbing a tumbling target satellite, the computation time is significantly reduced while the stability is guaranteed[5].

(b) After the completion of catching the tumbling target, the manipulator tries to retract it within allowable force. For this purpose, a new type of force control scheme using a sliding mode control is proposed[6]. Also, a new idea of redundancy in sliding mode control is introduced.

(c) When catching the target, much more time is consumed in visual data processing than in the calculation of control and so the degradation in control accuracy for tracking a moving object mainly comes

from the delay in the former. Hence, we have introduced prediction for setting the target position and attitude[7]. This has significantly reduced the achieved control accuracy.

4.4 Physical Simulation Using Test Bed[8]

ISAS has developed a 9 DOF (degree of freedom) space robotics simulator for the purpose of conducting a physical simulation of the ASREX on the ground[8]. The drawing and the picture of the robotics simulator are shown in Fig. 7 and Fig. 8 respectively. This simulator has 3 DOF for rotation motion for each of the chaser and the target and another 3 DOF for relative translation motion. The dynamics of the target and the chaser with the manipulator is solved by one of the three workstations and the 9 motors of the motion simulator are driven by the result. The control of the manipulator is carried out by another workstation while the image data is processed by the remaining one. The system configuration of the simulator is shown in Fig.9. The main features of the simulator are also summarized in Table 1.

5. Planetary Rover

Around the turn of the century, Mars exploitation is considered to be initiated with unmanned Mars rovers. NASDA and ISAS have been conducting concept studies on small and simple rovers launched by H-II rocket(rover weight is 450 [kg]) or M-V rocket(rover weight is 100 [kg]). The following summarizes the results of these studies.

5.1 Mission Analysis

(1)Engineering Missions

Main objective of the planetary rover is to establish various engineering techniques for future deep space missions such as :

- (a) Soft landing techniques using AI (Artificial Intelligence) to avoid obstacles which could potentially be found at the landing site,
- (b) Navigation techniques for autonomous planetary rover,
- (c) Tele-operation techniques for rover and instruments with time delay due to radio propagation,
- (d) Image processing techniques,
- (e) Weight reduction technique for the main structures

and the instruments.

(2) Science Missions

Candidates for the science missions are as follows:

- (a) Geology by photo images to provide for topographical survey, size and shape of rocks, composition of rocks, craters etc.
- (b) Element analysis of age using mass-spectrometer, element analysis using X-ray spectrometer, or g-ray spectrometer, study of mineral composition using visible or infrared reflection spectrometer etc.
- (c) Wide Area Investigation for magnetic anomalies using magnetometer, gravity anomalies, electromagnetic structure of the crust using VLF, seismological observation using seismometer network etc.
- (d) Investigation by Manipulator such as analysis of regolith, measurement of heat flux, element analysis etc.

5.2 System Overview

Various locomotion systems have been studied and 4-wheel system has been selected, because 4 wheels have advantages over caterpillars or articulated legs in terms of weight, simplicity and speed. As for drive motor, a brushless DC motor has advantages in terms of maintenance and life. A harmonic drive gear is used for deceleration. This locomotion system has ability to climb 30 degree slope. The speed of the rover is about 1 [km/hour] and the moving distance is about 1,000 [km/year].

5.3 Research Areas for Rover

Planetary rover covers a very wide variety of research areas. Followings are some of the research items.

(1) Path Planning[10][11]

A planetary rover is required to travel safely over a long distance for many days in unknown terrain. One of the important functions for planetary rover is to plan a path from a start point to a goal without hitting obstacles. A new path planning scheme has been proposed. The model of a rover is introduced to consider the size of the rover. This model can be easily modified into any other architecture. The planetary rover makes an elevation map by observing the environment. We have newly proposed EEM[Extended Elevation Map], which includes the effect of the size of the rover.

(2) Position Estimation[12][13][14]

A planetary rover needs to identify its position to reach a goal. Dead reckoning is one of the most widely used methods, which, however, has a drawback of inaccuracy due to the slipping of the rover tires. To supplement dead reckoning, we have proposed several methods as follows.

(a) The position and direction of the rover is obtained by observing the sun. Least squares method is used to estimate the position. This method has a position accuracy of about 1.0 [km], but during a long term trip, say for 6 months, this is very advantageous due to non-accumulation of errors.

(b) Three types of new map matching methods for 3-D terrain are proposed: differentiation map matching, altitude difference map matching and triangle map matching. The former two methods can be classified as template matching. where as the last method as structure matching. In these methods, terrain map information is used, which is derived from a laser range finder. The validity of the proposed methods is verified by computer simulations and experiments.

6. Conclusion

A brief summary is presented for the development status of space robot in Japan and for the research activities, mainly conducted by ISAS and NASDA, on orbiting spacecraft with robotics and planetary rovers. The authors wish that this article describes a very active research fields in Japan.

References

- [1] H.Saito, I.Nakatani, K.Ninomiya, A.Furuta, "Scanning Laser Radar System for Rendezvous and Docking in Space," Proc. of 38th Congress of the Int. Astronautical Federation, 1987.
- [2] I.Nakatani, T.Tanamachi, K.Ninomiya, "Satellite Motion Analysis via Laser Reflector Pattern Processing for Rendezvous and Docking," Proc. of 37th Congress of the Int. Astronautical Federation, 1986.
- [3] S.Azuma, I.Nakatani, K.Ninomiya, "A New Method for Autonomous Retrieval of a Satellite Using a Visual Sensor and a Manipulator," Proc. of 40th Congress of the Int. Astronautical Federation, 1989.
- [4] K.Ninomiya, I.Nakatani, T.Wakayama, "3D Motion

Estimation of an Object in Space by Image Processing"
Proc. of 30th Annual Conf. on SICE, 1991.

[5] K.Harima, J.Kawaguchi, I.Nakatani, K.Ninomiya, "Control of Space Manipulator Using Sliding Mode Control", Journal of Robotics Society, Vol.9-5, pp.572-579, 1991.

[6] K.Harima, J.Kawaguchi, I.Nakatani, K.Ninomiya, "Control of Redundant Space Manipulator Using New Sliding Mode", Journal of Robotics Society, Vol.9-7, pp.821-829, 1991.

[7] H.Nagamatsu, T.Kubota, I.Nakatani, "Experimental Study for Autonomous Retrieval of Tumbling Satellite by Space Manipulator", Proc. of 3rd Workshop on Astro-Dynamics and Flight Mechanics, pp.6-11, 1993.

[8] K.Ninomiya, et.al. , "Development of 9-DOF Space Robotics Simulator", Proc. of the 34th Annual Conf. on Space Sciences and Technology, pp.440-441, 1991.

[9] T.Iwata, I.Nakatani, "Overviews on the Japanese Activities on Planetary Rovers," Proc. of 43rd Congress of the Int. Astronautical Federation, 1987.

[10] T.Kubota, I.Nakatani, T.Yoshimitsu, "Path Planning for Planetary Mobile Robot", Proc. of ROBOMECH'94, 1994.

[11] I.Nakatani, T.Kubota, T.Yoshimitsu, "Path Planning for Planetary Rover Using Extended Elevation Map", i-SAIRAS'94, 1994.(to be presented)

[12] I.Nakatani, T.Kubota, T.Yoshimitsu, "Position Estimation for Planetary Rover by Observation of the Sun ", Proc. of 37th Annual Conf. on Space Sciences and Technology, pp.369-370, 1993.

[13] K.Ninomiya, I.Nakatani, T.Endo, "Map Matching Methods for Planetary Rover" Proc. of 32nd Annual Conf. on SICE, 1993.

[14] I.Nakatani, T.Kubota, N.Tanida, "Position Identification for Planetary Rover by Map Matching Using Characteristic Points" Proc. of 33rd Annual Conf. on SICE, 1994.

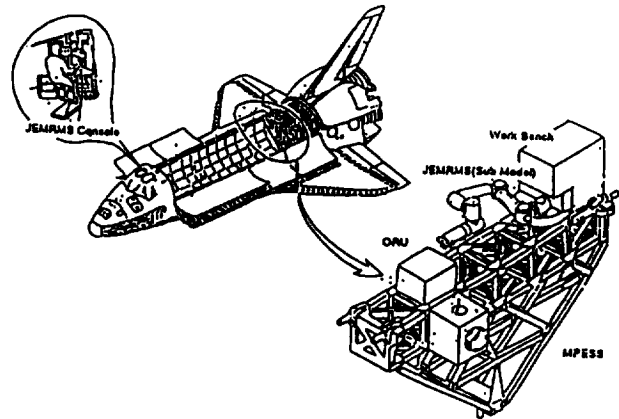

Fig. 2 JFD

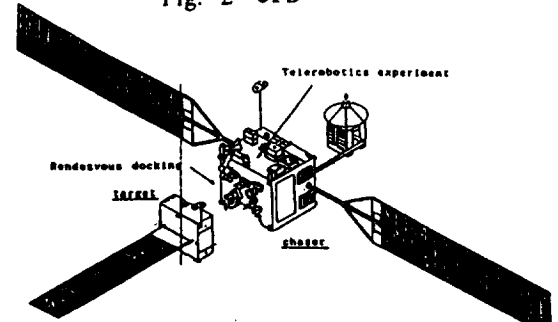

Fig. 3 On-orbit Configuration Baseline Configuration of ETS-VII

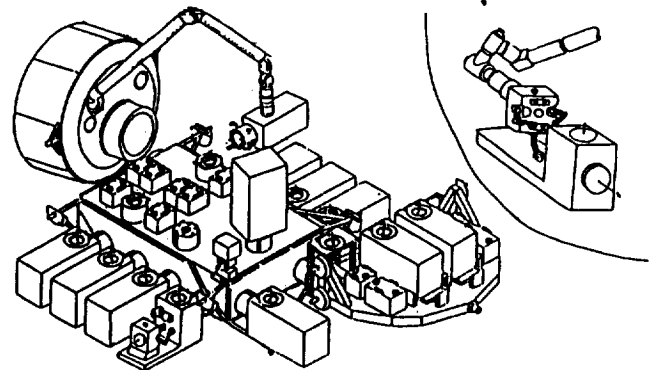

Fig. 4 Dexterous Robot Experiment Concept

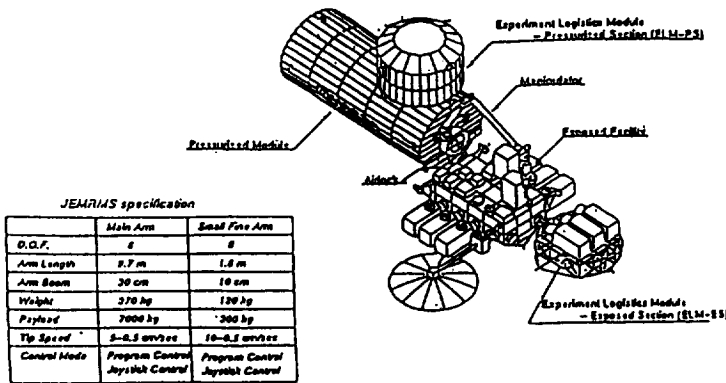

Fig. 1 JEM and JEMRMS

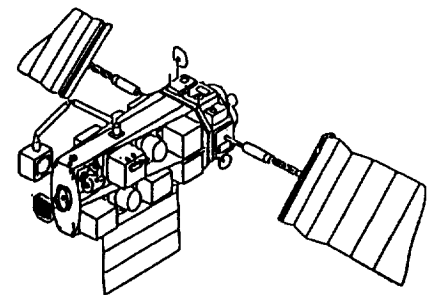

Fig. 5 On-orbit Servicing Platform

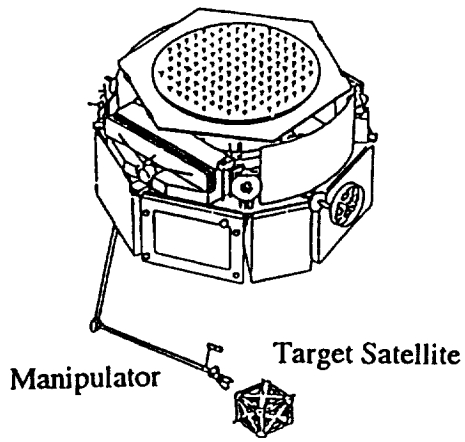

Fig. 6 Concept of ASREX

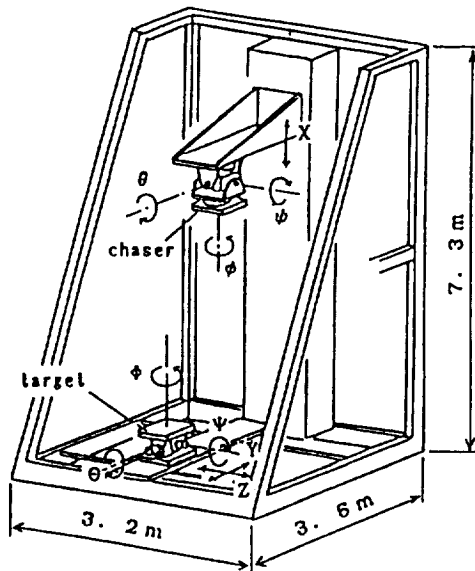

Fig. 7 Overview of robotics simulator

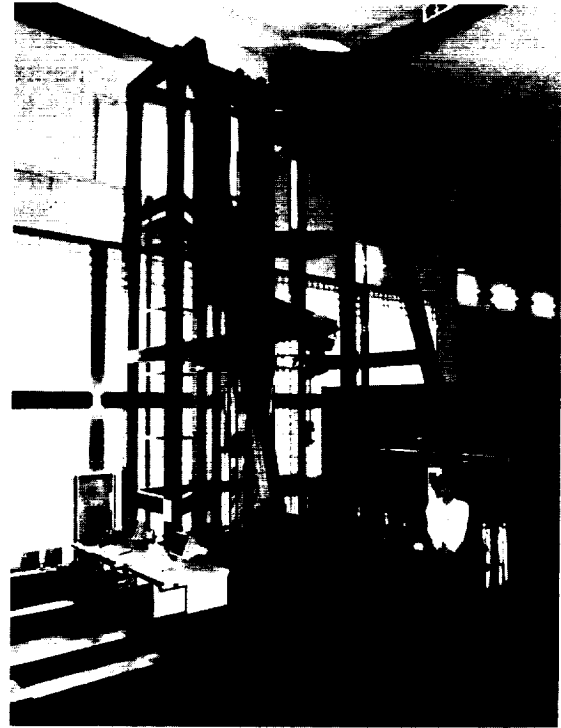

Fig. 8 Robotics Simulator

Table 1. Specification of simulator

Target Mount : payload weight 20[kg]				
direction	motion range	precision	maximum velocity	maximum torque
y	2.0 [m]	0.5 [mm]	0.2 [m/s]	150 [kgf]
z	2.0 [m]	0.5 [mm]	0.2 [m/s]	150 [kgf]
ϕ	± 180 [deg]	0.5 [deg]	30 [deg/s]	35 [Nm]
θ	± 40 [deg]	0.2 [deg]	20 [deg/s]	50 [Nm]
ψ	± 40 [deg]	0.2 [deg]	20 [deg/s]	50 [Nm]
Chaser Mount : payload weight 50[kg]				
x	4.0 [m]	1.0 [mm]	0.3 [m/s]	100 [kgf]
ϕ	± 180 [deg]	0.5 [deg]	30 [deg/s]	50 [Nm]
θ	± 20 [deg]	0.2 [deg]	20 [deg/s]	75 [Nm]
ψ	± 20 [deg]	0.2 [deg]	20 [deg/s]	75 [Nm]

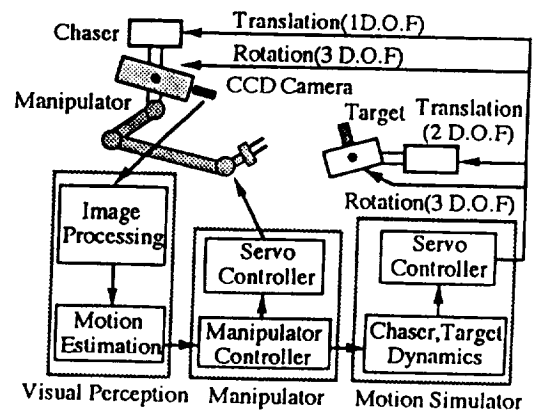

Fig. 9 System configuration of simulator