



Composite Materials Flown on the Long Duration Exposure Facility

*Pete E. George, Harry W. Dursch, and H. Gary Pippin
Boeing Defense & Space Group • Seattle, Washington*

Printed copies available from the following:

NASA Center for AeroSpace Information
800 Elkridge Landing Road
Linthicum Heights, MD 21090-2934
(301) 621-0390

National Technical Information Service (NTIS)
5285 Port Royal Road
Springfield, VA 22161-2171
(703) 487-4650

FOREWORD

This report describes the results from the testing and analysis of composite materials flown on the Long Duration Exposure Facility (LDEF). This work was carried out by Boeing under two Contracts, NAS1-18224, Task 12 (October 1989 through May 1991), and NAS1-19247, Tasks 1 and 8 (initiated May 1991). Sponsorship for these two programs was provided by the National Aeronautics and Space Administration, Langley Research Center (LaRC), Hampton, Virginia.

Mr. Lou Teichman, NASA LaRC, was the NASA Task Technical Monitor. Upon his retirement, Mr. Teichman was replaced by Ms. Joan Funk, NASA LaRC. Mr. Bland Stein, NASA LaRC, was the Materials Special Investigation Group Chairman, and was replaced by Ms. Joan Funk and Dr. Ann Whitaker, NASA Marshall Space Flight Center (MSFC), following Mr. Stein's retirement. The Materials & Processes Technology organization of the Boeing Defense & Space Group was responsible for providing the support to both contracts. The following Boeing personnel provided critical support throughout the program.

Bill Fedor	Program Manager
Sylvester Hill	Task Manager
Dr. Gary Pippin	Technical Leader
Pete George	Testing and Analysis
Harry Dursch	Testing and Analysis

Table of Contents

	<u>Page</u>
Foreword	iii
List of Tables	vi
List of Figures	vi
1.0 Introduction	1
2.0 LDEF Mission Profile	2
3.0 Results from Composite Experiments	6
3.1 AO019 - Influence of Extended Exposure in Space on Mechanical Properties of High-Toughness Graphite Epoxy Composite Material	6
3.2 AO054 - Space Plasma High-Voltage Drainage Experiment	6
3.3 AO134 - Space Exposure of Composite Materials for Large Space Structures	10
3.4 AO138-8 - Effect of Space Exposure of some Epoxy Matrix Composites on their Thermal Expansion and Mechanical Properties	10
3.5 AO138-9 - Effect of the Space Environment on Composite Materials	10
3.6 AO171 - Solar-Array-Materials Passive LDEF Experiment	10
3.7 AO175 - Evaluation of Long-Duration Exposure to the Natural Space Environment on Graphite-Polyimide and Graphite-Epoxy Mechanical Properties	13
3.8 AO180 - The Effect of Space Environment Exposure on the Properties of Polymer Matrix Composite Materials	13
3.9 M0003 - Space Environment Effects on Spacecraft Materials	13
3.10 P0005 - Space Aging of Solid Rocket Materials	16
3.11 S0010 - Exposure of Spacecraft Coatings	23
3.12 S1003 - Ion-Beam-Textured and Coated Surfaces Experiment	23
4.0 Coated Composites	24
5.0 Summary	25
6.0 References	26
Appendix	A-1

List of Tables

		<u>Page</u>
Table 1.	List of composite materials flown on LDEF	7
Table 2.	Average recession rates of specific composite materials flown on LDEF.	12
Table 3.	Erosion and optical data for certain uncoated composites as a function of exposure conditions.	14
Table 4.	Erosion and optical data for certain coated composites as a function of exposure conditions.	15
Table 5.	Summary of erosion data from laser profilometry scans on the T300/934 leading edge composite panel.	20

List of Figures

		<u>Page</u>
Figure 1.	Schematic diagram of the location(s) of each LDEF experiment.	3
Figure 2.	Atomic oxygen fluences for all row, longeron, and end-bay locations of LDEF.	4
Figure 3.	Solar ultraviolet fluence (equivalent sun hours of solar radiation normal to a surface) as a function of location on LDEF.	4
Figure 4.	NASA on-orbit photo of LDEF during retrieval.	5
Figure 5.	Photograph of composite specimen (A9) from row 12 experiment AO019 and diagram showing locations of post-flight profilometry measurements and in-flight orientation of this specimen.	8
Figure 6.	Laser profilometry scan over selected area of specimen from AO019. This scan is of the area marked "surface" in figure 5.	9
Figure 7.	NASA on-orbit photograph showing composite specimens of AO134 and S0010 on tray B9. The closed canister seen on this tray housed a duplicate set of S0010 specimens.	11
Figure 8.	NASA on-orbit photograph of tray D8 showing M0003 composite test specimens.	17
Figure 9.	NASA post-flight photograph of tray D4 showing M0003 composite test specimens.	18
Figure 10.	Pre-flight photo of coated T300 Graphite/934 Epoxy panel from experiment M0003, tray D9	19

List of Figures (con't)

	<u>Page</u>
Figure 11. Laser profilometry map of the T300/934 panel, including both A276 coated and bare areas shielded by a washer and both A276 coated and bare areas directly exposed to the space environment.	21
Figure 12. Microcrack density vs ply number for coated and bare areas of the T300/934 composite panel from tray D9.	22

1.0 INTRODUCTION

In this report, the types of composites flown on the Long Duration Exposure Facility (LDEF) are identified, essential findings summarized, recession data not previously published are presented, and references to published results for each composite related experiment are provided. Composite related summary discussions have also been published at a number of LDEF related meetings (refs. 1-5).

Almost all composite materials flown on LDEF were test specimens. The only non-experimental specimens among the composite materials are; 1) fiberglass shims used with the wire harness clamps on the interior of LDEF, 2) the fiberglass/epoxy viscous damper shroud mounted on LDEF's interior, and 3) the outer Teflon/fiberglass thermal blankets covering the batteries on experiment A0138. The fiberglass shims, shielded from LDEF's exterior environment, were only exposed to vacuum and thermal cycling. Minimal analysis was performed on the shims which showed all shims remained intact. The shims were discussed in the LDEF Interior Materials report (ref. 6) and will not be discussed further in this report. The viscous damper shroud was intact and appeared visually to be in excellent condition post-flight. The only measurement on this hardware was a measurement of peel strength of the aluminum tape (ref. 7) which covered the fiberglass shroud. The tape was in good condition post-flight and the peel strength was nominal. Results from testing of the two A0138 Teflon/fiberglass thermal blankets, exposed on LDEF's trailing edge (tray B3), showed some erosion of the Teflon matrix. Because of the minimal atomic oxygen exposure, the erosion was thought to be induced by the combination of UV and thermal cycling (ref. 8).

2.0 LDEF MISSION PROFILE

The LDEF was a large (about 9 meters in length, 4.3 meters in diameter), reusable, unmanned spacecraft to accommodate technology, science, and applications experiments which require long-term exposure to the space environment. LDEF was designed to be transported into space in the payload bay of a Space Shuttle, free-fly in low Earth orbit (LEO) for an extended time period, and then be retrieved by a Shuttle during a later flight. The LDEF was passively stabilized, and each surface maintained a constant orientation with respect to the direction of motion.

The LDEF was deployed by the Shuttle Challenger into a 482 km. nearly circular orbit with a 28.4 degree inclination on April 7, 1984. The planned 10-month to 1-year mission carried 57 experiments. A schematic diagram of the location(s) of each experiment on LDEF is shown in figure 1. Due to schedule changes and the loss of the Space Shuttle Challenger, the duration of this flight was extended well beyond the original planned exposure period. The levels of exposure to atomic oxygen and solar radiation as functions of position on the LDEF are shown in figures 2 and 3, respectively.

The LDEF was retrieved by the Space Shuttle Columbia on January 12, 1990 after spending 69 months in orbit. A photo of the LDEF during retrieval operations is shown in figure 4. During these 69 months, LDEF completed 32,422 orbits of Earth and decreased in altitude to 340 km., where it was grappled, photographed extensively from the Shuttle crew cabin, and then placed in the Shuttle payload bay for return to Earth. The LDEF remained in the payload bay of the Space Shuttle Columbia for the landing at Edwards Air Force Base and during the ferry flight to Kennedy Space Center (KSC). The LDEF was removed from Columbia at KSC and brought to the Spacecraft Assembly and Encapsulation Building (SAEF-2) where the LDEF and its experiments were examined visually and photographed, radiation measurements were conducted, and the experiments removed from the structure tray by tray. Each tray was photographed individually subsequent to removal. System level tests were carried out for particular experiments and support hardware. External surfaces were examined for evidence of impacts, contamination, and other exposure induced changes.

BAY ROW	A	B	C	
1	A0175	S0001	GRAPPLE	
2	A0178	S0001	A0015, A0187, M0006	
3	A0187	A0138	A0023, A0034, A0114, A0201	TRAILING EDGE
4	A0178	A0054	S0001	
5	S0001	A0178	A0178	P0005 P0003
6	S0001	S0001	A0178	
7	A0175	A0178	S0001	
8	A0171	S0001, A0056, A0147	A0178	
9	S0069	S0010, A0134	A0023, A0034, A0114, A0201	LEADING EDGE
10	A0178	S1005	GRAPPLE	
11	A0187	S0001	A0178	
12	S0001	A0201	S0109	

BAY ROW	D	E	F
1	A0178	S0001	S0001
2	A0189, A0172 S0001	A0178	P0004, P0006
3	M0003, M0002	A0187, S1002	S0001
4	M0003	S0001	A0178
5	A0178	S0050, A0044, A0135	S0001
6	A0201, S0001	A0023, S1006 S1003, M0002	A0038
7	A0178	S0001	S0001
8	M0003	A0187	M0004
9	M0003, M0002	S0014	A0076
10	A0054	A0178	S0001
11	A0178	S0001	S0001
12	A0023, A0019, A0180	A0038	S1001

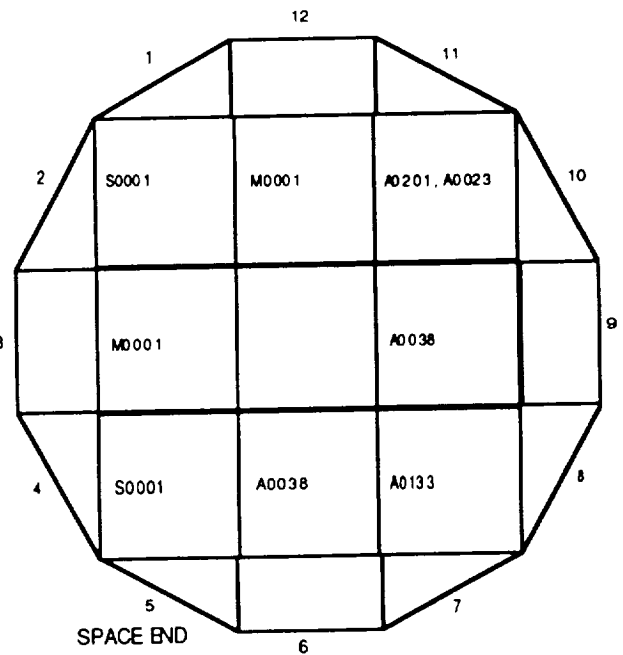
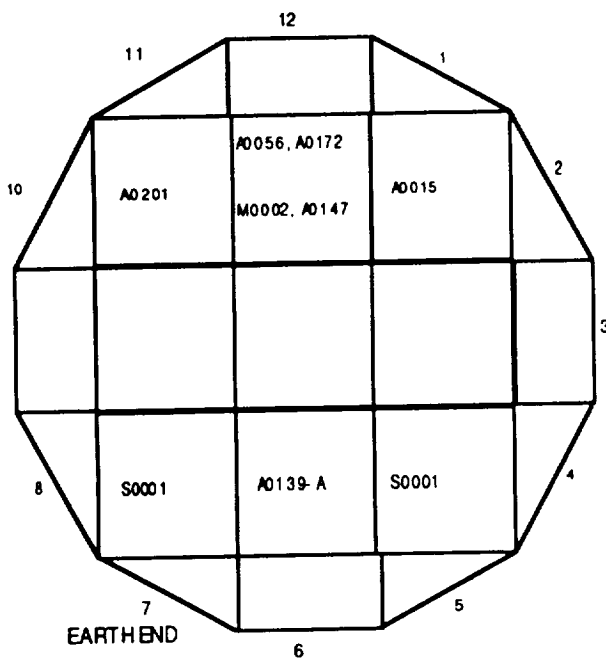

Figure 1. Schematic Diagram of the Location(s) of each LDEF Experiment.

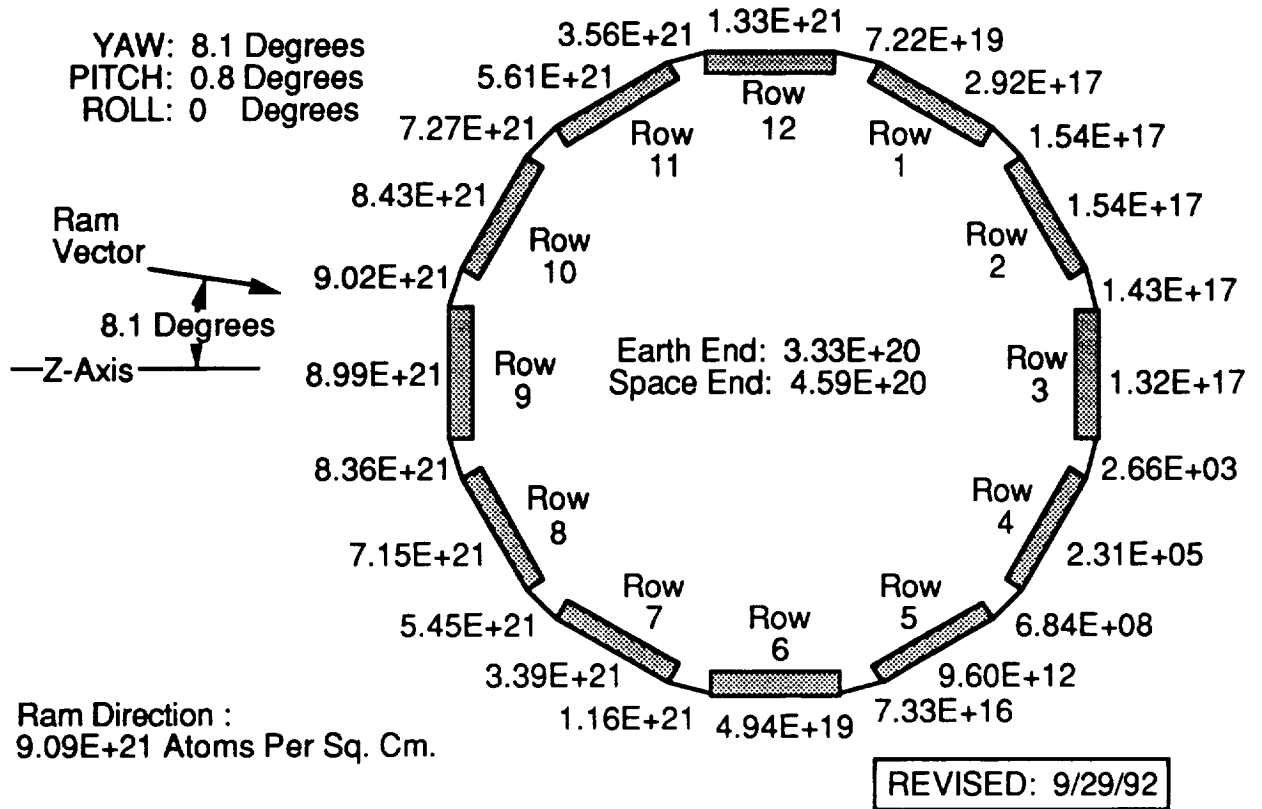

Figure 2. Atomic Oxygen Fluences for all Row, Longeron, and End-bay Locations of LDEF.

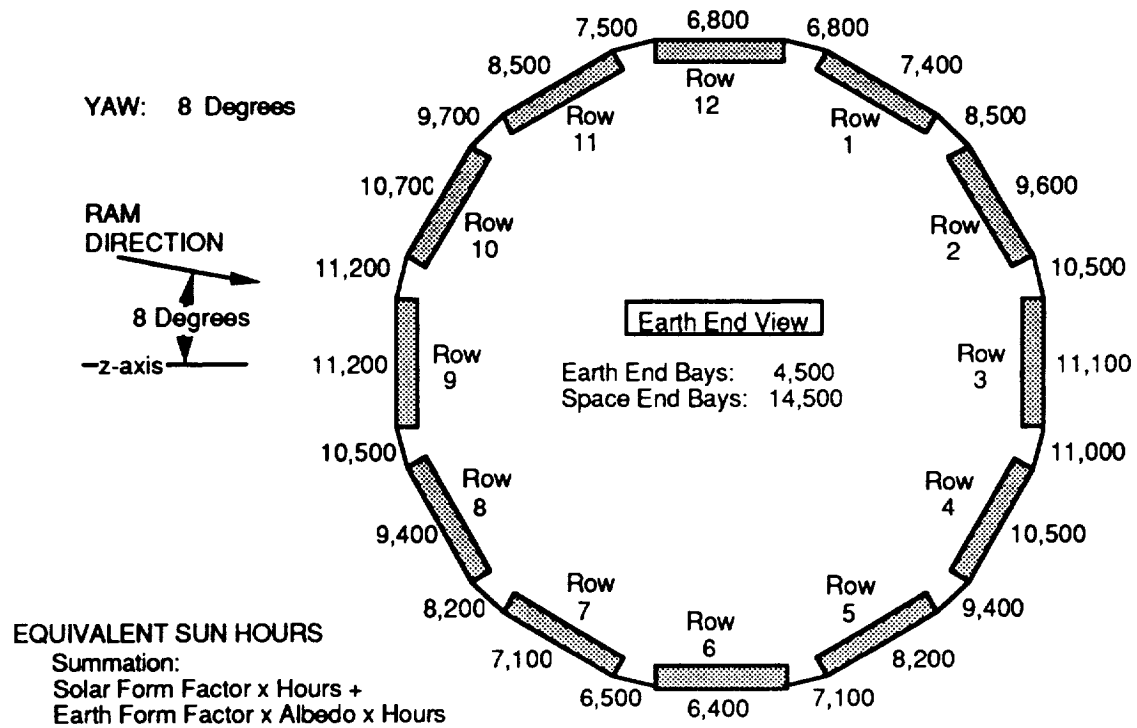
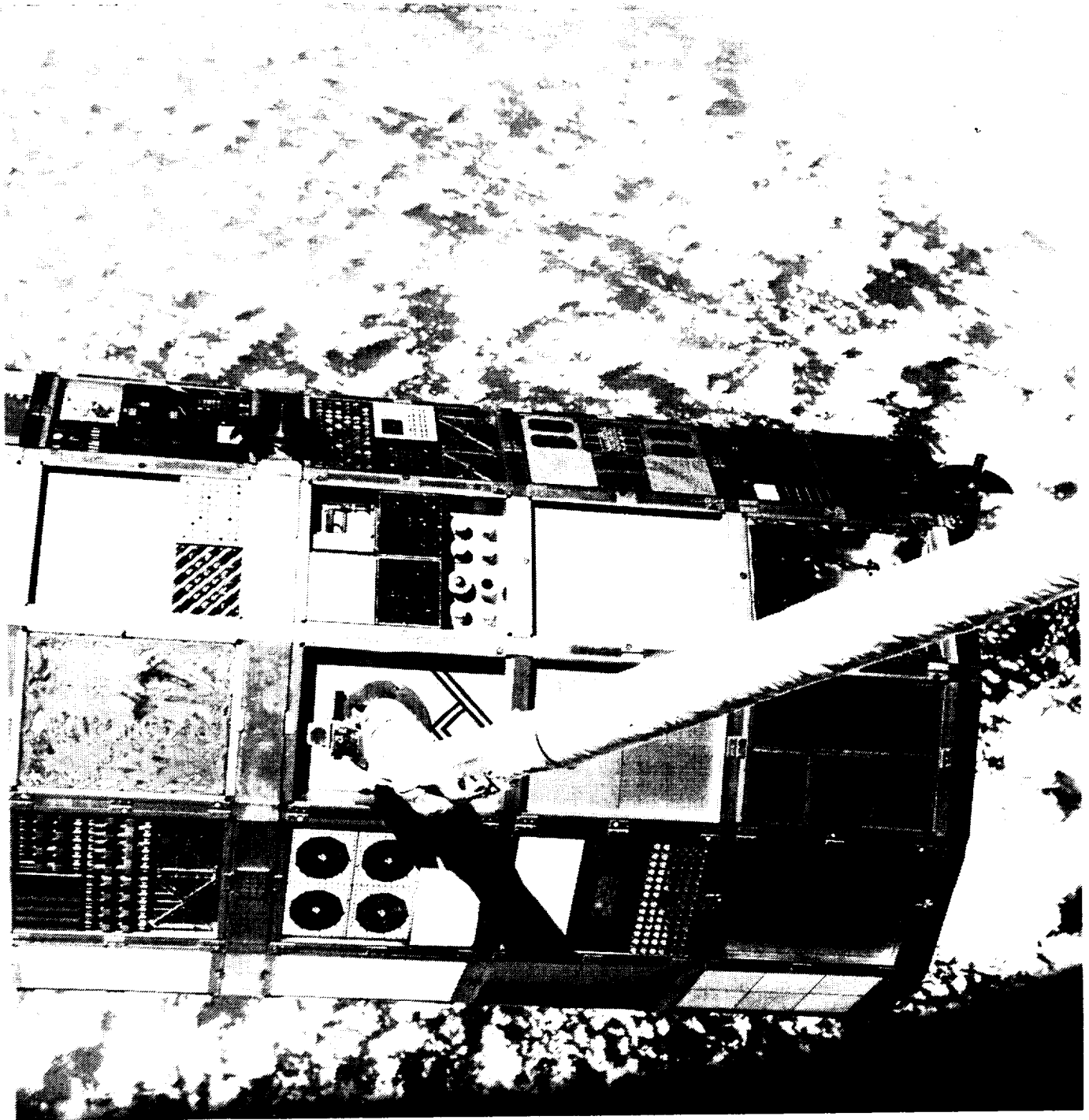

Figure 3. Solar UV Fluence (Equivalent Sun Hours of Solar Radiation Normal to a Surface) as a Function of Location on LDEF.



L-90-10481

Figure 4. NASA on-orbit photo taken during retrieval showing Rows 12-3, including several trays, A1, B3, D3, and D12, which each contained a number of composite specimens.

3.0 RESULTS FROM COMPOSITES EXPERIMENTS

Eight experiments from LDEF were either completely or partially dedicated to evaluation of composite materials. These experiments were designed to evaluate the effects of space exposure on a variety of mechanical, physical and optical properties of selected composites. Table 1 lists the composites flown on LDEF and the experiment(s) on which each material was flown.

3.1 AO019 - Influence of Extended Exposure in Space on Mechanical Properties of High-Toughness Graphite Epoxy Composite Material

Elastic modulus, strength, and fracture toughness was determined for T300/5208 graphite epoxy composite alternated with layers of perforated mylar. The unique material (refs. 9 & 10) was produced with intermittent interlaminar bonding in order to improve the fracture toughness properties. Pre-flight and post-flight measurements were made on two sets of ground control specimens, and on the flight specimens. Space exposure decreased the fracture toughness by roughly a factor of two relative to the control specimens. Similar tensile values were obtained for the flight tensile specimens and the control specimens. This experiment flew on tray D12, located 82-degrees from ram.

Selected areas on the space exposed side of tensile specimen A9 from AO019 were examined by laser profilometry. Two line scans were obtained at either end of the specimen. Each line scan was about 5 cm in length, starting at an exposed location and ending at a location which was covered on-orbit. The locations of the scans on the specimen and the orientation of the specimen with respect to ram is shown in figure 5 (this figure also contains a full size photo of the scanned specimen). The line scans labeled step 1 and step 2 show only the rough texture of the surface and no net recession in the exposed areas. Because of the extreme impingement angle (82 degrees) of atomic oxygen, the sample holder blocked atomic oxygen from attacking the "exposed" areas at this end of the specimen. By contrast, the line scans labeled step 3 and step 4 show distinct steps (40-120 microns) between the exposed and unexposed areas at this end of the specimen. In figure 6 a scan of an area adjacent to the step 3 location shows the texture of the composite surface and the apparent recession. The line scans for steps 1 - 4 are shown on pages 24-27 of Appendix A.

3.2 AO054 - Space Plasma High-Voltage Drainage Experiment

Panels of 0.188 inch thick fiberglass/epoxy coated on their exposed side with A276 white thermal control paint were used to hold specimens on this experiment. These panels survived the LDEF mission intact. A brief discussion of the characteristics of impacts on this surface is included in the report on this experiment (ref. 11).

Experiment #	Composite Materials
AO019	T300 interleaved with Kapton/5208
AO134	T300/5208, T300/934, C6000/P1700, C6000/P1700, GY70/930
S0010	Graphite/epoxy (coated and uncoated)
AO138-8	T300/V108, GY70/V108, GY70/BSL 914, GY70/code 87, T300 fabric/V108
AO138-9	GY70/934, Kevlar/V-108, G837/V108, GY70/V108
AO054	Fiberglass/epoxy
AO175	T300/F178, C6000/PMR-15, T300/934, C6000/LaRC-160
AO171	HMS/934, P75S/934, HMF/P1700, S-Glass/epoxy
AO180	T300/934, T300/5208, T300/SP288, SP328 Kevlar/epoxy, SP290 Boron/epoxy
M0003-8	T300/934, T300/P1700, C6000/PMR-15, Coated specimens
M0003-9	GY70/CE339, T50/F263, T50/934, T50/X904B, T50/E788, HMS/3501-5A, C6000/E788, P75/934, HMF176/934, E-Glass/CE339, P75/F593
M0003-10	GY70/X904B, HMS/3501-5A, E-Glass/X904B, GY70/X-30, GY70/CE339, P75S/CE339, P75S/934, GY70/934, W722/P1700, T300/V378A, T300/5208, T300/P1700, T300/PES, C6000/Polyimide, T300/934, AS/3501-6, C6000/PMR-15, Graphite/LaRC-160, Coated specimens
P0005	Carbon/carbon, Graphite/epoxy, Kevlar/epoxy, Glass/epoxy

Table 1. Composite Materials flown on LDEF

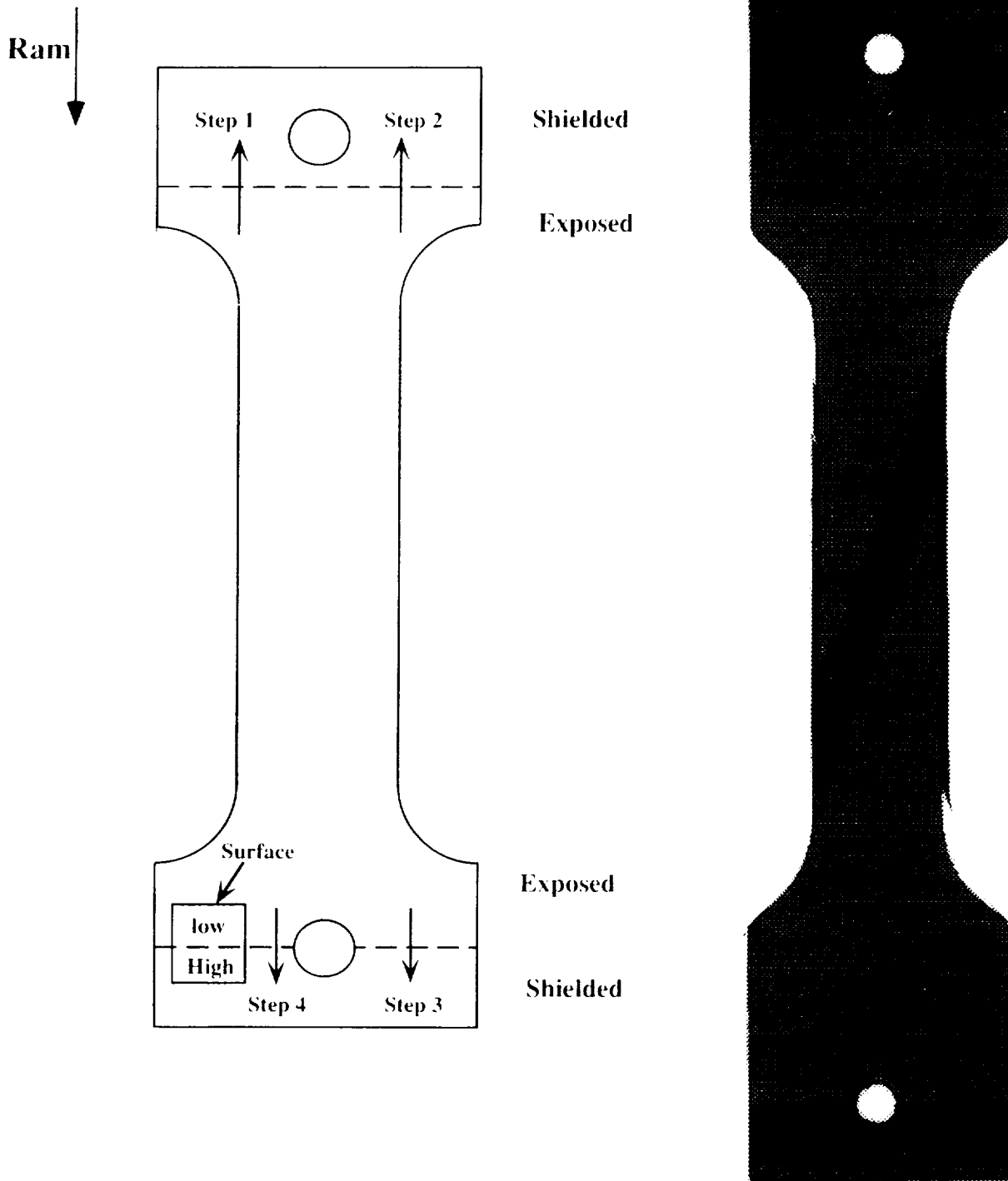

Figure 5. Photograph of composite specimen (A9) from row 12 Experiment AO019 and diagram showing locations of post-flight profilometry measurements and in-flight orientation of this specimen.

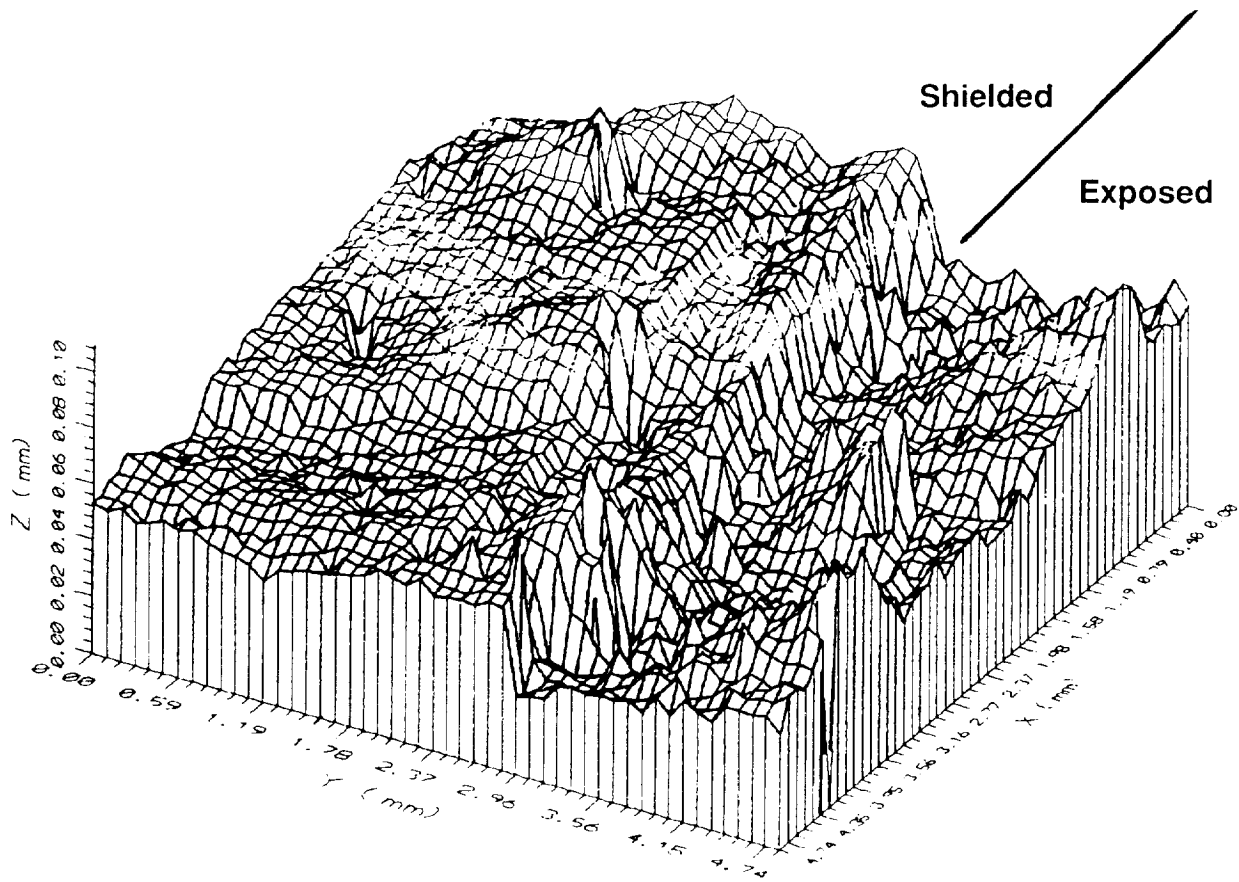

Figure 6. Laser profilometry scan over selected area of specimen AO019. This scan is of the area marked "surface" in figure 5.

ORIGINAL PAGE IS
OF POOR QUALITY

3.3 AO134 - Space Exposure of Composite Materials for Large Space Structure

Mechanical and chemical properties of graphite/polysulfone and graphite/epoxy materials were evaluated post-flight. These materials were flown on tray B9 (ref. 12). Specific materials flown were C6000/P1700, T300/934, and T300/5208. Results show preferential loss of resin compared to fiber. The decrease in tensile and modulus properties was due to atomic oxygen induced erosion of material. Figure 7 shows an on-orbit photo of tray B9, which includes this experiment, taken as part of the retrieval photo survey.

3.4 AO138-8 - Effect of Space Exposure of some Epoxy Matrix Composites on their Thermal Expansion and Mechanical Properties

Two identical sets of composite materials were flown on this trailing edge experiment (tray B3). Measurement results for both sets of materials are reported in the first symposium proceedings (refs. 13 & 14). One set of materials was positioned within the canister used on this experiment and were only directly exposed to exterior space environment for the first 9 months of the mission. Specimens included epoxy resin face sheet-aluminum core honeycomb sandwich structures, unidirectional graphite epoxy mechanical test specimens and graphite fabric/epoxy. No evidence of property changes was found for these materials.

3.5 AO138-9 - The Effect of the Space Environment on Composite Materials

Another set of materials were flown to evaluate changes in the coefficient of thermal expansion (CTE) due to space exposure, changes in simple elements and honeycomb sandwich assemblies, and to compare performance of two epoxy resins (ref. 14).

3.6 AO171 - Solar-Array-Materials Passive LDEF Experiment

Three carbon fiber (HMF 322/P1700, HMS/934, and P75S/934) and one glass fiber (S-glass/epoxy) composite systems were evaluated on this experiment (ref. 15). AO recession data for these materials are included in table 2, in which recession data is presented for leading edge and near-leading composites flown on LDEF's exterior.

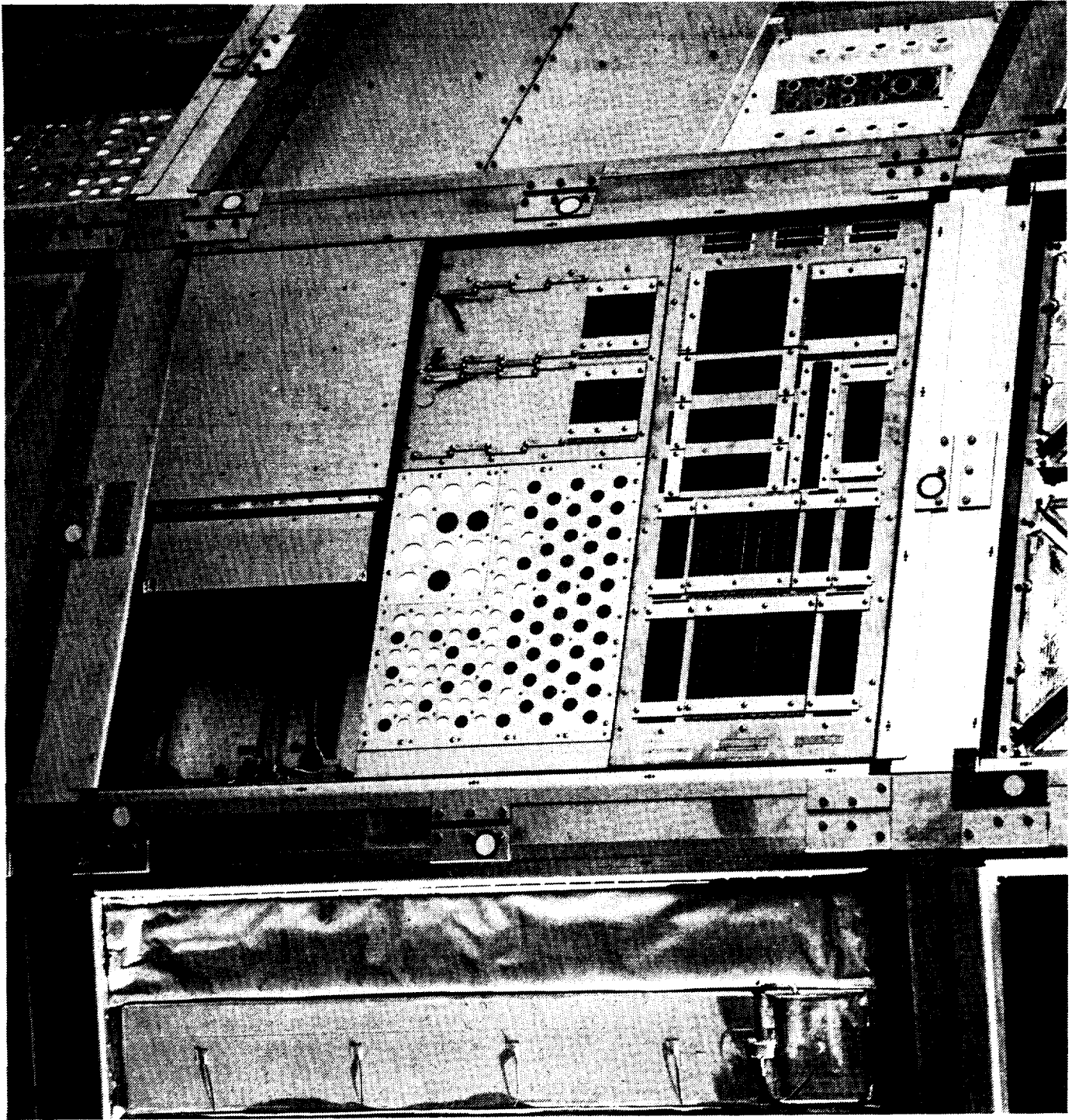

L-90-10374

Figure 7. NASA on-orbit photograph showing composite specimens of AO134 and S0010 on tray B9. The closed canister seen on this tray housed a duplicate set of S0010 specimens.

Location (row #)	Material	Recession Technique	Recession Rate (10E-24 cm ³ /atom)
9	AS/3501-6	mass loss	0.8
9	C6000/PMR-15	mass loss	1.2
9	Gr/LaRC-160	mass loss	0.9
9	T300/P1700	mass loss	1.1
9	T300/P1700	cross-section	1.05
9	T300/934	mass loss	0.3
9	T300/934	cross-section	1.03
9	Gr/PMR-15	cross-section	1.53
9	T300/934	laser profilometry	0.82, 0.91, 0.99, 1.00*
9	GY70/CE339	cross-section	0.73
9	T300/934	unknown	1.01
9	Kevlar/epoxy	cross-section	0.7-1.2**
12	T300/934	cross-section	1.6
12	T300/5208	cross-section	1.3
12	T300/5208	cross-section	1.5
8	T300/934	unknown	1.15
8	GY70/CE339	cross-section	0.79, 0.70
8	T300/934	cross-section	0.86, 0.84
8	T300/PS-C	cross-section	0.91
8	T300/PES-C	cross-section	0.77
8	P1700/HMF322	profilometry	0.89 - 2.2**
8	HMS/934	profilometry	0.96, 0.89
8	P75S/934	profilometry	0.96, 0.99
8	S-glass/epoxy	profilometry	0.13
7	C6000/PMR-15	cross-section	0.89

* Four measurements from one large specimen

** Range of measurements

Table 2. Recession rates of selected composites determined by mass loss, cross-sectioning, or profilometry techniques (each value is an individual specimen unless noted).

3.7 AO175 - Evaluation of Long-Duration Exposure to the Natural Space Environment on Graphite-Polyimide and Graphite-Epoxy Mechanical Properties

Rockwell Corp. flew a variety of graphite fiber reinforced resin matrix composites. Composite laminates made from T300/934 epoxy and C6000/LaRC-160 polyimide, and a bonded honeycomb sandwich panel with T300/934 facesheets and a Nomex core were flown on tray A1. Laminates made from T300/F178 bismaleimide and C6000/PMR-15 were flown on a near leading edge environment (tray A7). Measured weight loss on the tray A7 specimens corresponds to an erosion depth of 40-microns if all weight loss was due to AO erosion. Some on-orbit microcracking was observed, caused by the thermal cycling. Many mechanical tests were carried out on each of these materials. Rockwell concluded that the structural performance of these materials was not measurably changed by their in-flight exposure (ref. 16).

3.8 AO180 - The Effect of Space Environment Exposure on the Properties of Polymer Matrix Composite Materials

The University of Toronto experiment contained several composite material systems and provided significant amounts of temperature and dimensional change data as a function of time for the first year of the LDEF mission (refs. 17-19). Depending on the specific material, significant outgassing occurred for periods of the first 40 to 120 days on-orbit. This caused significant dimensional changes, as measured on-orbit (ref. 20). A comprehensive investigation of these materials has been carried out, including examination of impacts, recession due to atomic oxygen, mechanical and optical properties where appropriate. The investigators also carried out examination of specimens provided by several other experimenters. Results from this survey are included in tables 2-4.

3.9 M0003 - Space Environment Effects on Spacecraft Materials

The M0003 experiment flown by The Aerospace Corporation, included opportunities for a number of organizations to fly their own sub-experiments (refs. 21-23). A large set of composite specimens, both uncoated and coated, were flown as part of this experiment, on trays D8, D9, D3, and D4.

The Aerospace Corporation also flew their own set of organic composite materials (refs. 24-26) and several metal matrix composite materials. A detailed description of the performance of the metal matrix composites is included in references 27 and 28. Results show the graphite/aluminum and graphite/magnesium were more resistant to atomic oxygen and less susceptible to thermal cycling induced microcracking than organic composites.

Material	Angle from ram (degrees)	AO fluence (atoms/cm ²)	UV (ESH)	α		ϵ		Erosion (microns)
				front	back	front	back	
U. of Toronto Institute for Aerospace Studies Specimens								
T300/934	82	1.33x10 ²¹	6900	0.81	0.83	0.70	0.80	21.5
T300/5208	82	1.33x10 ²¹	6900	0.87	0.88	0.71	0.80	17.7
Lockheed Specimens								
GY70/CE339	8	8.99x10 ²¹	11100	0.98	0.88	0.92	0.80	65.4
GY70/CE339	172	1.32x10 ¹⁷	11100	0.86	0.88	0.80	0.79	none
Rockwell Specimens								
T300/934	112	2.92x10 ¹⁷	7500	0.89	0.90	0.79	0.87	none
C6000/PMR15	68	3.39x10 ²¹	7200	0.88	0.90	0.75	0.84	30.1
Boeing Specimens								
T300/934	8	8.99x10 ²¹	11100	0.94	0.84	0.94	0.84	90.7
T300/934	38	7.15x10 ²¹	9400	0.89	0.83	0.89	0.83	82.2
T300/934	172	1.32x10 ²¹	11100	0.77	0.80	0.77	0.80	none
T300/934	158	2.31x10 ⁵	10400	0.83	0.82	0.83	0.82	none
U of Michigan Specimen								
T300/5208	82	1.33x10 ²¹	6900	0.86	0.86	0.66	0.63	20.1
General Dynamics Specimens								
GY70/CE339	38	6.93x10 ²¹	9400					56.3, 50.0
T300/934	38	6.93x10 ²¹	9400					61.3, 60.0
McDonnell Douglas Specimens								
T300/PS-C	38	6.93x10 ²¹	9400					65.0
T300/PES-C	38	6.93x10 ²¹	9400					55.0
T300/PS-C	172	1.32x10 ¹⁷	11100					none

Table 3. Erosion and optical data for uncoated composites as a function of exposure conditions (ref 35).

Material	Angle from ram (degrees)	AO fluence (atoms/cm ²)	UV fluence (ESH)	α	ϵ
S13G Coating					
T300/5208	158	2.31x10 ⁵	10500	0.37, 0.36	0.88, 0.87
T300/PES	158	2.31x10 ⁵	10500	0.34, 0.31	0.80, 0.88
T300/PES	158	2.31x10 ⁵	10500	0.32, 0.32	0.89, 0.88
T300/5208	38	7.15x10 ²¹	9400	0.19, 0.19	0.88, 0.87
T300/P1700	38	7.15x10 ²¹	9400	0.21, 0.22	0.88, 0.88
T300/PES	38	7.15x10 ²¹	9400	0.18, 0.19	0.88, 0.87
T300/PES	Ground Control	0	0	0.14, 0.13	0.90, 0.89
Leafing Aluminum Coating					
T300/5208	158	2.31x10 ⁵	10500	0.75, 0.75	0.78, 0.78
T300/PES	158	2.31x10 ⁵	10500	0.76, 0.76	0.78, 0.78
T300/PES	Flight Control	0	0	0.67, 0.67	0.79, 0.79
T300/P1700	38	7.15x10 ²¹	9400	0.60, 0.61	0.73, 0.74
	Ground Control	0	0	0.66	0.79
A276 Coating					
T300/PES	Flight Control	0	0	0.31, 0.31	0.90, 0.89
T300/P1700	38	7.15x10 ²¹	9400	0.29, 0.29	0.94, 0.93

Table 4. Erosion and optical data for coated composites as a function of exposure conditions.

Figure 8 shows an on-orbit photo of tray D8 and part of tray D9, showing the large number of composite test specimens flown on this experiment. Figure 9 is a post-flight photo of tray D4 showing the companion set of composite specimens to those from D8. The Boeing portion of this experiment included an 11.75" x 16.75" T300/934 panel flown on tray D9 (refs. 29-31). The panel is visible in the lower right hand corner of figure 8. This panel was divided into four quadrants. One quadrant was bare composite, one was coated with A-276 polyurethane based white paint, one with Z-306 black polyurethane based paint, and one with Boeing Material Specification (BMS) 10-60 polyurethane based white paint. A photo of this panel is shown in figure 10. The panel was held in place by eight bolts each with a one inch diameter washer. These washers shielded small areas of each part of the panel which served as on-orbit controls for recession measurements and degradation evaluations. These measurements provide recession data for bare T300/934 composite, A276 and BMS 10-60 white thermal control paints, and Z306 black thermal control paint. Table 5 is a summary of the recession data for exposed areas near the various washers. Locations of laser profilometry measurements around each of these shielded areas are included in Appendix A along with their respective profilometry scans. Figure 11 shows a detailed three-dimensional laser profilometry scan in the area of a panel washer. A study of microcrack density as a function of ply number for each of the areas on the panel was also performed. Results of this study are shown in figure 12. It can be clearly seen that areas under the white coatings, which decreased the temperature range of the thermal cycles in comparison with the areas under black surfaces, suffered much less microcracking.

3.10 P0005 - Space Aging of Solid Rocket Materials

Thiokol Corp. flew materials used on Thiokol STAR motors. Included in this experiment were both 2D and 3D carbon-carbon (C-C) specimens and carbon-phenolic sandwich specimens. The 2D C-C materials were representative of STAR motor exit cones and the 3D C-C material was used on nozzle throats. All the P0005 specimens were contained in a stainless-steel container mounted on LDEF's interior frame assembly. The container had a vent valve designed to open in space and close during the return to Earth. Control specimens were kept throughout the mission. Results show the phenolic resin based specimens lost more weight than other specimens due to the loss of volatiles, water, and propyl alcohol, which are byproducts of the phenolic cure reaction (ref. 32). Mechanical testing of both C-C flight and control specimens showed no significant changes.

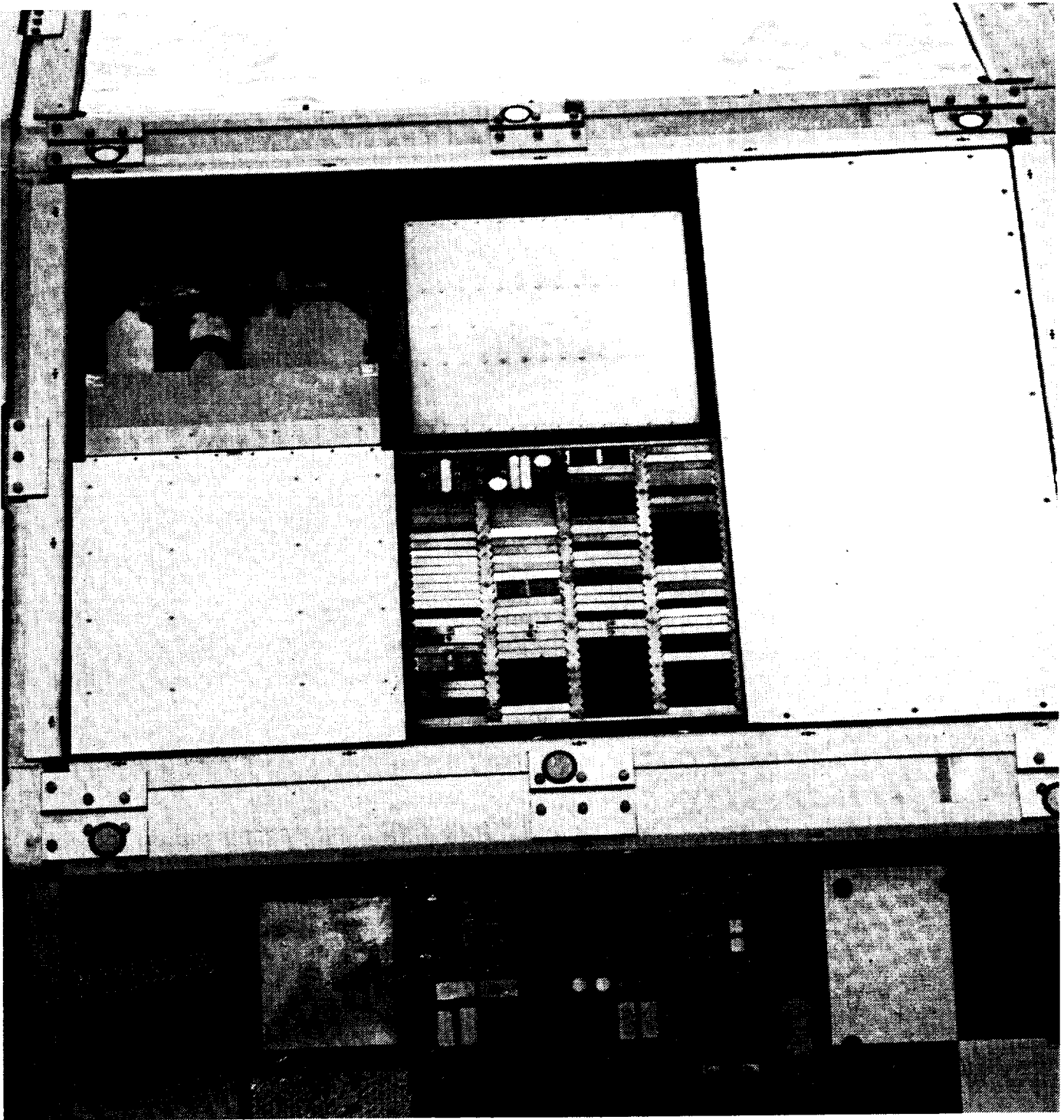

L-90-10377

Figure 8. NASA on-orbit photograph of tray D8 showing M0003 composite test specimens.

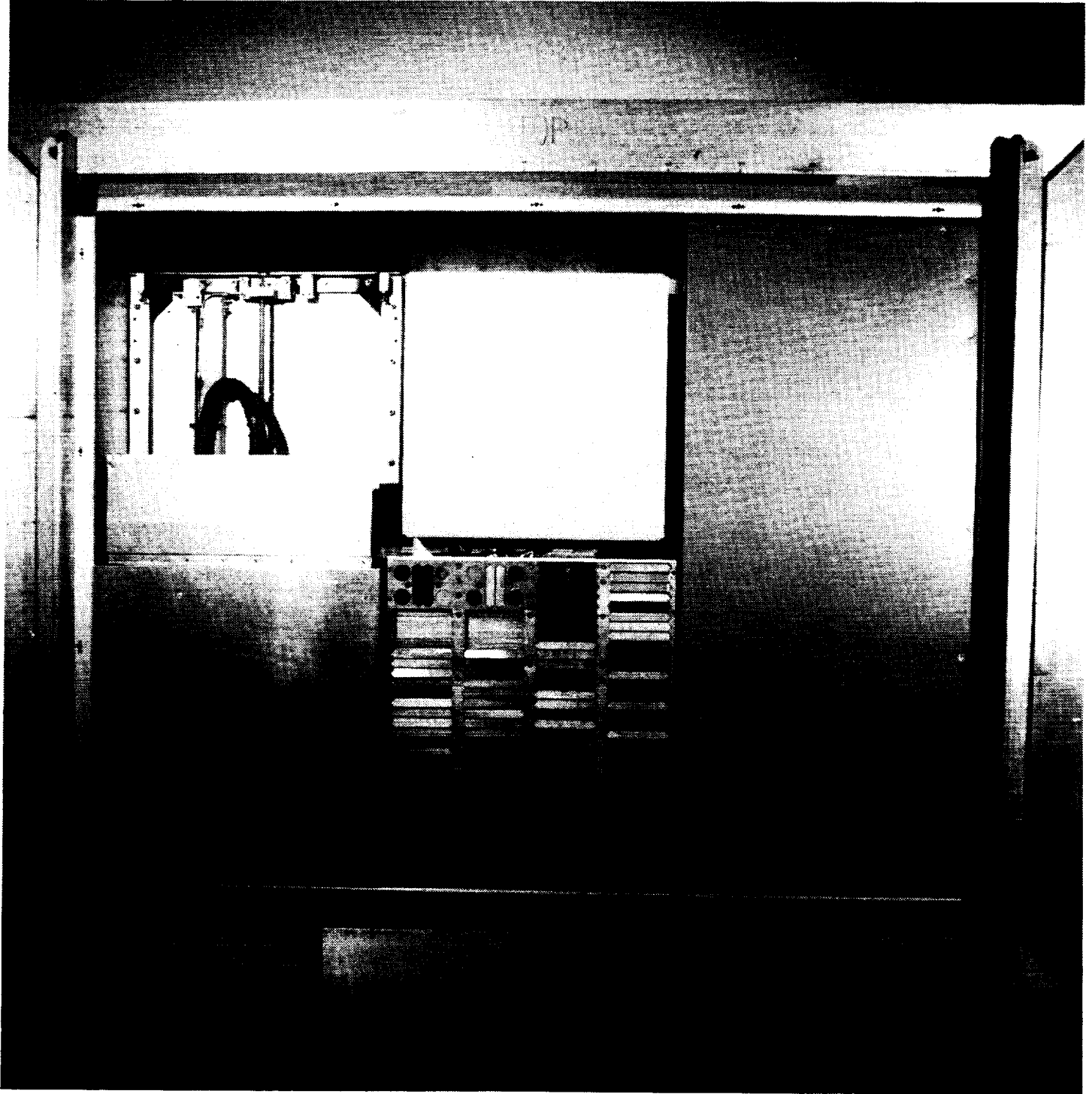

Figure 9. NASA post-flight photograph of tray D4 showing M0003 composite test specimens.

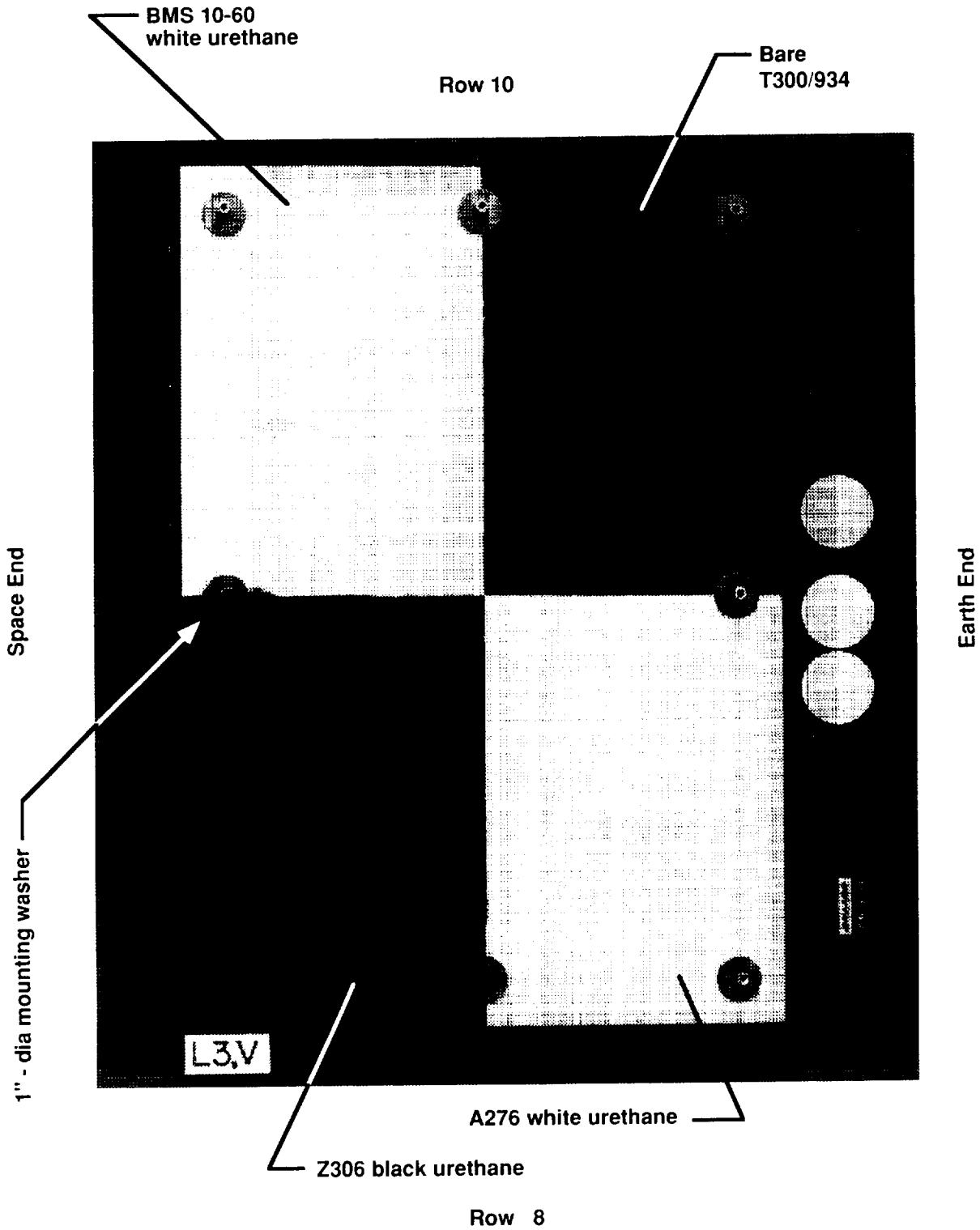

Figure 10. Pre-flight photo of coated T300 Graphite/934 Epoxy panel from experiment M0003, tray D9

Recession Measurement Location Measured Erosion (mils)

T300/934 Recession Data

Bare T300/934 (page A-2)	3.42
Bare T300/934 (page A-3)	3.51
Bare T300/934 (page A-4)	3.23
Bare T300/934 (page A-5)	2.92

A276 Recession Data

A276 (page A-7)	0.35
A276 (page A-8)	0.34
A276 (page A-9)	0.43
A276 (page A-10)	0.26
A276 (page A-11)	0.17
A276 (page A-12)	0.24

BMS 10-60 Recession Data

BMS 10-60 (page A-14)	0.28
BMS 10-60 (page A-15)	0.38
BMS 10-60 (page A-16)	0.30
BMS 10-60 (page A-17)	0.17
BMS 10-60 (page A-18)	0.32
BMS 10-60 (page A-19)	0.40

(Page A-x denotes location of profilometry scan)

Table 5. Summary of erosion data from laser profilometry scans on the T300/934 leading edge composite panel. Appendix A contains all profilometry scans.

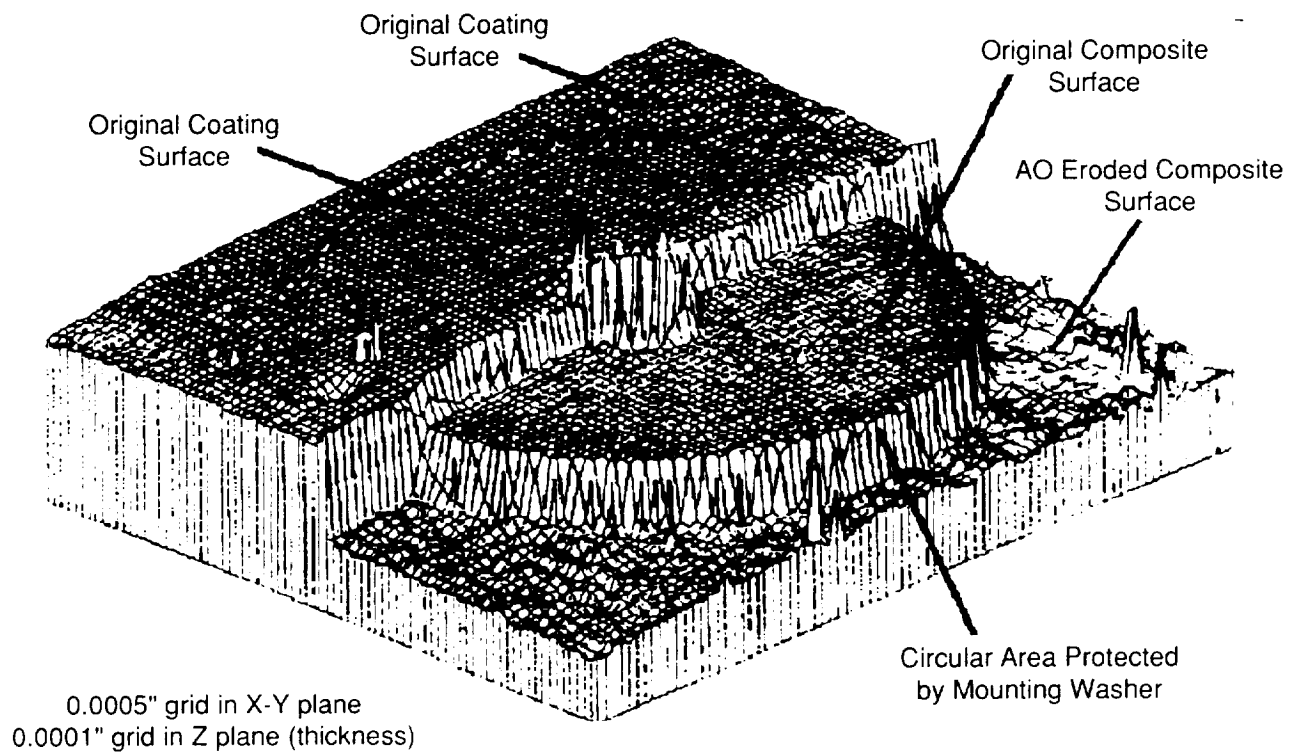

Figure 11. Laser profilometry map of the T300/934 panel, including both A276 coated and bare areas shielded by a washer and both A276 coated and bare areas directly exposed to the space environment.

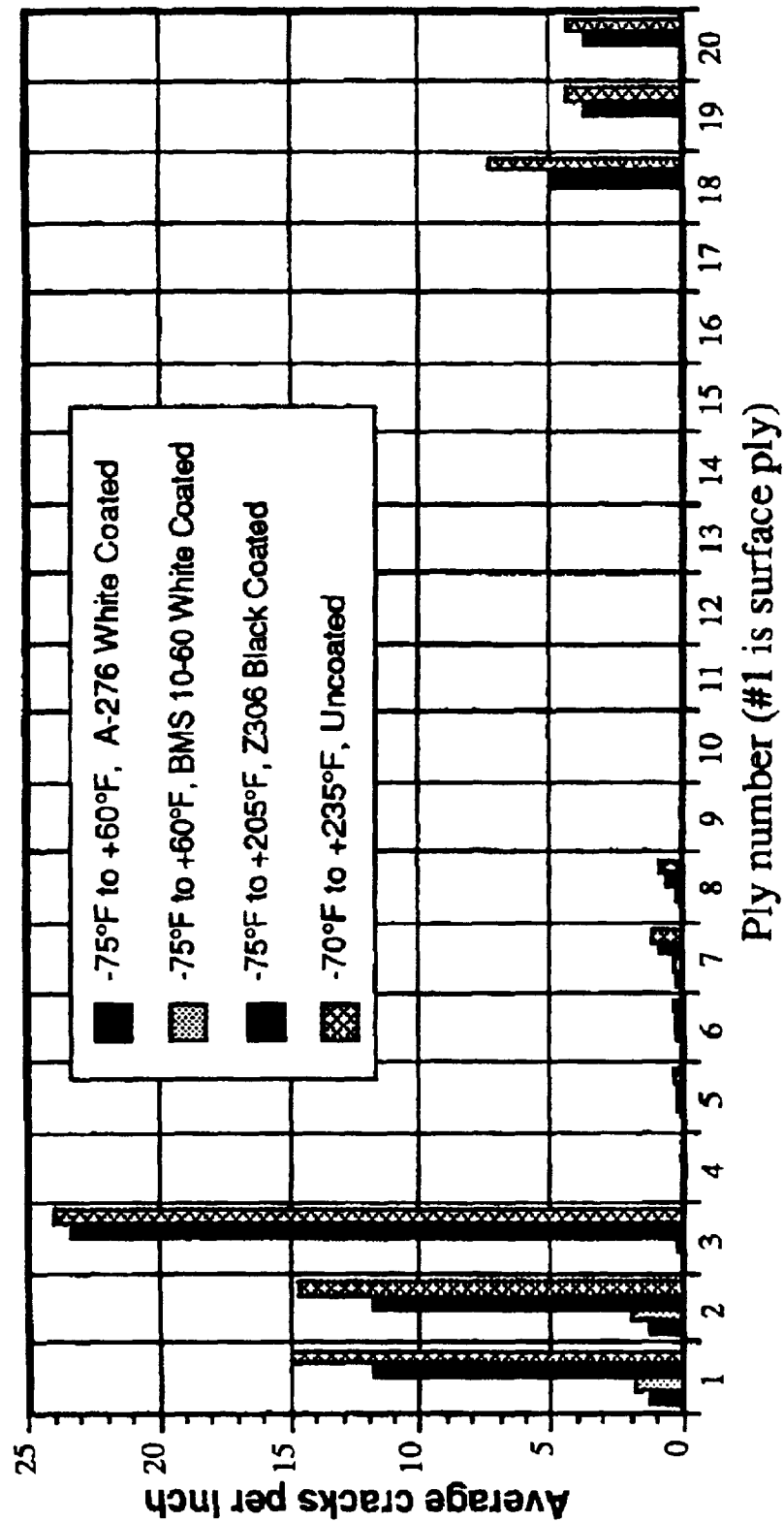

Figure 12. Microrack density vs ply number for coated and bare areas of the T300/934 composite panel from tray D9.

3.11 S0010 - Exposure of Spacecraft Coatings

This was a companion experiment to AO134. A selected set of sputter-coated composite specimens were flown on tray B9. A duplicate set of composite specimens with the same coatings were included in the environmental exposure control canister (EECC) on tray B9. The canister was opened after 10 days on-orbit. The canister was then closed on day 297 and remained sealed for the duration of the mission. The closed canister is visible in figure 7. Results showed that thin sputtered coatings eliminated the atomic oxygen induced erosion associated with bare composites located on LDEF's leading edge (ref. 33).

3.12 S1003 - Ion-Beam-Textured and Coated Surfaces Experiment

A fiberglass panel, coated on both sides with an ion beam sputter-deposited molybdenum, was flown on this experiment (ref. 34). The surface appeared unaltered upon post-flight inspection. The fiberglass substrate was not examined.

4.0 COATED COMPOSITES

As can be seen in table 4, the emittance of the S13G coating on the composite material was not significantly altered by any of the exposures on LDEF. Absorptance increases for leading edge specimens ranged between 0.04-0.08. For trailing edge specimens the absorptance changes ranged between 0.17-0.23. These changes are similar to changes of this material reported for other LDEF locations (ref. 36). The AO exposure removes some of the UV damaged layer and minimizes the absorptance change.

The leafing aluminum coating was applied to the composites using an epoxy binder. The absorptance decrease (0.05-0.06) and the slight emittance decrease (~0.05) observed for leading edge specimens is due to AO removal of the epoxy. The 0.09-0.10 increase in absorptance for the trailing edge specimens is primarily due to darkening of the epoxy by the solar UV. A flight specimen flown in a shielded configuration showed virtually identical optical properties to the ground control specimen. The width of the coated specimens is smaller than the aperture of the Gier-Dunkle instrument used for determining emissivity. This led to concern over the accuracy of the measured values. To overcome this concern, standard materials used to calibrate the instrument were masked using a black cloth so that the same area as the actual specimens was exposed to the light beam. The remainder of the aperture was blocked with the black cloth. The instrument was recalibrated using this standard configuration. The largest difference between the masked standards and the standards in their usual configuration (covering the entire aperture) was only about 0.02. The emissivity of the specimens was then measured with the same black cloth used with the standards as a background. The results obtained in this manner agree with data from larger paint specimens of the same materials which received similar exposure

5.0 SUMMARY

The recession rate of organic resin matrix materials were observed by several investigators to be substantially higher than recession rates of the graphite fibers. This is reported in quantitative fashion in the plot of rate of recession vs % resin in the matrix (ref. 25). The lower erosion rate of the graphite fibers also causes the average recession rate for these materials on LDEF to be lower than was predicted using results from short term exposures on the Space Shuttle. Fiberglass materials exhibited behavior similar to A276 paints. The glass fibers uncovered during atomic oxygen induced erosion of the matrix resin act as a protective barrier, as do the A276 pigment particles on eroded A276.

Selected composite specimens were coated to achieve protection from atomic oxygen and/or to alter the basic optical properties of the composite. These types of specimens were flown on experiments S0010 and M0003. Coatings used include sputter-coated nickel, aluminum film, SiO_x , white paints, leafing aluminum. Each coating protected the underlying composite substrate, even though a variety of changes were visible on the white paints.

Uncoated composites lost a maximum of about 1 ply under the worst exposure conditions. Resin material which remained was essentially unchanged in chemical properties relative to ground control specimens. Mechanical properties of flight specimens decreased in proportion to thickness loss.

6.0 REFERENCES

1. Preliminary Findings of the LDEF Materials Special Investigation Group, B.A. Stein and H.G. Pippin, NASA Conference Publication 3134, Part 2, LDEF-69 Months in Space, First Post-Retrieval Symposium, June 2-8, 1991, Kissimmee, Fl, A.S. Levine, ed.
2. LDEF Materials Overview, B.A. Stein, NASA Conference Publication 3194, Part 3, LDEF-69 Months in Space, Second Post-Retrieval Symposium, June 1-5, 1992, San Diego, Ca, A.S. Levine, ed.
3. Proposed Test Program and Data Base for LDEF Polymer Matrix Composites, R.C. Tennyson, P. George, G Steckel, and D.G. Zimcik, NASA Conference Publication 3162, Part 2, LDEF Materials Workshop '91, Nov 19-22, 1991, Hampton, Va, B.A. Stein and P.R. Young, eds.
4. Low-Earth Orbit Effects on Organic Composite Materials Flown on LDEF, P.E. George and H.W. Dursch, NASA Conference Publication 3257, LDEF Materials Results for Spacecraft Applications, Oct. 27-28, 1992, Huntsville, Al., A.F. Whitaker and J. Gregory, eds.
5. Space Environmental Effects on Polymer Composites: Research Needs and Opportunities, Bor Z. Jang, J Bianchi, Y.M. Liu, and C.P. Chang, NASA Conference Publication 3257, LDEF Materials Results for Spacecraft Applications, Oct. 27-28, 1992, Huntsville, Al., A.F. Whitaker and J. Gregory, eds.
6. Analysis of Selected Material Flown on Interior Locations of the Long Duration Exposure Facility, H.A. Smith, K.M. Nelson, D. Eash, and H.G. Pippin, NASA Contractor Report 4586, April 1994.
7. Evaluation of Adhesive Materials Used on the Long Duration Exposure Facility, H.W. Dursch, B.K. Keough, and H.G. Pippin, NASA Contractor Report 4646, March 1995.
8. French Cooperative Passive Payload (FRECOPA) System Results, Christian Durin, NASA Conference Publication 3134, Part 2, LDEF-69 Months in Space, First Post-Retrieval Symposium, June 2-8, 1991, Kissimmee, Fl, A.S. Levine, ed.

9. High-Toughness Graphite/Epoxy Composite Material Experiment, David K. Felbeck, NASA Conference Publication 3194, Part 3, LDEF-69 Months in Space. Second Post-Retrieval Symposium, June 1-5, 1992, San Diego, Ca, A.S. Levine, ed.
10. High-Toughness Graphite/Epoxy Composite Material Experiment, David K. Felbeck, NASA Conference Publication 3134, Part 2, LDEF-69 Months in Space. First Post-Retrieval Symposium, June 2-8, 1991, Kissimmee, Fl, A.S. Levine, ed.
11. Long Duration Exposure Facility (LDEF) Preliminary Finding: LEO Space Effects on the Space Plasma -- Voltage Drainage Experiment, B.K. Blakkolb, J.Y. Yaung, K.A. Henderson, W.W. Taylor and L.E. Ryan, NASA Conference Publication 3134, Part 2, LDEF-69 Months in Space. First Post-Retrieval Symposium, June 2-8, 1991, Kissimmee, Fl, A.S. Levine, ed.
12. Effects of LDEF Flight Exposure on Selected Polymer Matrix Resin Composite Materials, Wayne S. Slemp, Philip R. Young, William G. Witte, Jr., and James Y. Shen, NASA Conference Publication 3134, Part 2, LDEF-69 Months in Space. First Post-Retrieval Symposium, June 2-8, 1991, Kissimmee, Fl, A.S. Levine, ed.
13. Effect of Space Exposure of some Epoxy Matrix Composites on their Thermal Expansion and Mechanical Properties (AO138-8), Heinrich Jabs, NASA Conference Publication 3134, Part 2, LDEF-69 Months in Space. First Post-Retrieval Symposium, June 2-8, 1991, Kissimmee, Fl, A.S. Levine, ed.
14. Effect of Space Environment on Composite Materials and Thermal Coatings (AO138-9), Michel Parcelier and Jean Pierre Assié, NASA Conference Publication 3134, Part 2, LDEF-69 Months in Space. First Post-Retrieval Symposium, June 2-8, 1991, Kissimmee, Fl, A.S. Levine, ed.
15. Atomic Oxygen Considerations for Spacecraft Materials Selection, A.F. Whitaker and R.R. Kamenetsky, NASA Conference Publication 3257, LDEF Materials Results for Spacecraft Applications, Oct. 27-28, 1992, Huntsville, Al., A.F. Whitaker and J. Gregory, eds.
16. The Effects of Long-Duration Space Exposure on the Mechanical Properties of Some Carbon-Reinforced Resin Matrix Composites, R.F. Vyhnal, NASA Conference Publication 3194, Part 3, LDEF-69 Months in Space. Second Post-Retrieval Symposium, June 1-5, 1992, San Diego, Ca, A.S. Levine, ed.

17. Preliminary Results from the LDEF/UTIAS Composite Materials Experiment, R.C. Tennyson, G.E. Mabson, W.D. Morison, and J. Kleiman, NASA Conference Publication 3134, Part 2, LDEF-69 Months in Space. First Post-Retrieval Symposium, June 2-8, 1991, Kissimmee, Fl, A.S. Levine, ed.
18. Additional Results on Space Environmental Effects on Polymer Matrix Composites-Experiment AO180, R.C. Tennyson, NASA Conference Publication 3162, Part 2, LDEF Materials Workshop '91, Nov 19-22, 1991, Hampton, Va, B.A. Stein and P.R. Young, eds.
19. Thermal-Vacuum Response of Polymer Matrix Composites in Space, R.C. Tennyson and R. Mathews, NASA Conference Publication 3257, LDEF Materials Results for Spacecraft Applications, Oct. 27-28, 1992, Huntsville, Al., A.F. Whitaker and J. Gregory, eds.
20. Outgassing and Dimensional Changes of Polymer Matrix Composites in Space, R.C. Tennyson and R. Mathews, NASA Conference Publication 3194, Part 3, LDEF-69 Months in Space. Second Post-Retrieval Symposium, June 1-5, 1992, San Diego, Ca, A.S. Levine, ed.
21. LDEF-Space Environmental Effects on Materials: Composites and Silicone Coatings, Brian Petrie, NASA Conference Publication 3134, Part 2, LDEF-69 Months in Space. First Post-Retrieval Symposium, June 2-8, 1991, Kissimmee, Fl, A.S. Levine, ed.
22. Low Earth Orbit Environmental Effects On Composite Materials: Results From The Long Duration Exposure Facility (LDEF), C. Blair and B.C. Petrie, Proceedings of the 24th International SAMPE Technical Conference, Oct 20-22, 1992.
23. Polymer Matrix Composites on LDEF Experiments M0003-9 and 10, Gary L. Steckel, Thomas Cookson, and Christopher Blair, NASA Conference Publication 3162, Part 2, LDEF Materials Workshop '91, Nov 19-22, 1991, Hampton, Va, B.A. Stein and P.R. Young, eds.
24. LDEF Fiber-Composite Materials Characterization, C.J. Miglionico, C. Stein, R.E. Royal, and L.E. Murr, NASA Conference Publication 3194, Part 3, LDEF-69 Months in Space. Second Post-Retrieval Symposium, June 1-5, 1992, San Diego, Ca, A.S. Levine, ed.

25. M0003-10: LDEF Advanced Composites Experiment, Gary L. Steckel and Tuyen D. Le, NASA Conference Publication 3134, Part 2, LDEF-69 Months in Space, First Post-Retrieval Symposium, June 2-8, 1991, Kissimmee, Fl, A.S. Levine, ed.
26. Surface Analysis of Composites Exposed to the Space Environment on LDEF, Joseph J. Mallon, Joseph C. Uht, and Carol S. Hemminger, NASA Conference Publication 3194, Part 3, LDEF-69 Months in Space, Second Post-Retrieval Symposium, June 1-5, 1992, San Diego, Ca, A.S. Levine, ed.
27. The Impact of LDEF Results on the Space Application of Metal Matrix Composites, Gary L. Steckel and Tuyen D. Le, NASA Conference Publication 3257, LDEF Materials Results for Spacecraft Applications, Oct. 27-28, 1992, Huntsville, Al., A.F. Whitaker and J. Gregory, eds.
28. Thermal Expansion Behavior of LDEF Metal Matrix Composites, Tuyen D. Le and Gary L. Steckel, NASA Conference Publication 3194, Part 3, LDEF-69 Months in Space, Second Post-Retrieval Symposium, June 1-5, 1992, San Diego, Ca, A.S. Levine, ed.
29. Results from Analysis of Boeing Composite Specimens Flown on LDEF Experiment M0003, Pete E. George and Sylvester G. Hill, NASA Conference Publication 3134, Part 2, LDEF-69 Months in Space, First Post-Retrieval Symposium, June 2-8, 1991, Kissimmee, Fl, A.S. Levine, ed.
30. Space Environmental Effects on LDEF Low Earth Orbit Exposed Graphite Reinforced Polymer Matrix Composites, Pete George, NASA Conference Publication 3162, Part 2, LDEF Materials Workshop '91, Nov 19-22, 1991, Hampton, Va, B.A. Stein and P.R. Young, eds.
31. Space Environmental Effects on LDEF Composites: A Leading Edge Coated Graphite Epoxy Panel, P.E. George, H.W. Dursch, and S.G. Hill, NASA Conference Publication 3194, Part 3, LDEF-69 Months in Space, Second Post-Retrieval Symposium, June 1-5, 1992, San Diego, Ca, A.S. Levine, ed.
32. Long-Duration-Exposure-Facility Space Aging of STAR Motor Components, O.T. Chen, and J.A. Hartwell, AIAA 27th Joint Propulsion Conference, June 24-27, 1991, Sacramento, CA.

33. LDEF Polymeric Materials: 10 Months vs 5.8 Years of Exposure, P.R. Young, W.S. Slemp, and A.C. Chang, NASA Conference Publication 3194, Part 3, LDEF-69 Months in Space. Second Post-Retrieval Symposium, June 1-5, 1992, San Diego, Ca, A.S. Levine, ed.

34. Ion Beam Textured and Coated Surfaces Experiment (IBEX), M.J. Mirtich, S.K. Rutledge, N. Stevens, R. Olle, and J. Merrow, NASA Conference Publication 3134, Part 2, LDEF-69 Months in Space. First Post-Retrieval Symposium, June 2-8, 1991, Kissimmee, Fl, A.S. Levine, ed.

35. Space Environmental Effects on Polymer Matrix Composites as a Function of Sample Location on LDEF, R.C. Tennyson, G.R. Cool, and D.G. Zimcik, NASA Conference Publication 3275, LDEF-69 Months in Space. Third Post-Retrieval Symposium, November, 1993, Williamsburg, VA, A.S. Levine, ed.

36. Organic Matrix Composite Protective Coatings for Space Applications, H.W. Dursch and P. George, NASA Conference Publication 3275, LDEF-69 Months in Space. Third Post-Retrieval Symposium, November, 1993, Williamsburg, VA, A.S. Levine, ed.

Appendix A
Laser Profilometry Scans for Selected Composite Specimens
Appendix Figure List

- Figure A-1. Location of profilometer scans taken through the washer protected area and adjacent exposed areas in the bare T300/934 quadrant of the panel on tray D9.
- Figure A-2. Location of profilometer scans taken through the washer protected area and adjacent exposed areas in the bare 934/T300 and A276 white paint coated quadrants of the panel on tray D9.
- Figure A-3. Laser profilometry scan 3 from unexposed to exposed area of bare T300/934 surface on tray D9 composite panel.
- Figure A-4. Laser profilometry scan 4 from unexposed to exposed area of bare T300/934 surface on tray D9 composite panel.
- Figure A-5. Laser profilometry scan 1 from unexposed to exposed area of bare T300/934 surface on tray D9 composite panel.
- Figure A-6. Laser profilometry scan 2 from unexposed to exposed area of A276 coated surface on tray D9 composite panel.
- Figure A-7. Location of profilometer scans taken through the washer protected area and adjacent exposed areas in the A276 white paint coated quadrant of the panel on tray D9.
- Figure A-8. Location of profilometer scan taken through the washer protected area and adjacent exposed area in the A276 white paint coated quadrant of the panel on tray D9.
- Figure A-9. Laser profilometry scan 1 from unexposed to exposed area of A276 coated surface on tray D9 composite panel.
- Figure A-10. Laser profilometry scan 2 from unexposed to exposed area of A276 coated surface on tray D9 composite panel.

Appendix Figure List Continued

- Figure A-11. Laser profilometry scan 3 from unexposed to exposed area of A276 coated surface on tray D9 composite panel.
- Figure A-12. Laser profilometry scan 4 from unexposed to exposed area of A276 coated surface on tray D9 composite panel.
- Figure A-13. Laser profilometry scan 3 from unexposed to exposed area of A276 coated surface on tray D9 composite panel.
- Figure A-14. Location of profilometer scan taken through the washer protected area and adjacent exposed area in the BMS 10-60 white paint coated quadrant of the panel on tray D9.
- Figure A-15. Location of profilometer scans taken through the washer protected area and adjacent exposed areas in the BMS 10-60 white paint coated quadrant of the panel on tray D9.
- Figure A-16. Laser profilometry scan 1 from unexposed to exposed area of BMS 10-60 white paint coated surface on tray D9 composite panel.
- Figure A-17. Laser profilometry scan 1 from unexposed to exposed area of BMS 10-60 coated surface on tray D9 composite panel.
- Figure A-18. Laser profilometry scan 2 from unexposed to exposed area of BMS 10-60 coated surface on tray D9 composite panel.
- Figure A-19. Laser profilometry scan 3 from unexposed to exposed area of BMS 10-60 coated surface on tray D9 composite panel.
- Figure A-20. Laser profilometry scan 4 from unexposed to exposed area of BMS 10-60 coated surface on tray D9 composite panel.
- Figure A-21. Location of profilometer scans taken through the washer protected area and adjacent exposed areas in the BMS 10-60 white paint and bare T300/934 composite quadrants of the panel on tray D9.

Appendix Figure List Continued

- Figure A-22. Laser profilometry scan 3 from unexposed to exposed area of bare T300/934 surface on tray D9 composite panel. Taken from washer area between bare composite and BMS 10-60 coated quadrants.
- Figure A-23. Laser profilometry scan 4 from unexposed to exposed area of BMS 10-60 coated surface on tray D9 composite panel. Taken from washer area between bare composite and BMS 10-60 coated quadrants.
- Figure A-24. Laser profilometry scan from exposed to unexposed area of composite tensile specimen from AO019 shown in figure 5, along line marked step 1.
- Figure A-25. Laser profilometry scan from exposed to unexposed area of composite tensile specimen from AO019 shown in figure 5, along line marked step 2.
- Figure A-26. Laser profilometry scan from exposed to unexposed area of composite tensile specimen from AO019 shown in figure 5, along line marked step 3.
- Figure A-27. Laser profilometry scan from exposed to unexposed area of composite tensile specimen from AO019 shown in figure 5, along line marked step 4.

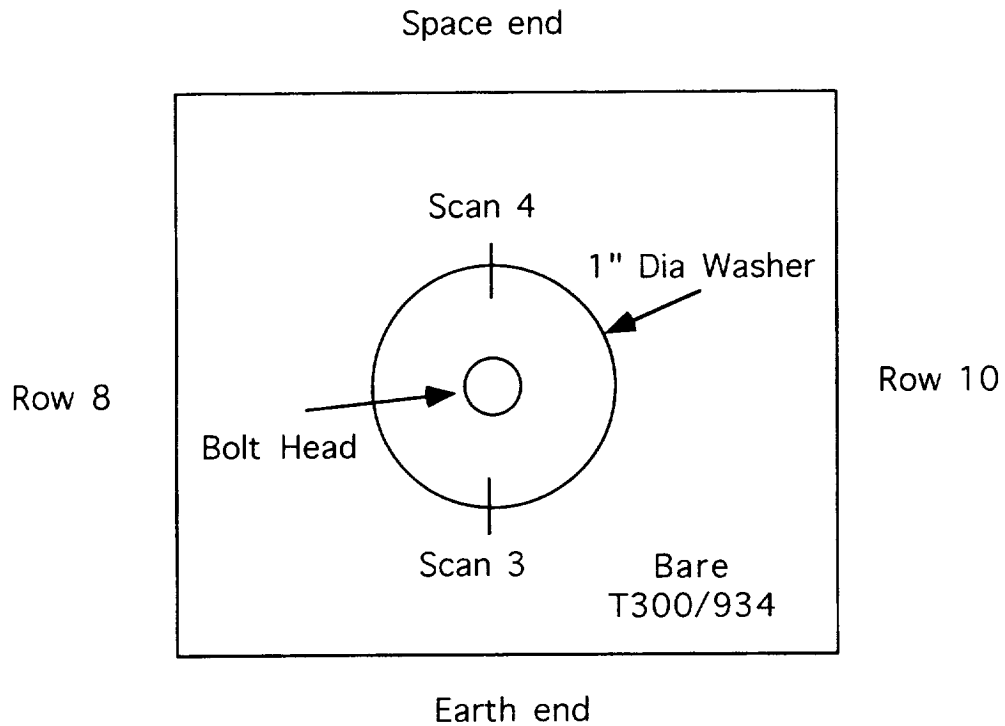

Figure A-1. Location of profilometer scans 3 and 4 taken through the washer protected area and adjacent exposed areas in the bare T300/934 quadrant of the panel on tray D9.

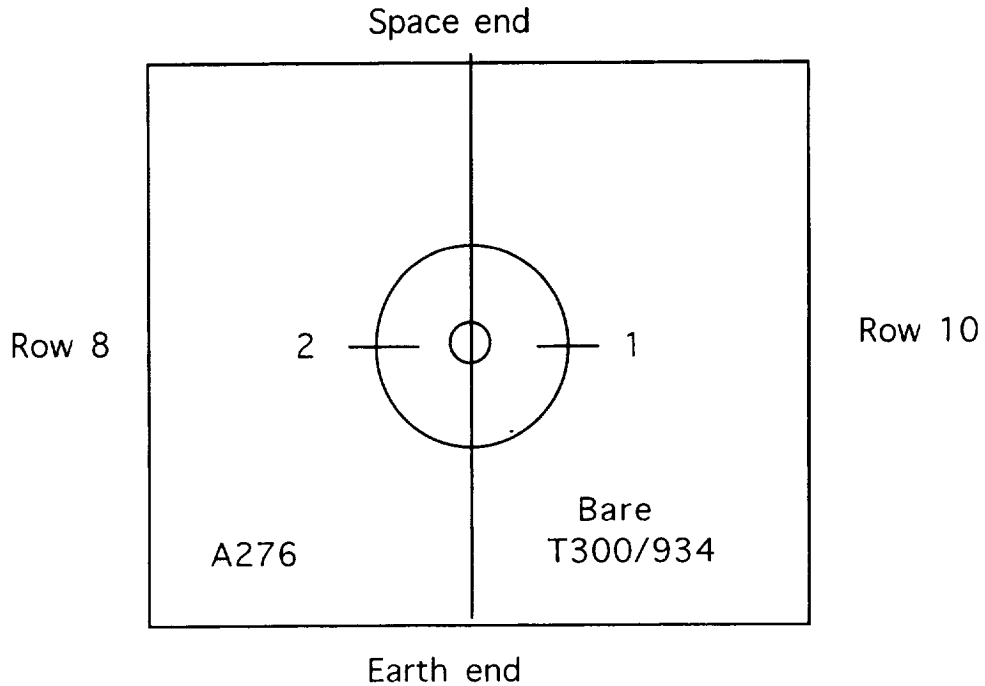

Figure A-2. Location of profilometer scans taken through the washer protected area and adjacent exposed areas in the bare T300/934 and A276 white paint coated quadrants of the panel on tray D9.

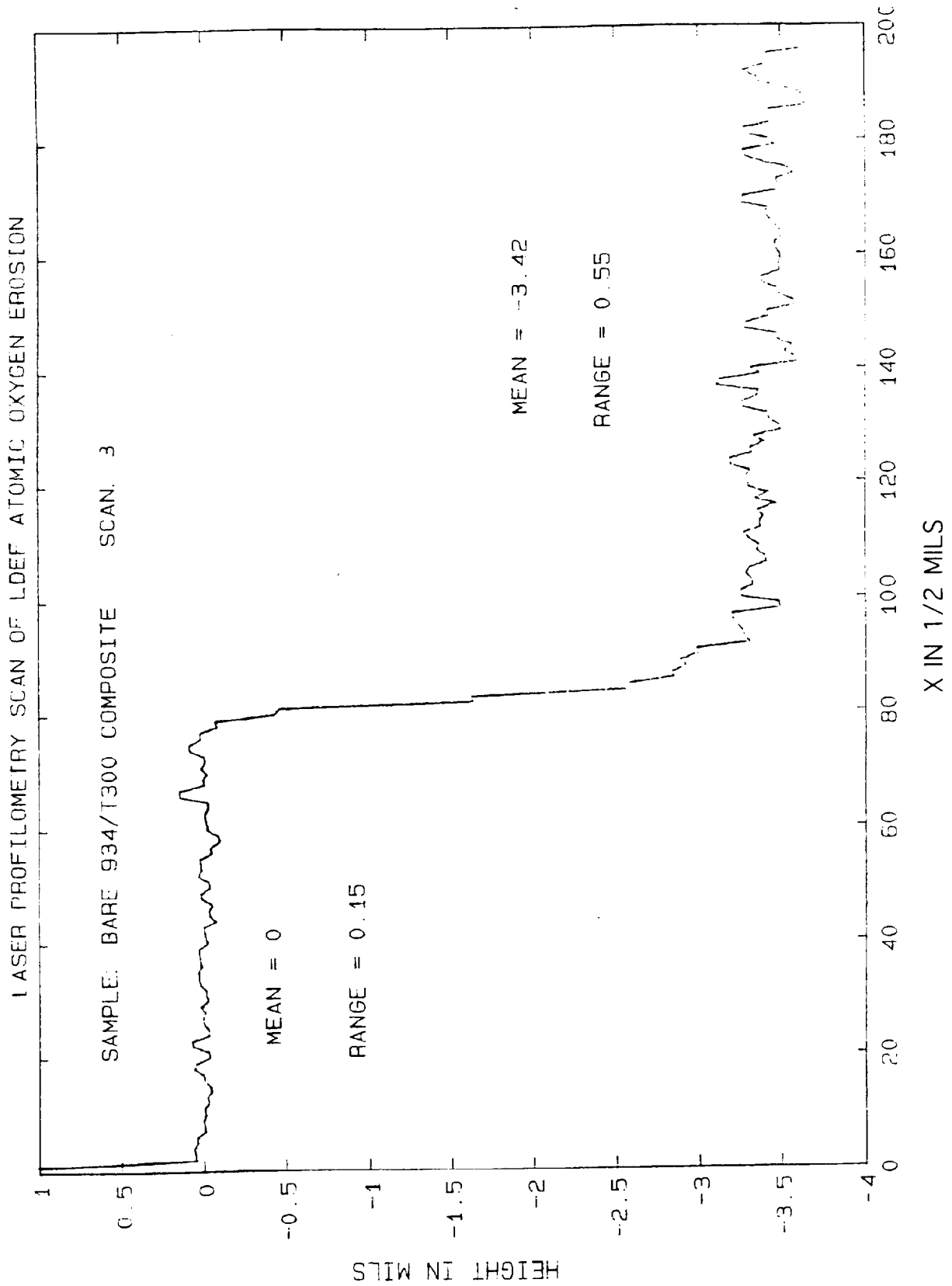

Figure A-3. Laser profilometer scan 3 from unexposed to exposed area of bare T300/934 surface on tray D9 composite panel.

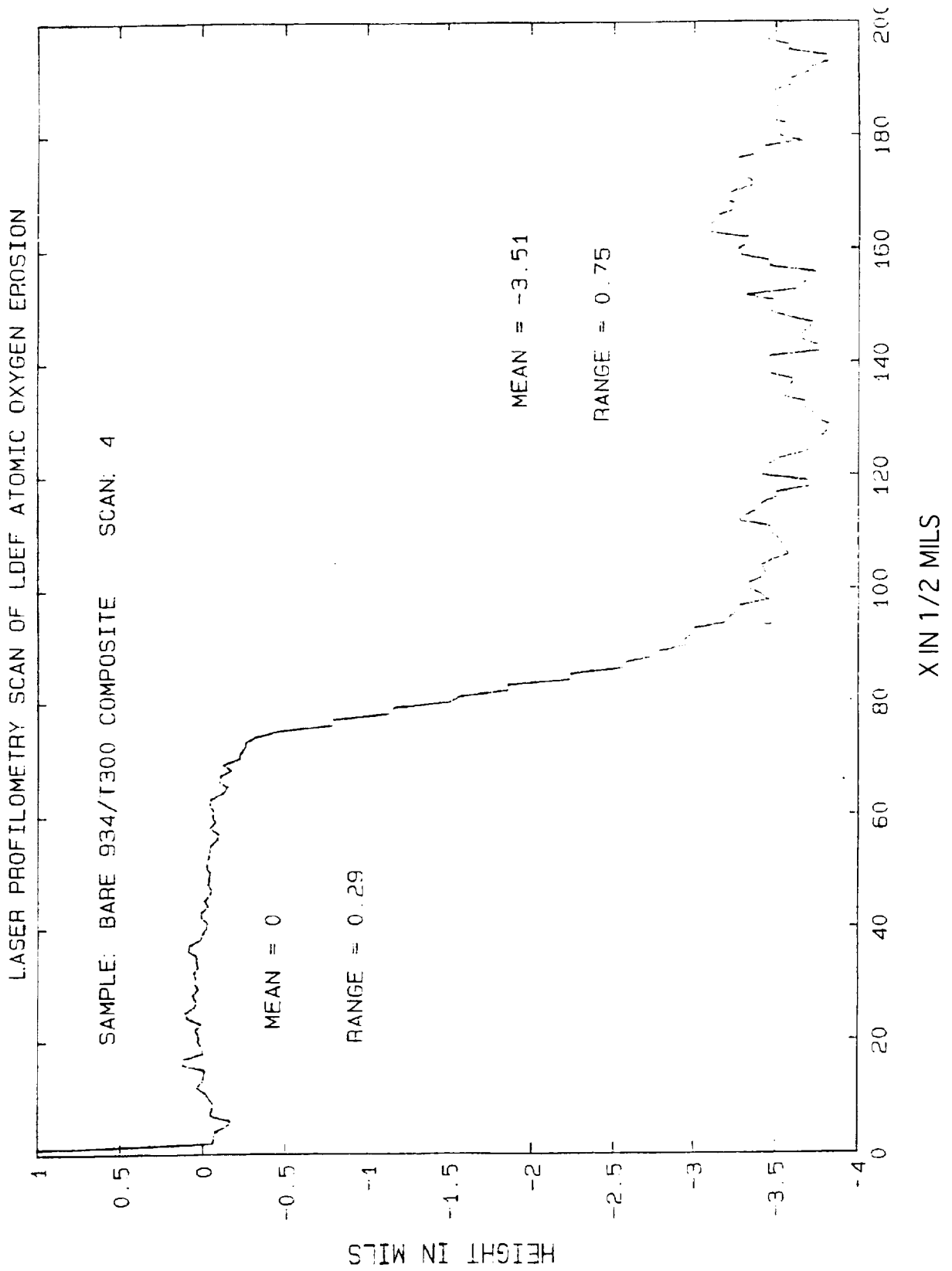

Figure A-4. Laser profilometry scan 4 from unexposed to exposed area of bare T300/934 surface on tray D9 composite panel.

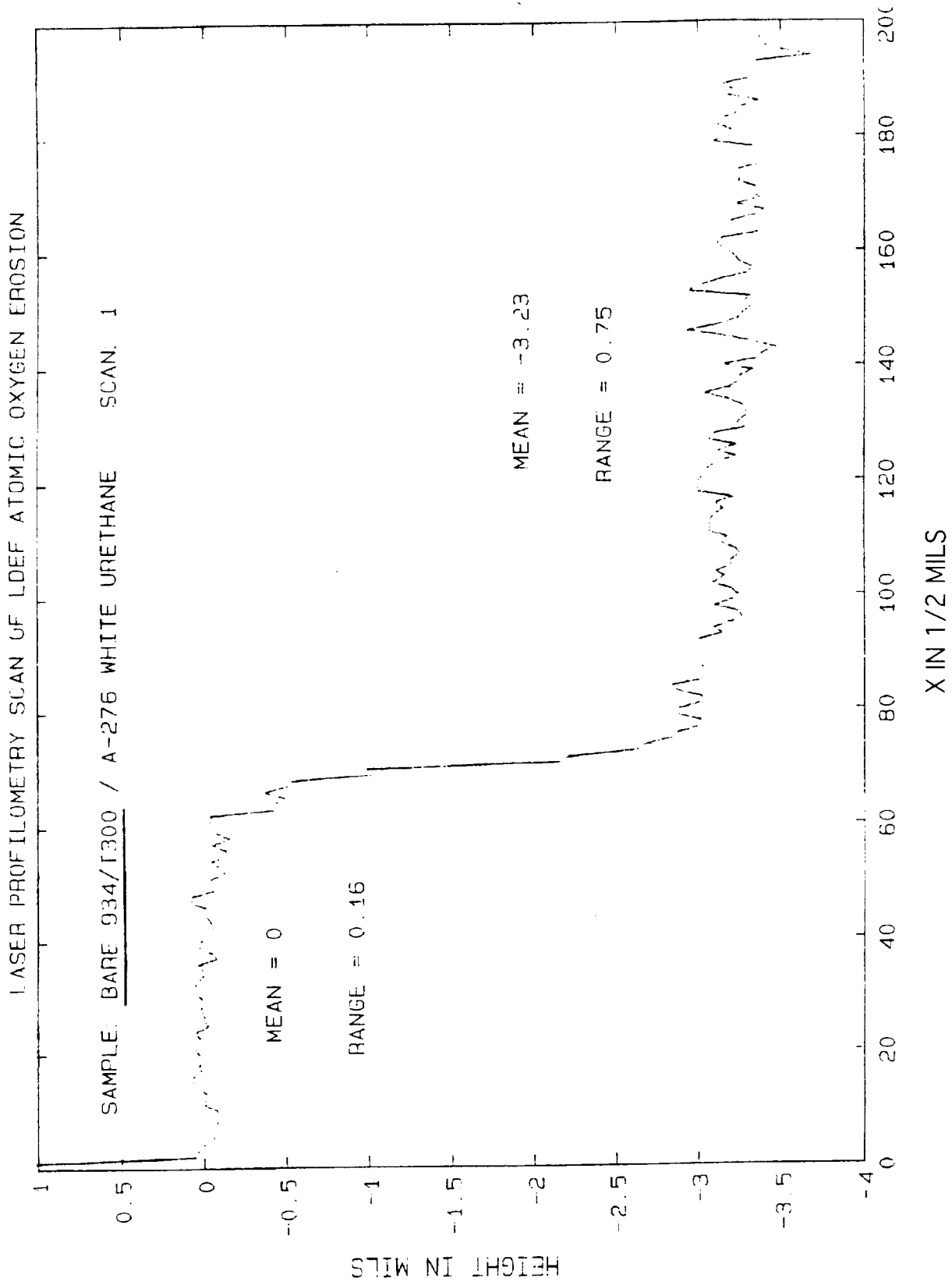

Figure A-5. Laser profilometry scan 1 from unexposed to exposed area of bare T300/934 surface on tray D9 composite panel.

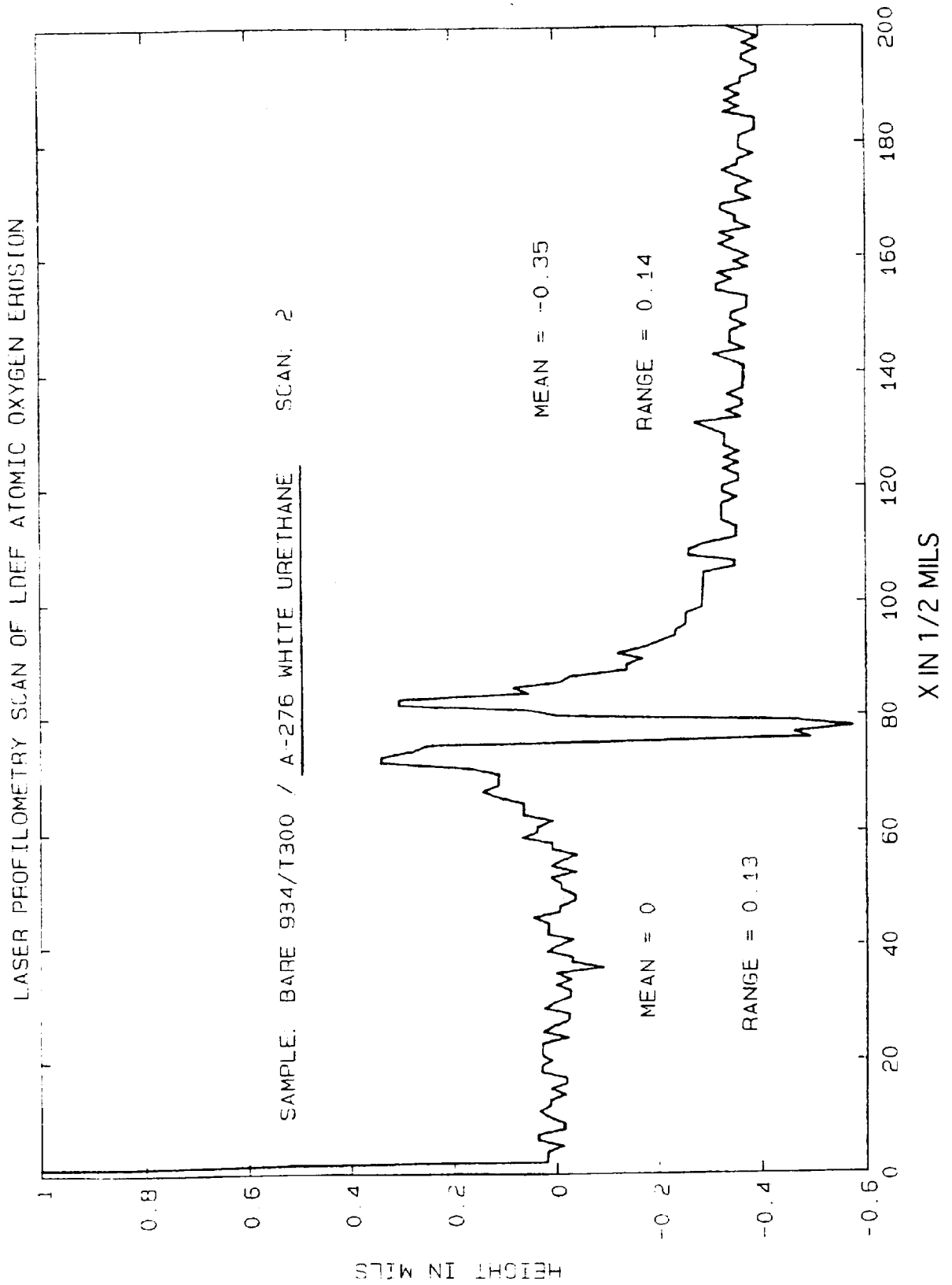

Figure A-6. Laser profilometry scan 2 from unexposed to exposed area of A276 coated surface on tray D9 composite panel.

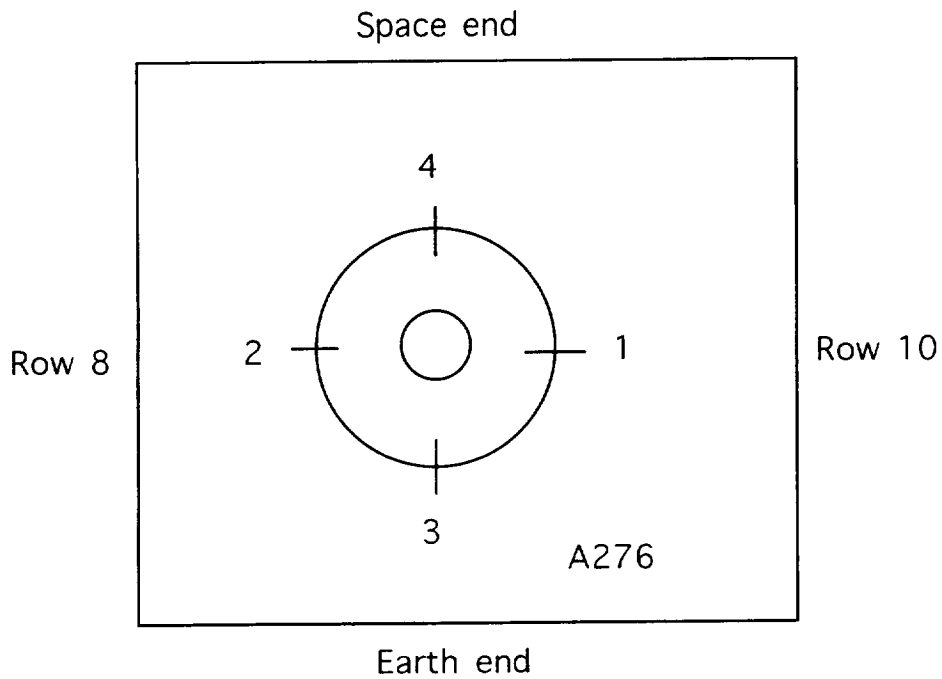

Figure A-7. Location of profilometer scans taken through the washer protected area and adjacent exposed areas in the A276 white paint coated quadrant of the panel on tray D9.

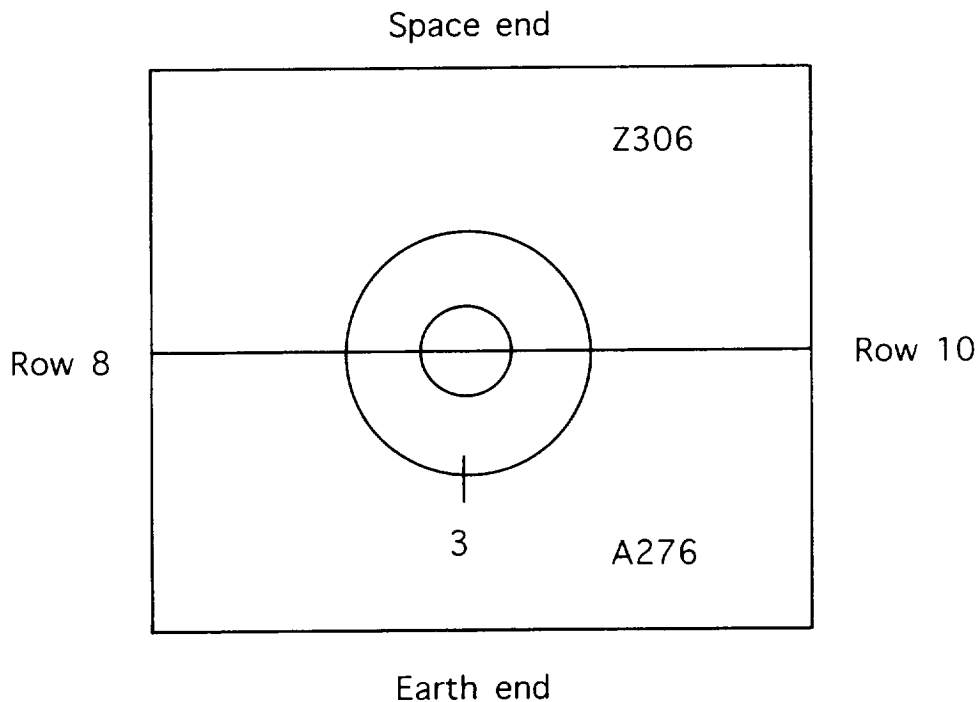

Figure A-8. Location of profilometer scan taken through the washer protected area and adjacent exposed area in the A276 white paint coated quadrant of the panel on tray D9.

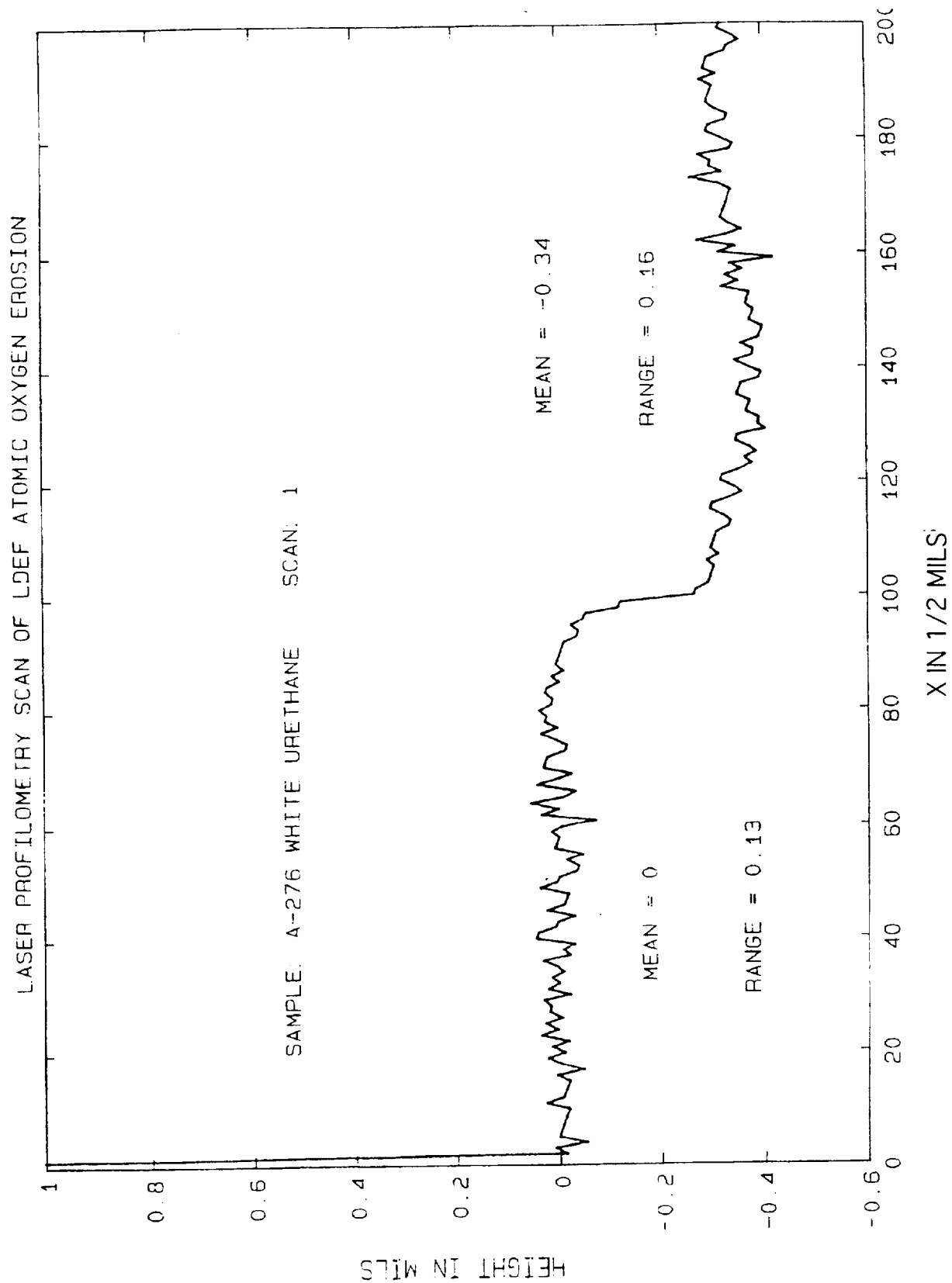

Figure A-9. Laser profilometry scan I from unexposed to exposed area of A276 coated surface on tray D9 composite panel.

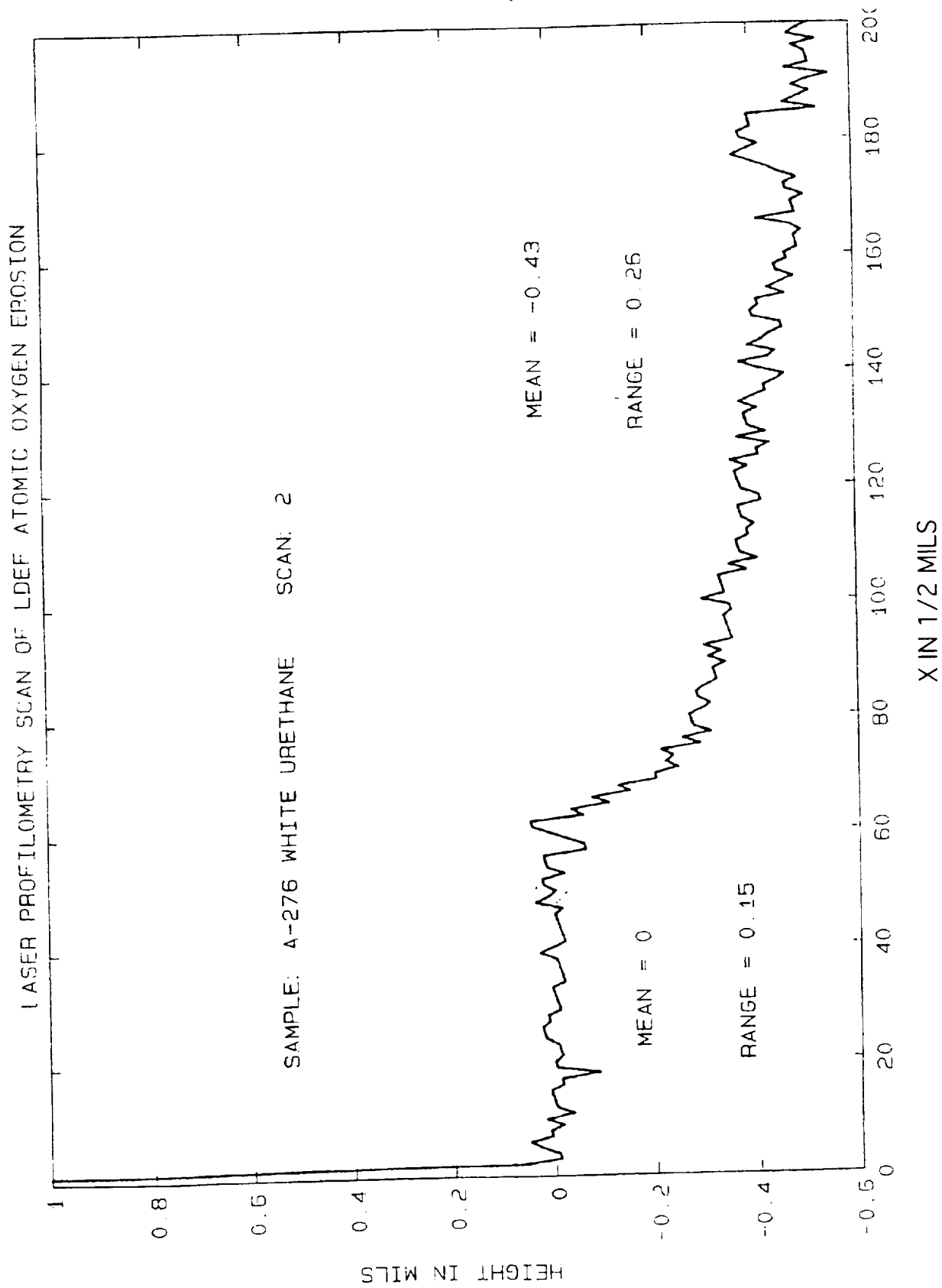

Figure A-10. Laser profilometry scan 2 from unexposed to exposed area of A276 coated surface on tray D9 composite panel.

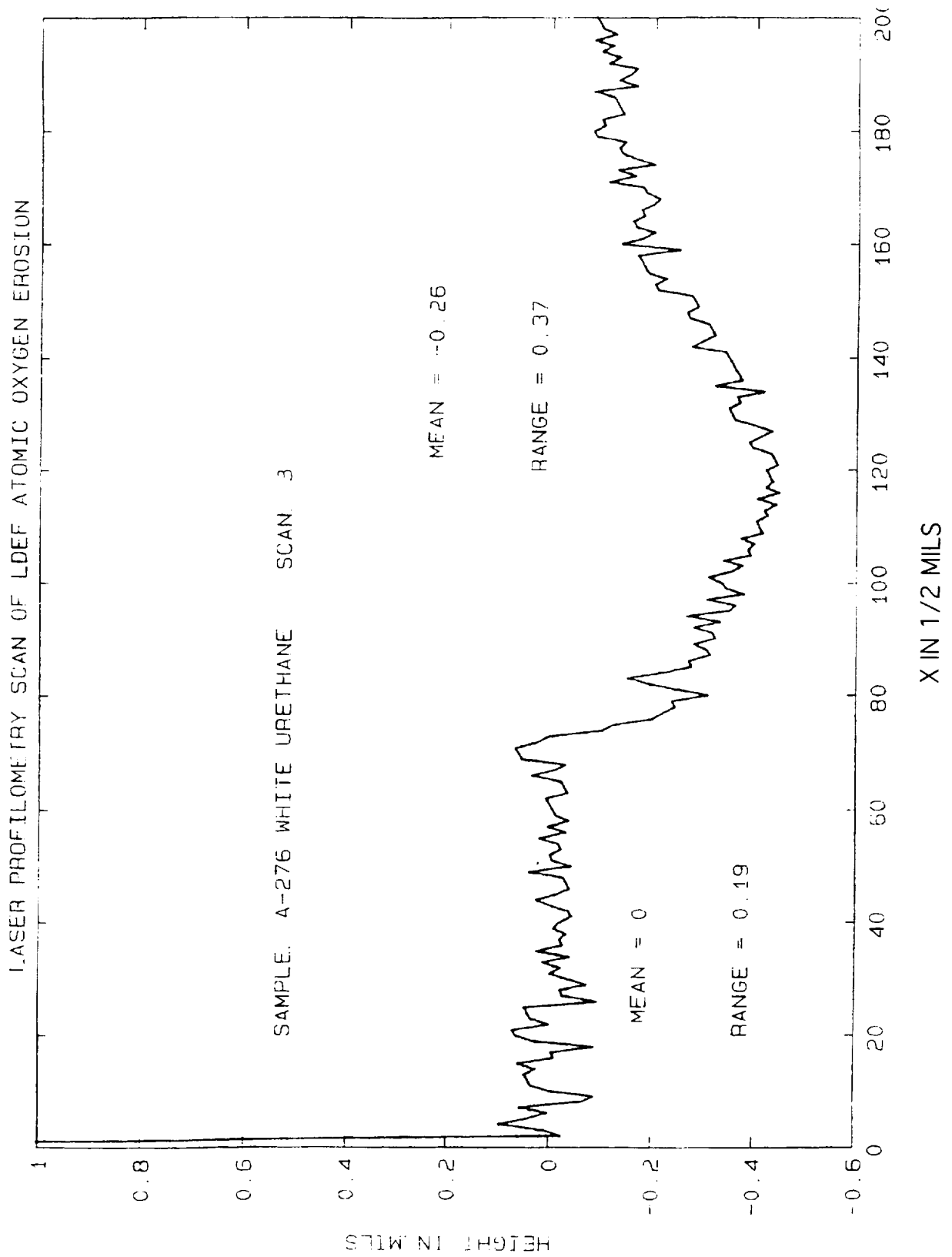

Figure A-11. Laser profilometry scan 3 from unexposed to exposed area of A276 coated surface on tray D9 composite panel.

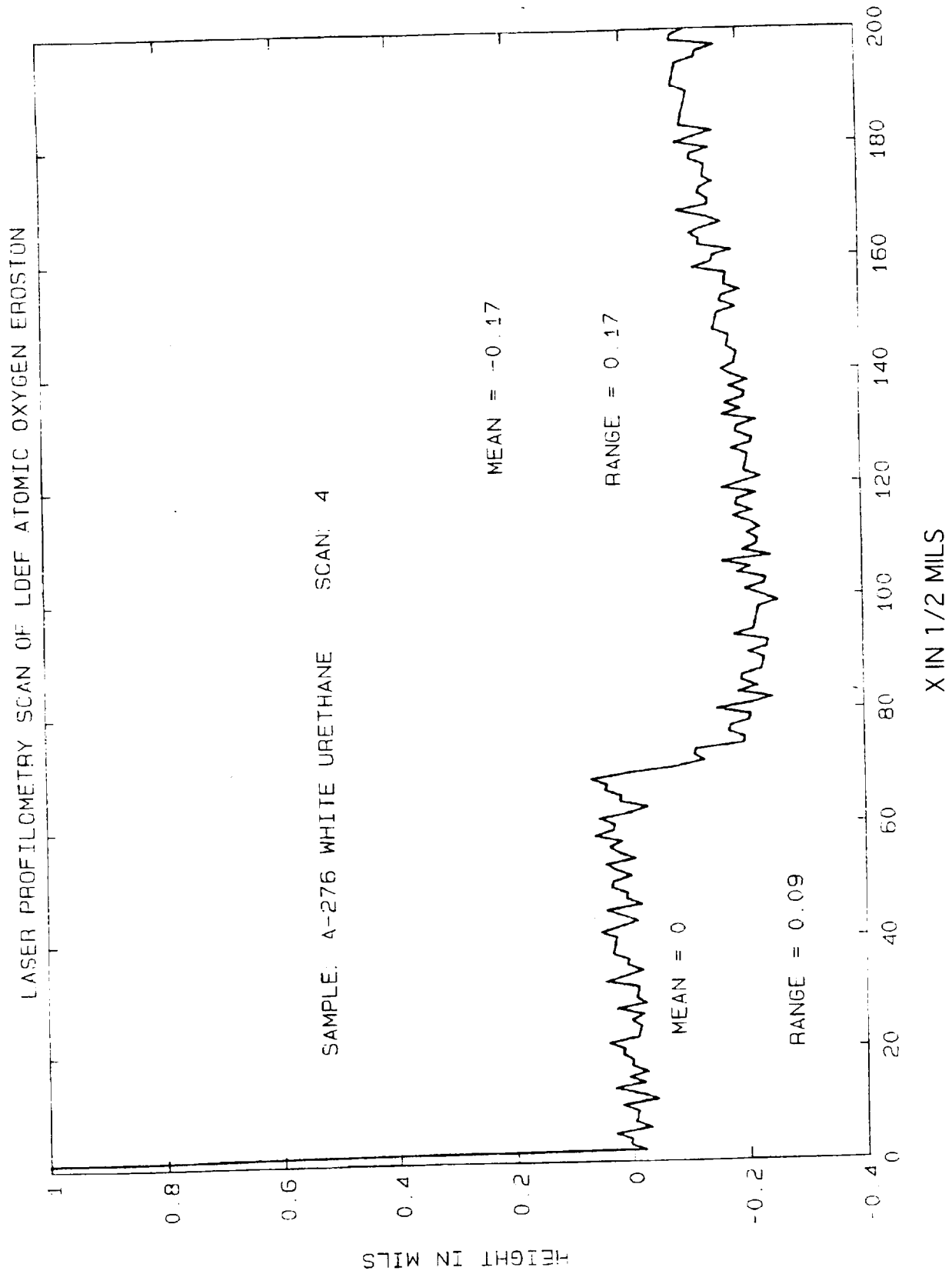

Figure A-12. Laser profilometry scan 4 from unexposed to exposed area of A276 coated surface on tray D9 composite panel.

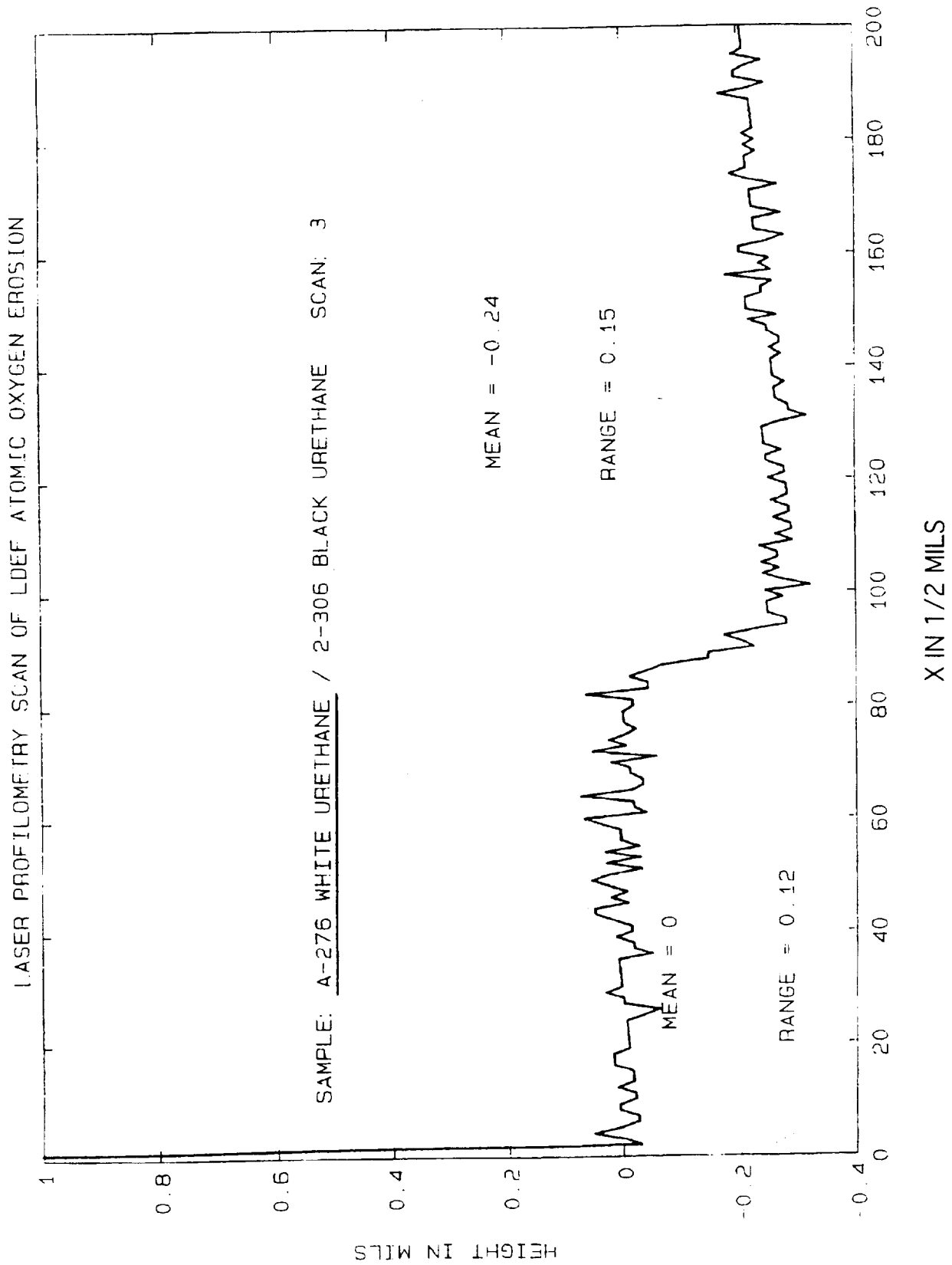

Figure A-13. Laser profilometry scan 3 from unexposed to exposed area of A276 coated surface on tray D9 composite panel.

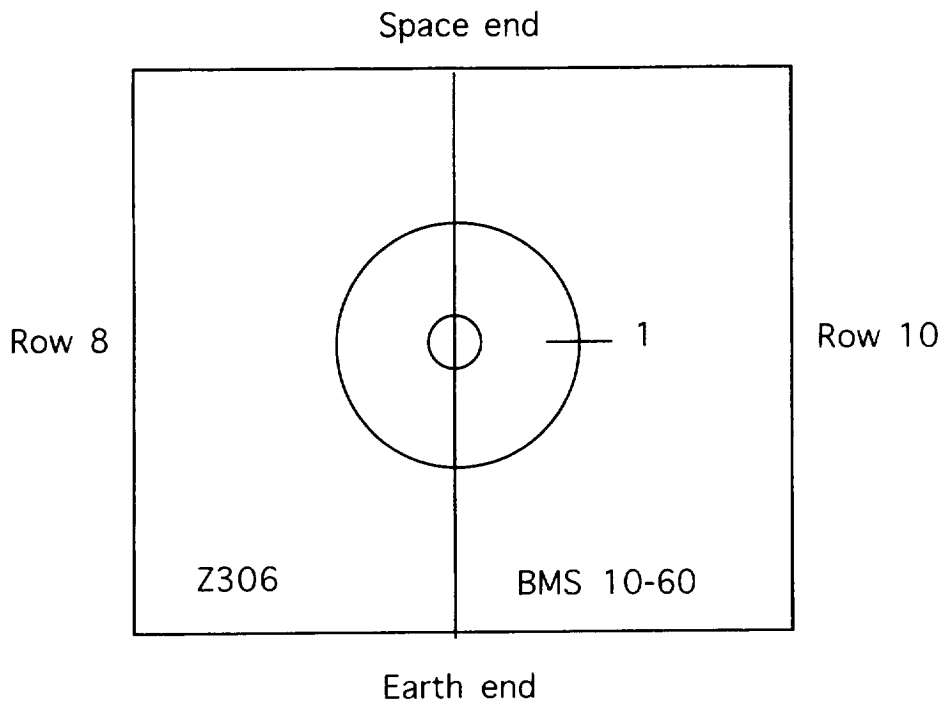

Figure A-14. Location of profilometer scan taken through the washer protected area and adjacent exposed area BMS 10-60 white paint coated quadrant of the panel on tray D9.

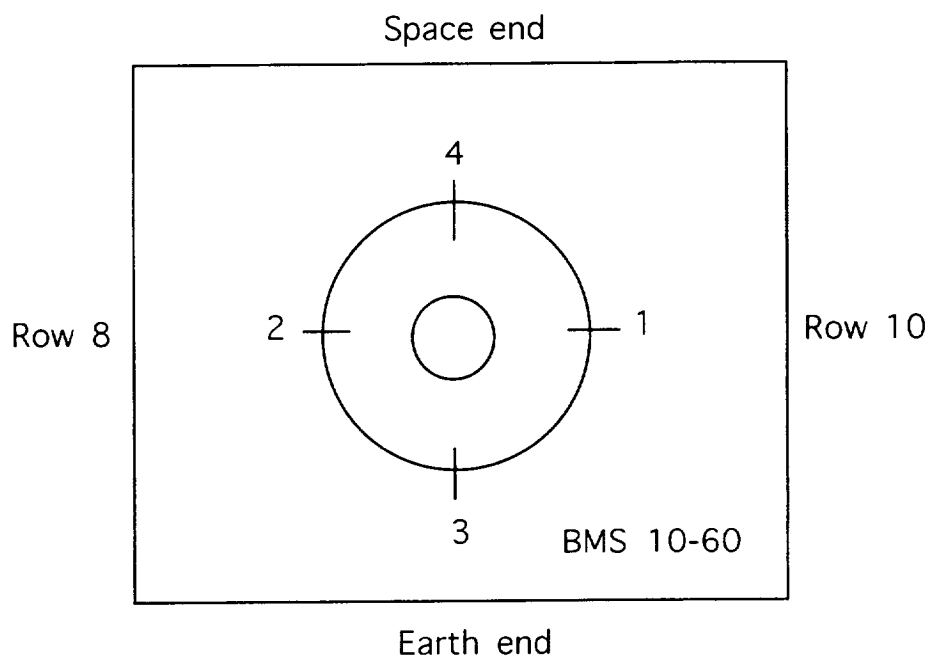

Figure A-15. Location of profilometer scans taken through the washer protected area and adjacent exposed areas in the BMS 10-60 white paint coated quadrant of the panel on tray D9.

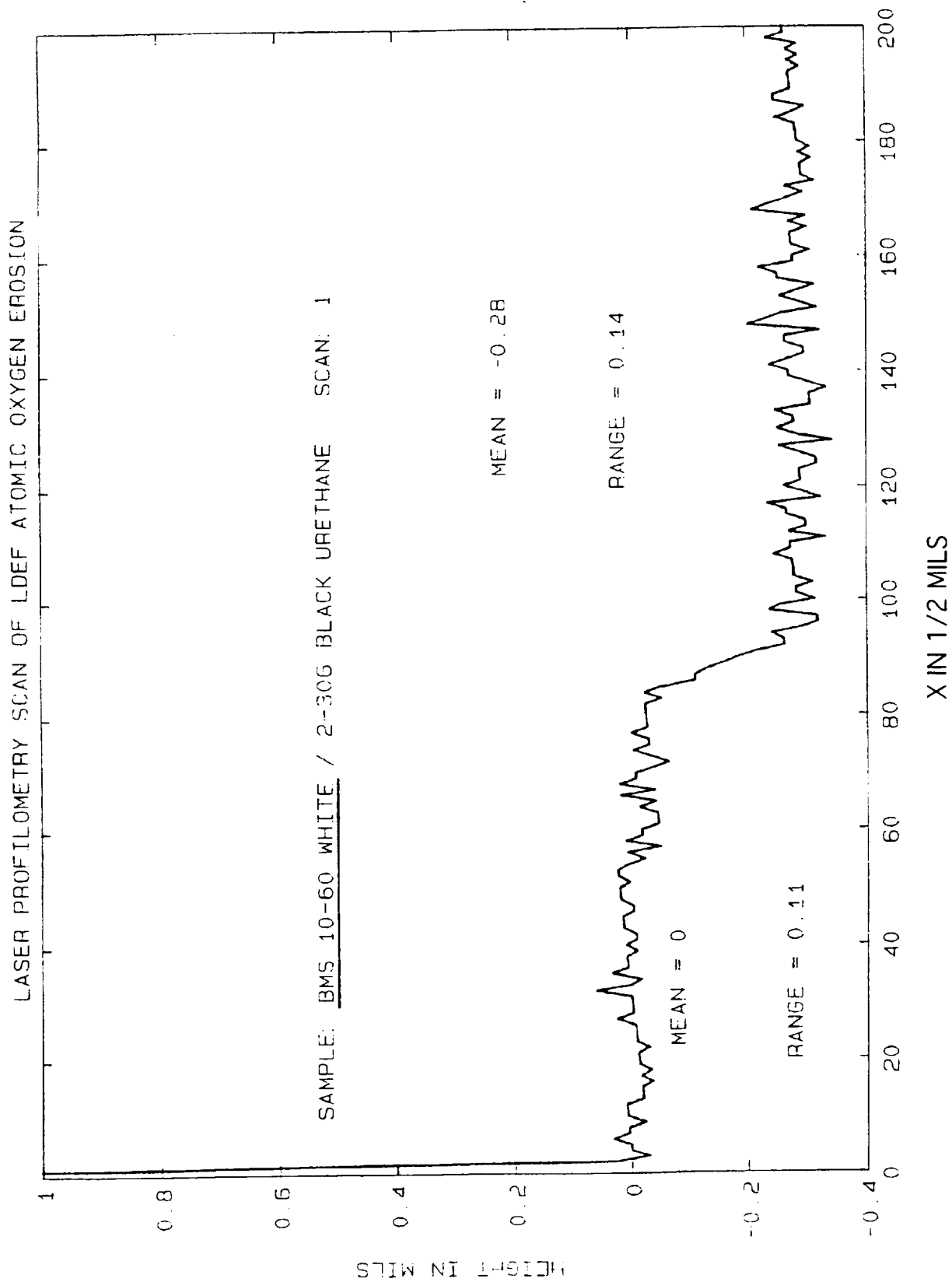

Figure A-16. Laser profilometry scan 1 from unexposed to exposed area of BMS 10-60 coated surface on tray D9 composite panel.

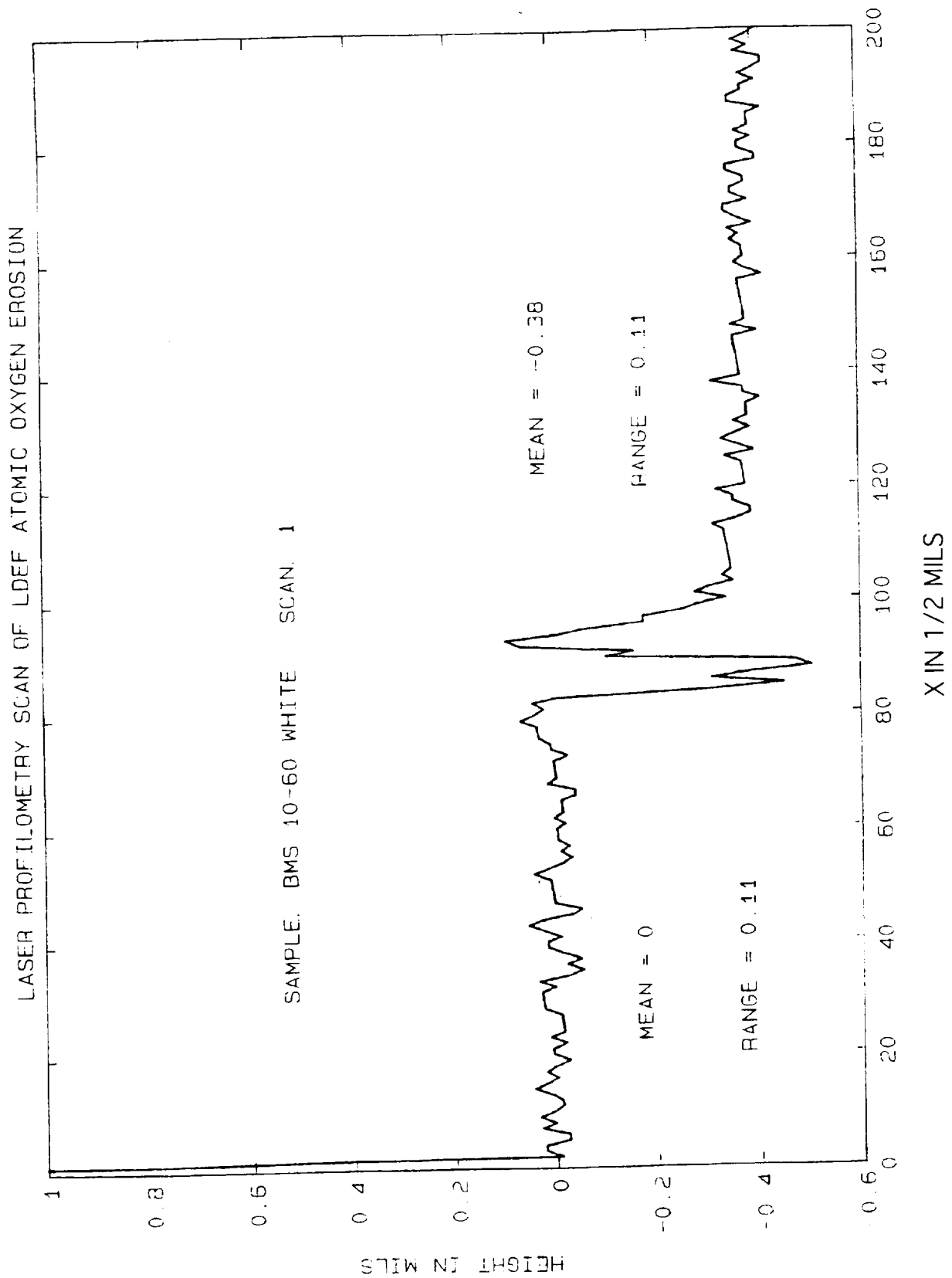

Figure A-17. Laser profilometry scan 1 from unexposed to exposed area of BMS 10-60 coated surface on tray D9 composite panel.

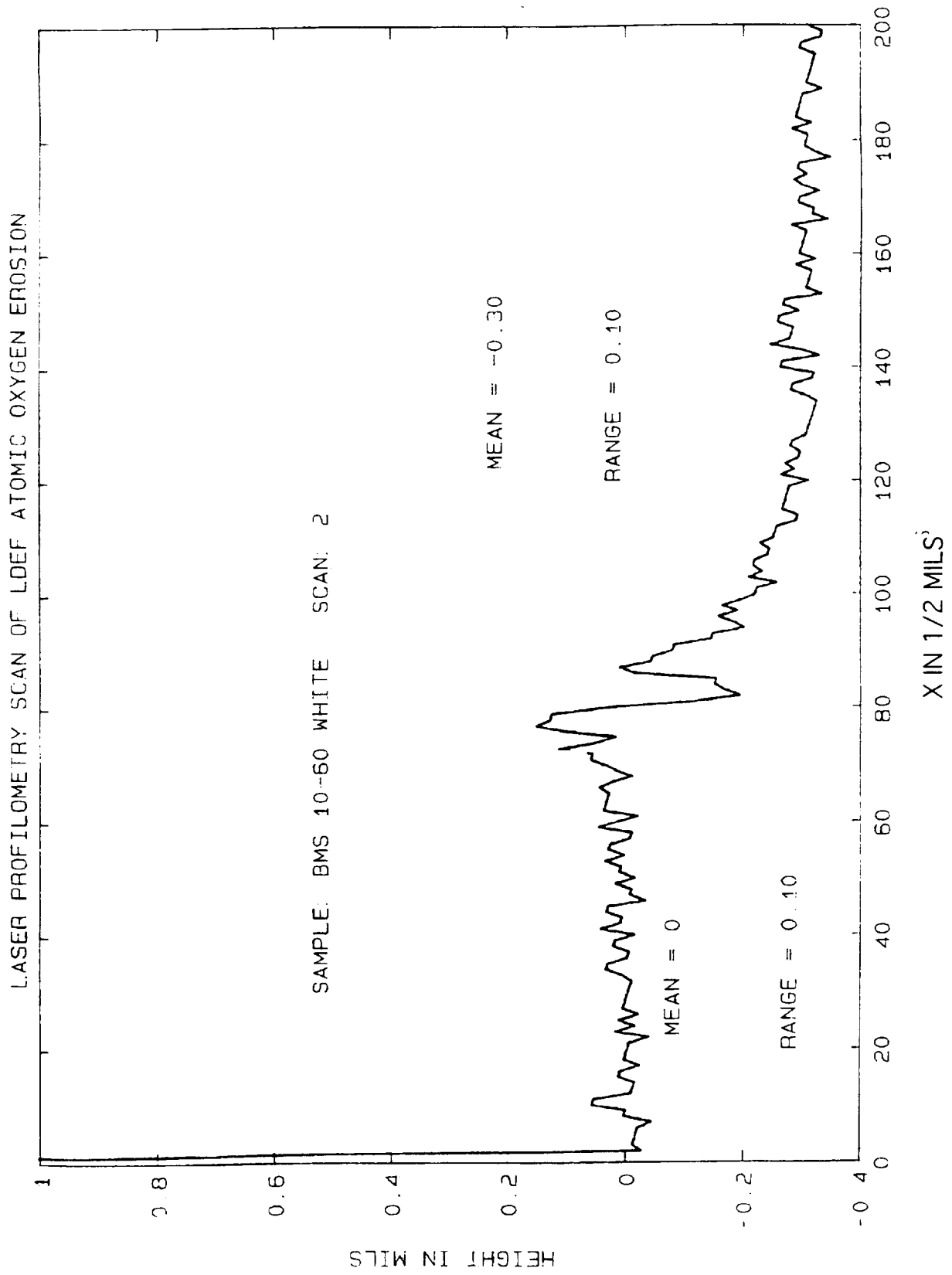

Figure A-18. Laser profilometry scan 2 from unexposed to exposed area of BMS 10-60 coated surface on tray D9 composite panel.

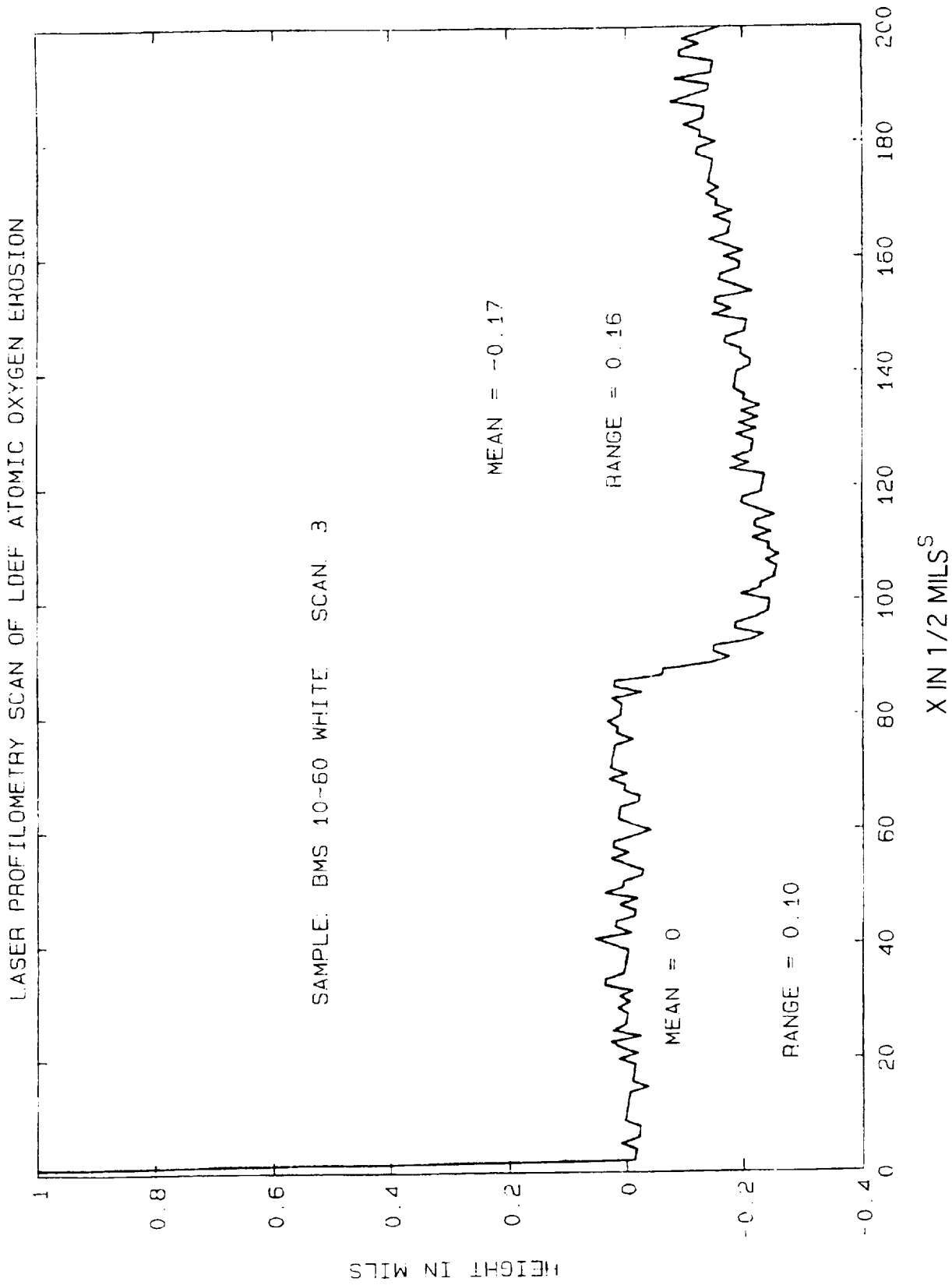

Figure A-19. Laser profilometry scan 3 from unexposed to exposed area of BMS 10-60 coated surface on tray D9 composite panel.

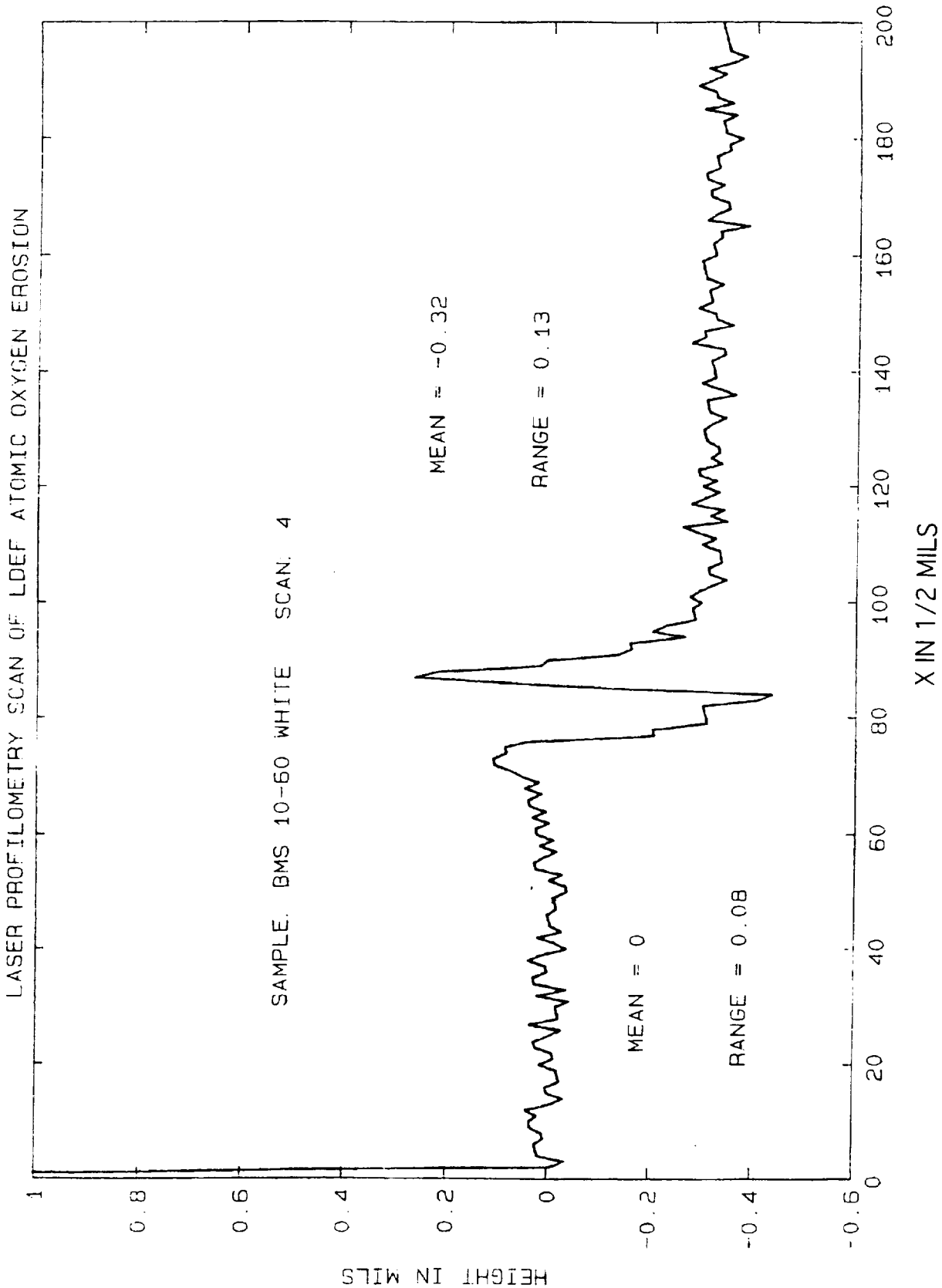

Figure A-20. Laser profilometry scan 4 from unexposed to exposed area of BMS 10-60 coated surface on tray D9 composite panel.

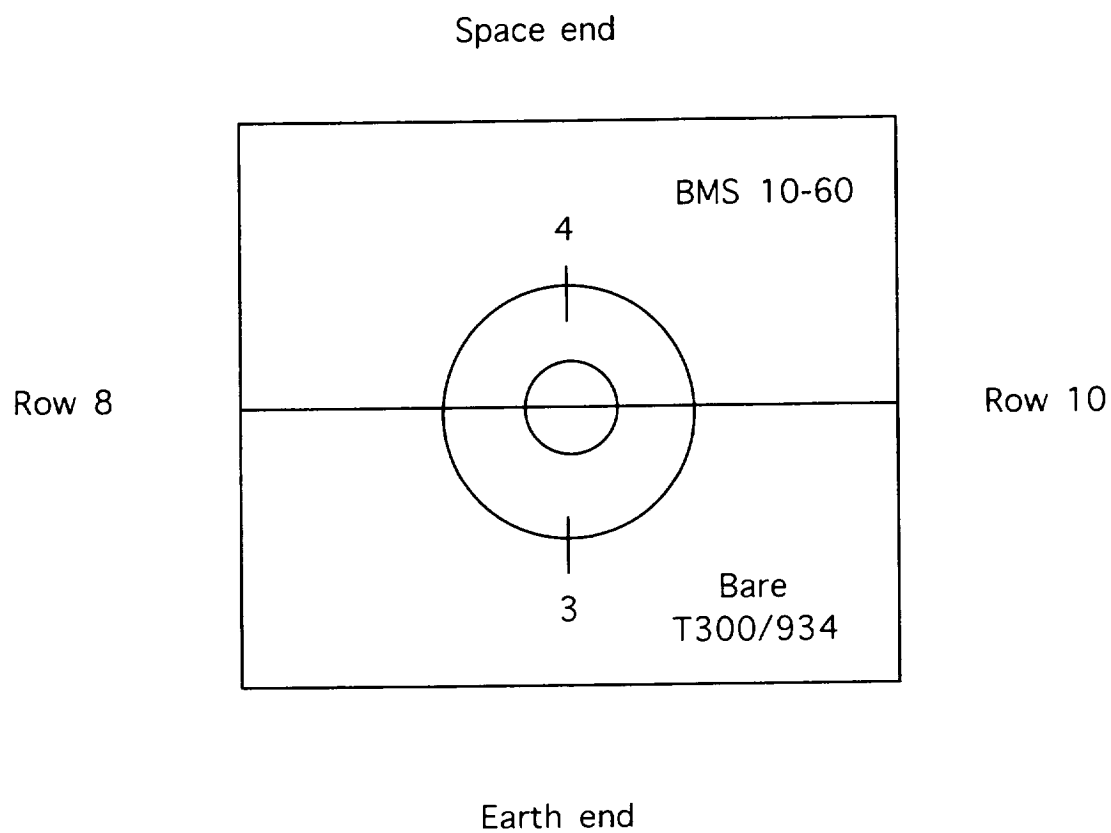

Figure A-21. Location of profilometer scans taken through the washer protected area and adjacent exposed areas in the BMS 10-60 white paint and bare T300/934 composite quadrants of the panel on tray D9.

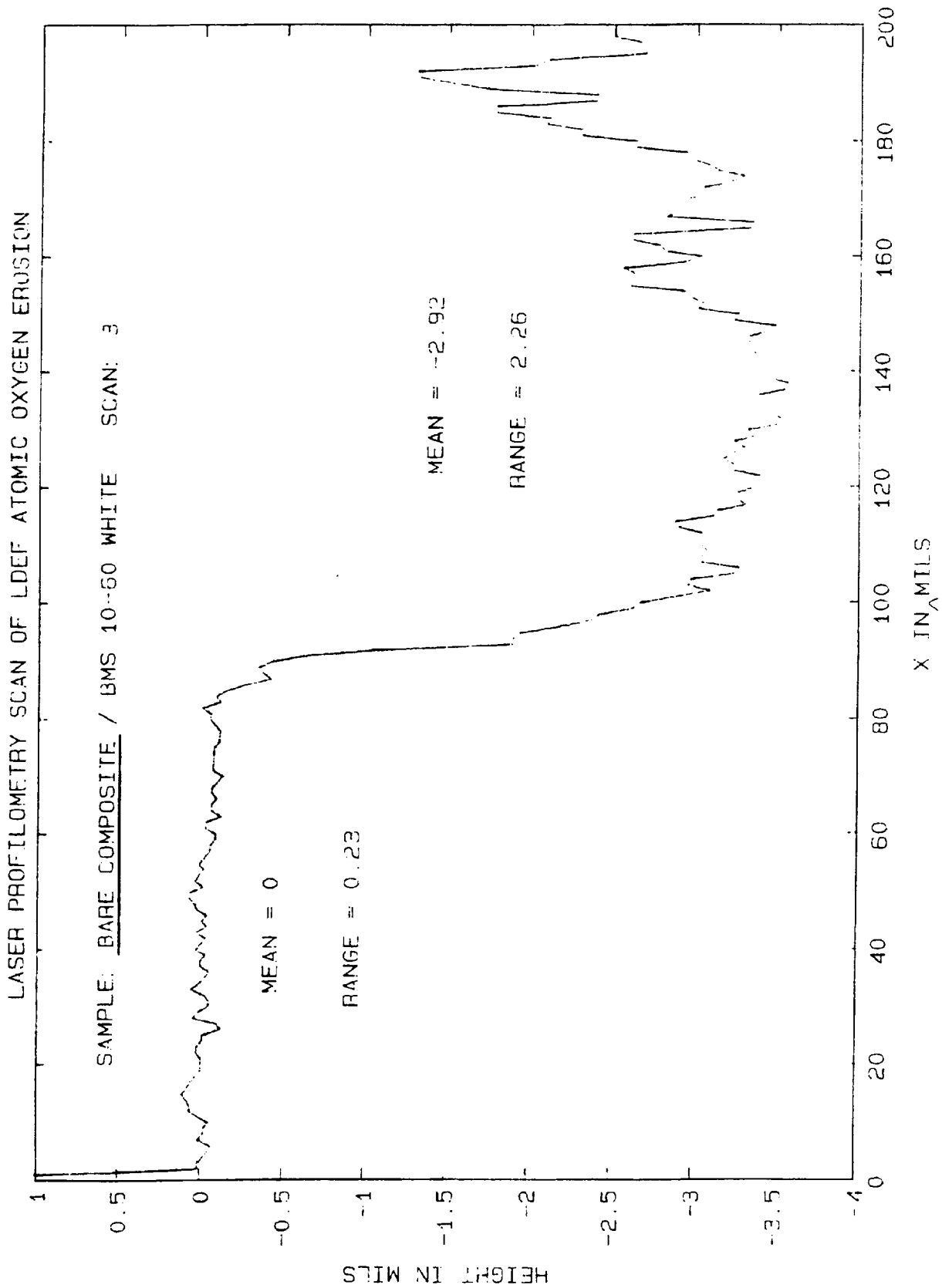

Figure A-22. Laser profilometry scan 3 from unexposed to exposed area of T300/934 surface on tray D9 composite panel. Taken from washer area between bare composite and BMS 10-60 coated quadrants.

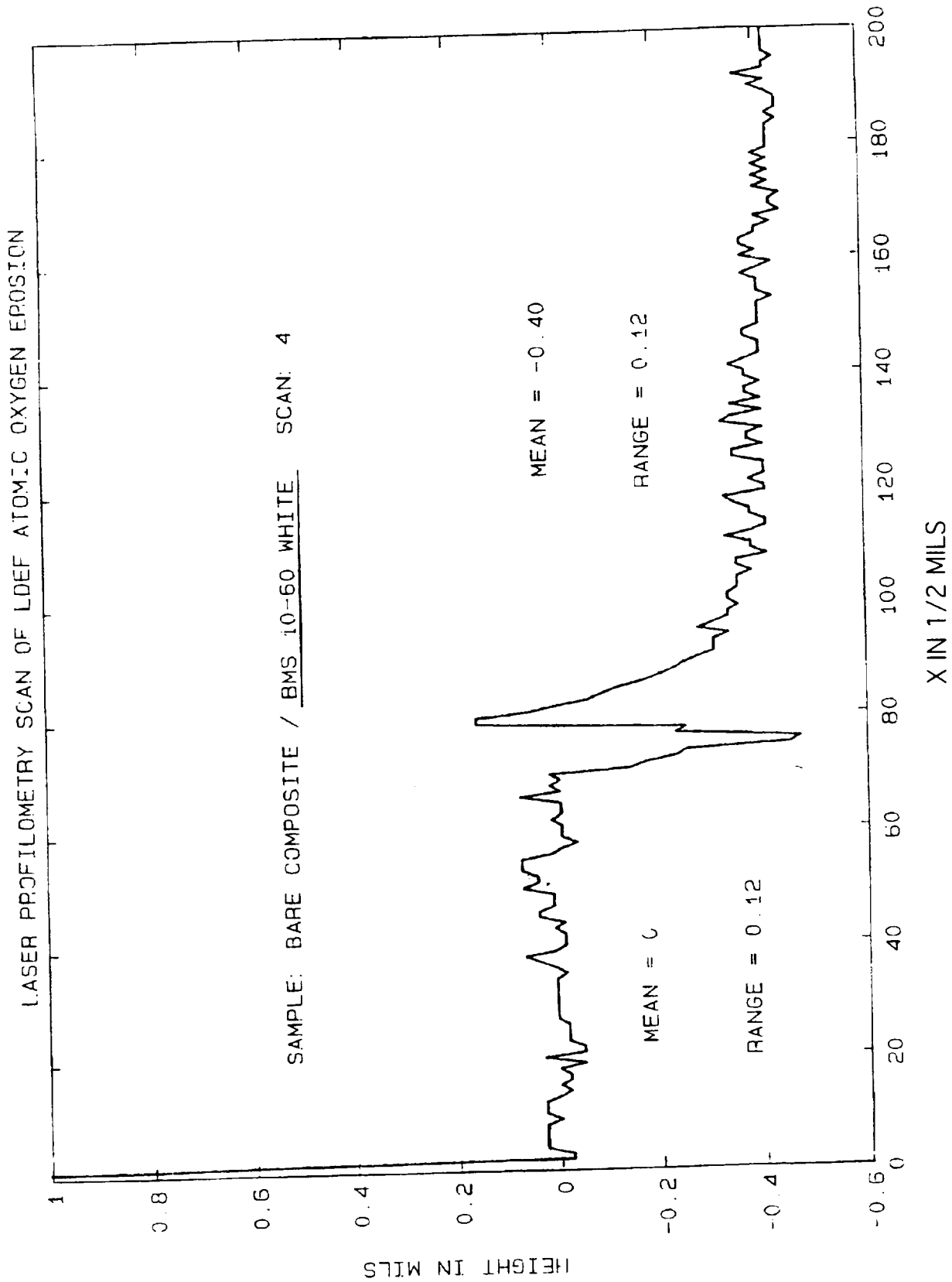

Figure A-23. Laser profilometry scan 4 from unexposed to exposed area of BMS 10-60 coated surface on tray D9 composite panel. Taken from washer area between bare composite and BMS 10-60 coated quadrants.

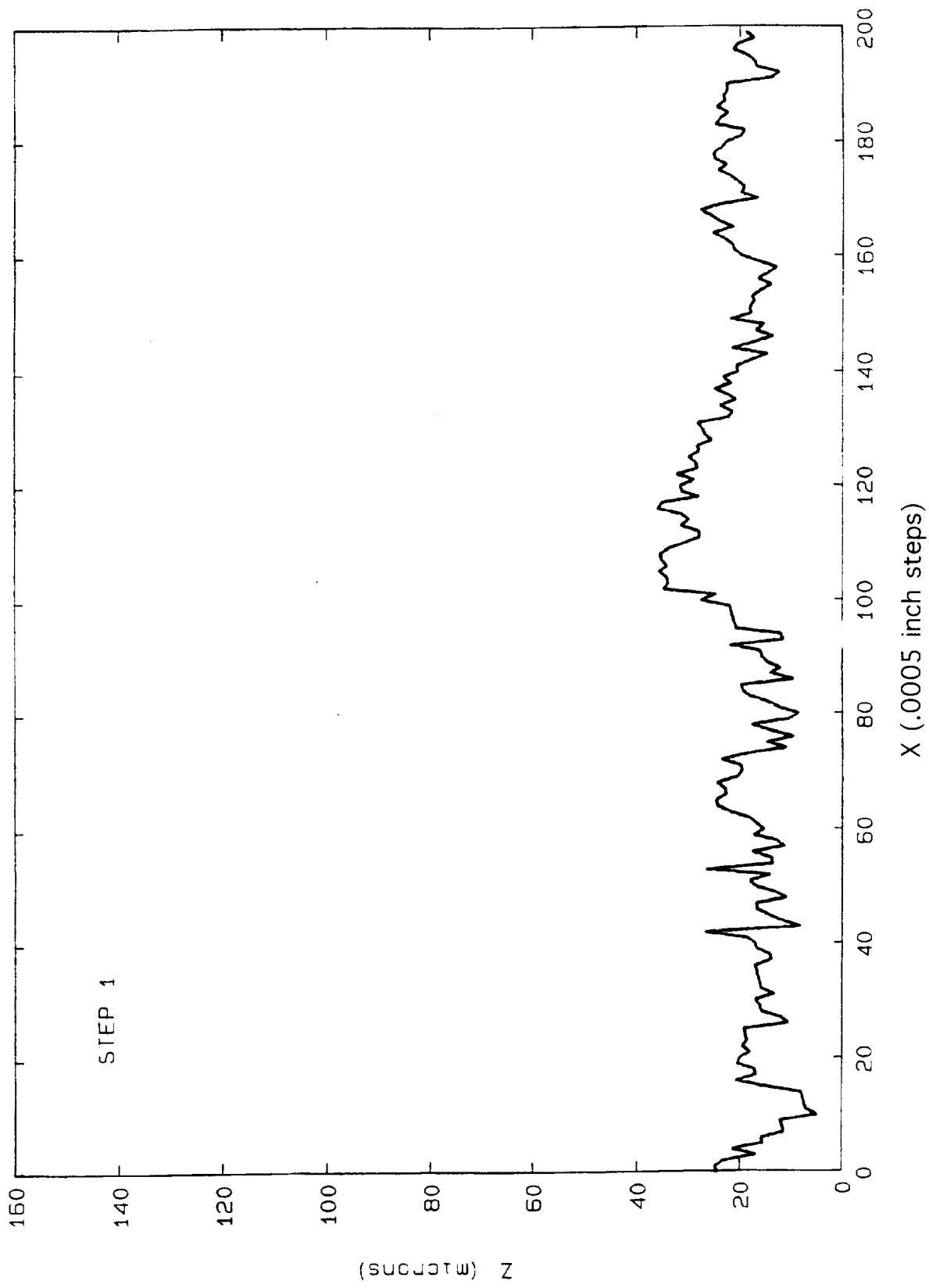

Figure A-24. Laser profilometry scan from exposed to unexposed area of composite tensile specimen from AO019 shown in figure 5, along line marked step 1.

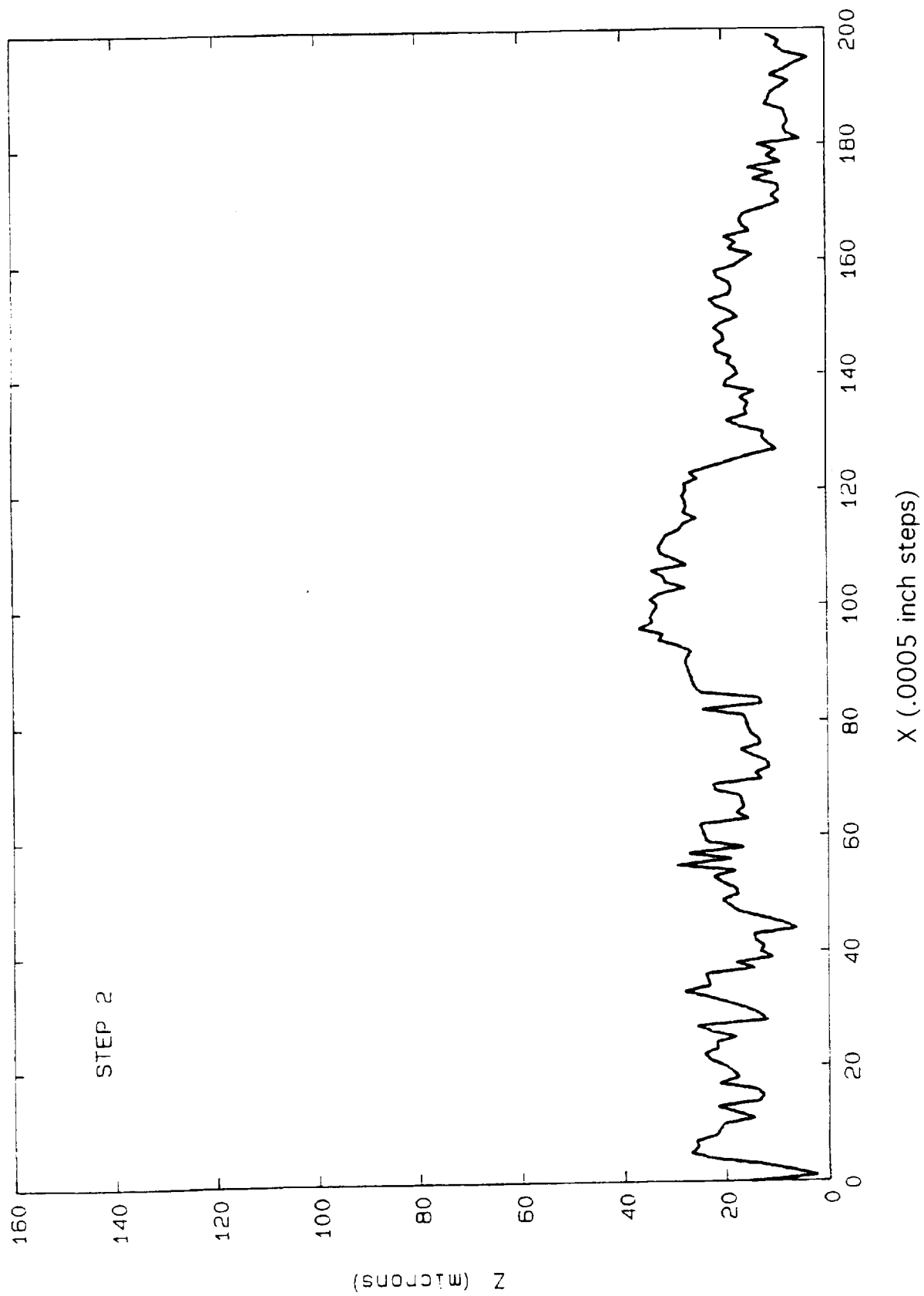

Figure A-25. Laser profilometry scan from exposed to unexposed area of composite tensile specimen from AO019 shown in figure 5, along line marked step 2.

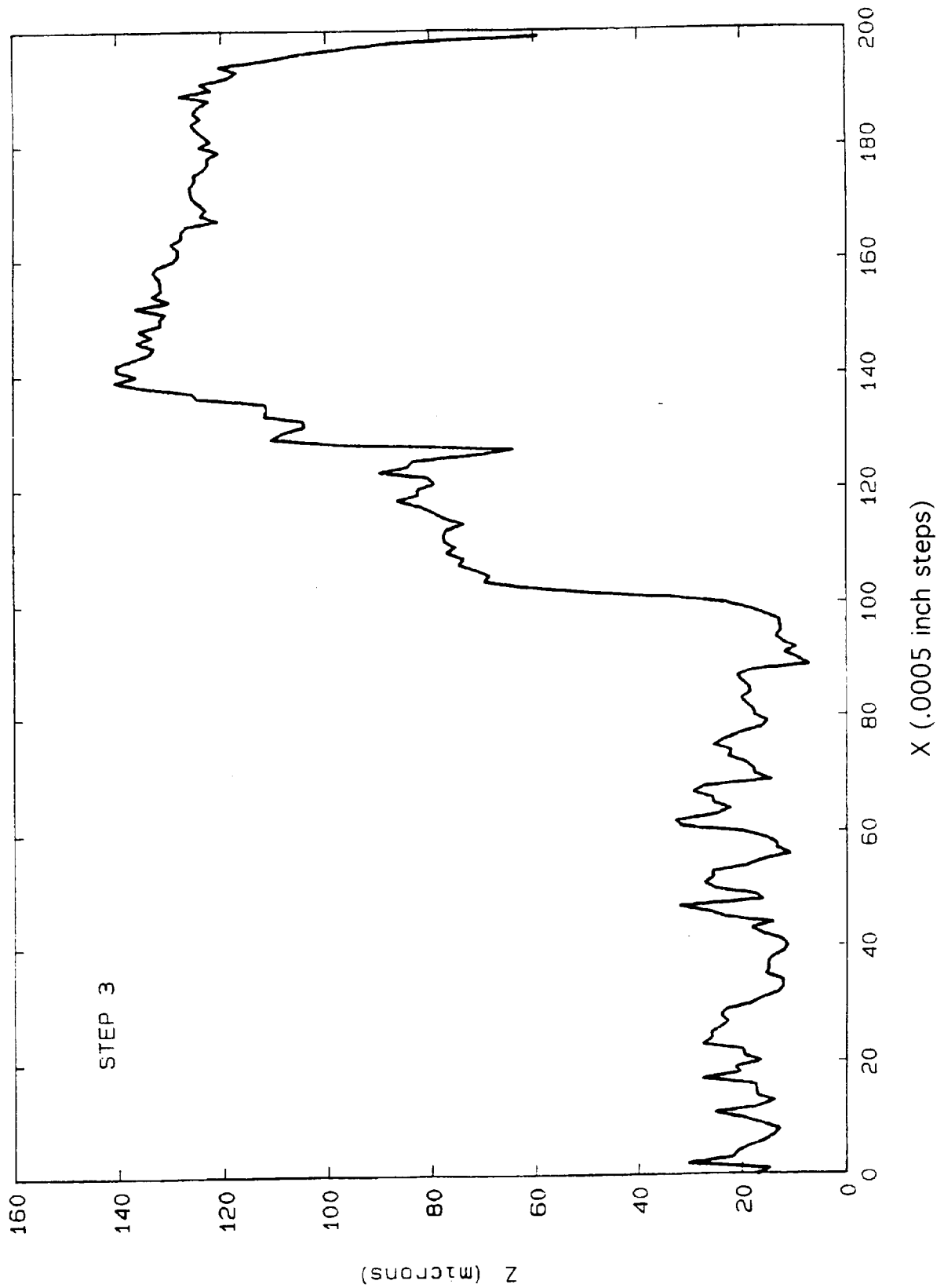

Figure A-26. Laser profilometry scan from exposed to unexposed area of composite tensile specimen from AO019 shown in figure 5, along line marked step 3.

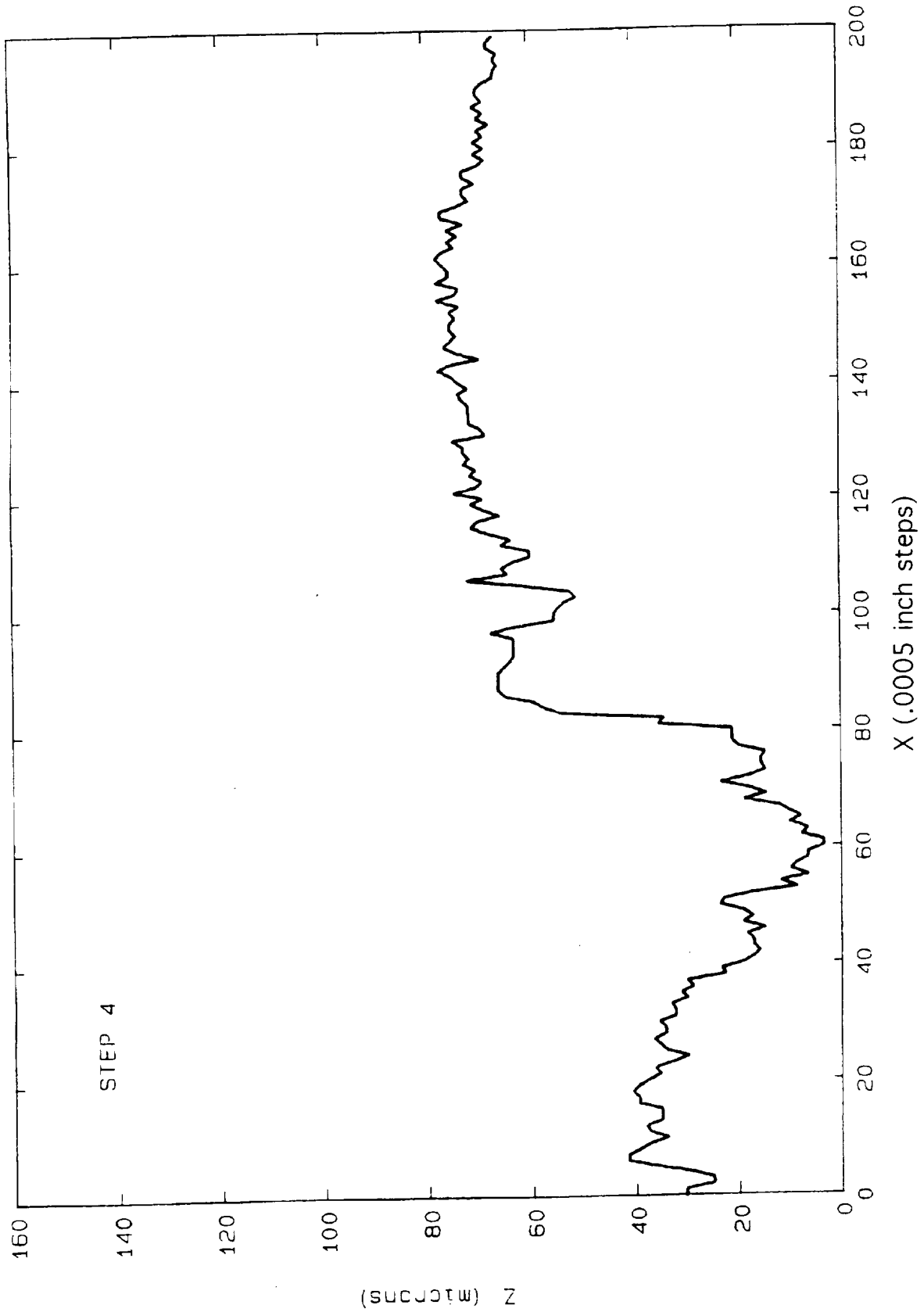

Figure A-27. Laser profilometry scan from exposed to unexposed area of composite tensile specimen from AO019 shown in figure 5, along line marked step 4.

REPORT DOCUMENTATION PAGE			Form Approved OMB No. 0704-0188	
Public reporting burden for this collection of information is estimated to average 1 hour per response, including the time for reviewing instructions, searching existing data sources, gathering and maintaining the data needed, and completing and reviewing the collection of information. Send comments regarding this burden estimate or any other aspect of this collection of information, including suggestions for reducing this burden, to Washington Headquarters Services, Directorate for Information Operations and Reports, 1215 Jefferson Davis Highway, Suite 1204, Arlington, VA 22202-4302, and to the Office of Management and Budget, Paperwork Reduction Project (0704-0188), Washington, DC 20503.				
1. AGENCY USE ONLY (Leave blank)		2. REPORT DATE April 1995	3. REPORT TYPE AND DATES COVERED Contractor Report (Feb. 1990-Feb. 1995)	
4. TITLE AND SUBTITLE Composite Materials Flown on the Long Duration Exposure Facility			5. FUNDING NUMBERS C NAS1-18224 C NAS1-19247	
6. AUTHOR(S) Pete E. George, Harry W. Dursch, and H. Gary Pippin			WU 506-43-61-02 WU 233-03-02-04	
7. PERFORMING ORGANIZATION NAME(S) AND ADDRESS(ES) Boeing Defense & Space Group P. O. Box 3999 Seattle, WA 98124-2499			8. PERFORMING ORGANIZATION REPORT NUMBER	
9. SPONSORING / MONITORING AGENCY NAME(S) AND ADDRESS(ES) National Aeronautics and Space Administration Langley Research Center Hampton, VA 23681-0001			10. SPONSORING / MONITORING AGENCY REPORT NUMBER NASA CR-4657	
11. SUPPLEMENTARY NOTES Langley Technical Monitor: Joan G. Funk				
12a. DISTRIBUTION / AVAILABILITY STATEMENT Unclassified-Unlimited Subject Category 23			12b. DISTRIBUTION CODE	
13. ABSTRACT (Maximum 200 words) Organic composite test specimens were flown on several LDEF experiments. Both bare and coated composites were flown. Atomic oxygen eroded bare composite material, with the resins being recessed at a greater rate than the fibers. Selected coating techniques protected the composite substrate in each case. Tensile and optical properties are reported for numerous specimens. Fiberglass and metal matrix composites were also flown.				
14. SUBJECT TERMS composites, graphite epoxy, LDEF, low earth orbit, organic resins			15. NUMBER OF PAGES 66	
			16. PRICE CODE A04	
17. SECURITY CLASSIFICATION OF REPORT Unclassified	18. SECURITY CLASSIFICATION OF THIS PAGE Unclassified	19. SECURITY CLASSIFICATION OF ABSTRACT Unclassified	20. LIMITATION OF ABSTRACT UL	

