

1995118846

40913 p. 26



Predictability in Space Launch Vehicle Anomaly Detection Using Intelligent Neuro-Fuzzy Systems

JPL JSC McDonnell Douglas Lockheed
Joint Effort

JPL Team

Sandeep Gulati Raoul Tawel
Nikzad Toomarian Anil Thakoor
Jacob Barhen Taher Daud
Ayanna Maccalla

Jet Propulsion Laboratory
California Institute of Technology
Center for Space Microelectronics Technology
Pasadena, CA

INTELLIGENT NEUROPROCESSORS FOR LAUNCH VEHICLE HEALTH MANAGEMENT SYSTEMS

742 TOTAL FLIGHTS (1966-87), 58 failures

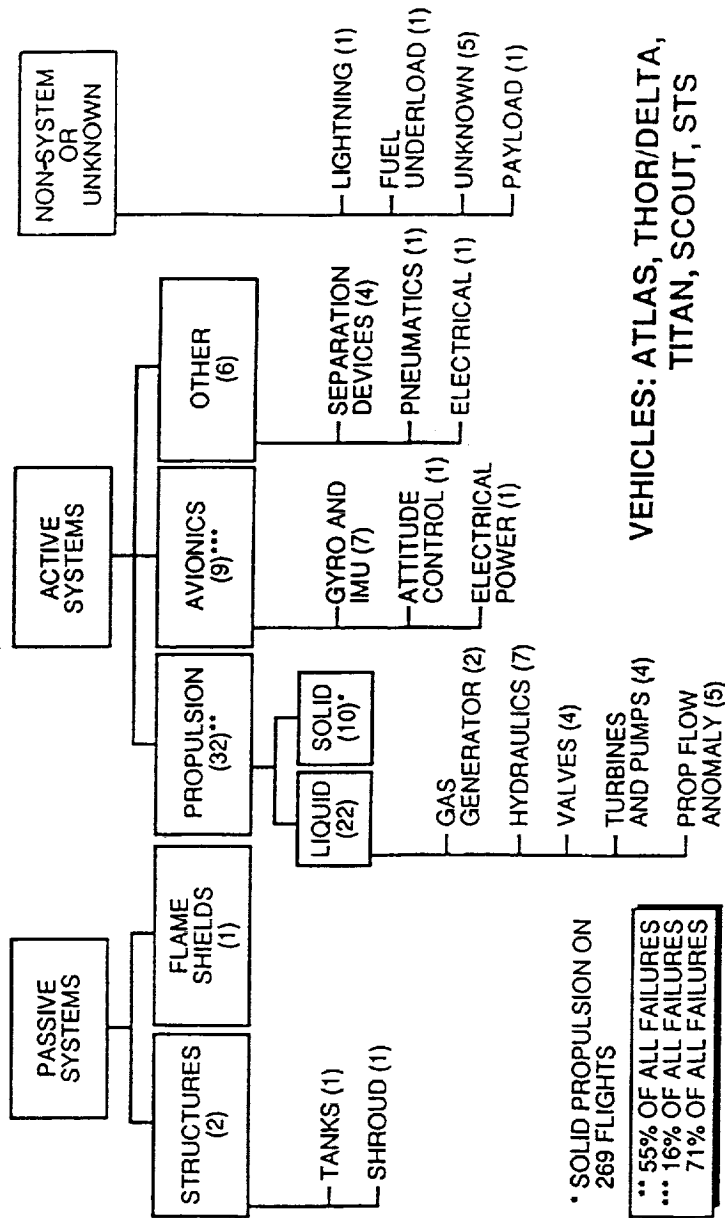

* SOLID PROPULSION ON 269 FLIGHTS

** 55% OF ALL FAILURES
*** 16% OF ALL FAILURES
71% OF ALL FAILURES

Where The Flight Failures Have Been In Launch Vehicles

INTELLIGENT NEUROPROCESSORS FOR LAUNCH VEHICLE HEALTH MANAGEMENT SYSTEMS

STS LAUNCH DELAY ASSESSMENT (AS OF JAN 24 1992)

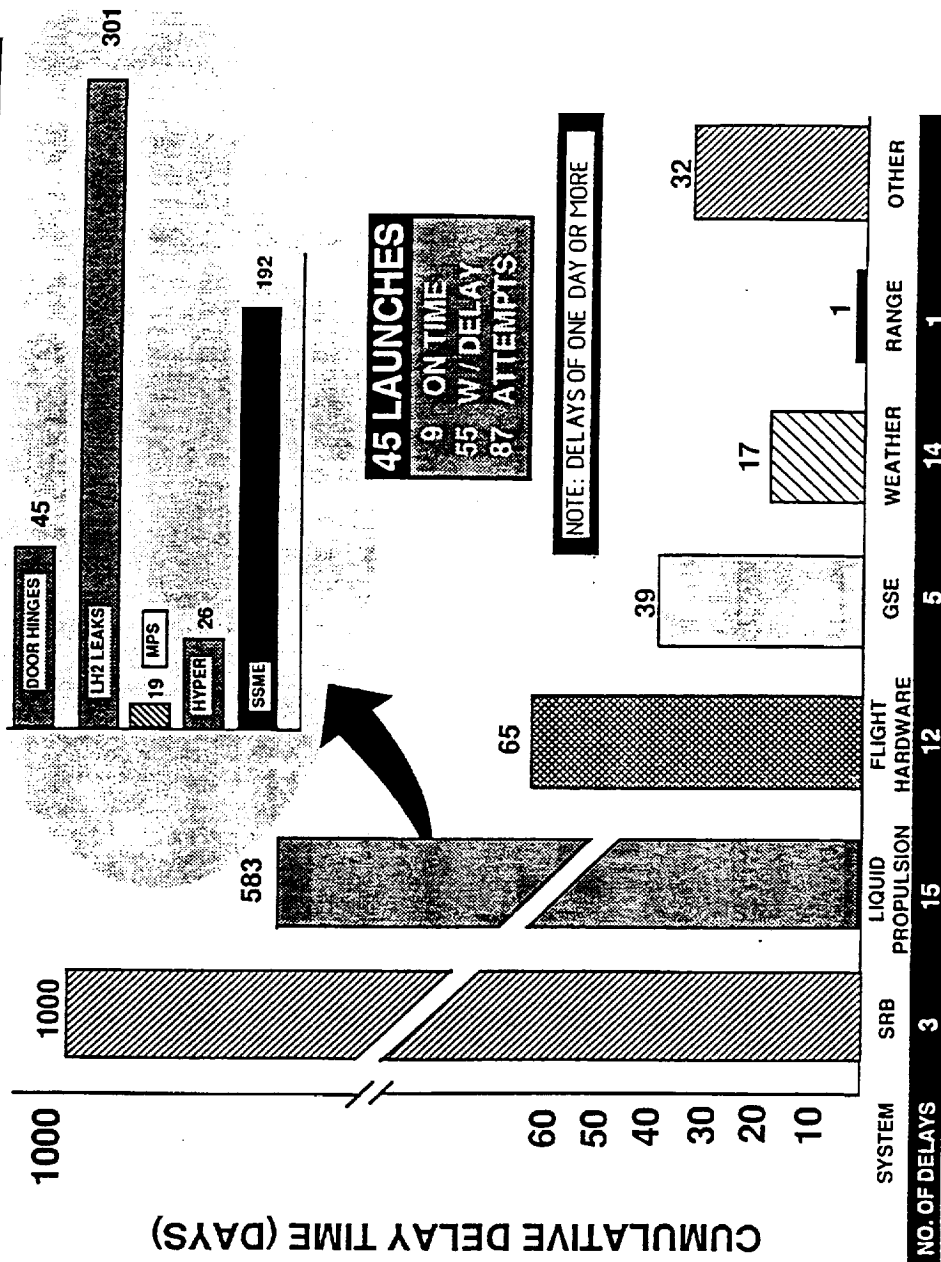

INTELLIGENT NEUROPROCESSORS FOR LAUNCH VEHICLE HEALTH MANAGEMENT SYSTEMS

Breakdown of Operations Hours

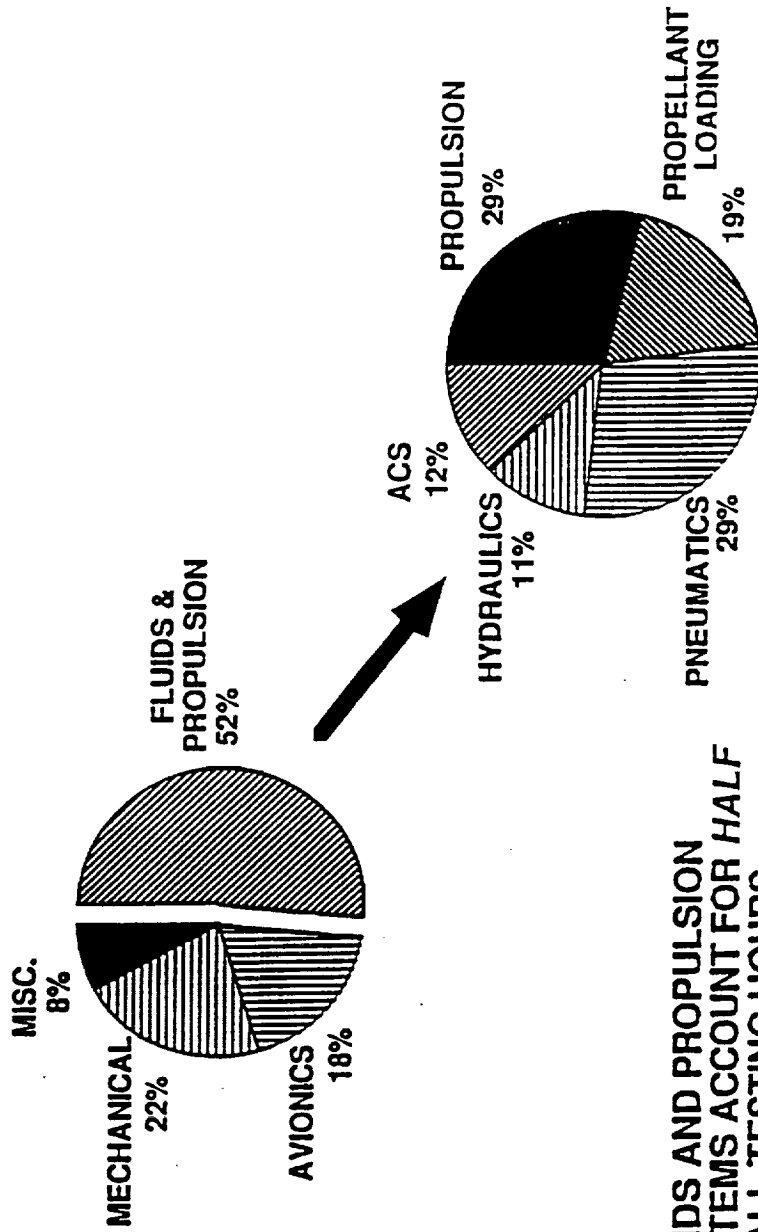

FLUIDS AND PROPULSION
SYSTEMS ACCOUNT FOR HALF
OF ALL TESTING HOURS.

SPACEPORT FLORIDA INFRASTRUCTURE IMPROVEMENT STUDY

Failure of Mars Probe Blamed on Fuel Leak

Troubled Spacecraft

A federal panel Wednesday announced the findings of its inquiry into the Aug. 21 disappearance of the \$980 million Mars Observer spacecraft. Exactly what happened to the space probe is not known, but the independent panel found these problems:

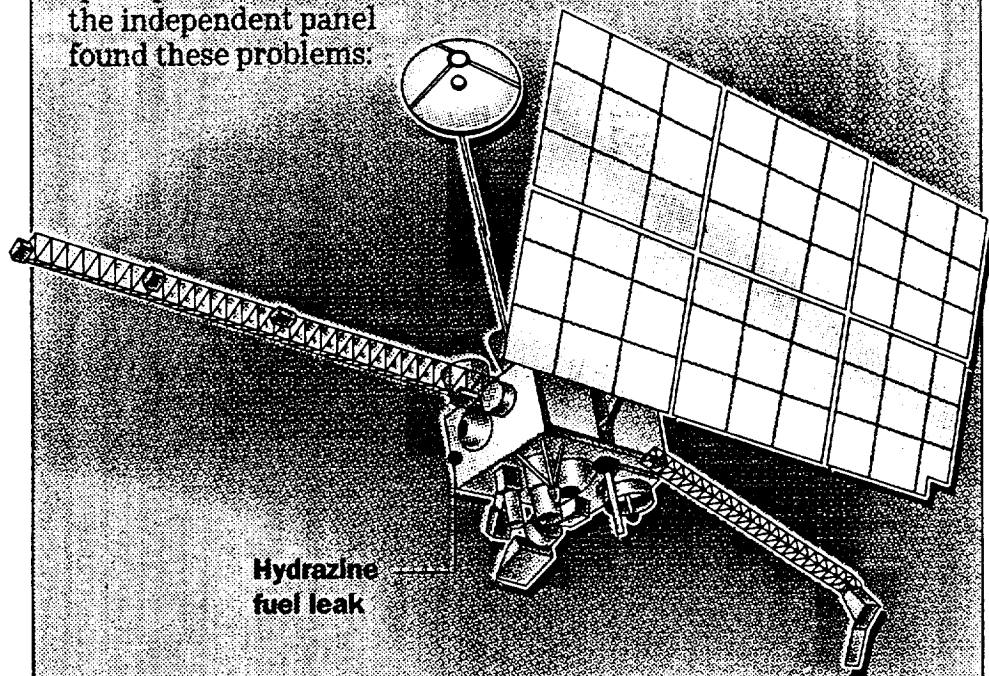

- **Mechanical flaw:** A leak of volatile hydrazine fuel may have caused an explosion when the spacecraft's tanks were pressurized.
- **Design flaw:** NASA engineers used technology that had been developed for operation in near-Earth orbit but was unsuitable for the more extreme conditions of interplanetary space.
- **Management flaw:** Project managers at the Jet Propulsion Laboratory did not exercise sufficient control over continuing changes in the spacecraft's design and its scientific instruments.

Source: NASA

INTELLIGENT NEUROPROCESSORS FOR LAUNCH VEHICLE HEALTH MANAGEMENT SYSTEMS

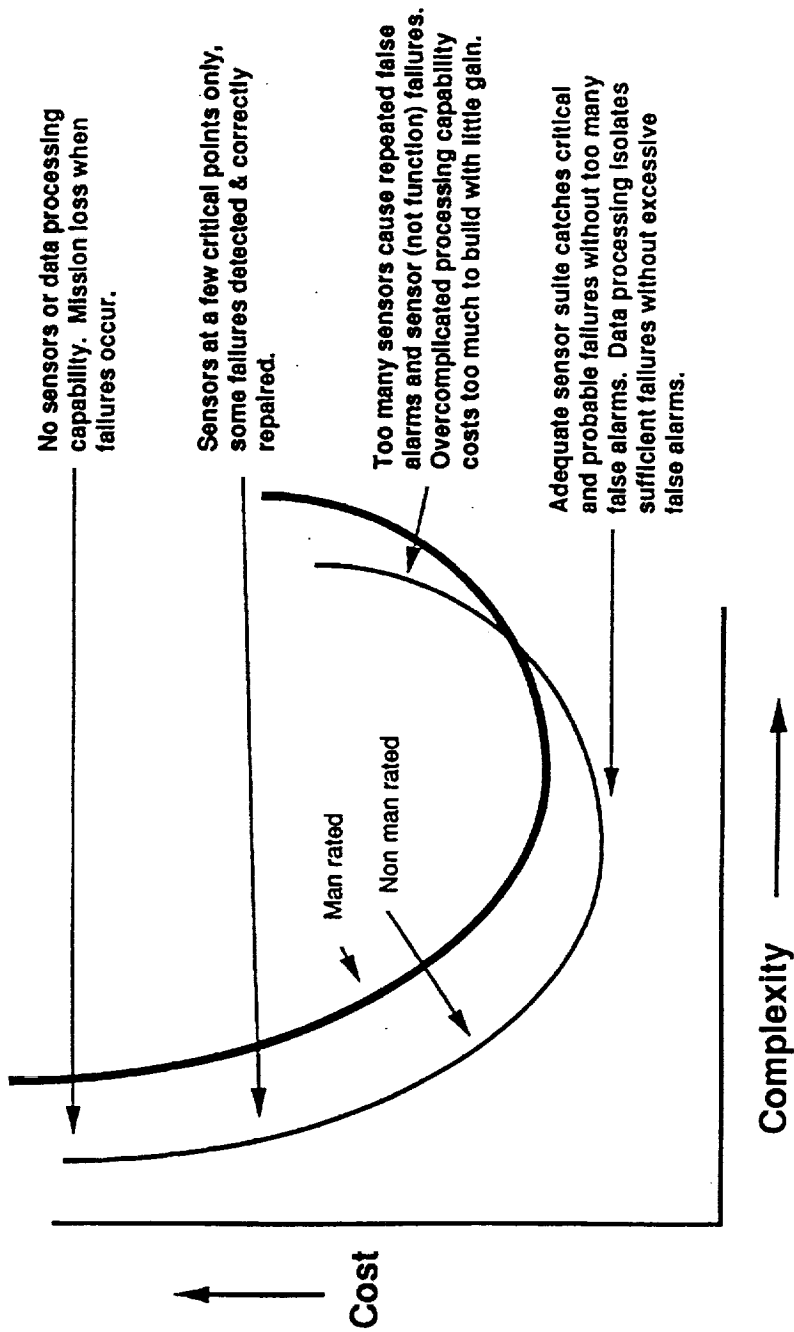

VHM COST OPTIMIZING CURVE

INTELLIGENT NEUROPROCESSORS FOR LAUNCH VEHICLE HEALTH MANAGEMENT SYSTEMS

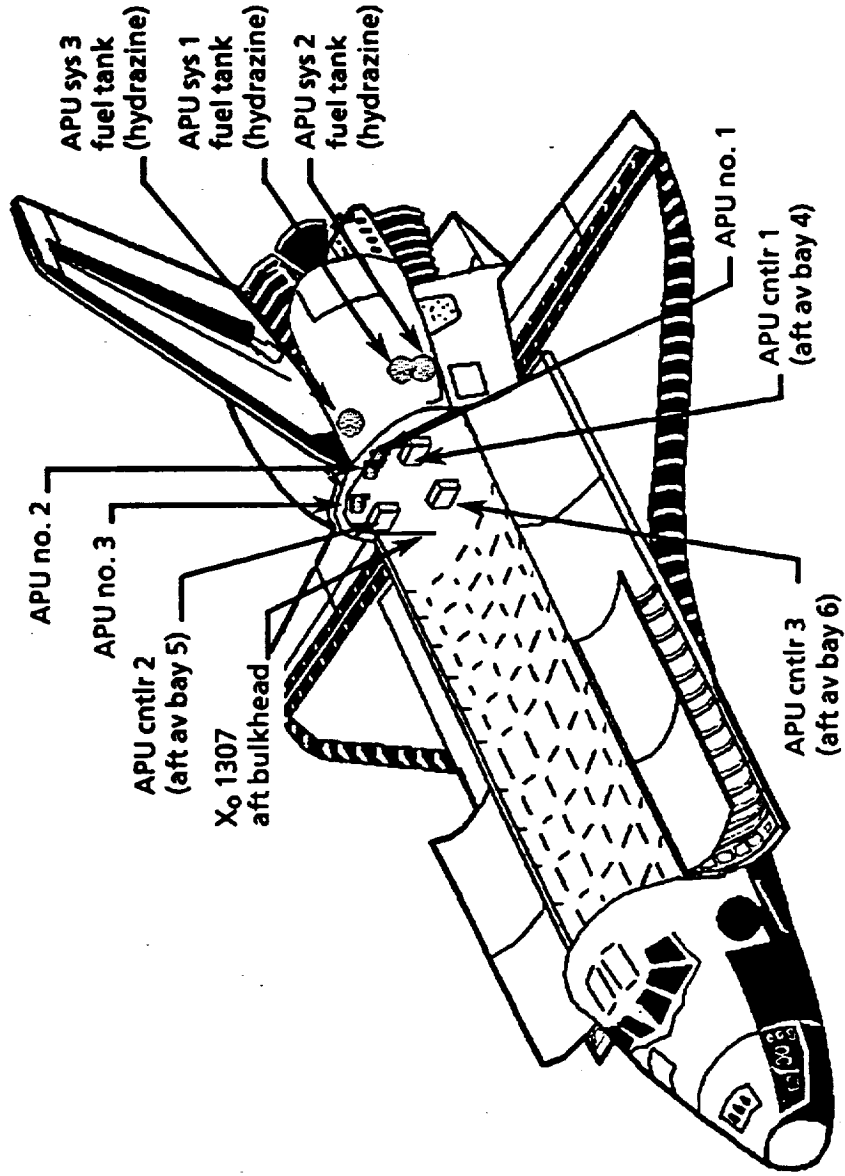

TARGET HMS - STS Auxiliary Power Unit Location

**INTELLIGENT NEUROPROCESSORS FOR LAUNCH
VEHICLE HEALTH MANAGEMENT SYSTEMS**

AUXILIARY POWER UNIT

- **Provide power for the Orbiter hydraulic systems**
 - **liquid hydrazine -----> mechanical shaft power**
- **Hydraulic systems**
 - **actuate the Orbiter aerosurfaces**
 - **throttle and steer Orbiter main engines**
 - **deploy and steer landing gear**
 - **apply landing gear brakes**
- **Operation Cycle**
 - **t-5 min to OMS-1 burn**
 - **deorbit burn and entry to just before landing**

**INTELLIGENT NEUROPROCESSORS FOR LAUNCH
VEHICLE HEALTH MANAGEMENT SYSTEMS**

- **Monitoring fuel tank isolation, fuel control valves and electronic controller, e.g.,**
 - **valve open for > 2 min in orbit without fuel flow could detonate hyrazine near valve**
 - **leakage detection**
 - **high rmp pulser-type valves**

APU MONITORING AND DIAGNOSIS

INTELLIGENT NEUROPROCESSORS FOR LAUNCH VEHICLE HEALTH MANAGEMENT SYSTEMS

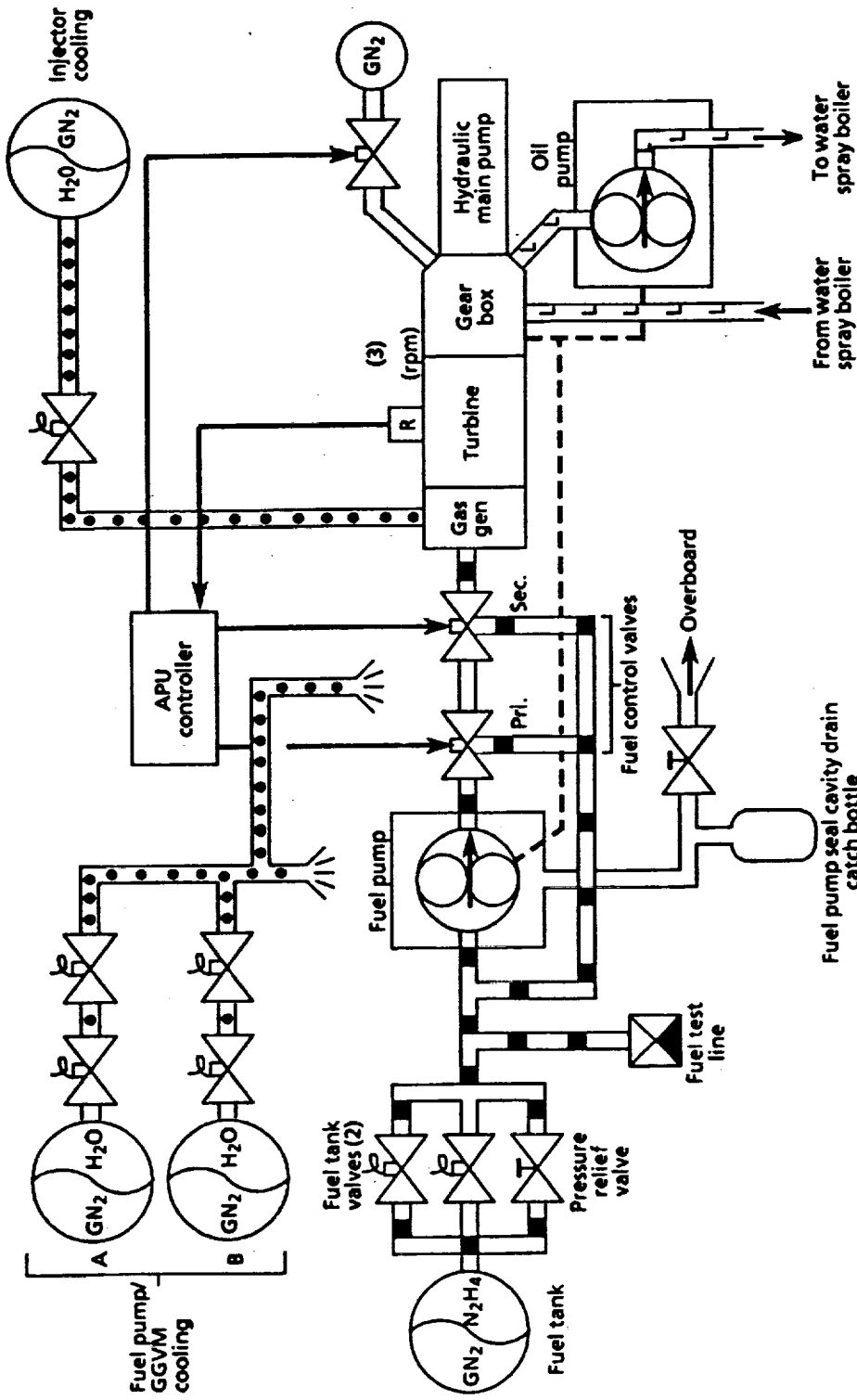

TARGET HMS - STS Auxiliary Power Unit

INTELLIGENT NEUROPROCESSORS FOR LAUNCH VEHICLE HEALTH MANAGEMENT SYSTEMS

TECHNOLOGY ISSUES

- Engineering alarm limits - critical thresholds which define the acceptable range of engineering values on any telemetry channel
 - determined manually: hardcopy ISOE data, design information on spacecraft, rules of thumb
 - Overreliance on domain experts leading to wide thresholds creating a range of undetected anomalies
 - monitoring of individual sensors via redlining approach
- Access only to snapshots of telemetry due to exploitation of low sensor acquisition rates. Further degradation due to noisy and incomplete data
- Specific diagnostics can be executed only if they were preconceived and preprogrammed
 - cannot currently correlate effects between multiple sensors in real-time
 - fault-detection to engine catastrophe time can be as short as 0.1 sec.

INTELLIGENT NEURO-FUZZY SYSTEM

for STS APU Health Monitoring

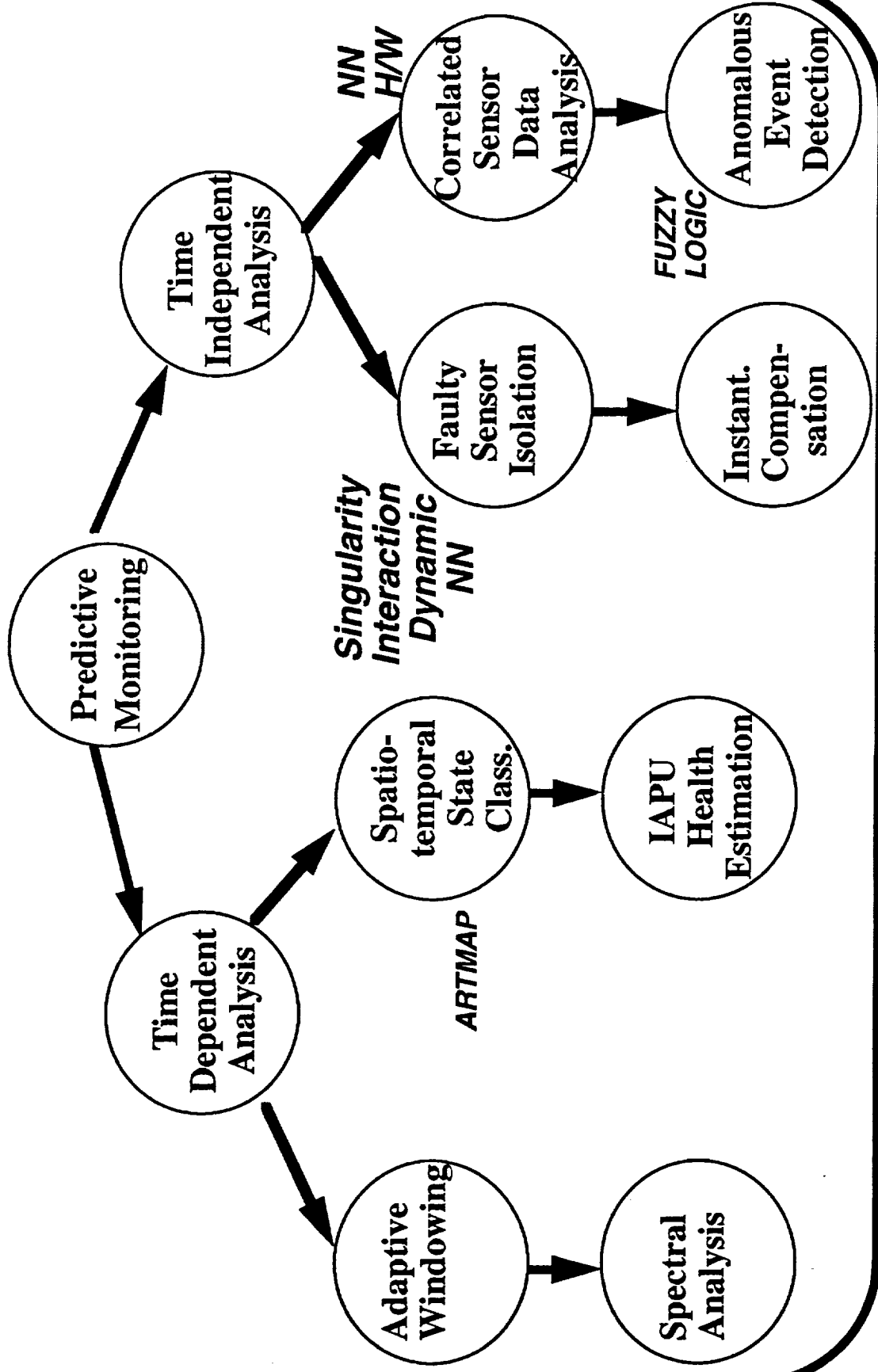

Integration of Neural Networks & Fuzzy Logic

NASA JSC,
McDonnell
Douglas

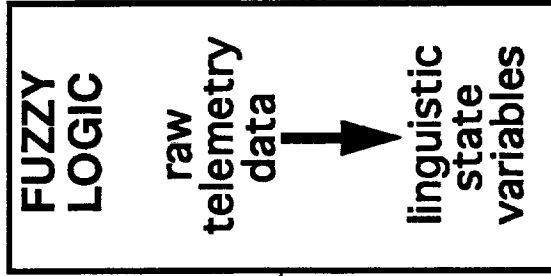

JPL

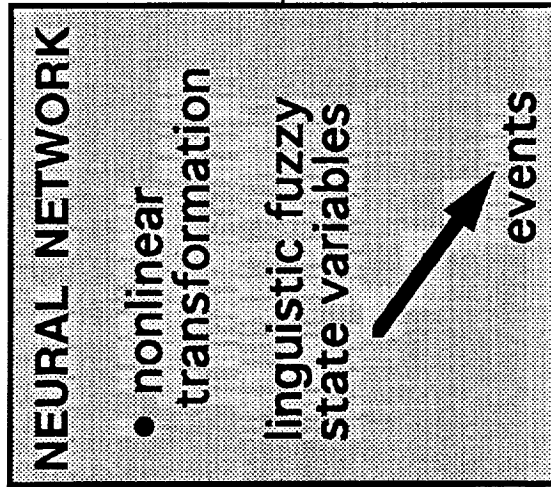

NASA JSC,
JPL, Lockheed

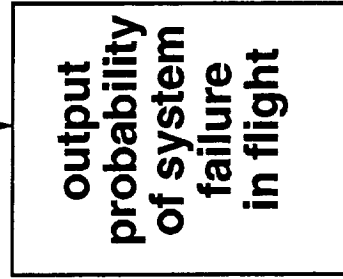
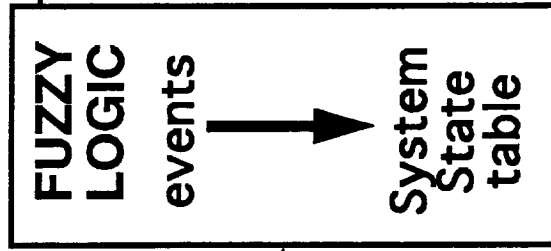

- 100 Hz
- linguistic space

Sensor_1
•
•
•
Sensor_k

INTELLIGENT NEUROPROCESSORS FOR LAUNCH VEHICLE HEALTH MANAGEMENT SYSTEMS

STS / APU HEALTH MONITORING

- detection of all red line errors currently identified
- real-time correlation of data from multiple heterogeneous sensors
 - faster-than-real-time anomaly propagation to determine probability of failure
 - both with (using NN s/w) and without (using NN h/w) time-lags
- ease of augmenting expert-generated APU fault knowledge base without needing to redesign the system
- isolating failed sensors as against failed subsystem / system
 - reconstruct suspect information and minimize disruption of diagnostic process
- synergistic integration of fuzzy logic and neural networks for real-time diagnostic applications

**INTELLIGENT NEUROPROCESSORS FOR LAUNCH
VEHICLE HEALTH MANAGEMENT SYSTEMS**

STS / APU HEALTH MONITORING

- **Startup & mode-switch phases difficult to monitor due to highly complex & nonlinear nature of IAPU dynamics**
- **reduced engine / test stand damage during test firings**
 - **typically damage 1 APU every 2 weeks**
- **facilitate post-test diagnostic process**
 - **tool for APU knowledge engineering**

Graph(1-8)

Graph(9-16)

Zoom

Quitzoom

Data

Quit

V46P0105A
APU 1 FU LN OUT PRESS

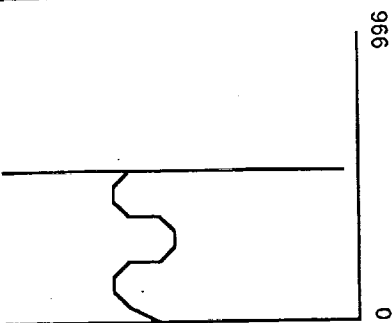

V46P0110A
APU 1 FU PMP IN PRESS

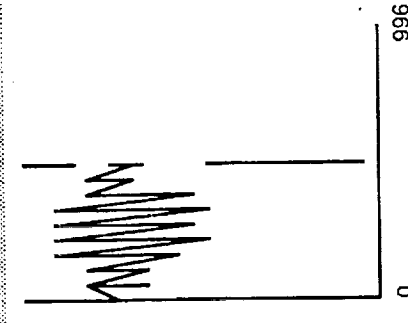

V46T0102A
APU 1 FU TK TEMP

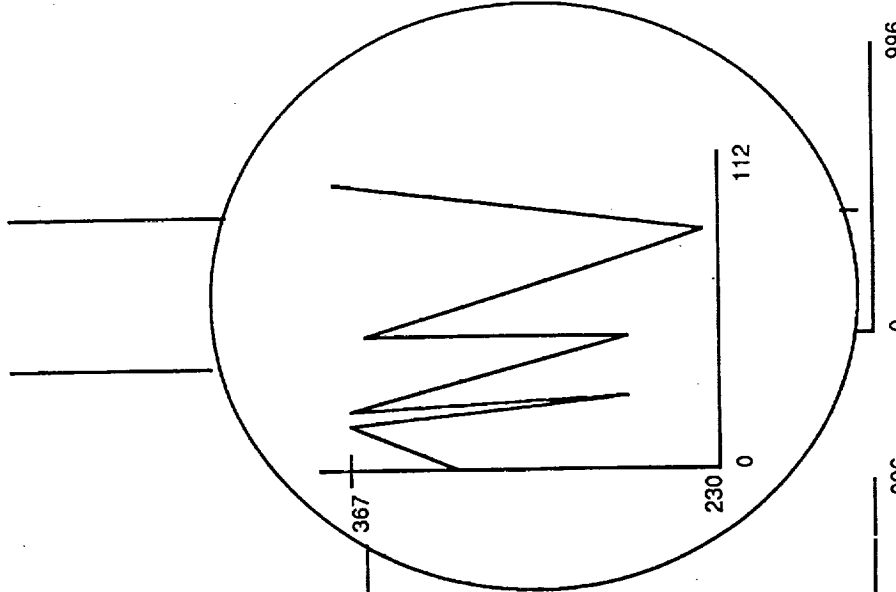

V46T0130A
APU 1 FU TK SKIN TEMP

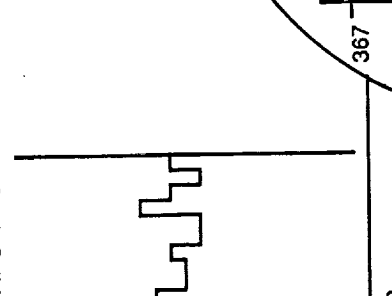

V
APU 1 F

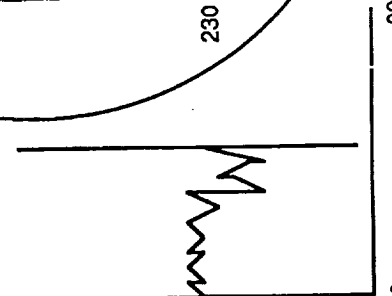

V46T0180A
APU 1 FU LN GN2 PRESS

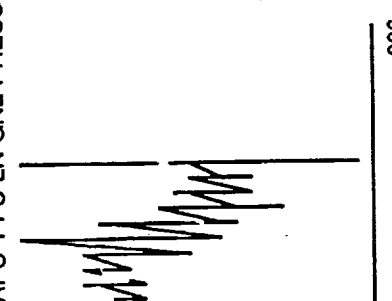

V46P0190A
APU 1 FU PMP DRN LN P-1

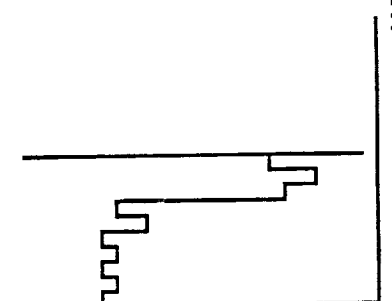

SUBSYSTEM: APU
STS-043

APU 1 GAS GENERATOR CHAMBER PRESS
APU 1 CHAMBER PRESSURE VS TURBINE SPEED

FORMAT: APU1GG-SPD
DATA: DESGGPRESZ

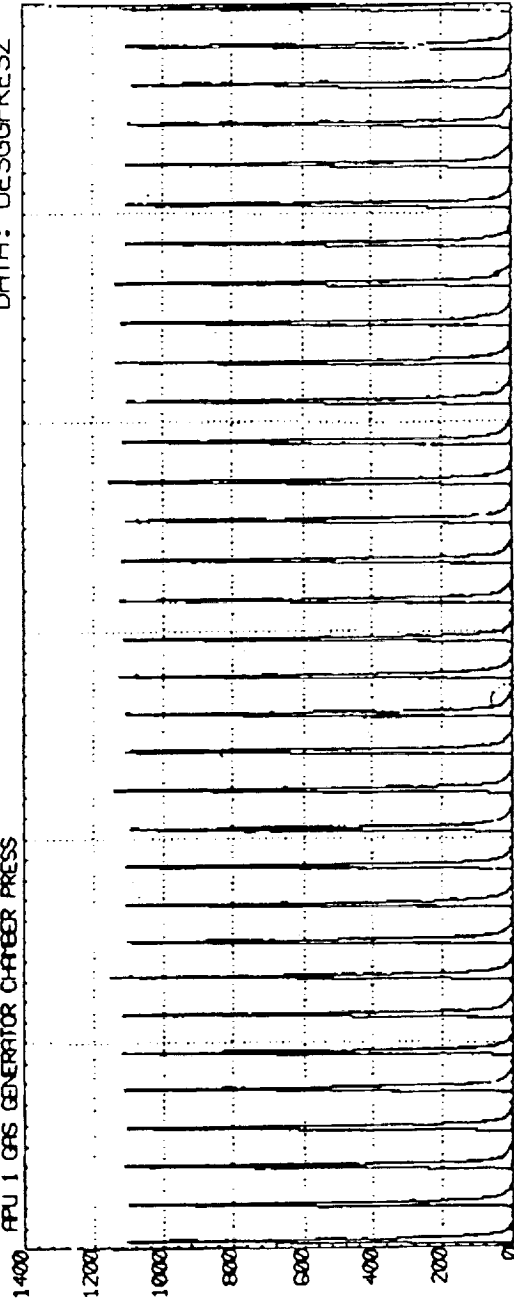

V46P0120A
(PSIA)

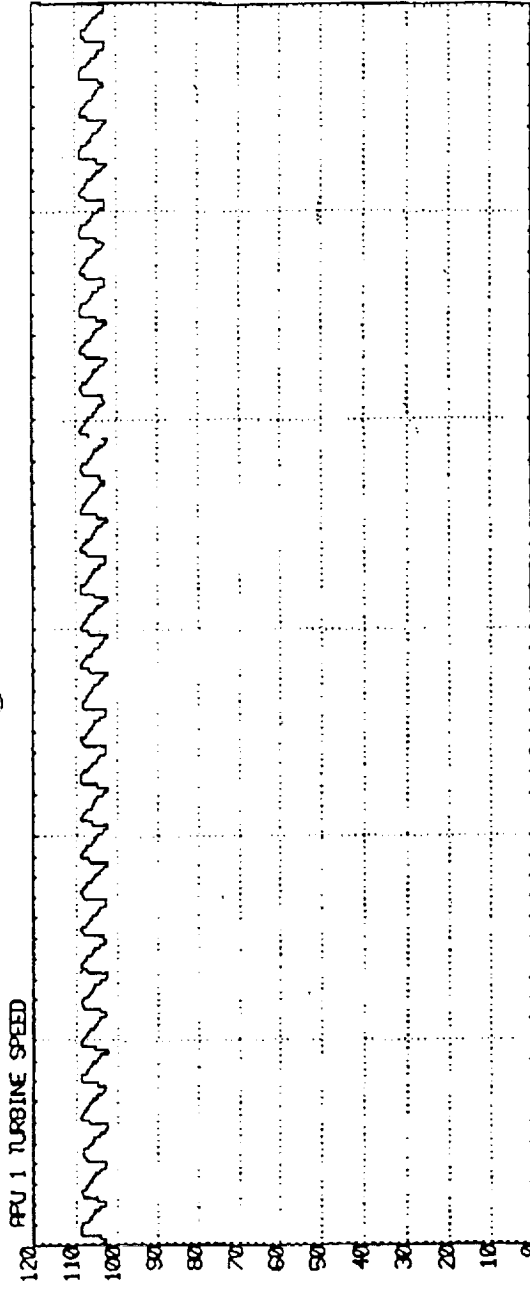

V46R0136A
(PCT)

223:11:57:45.000
223:11:57:55.000
223:11:58:00.000
223:11:58:05.000
223:11:58:10.000
223:11:58:15.000

G M T

SUBSYSTEM: APU
STS-031

APU 1 GFS GENERATOR CHAMBER PRESS
APU CHAMBER PRESSURE

FORMAT: APUGGPRESS
DATA: B31MA-0019

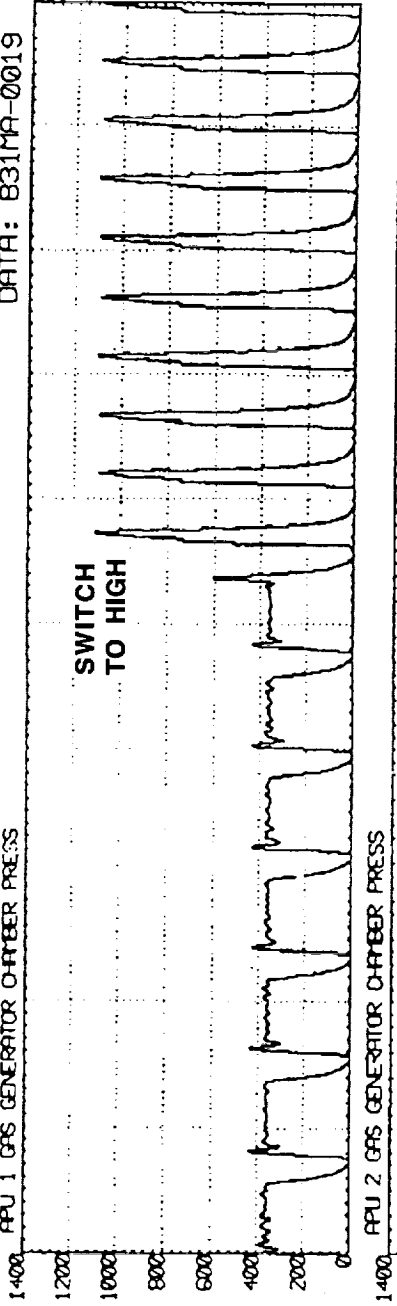

V46P0120A
(PSIA)

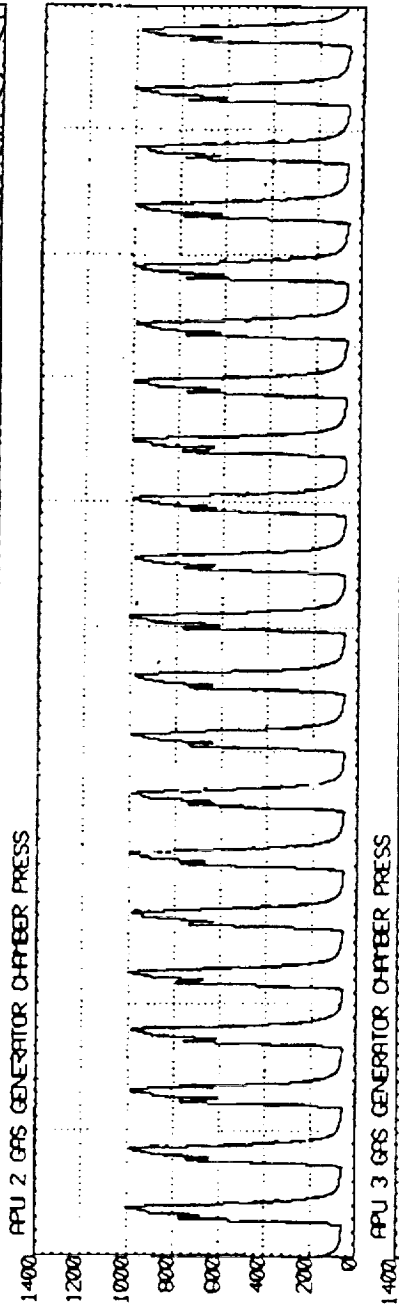

V46P0220A
(PSIA)

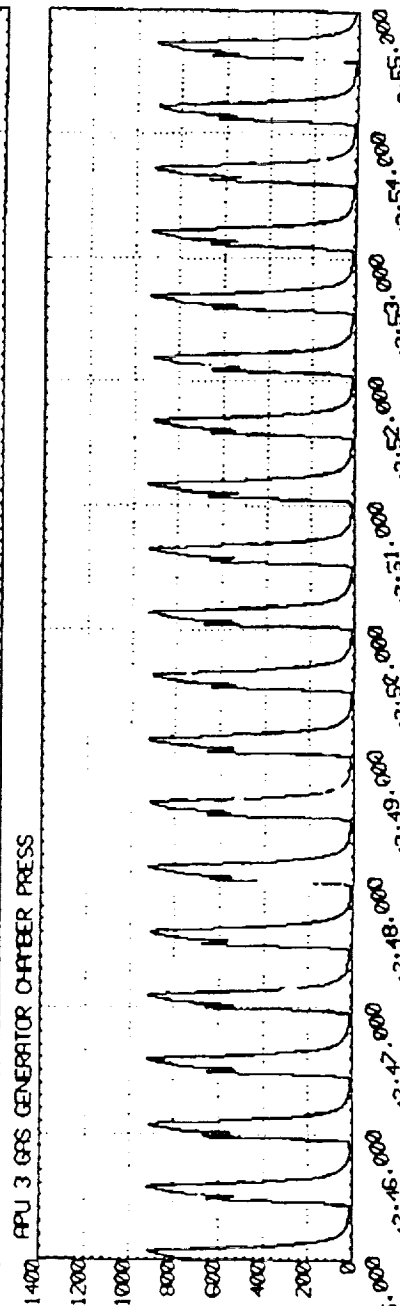

V46P0320A
(PSIA)

100:12:42:45.000
100:12:42:46.000
100:12:42:47.000
100:12:42:48.000
100:12:42:49.000
100:12:42:50.000
100:12:42:51.000
100:12:42:52.000
100:12:42:53.000
100:12:42:54.000
100:12:42:55.000
G M T

SUBSYSTEM: MER
STS-031

APU GAS GENERATOR CHAMBER PRESSURE

FORMAT: EVT_APU.GG
DATA: 831MA-0014

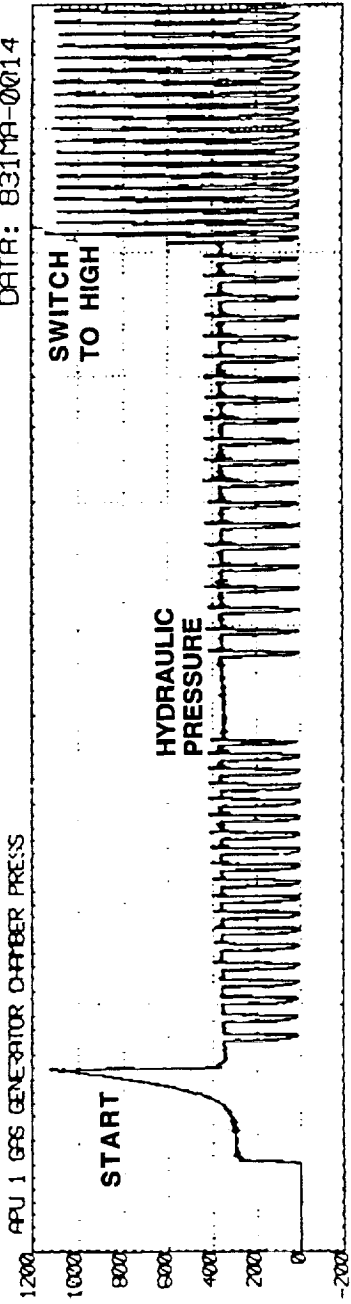

V46P01209A
(PSIA)

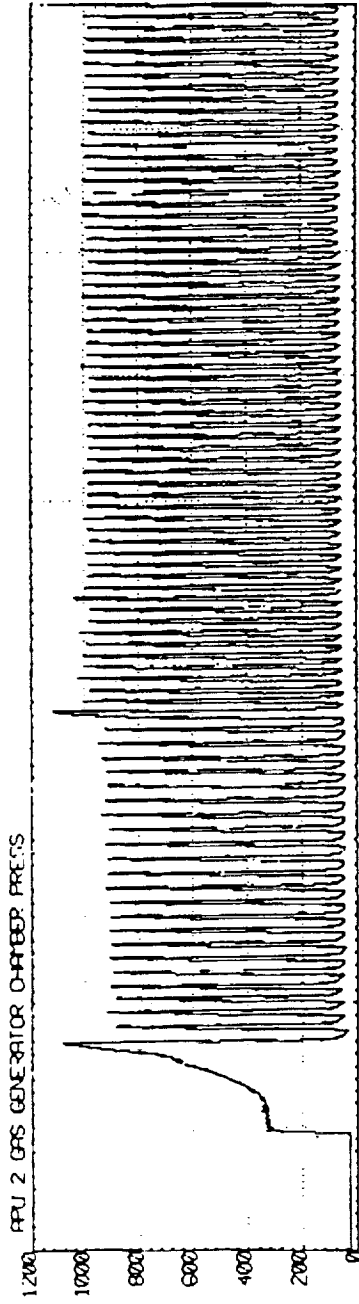

V46P02209A
(PSIA)

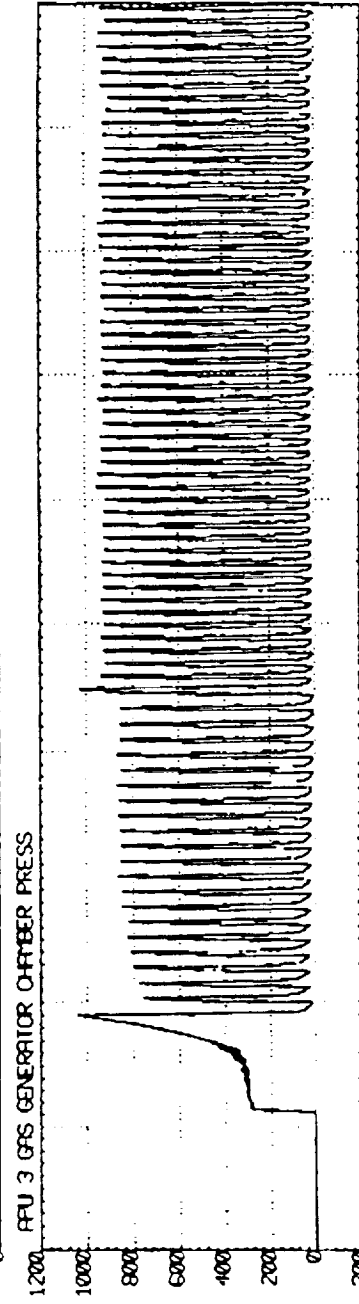

V46P03209A
(PSIA)

100:12:42:10.000
100:12:42:15.000
100:12:42:20.000
100:12:42:25.000
100:12:42:30.000
100:12:42:35.000
100:12:42:40.000
100:12:42:45.000
100:12:42:50.000
100:12:42:55.000
100:12:43:00.000
G M T

SUBSYSTEM: APU
STS-043

APU 1 CHAMBER PRESSURE VS TURBINE SPEED
APU 1 GAS GENERATOR CHAMBER PRESS

FORMAT: APU1GG-SPO
DATA: DESGPREZ

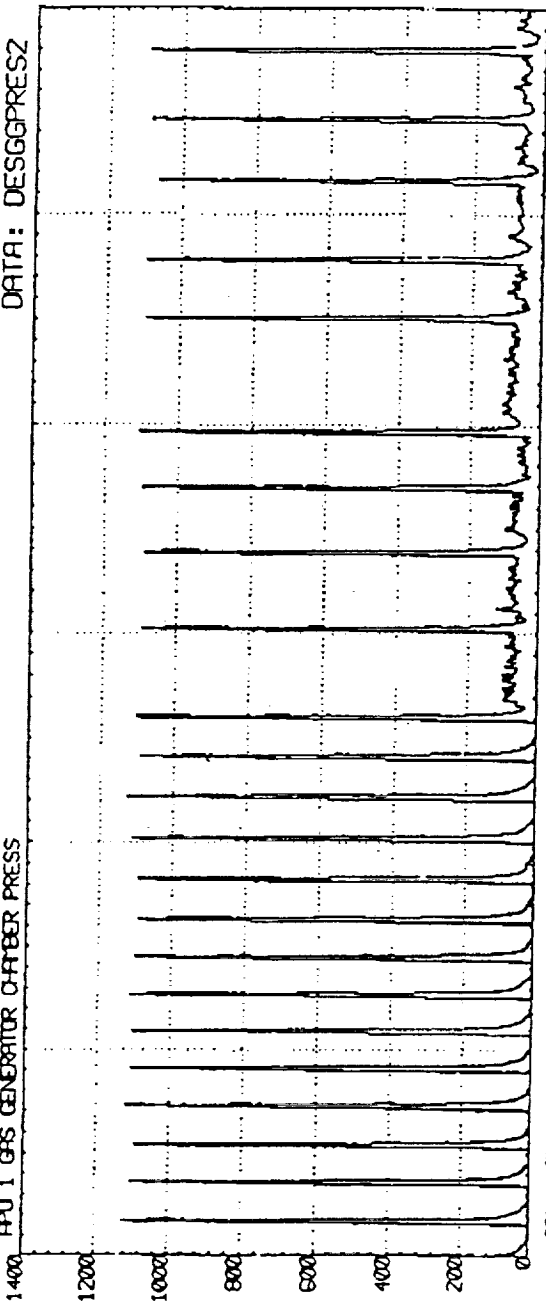

V46P0120A
(PSIA)

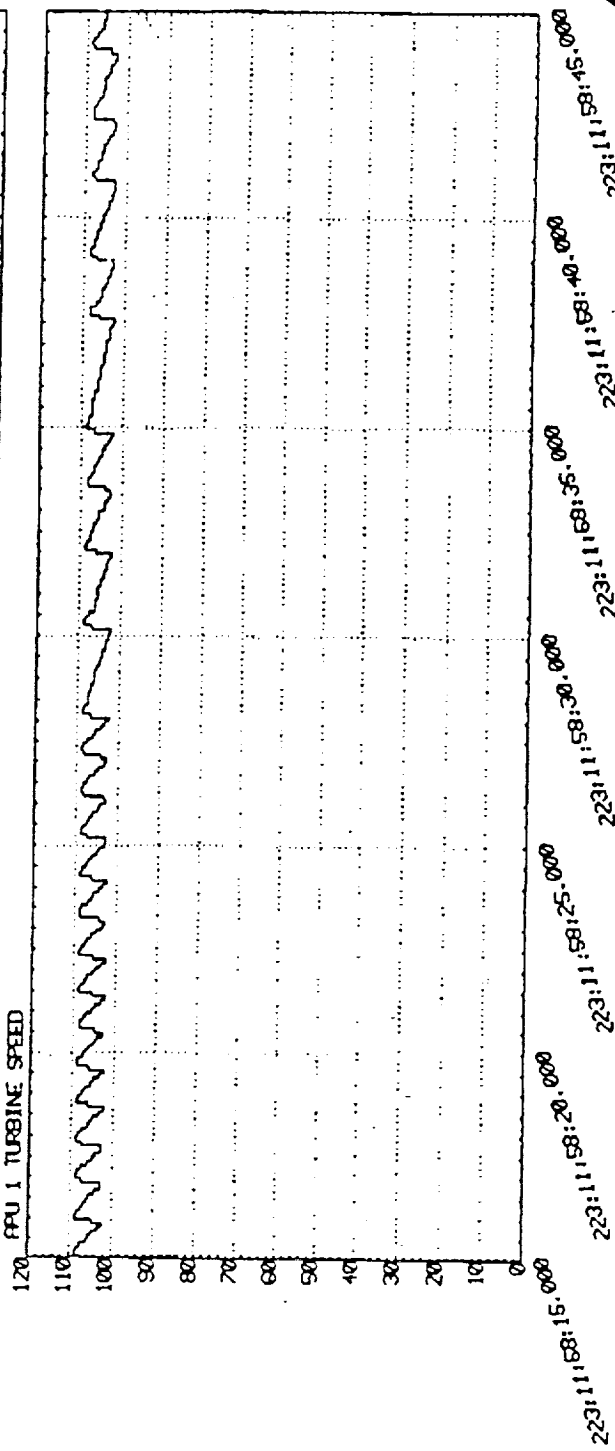

V46R0130A
(PCT)

VHM SENSOR DATA WITH CHANGING FREQUENCY AND ADDITIONAL GROUND NOISE

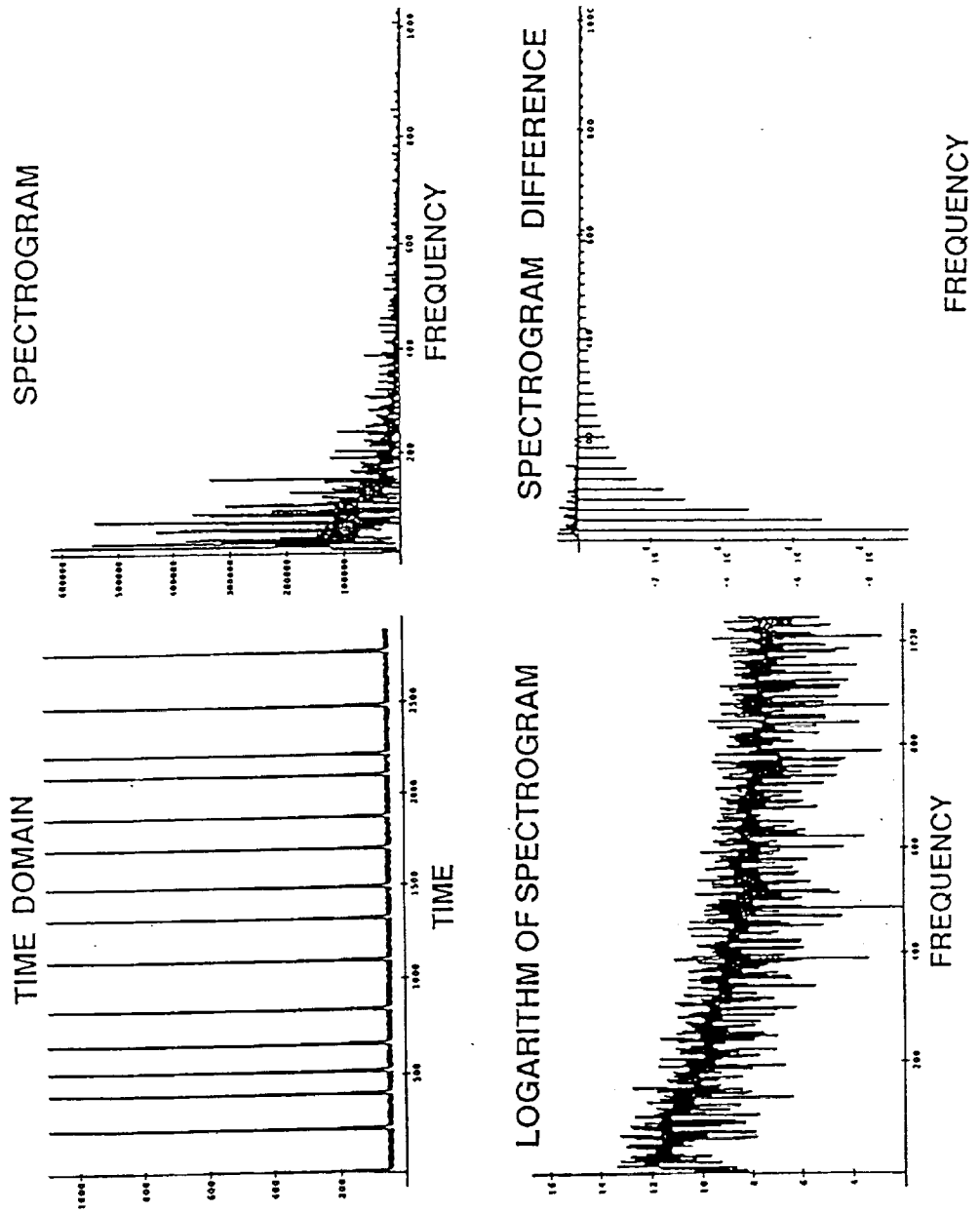

SAMPLED SPECTROGRAM DIFFERENCE

VHM SENSOR DATA WITH VARIATIONS IN FREQUENCY AND GROUND NOISE

POSITIVE SAMPLES

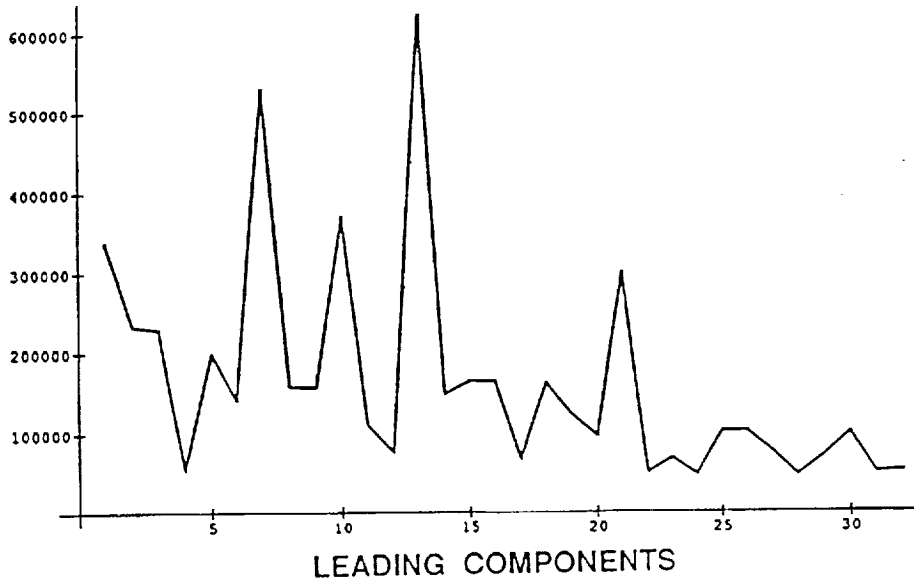

NEGATIVE SAMPLES

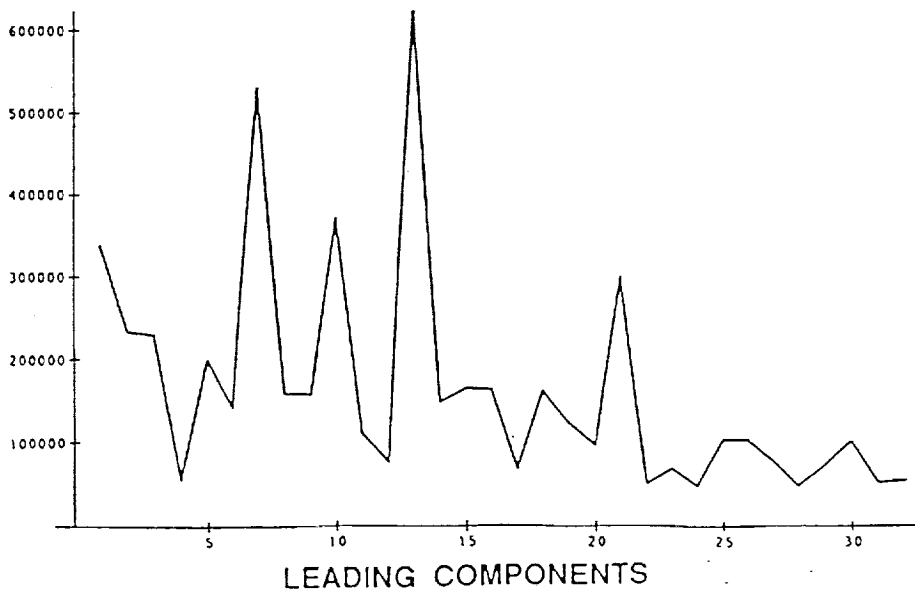

VHM SENSOR DATA WITH CHANGING FREQUENCY AND NOISE BUILDUP

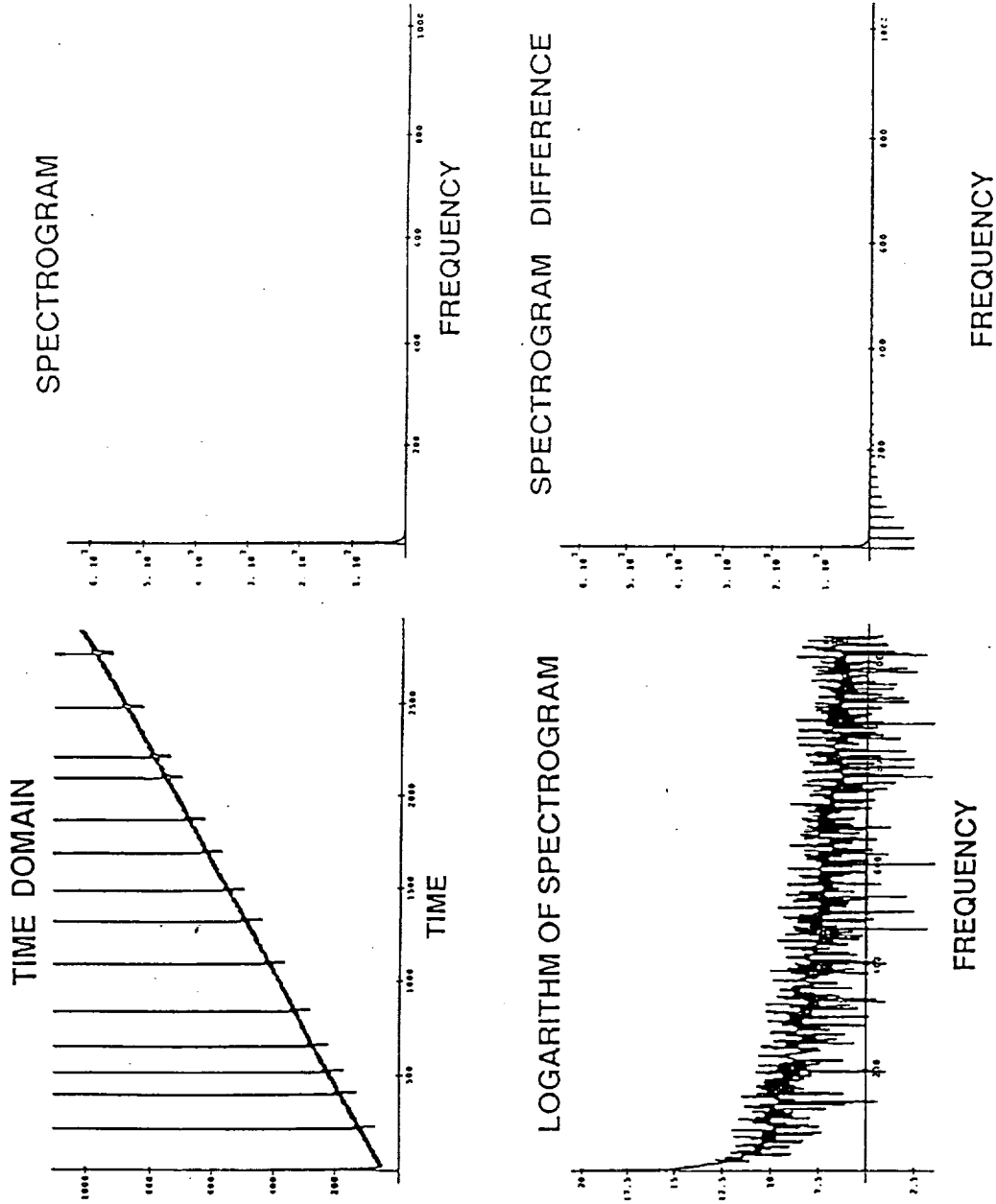

SAMPLED SPECTROGRAM DIFFERENCE

VHM SENSOR DATA WITH VARIATIONS IN FREQUENCY AND BUILDUP NOISE

POSITIVE SAMPLES

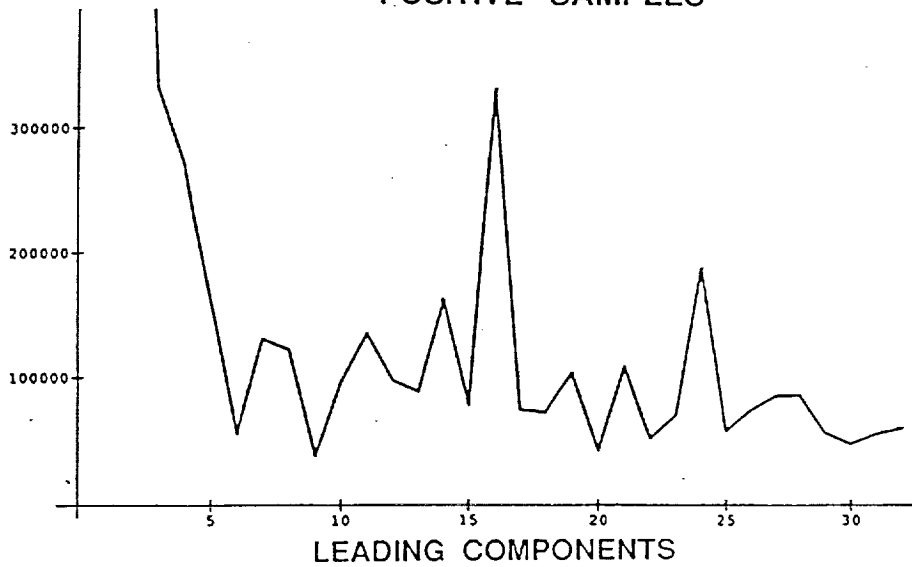

NEGATIVE SAMPLES

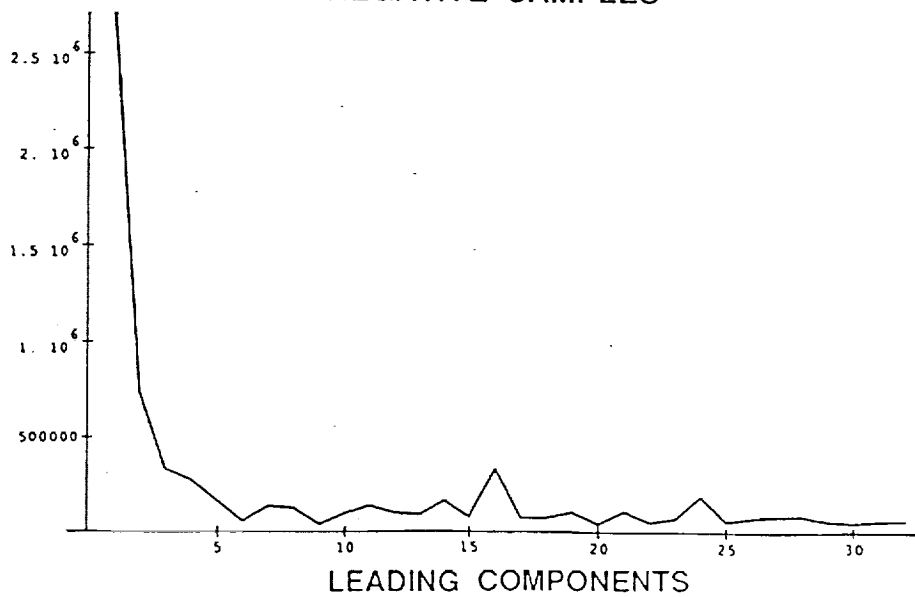

INTELLIGENT NEUROPROCESSORS FOR LAUNCH VEHICLE HEALTH MANAGEMENT SYSTEMS

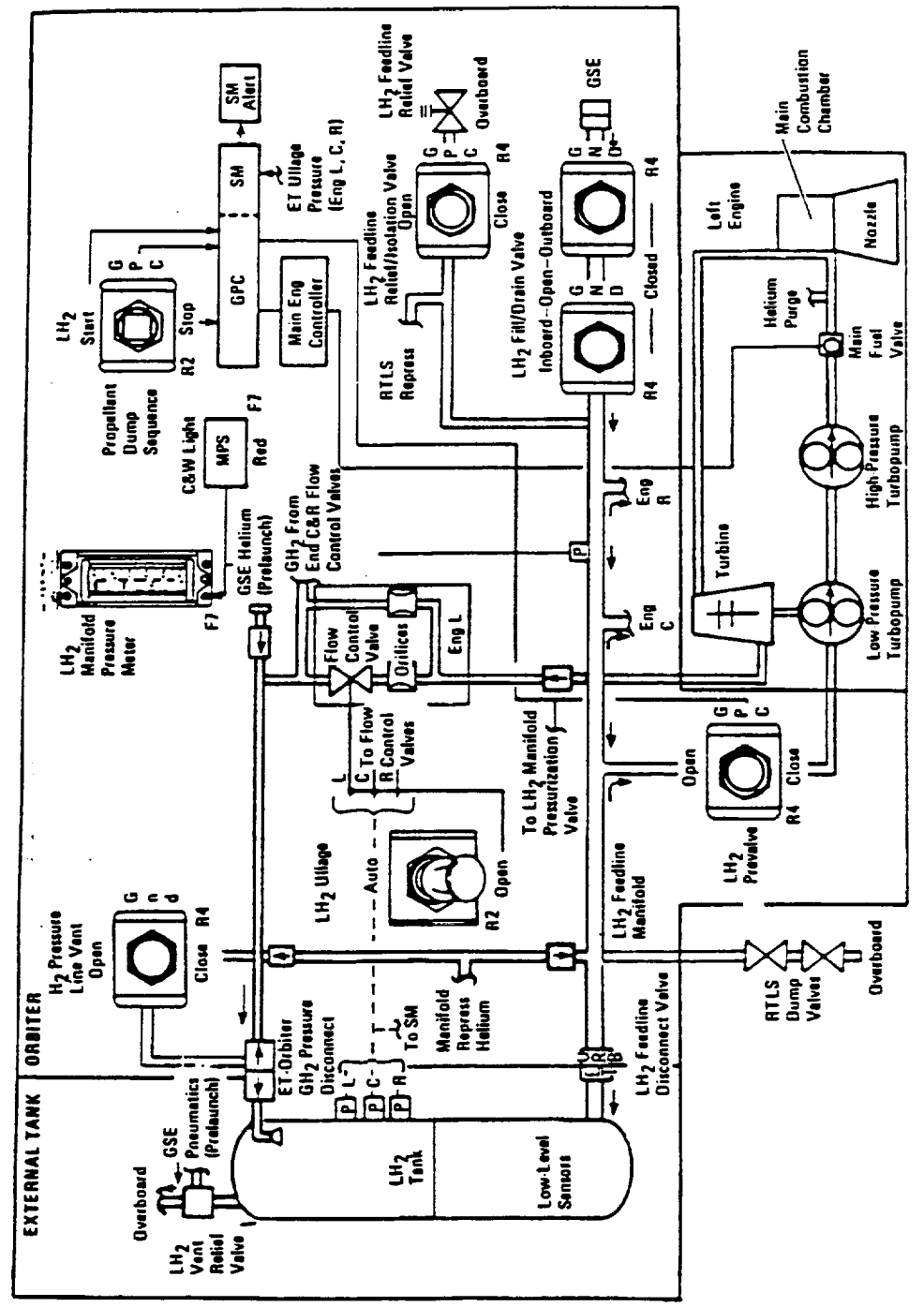

TARGET HMS - STS / MPS FUEL FLOW

INTELLIGENT NEUROPROCESSORS FOR LAUNCH VEHICLE HEALTH MANAGEMENT SYSTEMS

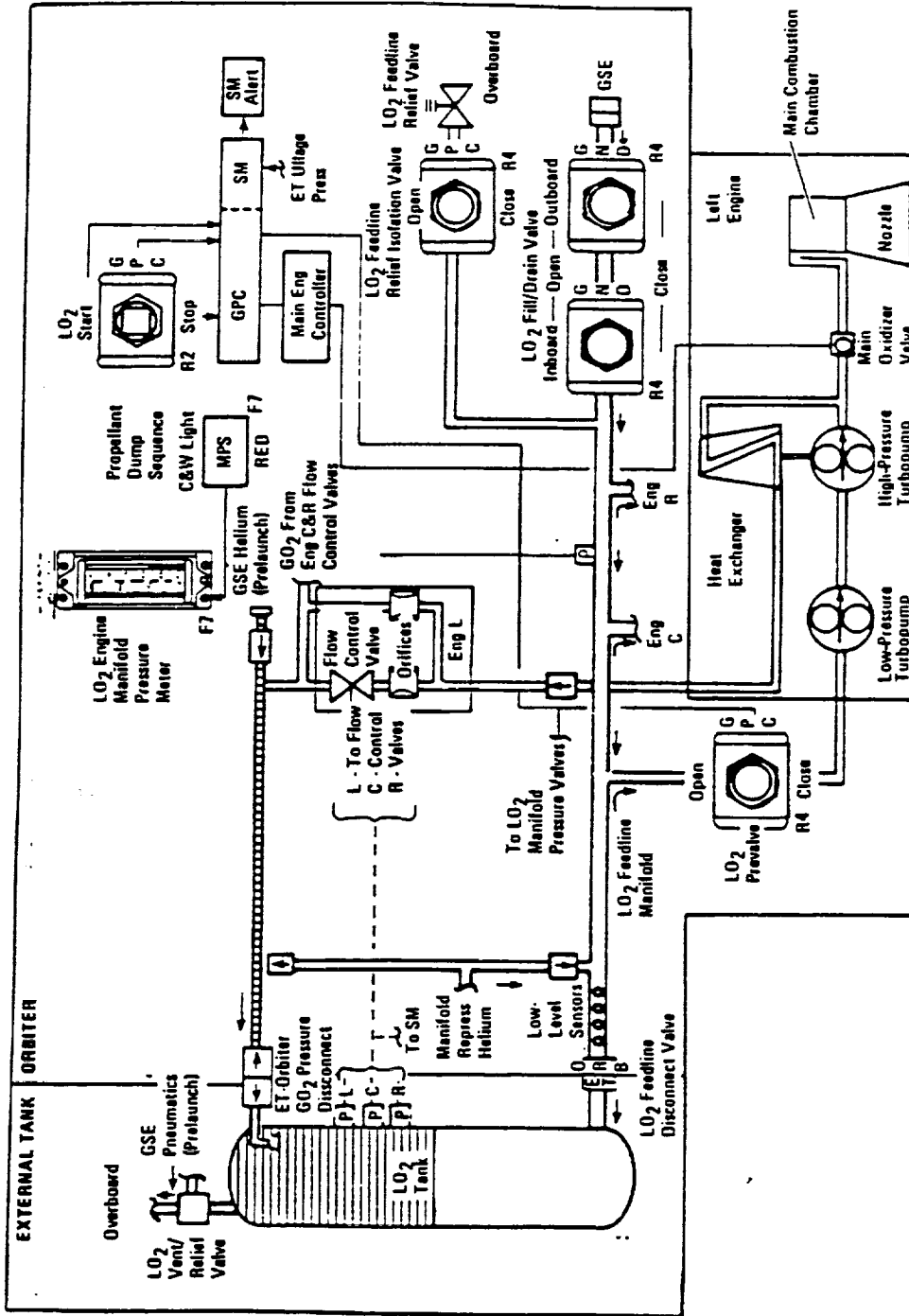

TARGET HMS - STS / MPS OXIDIZER FLOW