

1995122618



PERFORMANCE OF RESIN TRANSFER MOLDED MULTIAXIAL WARP KNIT COMPOSITES

510-24

H. Benson Dexter
NASA Langley Research Center
Hampton, Virginia

51293

Gregory H. Hasko
Lockheed Engineering and Sciences Co.
Hampton, Virginia

INTRODUCTION

Composite materials that are subjected to complex loads have traditionally been fabricated with multidirectionally oriented prepreg tape materials. Some of the problems associated with this type of construction include low delamination resistance, poor out-of-plane strength, and labor intensive fabrication processes. Textile reinforced composites with through-the-thickness reinforcement have the potential to solve some of these problems. Recently, a relatively new class of noncrimp fabrics designated as multi-axial warp knits have been developed to minimize some of the high cost and damage tolerance concerns. Multiple stacks of warp knit fabrics can be knitted or stitched together to reduce layup labor cost. The through-the-thickness reinforcement can provide significant improvements in damage tolerance and out-of-plane strength. Multilayer knitted/stitched preforms, in conjunction with resin transfer molding (RTM), offer potential for significant cost savings in fabrication of primary aircraft structures.

The objectives of this investigation were to conduct RTM processing studies and to characterize the mechanical behavior of composites reinforced with three multi-axial warp knit fabrics. The three fabrics investigated were produced by Hexcel and Milliken in the United States, and Saerbeck in Germany. Two resin systems, British Petroleum E905L and 3M PR 500, were characterized for RTM processing. The performance of Hexcel and Milliken quasi-isotropic knitted fabrics are compared to conventional prepreg tape laminates. The performance of the Saerbeck fabric is compared to uniweave wing skin layups being investigated by Douglas Aircraft Company in the NASA Advanced Composites Technology (ACT) program. Tests conducted include tension, open hole tension, compression, open hole compression, and compression after impact. The effects of fabric defects, such as misaligned fibers and gaps between tows, on material performance are also discussed. Estimated material and labor cost savings are projected for the Saerbeck fabric as compared to uniweave fabric currently being used by Douglas in the NASA ACT wing development program.

MULTIAXIAL WARP KNIT FABRIC

A schematic of a (0, 90, +45, -45) multiaxial warp knitted fabric is shown in figure 1. The knitting yarns are in the warp (0-degree) direction. The sketch indicates a chain knit to tie the four layers of carbon fabric together. Other types of knit, such as a tricot, can be used to tie the layers together. A tricot knit is normally used if 0-degree tows are on the surface of the fabric.

The potential benefits of multiaxial warp knitted fabrics are indicated in the figure. Significant cost savings are possible since layup time will be reduced compared to conventional unidirectional tape and biaxial broadgoods. Compared to woven broadgoods, the knitted fabric will have less crimp since the individual tows are not interlaced. Another benefit of multiaxial knitted fabric is reinforcement tailorability. In general, the off-axis ply orientations can range between 30 and 60 degrees. In addition, the tow size can be different for each ply of the fabric. Damage tolerance of the fabric can be controlled by the type and volume fraction of the knitting yarn. Polyester knitting yarn is generally used to hold 4-ply stacks together. However, Kevlar knitting yarn can be used to provide further improvements in damage tolerance.

MULTIAXIAL WARP KNIT FABRIC

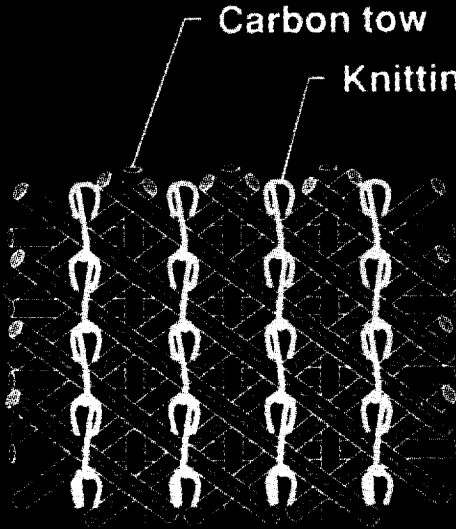

Carbon tow

Knitting yarn

(0, 90, +45, -45) fabric

Potential benefits

- Multidirectional/multilayer woven broadgoods replacement
- Minimum fiber crimp
- Tailorability
 - $0, 90, \pm \theta$
 - $30 \leq \theta \leq 60$
 - Ply areal weight
- Automated low-cost high throughput process
- Reduced layup/labor cost
- Improved damage tolerance

MULTIAXIAL KNITTED FABRICS EVALUATED

The multiaxial warp knitted fabrics evaluated in this investigation are described in figure 2. Fabrics were supplied by Hexcel, Saerbeck and Milliken. Seven fabrics from Hexcel with different tow sizes were evaluated. The results from the first Hexcel fabric listed in figure 2 with AS4-6K carbon fibers and polyester chain knit were reported on in reference 1 and will not be discussed here. The Hexcel fabrics with AS4 -3, -6, and -12K tows and a Kevlar chain knit were tested to evaluate the effects of tow size on mechanical properties and damage tolerance. The 3K, 6K, and 12K Hexcel fabrics had areal weights of 850, 1140, and 1695 g/m², respectively. The Hexcel fabric that had a mixture of 3, 6, and 12K T300 fibers was evaluated in a cooperative effort with Boeing. This fabric had 0-degree fibers on the surface and a polyester tricot knit, as previously mentioned, was used to tie the four layers of fabric together. This fabric had an areal weight of 760 g/m².

The German made Saerbeck fabric was evaluated in a cooperative effort with Douglas Aircraft Company. The Saerbeck fabric was knitted together with a polyester alternating tricot/chain knit. The Saerbeck fabric had a tailored areal weight to achieve a fabric with 44 percent of the fibers in the 0-degree direction, 44 percent of the fibers in the ± 45 -degree directions and 12 percent of the fibers in the 90-degree direction. This layup was selected to meet design requirements for the wing panels being developed by Douglas under the NASA Advanced Composites Technology (ACT) Program. The Saerbeck fabric had an areal weight of 1305 g/m².

The Milliken fabric consisted of 9K AS4 fibers in the ± 45 -degree directions and 12K fibers in the 0-degree and 90-degree directions and had an areal weight of 1730 g/m². This architecture was based on the Milliken machine set-up and was required to achieve a balanced weight quasi-isotropic layup.

MULTIAXIAL KNITTED FABRICS EVALUATED

Material Supplier	Fiber	Orientation	Knit Material (knit type)
		Tow size (K)	
Hexcel	AS4	(+45, 0, -45, 90) (← 6 →)	Polyester (chain)
Hexcel	AS4	(+45, 0, -45, 90) (← 3 →) (← 6 →) (← 12 →)	Kevlar 29 (chain)
Hexcel	AS4	(+45, 0, -45, 90) (← 3 →) (← 12 →)	Kevlar 29 (chain)
Hexcel (w/Boeing)	T300	(0, -45, 90, +45) (12 3 6 3)	Polyester (tricot)
Saerbeck* (w/Douglas)	AS4	(0, +45, 90, -45) (12 6 3 6)	Polyester (alternating tricot/chain)
Milliken	AS4	(-45, +45, 0, 90) (9 9 12 12)	Polyester (chain)

* Douglas ACT wing layup: 44% 0°, 44% $\pm 45^\circ$, 12% 90°

KNITTING CONCEPTS FOR MILLIKEN AND HEXCEL FABRICS

The knitting concepts for the Milliken and Hexcel fabrics are indicated in figure 3. The Milliken fabric is knitted on a Mayer multiaxial warp knitting machine that spaces the carbon fiber tows leaving gaps that allow the knitting needles to pass through the fabric without damaging the carbon tows. As indicated in the figure, a chain knit is used.

Hexcel fabrics were knitted with both chain and tricot knit styles, as shown in the figure. As indicated previously, the tricot knit is required to hold 0-degree tows on the surface of the fabric. The Hexcel fabric is knitted on a Liba multiaxial warp knitting machine that does not provide gaps for the knitting needles to pass through the fabric. As a result, the knitting needles impale and damage the carbon fiber tows as they pass through the fabric. Fiber misalignment is caused by the needle penetration and lack of tension on the carbon tows. The tradeoff in the two knitting methods is between fiber damage and misalignment and fiber volume fraction. The Mayer machine produces a fabric with less fiber damage but has a lower as-fabricated fiber volume fraction. Fiber volume fractions of over 60 percent have been achieved with the Milliken fabric but a consolidation pressure of well over 100 psi is required to spread the fibers and close the gaps between the carbon tows.

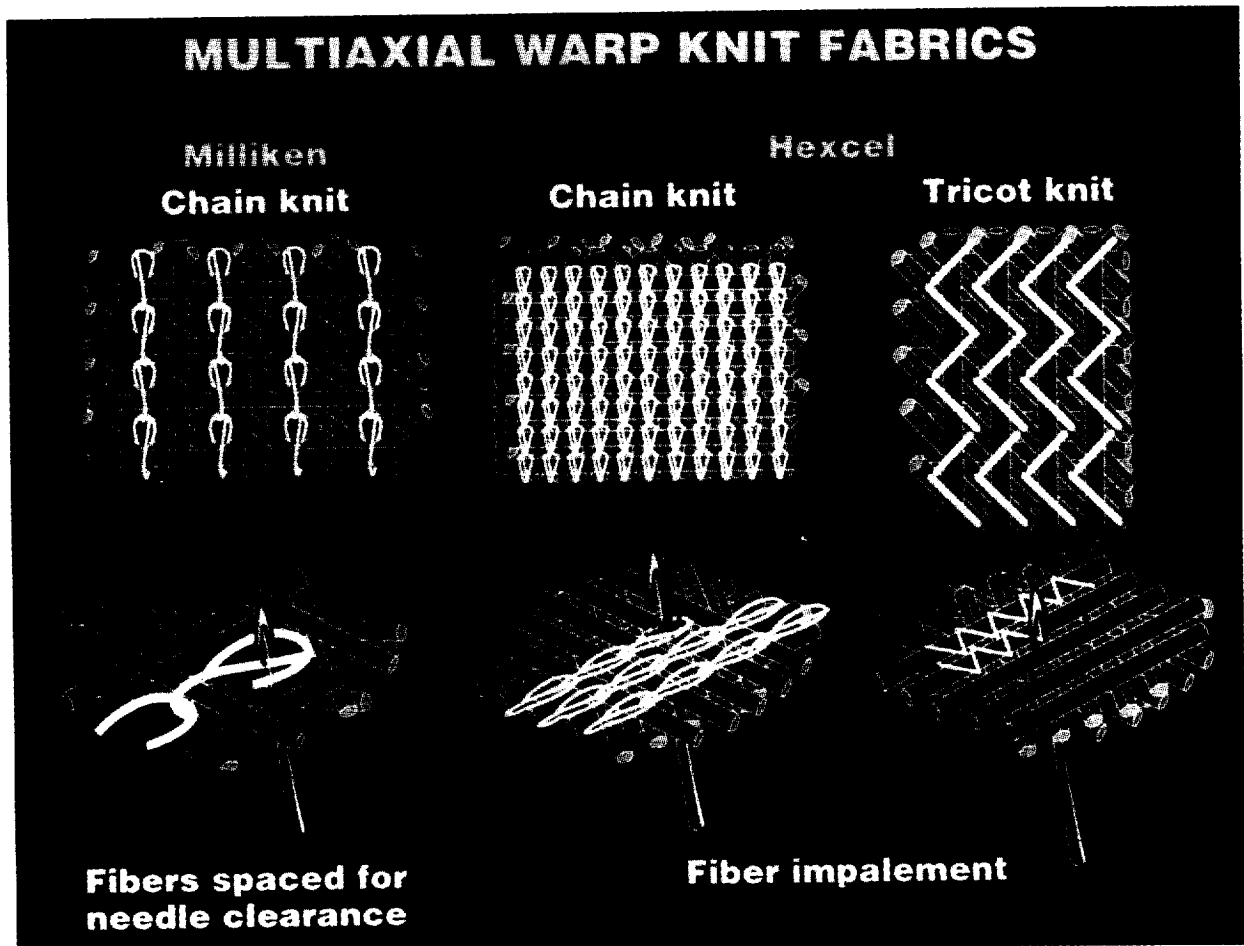

PHOTOGRAPHS OF KNITTED FABRICS

Photographs of the Hexcel, Milliken, and Saerbeck knitted fabrics are shown in figure 4. The Hexcel (+45, 0, -45, 90) chain knitted fabric shown in the upper left of the figure indicates significant gaps and fiber misalignment in the surface tows. Also, some fiber damage can be seen where the knitting yarns penetrate through the fabric. The Milliken (-45, +45, 0, 90) chain knitted fabric shown in the upper right of the figure indicates uniform gaps and minimal misalignment.

The Hexcel (0, -45, 90, +45) tricot knitted fabric has significant gaps between the 0-degree surface tows, whereas the Saerbeck (0, +45, 90, -45) fabric photograph indicates only small gaps between the 0-degree surface tows. However, some slight fiber waviness is evident in the Saerbeck fabric. The gaps in all the fabrics are potential sites for resin pockets to form during the resin transfer molding process. These resin pockets can contribute to the formation of microcracks in the cured composite.

MULTIAXIAL WARP KNIT FABRICS

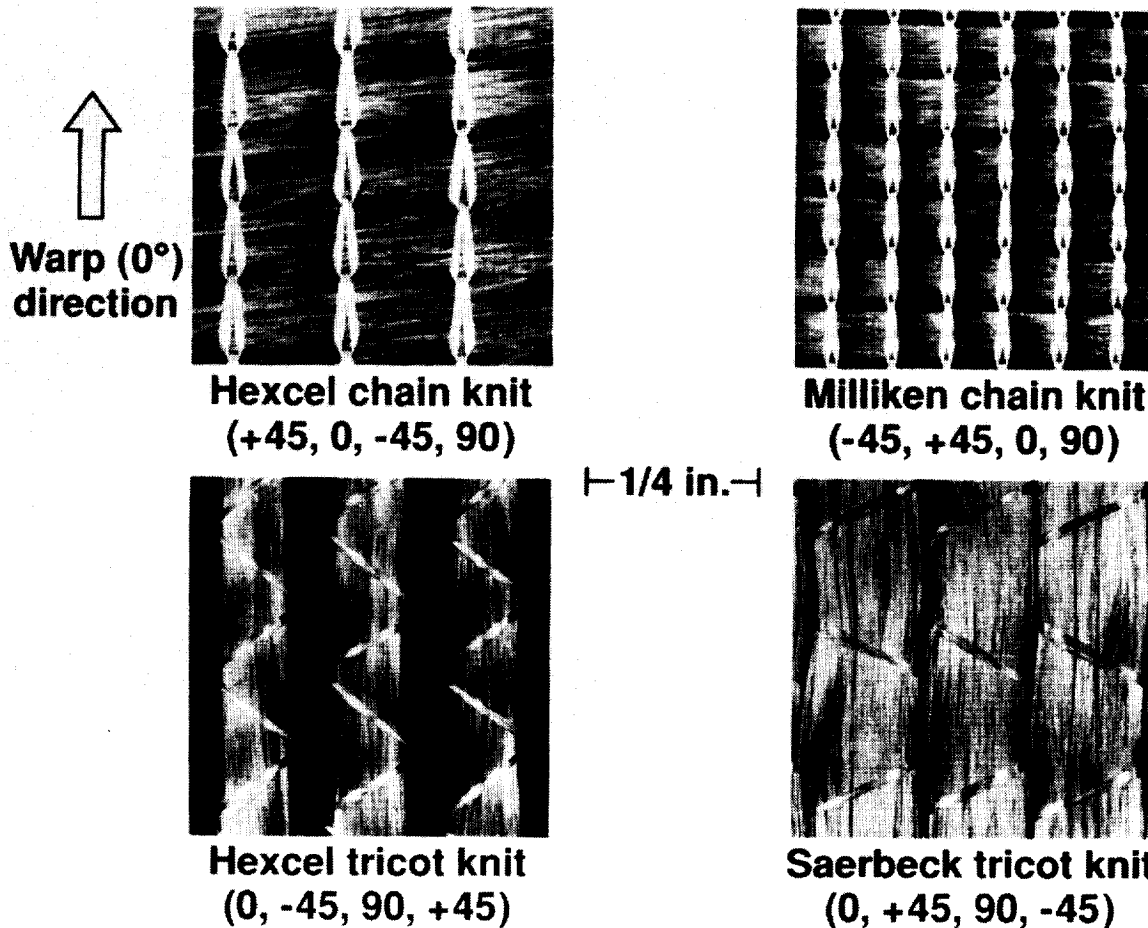

HEXCEL MULTIAXIAL WARP KNITTING MACHINE

The multiaxial warp knit fabrics obtained from Hexcel and Saerbeck were fabricated on machines that were developed by Liba, a German-owned company. The Hexcel machine shown in figure 5 can produce up to an 8-ply fabric with ply orientations of $(0, 90, \pm \theta)$, with θ ranging from 30 to 90 degrees. The machine can produce fabric up to 100-inches wide at a rate of 50 lineal yards/hour. Yarn carriers with multiple tows traverse the fabric width and place the tows around pins that are attached to a moving belt. The tow size and the number of tows per inch determine the fabric areal weight. Different tow sizes can be used in each direction if desired. The sketch in figure 5 shows that the 90- and ± 45 -degree tows are laid down by the yarn carriers moving along fixed guides. The 0-degree tows are laid down off a beam just prior to the 4-ply stack being knitted together. Either a chain or a tricot stitch can be used to knit the fabric plies together.

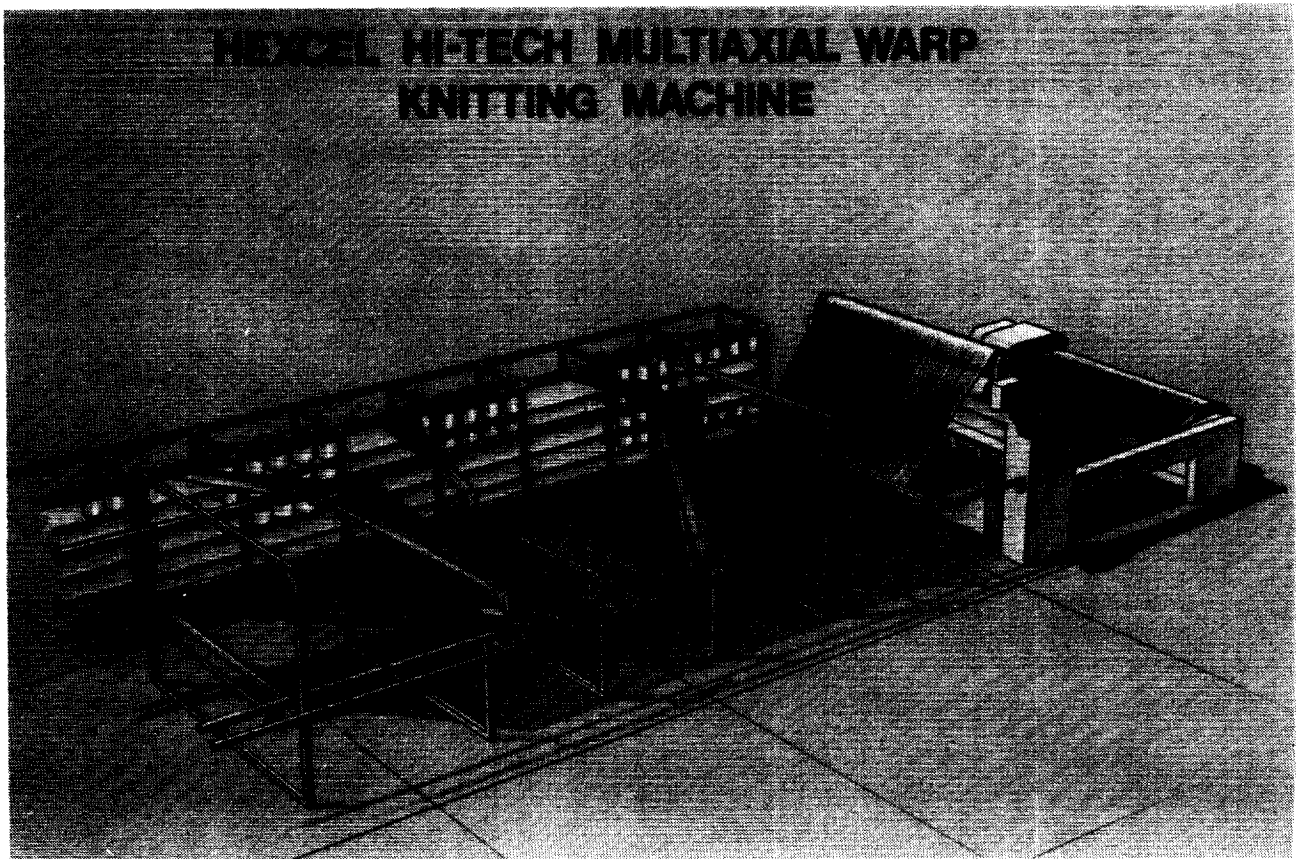

MILLIKEN MULTIAXIAL WARP KNITTING MACHINE

The multiaxial warp knit fabric obtained from Milliken was fabricated on a machine manufactured by the Mayer Textile Machine Corporation in Germany, figure 6. This machine can produce a 4-ply fabric with ply orientations of $(0, 90, \pm\theta)$, with θ ranging from 30 to 60 degrees. Fabrics with $(0, 90)$, $(90, \pm\theta)$, and $(\pm\theta)$ fiber orientations can also be produced. The Milliken machine can produce fabrics up to 62 inches wide at a rate of 50 lineal yards/hour. For the fibers used in this investigation, the machine was operated at a speed of approximately 30 yards/hour to minimize damage to the carbon tows. The tow count for this fabric was 12 tows/inch in the warp direction and 17 tows/inch in the ± 45 -degree directions. A chain knit was used to knit the $(-45, +45, 0, 90)$ plies together.

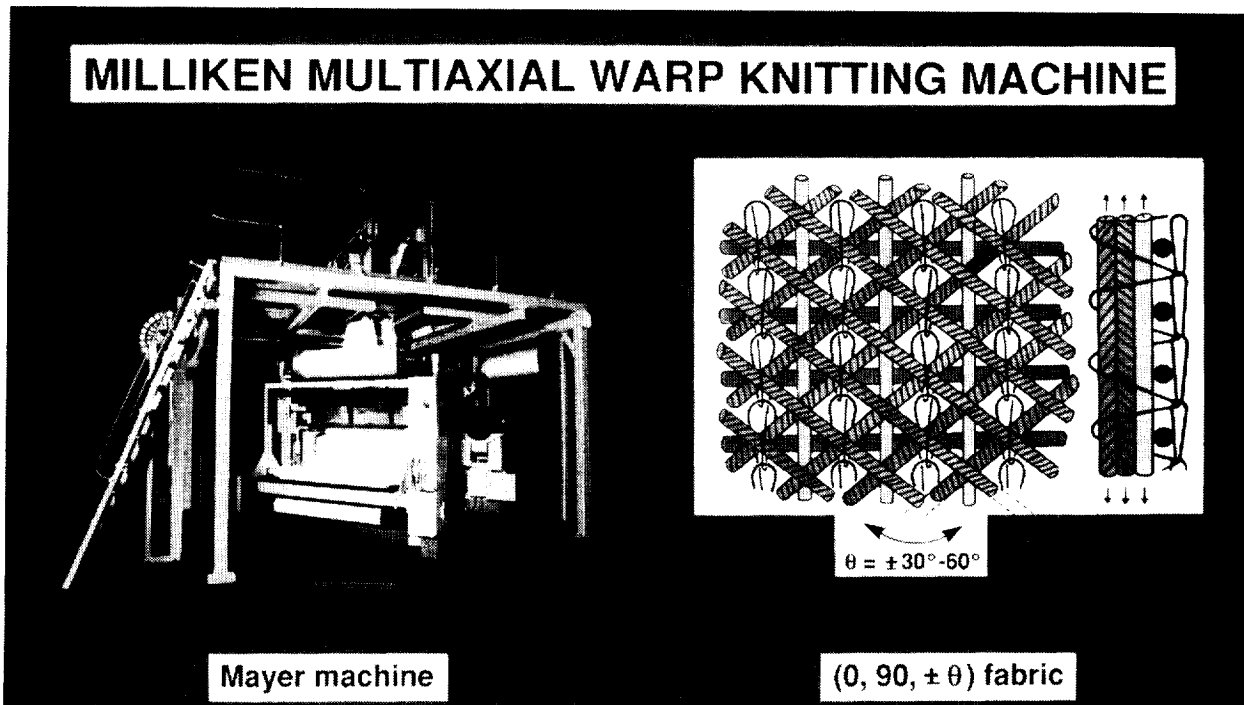

RTM RESINS EVALUATED

The five different resins evaluated for resin transfer molding the knitted fabrics are indicated in figure 7. The three one component epoxy resins, Hercules 3501-6, 3M PR 500, and Dow CET-3 were characterized for use in a vacuum infusion process, with a primary goal of establishing a suitable processing window for each of the resins. The 3501-6 resin melts during a ramp up to 245°F at which time a minimum viscosity of approximately 500 cps is achieved. The 3M PR 500 resin has a minimum viscosity of approximately 30 cps at 320°F. The Dow CET-3 epoxy-thermoplastic resin has a minimum viscosity of approximately 60 cps at 350°F.

The two component resins shown in figure 7 and evaluated in this study included British Petroleum E905L and Shell 1895. These resins were used in a pressure injection process. The E905L resin is heated to 200°F to achieve a minimum viscosity of approximately 100 cps. The Shell 1895 resin is heated to 250°F to achieve a minimum viscosity of approximately 10 cps. In this process the resin is pumped into the mold, the air is evacuated, the vent ports are closed, and the mold is closed to predetermined stops to set the final thickness of the panel.

RTM RESINS EVALUATED

- **Hercules 3501-6** - one component semi-solid epoxy at room temperature (vacuum infusion)
- **3M PR 500** - one component paste epoxy at room temperature (vacuum infusion)
- **Dow CET-3** - one component semi-solid crosslinkable epoxy thermoplastic at room temperature (vacuum infusion)
- **British Petroleum E905L** - two component liquid epoxy at room temperature (pressure injection)
- **Shell 1895** - two component liquid epoxy at room temperature (pressure injection)

EFFECTS OF MOISTURE AND TEMPERATURE ON RTM COMPOSITES

As part of the resin characterization study, the effects of moisture and temperature were investigated. To minimize data scatter, a well characterized state-of-the-art IM7 eight harness satin woven fabric was selected. Quasi-isotropic compression specimens were soaked in 160°F water for 45 days and tested at 180°F. The five resins discussed in figure 7 were tested in the as-fabricated condition and after the 45-day hot-wet exposure. The test results shown in figure 8 indicate that the composite with Shell 1895 resin had the best strength retention, about 90 percent, however, it had the lowest as-fabricated strength, about 65 ksi. The composite with BP E905L resin had a strength retention of about 82 percent and an as-fabricated strength of about 80 ksi, the highest of the systems tested. The composites with 3M PR 500 and the Hercules 3501-6 resins performed similarly to the BP E905L resin with the 3M PR 500 resin having a slightly lower strength retention of about 77 percent. The composite with Dow CET-3 resin had the lowest strength retention, about 75 percent, compared to the other four resins. Based on these results, availability of resins, and state of resin characterization, the BP E905L and the 3M PR500 resins were selected for the knitted fabrics evaluation. The BP E905L knitted fabric panels were processed at Boeing and the 3M PR500 knitted fabric panels were fabricated at NASA Langley.

EFFECTS OF MOISTURE AND TEMPERATURE ON RTM COMPOSITES

45-day water soak at 160° F, tested at 180° F

IM7 8HS Satin fabric, quasi-isotropic layup

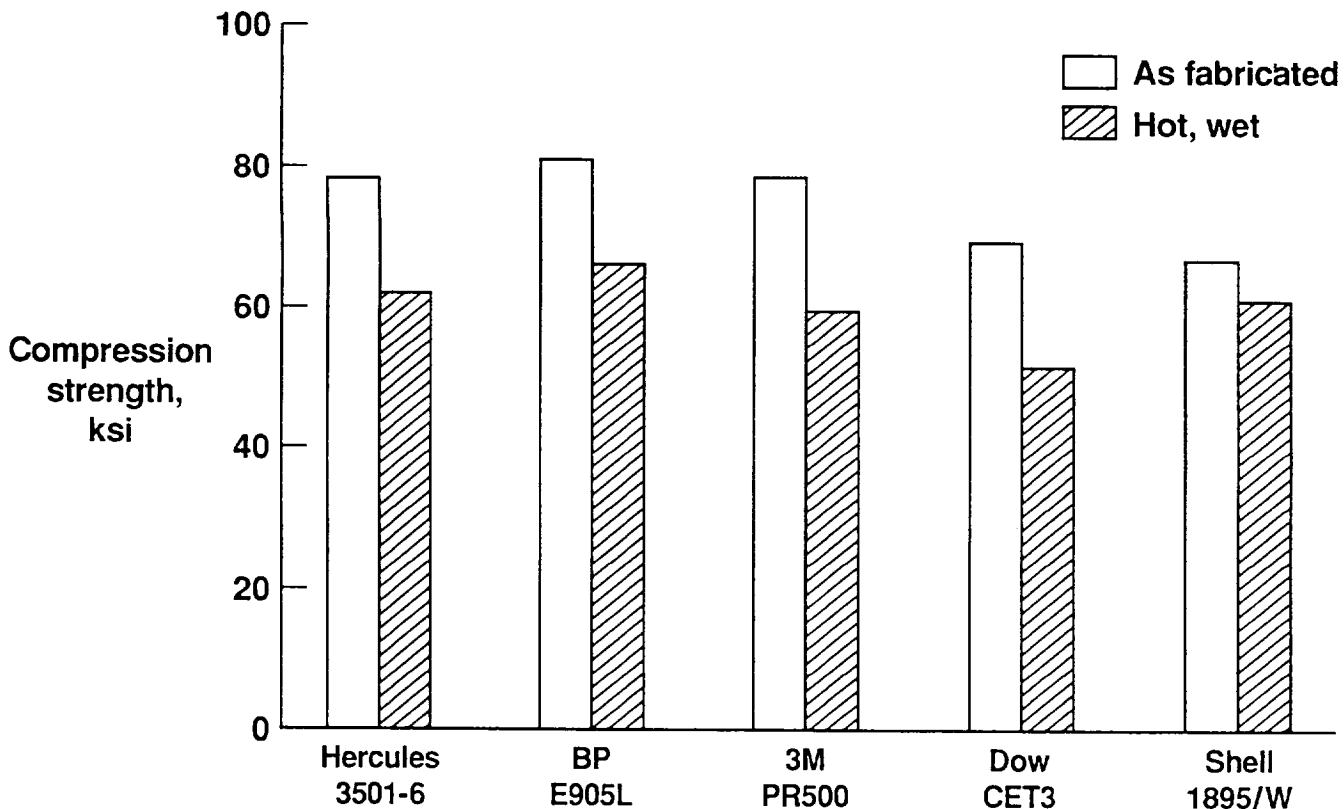

RESIN TRANSFER MOLDING METHODS

Two resin transfer molding methods were used to fabricate composite test panels for this investigation. The vacuum infusion method shown in figure 9 is similar to the process developed by Douglas Aircraft Company for fabrication of wing panels. The 3M PR 500 knitted panels were fabricated with the vacuum infusion method at NASA Langley in a vacuum press. The first step involves degassing the resin in a vacuum to remove any entrapped air. The second step consists of pouring the resin in the bottom of the picture frame tool in a predetermined amount to achieve the desired volume fraction. The knitted fabric is carefully trimmed to fit the 12-inch by 12-inch mold cavity and placed in the mold so that all edges have a tight press fit. This insures that there are no gaps for resin to escape around the fabric. A breather layer of porous Teflon-coated fiberglass is placed over the fabric to allow air to escape and to prevent excessive resin bleed. The upper caul plate is placed on top of the preform and the assembly is placed in a hydraulic press for resin infusion and curing. The required pressure is based upon compaction measurements conducted to establish volume fraction as a function of applied load on dry knitted fabric preforms. For the panels fabricated in this investigation, the fiber volume fractions were nominally 58 percent.

The pressure injection molding process shown in figure 9 was developed by Boeing Aerospace under contract to NASA Langley, and was used to mold the BP E905L knitted panels. This process involves resin flow in the plane of the fabric. As indicated in the figure, an O-ring is used to seal the mold to prevent resin leakage and air entrainment. The mold assembly is placed between two platens in a hydraulic press to close the mold and apply sufficient pressure to debulk the fabric and seat the O-ring. The mold cavity depth is sized to achieve a prescribed fabric thickness and fiber volume fraction. Resin enters the mold from a pressure pot and fills a channel around the perimeter of the fabric. Resin flows radially inward through the fabric to an exit port located in the center of the mold. A vacuum pump is attached to the exit port to remove excess air. Once the fabric preform is fully saturated and all the air is evacuated, the exit valve is closed and the prescribed cure cycle is followed. For the panels fabricated in this investigation, the fiber volume fractions were nominally 62 percent.

RESIN TRANSFER MOLDING METHODS

Vacuum Infusion

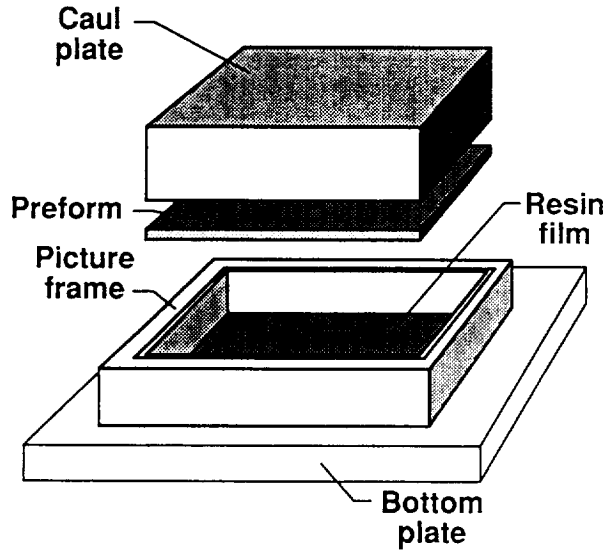

Pressure Injection

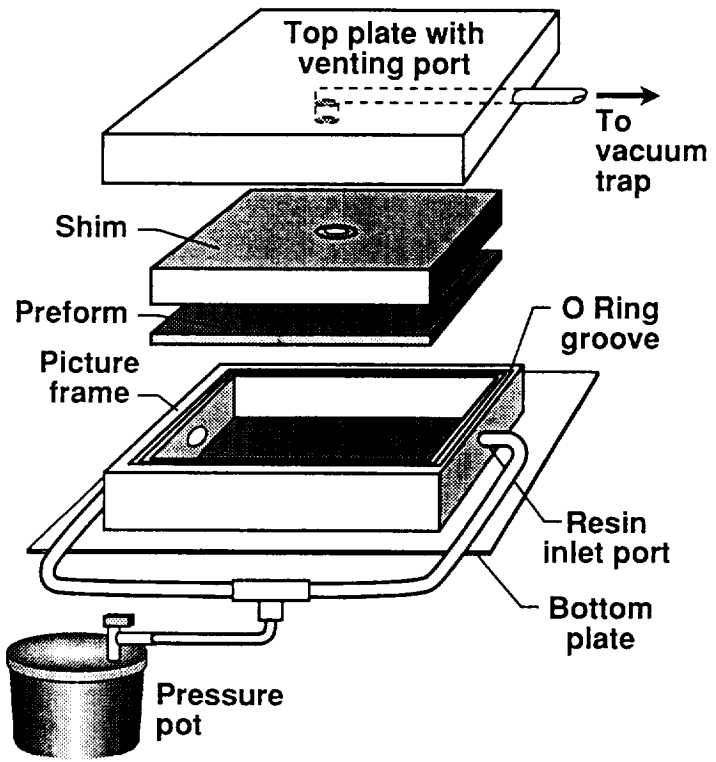

COMPACTION AND PERMEABILITY BEHAVIOR OF HEXCEL MULTIAXIAL WARP KNIT FABRIC

Compaction and permeability characteristics of the knitted fabrics were used as aids in developing infiltration and cure cycles. Compaction experiments were conducted to establish relationships between fiber volume fraction and compaction pressure. Test results for the 12K Hexcel knitted fabric are shown in figure 10. The results indicate that a pressure of approximately 50 psi is required to achieve a fiber volume fraction of 60 percent.

Also shown in figure 10 is the effect of fiber volume fraction on permeability. Permeability is a function of fabric architecture, compaction, porosity, and direction of resin flow. Test results are again presented for the 12K Hexcel knitted fabric. Note that for a given fiber volume fraction, the permeability for in-plane flow is much higher than for out-of-plane flow. These results indicate that flow along the in-plane fibers is much easier than flow through-the-thickness of the preform or across the fiber bundles. Results of other experiments indicate that through-the-thickness stitching can enhance out-of-plane flow, however, stitching may also inhibit resin flow in the plane of the fabric.

COMPACTION AND PERMEABILITY BEHAVIOR OF HEXCEL MULTIAXIAL WARP KNIT FABRIC

12K tows

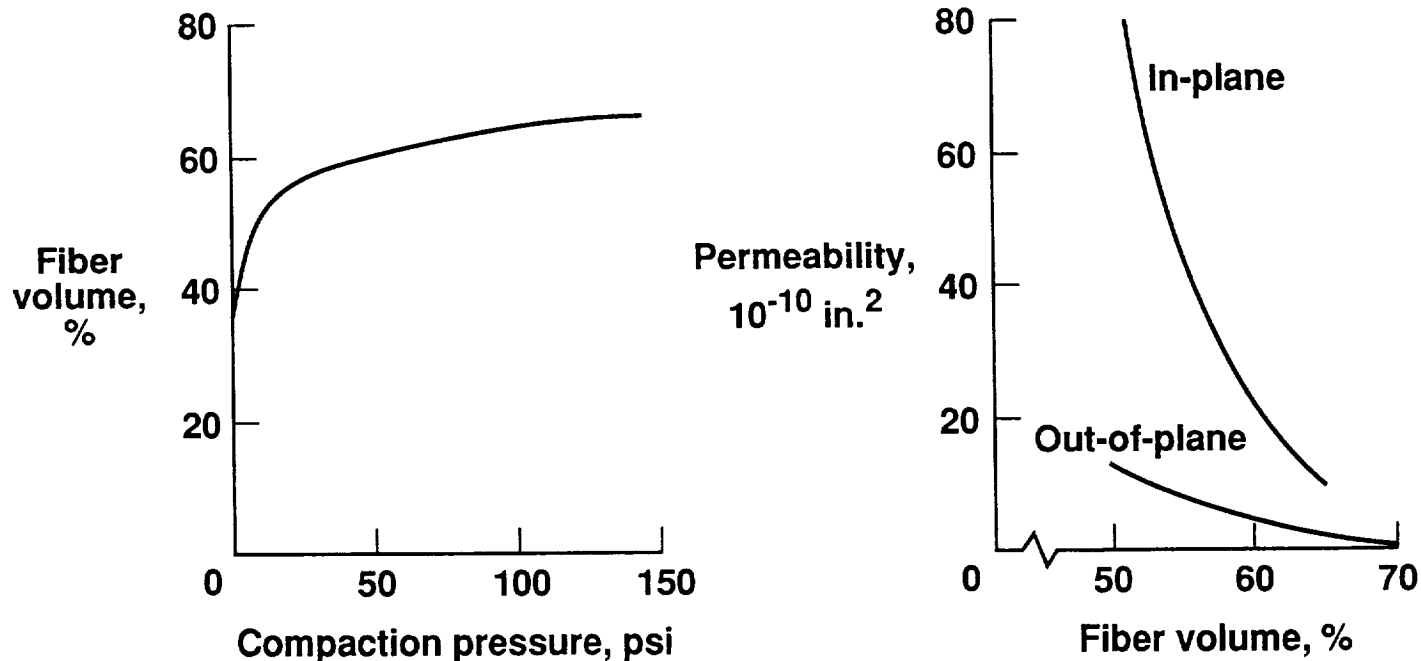

PHOTOMICROGRAPHS OF QUASI-ISOTROPIC LAMINATES

Cross-section photomicrographs of the Hexcel and Milliken knitted fabric composite laminates are shown in figure 11. For comparison purposes, a photomicrograph of a prepreg tape laminate is also shown. The Hexcel chain knitted laminate exhibited more out-of plane fiber crimp than would be expected for knitted fabrics. This can be explained by examining the photographs of the dry fabrics shown in figure 4, where significant gaps between tows of the Hexcel fabric was seen. Close examination of the Hexcel composite laminates indicated that the gaps in the fabric allowed adjacent tows to displace out-of-plane and fill the gaps during panel consolidation. As noted in figure 4, large gaps between the 0-degree surface tows were also evident for the Hexcel tricot knitted fabric. These gaps allow significant undulation in carbon fiber tows in adjacent plies, as shown in the figure.

As previously indicated in figure 4, the Milliken fabric had uniform gaps between all the tows to allow the knitting needles to pass through the fabric without damaging the carbon fibers. These gaps lead to numerous resin pockets in the composite laminate as shown in figure 11. However, these gaps do not appear to contribute to significant fiber undulations as were seen in the Hexcel laminates. Compared to the prepreg tape laminates, all the knitted fabrics have larger resin pockets and more fiber distortion.

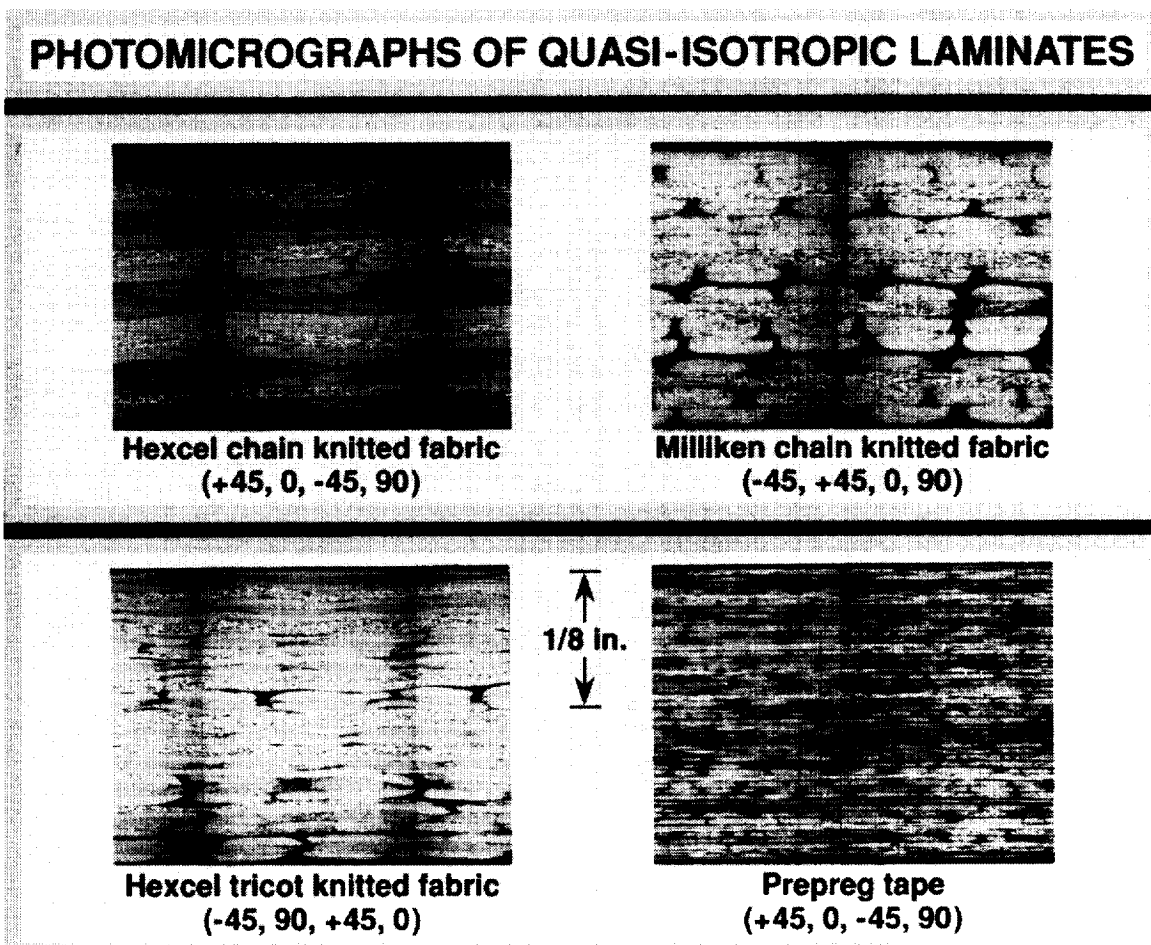

PHOTOMICROGRAPHS OF DOUGLAS WING SKIN LAYUP

Cross-section photomicrographs of uniweave, Saerbeck knitted, and Saerbeck knitted/stitched composite laminates are shown in figure 12. The uniweave fabric is the baseline fabric selected for the Douglas wing skin layup. The wing skin has a layup that consists of 44 percent 0-degree fibers, 44 percent ± 45 -degree fibers and 12 percent 90-degree fibers. The Saerbeck fabric is a potential alternate to the uniweave fabric. The Saerbeck fabric was knitted in a 4-ply stack to have the same areal weight (1305 g/m^2) as a 9-ply stack of the uniweave fabric. Fifty-four plies of uniweave fabric are required to fabricate the wing skin layup, whereas only six 4-ply stacks are required with the Saerbeck knitted fabric. To achieve the desired damage tolerance for the wing skin, through-the-thickness stitching with 1500 denier Kevlar thread is being investigated.

The photomicrographs shown in figure 12 indicate good fiber compaction. Some resin pockets are evident in the Saerbeck fabric laminate, however, the in-plane fibers have less undulation compared to the Hexcel fabric discussed in figure 11. The Saerbeck stitched fabric laminate shown in the lower part of figure 12 was infused with 3M PR 500 resin and no microcracks are evident around the Kevlar stitches. This resin has also been shown to be microcrack resistant in other stitched fabrics.

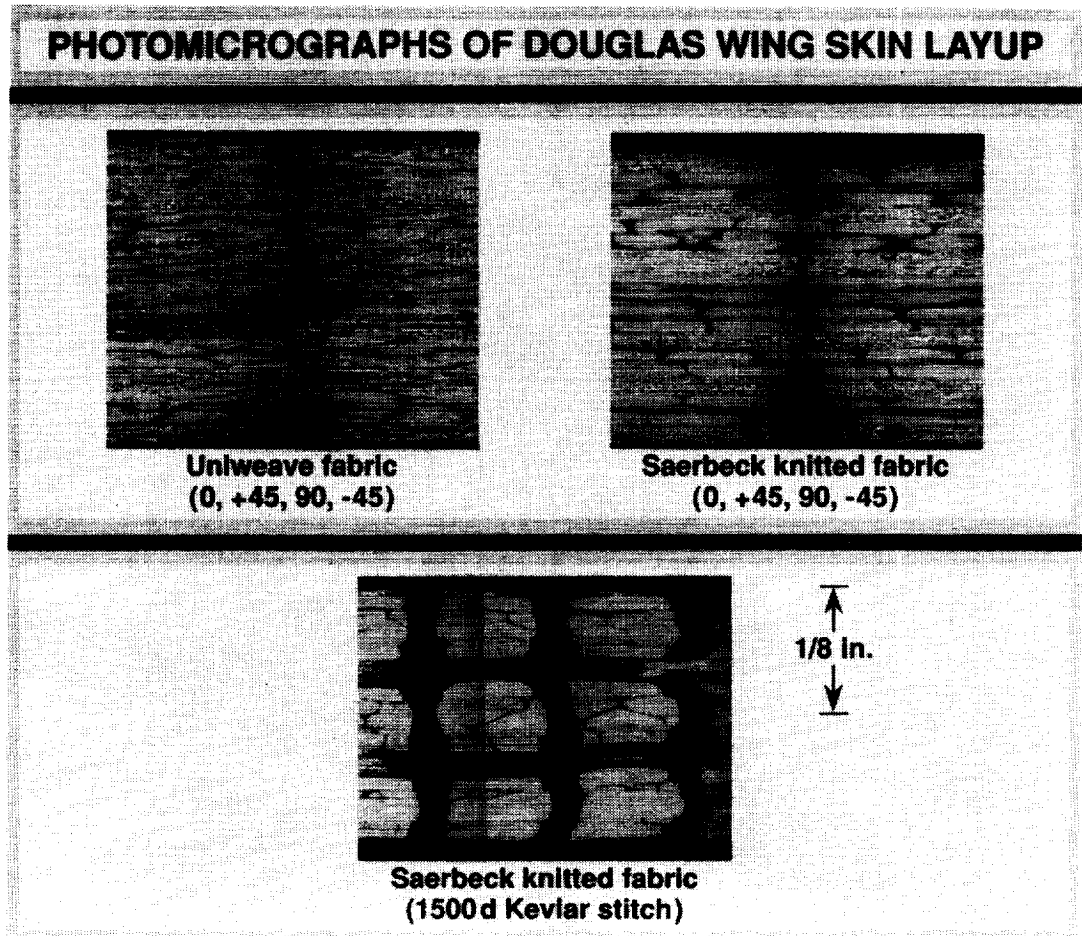

TEST SPECIMENS

The test specimens used in the NASA Langley in-house test program are shown in figure 13. The Hexcel and Milliken knitted fabric specimens have a nominal thickness of 0.25-inch whereas the Saerbeck knitted specimens have a nominal thickness of 0.30-inch. Specimen lengths and widths are indicated in the figure. The compression and tension specimens were instrumented with 0.125-inch long stacked strain gages, and the compression after impact, open hole tension, and open hole compression specimens were instrumented with 0.250-inch long axial strain gages. The compression after impact specimens were impacted at a nominal impact energy of 30 ft-lbs with the NASA Langley air gun using a 0.500-inch diameter aluminum sphere as the impactor. A 0.250-inch diameter hole was drilled in the center of the open hole tension and open hole compression specimens. Most of the tension specimens were tested without loading tabs, however, fiberglass tabs were required for the specimens fabricated with the Douglas wing lay-up. The test apparatus and loading rates described in reference 1 were also used in this investigation.

TEST SPECIMENS

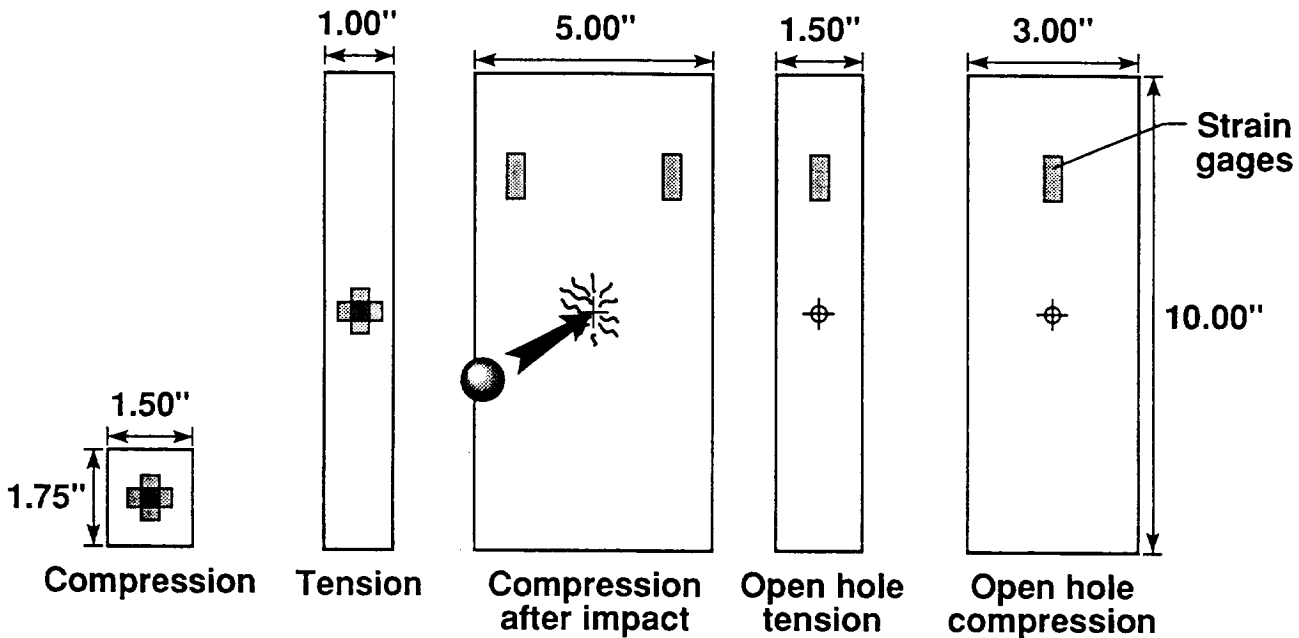

COMPRESSION STRENGTH VARIABILITY FOR MULTIAXIAL WARP KNIT COMPOSITES

Excessive data scatter was evident for the Hexcel knitted fabric laminates early in the mechanical property test program. Fabrication and testing continued and additional fabric was ordered with the expectation that a higher quality fabric could be produced. Compression strength results for 135 tests from 17 panels fabricated with both E905L and PR 500 resin systems are plotted in figure 14 for Hexcel, Milliken, and Saerbeck knitted fabrics. The results indicate excessive strength scatter in the Hexcel fabric panels, especially in the 3K panels. Compression strengths ranging from 48 ksi to 85 ksi were achieved. The Milliken laminates, in particular the panel with 8 replicates, also indicated excessive strength scatter. Although only two Saerbeck knitted fabric panels were tested, the strength scatter is much less. It should be noted that the Saerbeck fabric has the highest strength because it has a higher percentage of 0-degree fibers compared to the Hexcel and Milliken fabrics.

These results indicate that additional process controls must be instituted to achieve higher quality knitted fabrics. The Saerbeck machine, which was also produced by Liba in Germany, is a third generation machine compared to the Hexcel machine, and improved tension control mechanisms could possibly account for the reduced compression strength scatter for the Saerbeck fabric.

COMPRESSION STRENGTH VARIABILITY FOR MULTIAXIAL WARP KNIT COMPOSITES

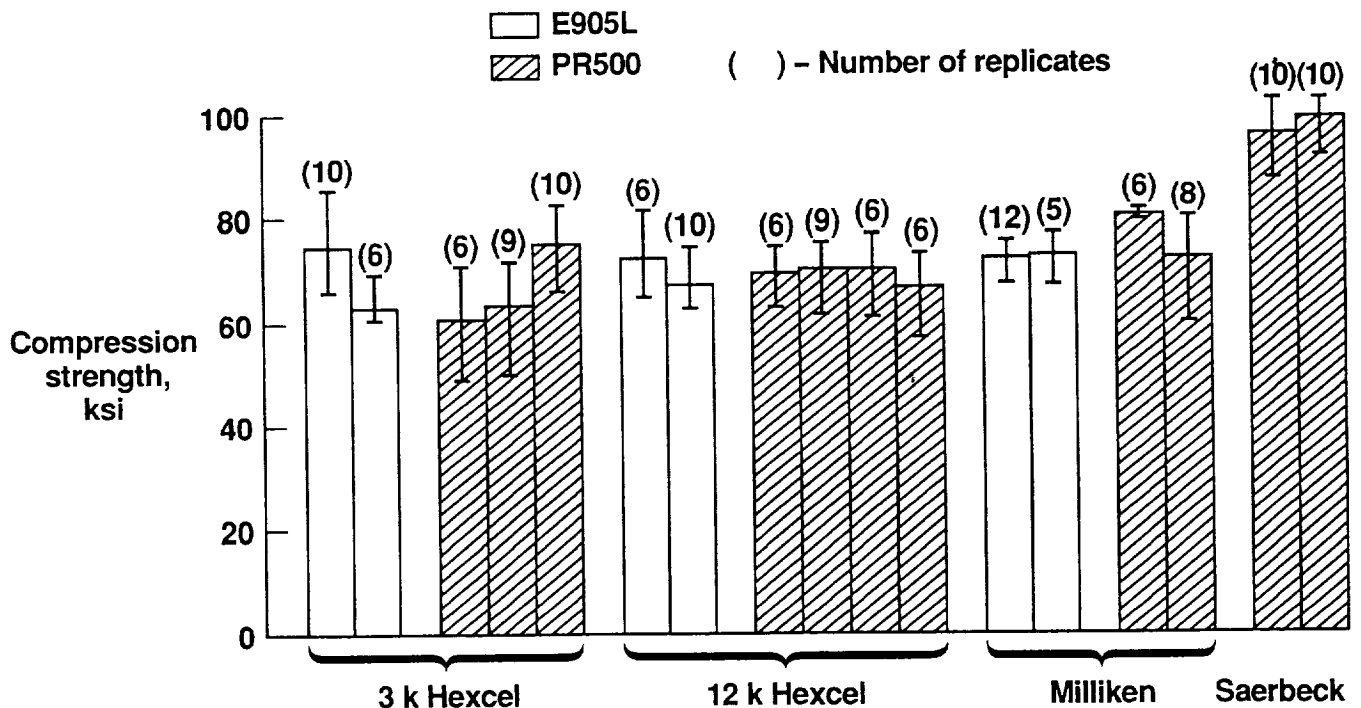

TENSION STRENGTH OF KNITTED FABRIC COMPOSITES

Average tension strengths for the Hexcel and Milliken fabric laminates are shown in figure 15. Test results are shown for E905L and PR 500 resin systems for the various fiber orientations and tow sizes indicated in the figure, and are compared to results of prepreg tape laminates fabricated with Hercules 3501-6 resin. The average tension strength of the Hexcel knitted fabrics is about 15 percent lower than the strength of the prepreg tape laminates. There is no appreciable difference in strength between the Hexcel knitted laminates fabricated with 3, 6, or 12K tows. These results are important because significant labor savings can be achieved through reduced machine running time and laminate layup time. For example, a 1/4-inch thick laminate requires eight 4-ply stacks of 3K tow fabric, whereas only four 4-ply stacks are required with 12K tows.

Average tension strengths for the Milliken fabric laminate specimens are about 30 percent lower than the strength of the prepreg tape laminate. Part of this additional strength decrease compared to the Hexcel fabric can be attributed to the gaps between the tows and the lower fiber volume fraction of the Milliken fabric. Additional Milliken laminates will be fabricated and tested to achieve a larger data base for comparison with the Hexcel knitted fabric laminates.

TENSION STRENGTH OF KNITTED FABRIC COMPOSITES

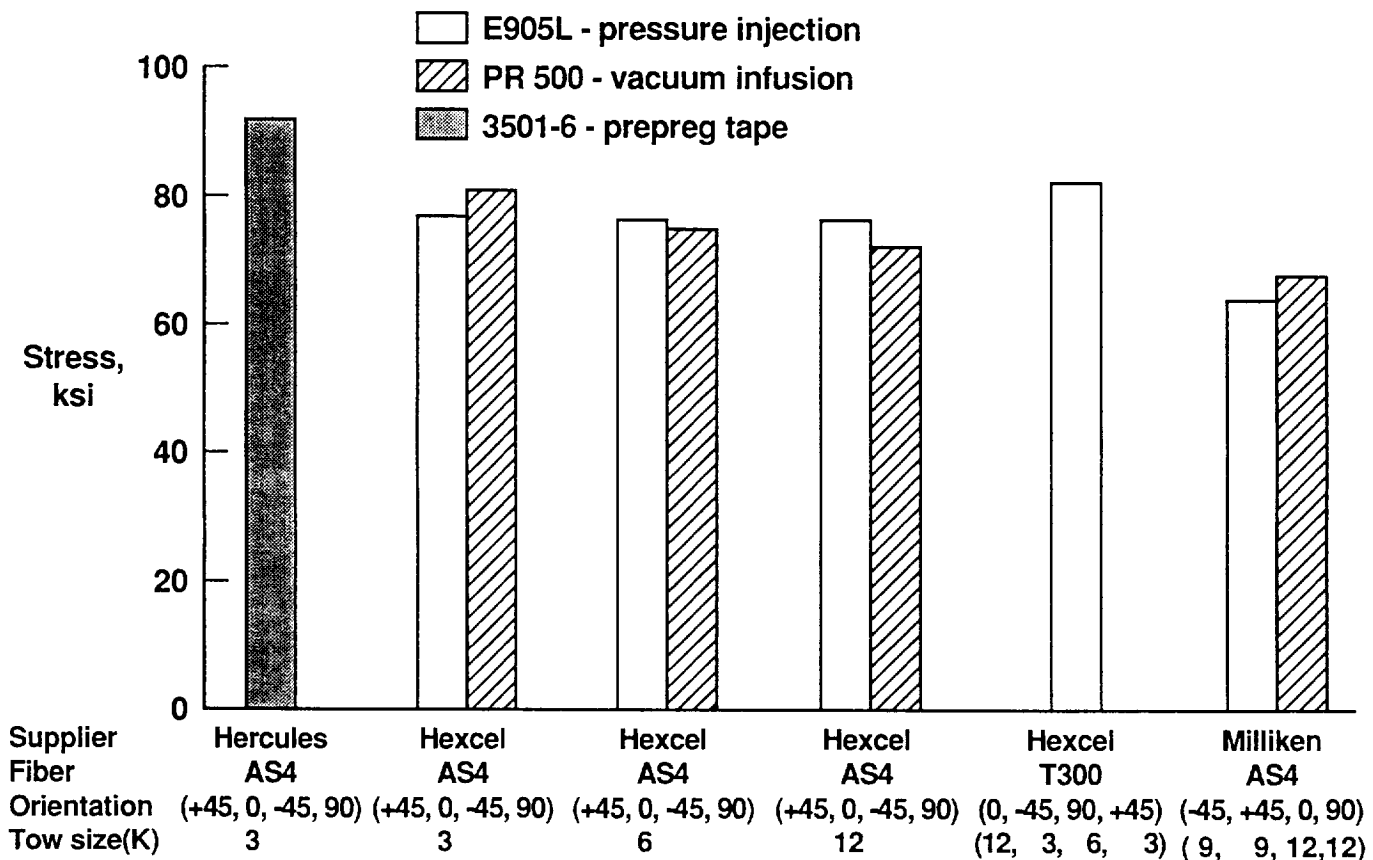

TENSION MODULUS OF KNITTED FABRIC COMPOSITES

Average tension moduli for the Hexcel and Milliken fabric laminates are shown in figure 16. Test results are compared for E905L and PR 500 resin systems for the various fiber orientations and tow sizes indicated in the figure, and again are compared to prepreg tape laminates fabricated with Hercules 3501-6 resin. The tension moduli for all the E905L laminates are slightly higher than the modulus for the prepreg tape laminates, whereas the tension moduli for the PR 500 laminates are slightly lower. These variations are attributed to fiber volume fraction variations. Nominal fiber volume fractions for the three materials are as follows: E905L knitted fabric - 62 percent, PR 500 knitted fabric - 58 percent, and 3501-6 prepreg tape - 60 percent. As was noted in the tension strength results, no significant differences in moduli were observed between 3, 6, or 12K tows of the Hexcel knitted fabric laminates.

TENSION MODULUS OF KNITTED FABRIC COMPOSITES

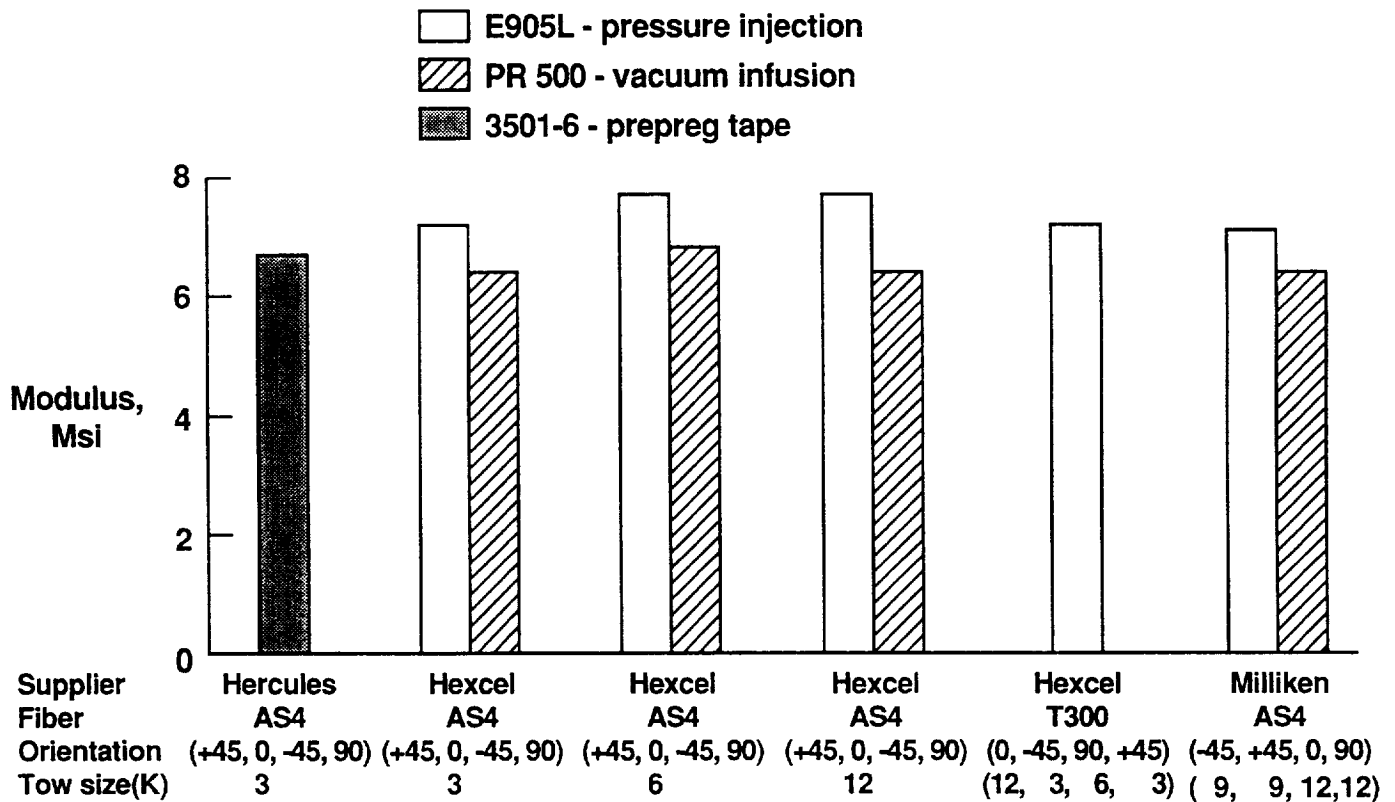

OPEN HOLE TENSION STRENGTH OF KNITTED FABRIC COMPOSITES

The effects of a 1/4-inch diameter hole on the tension strength of the Hexcel and Milliken knitted fabric laminates are shown in figure 17. The average strength for all the knitted fabric laminates is approximately 50 ksi. The open hole tension strength for the prepreg tape material is slightly below 50 ksi, although similar data reported in Hercules product literature indicates that the open hole tension strength of 3501-6 prepreg tape is 50 ksi. Hence, based on these results, knitted fabric laminates and prepreg laminates have similar open hole tension strengths and they meet the Boeing Material Specification BMS 8-276 target value of 50 ksi.

OPEN HOLE TENSION STRENGTH OF KNITTED FABRIC COMPOSITES

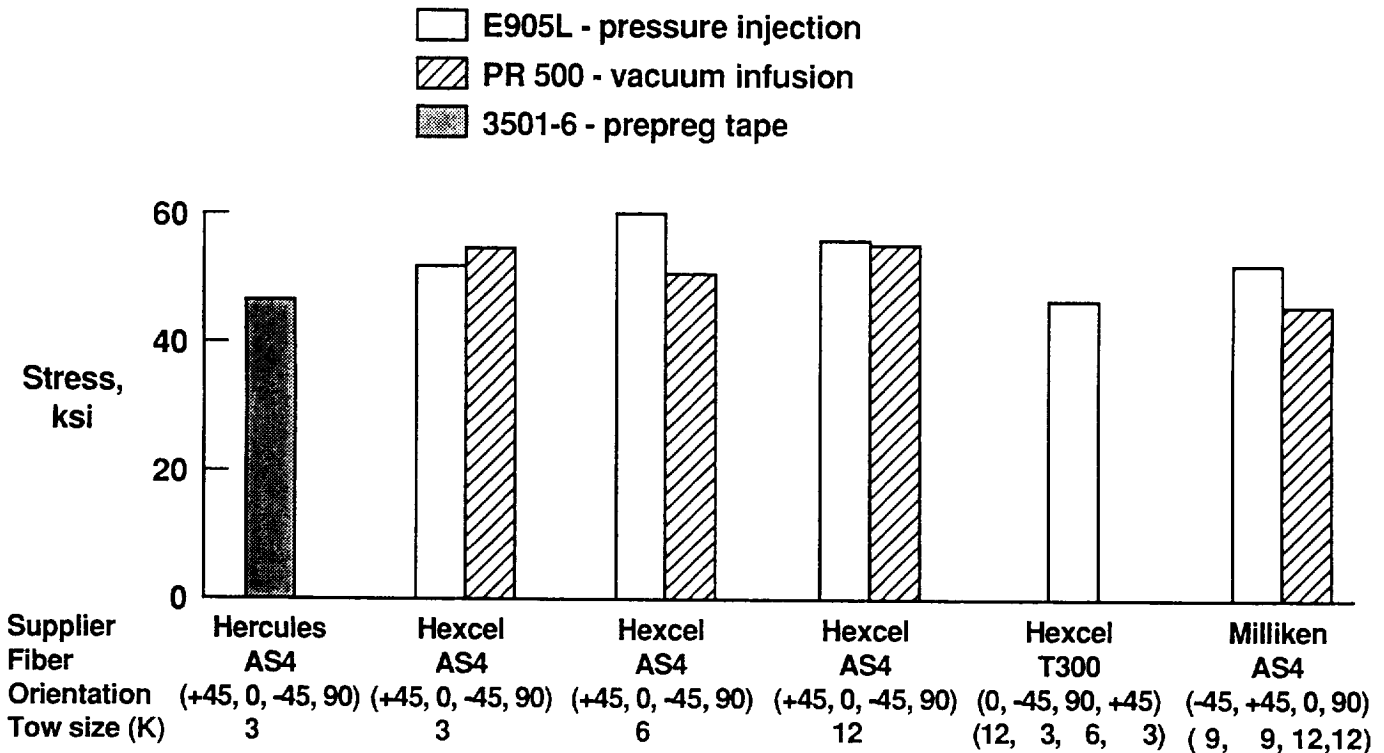

COMPRESSION STRENGTH OF KNITTED FABRIC COMPOSITES

The compression strengths of the Hexcel and Milliken knitted fabric laminates are compared with the strength of prepreg tape laminates in figure 18. Results indicate that the average compression strength for the Hexcel knitted fabric laminates is about 25 percent lower than the strength for the prepreg tape laminates. The Milliken knitted fabric laminates indicate a 20 percent reduction in compression strength compared to the prepreg tape laminates. These reductions in strength are partially attributed to fiber waviness caused by gaps in the knitted fabrics. Photomicrographic studies, shown earlier in figure 11, indicated that the carbon fiber tows tend to deflect out-of-plane to fill gaps in adjacent layers. As with the tension results, no significant differences in compression strength were indicated between 3, 6, or 12K tows for the Hexcel knitted fabric laminates, or between the two resin systems used in either knitted laminate.

COMPRESSION STRENGTH OF KNITTED FABRIC COMPOSITES

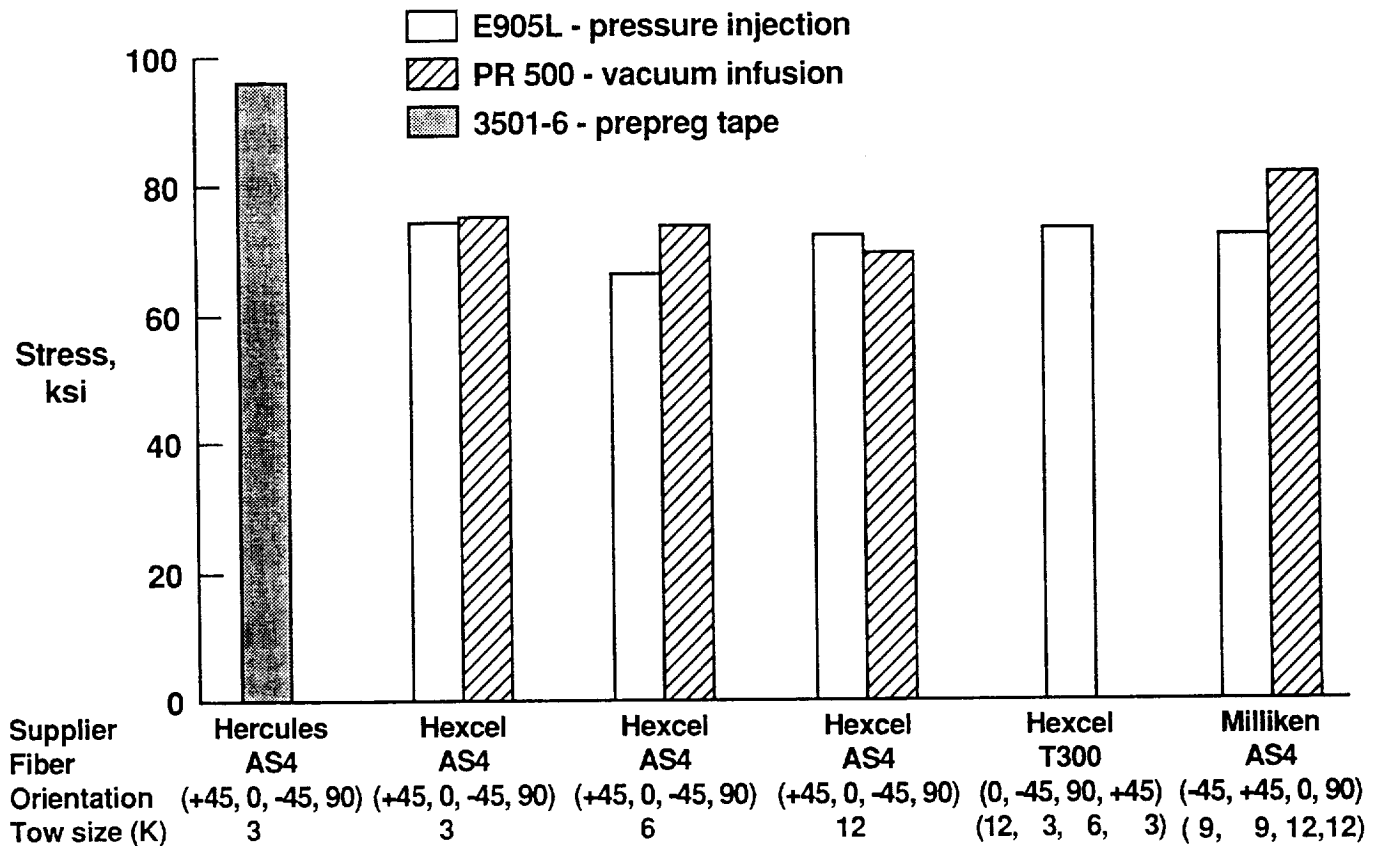

COMPRESSION MODULUS OF KNITTED FABRIC COMPOSITES

Average compression moduli for the Hexcel and Milliken fabric laminates are compared with the modulus of prepreg tape laminates in figure 19. The average compression moduli for the knitted fabric laminates with E905L resin are similar to the modulus achieved for the 3501-6 prepreg tape. The moduli for the knitted fabric laminates with PR 500 resin are about 15 percent lower than these values. As mentioned previously, the knitted fabric laminates with PR 500 resin had a lower fiber volume fraction compared to the knitted fabric laminates with E905L resin. However, this difference in fiber volume fraction would not account for a 15 percent reduction in modulus.

COMPRESSION MODULUS OF KNITTED FABRIC COMPOSITES

- E905L - pressure injection
- ▨ PR 500 - vacuum infusion
- ▩ 3501-6 - prepreg tape

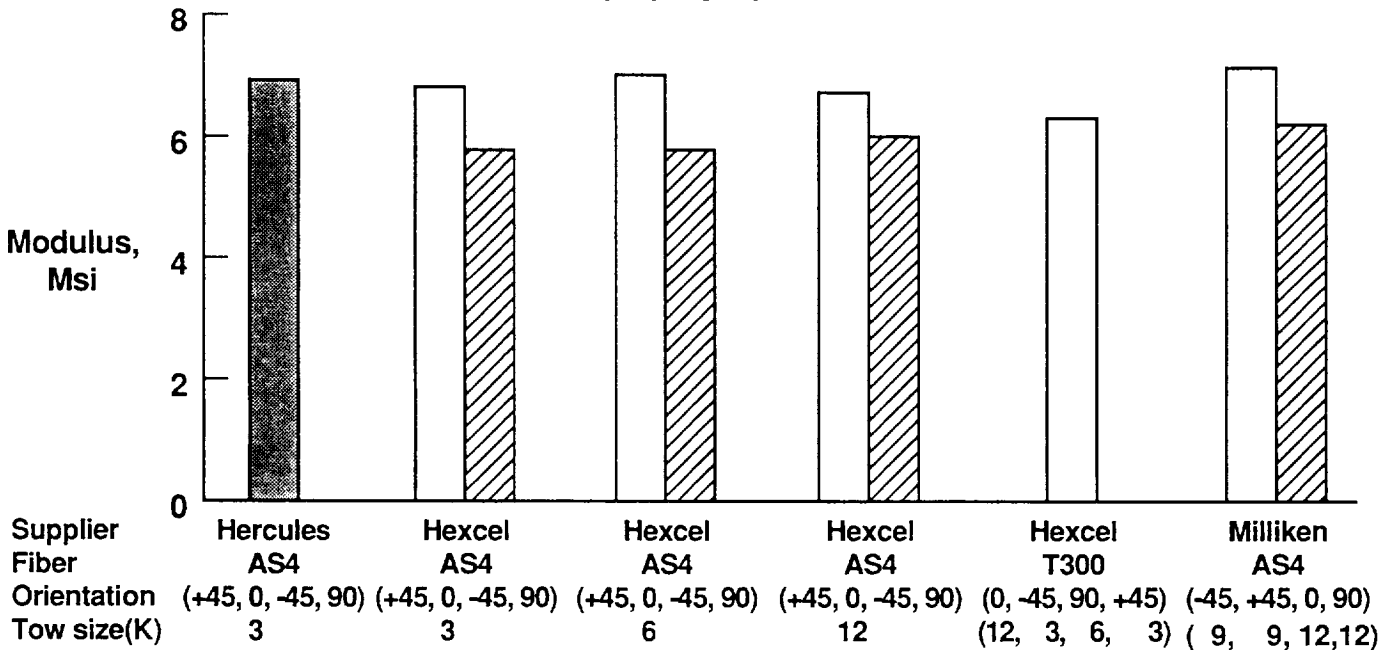

OPEN HOLE COMPRESSION STRENGTH OF KNITTED FABRIC COMPOSITES

The effects of a 1/4-inch diameter hole on the compression strength of the Hexcel and Milliken knitted fabric laminates are shown in figure 20. The results indicate similar performance for the knitted fabric laminates and the prepreg tape laminates. In addition, these results compare favorably with the Hercules product literature value of 45 ksi and the Boeing Material Specification BMS 8-276 target value of 42.5 ksi.

OPEN HOLE COMPRESSION STRENGTH OF KNITTED FABRIC COMPOSITES

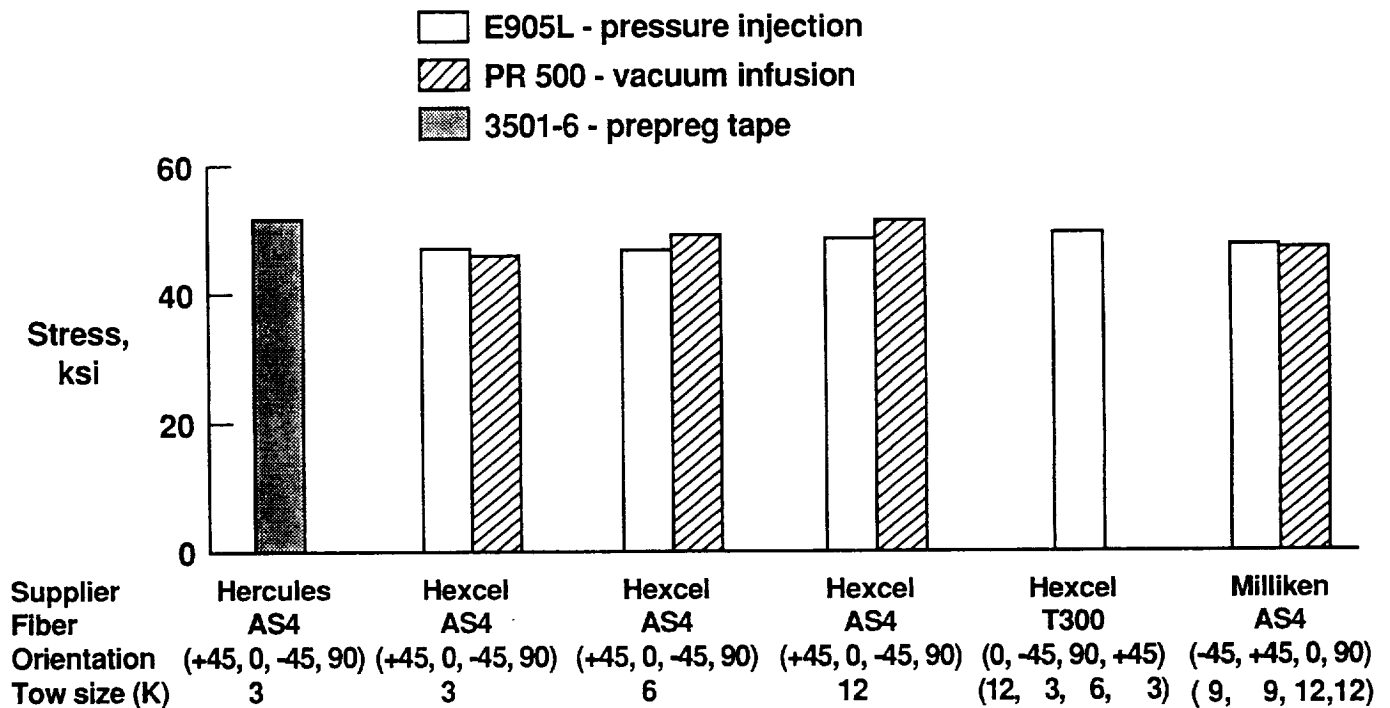

COMPRESSION AFTER IMPACT STRENGTH OF KNITTED FABRIC COMPOSITES

Compression after impact (CAI) strength tests were conducted to compare the damage tolerance of knitted fabric laminates with conventional prepreg tape laminates. The 1/4-inch thick laminates were impacted with 1/2-inch diameter aluminum spheres at an impact energy of 30 ft-lbs with the NASA Langley air gun. The test results shown in figure 21 indicate that the knitted fabric laminates that were resin transfer molded with the toughened PR 500 resin had CAI strengths up to 50 percent higher than the brittle 3501-6 prepreg tape laminates. The knitted fabric laminates with E905L resin had CAI strengths that were up to 30 percent higher than the prepreg tape laminates. These results indicate significant improvements in damage tolerance for the knitted fabric laminates. However, they still fall well below the target of 40 ksi. Additional through-the-thickness reinforcement such as heavy density stitching is required to achieve the target value.

COMPRESSION AFTER IMPACT STRENGTH OF KNITTED FABRIC COMPOSITES

30 ft-lb impact NASA Air Gun

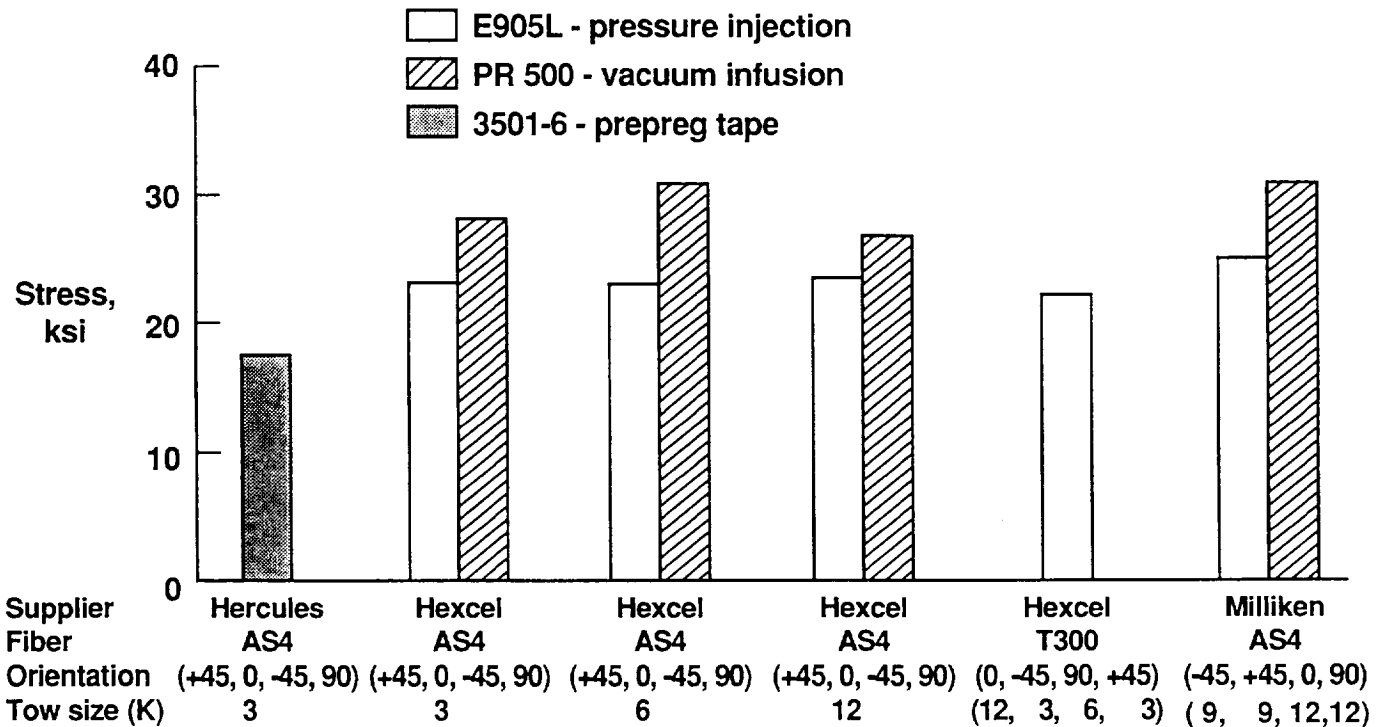

COMPRESSION AFTER IMPACT STRENGTH OF KNITTED/STITCHED FABRIC COMPOSITES

Compression after impact strength tests were also conducted to determine the effect of stitching on the strength of knitted fabric laminates, figure 22. The Hexcel preforms that were knitted with 3K and 12K tows were stitched by Ketema with a modified lock stitch. The preforms were stitched in the 0-degree direction in columns 0.33-inch apart with a stitch pitch of 1/8-inch. The Milliken preforms were stitched by Puritan Industries with a chain stitch. The panels were chain stitched in the 0-degree and 90-degree directions with rows and columns 1/4-inch apart with a stitch pitch of 1/8-inch. All the preforms were stitched with a 1500 denier Kevlar thread.

The panels were impacted at an energy level of 30 ft-lbs with the same procedure described earlier. The Milliken knitted/stitched fabric laminates with the PR 500 resin system achieved the target of 40 ksi CAI strength. The Hexcel knitted/stitched laminates fell below the target. The toughened PR 500 resin system exhibited consistently higher CAI strengths than the E905L, as was noted in the unstitched results. Results of a previous stitching study, reference 2, indicated strengths over 45 ksi with stitched uniweave fabric laminates when a stitch spacing of 3/16-inch was used. Based on those findings, it is expected that the Hexcel fabric laminates would achieve the target value if the stitch spacing were reduced to no more than 3/16-inch.

COMPRESSION AFTER IMPACT STRENGTH OF KNITTED/STITCHED FABRIC COMPOSITES

30 ft-lb impact NASA Air Gun

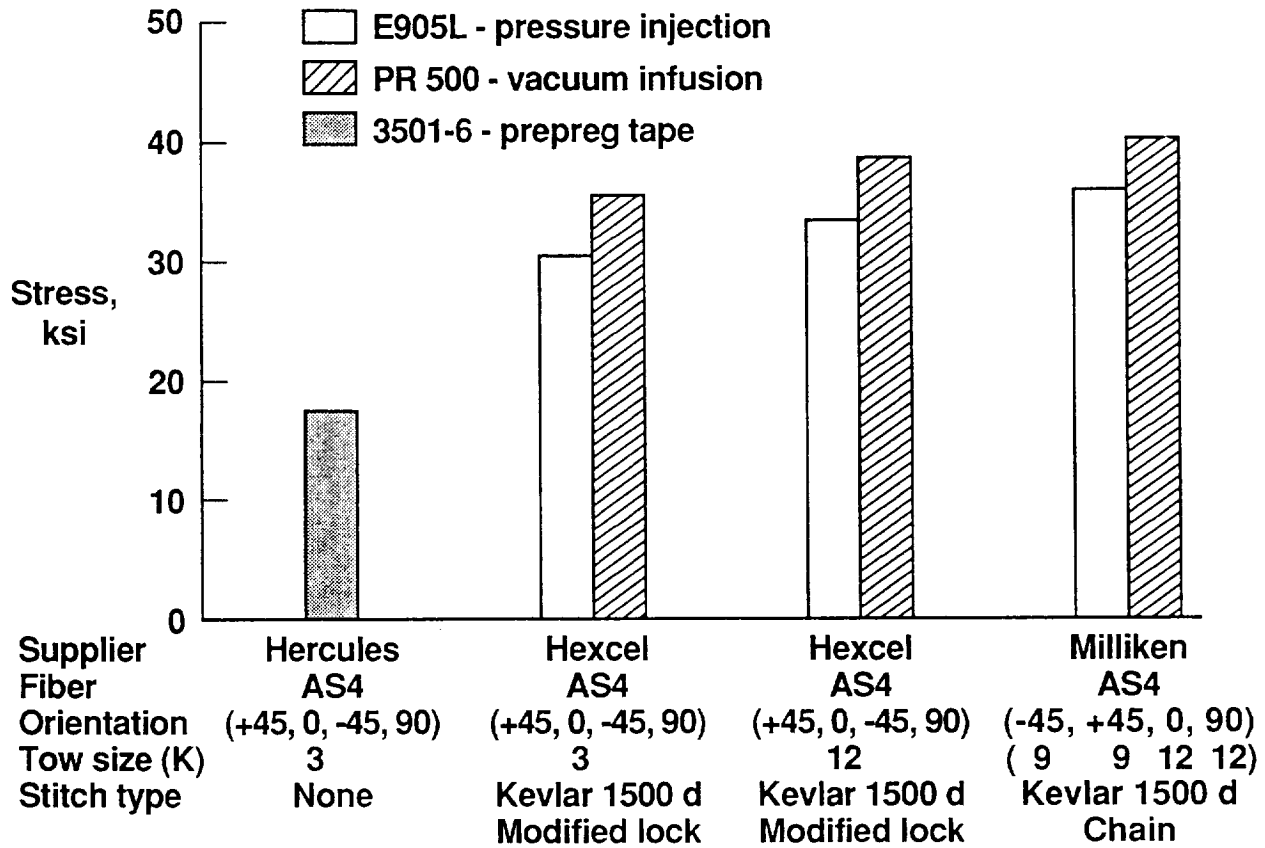

PERFORMANCE COMPARISON OF AS4/PR 500 SAERBECK KNITTED AND UNIWEAVE FABRIC COMPOSITES

Douglas Aircraft Company and NASA Langley have been developing a data base on uniweave fabrics for application to wing structural components. The Douglas design for the wing skin material consists of 54 plies of uniweave fabric with 44 percent of the fibers in the 0-degree direction, 44 percent of the fibers in the ± 45 -degree directions, and 12 percent of the fibers in the 90-degree direction. Concerns for stability and handleability of the uniweave fabric led Douglas to investigate other fabric options. A knitted fabric produced by Saerbeck in Germany was selected. A description of the fabric was presented in figure 2. The test results presented in figure 23 were developed at NASA Langley in a cooperative effort with Douglas. It should be noted that the test results are preliminary and additional tests are planned to expand the data base.

Tension, compression, open hole tension, open hole compression, and CAI tests were conducted to compare the performance of the knitted and uniweave fabric laminates. All of the fabrics were resin transfer molded with the 3M PR 500 resin except the stitched uniweave CAI panel which was fabricated with Hercules 3501-6 resin. Also, the uniweave panel was stitched with S-2 glass whereas the Saerbeck panel was stitched with Kevlar. The stitched uniweave panel was impacted at an energy level of 40 ft-lbs with a drop weight apparatus. The other panels were impacted at an energy level of 30 ft-lbs with the air gun previously described. Test results shown in figure 23 indicate comparable performance between the two fabrics. Both fabrics meet the design requirements for the Douglas wing skin. It should be noted that the Saerbeck knitted fabric consisted of six 4-ply stacks whereas the uniweave fabric consisted of 54 plies to build up the required thickness of 0.30-inch. This difference has important cost implications and will be discussed in a subsequent figure.

PERFORMANCE COMPARISON OF AS4/PR 500 SAERBECK KNITTED AND UNIWEAVE FABRIC COMPOSITES

Douglas ACT wing layup (0, +45, 90, -45)

[44% 0°, 44% ±45°, 12% 90°]

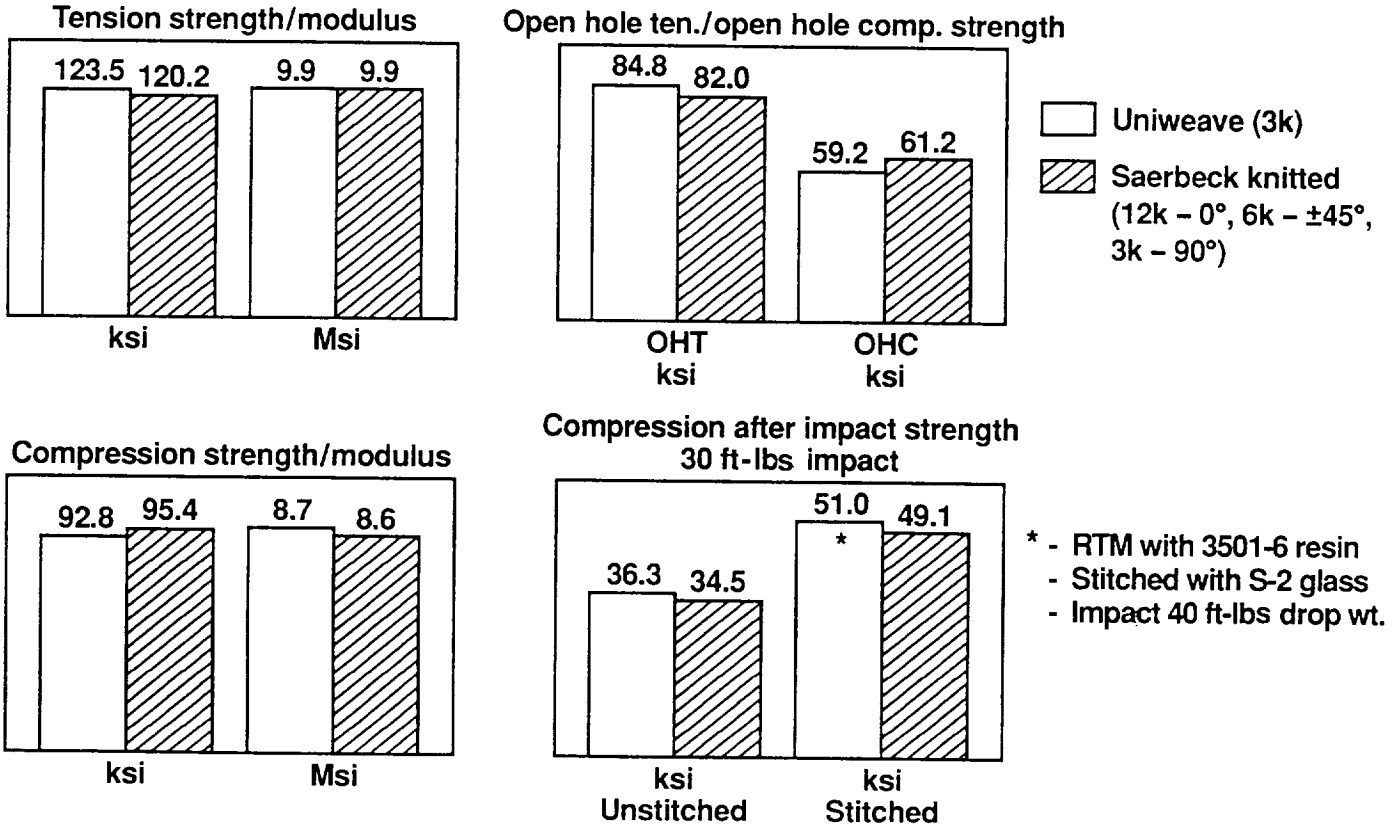

ESTIMATED LABOR/MATERIAL COST FOR STITCHED CARBON FIBER PREFORMS

Estimated labor and material costs were projected by Douglas Aircraft Company for two different carbon fiber preforms with the same wing skin layup. The preform was assumed to be 8-feet wide by 60-feet long by 0.30-inch thick with a layup consisting of 44 percent fibers in the 0-degree direction, 44 percent of the fibers in the ± 45 -degree directions, and 12 percent of the fibers in the 90-degree direction. The baseline used for these estimates is the 3K uniweave fabric that is currently being used by Douglas in their wing skin development. Fifty-four plies of the uniweave fabric are required to produce the 0.30-inch thick preform. The preform is produced by lightly stitching 9-ply stacks of fabric with a multineedle machine and subsequently stitching six of the 9-ply stacks together with a heavy-duty single needle machine.

An alternate approach consisted of using the Saerbeck knitted fabric. This fabric consisted of a 4-ply stack that was equivalent in properties and areal weight to the 9-ply stack of uniweave fabric. Six stacks of the Saerbeck fabric were required to produce the 0.30-inch thick preform. The six stacks of Saerbeck fabric were stitched together with the single needle machine. The uniweave and Saerbeck fabrics are currently available in 50-inch widths. The cost analysis results presented in figure 24 are based on weaving and knitting machine developments required to produce 100-inch wide fabrics.

The cost analysis indicates that the Saerbeck knitted preform material cost will be 35 percent lower than the uniweave cost and the labor cost for the Saerbeck knitted preform will be 40 percent less. The material cost savings is due to the high speed, multilayer knitting processes compared to the slower single layer weaving processes. The labor cost savings are attributed to elimination of the stacking required for the 9-ply uniweave elements plus the elimination of the multineedle stitching operation. These results, along with the performance results shown in figure 23, indicate that knitted fabrics are excellent candidates for the Douglas wing skin material. A scale-up in equipment and on-line process controls are required to meet the long term needs for airframe production.

ESTIMATED LABOR/MATERIAL COST FOR STITCHED CARBON FIBER PREFORMS

8 ft wide x 60 ft long x 0.30-in. thick
[44% 0°, 44% ±45°, 12% 90°]

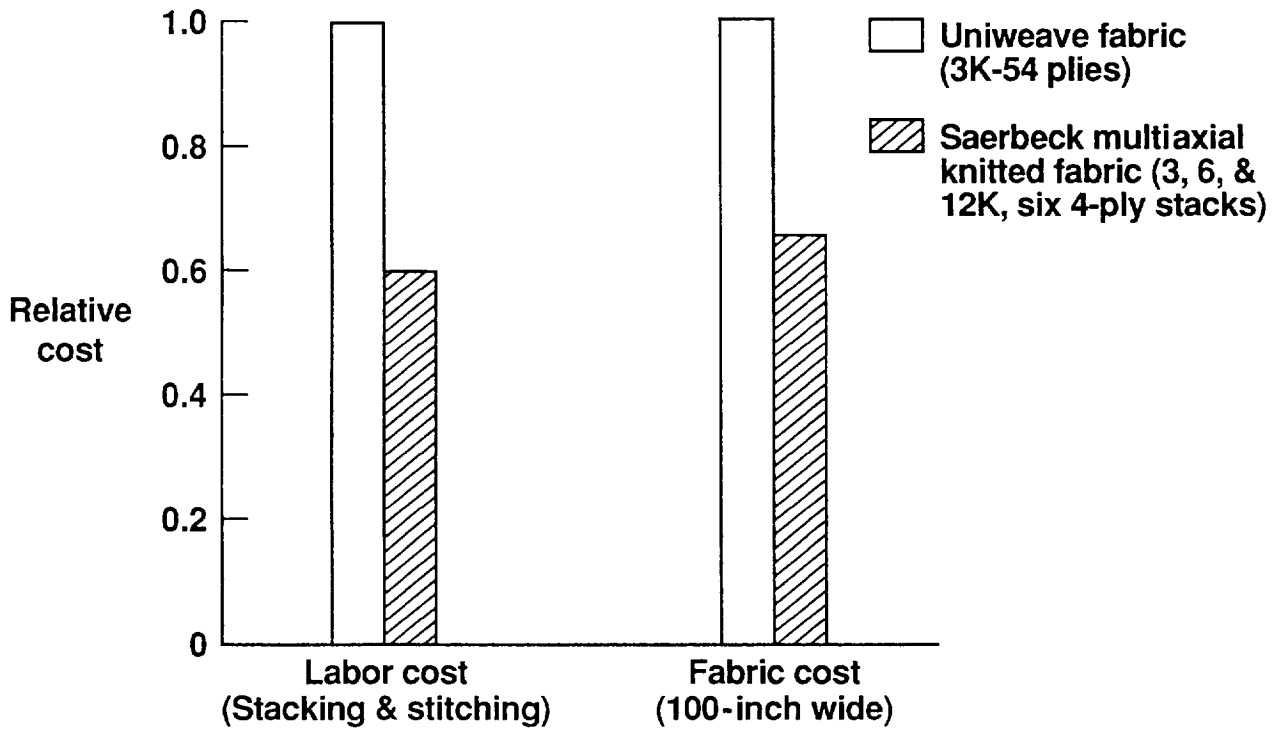

CONCLUDING REMARKS

Three relatively new multiaxial warp knitting processes were evaluated to establish their potential to produce aerospace quality fabrics for composite structural applications. Quasi-isotropic knitted fabrics were produced by Hexcel and Milliken and a knitted fabric with the Douglas Aircraft Company wing skin layup was produced by Saerbeck in Germany. All of the fabrics were fabricated into composite test panels using the resin transfer molding process. Two new resin systems, British Petroleum E905L and 3M PR 500, were selected for the processing studies. Compaction and permeability studies were conducted on the dry fabric preforms to aid in development of infiltration and cure cycles. Viscosity profiles and cure cycles for both resin systems were developed to insure high quality composite test laminates. Low void content laminates were produced with the PR 500 resin in a vacuum infusion process and with the E905L resin in a pressure injection process. Prepreg tape laminates with AS4/3501-6 graphite/epoxy were used as a baseline to compare the performance of the knitted laminates.

Tension, compression, open hole tension, open hole compression, and CAI tests were conducted to compare material performance. In addition, some dry preforms were stitched with 1500 denier Kevlar thread to evaluate the effects of stitching on damage tolerance. The mechanical performance of the Hexcel and Milliken fabric laminates was compared to quasi-isotropic prepreg tape laminates and the performance of the Saerbeck fabric laminates was compared to uniweave laminates with the Douglas wing skin layup. Compared to prepreg tape laminates, the Hexcel and Milliken knitted fabric laminates had tension and compression strengths that were up to 30 percent lower. The open hole tension and compression strengths were similar to the prepreg tape laminates. However, the CAI strengths of the knitted fabric laminates were up to 50 percent higher than the CAI strength of the prepreg tape laminates. The addition of stitching increased the CAI strength of the knitted fabric laminates near the target value of 40 ksi. A limited data base was generated for the Saerbeck knitted fabric and the performance was comparable with the performance of uniweave fabric in all the tests conducted.

Excessive data scatter was evident for the Hexcel and Milliken fabric laminates. Contributing factors to the scatter include misaligned fibers and large gaps between tows. To achieve aerospace quality fabrics, the Hexcel and Milliken knitting processes must incorporate stringent on-line process controls that will control fiber tension, alignment, and gaps between tows. The overall quality of the Saerbeck fabric was superior to the Hexcel fabric, mostly in the areas of fiber alignment and reduced gaps.

Preliminary cost analyses conducted by Douglas Aircraft Company indicate that the Saerbeck knitted fabric can save 35 to 40 percent in material and labor costs for fabrication of wing skin preforms. The results of this investigation indicate that multiaxial warp knit fabrics can be used to produce high quality resin transfer molded composites for aircraft structural applications. Significant cost savings are possible compared to conventional unidirectional and bidirectional woven fabrics.

REFERENCES

1. Dexter, H. Benson, Hasko, Gregory H., and Cano, Roberto J: Characterization of Multiaxial Warp Knit Composites, First NASA Advanced Composites Technology Conference, Seattle, Washington, October 29-November 1, 1990, NASA Conference Publication 3104, Part 2, pp. 589-619.
2. Palmer, Raymond J., Dow, Marvin B., and Smith, Donald J: Development of Stitching Reinforcement for Transport Wing Panels, First NASA Advanced Composites Technology Conference, Seattle, Washington, October 29-November 1, 1990, NASA Conference Publication 3104, Part 2, pp 621-646.

