

1996
-1516

NASA Contractor Report 198285

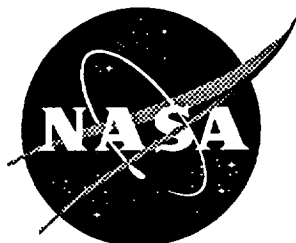

Compression Testing of Textile Composite Materials

John E. Masters
Lockheed Martin Engineering and Sciences Company, Hampton, Virginia

Contract NAS1-19000

February 1996

National Aeronautics and
Space Administration
Langley Research Center
Hampton, Virginia 23681-0001

Abstract:

The utilization of textile processes such as braiding, weaving, and knitting in the manufacture of composite materials has long been proposed as a means of improving mechanical performance and of reducing cost. However, along with the potential advantages of improved impact and delamination resistance, these new material forms also bring with them new challenges in design and manufacturing.

The applicability of existing test methods, which were developed primarily for laminates made of unidirectional prepreg tape, to textile composites is one area of concern. The issue is whether the values measured for the 2-D and 3-D braided, woven, stitched, and knit materials are accurate representations of the true material response.

This report provides a review of efforts to establish a compression test method for textile reinforced composite materials. Experimental data have been gathered from several sources and evaluated to assess the effectiveness of a variety of test methods. The effectiveness of the individual test methods to measure the material's modulus and strength is determined. Data are presented for 2-D triaxial braided, 3-D woven, and stitched graphite/epoxy material. However, the determination of a recommended test method and specimen dimensions is based, primarily, on experimental results obtained by the Boeing Defense and Space Group for 2-D triaxially braided materials.

Introduction

Textile composite materials have been extensively evaluated in NASA's Advanced Composite Technology (ACT) Program, which was initiated in 1990 to develop less-costly composite aircraft structures. Composite laminates reinforced with continuous networks of braided, woven, knit, or stitched fibers have all been tested as a part of the program. These test results established the viability of textile composite materials as potential alternatives to unidirectional prepreg tape.

These new composite material forms bring with them potential testing problems. The test methods currently used to evaluate composite materials were developed for composite materials made of unidirectional prepreg tape or simple 2-D woven fabrics. The microstructure of these laminated composite materials differs significantly from the architectures of the braided, woven, knit, and stitched materials under investigation. Consequently, the applicability of the current test methods to the wide range of emerging materials bears investigation. The overriding concern is that the values measured are accurate representations of the true material response.

Fiber architecture plays a prime role in determining the mechanical response of textile composite materials. Inhomogeneous local displacement fields develop within the textile specimens, even under uniform axial extension (Ref. 1), as a result of the interweaving and interlacing of the yarn bundles. This is not seen in laminates formed of unidirectional tape materials. Specimen dimensions and loading methods developed for tape type composites may, therefore, not be applicable to textile composites.

A program to establish a set of test methods to evaluate textile composites was developed to address these issues. This report provides a review of a portion of that work, the effort to establish a compression test method for unnotched textile reinforced composite materials.

Information was gathered from a variety of sources and analyzed to establish the recommended test method. The current practices established by ASTM and the MIL-HDBK-17 Committee for laminated composite materials were considered. Test data developed

by Boeing Defense and Space (Ref. 2) under contract to NASA was the primary source of information on compression test method development for textile composites. In addition, Lockheed Aeronautical Systems Company conducted an extensive materials evaluation program on braided and woven textile systems. The test practice employed there and the data developed on that program were also evaluated.

The following sections include descriptions of the materials investigated and the test methods considered. This is followed by a discussion of the experimental results and, finally, by a summary section that identifies a recommended test method.

Materials Investigated

Boeing evaluated three textile forms in their test program: 2-D triaxial braids, through-the-thickness weaves, and stitched uniwoven laminates. All the specimens tested in their program featured Hercules' AS-4 graphite fibers and Shell's RSL-1895 epoxy resin.

The Lockheed test program included both 2-D and 3-D braided textiles and 3-D woven systems. The material tested in this program were made of Hercules' AS-4 graphite fibers impregnated with PR-500 epoxy resin.

Braided Material

2-D Triaxial Braids

Specimens featuring 2-D triaxially braided fibrous preforms were evaluated by both Boeing and Lockheed. Figure 1 schematically illustrates a triaxial braid architecture and establishes the nomenclature used in the paper. As the figure indicates, three yarns are intertwined to form a single layer of $0^\circ / \pm \Theta^\circ$ material in this braiding scheme. In the example shown here, the braided yarns are intertwined in a 2 by 2 pattern. Each $+\Theta$ yarn crosses alternatively over and under two $-\Theta$ yarns and vice versa. The 0° yarns were inserted between the braided yarns. This yields a two-dimensional material; there is no through-the-thickness reinforcement.

The figure shows a repeatable unit of the braid architecture that is sometimes referred to as the braid's natural unit cell. A unit cell is a repeatable unit of fabric geometry. It represents the complete yarn or tow intertwinement pattern. It is desirable, for analysis purposes, to define the smallest unit cell possible. Rectangular unit cells are also preferable. The box outlined within the rhombic unit cell defines the smallest unit cell for a triaxial braid.

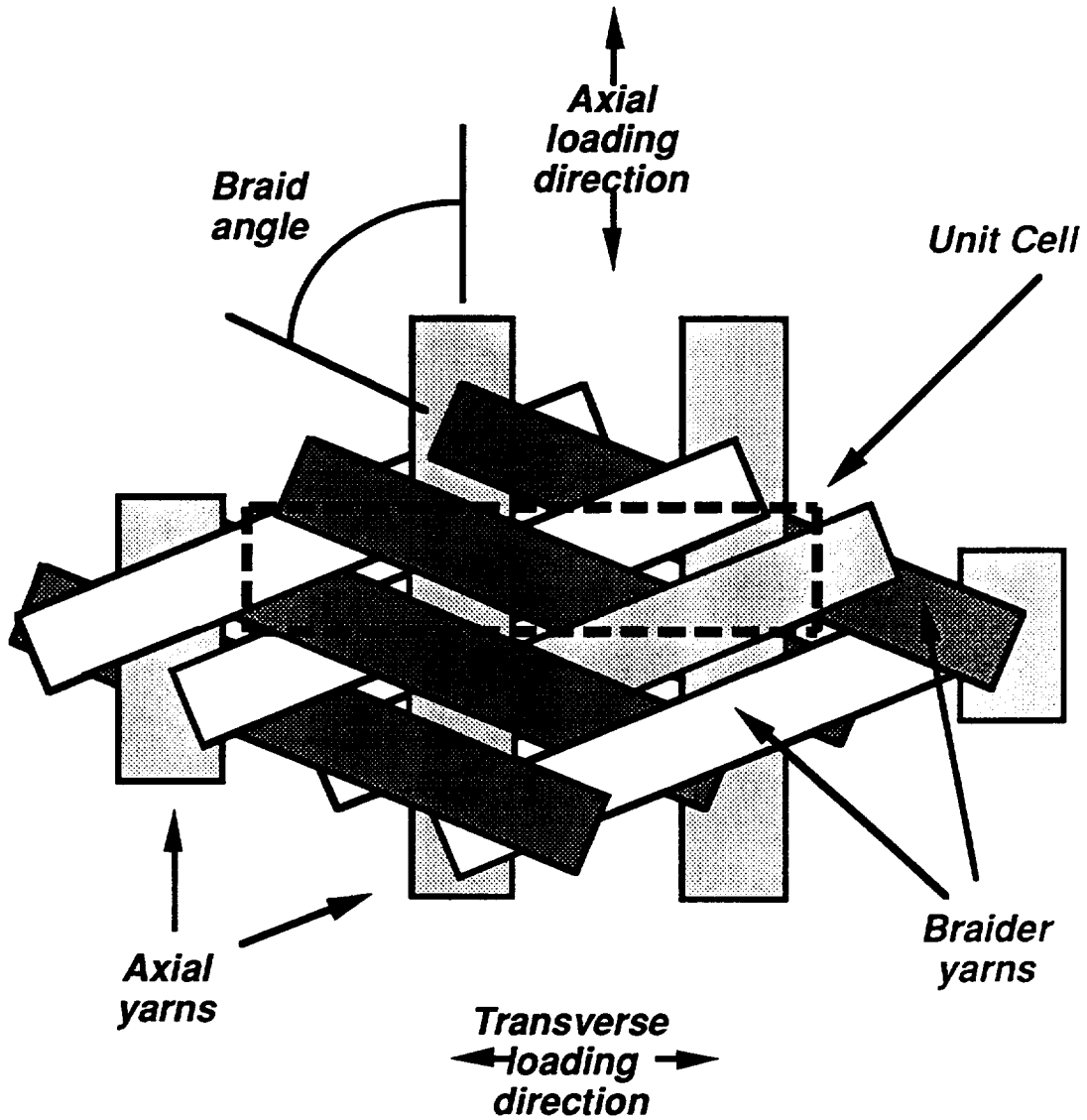

Figure 1. 2-D Triaxial Braid.

A shorthand notation, similar to the practice used to define the stacking sequence of laminates formed of unidirectional prepreg tape, has been developed to define the braid architecture. The proposed notation is

$$[0^\circ \text{ xk} / \pm \theta^\circ \text{ yk}] \text{ N\% Axial}$$

where: θ indicates the braid angle,
 x indicates the number of fibers in the axial yarn bundles,
 y indicates the number of fibers in the braided yarn bundles,
 k indicates thousands, and
 N indicates the percentage by volume of axial yarns in the preform

This notation will be employed throughout the report when referring to the test results obtained for braided materials.

Boeing evaluated four 2-D triaxial braid architectures in their test program. The nominal braid configurations are summarized in Table I. Two specimen thicknesses, 0.125 inches and 0.250 inches, were evaluated in the program. The number of layers in each panel is listed in the table along with the unit cell dimensions.

Table I. 2 - D Triaxial Braid Configurations Investigated by Boeing.

Braid Configuration	Number of Layers		Unit Cell Size (inch) height x width
	(0.125 in.)	(0.250 in.)	
[0 30k / \pm 70 6k] 46% Axial	4	8	.083 x .458
[0 75k / \pm 70 15k] 46% Axial	3	6	.150 x .829
[0 36k / \pm 45 15k] 46% Axial	3	6	.207 x .414
[0 6k / \pm 45 15k] 12% Axial	5	10	.207 x .414

Note: [0 75k/ \pm 70 15k] 46% Axial materials were braided with 72 braider and 36 axial yarns. The others had 144 braider and 72 axial yarns.

Lockheed evaluated two 2-D triaxial braid architectures in their test program. These specimens had the following braid configurations: [0 12k/ \pm 60 6k] 33% Axial and [0 24k/ \pm 60 6k] 50% Axial. All 2-D braid compression specimens tested at Lockheed had a nominal thickness of 0.12 inch. The unit cell dimensions of these architectures were not available.

3-D Braids

Lockheed also tested two 3-D braided materials in compression. Their nominal braid configurations were: [024k/±606k] 50% Axial and [018k/±606k] 56% Axial.

The 3-D braid systems, like their 2-D counterparts, feature three yarn systems that are intertwined to form a fibrous preform. However, unlike the braids discussed earlier, the yarns move along the z axis to provide through-the-thickness reinforcement.

Woven Material

Weaving, unlike braiding, forms a preform by introducing yarns in two orthogonal directions, the warp (0°) and the fill (90°) directions. A fabric is formed in this process by interlacing or selectively inserting fill yarns into the warp yarn system. The individual layers of the woven material tested in this program were formed in this manner. However, unlike traditional woven materials, these specimens also featured graphite yarns woven through the thickness of the panel. These interlocking yarns ran parallel to the 0° warp yarns and wrapped around the 90° weft yarns thus forming a true three-dimensional material.

Three interlocking configurations, through-the-thickness orthogonal interlock, through-the-thickness angle interlock, and a layer-to-layer interlock, were investigated by both Boeing and Lockheed. These three configurations are shown schematically in Figure 2.



Figure 2. General Schematic of the Three 3-D Weave Types.

The woven systems tested at Boeing are defined in Table II. The table lists the sizes of the yarns used in the warp, fill, and the through-the-thickness directions plus the number of layers in each laminate. As the data indicate, two yarn sizes were investigated for each of the three weave patterns studied.

Table III defines the 3-D woven systems evaluated at Lockheed. The sizes of the yarns used in the warp, fill, and the through-the-thickness directions are listed in the table. A comparison of Tables II and III indicates that two weaves were common to each test program. Boeing's TS-2 angle interlock weave is identical to the TTT-1 system tested at Lockheed. The LS-2 and the LTL-2 layer-to-layer angle interlock systems are also quite similar. The former has a slightly higher warp yarn content (56%) than the latter (46%).

Table II. Weave Configurations Investigated by Boeing.

Weave Type	Weave Code	Warp Yarn Size	No. of Warp Layers	Fill Yarn Size	No. of Fill Layers	Interlock Yarn Size
Orthogonal Interlock	OS - 1	24k (59%)	4	12k (34%)	5	6k (7%)
Orthogonal Interlock	OS - 2	12k (58%)	6	6k (31%)	7	3k (11%)
Angle Interlock	TS - 1	24k (57%)	4	12k (33%)	5	6k (10%)
Angle Interlock	TS - 2	12k (56%)	6	6k (38%)	7	3k (6%)
Layer-to-Layer Angle Interlock	LS - 1	24k (59%)	4	12k (35%)	5	6k (7%)
Layer-to-Layer Angle Interlock	LS - 2	12k (56%)	6	6k (39%)	7	3k (5%)

Note: Numbers in parenthesis indicate yarn content as a percentage of total yarn content.

1k T300 yarns were used to interlock the fill yarns on the surface of the Layer-to-Layer Angle Interlock material.

Table III. Weave Configurations Investigated by Lockheed.

Weave Type	Weave Code	Warp Yarn Size	No. of Warp Layers	Fill Yarn Size	No. of Fill Layers	Interlock Yarn Size
Angle Interlock	TTT - 1	12k (56%)	n/a	6k (38%)	n/a	3k (6%)
Layer-to-Layer Angle Interlock	LTL - 1	6k (46%)	n/a	6k (46%)	n/a	3k (8%)
Layer-to-Layer Angle Interlock	LTL - 2	12k (46%)	n/a	6k (46%)	n/a	3k (8%)

Note: Numbers in parenthesis indicate yarn content as a percentage of total yarn content.

1k T300 yarns were used to interlock the fill yarns on the surface of the Layer-to-Layer Angle Interlock material.

Stitched Material

Figure 3 schematically illustrates a stitched fibrous preform and defines the stitching nomenclature. Boeing tested five stitched material systems; they are listed in Table IV. Four stitch parameters, stitching yarn, yarn size, stitch spacing, and stitch pitch, were varied in the study.

All the stitched laminates tested were 48-ply thick. They featured a quasi-isotropic [+45/0/-45/90] 6_s stacking sequence. They were fabricated of an AS4 uniweave fabric that featured a light E-Glass fill yarn (8 fill yarns per inch).

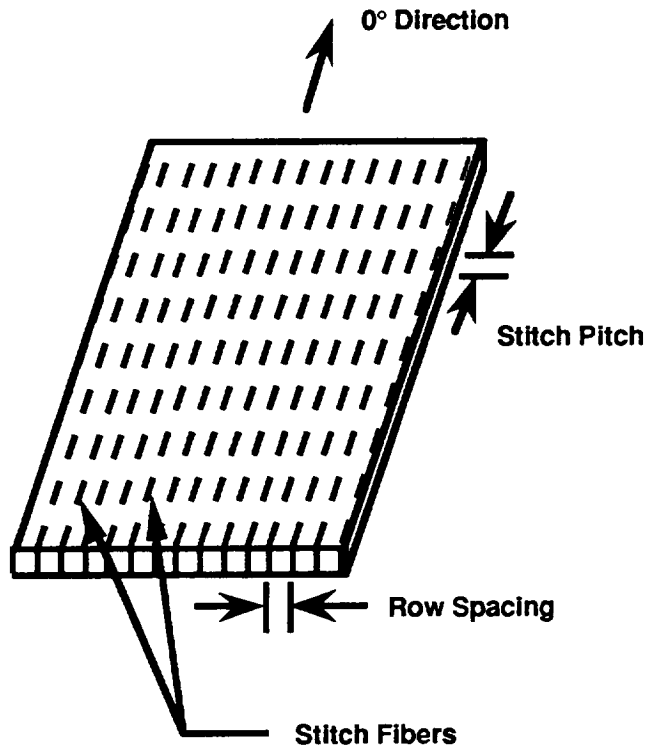

Figure 3. Stitched Laminate Geometry and Nomenclature.

Table IV. Stitched Laminate Configurations Investigated by Boeing.

Material Designation	Stitch Material	Stitch Pitch (stitch/in.)	Stitch Spacing (in)	Stitch Tow Size
SU - 1	S2 Glass	8	0.125	3k
SU - 2	S2 Glass	8	0.125	6k
SU - 3	Kevlar 29	8	0.125	6k
SU - 4	Kevlar 29	4	0.250	6k
SU - 5	Kevlar 29	8	0.125	12k

Test Methods

As Whitney et. al. noted (Ref. 3), compression strength is perhaps the most difficult of the intrinsic composite material properties to measure. This difficulty is due to the material's strong tendency for premature failure under compression loading. Even slight geometric variations can result in eccentricity of the applied load, thereby, enhancing the opportunity for failure due to geometric instability. Local crushing of the specimen ends, or end brooming, is a second potential source of premature failure. A variety of rather complex loading fixtures and specimen configurations have been developed to address these two premature failure modes.

Compression test methods have been classified into three broad categories by Daniel and Ishai (Ref. 4). The first category (Type I) features specimens with short unsupported gage lengths. Relatively long, fully supported specimens are used in the second (Type II) category of test methods. Test fixtures provide contact support over the specimen's entire gage length to prevent bucking in these tests. The composite laminate is bonded to a honeycomb core to provide the required lateral support in the third (Type III) category of compression test methods. Sandwich specimens can be tested in direct edgewise compression or in pure bending. Examples of all three categories of methods can be found in the literature. Representatives of each were considered for use on textile composites.

American Society for Testing and Materials Test Methods

The American Society for Testing and Materials (ASTM) lists two test methods to determine the compressive properties of composite materials: D5467, Standard Test Method for Compressive Properties of Polymer Matrix Composite Materials Using a Sandwich Beam and D3410/D3410M-94, Standard Test Method for Compressive Properties of Polymer Matrix Composite Materials with Unsupported Gage Section by Shear Loading. A third test method, D695, originally developed for rigid, un-reinforced plastics, has been extensively modified and is often used on composite materials. It has become known as the Modified D695 Method (Ref. 5). These test methods were developed for composites fabricated of unidirectional prepreg tape and simple woven fabrics. They are the only methods that have gained broad national acceptance; they have been endorsed by the MIL-HDBK-17 Committee.

The three ASTM test methods differ primarily in the manner in which load is introduced into the specimen. In method D 5467 a honeycomb core sandwich beam with a thin composite skin is loaded in four point bending at its two quarter-span points. This subjects the top skin to nearly uniform compression loading. Load is transferred into the unsupported composite specimen through shear loading in method D 3410. Two test procedures, each with its own test specimen geometry and loading fixture, are identified in the method. Although load is transmitted to the specimen through tapered wedge grips in both procedures, the wedges are conical in one case and rectangular in the other. Compressive load is transmitted to the composite specimen by end-loading in the D 695 test method.

The specimen geometries also differ markedly from method to method. The sandwich flexure specimen used in D 5467 consists of a honeycomb core with a composite skin or facing sheet bonded on the top (compressive) side and a metal sheet bonded on the bottom (tensile) side. The overall beam is 22 inches long and 1 inch wide. The honeycomb core is 1.5 inch deep; and the thickness of the composite and metal faces are adjusted to ensure compressive failure in the top face.

Both test procedures defined in Method D 3410 feature a flat strip of composite material having a constant rectangular cross-section. The specimens' dimensions differ, however. Procedure A requires a 0.25 inch wide, 5.5 inch long specimen with a 0.5 inch test section. In contrast to Procedure A, D 3410 permits a degree of flexibility in the choice of Procedure B specimen dimensions. Specimen widths and gage lengths may vary from 0.5 to 1.0 inch in this case. A table of required minimum specimen thickness is provided for both procedures to ensure that column buckling does not occur in the specimen's unsupported test section. The values listed are determined by applying the Euler buckling equation assuming pinned-end conditions. Minimum specimen thicknesses are expressed in tabular form as a function of the expected modulus and compression strength in the direction of load application. Although recommended tab dimensions are provided in the test method, they are not required. The test method states that there is no reason to change a given gripping method if acceptable failure modes occur with reasonable frequency.

The specimen used in the Modified D 695 test is also straight-sided. It incorporates end tabs that are adhesively bonded to the specimen to increase the bearing area. The specimen is constrained from buckling by sandwiching it between lateral supports that are lightly bolted together. These test specimens are 0.5 inch wide and have an unsupported test section of 0.188 inch. Specimen thickness is set at a nominal 0.040 inch for tape laminates and 0.120 inch for woven fabric laminates.

Test Methods Investigated at Boeing

Boeing evaluated seven compression test configurations. All three of the general test method categories discussed above were represented in the test methods investigated.

Two of the methods investigated featured test specimens with the short unsupported test sections typical of the Type I category of test methods. The first specimen, which is commonly referred to as the NASA Short Block Specimen (Ref. 6), is shown in Figure 4. The second specimen, which bears a close resemblance to the specimen used in Procedure B of ASTM D 3410, is illustrated in Figure 5. Boeing referred to this specimen as a Modified IITRI specimen in deference to the work performed at the Illinois Institute of Technology Research Institute (Ref. 7) that served as the common basis for both this specimen and the one defined in D3410. As the figures illustrate, Boeing chose to use identical test section dimensions for the NASA Short Block and Modified IITRI specimens. All Short Block specimens tested at Boeing were 0.250 inch thick. With the exception of one set of 2-D triaxially braided coupons, all Modified IITRI specimens tested were also 0.250 inch thick.

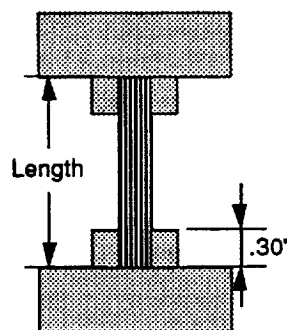

Figure 4. NASA Short Block Specimen and Test Fixture.

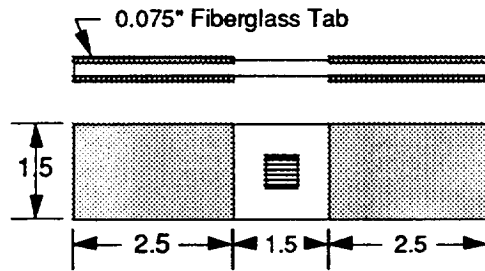

Figure 5. Modified IITRI Test Specimen.

Although both specimens featured short unsupported test sections, the methods of load transfer to the specimens differed. The Short Block specimen is end-loaded; load is transferred to the tabbed Modified IITRI specimen through shear. However, unlike the ASTM method, which uses mechanical wedge grips to transfer load to the specimen, Boeing's Modified IITRI specimen was tested in hydraulic grips.

The method of load introduction and the clamping conditions are the only differences in these two test methods since the two specimens' test section dimensions are identical. As the figures indicate, the loaded edges of the NASA Short Block specimen are clamped over 0.30 inch; the Modified IITRI coupon is clamped over a much larger area. In addition, the Modified IITRI specimen is clamped more rigidly than the NASA Short Block specimen.

The majority of test methods evaluated at Boeing fell into the Type II category since they featured specimens with relatively long test sections that were full or partially supported over their entire gage length to prevent buckling. Two of the test methods evaluated used the 1.5 inch wide, 12.0 inch long specimens shown in Figure 6. In both cases the specimens were sandwiched between lightly bolted lateral supports. The first of these methods is referred to as the Boeing OHC Test in Ref. 2 because it used a test fixture developed for open hole compression (OHC) testing. The fixture, which is shown in Figure 7, is used in the Suppliers of Advanced Composite Material Association's (SACMA) Recommended Test Method SRM 3R-94 (Ref. 8) and is being evaluated by ASTM. It provides contact support over the entire surface of the specimen except for a 1.0 inch long, 0.65 inch wide cut-out section. Load is transferred to the specimen by end-loading in this test.

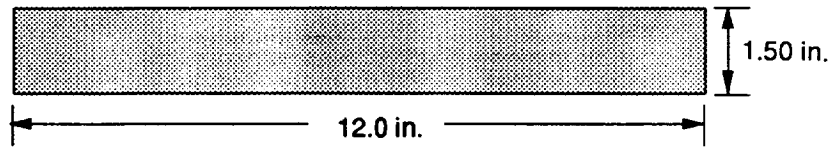

Figure 6. Specimen Used in the Boeing OHC and Zabora Tests.

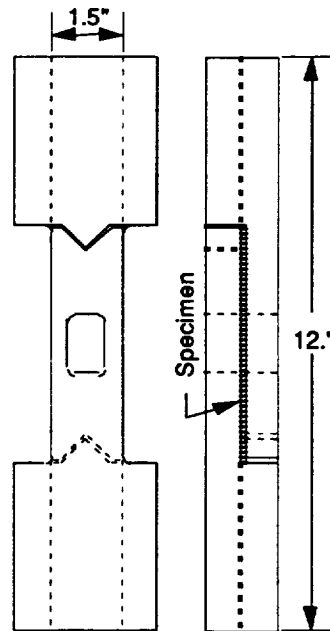

Figure 7. Boeing OHC Test Fixture.

The second method featured a similar test fixture but it supported the specimen in a different manner. In this case the specimen was given contact support along its entire length but only at the edges. As the drawing in Figure 8 indicates, a shallow step is machined into the two halves of the test fixture to leave the central 0.80 inch wide section unsupported. In addition, a 3.0 inch long 0.80 inch wide section of the fixture is cut out of the fixture altogether. The test fixture is referred to as the Zabora Fixture in Boeing's report since it was designed by Ron Zabora of Boeing Commercial Airplanes Co. The load is transferred into the composite specimen through shear loading in the Zabora Fixture.

The Boeing OHC and the Zabora Fixtures permit the evaluation of relatively thin specimens since they support the specimens along their entire length. Boeing tested only 0.125 inch thick specimens in these test fixtures.

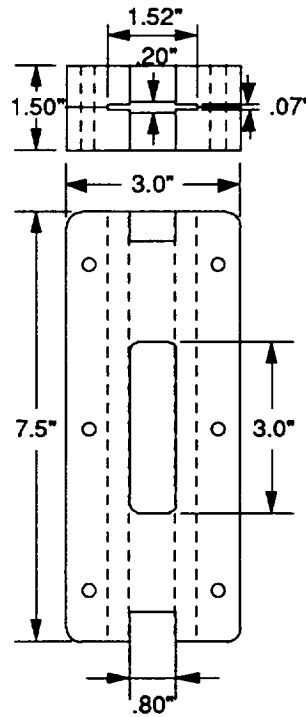

Figure 8. Zabora Test Fixture.

Boeing evaluated two additional test methods that also fit into the Type II compression test category. These test methods were referred to as the Boeing CAI Test and the NASA ST-4 Test in Ref. 2. The first method, which was developed by Boeing Commercial Airplanes Co., featured a test specimen and test fixture that have been used previously in compression after impact (CAI) tests. Like the Boeing OHC Test, it has been adopted by SACMA (Ref. 9) and is under evaluation by ASTM (as a CAI test, not as a compression test). The NASA ST-4 Test was initially developed for open hole compression testing (Ref. 10).

These two test methods differed only in the sizes of the specimens tested. The Boeing CAI test used a 4.0 inch wide, 6.0 inch long specimen; the NASA ST-4 specimen measured 5.0 inch by 10.0

inch. All Boeing CAI and NASA ST-4 specimens tested had a nominal thickness of 0.250 inch.

The specimens are end loaded in both cases. Their loading edges are clamped; their sides are simply supported between rails that are snug but not tight (Figure 9).

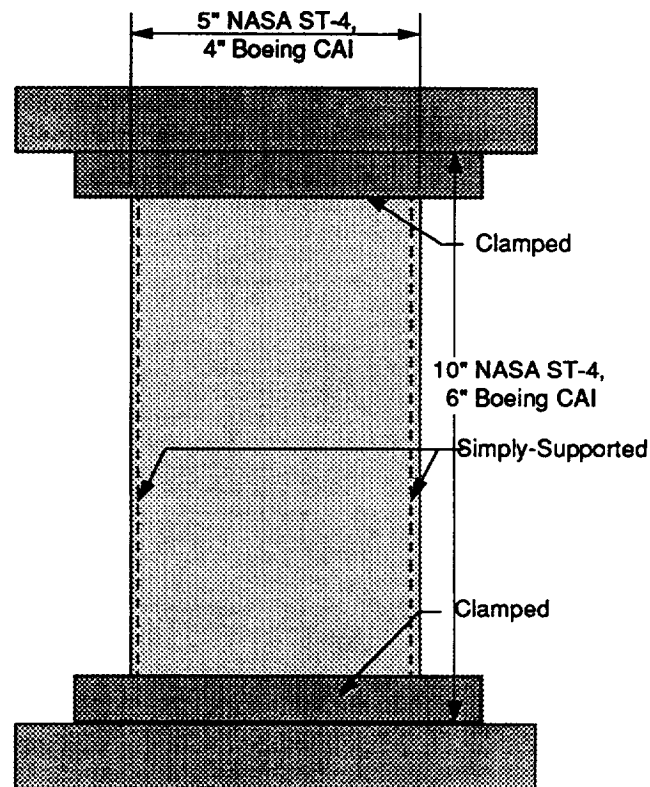

Figure 9. Boeing CAI and NASA ST-4 Test Fixtures.

The seventh test method evaluated at Boeing featured the Sandwich Column Test specimen shown in Figure 10. These tabbed coupons were clamped into a test fixture and end loaded. A shallow 10° bevel was machined into the specimen ends to match the specimen ends to the test fixture that is also shown in the figure.

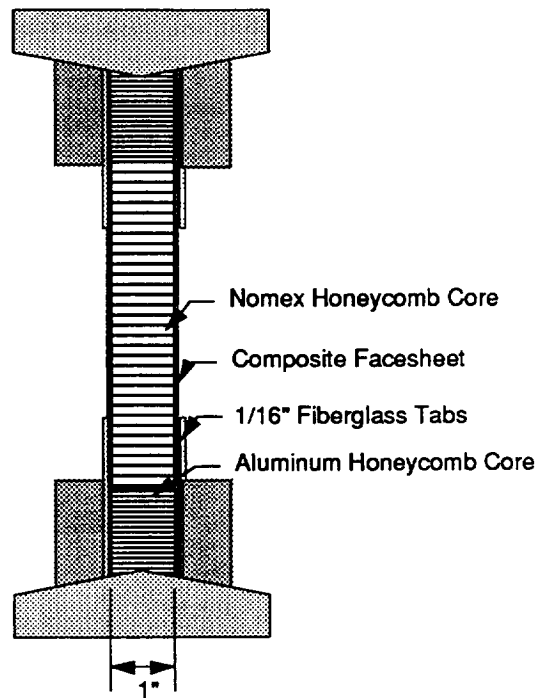

Figure 10. Sandwich Column Test Specimen and Fixture.

Test Method Used by Lockheed Aeronautical Systems Co.

The test method Lockheed employed in its textile materials evaluation program featured relatively long test specimens that were supported along their entire gage length (a Type II test). A test fixture identical to the Zabora Fixture was used to prevent buckling.

Two specimen geometries were used in these tests. Lockheed distinguished between hard materials, which contained greater than 25% axial yarns, and soft materials, which have an axial yarn content of 25% or less. The large, 1.5 inch wide, 12.0 inch long, specimens shown in Figure 11 were used for the soft materials. The smaller, 0.75 inch x 8.0 inch. specimens shown in the figure were used for the hard materials. All the results listed in this report were obtained from specimens with a 0.120 inch nominal thickness. As the figure indicates, Lockheed, unlike Boeing, used tapered specimens in their compression tests.

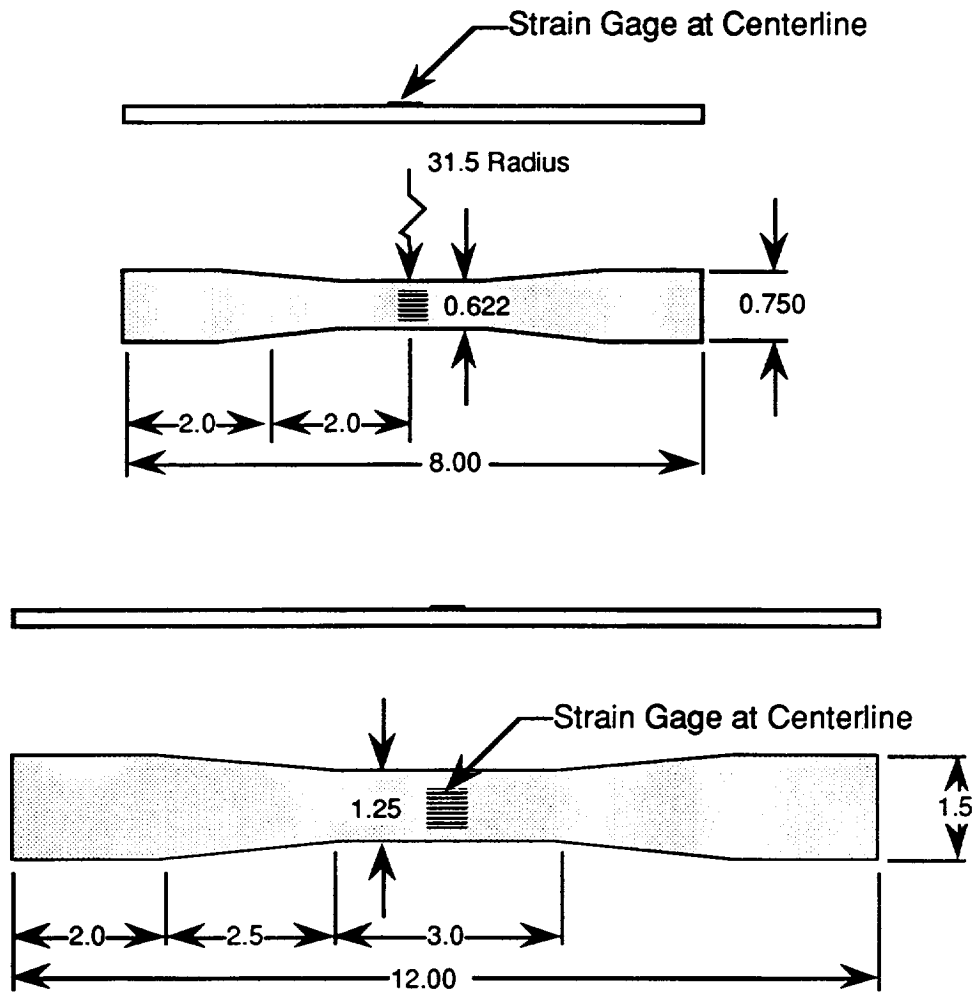

Figure 11. Compression Specimens used at Lockheed.

Very few similarities exist between the compression test methods used at Boeing and Lockheed and the methods developed by ASTM. The Modified IITRI Test method used at Boeing is the closest to an existing standard. However, it differs from the method specified in Procedure B of D 3410 in several ways. The specimen used in the Boeing procedure is wider than the specimen used in D3410. It is also gripped in a slightly different manner. The effects of these variances from the standard method have not been determined. Although the Boeing CAI and the Boeing OHC specimens and test fixtures are being studied by ASTM, neither method is being considered as a compression test method. The former is being evaluated in a proposed compression after impact test method; the latter is being evaluated in a proposed open hole compression test method.

Instrumentation and Data Reduction

Plate-to-plate variations in the fiber volume fraction necessitated the use of a normalization practice to facilitate data comparison. When dealing with tape or fabric laminates, Boeing typically determines a normalized thickness corresponding to a given fiber volume. This thickness is kept constant for all calculations. They used a similar approach in this investigation.

They first experimentally measured each panel's fiber volume fraction and thickness. The mean thickness and fiber volume were then determined across all panels of a given material. The thickness corresponding to a 60% volume fraction was then calculated for each material. These values were used to calculate all stresses and moduli for that material form. The resulting nominal thicknesses are listed in Ref. 2.

Although the values used in the calculations are somewhat different, the nominal thicknesses of "1/8" and "1/4" inch will be used in the following sections of this report for simplicity.

Boeing calculated the specimen modulus by performing a linear regression of load versus axial strain. The axial strain range used in the calculation was 1000 to 3000 microstrain. Boeing employed 0.500 inch square strain gages (Measurements Group Inc. EA-06-500AE-350) in these measurements. The specimen's actual width and nominal thickness were used in the calculation.

Ultimate stress was defined as the specimen ultimate load divided by the specimen actual width and *nominal* (corresponding to 60% fiber volume) thickness:

$$\sigma = \frac{P}{w t_{\text{nom}}}$$

Where P is the load,
w is the specimen width, and
t_{nom} is the nominal thickness.

Test Results

The results of the experimental programs conducted at Boeing and at Lockheed will be reviewed in this section. The Boeing study was designed to develop data to support textile composite material test method development. Their results, therefore, address specific test issues. Lockheed, on the other hand, conducted a materials evaluation program to support their ACT related activities. They employed a single test method in this effort. Their results are included here for completeness. They supplement the results of the Boeing study, which will serve as the primary source of information.

Boeing Test Results - 2-D Triaxial Braids

Although data were generated for 3-D woven and stitched uniweave material systems, Boeing used the 2-D triaxial braided material systems listed in Table I to evaluate the test methods. These material systems were used to establish the viability of the various candidate methods and to measure their sensitivity to specimen dimensions.

Modified IITRI and NASA Short Block Tests

The test matrices used to evaluate the Modified IITRI and NASA Short Block test methods are given in Tables V and VI. The matrices indicate that gage section length was varied from 1.0 to 2.0 inches to determine the specimens' sensitivity to Euler buckling. All the specimens listed in the tables had a nominal thickness of 0.250 inch. In addition to these specimens, one set of 0.125 inch thick, 1.5 inch wide, Modified IITRI specimens were tested for each 2-D braid architecture. These specimens had a 1.0 inch gage length.

Boeing conducted gage length sensitivity studies on Short Block and Modified IITRI specimens only. The studies were necessary for these methods since they use the only specimens in the study with unsupported test sections. Edge or face supports are provided in the other methods to prevent buckling.

Table V. Test Matrix for NASA Short Block Tests.

Dimensions		Material Systems			
Width	Length	[0 30k/±70 6k] 46% Axial	[0 75k/±70 15k] 46% Axial	[0 36k/±45 15k] 46% Axial	[0 6k/±45 15k] 12% Axial
1.50	1.0	3	-	3	-
1.50	1.50	3	3	3	3
1.50	2.0	3	-	3	-

Note: All specimens were 0.250 inch thick.

Table VI. Test Matrix for Modified IITRI Tests.

Dimensions		Material Systems			
Width	Length	[0 30k/±70 6k] 46% Axial	[0 75k/±70 15k] 46% Axial	[0 36k/±45 15k] 46% Axial	[0 6k/±45 15k] 12% Axial
1.50	1.0	3	-	3	-
1.50	1.50	3	3	3	3
1.50	2.0	3	-	3	-

Note: All specimens listed were 0.250 inch thick.

An additional set of 1.50 inch x 1.0 inch x 0.125 inch specimens were tested for each material system.

Tables VII and VIII list the compression moduli measured during these tests. They indicate that the Modified IITRI specimens had higher moduli, by an average of 9%, in five of the six cases in which their data could be compared with the results obtained with the Short Block specimen. This is illustrated graphically in Figure 12, which plots the moduli of all four braid architectures. These results were obtained using 1.5 inch wide, 0.25 inch thick specimens with a 1.5 inch gage section. The one exception in which the Short Block Specimen had a higher modulus (by 7.5%) is shown in the figure.

The tables also indicate that there was very little scatter in the data. The average coefficient of variation (CoV) of all the NASA Short Block data was 3.8%; the Modified IITRI specimens had an average CoV of 2.6%. The scatter in these data is comparable to the CoVs that were measured for these 0.500 inch gages in the strain gage size sensitivity study (Ref. 11) that was conducted as a part of this effort to develop test methods for textile composites.

Table VII. NASA Short Block Test Results: Modulus.

Dimensions		Compression Modulus (MSI)			
Width	Length	[0 30k/±70 6k] 46% Axial	[0 75k/±70 15k] 46% Axial	[0 36k/±45 15k] 46% Axial	[0 6k/±45 15k] 12% Axial
1.50	1.0	No Data	-	No Data	-
1.50	1.50	8.42 ± 0.14 (1.7%)	7.91 ± 0.21 (2.6%)	8.90 ± 0.19 (2.0%)	4.05 ± 0.33 (8.0%)
1.50	2.0	7.67 ± 0.57 (7.4%)	-	8.31 ± 0.08 (1.0%)	-

Note: Coefficients of Variation are shown in ().

Table VIII. Modified IITRI Test Results: Modulus.

Dimensions		Compression Modulus (MSI)			
Width	Length	[0 30k/±70 6k] 46% Axial	[0 75k/±70 15k] 46% Axial	[0 36k/±45 15k] 46% Axial	[0 6k/±45 15k] 12% Axial
0.250 inch Thick Specimens					
1.50	1.0	8.67 ± 0.13 (1.5%)	-	8.50	-
1.50	1.50	8.64 ± 0.2 (2.3%)	8.31 ± 0.14 (1.7%)	8.28 ± 0.3 (3.6%)	4.59 ± 0.11 (2.4%)
1.50	2.0	8.94 ± 0.10 (1.1%)	-	9.04 ± 0.5 (5.5%)	-
0.125 inch Thick Specimens					
1.50	1.0	8.79 ± 0.17 (1.9%)	8.44 ± 0.9 (10.7%)	9.32 ± 1.0 (10.7%)	4.43 ± 0.2 (4.5%)

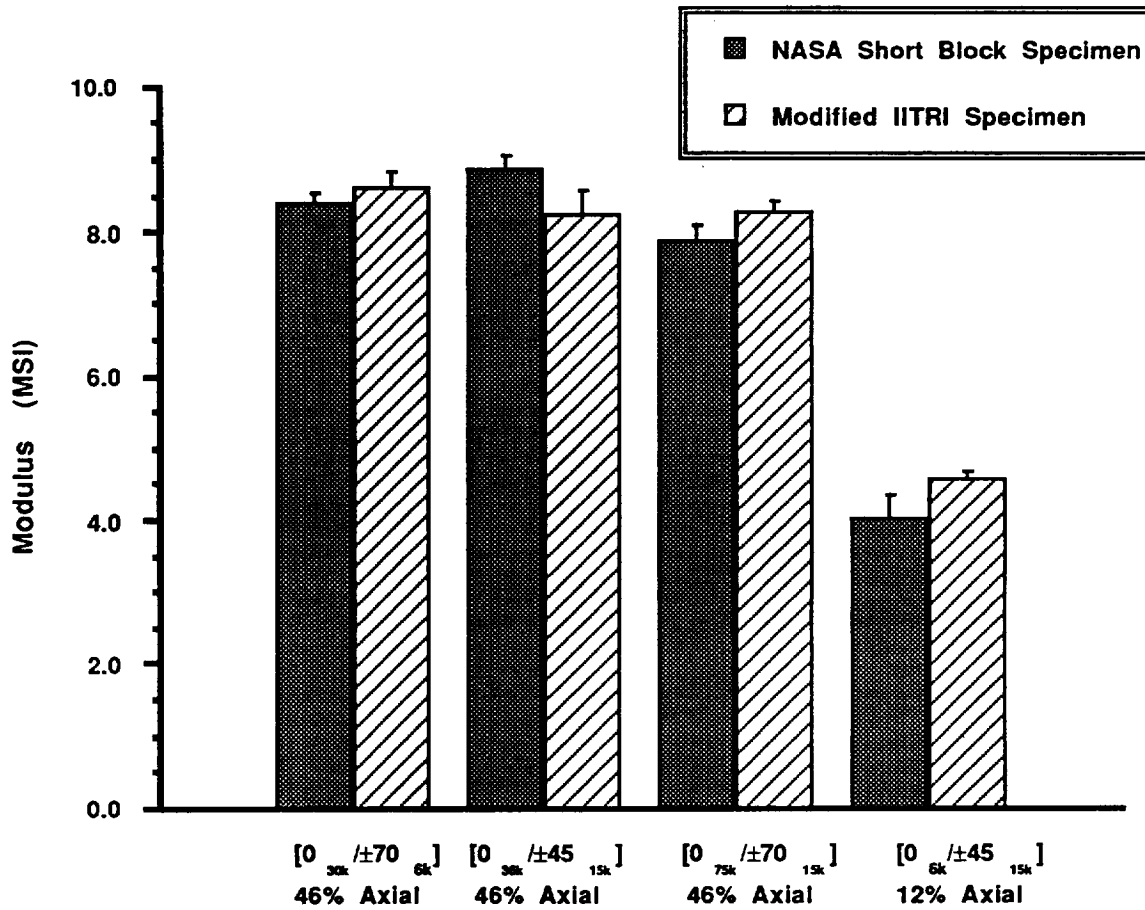

Figure 12. A Comparison of Modulus Measurements Made Using the Short Block and Modified IITRI Tests.

The compression strengths measured during these tests are summarized in Tables IX and X. In contrast to the moduli measurements listed in Tables VII and VIII, the Short Block specimen yielded higher strengths than the Modified IITRI specimen in all but one case. The Short Block specimens' strengths were on average 19% higher than the Modified IITRI specimens' strengths. These differences were quite pronounced in some cases. This is evident in Figure 13, which plots the results obtained for 1.5 inch wide, 0.25 inch thick specimens with a 1.5 inch gage section. The figure illustrates the large differences, 41%, in the compression strengths of the [075k/±7015k] 46% specimens. The error bars seen in the figure provide a measure of the scatter in the individual data sets. The two test methods were comparable by this measure. The Modified IITRI test results had an average CoV of 8.4%; the Short Block tests' was 6.8%.

Table IX. NASA Short Block Test Results: Strength.

Dimensions		Compression Strength (KSI)			
Width	Length	[0 30k/±70 6k] 46% Axial	[0 75k/±70 15k] 46% Axial	[0 36k/±45 15k] 46% Axial	[0 6k/±45 15k] 12% Axial
1.50	1.0	79.2 ± 1.7 (2.1%)	-	78.1 ± 4.0 (5.1%)	-
1.50	1.50	76.9 ± 3.4 (4.4%)	61.9 ± 4.5 (7.3%)	64.1 ± 4.8 (7.5%)	46.1 ± 0.6 (1.3%)
1.50	2.0	71.5 ± 7.6 (10.6%)	-	57.4 ± 9.1 (15.9%)	-

Note: Coefficients of Variation are shown in ().

Table X. Modified ITRI Test Results: Strength.

Dimensions		Compression Strength (KSI)			
Width	Length	[0 30k/±70 6k] 46% Axial	[0 75k/±70 15k] 46% Axial	[0 36k/±45 15k] 46% Axial	[0 6k/±45 15k] 12% Axial
0.250 inch Thick Specimens					
1.50	1.0	67.6 ± 6.8 (10.1%)	-	58.6	-
1.50	1.50	71.2 ± 0.06 (0.1%)	44.0 ± 4.7 (10.7%)	54.8 ± 1.9 (3.5%)	44.1 ± 0.06 (0.1%)
1.50	2.0	62.9 ± 16.1 (25.6%)	-	62.8 ± 5.5 (8.8%)	-
0.125 inch Thick Specimens					
1.50	1.0	67.1 ± 1.6 (2.4%)	51.7 ± 10.0 (19.3%)	62.8 ± 3.1 (5.0%)	49.1 ± 2.2 (4.5%)

Note: Coefficients of Variation are shown in ().

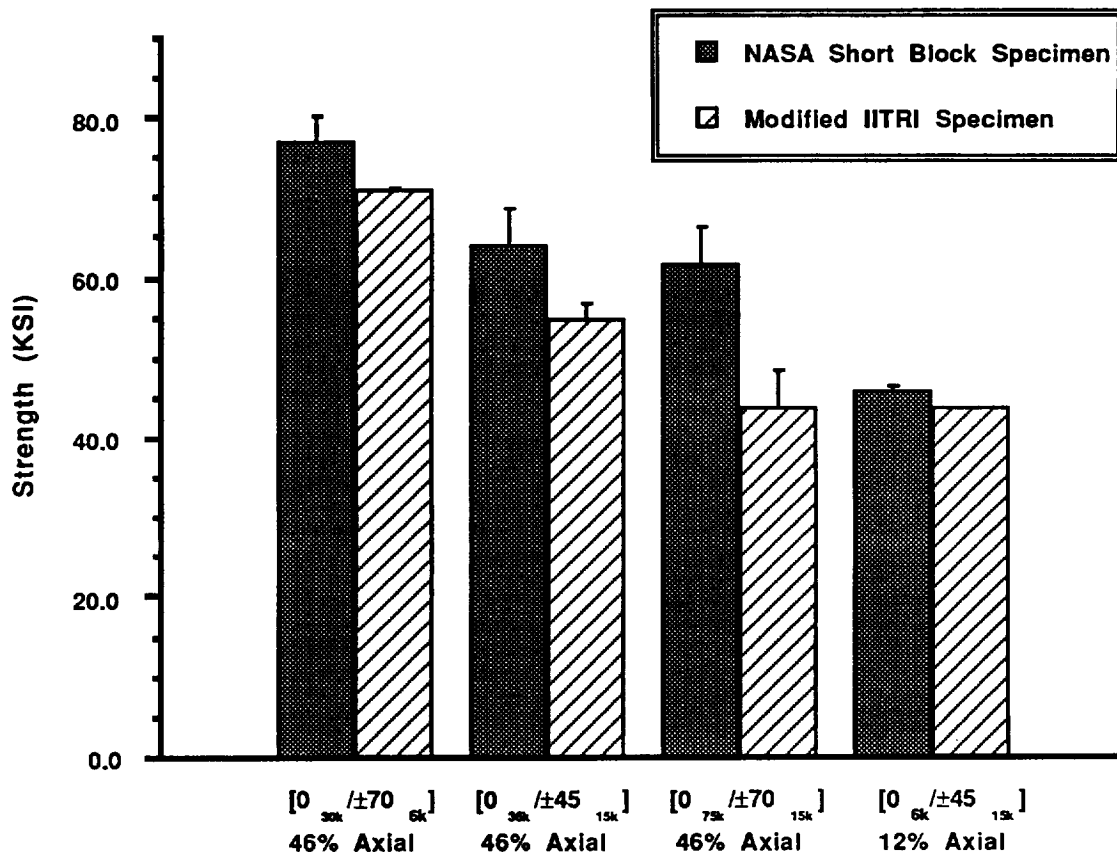

Figure 13. A Comparison of Strength Measurements Made Using the Short Block and Modified IITRI Tests.

As the test matrix indicated, a series of tests was also conducted to measure the sensitivity of these two test specimen geometries to changes in gage length. A series of [030k/±706k] 46% and [036k/±4515k] 46% specimens with 1.0 inch, 1.5 inch, and 2.0 inch gage lengths were tested (See Tables IX and X). It is difficult to accurately define trends in the data given the limited number of replicate tests and the observation that the scatter in all the data increased as the gage length increased. The data indicate, however, that the Modified IITRI specimen seems less sensitive to changes in gage length than the Short Block specimen. The former's moduli actually showed a slight, 5%, increase with increasing gage length. The Short Block specimens registered slightly larger, 8%, decreases in modulus. The strengths of the Short Block specimens also showed greater sensitivity to changes in gage length. The [030k/±706k] 46% specimens' strengths decreased by 10% and the [036k/±4515k] 46%

specimens' strengths decreased by 27% in the Short Block tests as gage length increased to 2.0 inch. The Modified IITRI test results, by comparison, showed a 7% decrease and a 7% increase, respectively, as the [030k/±706k] 46% and the [036k/±4515k] 46% specimens' gage lengths increased over the same ranges.

A comparison of the Short Block and the Modified IITRI data also gives an indication of the effects of end constraint and loading mode. The Short Block method lightly clamps the specimen over 0.30 inch length and features end loading. The Modified IITRI clamps a much larger section of its specimen (2.50 inches). Load is transferred to this specimen through shear loading. The data indicate that the Modified IITRI specimens averaged 9% higher moduli than their Short Block counterparts. On the other hand, the Short Block specimens' strengths were 20% higher. Comparable scatter was seen in both methods' moduli and strength results.

One set of Modified IITRI tests was conducted using 0.125 inch thick specimens to measure the sensitivity of this method to specimen thickness. A 1.0 inch gage length was selected for these tests. The results of these tests are also included in Tables VIII and X. The tabulated results indicate that the 0.125 inch thick specimens had moduli and strengths that were comparable to the 0.250 inch thick specimens for all four braids. Minguet (Ref. 2) noted, however, that an examination of the strain data obtained using back-to-back gages indicated that the 0.125 inch thick specimens exhibited non-linearity indicative of a stability problem. His observations indicate that, despite the short gage length, this method may not be viable when thin specimens are tested.

Boeing Open Hole Compression and Zabora Tests

Boeing Open Hole Compression and Zabora test methods have been grouped together for discussion since both feature long, thin specimens that are supported along their entire length to prevent buckling. In fact, Boeing used identical, 1.5 inch wide, 12.0 inch long, specimens in their evaluations of each method. Although they are quiet similar, the two test fixtures used in these tests support the specimens in different manners. Both fixtures feature cut-out sections. However, the cut-out in the Zabora fixture is three times longer than the cut-out in the Boeing OHC fixture. The test fixtures also differ in the manner in which they support the specimens in

sections away from the cut-outs. The Boeing OHC test fixture provides contact support over the entire specimen face. The Zabora fixture contacts the specimen edges only; a shallow step machined into the fixture leaves the 0.800 inch wide center section unsupported.

Table XI lists the test matrix used to evaluate these test methods. Samples of all four braids were tested. However, unlike the Short Block and Modified IITRI tests, the sensitivity of the test methods to changes in specimen geometry was not addressed. Only one specimen configuration was evaluated.

Table XI. Test Matrix for Boeing OHC and Zabora Tests.

Dimensions		Material Systems			
Width	Length	[0 30k/±70 6k] 46% Axial	[0 75k/±70 15k] 46% Axial	[0 36k/±45 15k] 46% Axial	[0 6k/±45 15k] 12% Axial
Boeing OHC					
1.5	12.0	3	3	3	3
Zabora					
1.5	12.0	3	3	3	3

Note: All specimens listed were 0.125 inch thick.

The results of these evaluations are contained in Tables XII and XIII. They are also graphically illustrated in Figures 14 and 15.

Table XII. Boeing OHC and Zabora Test Results: Modulus.

Test Method	Compression Modulus (MSI)			
	[0 30k/±70 6k] 46% Axial	[0 75k/±70 15k] 46% Axial	[0 36k/±45 15k] 46% Axial	[0 6k/±45 15k] 12% Axial
Boeing OHC	9.21 ± 0.09 (1.0%)	11.7 ± 5.8 (50%)	10.2 ± 0.24 (2.4%)	4.57 ± 0.06 (1.3%)
Zabora	9.20 ± 0.41 (4.4%)	8.63 ± 0.26 (3.0%)	10.56 ± 0.4 (3.8%)	4.92 ± 0.10 (2.0%)

Table XIII. Boeing OHC and Zabora Test Results: Strength.

Test Method	Compression Strength (KSI)			
	[0 30k/±70 6k] 46% Axial	[0 75k/±70 15k] 46% Axial	[0 36k/±45 15k] 46% Axial	[0 6k/±45 15k] 12% Axial
Boeing OHC	102.9 ± 26.0 (25.3%)	77.0 ± 35.3 (45.8%)	59.2 ± 3.4 (5.7%)	41.7 ± 0.6 (1.3%)
Zabora	85.9 ± 11.3 (13.2%)	64.3 ± 3.8 (5.9%)	67.7 ± 4.2 (6.2%)	46.9 ± 2.0 (4.3%)

The data indicate that, with the exception of one set of results, the scatter in the modulus measurements was, again, quite low. The Zabora specimens had an average CoV of 3%. The moduli measured for the [030k/±706k] 46% Axial, [036k/±4515k] 46% Axial, and [06k/±4515k] 12% Axial specimens using the Boeing OHC test method had an average CoV of 1.5%. The exception was the results obtained for the [075k/±7015k] 46% Axial material; they had a CoV of 50%. The large scatter in these measurements can be traced to a single test in which a modulus of 18 MSI was recorded. This was more than twice the modulus measured in the other two tests in the series; they averaged 8.4 MSI.

The two methods recorded comparable average moduli for each of the braids tested if the suspect [075k/±7015k] 46% Axial data are not considered. The moduli measured by the two methods differed by an average of only 3.5%, which is comparable to the scatter in that data.

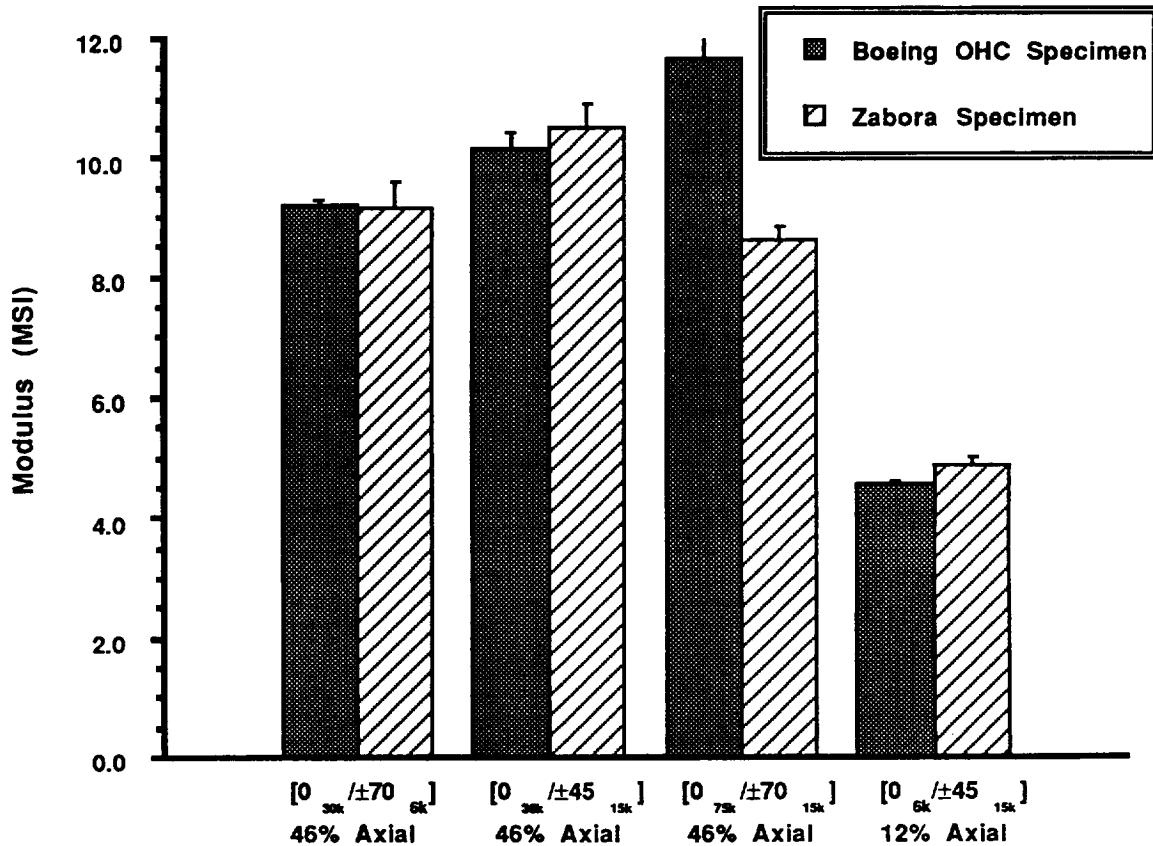

Figure 14. A Comparison of Modulus Measurements Made Using the Boeing OHC and Zabora Test Methods.

The results of the compression strength measurements are shown in Figure 15. An analysis of the data indicates that the Zabora tests yielded higher strengths (by an average of 13%) for both the [0_{36k}/±45_{15k}] 46% Axial and [0_{6k}/±45_{15k}] 12% Axial material. The two methods recorded comparable strengths for the [0_{75k}/±70_{15k}] 46% Axial braids if the suspect Boeing OHC data are, again, not considered. The Boeing OHC fixture yielded a higher strength for the [0_{30k}/±70_{6k}] 46% Axial specimens, 102.9 versus 85.9 KSI. However, the scatter in the Boeing OHC measurements for this architecture was nearly twice as great as the scatter in the Zabora measurements, 25% versus 13%.

It is difficult to establish a clear pattern from these results. However, it may be stated that, although the strengths obtained using the Zabora fixture were only slightly higher than those

obtained using the Boeing OHC fixture, the reproducibility of the data was greater with the former than the latter. The Boeing OHC tests had an average CoV of 11% if the [0_{30k}/±70_{15k}] 46% Axial data is not considered, the average CoV is 19.5% if it is considered. The Zabora test results had an average CoV of 7.4%.

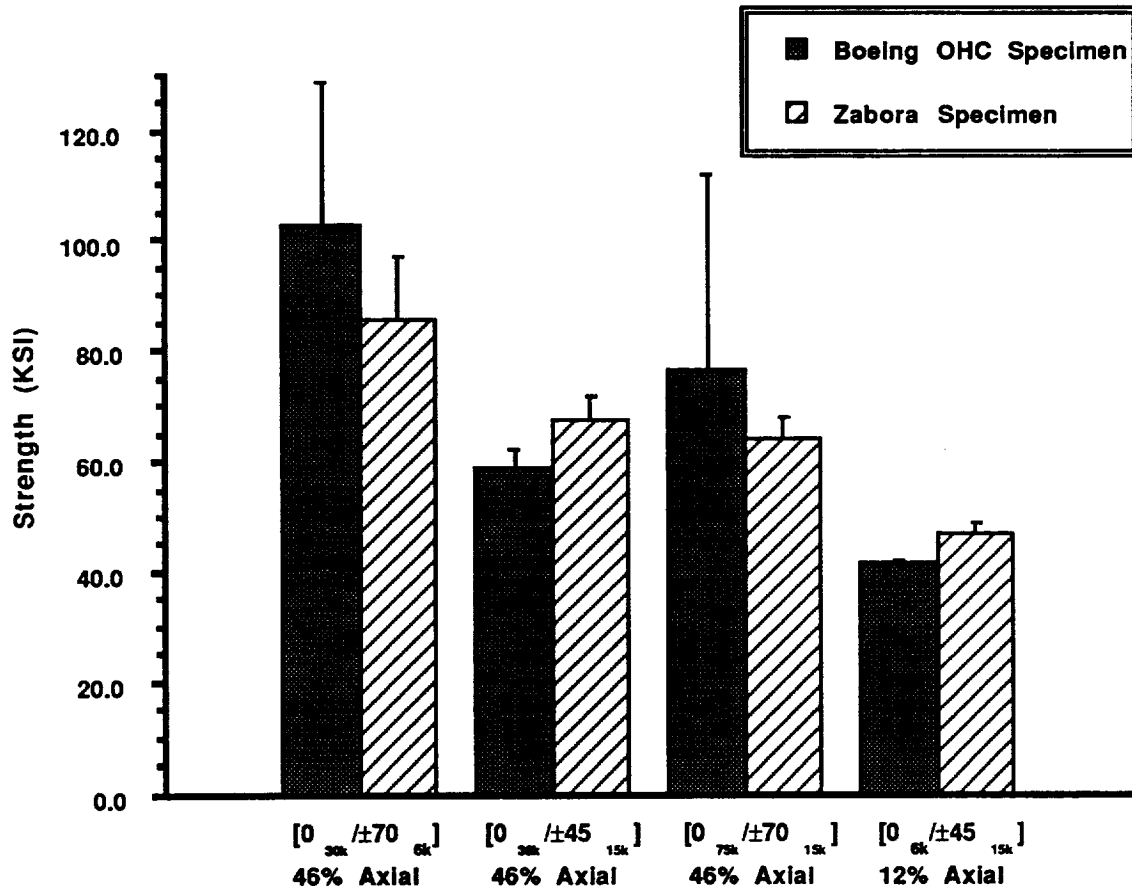

Figure 15. A Comparison of Strength Measurements Made Using the Boeing OHC and Zabora Test Methods.

Boeing Compression after Impact and NASA ST-4 Tests

Although the Boeing Compression after Impact (CAI) test was originally designed to measure damage tolerance and the NASA ST-4 test was originally used to measure the open hole compression strength, they employ identical test fixtures. As in the Boeing OHC and the Zabora fixtures, the test specimens are fully supported along

their lengths to prevent buckling. However, unlike the two previous test methods, the specimens are only supported along their edges in these tests. Both tests employ knife edge fixtures that clamp onto the specimens about 0.50 inch in from their edges. The two methods differ only in the sizes of the specimens used. The Boeing CAI specimen is 4.0 inch wide and 6.0 inch long; ST-4 specimen is 5.0 inch wide and 10.0 inch long.

The test matrix used to evaluate these methods is given in Table XIV. It indicates that, like the Boeing OHC and Zabora tests, data were gathered for all four 2-D braids. It also indicates that, again like the Boeing OHC and Zabora tests, the sensitivity of the test methods to changes in specimen geometry was not addressed. Only one specimen configuration was evaluated for each method and all specimens were 0.250 inches thick.

Table XIV. Test Matrix for Boeing CAI and NASA ST-4 Tests.

Dimensions		Material Systems			
Width	Length	[0 30k/±70 6k] 46% Axial	[0 75k/±70 15k] 46% Axial	[0 36k/±45 15k] 46% Axial	[0 6k/±45 15k] 12% Axial
Boeing CAI 4.0	6.0	3	3	3	3
NASA ST-4 5.0	10.0	3	3	3	3

The results of the elastic measurements are listed in Table XV; Table XVI lists the strength measurement results.

Table XV. Boeing CAI and NASA ST-4 Test Results: Modulus.

Test Method	Compression Modulus (MSI)			
	[0 30k/±70 6k] 46% Axial	[0 75k/±70 15k] 46% Axial	[0 36k/±45 15k] 46% Axial	[0 6k/±45 15k] 12% Axial
Boeing CAI	9.11 ± 0.09 (1.0%)	8.66 ± 0.28 (3.2%)	9.48 ± 0.4 (4.0%)	4.35 ± 0.13 (3.0%)
NASA ST-4	9.46 ± 0.32 (3.4%)	8.37 ± 0.27 (3.2%)	9.18 ± 0.6 (6.5%)	4.74 ± 0.05 (1.0%)

Table XVI. Boeing CAI and NASA ST-4 Test Results: Strength.

Test Method	Compression Strength (KSI)			
	[0 30k/±70 6k] 46% Axial	[0 75k/±70 15k] 46% Axial	[0 36k/±45 15k] 46% Axial	[0 6k/±45 15k] 12% Axial
Boeing CAI	63.2 ± 4.4 (7.0%)	56.0 ± 1.7 (3.0%)	56.8 ± 2.9 (5.1%)	43.0 ± 0.6 (1.4%)
NASA ST-4	44.6 ± 1.6 (3.6%)	43.4 ± 1.8 (4.1%)	47.0 ± 1.0 (2.1%)	43.2 ± 3.1 (7.2%)

There was little difference in the moduli measured by the two methods. As Figure 16 demonstrates, the Boeing CAI method yielded higher values for the [036k/±4515k] 46% Axial and the [075k/±7015k] 46% Axial material; the ST-4 method recorded higher moduli for the [030k/±706k] 46% Axial and the [06k/±4515k] 12% Axial specimens. The average difference in these measurements was 5%. The scatter in all these measurements was also quite low. The Boeing CAI measurements had an average CoV of 3%; the ST-4 tests averaged 3.5%.

Although the two methods yielded comparable results in the modulus measurements, there was a decided difference in their strength results. As the data in Figure 17 demonstrates, the Boeing CAI test method yielded substantially higher strengths (by an average of 23 %) for three of the four braids tested. The two methods yielded comparable results for the [06k/±4515k] 12% Axial material only. This decrease in strength is assumed to be indicative of buckling instability in the 10.0 inch long ST-4 specimens despite the edge supports.

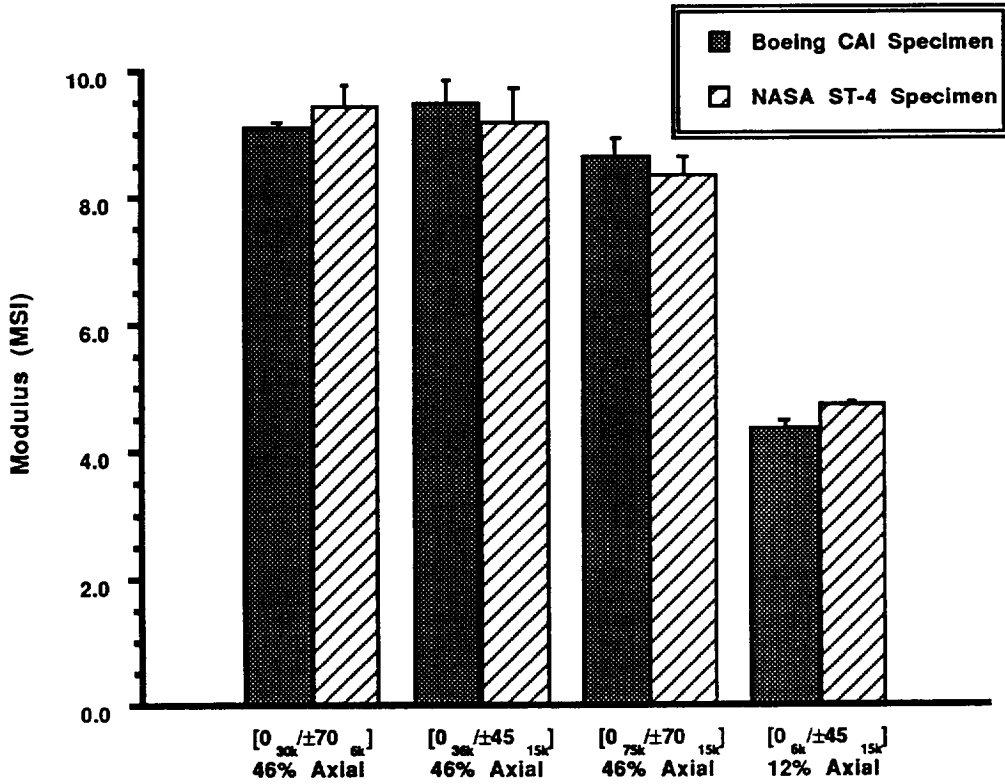

Figure 16. Boeing CAI and NASA ST-4 Moduli Measurements.

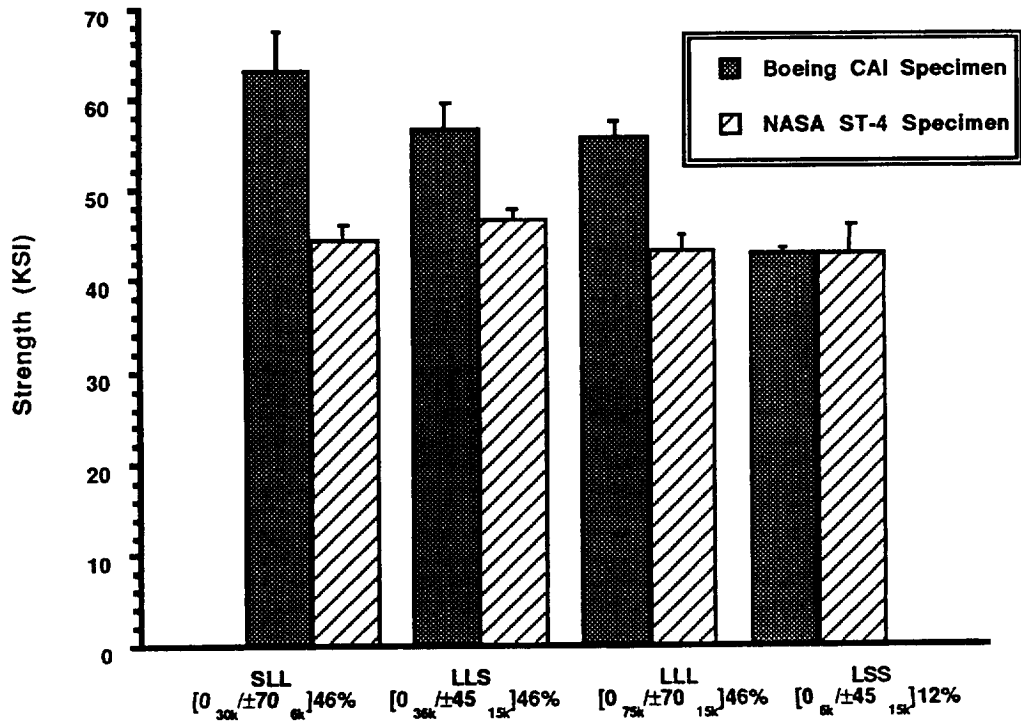

Figure 17. Boeing CAI and NASA ST-4 Strength Measurements.

Sandwich Column Tests

The final test method investigated by Boeing was the Sandwich Column Test illustrated in Figure 10. The test matrix employed in this investigation is given in Table XVII. It demonstrates that the investigators conducted an extensive evaluation of the effects of the specimen width and length on modulus and strength.

Table XVII. Test Matrix for Sandwich Column Tests.

Dimensions		Material Systems			
Width	Length	[0 30k/±70 6k] 46% Axial	[0 75k/±70 15k] 46% Axial	[0 36k/±45 15k] 46% Axial	[0 6k/±45 15k] 12% Axial
1.50	6.0	3	-	3	-
2.25	6.0	3	-	3	-
3.0	6.0	3	3	3	3
3.0	2.0	3	-	3	-
3.0	8.0	3	-	3	-

Note: All composite face sheets had a nominal thickness of 0.0625 inch.

The results of the modulus measurements are summarized in Table XVIII; the strength results are listed in Table XIX. Minguet (Ref. 2) noted two difficulties in evaluating these specimens. Boeing was unable to determine the textile composite face sheet's fiber volume fraction because the specimens were delivered as a completed sandwich. This made comparison of the data with the results attained from previous tests difficult. The second problem was far more serious. All the specimens failed by separation of the face sheet from the core due to either core failure or to failure of the core-laminate bond. The latter problem negates the compression strength test results. A review of the results listed in Table XIX affirm this observation. The strengths recorded using this technique were significantly lower than those measured using any of the other methods previously reviewed. A review of the moduli listed in Table XVIII also raises questions about the specimen performance in the elastic range. These values were lower than the results obtained

using the other methods for three of the four materials tested. In the fourth case, the modulus measured for the [036k/±45 15k] 46% Axial material was significantly larger than the moduli measured using the other six test techniques.

Table XVIII. Sandwich Column Test Results: Modulus.

Dimensions		Compression Modulus (MSI)			
Width	Length	[0 30k/±70 6k] 46% Axial	[0 75k/±70 15k] 46% Axial	[0 36k/±45 15k] 46% Axial	[0 6k/±45 15k] 12% Axial
1.50	6.0	7.56 ± 0.11 (1.5%)	-	11.2 ± 0.24 (2.1%)	-
2.25	6.0	7.49 ± 0.21 (2.8%)	-	11.4 ± 0.18 (1.6%)	-
3.0	6.0	7.48 ± 0.09 (1.2%)	5.5 ± 0.17 (3.1%)	11.0 ± 0.3 (2.7%)	3.43 ± 0.04 (1.2%)
3.0	2.0	7.87 ± 0.26 (3.3%)	-	11.0 ± 0.14 (1.3%)	-
3.0	8.0	7.97 ± 0.21 (2.6%)	-	11.4 ± 0.2 (1.8%)	-

Table XIX. Sandwich Column Test Results: Strength.

Dimensions		Compression Strength (KSI)			
Width	Length	[0 30k/±70 6k] 46% Axial	[0 75k/±70 15k] 46% Axial	[0 36k/±45 15k] 46% Axial	[0 6k/±45 15k] 12% Axial
1.50	6.0	28.1 ± 0.7 (2.5%)	-	34.7 ± 1.9 (5.5%)	-
2.25	6.0	28.5 ± 2.1 (7.4%)	-	35.7 ± 1.0 (2.8%)	-
3.0	6.0	27.2 ± 3.0 (11.0%)	16.3 ± 1.1 (6.7%)	33.5 ± 1.0 (3.0%)	16.7 ± 0.2 (1.2%)
3.0	2.0	30.4 ± 2.5 (8.2%)	-	36.5 ± 0.8 (2.2%)	-
3.0	8.0	26.2 ± 2.7 (10.3%)	-	34.4 ± 2.7 (7.8%)	-

Boeing Test Results - 3-D Woven Material

Boeing used only the Modified IITRI and the NASA Short Block test methods to measure the properties of the 3-D woven materials. All specimens tested were 1.5 inches wide and 0.250 inches thick. Their test sections were 1.5 inches long. Table XX lists the test matrix used for these tests.

Table XX. Test Matrix for 3-D Woven Material Tests.

Dimensions		Material Systems					
Width	Length	OS - 1	OS - 2	TS - 1	TS - 2	LS - 1	LS - 2
NASA Short Block							
1.5	1.5	3	3	3	3	3	3
Modified IITRI							
1.5	1.5	3	3	3	3	3	3

The results of these tests are given in Tables XXI through XXIII. The longitudinal moduli and strengths are listed in Tables XXI and XXII; the materials' transverse properties are listed in Table XXIII.

The data indicate that, as in the case of the 2-D triaxial braids, the Modified IITRI tests yielded higher modulus measurements than the Short Block tests. The differences in the moduli measured by the two methods was less pronounced for these materials, however. The moduli measured using the Modified IITRI specimens were only 3% higher than those measured using the Short Block technique. The strength data listed in Table XXII indicate that the Short Block method gave higher strengths for all six woven materials. Their strengths were, on average, 11% greater than those of the Modified IITRI specimens. The same trend was noted in the 2-D braided materials' test results. However, as in the modulus measurements, the difference between the two methods was less pronounced for the woven materials.

Table XXI. 3-D Woven Material Test Results: Longitudinal Modulus.

Test Method	Compression Modulus (MSI)					
	OS - 1	OS - 2	TS - 1	TS - 2	LS - 1	LS - 2
NASA Short Block	10.58 ± 0.18 (1.7%)	10.61 ± 0.69 (6.5%)	10.62 ± 0.30 (2.8%)	10.28 ± 0.04 (0.4%)	11.09 ± 0.22 (2.0%)	10.67 ± 0.33 (3.1%)
Modified IITRI	10.61 ± 0.16 (1.5%)	10.31 ± 0.09 (1.0%)	10.62 ± 0.22 (2.1%)	10.64 ± 0.16 (1.5%)	11.39 ± 0.11 (1.0%)	11.00 ± 0.20 (1.8%)

Table XXII. 3-D Woven Material Test Results: Longitudinal Strength.

Test Method	Compression Strength (KSI)					
	OS - 1	OS - 2	TS - 1	TS - 2	LS - 1	LS - 2
NASA Short Block	83.7 ± 2.9 (3.4%)	92.2 ± 5.3 (5.7%)	76.1 ± 1.1 (1.4%)	71.5 ± 2.9 (4.1%)	80.5 ± 4.6 (5.7%)	78.1 ± 6.0 (7.7%)
Modified IITRI	81.5 ± 4.4 (5.4%)	78.4 ± 6.1 (7.8%)	74.1 ± 4.9 (6.6%)	65.5 ± 1.0 (1.5%)	76.3 ± 2.8 (3.7%)	62.2 ± 0.5 (1.0%)

Table XXIII. 3-D Woven Material Test Results: Transverse Modulus and Strength.

Property	Material Systems					
	OS - 1	OS - 2	TS - 1	TS - 2	LS - 1	LS - 2
Modulus (MSI)	6.07 ± 0.14 (2.3%)	5.96 ± 0.04 (0.7%)	5.82 ± 0.10 (1.7%)	6.98 ± 0.14 (2.0%)	6.12 ± 0.09 (1.5%)	6.26 ± 0.003 (0.1%)
Strength (KSI)	41.0 ± 1.1 (2.8%)	52.8 ± 0.6 (1.2%)	37.4 ± 2.0 (5.4%)	50.8 ± 2.0 (3.9%)	32.3 ± 4.7 (14.4%)	27.3 ± 5.6 (20.5%)

Boeing Test Results - Stitched Uniwoven Material

Table XXIV lists the test matrix used to evaluate the stitched materials. As in the case of the 3-D woven materials, Boeing employed only the Modified IITRI and the Short Block methods in this study. The specimen gage length was again fixed at 1.5 inch. All the specimens were 1.5 inch wide and 0.25 inch thick.

Table XXIV. Test Matrix for Stitched Laminate Tests.

Dimensions		Material Systems				
Width	Length	SU - 1	SU - 2	SU - 3	SU - 4	SU - 5
NASA Short Block 1.5	1.5	3	3	3	3	3
NASA Short Block 1.5	1.5	3	3	3	3	3

The moduli and strengths measured in these tests are listed in Tables XXV and XXVI, respectively. The performances of the two test methods on the stitched materials were comparable to their performances on the braided and woven materials. The Modified IITRI method registered the higher moduli in all five stitched systems evaluated. The average difference in this case was 5%. This was comparable to the difference measured for the woven systems but slightly less than the improvements seen in the braided systems. The Short Block method again yielded the higher strengths. The average difference in strength was 12% in this case. This was, again, comparable to the increase seen in the woven materials but less than the difference measured for the braided materials.

Table XXV. Stitched Laminate Test Results: Longitudinal Modulus.

Test Method	Compression Modulus (MSI)				
	SU - 1	SU - 2	SU - 3	SU - 4	SU - 5
NASA Short Block	5.79 ± 0.24 (4.1%)	5.88 ± 0.05 (1.0%)	6.10 ± 0.14 (2.3%)	6.22 ± 0.09 (1.4%)	5.81 ± 0.10 (1.7%)
Modified IITRI	6.33 ± 0.07 (1.1%)	6.11 ± 0.06 (1.0%)	6.37 ± 0.10 (1.6%)	6.44 ± 0.04 (0.6%)	6.04 ± 0.02 (0.3%)

Table XXVI. Stitched Laminate Test Results: Longitudinal Strength.

Test Method	Compression Strength (KSI)				
	SU - 1	SU - 2	SU - 3	SU - 4	SU - 5
NASA Short Block	56.3 ± 2.1 (3.7%)	51.5 ± 1.9 (3.7%)	53.9 ± 0.9 (1.7%)	53.1 ± 1.1 (2.0%)	52.6 ± 2.3 (4.4%)
Modified IITRI	52.1 ± 0.9 (1.7%)	45.3 ± 0.5 (1.2%)	47.6 ± 2.0 (4.1%)	48.1 ± 0.9 (1.9%)	45.6 ± 0.5 (1.2%)

A series of Modified IITRI tests was also conducted on each architecture to determine its transverse compression properties. The specimen dimensions listed in Table XXIV were used in these tests. The results of these tests are listed in Table XXVII.

Table XXVII. Stitched Laminate Results: Transverse Modulus and Strength.

Property	Material Systems				
	SU - 1	SU - 2	SU - 3	SU - 4	SU - 5
Modulus (MSI)	6.35 ± 0.15 (2.4%)	6.21 ± 0.05 (1.0%)	6.49 ± 0.11 (1.7%)	6.61 ± 0.05 (1.0%)	6.64 ± 0.05 (1.0%)
Strength (KSI)	55.1 ± 2.3 (4.2%)	51.6 ± 0.5 (1.0%)	54.2 ± 2.2 (4.0%)	52.2 ± 1.4 (2.7%)	55.7 ± 1.1 (1.9%)

Lockheed Test Results

Tables XXVIII to XXX summarize the results of Lockheed's evaluations of the 2-D Braided, 3-D Braided, and 3-D Woven materials, respectively.

Table XXVIII. 2-D Braided Material Test Results: Lockheed

Property	2-D Braided Systems	
	[0 12k/±60 6k] 33% Axial	[0 24k/±60 6k] 50% Axial
Longitudinal Modulus (MSI)	7.13 ± 0.16 (2.3%)	9.87 ± 0.31 (3.1%)
Longitudinal Strength (KSI)	65.4 ± 5.3 (8.1%)	77.7 ± 2.0 (2.6%)
Transverse Modulus (MSI)	6.30 ± 0.09 (1.4%)	5.07 ± 0.13 (2.5%)
Transverse Strength (KSI)	49.0 ± 3.6 (7.4%)	40.4 ± 0.9 (2.2%)

Table XXIX. 3-D Braided Material Test Results: Lockheed

Property	3-D Braided Systems	
	[0 6k/±60 6k] 30 % Axial	[0 18k/±60 6k] 56% Axial
Longitudinal Modulus (MSI)	5.92 ± 0.36 (6.2%)	9.58 ± 0.21 (2.2%)
Longitudinal Strength (KSI)	71.1 ± 4.8 (6.7%)	71.8 ± 1.5 (2.1%)
Transverse Modulus (MSI)	5.22 ± 0.20 (3.9%)	3.66 ± 0.27 (7.4%)
Transverse Strength (KSI)	54.3 ± 2.3 (4.2%)	32.8 ± 0.2 (0.6%)

Table XXX. 3-D Woven Material Test Results: Lockheed

Property	3-D Woven Systems		
	TTT - 1	LTL - 1	LTL - 2
Longitudinal Modulus (MSI)	7.95 ± 0.2 (2.5%)	8.91 ± 0.18 (2.0%)	7.64 ± 0.16 (2.1%)
Longitudinal Strength (KSI)	75.1 ± 3.2 (4.2%)	81.6 ± 8.0 (9.8%)	71.9 ± 4.2 (5.9%)
Transverse Modulus (MSI)	7.94 ± 0.04 (0.5%)	8.13 ± 0.15 (1.8%)	8.67 ± 0.28 (3.2%)
Transverse Strength (KSI)	57.9 ± 1.3 (2.2 %)	53.7 ± 0.5 (1.0%)	55.3 ± 1.4 (2.6%)

A comparison of the 2-D and 3-D braid architectures indicates that all four systems were braided at $\pm 60^\circ$ and that their axial yarn contents were comparable. The former featured 33% and 50% axial yarns; the latter contained 30% and 56% axial yarns. Although they are not exactly equal, a comparison of their properties is reasonable.

The data indicate that the 2-D materials had higher longitudinal and transverse moduli than their 3-D counterparts. The data also show, however, that these 2-D and 3-D braids had comparable strengths.

Scatter in both sets of data was quite low. The average CoVs for the 2-D and 3-D materials' moduli measurements were 2.3% and 4.9%, respectively. Their strength measurements averaged 5.1% and 3.4%. The reproducibility of these results is comparable to those attained by Boeing using the Zabora Method, which featured a comparable test fixture. Unlike the method employed at Lockheed, however, the Zabora Method uses straight-sided specimens. By comparison, the moduli measured for the four 2-D braids using the Zabora test (Table XII) had an average CoV of 3.3%; the strength measurements (Table XIII) averaged 7.4%.

The results obtained for the three 3-D woven systems also showed little scatter. The moduli measurements had an average CoV of 2.0%; the strength results averaged 4.3%. A comparison of these results with those obtained using the Zabora fixture is not possible, however, since Boeing evaluated only 2-D braids with that method.

Summary and Conclusions

Compression test data developed by Boeing and Lockheed under ACT Program funding were reviewed in this report. Boeing was specifically funded to develop data on test methods for textile composites. They investigated seven separate test techniques. These results were the prime source of data used to identify a recommended test practice. The Lockheed investigation focused on developing material property data bases for a variety of textile composite materials. They used a single method to measure the materials' compression properties. Their results were used to supplement the Boeing test data. Although woven, braided, and stitched laminates were tested in both programs, Boeing primarily used braided specimens to assess the viability of the various methods and to establish specimen dimensions.

Compression test specimens have been divided into three categories: short, unsupported coupons, long coupons supported along their entire length, and laminates that feature sandwich construction to prevent buckling. All three types of specimen configurations were evaluated by Boeing. Lockheed used a long, tapered coupon and a test fixture that provided edge support along the length of the specimen in its evaluation.

A number of issues must be considered in choosing a compression test method. The effectiveness of the method in measuring the true material response is certainly the prime consideration. The test methods' ability to measure both the modulus and the strength will be used to select a test method. It is highly desirable that the same test method and specimen be used to establish both properties. The test methods will, therefore, be judged on their combined performance in making both measurements.

Two metrics, the magnitude of the modulus or strength measurement and the reproducibility of those measurements, will be used to judge the methods' effectiveness.

Investigators faced with a similar choice for tape materials have often chosen the method that yields the highest strength. This is based on the assumption that compression strength is a material property and not a structural property. If you assume that the material has an inherent, baseline strength then logic indicates that the method that yields the highest value is the best since it either measures the true material response or comes the closest of all the candidates. Stated another way, even an ideal test cannot yield a result greater than the material's inherent strength; a faulty test can, however, record a lower "strength."

The premise discussed above will also be applicable to the modulus measurements but to a lesser degree. These measures are performed in the linear elastic range. Buckling, a failure mode that would lower apparent strength, should not be a factor in these tests.

The approach taken in this report will be to choose the test method that consistently yields the highest modulus and strength provided it has acceptable reproducibility. Test methods with a CoV of 5% or lower will be judged acceptable.

The relative performances of the candidate test methods are illustrated in Figures 18 and 19. The moduli measured for each of the four 2-D triaxial braids are summarized in Figure 18; their strengths are plotted in Figures 19. Data from six of the seven methods evaluated are contained in the figures. As was noted earlier, the seventh method, the Sandwich Column Test Method, was ineffective and was not considered. The inch 1.50 by 1.50 inch by 0.250 inch NASA Short Block and Modified IITRI test results are plotted in the figures.

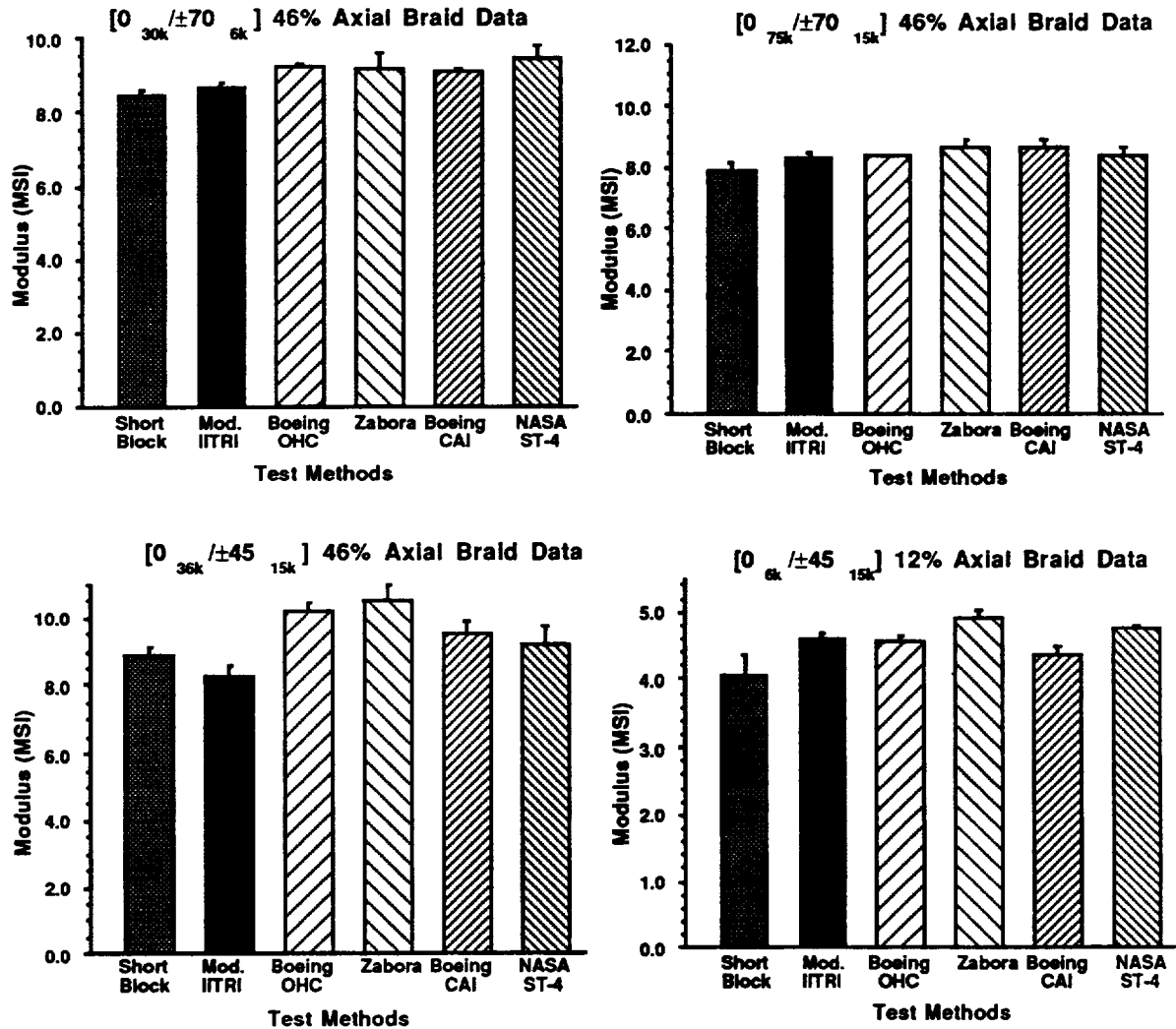

Figure 18. Comparison of Methods: Modulus Measurements.

A method-to-method comparison of the data in Figure 18 indicates that a range of moduli was recorded for each material. The differences between the low and the high moduli measured (expressed as a percentage of the low value) ranged from 9.5% for the [075k/±7015k] 46% Axial material to 27.5% for the [036k/±4515k] 46% Axial material. The average difference between the low and the high values measured was 18% for the four braids tested. The Zabora Method recorded the highest modulus for two of the four 2-D braids tested; it was the second highest in the two remaining cases. The test methods that featured short, unsupported test sections, the NASA Short Block and the Modified IITRI Test

Methods, consistently yielded the lowest values. The Short Block method recorded the lowest modulus in three of the four cases considered. The moduli measured using the Short Block Test were 15% (expressed as a percentage of the Short Block modulus) lower, on average, than the highest values measured.

An examination of the scatter in the data indicates that all the methods performed comparably well. The reproducibility of the measurements, i.e., the scatter in the moduli, made using each method was quite good. The CoV exceeded 5% in only two cases: the Short Block measurement of the [06k/±4515k] 12% Axial material (8%), and the NASA ST-4 measurement on the [036k/±4515k] 46% Axial material (6.5%).

The results of the strength measurements provide a more discernible basis with which to select a test method. The data in Figure 19 indicate that the overall range of the measurements increased significantly when compared method-to-method. The average difference between the low and the high values recorded for each material was almost 60% in the strength measurements compared to only 18% in the modulus measurements. A review of the data also indicates that there was more scatter in the individual strength measurements than in the modulus measurements. The CoVs exceeded 5% in almost half of the strength measurements.

An examination of the figure indicates that the Zabora Method again led the other methods. It was followed by the Boeing OHC and the Short Block Tests. The Zabora Method recorded the highest strength for three of the four braids tested. It was the second highest in the remaining case. The NASA ST-4 Method, by contrast, yielded the lowest strength in three of the four cases evaluated.

The Short Block Method, with an average CoV 5.1%, demonstrated the best reproducibility of the top three methods. It was followed by the Zabora and the Boeing OHC Methods. Their CoVs were 7.4% and 10.8%, respectively.

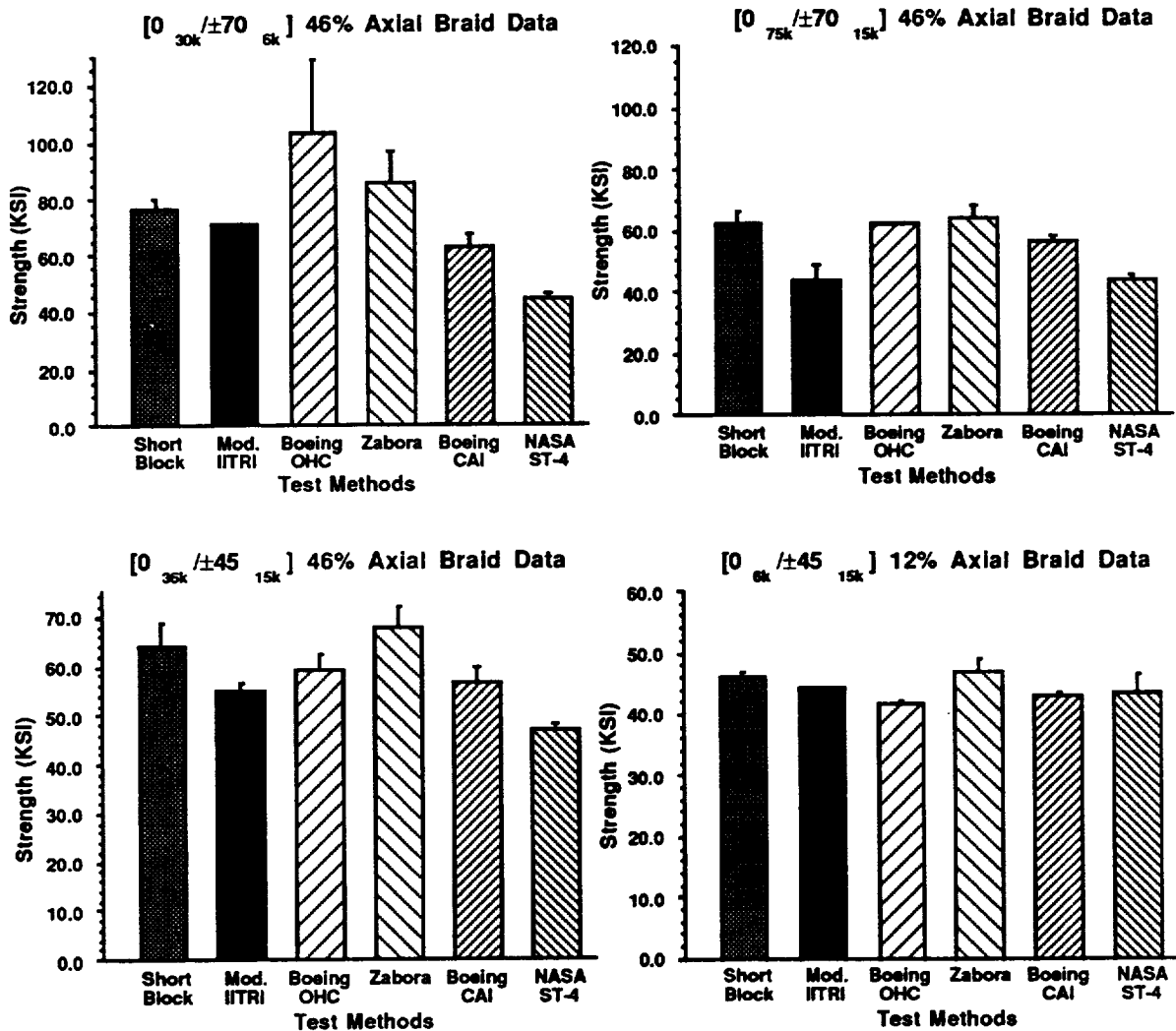

Figure 19. Comparison of Methods: Strength Measurements.

The Zabora Method demonstrated the best overall performance in both the modulus and the strength measurements. In most cases the highest modulus or strength was recorded using this method. It demonstrated low scatter in the modulus measurements and, although greater than 5%, reasonable scatter in the strength measurements. It is, therefore, recommended as the method to be used to characterize the compression strength of textile composites.

Along with its performance advantages, the Zabora Method has several other attractive features. The specimen used in the test is quite versatile; it can be used for both tension and open hole tension testing (Ref. 12, 13). In contrast to several of the other test methods, the Zabora Method can also be used effectively to measure properties

of thin materials. The specimens tested in this evaluation were 0.125 inch thick. The Short Block Method, by comparison, is limited to 0.250 inch specimens to avoid buckling.

The Zabora Method is similar to the test method employed at Lockheed. A comparison of the data developed by Boeing with the result obtained at Lockheed indicates that the tapered cross-section used in the latter's method may not be necessary. The average CoVs reported at Lockheed for 2-D braided materials were 2.3% for the modulus measurements and 5.1% for the strength measurements.

The Short Block and the Boeing OHC Methods also deserve strong consideration. However, the data reveal disadvantages to both methods.

The Short Block Method recorded the second highest strengths in three of the four cases tested. The strengths measured using this method were on average 5.7% lower than strength measured using the Zabora Method. The moduli recorded using this method were consistently much lower than those measured using the other methods, however. The Short Block specimen does offer one important advantage. Although it requires the use of a thicker specimen than the Zabora Method, the Short Block specimens require far less material overall since they are much shorter than the Zabora specimens. The Short Block Method may be used effectively in a materials development program when quantities of material are limited and relative moduli measurements are sufficient to assess trends in the data. The superior performance of the Zabora Method and the versatility of its test specimen, by comparison, make it more desirable for use in a program to determine design data.

In contrast to the Short Block Method, the Boeing OHC Method recorded consistently high moduli and strength values. Like the Zabora Method, it features a versatile specimen that can be used in both tension and compression tests. In addition, the test fixture used in this test is specified in a SACMA Recommended Test Method SRM 3R-94 and is being evaluated by ASTM for open hole compression testing. This is an advantage since the fixture is already in use in many test labs and is marketed commercially. The scatter in its strength data was, however, quite high. Boeing noted that abnormally high strength results were obtained in several cases. They attributed these results to friction or interference between the fixture and the specimen.

References

1. Naik, R. A., Ifju, P. G., and Masters, J. E., "Effect of Fiber Architecture Parameters on Deformation Fields and Elastic Moduli of 2-D Braided Composites," *Journal of Composite Materials*, Vol. 28, No. 7/1994, pp. 656 - 681.
2. Minguet, P. J., Fedro, M. J., and Gunther, C. K., "Test Methods for Textile Composites," NASA Contractor Report 4609, July, 1994.
3. Whitney, J. M., Daniel, I. M., and Pipes, R. B., Experimental Mechanics of Fiber Reinforced Composite Materials, The Society for Experimental Stress Analysis, Brookfield Center, CT, 1982, pp. 175 - 185.
4. Daniel, I. M. and Ishai, O., Engineering Mechanics of Composite Materials, Oxford University Press, New York, NY, 1994, pp. 316 - 321.
5. Adams, D. F., "Current Status of Compression Testing of Composite Materials," Proceedings 40th International SAMPE Symposium. May 1995, pp. 1831 - 1845
6. Shuart, M. J.: Failure of Compression-Loaded Multidirectional Composite Laminates. *AIAA Journal*, vol. 27, no. 9, September 1989, pp. 1274-1279.
7. Hofer, K. E., Rao, N., and Larsen, D., "Development of Engineering Data on Mechanical Properties of Advanced Composite Materials," Air Force Technical Report AFML-TR-72-205, Part I, Sept. 1972.
8. SACMA Recommended Test Method for Open-Hole Compression Properties of Oriented Fiber-Resin Composites, SRM 3R-94, Suppliers of Advanced Composites Materials Association, Arlington, VA, 1994.
9. SACMA Recommended Test Method for Compression After Impact Properties of Oriented Fiber-Resin Composites, SRM 2R-94, Suppliers of Advanced Composites Materials Association, Arlington, VA, 1994.

10. Standard Tests for Toughened Resin Composites, NASA Reference Publication 1092, NASA Langley Research Center, Hampton, VA, 1983.
11. Masters, J. E., Strain Gage Selection Criteria for Textile Composite Materials, NASA CR-198286, February 1996.
12. Portanova, M. A., Standard Methods for Unnotched Tension Testing of Textile Composites, NASA CR-198264, December 1995.
13. Portanova, M. A., Standard Methods for Open Hole Tension Testing of Textile Composites, NASA CR-198262, December 1995.

REPORT DOCUMENTATION PAGE

Form Approved
OMB No. 0704-0188

Public reporting burden for this collection of information is estimated to average 1 hour per response, including the time for reviewing instructions, searching existing data sources, gathering and maintaining the data needed, and completing and reviewing the collection of information. Send comments regarding this burden estimate or any other aspect of this collection of information, including suggestions for reducing the burden, to Washington Headquarters Services, Directorate for Information Operations and Reports, 1215 Jefferson Davis Highway, Suite 1204, Arlington, VA 22202-4302, and to the Office of Management and Budget, Paperwork Reduction Project (0704-0188), Washington, DC 20503.

1. AGENCY USE ONLY (Leave blank)	2. REPORT DATE February 1996	3. REPORT TYPE AND DATES COVERED Contractor Report	
4. TITLE AND SUBTITLE Compression Testing of Textile Composite Materials		5. FUNDING NUMBERS Contract NAS1-19000 WU 505-63-50-04	
6. AUTHOR(S) John E. Masters		8. PERFORMING ORGANIZATION REPORT NUMBER	
7. PERFORMING ORGANIZATION NAME(S) AND ADDRESS(ES) Lockheed Martin Engineering & Sciences 144 Research Drive Hampton, VA 23666		10. SPONSORING/MONITORING AGENCY REPORT NUMBER NASA CR-198285	
9. SPONSORING/MONITORING AGENCY NAME(S) AND ADDRESS(ES) National Aeronautics and Space Administration Langley Research Center Hampton, VA 23681-0001		11. SUPPLEMENTARY NOTES NASA Technical Monitor: I. S. Raju	
12a. DISTRIBUTION/AVAILABILITY STATEMENT Unclassified - Unlimited Subject Category 24		12b. DISTRIBUTION CODE	
13. ABSTRACT (<i>Maximum 200 words</i>) <p style="text-align: center;">The applicability of existing test methods, which were developed primarily for laminates made of unidirectional prepreg tape, to textile composites is an area of concern. The issue is whether the values measured for the 2-D and 3-D braided, woven, stitched, and knit materials are accurate representations of the true material response.</p> <p>This report provides a review of efforts to establish a compression test method for textile reinforced composite materials. Experimental data have been gathered from several sources and evaluated to assess the effectiveness of a variety of test methods. The effectiveness of the individual test methods to measure the material's modulus and strength is determined. Data are presented for 2-D triaxial braided, 3-D woven, and stitched graphite/epoxy material. However, the determination of a recommended test method and specimen dimensions is based, primarily, on experimental results obtained by the Boeing Defense and Space Group for 2-D triaxially braided materials. They evaluated seven test methods: NASA Short Block, Modified IITRI, Boeing Open Hole Compression, Zabora Compression, Boeing Compression after Impact, NASA ST-4, and a Sandwich Column Test.</p>			
14. SUBJECT TERMS Modulus, Strength, Compression, Braids, Short Block, Zabora, IITRI		15. NUMBER OF PAGES 52	16. PRICE CODE A04
17. SECURITY CLASSIFICATION OF REPORT Unclassified	18. SECURITY CLASSIFICATION OF THIS PAGE Unclassified	19. SECURITY CLASSIFICATION OF ABSTRACT	20. LIMITATION OF ABSTRACT



