

64577

NASA
Technical Memorandum 107202

Army Research Laboratory
Technical Report ARL-TR-1067

Experimental Study of Split-Path Transmission Load Sharing

Timothy L. Krantz and Irebert R. Delgado
Vehicle Propulsion Directorate
U.S. Army Research Laboratory
Lewis Research Center
Cleveland, Ohio

Prepared for the
Seventh International Power Transmission and Gearing Conference
sponsored by the American Society of Mechanical Engineers
San Diego, California, October 6-9, 1996



National Aeronautics and
Space Administration



EXPERIMENTAL STUDY OF SPLIT-PATH TRANSMISSION LOAD SHARING

Timothy L. Krantz

U.S. Army Research Laboratory
Vehicle Propulsion Directorate
Lewis Research Center
Cleveland, Ohio 44135
U.S.A.

(216) 433-3580; Tim.Krantz@lerc.nasa.gov

Irebert R. Delgado

U.S. Army Research Laboratory
Vehicle Propulsion Directorate
Lewis Research Center
Cleveland, Ohio 44135
U.S.A.

(216) 433-3935; Irebert.Delgado@lerc.nasa.gov

ABSTRACT

Split-path transmissions are promising, attractive alternatives to the common planetary transmissions for helicopters. The split-path design offers two parallel paths for transmitting torque from the engine to the rotor. Ideally, the transmitted torque is shared equally between the two load paths; however, because of manufacturing tolerances, the design must be sized to allow for other than equal load sharing. To study the effect of tolerances, experiments were conducted using the NASA split-path test gearbox. Two gearboxes, nominally identical except for manufacturing tolerances, were tested. The clocking angle was considered to be a design parameter and used to adjust the load sharing of an otherwise fixed design. The torque carried in each path was measured for a matrix of input torques and clocking angles. The data were used to determine the optimal value and a tolerance for the clocking angles such that the most heavily loaded split path carried no greater than 53 percent of an input shaft torque of 367 N-m. The range of clocking angles satisfying this condition was -0.0012 ± 0.0007 rad for box 1 and -0.0023 ± 0.0009 rad for box 2. This study indicates that split-path gearboxes can be used successfully in rotorcraft and can be manufactured with existing technology.

INTRODUCTION

The drive system of a rotorcraft must meet especially demanding requirements. It must transmit the engine power to the rotor while providing a typical speed reduction of 60 to 1. In addition, it must be safe, reliable, lightweight, and energy efficient while producing little vibration and noise. Rotorcraft transmissions have matured to a high performance level through a combination of analyses, experiments, and applications of field experience. Still, the next generation of rotorcraft will call for drive systems that are even safer, lighter, quieter, and more reliable. These improvements are needed to increase the vehicle's payload and performance, improve passenger comfort and safety, lower operating costs, and reduce unscheduled maintenance.

The weight of the drive system is an especially important property. It is significantly influenced by three key features of the configuration: the number of stages, the number of parallel power paths, and the gear ratio of the final stage. By using fewer stages, more parallel power paths, and larger reduction ratios at the final stage, the drive system weight can be reduced. Using more parallel power paths reduces system weight because a gear is sized by mesh loads, not by the total torque. With the total torque shared among multiple meshes, the gear sizes are reduced. Using a larger reduction ratio at the final stage also reduces the system weight because the preceding stages will then operate at lower torques.

A planetary gear stage (Fig. 1) for a helicopter typically has 3 to 18 parallel power paths and a reduction ratio of no greater than about 7:1. There is a little used but promising alternative for the final stage, known as a split-torque or split-path arrangement (Fig. 2). With the split-path arrangement a final-stage reduction ratio of up to 14:1 can be achieved with two parallel power paths. White (1974, 1983, 1984, 1985, 1989) has studied split-path designs for helicopters and proposed their use after concluding that such designs offer the following advantages over the traditional planetary design:

- (1) A high speed reduction ratio at the final stage
- (2) A reduced number of gear stages
- (3) Lower energy losses
- (4) Increased reliability owing to separate drive paths
- (5) Fewer gears and bearings
- (6) Lower noise levels from gear meshes
- (7) Lower overall drive system weight

Obviously, depending on the requirements of the rotorcraft, a split-path design can offer significant advantages over the commonly used planetary design.

In spite of these attractive features, split-path designs have seen little use in rotorcraft because they have been considered relatively risky. The major risk of these designs is that even gearboxes manufactured to precise tolerances might have unequal torques in the two parallel paths. To compensate for this, designs proposed for or used in helicopters have

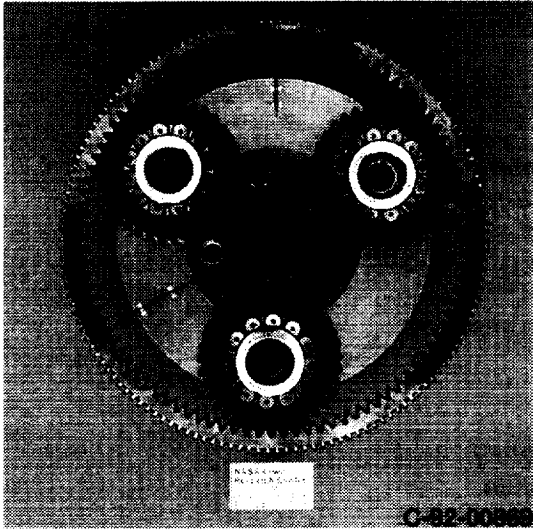

Figure 1.—Planetary design with three load paths used for final stage of helicopter transmission.

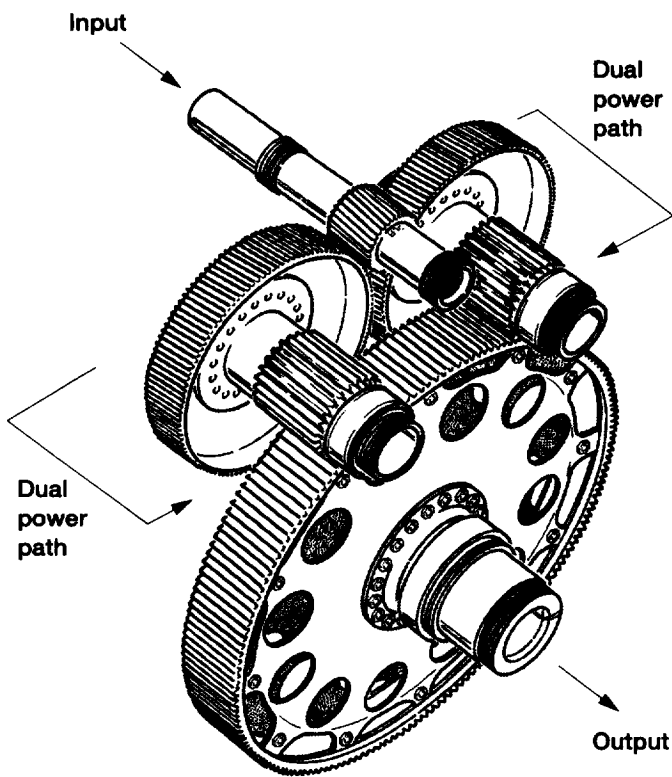

Figure 2.—Example of split-path design with dual power paths.

included a load-balancing device. For example, Smirnov (1990) and Cocking (1986) describe split-path designs that feature quill shafts to minimize the torque loading differences between the two parallel power paths. However, quill shafts, as do all load sharing devices, add complexity and weight to the design, thereby offsetting some of the advantages over proven planetary designs.

Kish (1993a) reported on the development and testing of a split-path gearbox that featured a torsionally compliant elastomeric load-sharing device. The gearbox was tested extensively both with and without the load sharing device, and Kish made the following observations:

(1) Excellent load sharing was obtained when the gearbox was operated under nominal laboratory conditions and with the load sharing device installed.

(2) The load-sharing device that was tested did not meet the requirements for field operation. For example, temperature cycles degraded the function of the device.

(3) Acceptable load sharing can be achieved without a special load-sharing device so long as manufacturing and installation tolerances are adequately controlled. Furthermore, the precision required for their manufacture and installation is within the capabilities of available and proven manufacturing processes.

On the basis of these results, a split-path design has been selected for use in the U.S. Army's Comanche helicopter (Kish, 1993b). However, the load-sharing properties of such designs are still not fully understood. For example, Kish (1993a) stated that although acceptable load sharing was demonstrated during the Advanced Rotorcraft Transmission project, the measured load sharing was not as good as predicted, considering the precision achieved in the manufacturing and installation of the tested gearbox. He suggested that compliances which were not considered in the prediction of the load sharing were, in fact, significant.

The research reported here was done to better understand split-path transmissions in an effort to support their use in the Comanche and future rotorcraft. We define the clocking angle of the geartrain and show it to be the key design parameter in optimizing an otherwise fixed design for equal sharing of the design torque. Experiments were done to measure the load sharing in the NASA split-path test gearbox. Two gearboxes, identical notwithstanding manufacturing tolerances, were tested. For each gearbox, we determined the optimal clocking angle such that a particular input torque would be split equally between the two split paths. We also determined the clocking angle tolerance that would guarantee acceptable load sharing.

A companion study to develop a method to analyze and optimize the load sharing of split-path gearboxes has also been completed. The results of that study are reported separately (Krantz, 1996).

SPLIT-PATH CONCEPTS AND DEFINITIONS

In this report, a split path refers to a parallel shaft gearing arrangement, such as that shown in Figs. 2 and 3, where the input pinion meshes with two gears, thereby offering two paths to transfer power to the output gear. For purposes of discussion, a coordinate system and some concepts are defined as follows. A right-hand Cartesian coordinate system (Fig. 3) is established such that the z-axis is coincident with the output gear shaft, the positive y-axis extends from the output gear center through the input pinion center, and the input gear drives clockwise. The first-stage gear, gearshaft, and second-stage pinion combination are collectively called the compound shaft. The two power paths are identified as A and B, with A to the right of B.

Clocking, which refers to the relative angular positions of the gear teeth, is an important attribute of a split-path geartrain. For example, there are certain clockings that would prevent the geartrain from being assembled since some of the gear teeth would interfere with one another. As will be shown, the clocking and load sharing of a split-path geartrain are related. In this report, the clocking is defined by a clocking angle β . This angle could be measured by the conceptual experiment depicted in Fig. 3. Here, the output gear is fixed from rotating and a nominal clockwise torque is applied to the input pinion so that the gear teeth come into contact. If all the gear teeth of both power paths come into contact, then clocking angle β is, by definition, equal to zero. If the teeth of one power path are not in contact, then the clocking angle β is equal to the angle that the first-stage gear would have to be rotated relative to the second-stage pinion to bring all teeth into contact. The clocking angle β could be determined by measuring the circumferential movement of a gear tooth with a dial indicator while rotating the "loose" compound shaft over the range of play and then calculating

$$\beta = X/R \quad (1)$$

where X = the movement measured by the indicator, and R = the radius at which the indicator is located. The clocking angle β is defined as positive if, under nominal torque, a gap exists in path A and as negative if the gap exists in path B.

To relate the clocking angle to load sharing, let us use the concept of the loaded windup of the geartrain. Envision that the output gear of a geartrain is rigidly fixed from rotating and a torque is applied to the input pinion. Because of deformations, the input shaft will rotate some amount

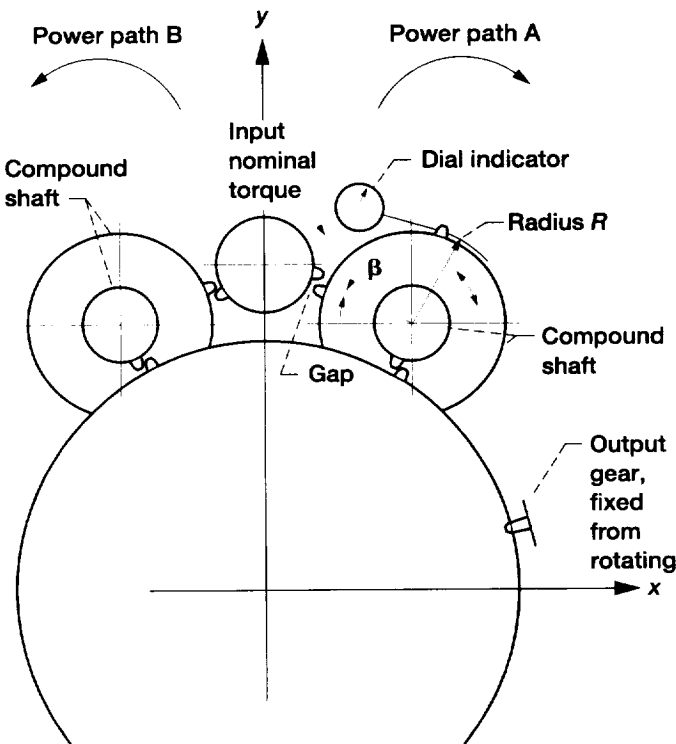

Figure 3.—Illustration of conceptual experiment to measure geartrain clocking angle β .

as torque is applied. This rotation of the input pinion relative to the output gear is the loaded windup. The loaded windups of the two power paths are related to the clocking angle by

$$\beta = \frac{LWB - LWA}{GR} \quad (2)$$

where LWA = loaded windup of power path A; LWB = loaded windup of power path B; and GR = the reduction ratio of input pinion and compound shaft gear.

The torque transferred by each load path is a product of the loaded windup multiplied by the net torsional stiffness of that path. Combining this information with Eq. (2) allows us to consider the clocking angle β as a design variable for split-path gearboxes. For an otherwise fixed design, the clocking angle can be adjusted to split a design load equally between the two power paths. Of course, as already mentioned, the clocking angle must also allow for assembly of the geartrain.

DESCRIPTION OF THE GEARBOX AND CALIBRATION

The design studied was the NASA split-path test gearbox. This gearbox (Figs. 2 and 4) has two stages and is designed to operate at 373 kW (500 hp) with an input shaft speed of 8780 rpm. Two gearboxes, denoted box 1 and box 2, were tested. The two boxes were nominally identical except for manufacturing tolerances. Gear and bearing design data are given in Tables I and II.

Within each gearbox, the face widths of the gears of the compound shafts are somewhat wider than those of their mating teeth. Therefore, the axial locations of the compound shafts can vary somewhat and still allow for contact across the full faces of the mating teeth. The axial location of each compound shaft depends on the thickness of a shim pack (Fig. 4); thus the clocking angle of the geartrain can be easily adjusted by adjusting the thickness of the shim pack, which effectively screws the helical gear into or out of mesh with its mate.

Strain gages were attached to the compound shafts to measure torque via a torque bridge. Four 1000- Ω nominal resistance gages with torque-type grid patterns were attached as diametrically opposed pairs. The gage leads were joined to make a full Wheatstone bridge such that shaft torsion would change the bridge balance whereas pure shaft bending would not. The strain gage conditioner supplied a constant 5-V-dc excitation and amplified the output of the Wheatstone bridge by a factor of 200. The output voltage was measured with a digital voltmeter.

FRICTION

In all calibrations and experiments, static torques were used. Even though the gears and bearings were wet with turbine engine oil during the experiments, the friction forces encountered were significantly larger than those that would be present if the shafts were rotating at design speed and with proper lubrication. To make the results of the experiments as representative as possible of the operating gearbox, we determined a friction factor that enabled us to remove the influence of friction from the data.

To determine a friction factor, we loaded the input shaft with a pure static torque by using masses, a pulley, and a loading arm as shown in Fig. 5. The output shaft was connected to ground through flexible couplings to react the load. Because of the couplings, the output shaft

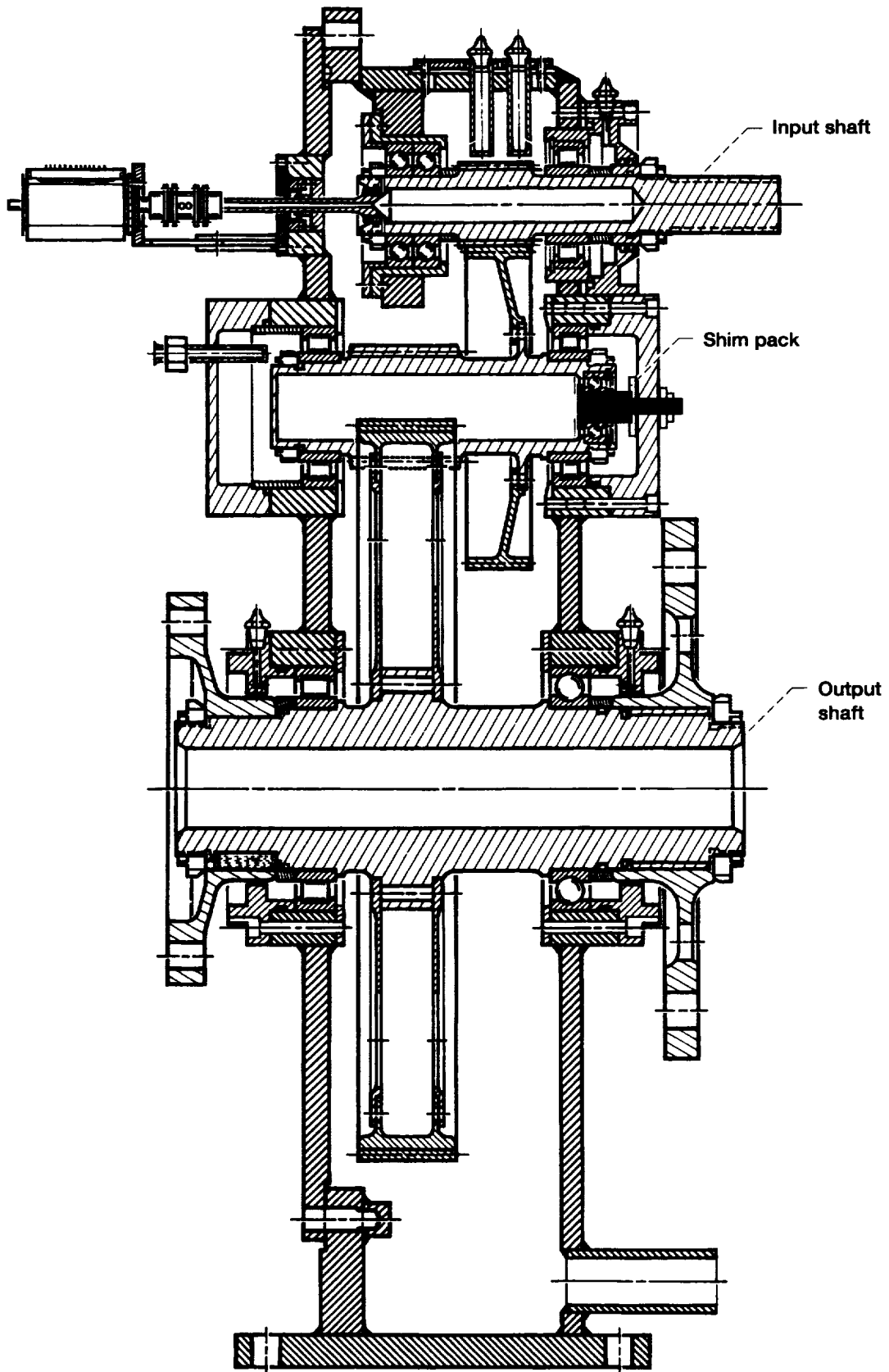

Figure 4.—Cross-sectional view of NASA split-path test gearbox.

TABLE I.—Gear Data of the NASA Split-Path Test Gearbox

Location	Number of teeth	Pitch diameter, mm	Face width, mm	Normal pressure angle, deg	Helix angle, deg
First-stage pinion	32	51.1	44.5	20	6
First-stage gear	124	197.9	38.1	20	6
Second-stage pinion	27	68.6	66.0	25	0
Second-stage gear	176	447.0	59.9	25	0

TABLE II.—Bearing Data of the NASA Split-Path Test Gearbox

Location	Type	Inner raceway diameter, mm	Outer raceway diameter, mm	Number of rolling elements	Rolling element diameter, mm	Roller length, mm	Contact angle, deg
Input shaft	Roller	50.0	69.1	13	9.53	13.20	-
Compound shaft	Roller	87.4	66.5	15	10.67	10.67	-
Output shaft	Roller	113.0	133.9	23	15.88	10.41	-
Input shaft	Duplex ball	48.9	71.3	14	11.13	---	29
Output shaft	Ball	109.1	140.9	14	15.88	---	0

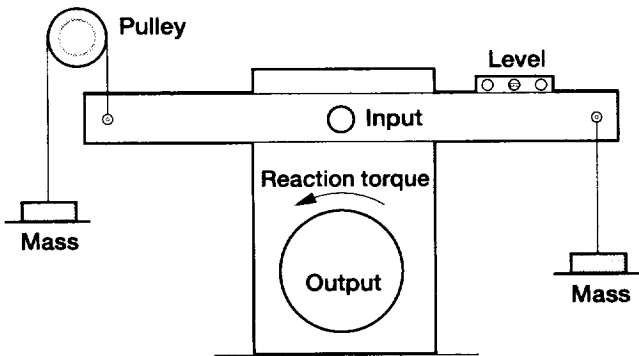

Figure 5.—Experimental method using a loading arm and pulley system to load the input shaft with a pure torque load.

carried a pure torque. Before recording data, we rotated the shafts to position the loading arm to be horizontal, as indicated by a level. Data were recorded once after rotating the shafts clockwise and again after rotating the shafts counterclockwise. We recorded five datasets for each of the two boxes, rotating the input shaft several turns between each dataset so that different gear teeth were in contact from dataset to dataset. A raw dataset consisted of output voltages recorded for five torque loads for both shaft rotation directions.

For each dataset, we calculated two linear least-squares-fit equations, one for each direction of rotation (Fig. 6). As expected, the y-intercepts of the two equations were equal (to within experimental uncertainty), but the slopes differed. The slopes were different because for clockwise rotation the frictional torque adds to the input torque, whereas for counterclockwise rotation the frictional torque subtracts from input torque. We expect that when the gearbox operates with proper lubrication, the frictional torques will be negligible compared to those present in these static load experiments. We considered two ways to determine “frictionless” data from our experimental setup. One was to conduct each experiment twice, once for each rotation direction, and average the results. Another way, the one we chose, was to conduct all experiments for one direction of rotation (clockwise was used) and remove the friction effects from the data. Referring to Fig. 6, we can describe the lines through the data as

$$\text{volts}_{cw} = \text{torque} \times m_{cw} + b \quad (3)$$

$$\text{volts}_{ccw} = \text{torque} \times m_{ccw} + b \quad (4)$$

Frictionless data would fall on the line

$$\text{volts} = \text{torque} + (m_{cw} + m_{ccw})/2 + b \quad (5)$$

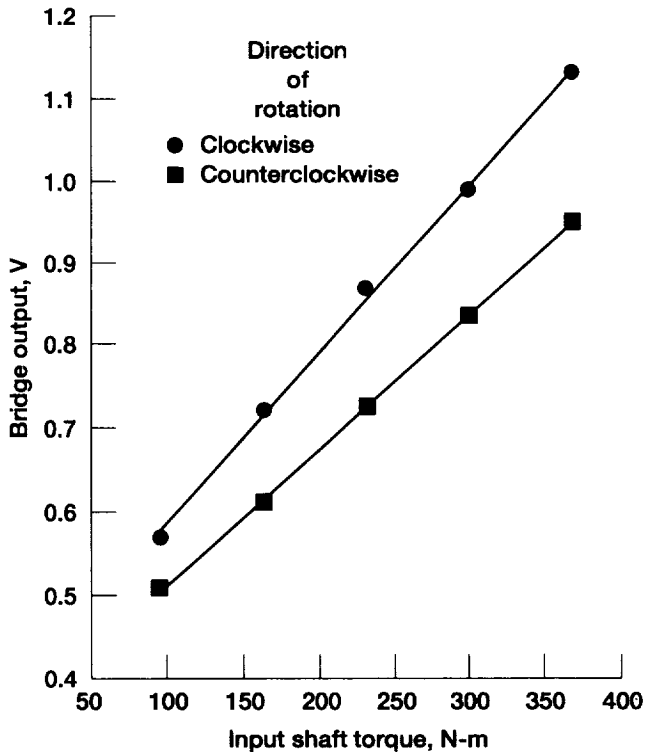

Figure 6.—Typical dataset from friction experiments. Reversing direction of rotation also reverses direction of friction forces, thereby affecting torque bridge output.

Therefore, we can define a friction factor as

$$\text{friction factor} = \frac{(m_{ccw} + m_{cw})/2}{m_{cw}} \quad (6)$$

The mean value of the friction factors for all datasets was found to be 0.89, with a standard error of ± 0.04 (a 95-percent confidence level, assuming Student's *t* distribution applies).

Except for the friction experiments just described, in all other experiments the shafts of the gearboxes were rotated clockwise immediately before the data were recorded. The influence of the friction forces was removed from the data by incorporating the friction factor into calibration equations. The details of the calibration procedure, including how the friction factor was incorporated, are explained in the following section.

CALIBRATION

To calibrate the torque bridge on a compound shaft, we installed only one of the two compound shafts in the gearbox at a time. Torque was applied to the input shaft in the same manner as was done for the friction experiments (Fig. 5). The input shaft was rotated clockwise to bring the loading arm horizontal, and then the amplified output voltage from the strain gage conditioner was measured and recorded. For each

compound shaft, we recorded calibration data for a full matrix of eight different torques and four different angular positions of the compound shaft. Each torque and position combination was tested twice.

Analysis of the torque bridge calibration data showed that the output voltage was a function not only of the torque but also of the angular position of the compound shaft (Fig. 7). Classical beam theory, valid for long beams, predicts a symmetric strain distribution; therefore, the torque bridge output voltage should be independent of angular position. The dependence on angular position that we see in these data probably means that the strain distribution in this short shaft is different from that suggested by the classical beam theory. It could also be due to errors in positioning the strain gages on the gearshaft. Because the output voltage depends on angular position, if the compound shaft were rotating while carrying a constant torque, the output voltage from the torque bridge would vary as a periodic function. The time-averaged mean of the periodic function would be proportional to the torque. We averaged the measured voltages of the four discrete compound shaft positions tested to determine the approximate time-averaged mean of this periodic function.

To determine a calibration equation for each compound shaft, we first calculated the least-squares-fit linear equation of the calibration data and then modified the relation by multiplying the slope by the friction factor as defined by Eq. (6). Incorporating the friction factor into the calibration equations in this way removed the influence of friction from the experimental data.

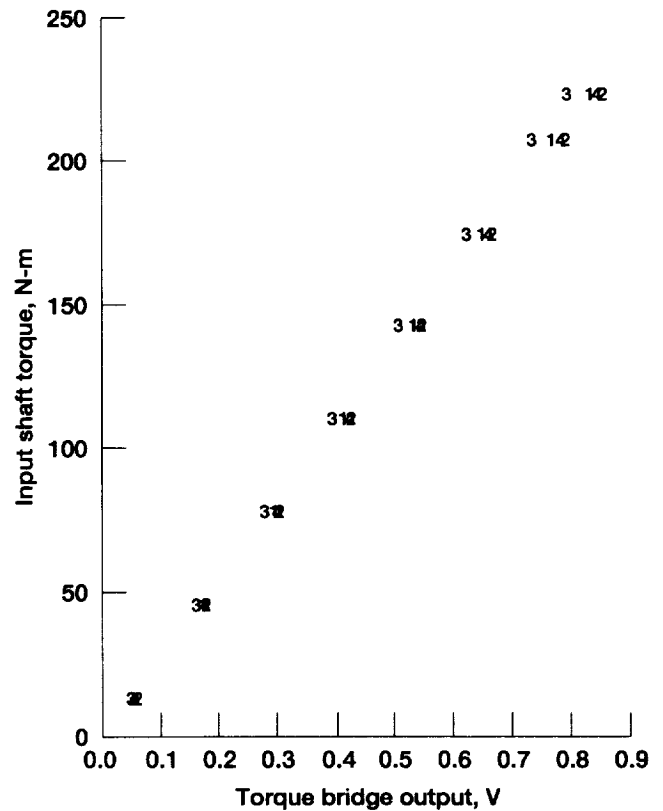

Figure 7.—Data from experiment to calibrate compound shaft torque bridge. The numerals used as symbols represent four shaft angular positions tested.

EXPERIMENTAL CASE STUDY

The NASA split-path gearbox was used to do a case study of the relationship between the clocking angle and the load sharing of split-path designs. The problem we posed was to determine (1) the optimal clocking such that an input shaft torque of 367 N-m would be split equally between the two compound shafts, and (2) a tolerance for the clocking angle such that the more heavily loaded compound shaft would carry no more than 53 percent of an input shaft torque of 367 N-m. We chose these values (367 N-m and 53 percent) because they were representative of gearboxes for a small helicopter.

In the experiments to solve the case study problem, static torques were applied to the input shaft and then the torques carried by the compound shafts were measured. Experiments were done for a range of torques and clocking angles. The gearboxes were loaded in the same manner as was done for the friction experiments (Fig. 5) so that input and output shafts carried pure torque loads. The input shaft was always rotated clockwise to bring the loading arm level before the data were recorded.

Data were recorded at 14 different clocking angles for box 1, and 5 different clocking angles for box 2. We adjusted the clocking angles by varying the thicknesses of the shim packs that axially positioned the compound shafts. The range of values used for the shim pack thicknesses allowed for as large a range of clocking angles as possible while still maintaining contact across the full faces of the gear teeth for all experiments.

Datasets were recorded for each gearbox. The output voltages of the torque bridges for both compound shafts were recorded as datapoint pairs; a full dataset consisted of the datapoint pairs for a matrix of four angular positions of the compound shafts under at least five torque loads. All of the data in one dataset corresponded to a particular set of shim pack thicknesses. For both gearboxes, five full datasets corresponding to five pairs of shim packs of varying sizes were recorded. For box 1, data were also recorded for a matrix of nine additional shim pack sizes at four angular shaft positions under an input shaft torque of 367 N-m.

We set up the following method to solve the case study problem using the experimental raw data:

- (1) For each shim pack pair tested, find the functions that relate the compound shaft torques to the input shaft torque.
- (2) Relate the shim pack sizes to the clocking angle.
- (3) Use the results of steps 1 and 2 to find functions that relate the compound shaft torques to the clocking angles for an input shaft torque of 367 N-m.
- (4) Use the results of step 3 to determine the clocking angles that yield the optimal and the acceptable levels of torque carried by the compound shafts.

To complete the first two steps, we used the calibration equations and measured torque bridge output voltage to calculate the torques carried by each compound shaft. Since the friction factor was incorporated into the calibration equations, the effect of friction was thereby removed from the data. Next, we calculated the least-squares-fit linear equations for each full dataset (Fig. 8) to determine the compound shaft torques as a function of the input shaft torque. Each equation was valid only for a particular pair of shim packs and, therefore, valid only for a particular clocking angle.

As the third step, we related the sizes of the shim pack pairs to the clocking angle by describing the clocking angle as a linear function of the sizes of the shim pack pairs:

$$\beta = \{t_A - t_B\}m + b \quad (7)$$

where β = the clocking angle; t_A = the thickness of the shim pack for power path A; t_B = the thickness of the shim pack for power path B; slope m is known from the lead of the helical gear; and the y -intercept b is a term to be determined.

We determined b , the y -intercept of Eq. (7), by using our definition of the clocking angle. The definition states that the clocking angle is zero if the gear teeth of both power paths are in contact for a nominal input shaft torque. This definition implies that if the clocking angle were equal to zero, then a linear equation relating input shaft torque to compound shaft torque should have a y -intercept equal to zero. Using the curvefits of compound shaft torque as a function of input shaft torque for the five full datasets for each gearbox, we plotted the y -intercepts of those curvefits as a function of the difference in shim pack thicknesses (Fig. 9). The value of b for Eq. (7) could then be determined since the difference in shim pack thicknesses that yields a y -intercept equal to zero is also the difference that coincides with a clocking angle equal to zero. The two

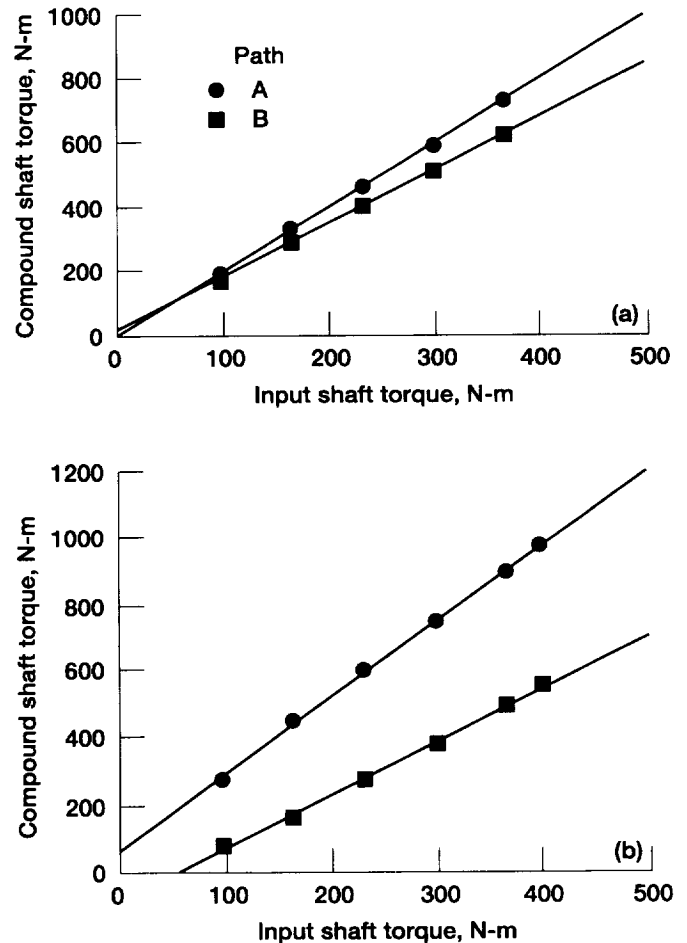

Figure 8.—Typical examples of data and curvefits of compound shaft torque as a function of input shaft torque. (a) Shim pack set 3 installed in box 2. (b) Shim pack set 5 installed in box 2.

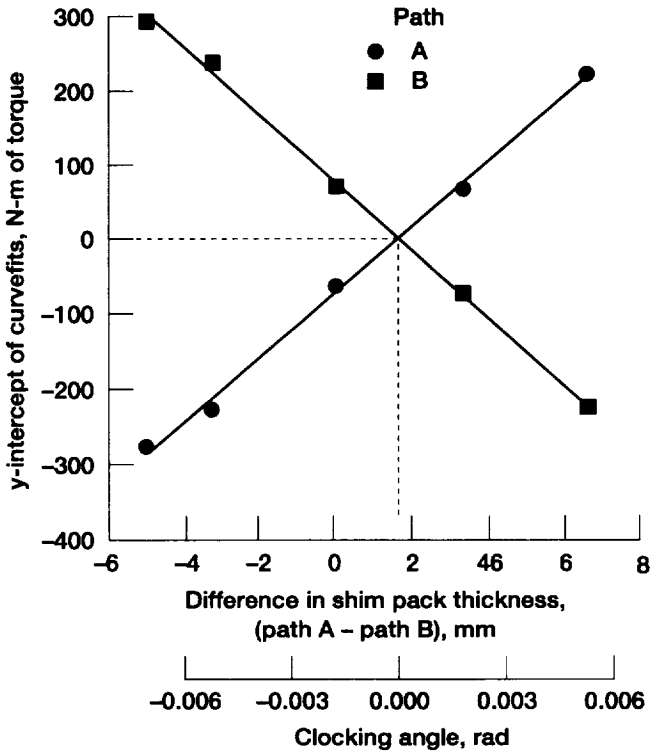

Figure 9.—Relation of difference in shim thickness to clocking angle for box 1.

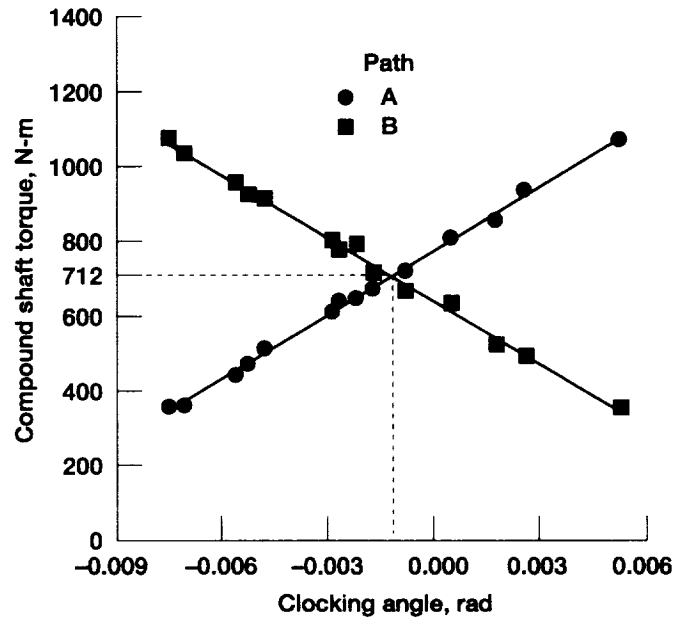

Figure 10.—Data for box 1 carrying an input shaft torque of 367 N-m indicates that for a clocking angle of -0.0012 rad both compound shafts will carry the optimal amount of torque (712 N-m).

curvefits provided for two independent evaluations, and both yielded the same result.

As the fourth step of the method, we determined the clocking angles such that an input shaft torque of 367 N-m would be shared equally between power paths A and B. For each of the five full datasets, we calculated the compound shaft torque in power path A for an input shaft torque of 367 N-m by using the curvefits from step 2 to relate the input and compound shaft torques for that dataset. (In addition to the full datasets, for box 1 we had recorded the output voltages in the compound shafts with the input shaft loaded to 367 N-m for another nine clocking angles; those data are included in this analysis.) The clocking angle for a particular dataset was determined by using the results of step 3. Next we plotted and curve-fit the torque carried by both compound shafts as a function of the clocking angle (Fig. 10) and used this to directly solve the case study problem. The desired optimal torque is 712 N-m, which is equal to one-half the input shaft torque of 367 N-m multiplied by the first-stage gear ratio of 3.88:1. Using Fig. 10, we determined that the clocking angle for optimal sharing of an input torque of 367 N-m for box 1 is -0.0012 rad (-4.1 min). The two curvefits provided for two independent measures of the optimal clocking angle, and both produced the same result. For box 2, the optimal clocking angle was found to be -0.0023 rad (-7.9 min).

The data for power path A from Fig. 10 are plotted again in Fig. 11 with the ordinate expressed as the proportion of input shaft torque. Considering ± 3 percent to be an acceptable variation in the torque carried by the compound shaft, we used Fig. 11 to determine a tolerance for the clocking angle. The tolerance for box 1 equaled ± 0.0007 rad (± 2.4 min) and for box 2 equaled ± 0.0009 rad (± 3.1 min).

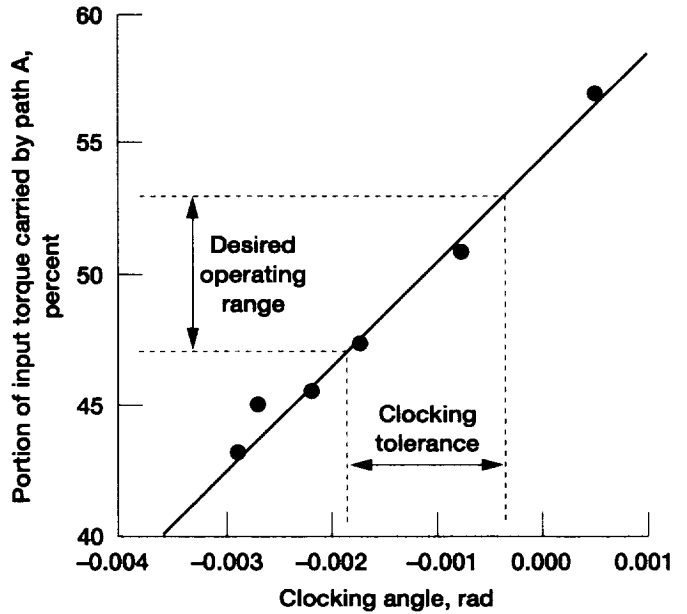

Figure 11.—Results for box 1 showing range of clocking angles which will guarantee that the most heavily loaded power path will carry no more than 53 percent of the input power.

The uncertainty of the experimentally derived results presented herein is essentially determined by the uncertainty of the friction factor. A single value was used for the friction factor throughout the data analysis, when in fact, the friction factor varied depending on which load-bearing surfaces were in contact when a datapoint was recorded. We estimated the uncertainty in the friction factor by a statistical analysis of the friction experiments and then performed uncertainty calculations of the final results. To a 95-percent confidence level, the uncertainties were estimated as ± 0.0006 rad for the optimal clocking angle and as ± 0.0002 rad for the clocking angle tolerance band.

Just as we could measure the clocking angle by a linear dimension, as depicted in the conceptual experiment of Fig. 3, we can also express the tolerance for the clocking angle in a similar manner. Expressing the tolerance for box 1 as a linear dimension at the pitch diameter of the first-stage gear and using the second-stage pinion as a reference, we found that the working surface of the tooth must be located within ± 0.003 in. Aerospace gear manufacturers are capable of maintaining such a tolerance. Therefore, this study indicates that split-path transmissions can be used successfully for rotorcraft and that the precision of manufacture and installation required is within the capabilities of existing technology.

SUMMARY

This investigation was done to better understand split-path transmission load sharing and thereby support its use in the Comanche and future rotorcraft. The clocking angle of a split-path gearbox was considered as a design parameter that can be used to adjust the load sharing. Experiments were done to study the relationship between the clocking angle and the load sharing of the NASA split-path test gearbox. The influence of friction was eliminated from the data, which was recorded by using static torques, so that the results of the experiments would be as representative as possible of the operating gearbox. Two gearboxes, nominally identical except for manufacturing tolerances, were studied.

As a case study, we determined the optimal value and the clocking angle tolerance for an input shaft torque of 367 N-m while using 53 percent of this torque as the maximum allowable proportion to be carried by the more heavily loaded split path. The optimal clocking angles for the torque to be shared equally between the two load paths were

-0.0012 rad (-4.1 min) for box 1 and -0.0023 rad (-7.9 min) for box 2. In order for the most heavily loaded split path to carry no greater than 53 percent of the input torque, the tolerance required for the clocking angle was found to be ± 0.0007 rad (2.4 min) for box 1 and ± 0.0009 rad (3.1 min) for box 2. This study indicates that split-path transmissions can be used successfully for rotorcraft and that the precision of manufacture and installation required is within the capabilities of existing manufacturing technology.

REFERENCES

- Cocking, H., 1986, "The Design of an Advanced Engineering Gearbox," *Vertica*, Vol. 10, No. 2, Westland Helicopters and Hovercraft PLC, Yeovil, England, pp. 213-215.
- Kish, J.G., 1993a, "Sikorsky Aircraft Advanced Rotorcraft Transmission (ART) Program - Final Report," NASA CR-191079, NASA Lewis Research Center, Cleveland, OH.
- Kish, J., 1993b, "Comanche Drive System," *Rotary Wing Propulsion Specialists' Meeting: Proceedings, American Helicopter Society*, Williamsburg, VA, p. 7.
- Krantz, T.L., 1996, "A Method to Analyze and Optimize the Load Sharing of Split-Path Transmissions," NASA TM-107201, ARL-TR-1066, NASA Lewis Research Center, Cleveland, OH.
- Smirnov, G., 1990, "Multiple-Power-Path Nonplanetary Main Gearbox of the Mi-26 Heavy-Lift Transport Helicopter," *Vertiflite*, Mil Design Bureau, Moscow, Vol. 36, pp. 20-23.
- White, G., 1974, "New Family of High-Ratio Reduction Gears With Multiple Drive Paths," *Proc. Instn. Mech. Engrs.*, Vol. 188, pp. 281-288.
- White, G., 1983, "Design Study of a 375 kW Helicopter Transmission With Split-Torque Epicyclic and Bevel Drive Stages," *J. Mech. Eng. Sci.*, Vol. 197, Part C, pp. 213-224.
- White, G., 1984, "A 2400 kW Lightweight Helicopter Transmission With Split-Torque Gear Trains," ASME Paper 84-Det-91.
- White, G., 1985, "The 3600 hp Split-Torque Helicopter Transmission," NASA CR-174932, NASA Lewis Research Center, Cleveland, OH.
- White, G., 1989, "Split-Torque Helicopter Transmission With Widely Separated Engines," *Proc. Instn. Mech. Engrs.*, Vol. 203, No. G1, pp. 53-65.

REPORT DOCUMENTATION PAGEForm Approved
OMB No. 0704-0188

Public reporting burden for this collection of information is estimated to average 1 hour per response, including the time for reviewing instructions, searching existing data sources, gathering and maintaining the data needed, and completing and reviewing the collection of information. Send comments regarding this burden estimate or any other aspect of this collection of information, including suggestions for reducing this burden, to Washington Headquarters Services, Directorate for Information Operations and Reports, 1215 Jefferson Davis Highway, Suite 1204, Arlington, VA 22202-4302, and to the Office of Management and Budget, Paperwork Reduction Project (0704-0188), Washington, DC 20503.

1. AGENCY USE ONLY (Leave blank)		2. REPORT DATE June 1996	3. REPORT TYPE AND DATES COVERED Technical Memorandum	
4. TITLE AND SUBTITLE Experimental Study of Split Path Transmission Load Sharing			5. FUNDING NUMBERS WU-505-62-36 1L162211A47A	
6. AUTHOR(S) Timothy L. Krantz and Irebert R. Delgado				
7. PERFORMING ORGANIZATION NAME(S) AND ADDRESS(ES) NASA Lewis Research Center Cleveland, Ohio 44135-3191 and Vehicle Propulsion Directorate U.S. Army Research Laboratory Cleveland, Ohio 44135-3191			8. PERFORMING ORGANIZATION REPORT NUMBER E-10187	
9. SPONSORING/MONITORING AGENCY NAME(S) AND ADDRESS(ES) National Aeronautics and Space Administration Washington, D.C. 20546-0001 and U.S. Army Research Laboratory Adelphi, Maryland 20783-1145			10. SPONSORING/MONITORING AGENCY REPORT NUMBER NASA TM-107202 ARL-TR-1067	
11. SUPPLEMENTARY NOTES Prepared for the Seventh International Power Transmission and Gearing Conference sponsored by the American Society of Mechanical Engineers, San Diego, California, October 6-9, 1996. Responsible person, Timothy L. Krantz, organization code 2730, (216) 433-3580.				
12a. DISTRIBUTION/AVAILABILITY STATEMENT Unclassified - Unlimited Subject Category 37 This publication is available from the NASA Center for AeroSpace Information, (301) 621-0390.			12b. DISTRIBUTION CODE	
13. ABSTRACT (Maximum 200 words) Split-path transmissions are promising, attractive alternatives to the common planetary transmissions for helicopters. The split-path design offers two parallel paths for transmitting torque from the engine to the rotor. Ideally, the transmitted torque is shared equally between the two load paths; however, because of manufacturing tolerances, the design must be sized to allow for other than equal load sharing. To study the effect of tolerances, experiments were conducted using the NASA split-path test gearbox. Two gearboxes, nominally identical except for manufacturing tolerances, were tested. The clocking angle was considered to be a design parameter and used to adjust the load sharing of an otherwise fixed design. The torque carried in each path was measured for a matrix of input torques and clocking angles. The data were used to determine the optimal value and a tolerance for the clocking angles such that the most heavily loaded split path carried no greater than 53 percent of an input shaft torque of 367 N-m. The range of clocking angles satisfying this condition was -0.0012 ± 0.0007 rad for box 1 and -0.0023 ± 0.0009 rad for box 2. This study indicates that split-path gearboxes can be used successfully in rotorcraft and can be manufactured with existing technology.				
14. SUBJECT TERMS Gears; Transmissions; Helicopters			15. NUMBER OF PAGES 11	
			16. PRICE CODE A03	
17. SECURITY CLASSIFICATION OF REPORT Unclassified	18. SECURITY CLASSIFICATION OF THIS PAGE Unclassified	19. SECURITY CLASSIFICATION OF ABSTRACT Unclassified	20. LIMITATION OF ABSTRACT	

National Aeronautics and
Space Administration

Lewis Research Center
21000 Brookpark Rd.
Cleveland, OH 44135-3191

Official Business
Penalty for Private Use \$300

POSTMASTER: If Undeliverable — Do Not Return