

MAGNETIC LEVIATION SYSTEM DESIGN AND IMPLEMENTATION FOR WIND TUNNEL APPLICATION

Chin E. Lin
Institute of Aeronautics and Astronautics
National Cheng Kung University
Tainan, Taiwan, R.O.C.

Yih-Ran Sheu
Department of Electrical Engineering
Nan-Tai College, Tainan, Taiwan, R.O.C.

Hui-Long Jou
Institute of Aeronautics and Astronautics
National Cheng Kung University
Tainan, Taiwan, R.O.C.

ABSTRACT

This paper presents recent work in magnetic suspension wind tunnel development in National Cheng Kung University. In this phase of research, a control-based study is emphasized to implement a robust control system into the experimental system under study. A ten-coil 10 cm x 10 cm magnetic suspension wind tunnel is built using a set of quadrant detectors for six degree of freedom control. To achieve the attitude control of suspended model with different attitudes, a spacial electromagnetic field simulation using OPERA 3D is studied. A successful test for six degree of freedom control is demonstrated in this paper.

I. INTRODUCTION

Magnetic Suspension and Balance Systems (MSBS) are being developed for wind tunnels to support aircraft models operating free from flow interference caused by the conventional mechanical supports. There are several MSBS's operated for wind tunnel tests described in the literature. A typical MSBS consists of an array of electromagnets around the wind tunnel test section, generating electromagnetic forces and moments on the suspended model. The suspended model is designed with several permanent magnets embedded inside the non-metallic envelope. MSBS's of this type are inherently open-loop unstable, i.e., the position and attitude of the

suspended model should be continuously monitored with adjustment and control of the magnetic field within the wind tunnel test section via a feedback control system [1,2]. From the literature, the MSBS for wind tunnel application requires a dedicated electromagnetic loop design and a feedback control system. These two major parts are dominant to the success of the MSBS in wind tunnel operation. To accomplish such a development, a control-based study for developing a modern position and attitude control technology should be emphasized. In preparation for this research development, a comprehensive force model has been developed to look into more correlated problems in the large-gap MSBS [3,4]. From basic control approaches, we understand that many conventional control technologies can be adopted in the MSBS for wind tunnel applications. The control methodology can become useful knowledge in our laboratory from previous studies [5]. This paper presents an MSBS for wind tunnel applications from the view of the control-based study and implementation. A test system, consisting of an array of ten electromagnets for 10 cm x 10 cm wind tunnel test section, has been built and tested. The configuration of typical MSBS consists of power supplies, position sensing system, dynamic model, and feedback controller. The power supply system consists of ten PWM switching power units. Each power unit uses the high gain current feedback method to shift the poles of the electromagnet coil far from the imaginary axis. The electromagnet dynamics is neglected [2]. The position sensing system is composed of a laser optical circuit, quadrant detectors, and lateral offset detectors. The system can measure the motion of the suspended model with six degrees of freedom in wide range operation. Its accuracy is proved by experimental testing. The operating rate of the system is above 1 KHz such that the stiffness in model control is high. The dynamic model in our case indicates the relationship between the electromagnetic coil currents and the motion of suspended model. The electromagnetic field is simulated by the OPERA 3D magnetic field simulation software to look into the electromagnetic field problem, and the magnetic forces and moments in relation with magnetic field are calculated by the theoretical electromagnetic formulas. After the equations of motion are introduced [3], the linearized system dynamic model at a normal operation point is obtained. From the Bode plot of the linearized system dynamic model, we can consider the system to be decentralized since each motion of degree of freedom is dominated by its corresponding electromagnets. Then, the PID controllers are used in the decentralized system for stable regulation control. This controller is simple and easy to implement. Combining the decentralized PID controller with the optical position sensing system, the proposed system does a good job to achieve control requirements in the MSBS.

II. SYSTEM DYNAMIC MODELING

The sketch of the electromagnet circuit and its system coordinates are shown in Fig. 1. It is composed of ten electromagnet coils and a suspended model. Two air cored coils, No. 1 and No. 2, and the other eight iron cored coils, from No. 3 to No. 10, generate the electromagnetic forces and moments acting on the suspended model against the aerodynamic drag force, moment and the gravity force. The size of test section is 10 cm x 10 cm. The symmetric arrangement of the ten electromagnet coils is arranged to have a uniform magnetic field distribution in the test section. The system dynamic model gives the relationship of coil currents and the positions and attitudes of the controlled suspended model. The ten coils of the MSBS are divided into six

groups. The input coil currents are $I_1, I_2, I_3, I_4, I_5,$ and I_6 , individually. The system outputs are the positions of $x, y, z,$ and the attitude of pitch, yaw and roll. The coil currents will produce magnetic field and exert the magnetic forces and moments on the suspended model such that motion in six degrees of freedom can be generated. As the equations of motion are introduced [6] and are generally linearized for use, the system dynamic model at its normal operation point is obtained. The magnetic field in our experiments is simulated by the OPERA 3D magnetic field simulation software to understand the magnetic field problem, and the electromagnetic forces and moments in relation with magnetic field are calculated by the improved theoretical electro-magnetic formulas. The formulas are simple and their accuracies are proved by experimental measurements [4]. This process is valuable to understand the relationship of coil currents to each desired model position and attitude. Using different test conditions as inputs, the simulation results quickly show the correct direction for test preparations and control gain setting.

III. POSITION SENSING SYSTEM

The position sensing system is composed of a laser optical circuit, quadrant detectors, and lateral offset detectors. The configuration of the system is shown in Fig. 2. The laser beam from the laser tube passes through a spatial filter and a convex lens, and then extends to parallel beams. The light beam is marked by a covered sheet to form a slender rectangular beam. It goes through a splitter and then divides into two light beams. One beam goes in y -axis direction and the other in z -axis direction as shown in Fig. 5, each will be detected by a quadrant detector located at the center of the sensing position. The quadrant detector is a cell which is composed of four photo-diodes for each different direction. As the light intensity on the cell is balanced, the output of sensor voltage is zero. For the suspended model in the test section, part of the light beam will be blocked by the model and the residual light will still be received by the quadrant detector. If the model is located at the center position in z -axis direction, the top part of the residual light is the same as the bottom part and the output voltage of the detector is zero. If the model moves down in z -axis position, the top part is larger than the bottom part and the output voltage is negative, or vice versa.

This is the example for the z -axis displacement measurement. Similarly, from the residual light of the left part and the right part, the y -axis displacement can be measured. In pitch angle and yaw angle measurement, the angle variation is proportional to the sum of the unmarked light intensity by a sinusoidal function. We can pick up the data of the sum of the unmarked light to obtain the model attitude. The x -axis displacement and roll motion is measured using the lateral offset detector. The lateral offset detector is first applied to the model position sensing in MSBS. It is like the CCD position sensing system to measure the position of the marked light points on the suspended model [7], but its outputs are analog voltages with relative to the x position of the reflected light point on the detectors. The resolution and speed are much higher than CCD, and its operation is simpler.

The sensing system is calibrated by several experiments. The experimental instruments are built-up by two 0.01 mm accuracy height gauges, a 0.01 mm accuracy meter gauge, and a 10000

pulses per cycle photo-encoder. The height gauges are used to measure the y, z, pitch, and yaw displacements of the model, the meter gauge is used to measure the x-axis displacement, and the photo-encoder is used to measure the roll displacement. As the positions, and attitudes are changed, the data from the detector signal amplifier is picked up. The calibration results, which is the relationship of amplifier output signal and attitude change, and its error analysis, which is obtained from the differences between the picked-up data and the fitted curves, are shown in Fig. 3. Fig. 3(a) is the result of x-axis displacement, Fig. 3(b) is the z-axis displacement, Fig. 3(c) is the pitch angle, and Fig. 3(d) is the roll angle. The y-axis displacement and yaw angle rotation calibration result are similar to the z-axis displacement and pitch angle. We can see that the accuracy of x displacement is limited in 0.04 mm, z displacement is limited in 0.01 mm, and pitch angle is limited in 0.2 degree. The operation ranges of the sensing system follows: the pitch angle is $\pm 25^\circ$, the yaw angle is $\pm 25^\circ$, and the roll angle is $\pm 20^\circ$.

Concerning the position sensing system, there are several problems to be discussed. One is the coupling problem between the measurements in each degree of freedom, for example, the movement of z-axis will effect the measurement of roll displacement. But in the real application of the wind tunnel, the mass center of the model is fixed such that the coupling problem is not considered here. Another problem is about the sensitivity of the analog devices. They are effected by the light intensity variation and noise, mainly produced by the computer. In practice, the output signal of the amplifier is normalized by the light intensity to have the signal relatively insensitive to intensity changes and the accuracy is acceptable considering the noisy environment. To summarize, the advantages of the position and attitude sensing system are high bandwidth, accuracy, robustness, easy realization, and wide range in operation.

IV. SYSTEM IMPLEMENTATION

Based on theoretical analysis, since each electromagnetic coil contributes a different effect to position and attitude control of the suspended model, a decentralized control can be implemented on a PC-based control system. The decentralized control commands coils No. 1 and No. 2 acting on the x displacement, coils No. 3, No. 4, No. 5 and No. 6 acting on the z displacement and pitch motion control, and then coils No. 7, No. 8, No. 9 and No. 10 acting on the y displacement and yaw and roll angle control. The suspended model has embedded a cylindrical permanent magnet inside its aerodynamic envelope for magnetic field vector control. The envelope of our experiment model is a rocket of 90 mm length with total mass of 100 g, embedded with five high flux density permanent magnets of 10 mm diameter. The measured value of the magnetization is equal to 839250 A/m.

By an integration of the decentralized PID controller with loop closed from the position sensing system, the suspended model in the test section is stable in regulation control. The photograph of configuration of the MSBS is shown in Fig. 4 and its control results is shown in Fig. 5. Six PID controllers for six degrees of freedom of motion control are realized using an Intel 486-33 personal computer. The highest system sampling rate is 2 KHz, determined by

stiffness of the suspended model. The higher sampling rate can provide higher operation stiffness, and the lower sampling rate is more difficult to design the controller to meet system stability requirement.

V. CONCLUSION

In this paper, the implementation of a magnetic suspension wind tunnel using effective measurement and control is demonstrated. The objective of the proposed idea accomplishes the operation requirements of a model position and attitude measurement and control for six degrees-of-freedom. By calibration procedures, the accuracy of the proposed measurement system using an integration of quadrant detector and lateral offset detector has achieved an acceptable level [8]. Other advantages of such an implementation are beneficial operation range, bandwidth, stiffness, and stability, in addition to its high accuracy with low cost. This magnetic suspension wind tunnel is used for low speed model tests under continuous attitude changes as a simulation of real flight conditions. Also, the measurement system is established for other related research projects to test their developing control methods for such nonlinear and unstable characteristics of magnetic suspension system.

REFERENCES

- [1] C. P. Britcher; and M. J. Goodyer: "Digital Control of Wind Tunnel Magnetic Suspension and Balance System," ICIASF '87 Record, Williamsburg, VA, June 22-23, 1990.
- [2] C. E. Lin; and L. A. Lee: "Dynamic Control of Magnetic Suspension System," IEEE Advanced Motion Control Conference, Tokyo, Japan, March 30, 1990.
- [3] N. J. Groom: "Analytical Model of a Five Degree-of-Freedom Magnetic Suspension and Positioning System," NASA TM-100671, March 1989.
- [4] C. E. Lin; and H. L. Jou: "A Dynamic Method for Magnetic Torque Measurement of Permanent Magnet," IEEE Instrumentation and Measurement Technology Conference IMTC '94, Hamamatsu, Japan, May 9-12, 1994.
- [5] C. E. Lin; and Y. R. Sheu: "A Hybrid Control Approach for Large-Gap Magnetic Suspension System," CAC Journal of Control Systems and Technology, Vol. 2, No. 1, Jan. 1994, pp. 1-9.
- [6] Nelson J. Groom: "Analytical Model of a Five Degree of Freedom Magnetic Suspension and Positioning System," NASA TM-100671, March 1989.

- [7] C. E. Lin; and A. S. Hou, "A Real Time Position and Attitude Sensing Using CCD in Magnetic Suspension System Application," IEEE Trans. on Instrumentation and Measurement," Vol. 44, No. 1, pp. 8-14, February 1995.
- [8] C. E. Lin; J. H. Jou; and Y. R. Sheu: "System Implementation of Measurement and Control for a Magnetic Suspension Wind Tunnel," IEEE Instrumentation and Measurement Technology Conference 95, Boston, April 23-26, 1995.

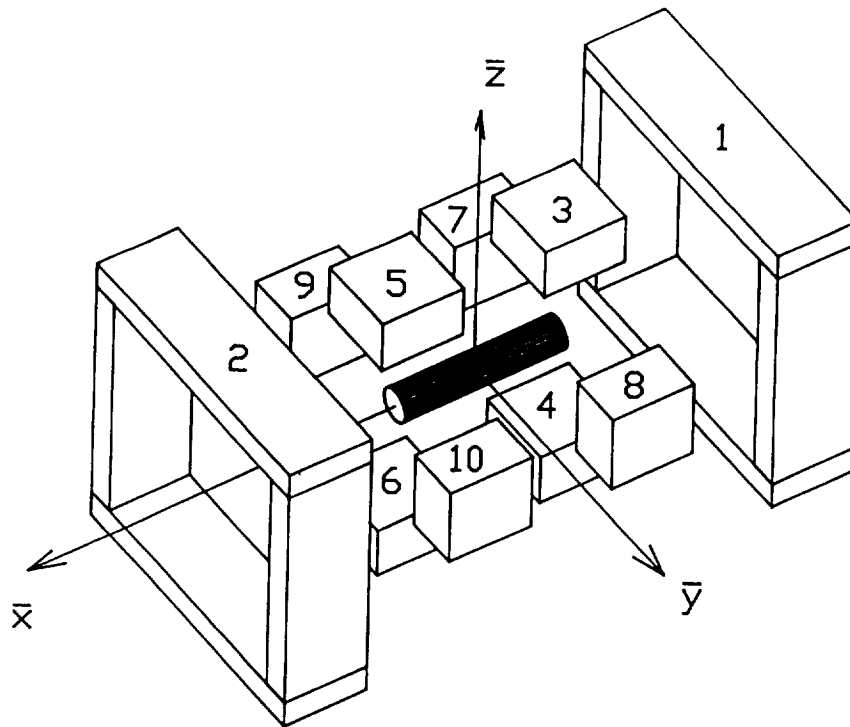

Fig. 1 Sketch of the MSBS and its system coordinate.

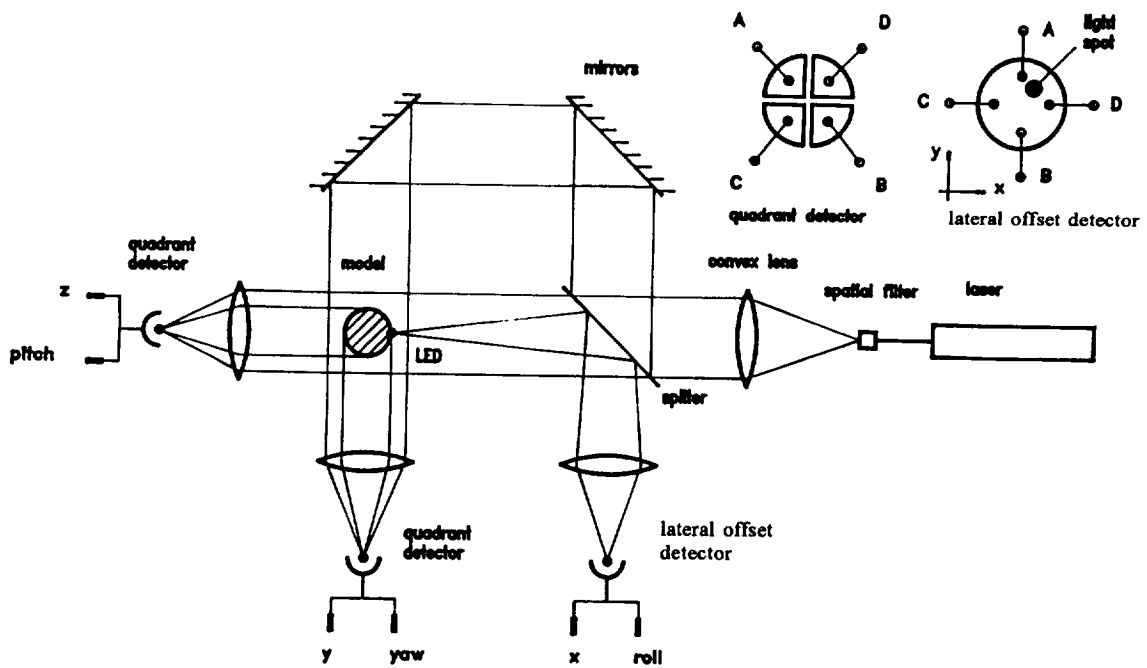

Fig. 2 Sketch of the position sensing system.

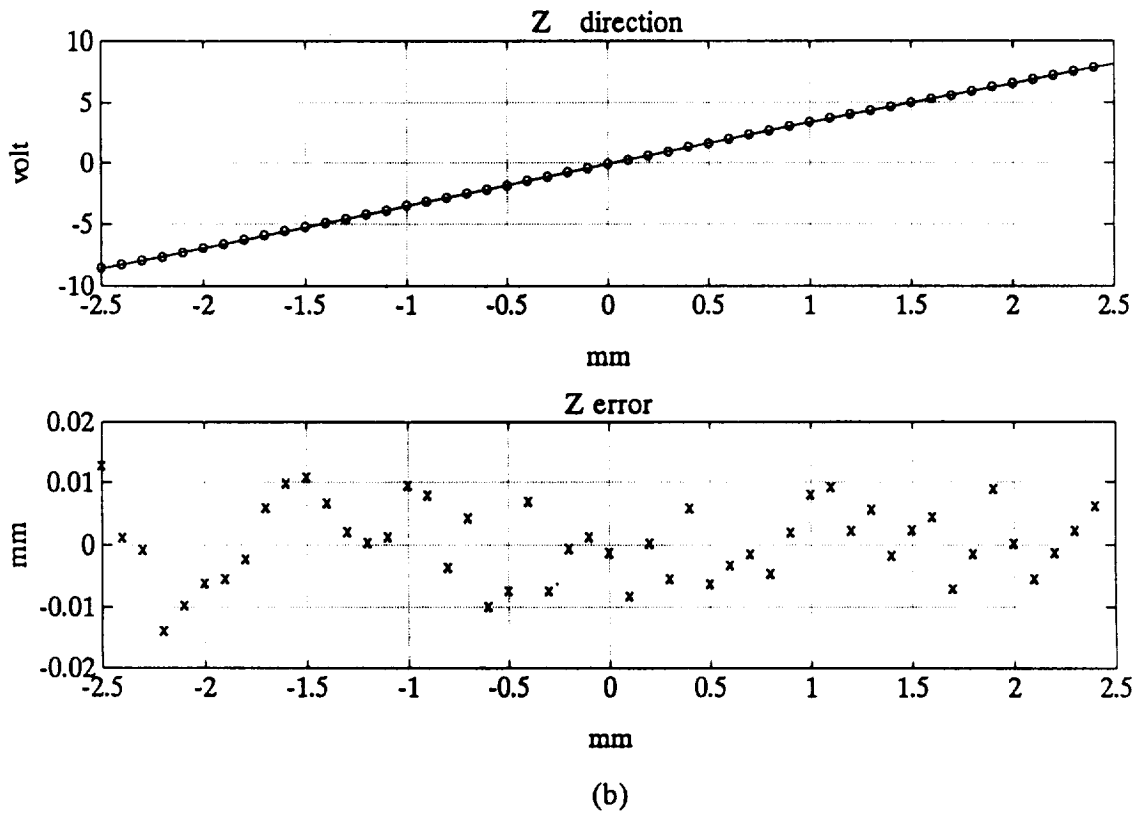
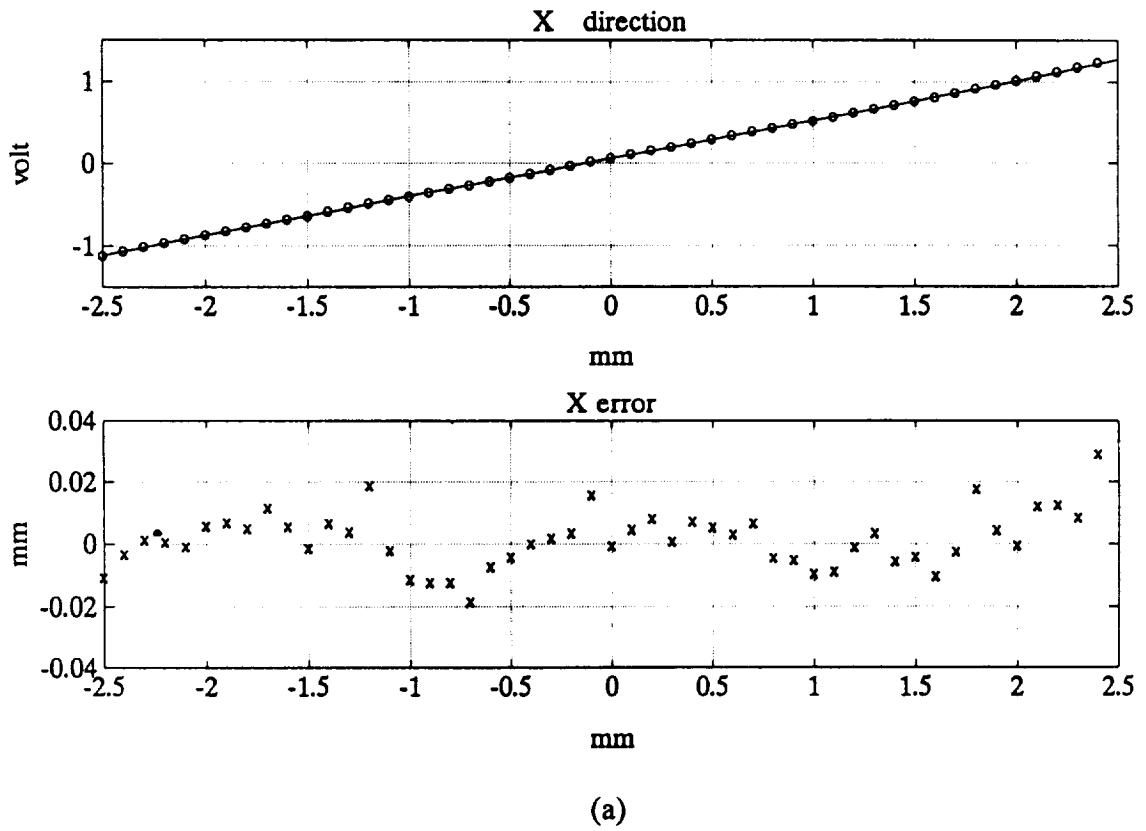
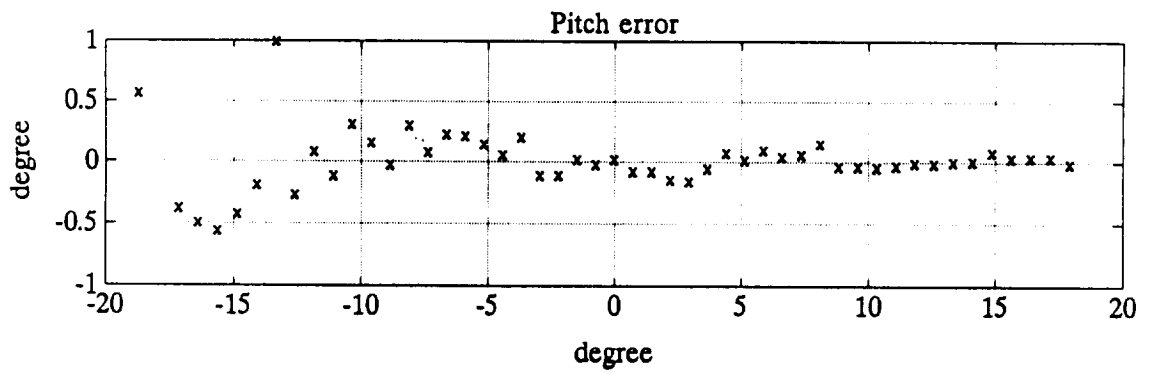
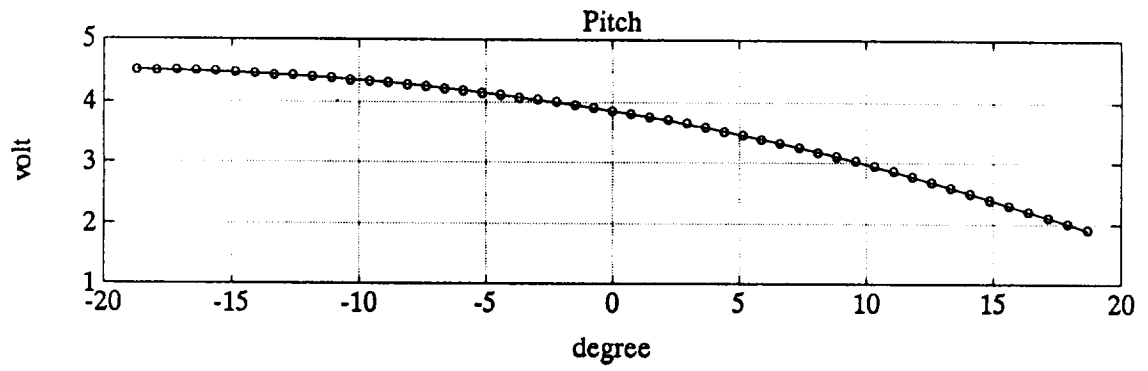
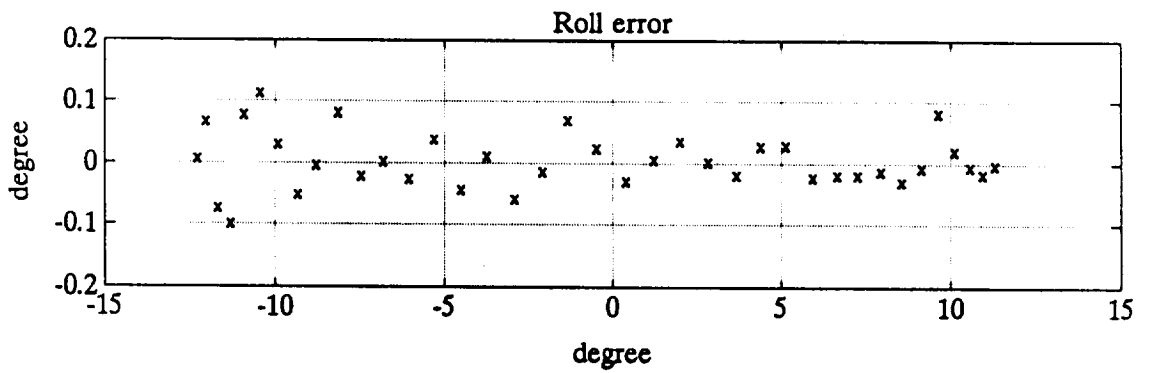
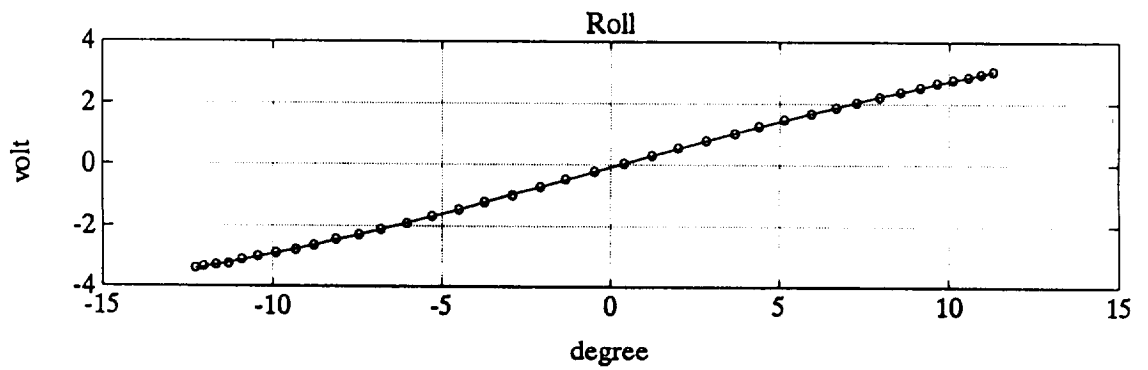

Fig. 3 Calibration results of position sensing system.



(c)



(d)

Fig. 3 Calibration results of position sensing system.

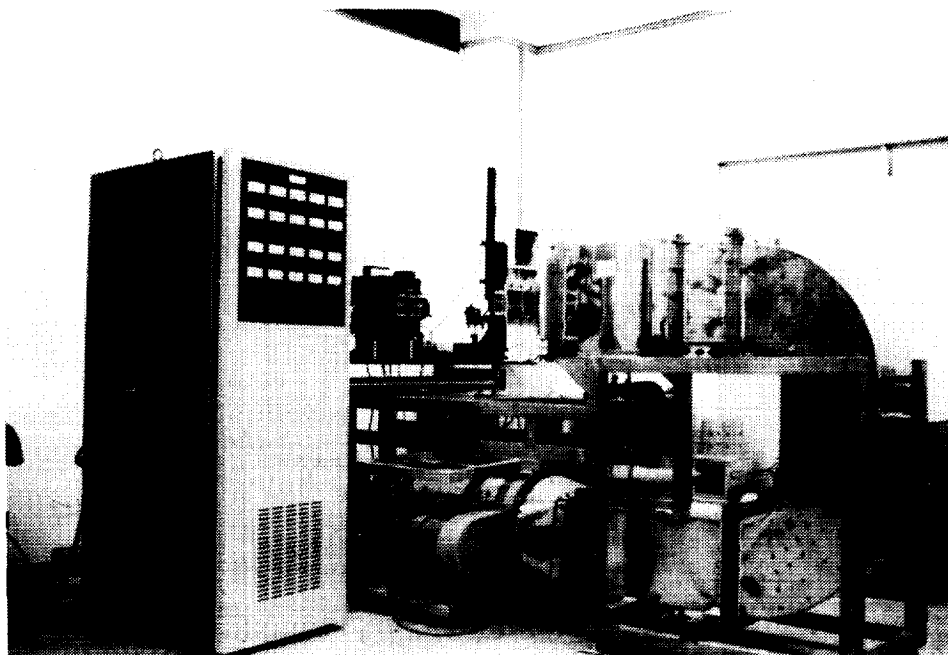

Fig. 4 Photograph of the configuration of the MSBS.

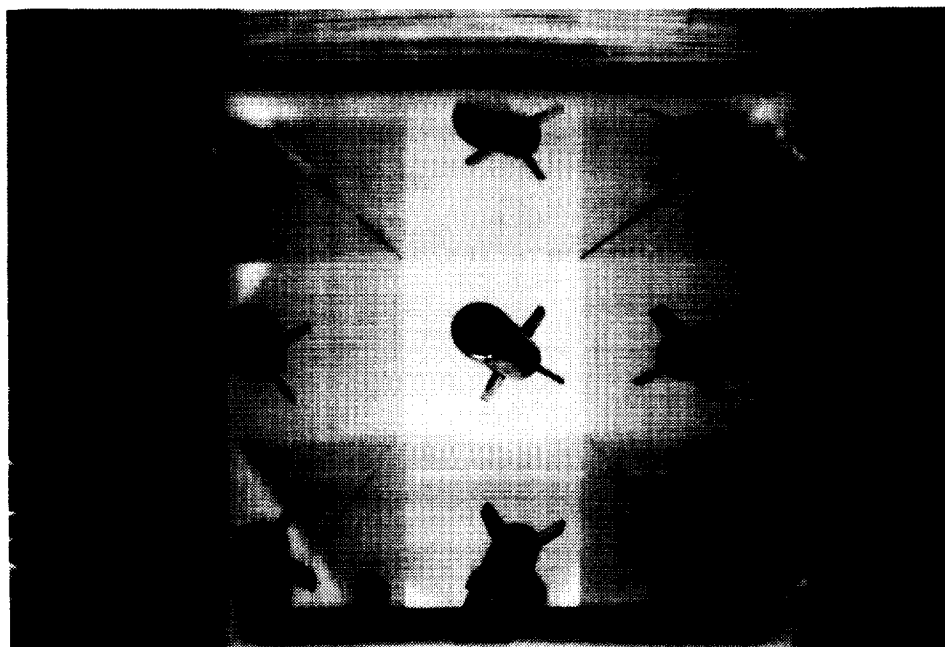

Fig. 5 Photograph of the control results of the MSBS.