

83226

Large Format Multifunction 2-Terabyte Optical Disk Storage System

David R. Kaiser, Charles F. Brucker, Edward C. Gage,
T.K. Hatwar, George O. Simmons

Eastman Kodak Company
460 Buffalo Road
Rochester, NY 14652-3816
kaiser@kodak.com
Tel: 716-588-5589
Fax: : 716-588-7693

Abstract

The *Kodak Digital Science* OD System 2000E Automated Disk Library (ADL) Base Module and write-once drive are being developed as the next generation commercial product to the currently available System 2000 ADL. Under government sponsorship with the Air Force's Rome Laboratory, Kodak is developing magneto-optic (M-O) subsystems compatible with the *Kodak Digital Science* ODW25 drive architecture, which will result in a multifunction (MF) drive capable of reading and writing 25 gigabyte (GB) WORM media and 15 GB erasable media. In an OD System 2000E ADL configuration with 4 MF drives and 100 total disks with a 50% ratio of WORM and M-O media, 2.0 terabytes (TB) of versatile near line mass storage is available.

Introduction

The architecture of the MF drive is a highly leveraged version of the WORM drive. With the exception of the MF optical head, MF analog head electronics, and bias field magnet the drive hardware is unchanged from the commercial WORM design. The MF analog electronics condition the M-O readback signals such that when they are forwarded to digitizing electronics, they are compatible with WORM signals, thereby preserving a majority of the hardware architecture.

The MF optical head has a 680 nanometer wavelength laser and 0.55 numerical aperture lens, which provide a 0.7 micron minimum mark size. The signal balancing capabilities in the MF analog electronics reduce effects of power variations and media birefringence. At 12 meters per second using an optimum record power of 5 milliwatts, a narrow band carrier-to-noise-ratio greater than 56 dB has been obtained.

The M-O media is fabricated on the same 356 millimeter diameter aluminum substrate as the commercial WORM media. While this approach required technological advances in MF head electronics because of the polycarbonate coversheet birefringence and the characteristic media noise of the underlayers, the benefits of this approach are numerous. Utilization of existing manufacturing processes and fabrication equipment positively affect quality, process yield, and unit costs for a new media offering. Furthermore, the commercial cartridge hardware provides turn-key mechanical compatibility with existing drive and robotic library designs.

As manufactured, the media is featureless. Tracking pads and sector headers are servo written as part of the manufacturing process. The featureless characteristic allows the

erasable media to be re-formatted to accommodate performance improvements in track pitch and capacity as they become available later in the product lifecycle.

The ODW25 drive uses the Intel 960 processor and employs an object orientated design. Therefore, adding the erasable functionality to the WORM baseline is straightforward. The ODW25 drive is field upgradable to MF by means of an optical head change and firmware download through a PCM/CIA card.

Kodak Digital Science ODW25 Optical Drive Architecture

The System 2000E is an evolutionary product based upon the current Kodak Optical Storage Products' large format high capacity automated disk library, the System 2000. The "E" connotation refers to the enhanced capabilities that are provided via the next generation ODW25 optical drive. The drive is fully backward compatible with Kodak's pre-existing 14" media types, can be readily installed into existing System 2000 libraries and features dual write/read heads, increased data rates, reliability and media capacity. The drive size and weight has been reduced to support a four-drive library configuration providing additional throughput and back-up capability.

The ODW25 drive has been engineered with a platform architecture to facilitate future enhancements and features. Kodak's 14" optical media format was designed to be "dual-head" ready from the onset by formatting opposing spirals on either side of the disk. The platform architecture concept was applied to both the drive and media to support a product family commensurate with the "Technology Roadmap" shown in Figure 1. The strategy behind the platform concept was to develop a "system" design that would provide both a hardware and software base which could be enhanced to support additional features and functions requested by the customer in a timely, cost effective manner.

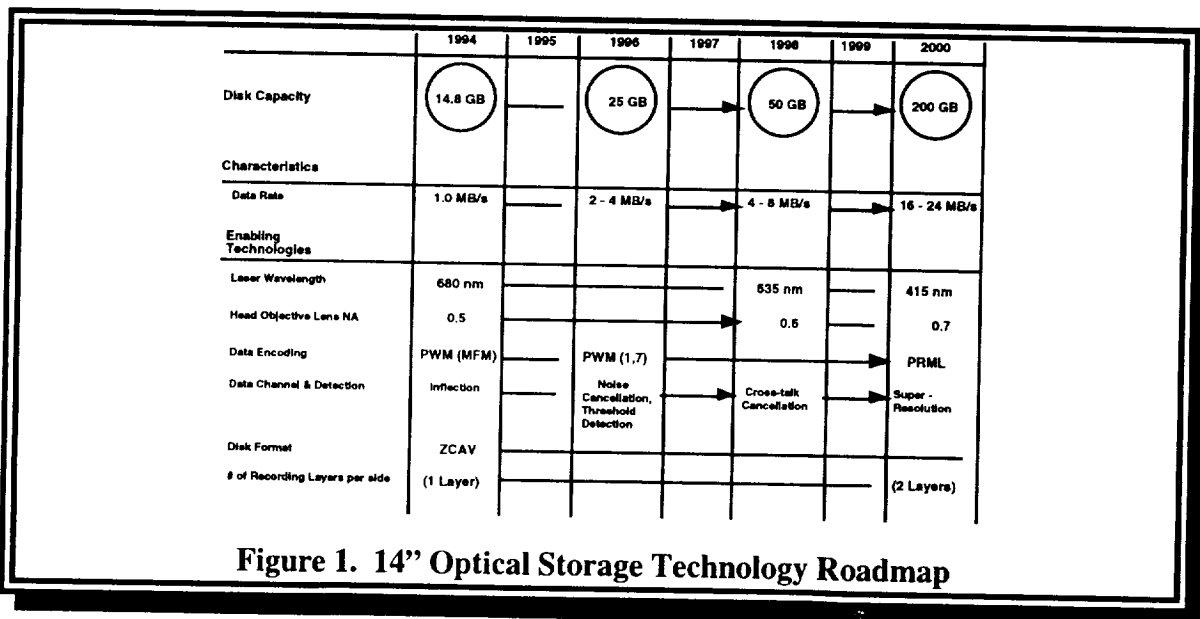

The ODW25 disk drive features a variety of innovative hardware and software techniques intended to improve reliability and flexibility for future applications. The block diagram shown in Figure 2 illustrates the major subsystems of the drive.

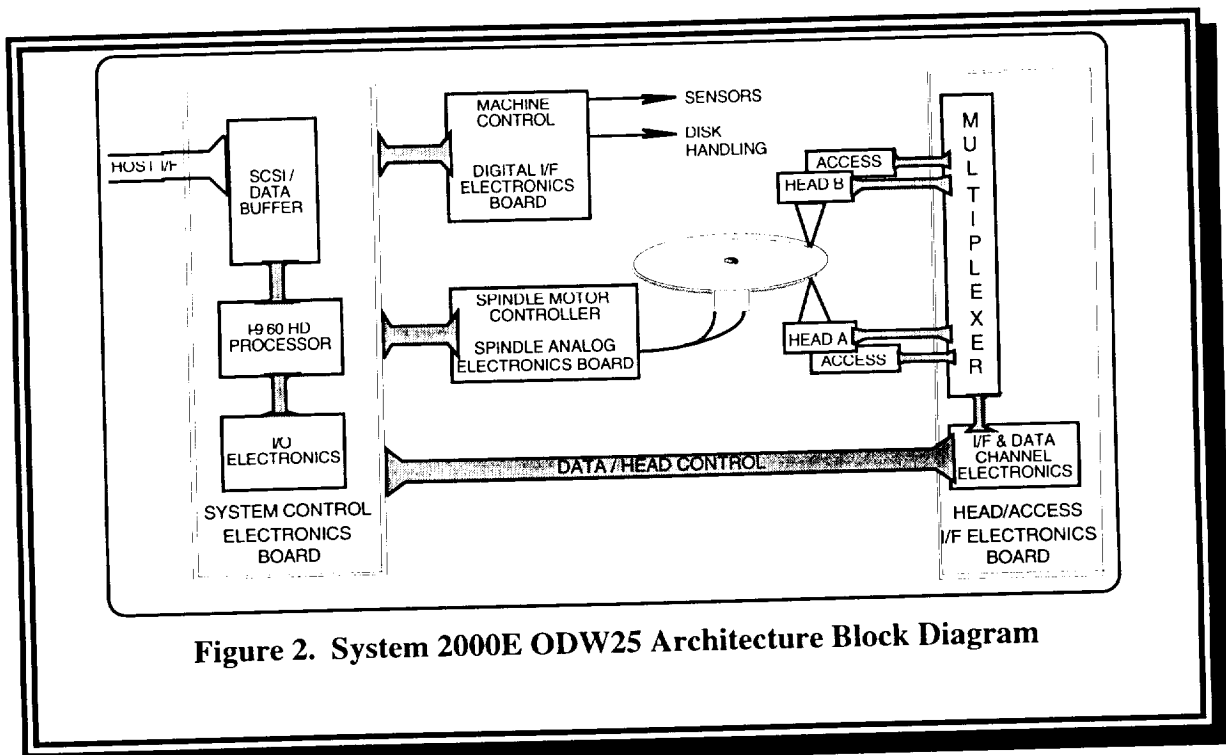

Figure 2. System 2000E ODW25 Architecture Block Diagram

The System Control Electronics (SCE) circuit board contains the Intel I-960 microprocessor which controls the entire machine, performs error detection and correction on data read back from the media in the drive and handles all communication with the host through a SCSI interface. The Digital Interface Electronics board (DIE) is responsible for all the machine control and I/O not associated with the optical head. These functions include media handling, disk clamping, temperature sensors, monitoring power supply voltages, and more. The Spindle Analog Electronics board (SAE) delivers the required power to the spindle motor and processes the hall sensor data to provide velocity feedback to the servo. The spindle motor is controlled utilizing a pulse width modulated motor driver under software servo control. The Head/Access Interface Board (HIE) processes all signals coming to, or going from, the optical heads. A multiplexer approach switches between the top and bottom heads allowing for near instantaneous access to either side of the disk. Each head is driven by its own carriage motor and motor driver to facilitate access to data on either side of the disk without external robotics. The present HIE contains only one programmable data channel and data channel controller. Future generations of the ODW25 drive will employ simultaneous access to both sides of the media platter.

Sensors integrated into the media handling robotics determine the media type upon insertion into the drive. The Intel I-960 microprocessor then "programs" the gate arrays that comprise the data channel into the proper format for that media capacity. Therefore, future media upgrades and capacity increases can be accommodated with existing hardware. Also, the data channel is fully backward compatible with previous media types.

Control of the various servo subsystems required by the optical drive to maintain media velocity, access position, focus, tracking and laser power is critical to obtain performance expectations. The machine servo control systems must meet product specifications over

a wide operating range. The ODW25 drive has utilized a digital servo system, which is controlled by the I-960 processor. These software servos provide both effective machine control and flexibility. The microprocessor samples the servo error signals from the optical head and can "tune" itself to provide optimum performance, something that cannot be accomplished with conventional analog implementations. Modifications to the optical head and head electronics required for future performance upgrades may be accommodated by "reprogramming" the servo functions without changing hardware in the drive. The software servo controls have improved diagnostic capability and reliability via the reduction in the number of electronic components required to operate the optical head.

The Error Detection and Correction (EDAC) algorithm employed by the drive is also coded in software. This concept allows real-time access to byte error rate measurement, improves reliability and lowers cost by eliminating the need for expensive ASIC's and logic arrays. The software EDAC subsystem can be easily modified for future formats as EDAC strategies change as a result of increased packing densities.

The ODW25 drive platform was conceived to provide optimum performance to the customer and maximum flexibility to allow for future upgrades without complete hardware redesign. The platform concept will protect the customer's investment in hardware and ease the integration of future features. The current drive/media system will operate at a write/read data rate of 1.5 to 2.5 megabytes per second per optical head depending upon the media type (capacity). The media is manufactured with a zoned constant angular velocity (ZCAV) format, which provides the most effective compromise between access time and media capacity. The ODW25 drive will utilize all previous media types manufactured by Kodak, 6.8 GB (read only), 10.2 GB, and 14.8 GB, as well as the upcoming 25 GB platters and beyond with additional firmware upgrades. With future performance enhancement in mind, each drive was equipped with independent access systems for each side of the disk. This will facilitate future enhancements to enable simultaneous access to both sides of the disk which will, in effect, double both the write and readback data rates without substantial hardware modifications to the drive. The ODW25 drive with the 2000E automated library will propel the user and the optical storage technology into the 21st century.

Rome Laboratory Erasable Optical Program

Program Overview

The objective of the Rome Laboratory Contract (# F30602-94-C-0047) is to develop erasable optical recording hardware and media subsystems for integration into Kodak's commercial large format drive and library system. The system portrayed in Figure 3 will be delivered to the Air Force and integrated with other storage devices (magnetic disk and magnetic tape) as part of a hierarchical storage management (HSM) system. Large file size intelligence data processing and mission planning operations will be demonstrated using the HSM solution.

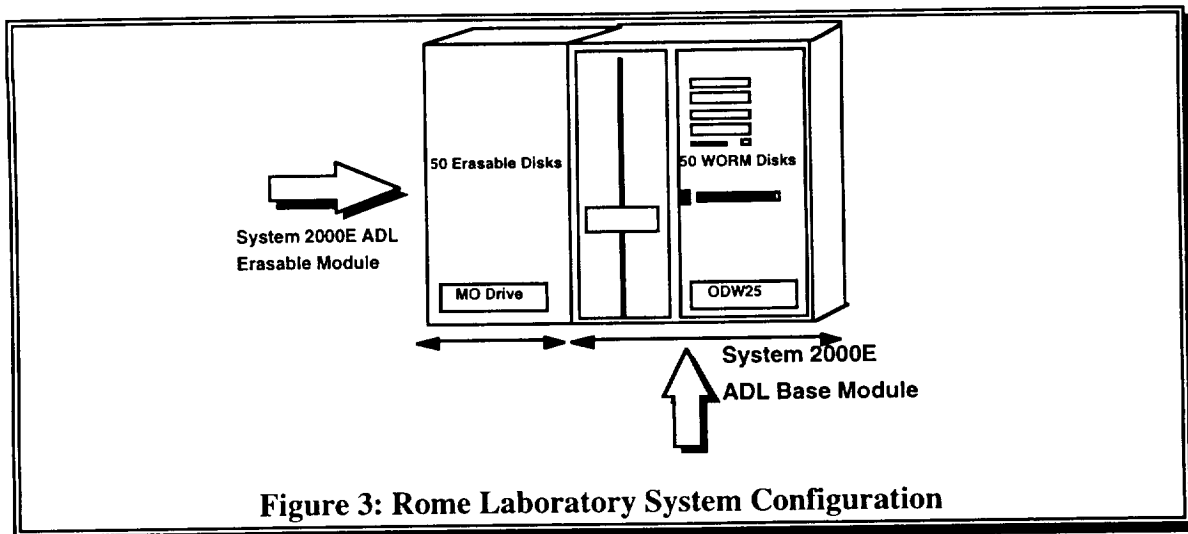

The approach employed in the program is to design the erasable subsystems utilizing and/or leveraging the commercial write-once design such that an offering of a commercial erasable drive in the future will require a minimum level of engineering work. Thus, the engineering task focus areas under development including: (1) the optical head; (2) analog conditioning/processing electronics; (3) servo written media format; and (4) high-level SCSI interface command and control software all have significant linkages to the commercial product family. Low-level servo control for laser writing and reading, focus, and tracking are aimed specifically at the MF head and erasable media.

Expanded detail of the technology development work and results obtained to date are contained in the following sections.

Magneto-Optical Media

Here we describe the overall disk structure, characterization of the individual layers, and optimization of the optical stack.

Disk Structure

A new simple trilayer disk structure was used. The disk structure, Al Substrate/Ti reflecting layer/MO layer/AiN antireflection layer, eliminates the second dielectric in the conventional quadrilayer structure, while essentially maintaining its performance. Also, it eases some of the tight manufacturing tolerance limits involved in the quadrilayer structure. Ti metal layer can be deposited more easily and at a significantly higher rate than its dielectric counterparts, e.g., AlN or Si₃N₄. Figure 4 contains a side view detail of the MO disk structure.

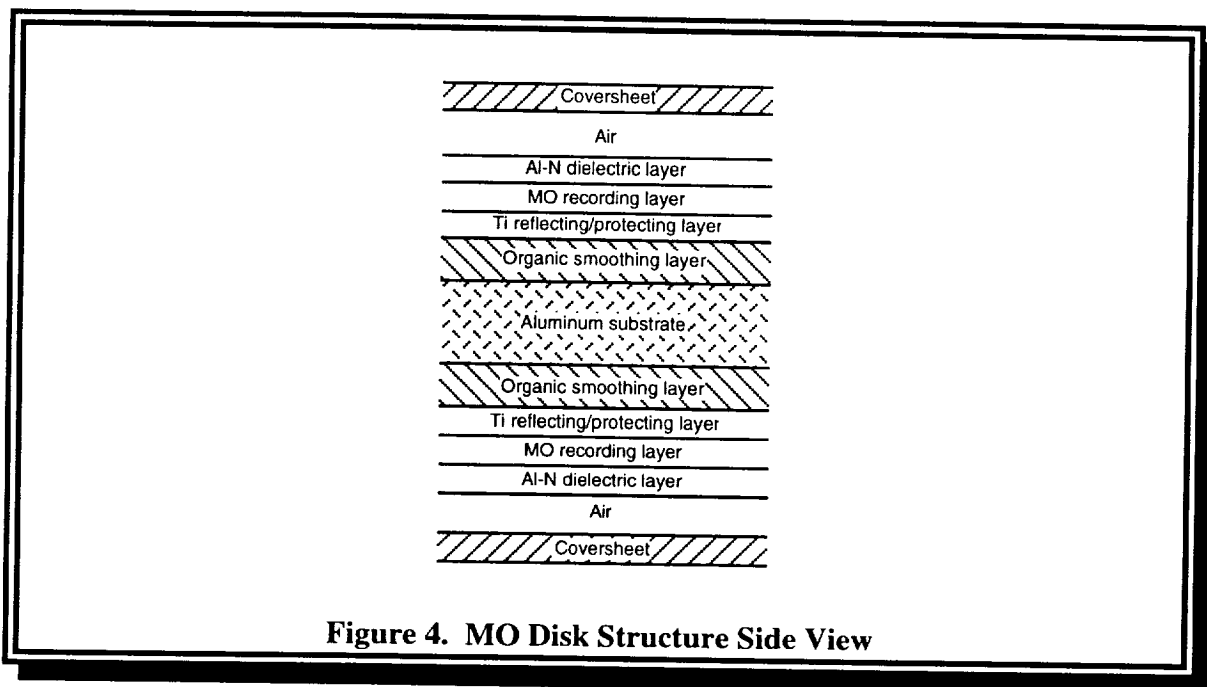

Figure 4. MO Disk Structure Side View

Magneto-optic media was fabricated using a modified Balzers LLS-801 sputter deposition system. The sputter deposition is carried out using three cathodes for depositing a Ti reflector layer, a TbFeCo-based MO layer, and the AlN dielectric layer. During deposition, the substrate is rotated around an axis perpendicular to the sputtering cathode using a turn table affixed to the indexing drum. In this way, all three layers are deposited in sequence with no vacuum break. Subsequently, a protective polycarbonate coversheet is attached and the disk is cartridge'd identically to the ODW25 product.

MO Layer Characterization

Recording Layer. The recording layer composition, thickness, and deposition conditions were chosen to provide the optimal combination of signal quality, recording power, and environmental stability. The sputtering pressure and film composition were adjusted for a coercivity less than about 10 kOe to enable static room temperature disk erasure using a large area electromagnet; this is a much faster method of initialization compared to dynamic erasure using a focused optical stylus. The circumferential variation in recording layer properties was negligible due to the rotating substrate motion, and the radial variation in thickness was held within $\pm 5\%$ using a specially designed mask. Additions of small amounts of Zr and Pd, have been shown to enhance the intrinsic environmental stability and writing sensitivity of the MO layer.

Dielectric Layer. An AlN dielectric layer was used to optimize the Kerr rotation and reflectivity of the optical stack and, importantly, to provide corrosion protection for the MO layer. It was deposited by DC reactive sputtering of an Al target in an Ar and N₂ atmosphere. The reactive AlN sputtering process involves feedback control of the N₂ flow to maintain constant current at constant pressure. The AlN mechanical and optical properties, as well as thickness uniformity are critically important for the performance of the disk. Preparation of low stress and crack-free AlN layers is essential for providing long-term corrosion protection of the oxidation susceptible MO layer. AlN films with opti-

imum properties were obtained by controlling the sputtering power, Ar:N₂ pressure ratio and total sputtering pressure. A radial thickness variation of less than $\pm 5\%$ was obtained. The measured refractive index at 680 nm for AlN is $n + ik = 2.06 + i0.01$. The low coefficient of absorption $k = 0.01$ is desirable for efficient optical performance.

Reflector Layer. Ti metal was used as a reflecting layer. Ti metal has low thermal conductivity so in addition it acts as a thermal barrier between the MO layer and the surface smoothed aluminum substrate, thus improving the writing sensitivity of the disk. The Ti layer also provides corrosion protection for the MO media from the organic surface smoothing material. Its thickness uniformity was within $\pm 5\%$, similar to the MO and dielectric layers. An additional beneficial effect of the Ti underlayer was to enhance the coercivity and squareness of the Kerr hysteresis loop, advantageous for low disk recording noise.

Optimization of Optical Stack. The multilayer stack was designed to obtain adequate figure-of-merit (reflectivity times Kerr rotation) subject to practical constraints on reflectivity and corrosion protection. Several small coupons were made with varying thickness of AlN, MO, and Ti layers. Figure 5 show variations of reflectivity R, Kerr rotation θ_k , and figure-of-merit $R\theta_k$, plotted as a function of AlN layer thickness. The optimal combination of figure-of-merit, reflectivity, and passivation was obtained for 50 nm Ti / 45 nm MO / 80 nm AlN. Several full structure disks were fabricated. A lower thickness for the MO and Ti layers was found to give higher writing sensitivity if desired. Also, it was found that the CNR performance was quite insensitive to AlN thickness, demonstrating the robustness of the optical stack design.

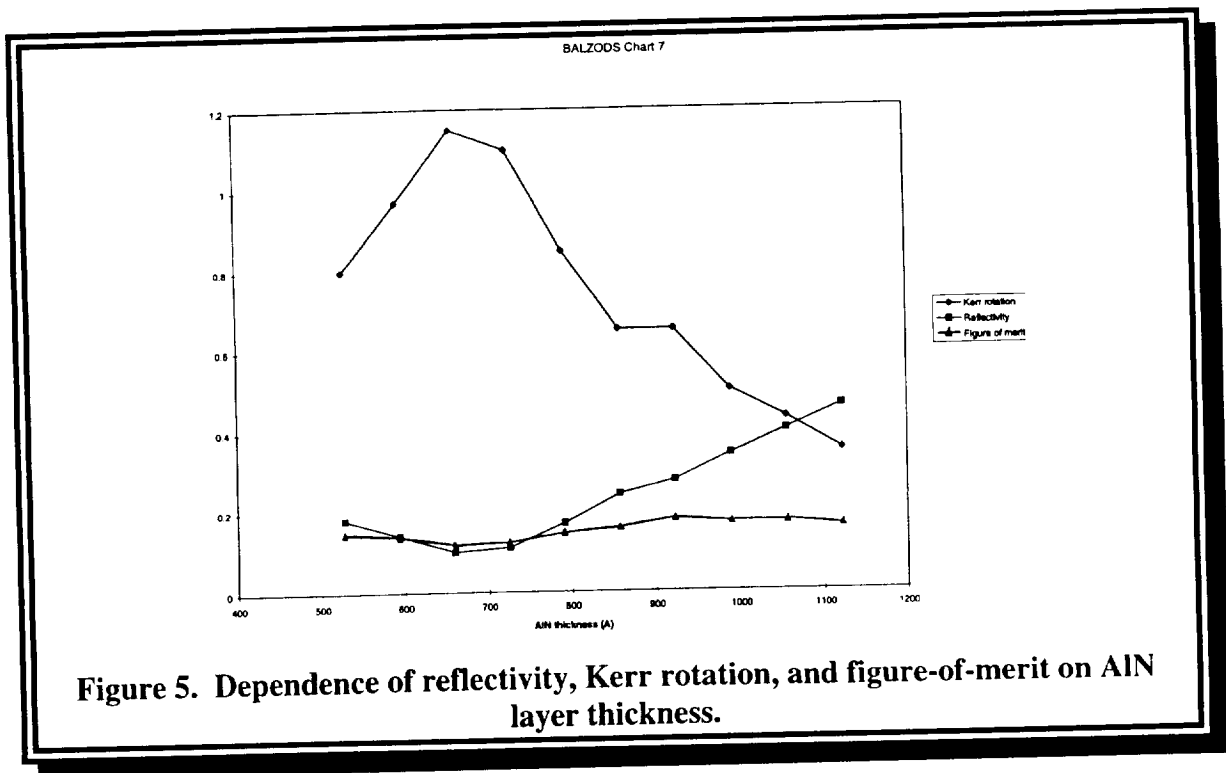

Media Keeping

A life test program was designed and carried out to characterize the media shelf life for two recording layer compositions, TbFeCo and TbFeCoZrPd. The fabrication equipment, process, and optical stack structure were identical to those intended for final disk production. Results to date, based on static measurements of coupon samples, indicate exceptional environmental stability for both compositions. In particular, no change in Kerr rotation and reflectivity have been detected after exposure to 70°C/85% RH, 90°C/17% RH, or 32°C/90% RH for six weeks.

Multifunction Optical Head and Analog Electronics

A schematic of the multifunction optical head is shown in Figure 6. The head is leveraged from the current System 2000 WORM optical head and its properties are summarized in Table 1.

The 30 mW SDL laser diode has undergone extensive testing and has been shown to be extremely reliable with very low relative intensity noise. The laser is collimated with 7.5 mm focal length, precision glass molded (Kodak A375) lens. The optical stack uses the same glass types as our commercial product to provide achromatic beam expansion. The coating on the partial PBS was redesigned to maximize the MO data signal and provide an acceptable head efficiency as described in Table 1. A turning prism reflects the beam up to the 0.55 numerical aperture (NA) molded glass objective lens. A 1.1 mm coverplate and the 90 μ m coversheet for both the MO and WORM media packages compensates for the lens design substrate thickness of 1.2 mm.

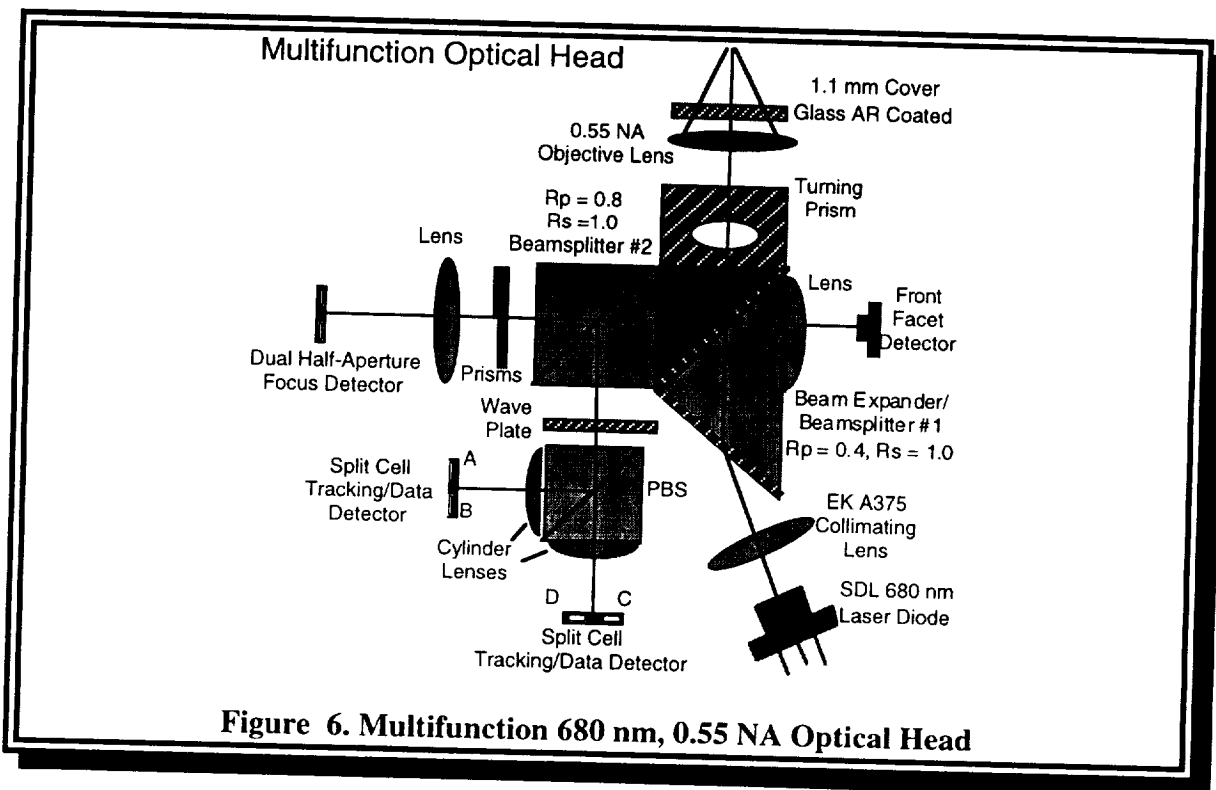

Figure 6. Multifunction 680 nm, 0.55 NA Optical Head

Table 1 Properties of 680-mm Multifunction Optical Head

Media Type	14" MO or WORM
Substrate	90 μm coversheet
Wavelength	680 nm
Spot Size FWHM	0.70 μm
Numerical Aperture	0.55
Head Efficiency	30%
Power at Disk (Maximum):	8 mW
Focus Method	Dual Half Aperture
Tracking Method	Full Aperture Push-Pull

The return path is designed to maximize the data and tracking detection signal-to-noise ratio. The return beam is reflected by the partial polarization beamsplitter #1. The dual half aperture focus detector receives $\approx 20\%$ of the p-polarization component of the return beam. The reflected light from beamsplitter # 2 is directed through a waveplate that corrects for media and head phase shifts and results in approximately equal intensity from the two beams from the polarization beamsplitter (analyzer). The two beams are brought to line foci (elongated in the cross track direction) on a pair of bi-cell detectors that provide signals A, B, C, and D for tracking error and data detection. These signals are processed by the multifunction data/tracking electronics as shown in Figure 7. The push pull tracking signals are given by:

$$\text{WORM TES} = (A + C) - (B + D) \quad (1)$$

$$\text{MO TES} = (A + D) - (B + C) \quad (2)$$

where the tracking error signal is sampled from the diffraction effects over servo written tracking pads (long data marks). The data signals are given by:

$$\text{WORM DATA} = (A + B) + (C + D) \quad (3)$$

$$\text{MO DATA} = (A + B) - (C + D) \quad (4)$$

The signal balancer electronics utilize variable gain amplifiers to minimize the effects of birefringence and laser power fluctuations on the data signals RF A and RF B before the final sum (WORM) and difference (MO) are generated according to equations 3 and 4. This additional step is required with a bi-refractive coversheet in a multifunction system.

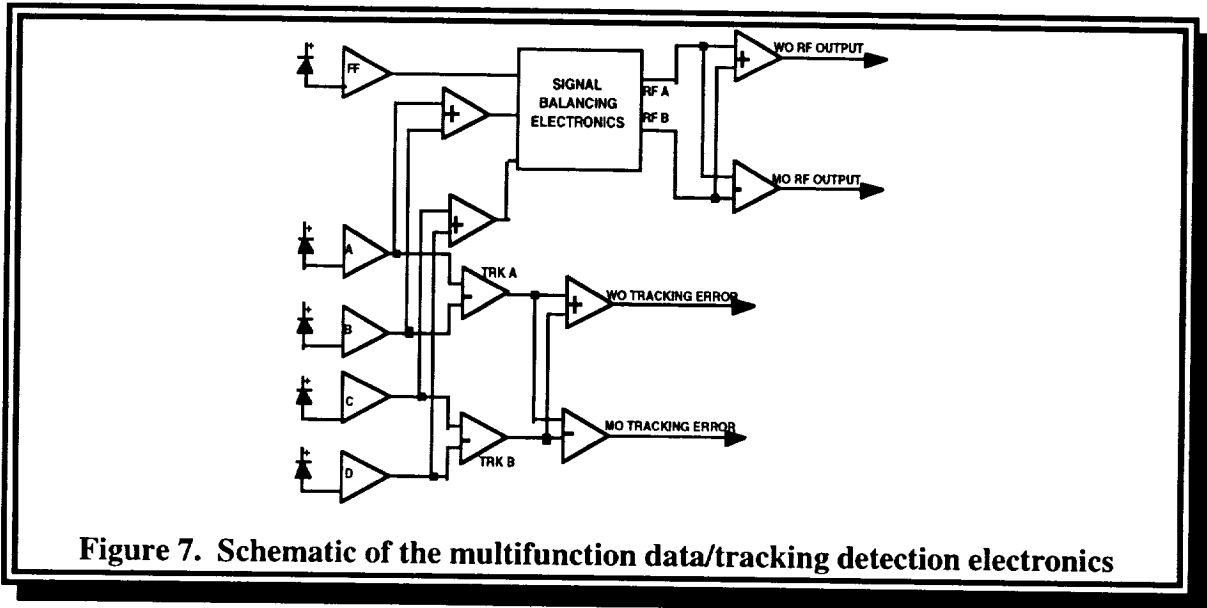

Figure 7. Schematic of the multifunction data/tracking detection electronics

Dynamic Testing

The main thrust of the dynamic testing is to ensure that the WORM performance is similar to the production WORM system and that the MO system exceeds the contract requirements for data integrity, capacity (> 10 Gigabyte/Disk), and data rate (>1 Megabytes/sec). The fundamental performance of the system with the two media types is illustrated in Figure 8. The readout spectrum of the WORM system shows a carrier-to-noise ratio in a 30 KHz bandwidth (CNR) of 57.0 dB. This was recorded at the second harmonic minimum, with an optimum recording power (ORP) of 5.1 mW. By comparison, the MO system shows a CNR of 56.5 dB at an ORP of 5.0 mW. The WORM system is dominated by media noise at low frequencies and laser noise at higher frequencies, while the MO system is dominated by electronic and shot noise. Thus the MO has a whiter noise signature and a lower integrated signal-to-noise ratio. The similarity of the ORP and CNR for WORM and MO is important to a multifunction system design.

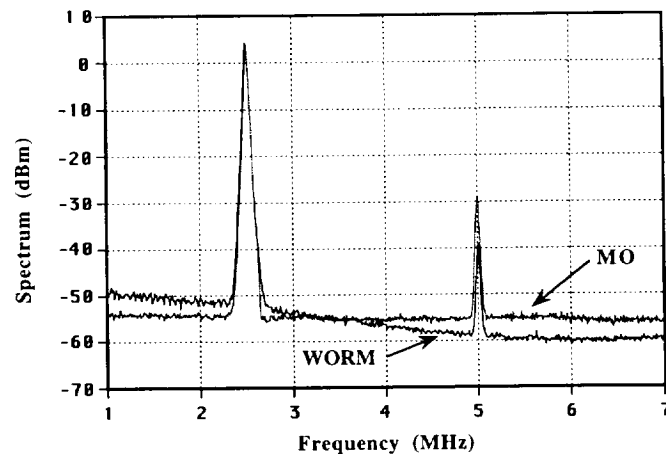

Figure 8. The readout spectrum is shown for WORM and MO readout for a 2.5 MHz tone at a media velocity of 12 m/s. The recording power is 5.1 mW for WORM and 5.0 mW for MO. The read powers are 1.0 and 1.5 mW for WORM and MO readout respectively.

This system has also been integrated with the System 2000E read channel. The figure of merit percent phase margin (% PM) indicates the amount of the bit window remaining after noise and mark length errors are considered for a raw bit error rate of 10^{-6} . Commercial goals are typically 20-50% PM depending on the systems error budget. For the multifunction drive with a worst case pattern at the conditions of 12 m/sec, MFM encoding, and a raw data rate of 10 Megabits/sec, the WORM system has a % PM of 70% consistent with our future 25 Gigabyte/Disk commercial product and the MO system has a % PM of 45%, which will allow the contract specifications to be met.

Ultrahigh Capacity Optical Disk (UCOD) Program

The National Storage Industry Consortium (NSIC) is leading an Advanced Technology R&D project with the Department of Commerce for the development of an optical data storage system that will place U.S. technology at the forefront of commercial data storage markets throughout the remainder of this century and well into the next century. The program teams Eastman Kodak Company, a leading supplier of high-end optical data storage libraries, SDL, Inc., the world-wide leader in high-power laser diode manufacturing, and Carnegie-Mellon University, a leading research facility in optical storage in a highly focused program to produce an optical data storage system with the following attributes:

- 1 Terabyte storage capacity, a 40 x increase over current technology
- 30 Megabyte/sec data transfer rate, a 10 x increase

The technology developed will be rapidly incorporated into products at both Kodak and SDL throughout the program, such that the program will serve to strengthen and solidify the technical position of many U.S. industries, including high-definition television (HDTV), medical and library data storage systems, biotechnology, and visible laser diode systems.

A four-year research and development program (Fiscal Year 1996-1999) with four major technologies is underway. The four technology areas are: (1) advanced laser sources, (2) multilayer media technology, (3) advanced channel coding techniques, and (4) high numerical aperture optics development. The development is being pursued in three major phases. An assessment phase will concentrate on gathering data and building integrated models. The experimental phase will include targeted work on the four technology elements discussed above using refined goals from the assessment. The final stage is the design, fabrication, and testing of the a prototype system. The technical challenges in this development are listed in the Table 2.

Table 2: Research Task/Barrier/Approach Matrix

Task	Barrier	Primary Approach
• Multilayer media	Ultra-thin film performance	Self passivation, new materials
• Blue Light source	Crystal damage	Fabrication, Doubling Method
• High NA Objective	Aberration Tolerances	Molded precision glass
• High Density Code	SNR Requirements	PRML

While the Rome Laboratory (RL) program will provide the first Beta version of Magneto-Optic recording subsystems integrated in a commercial drive platform, the UCOD program will leverage the RL program and advance state-of-the-art in write-once and erasable optical recording.

Conclusions

A key component of the "platform approach" of the ODW25 was to provide the capability to implement future enhancements with reduced resources and cycle times. The Rome Laboratory erasable optical project has utilized the platform effectively. The direct compatibility of the multifunction optical head, media substrate and cartridge, and implementation of featureless servo written formatted media will provide the capability to commercialize a multifunction drive in the future. The UCOD program will develop new technology which will continue to efficiently add significant performance improvements to the ODW25 platform.

References

1. T.W. McDaniel and F.O. Sequeda, *Appl. Phys. Commun.* 11, 427 (1992).
2. T.K. Hatwar, *J. Appl. Phys.* 70, 6335 (1991).
3. E. C. Gage, S. Beckens, P. Cronkite, S. Dohmeier, D. Kay, M. Meichle, and R. Metzger, "Low Noise, High Reliability 680 nm Optical Head Enables Robust 14.9 Gigabyte/Disk Product," *SPIE Proc. Vol. 2514, Optical Data Storage '95*, eds. G. R. Knight, H. Ooki, and Y. S. Tyan, p. 129 (1995).
4. D. B. Kay, S. B. Chase, E. C. Gage, and B. D. Silverstein, "Write Noise from Optical Heads with Non-Achromatic Beam Expansion Prisms," *SPIE Proc. Vol. 1499, Optical Data Storage '91*, eds. J. J. Burke, T. A. Shull, and N. Imamura, p. 281 (1991).
5. E. C. Gage and B. J. Bartholomeusz, "Directional Asymmetries due to Write-Laser Mode Hopping during Optical Recording," *J. Appl. Phys.* 69, 569 (1991).

REPORT DOCUMENTATION PAGE

Form Approved
OMB No. 0704-0188

Public reporting burden for this collection of information is estimated to average 1 hour per response, including the time for reviewing instructions, searching existing data sources, gathering and maintaining the data needed, and completing and reviewing the collection of information. Send comments regarding this burden estimate or any other aspect of this collection of information, including suggestions for reducing this burden, to Washington Headquarters Services, Directorate for Information Operations and Reports, 1215 Jefferson Davis Highway, Suite 1204, Arlington, VA 22202-4302, and to the Office of Management and Budget, Paperwork Reduction Project (0704-0188), Washington, DC 20503.

1. AGENCY USE ONLY (Leave blank)		2. REPORT DATE September 1996	3. REPORT TYPE AND DATES COVERED Conference Publication	
4. TITLE AND SUBTITLE Fifth Goddard Conference on Mass Storage Systems and Technologies - Volume II			5. FUNDING NUMBERS Code 505	
6. AUTHOR(S) Benjamin Kobler and P. C. Hariharan				
7. PERFORMING ORGANIZATION NAME(S) AND ADDRESS (ES) Goddard Space Flight Center Greenbelt, Maryland 20771			8. PERFORMING ORGANIZATION REPORT NUMBER 96B00117	
9. SPONSORING / MONITORING AGENCY NAME(S) AND ADDRESS (ES) National Aeronautics and Space Administration Washington, DC 20546-0001			10. SPONSORING / MONITORING AGENCY REPORT NUMBER NASA CP-3340, Vol. II	
11. SUPPLEMENTARY NOTES Kobler: Goddard Space Flight Center, Greenbelt, Maryland; Hariharan: Systems Engineering and Security, Inc., Greenbelt, Maryland				
12a. DISTRIBUTION / AVAILABILITY STATEMENT Unclassified - Unlimited Subject Category 82 Availability: NASA CASI (301) 621-0390.			12b. DISTRIBUTION CODE	
13. ABSTRACT (Maximum 200 words) This document contains copies of those technical papers received in time for publication prior to the Fifth Goddard Conference on Mass Storage Systems and Technologies held September 17 - 19, 1996, at the University of Maryland, University Conference Center in College Park, Maryland. As one of an ongoing series, this conference continues to serve as a unique medium for the exchange of information on topics relating to the ingestion and management of substantial amounts of data and the attendant problems involved. This year's discussion topics include storage architecture, database management, data distribution, file system performance and modeling, and optical recording technology. There will also be a paper on Application Programming Interfaces (API) for a Physical Volume Repository (PVR) defined in Version 5 of the Institute of Electrical and Electronics Engineers (IEEE) Reference Model (RM). In addition, there are papers on specific archives and storage products.				
14. SUBJECT TERMS Magnetic tape, magnetic disk, optical disk, mass storage, software storage, digital recording, data compression, storage architecture, optical recording, database management.			15. NUMBER OF PAGES 348	
			16. PRICE CODE	
17. SECURITY CLASSIFICATION OF REPORT Unclassified	18. SECURITY CLASSIFICATION OF THIS PAGE Unclassified	19. SECURITY CLASSIFICATION OF ABSTRACT Unclassified	20. LIMITATION OF ABSTRACT UL	

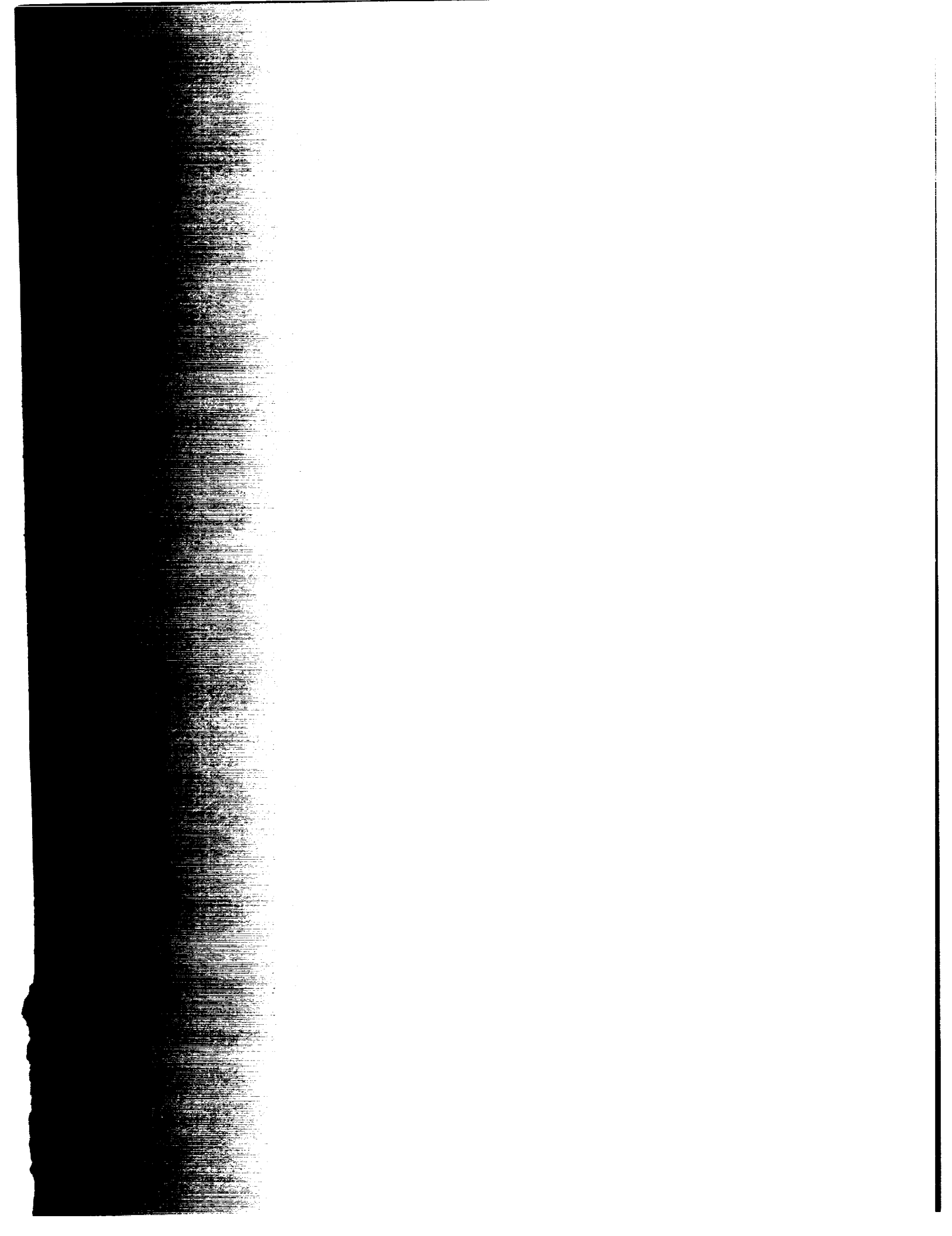

National Aeronautics and
Space Administration

Goddard Space Flight Center
Greenbelt, Maryland 20771

Official Business

Penalty for Private Use, \$300

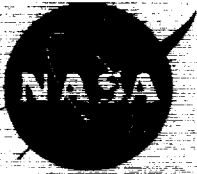

POB