

11-115
93057

NASA Contractor Report 4751

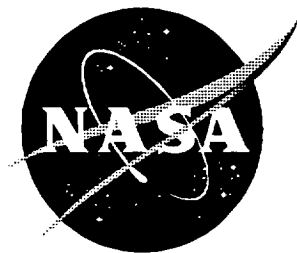

Standard Test Methods for Textile Composites

John E. Masters and Marc A. Portanova

Contract NAS1-19000
Prepared for Langley Research Center

September 1996

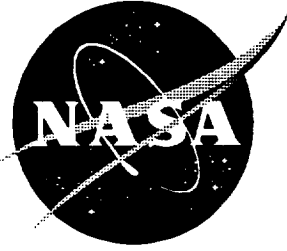

Standard Test Methods for Textile Composites

*John E. Masters and Marc A. Portanova
Lockheed Martin Engineering & Sciences Company • Hampton, Virginia*

Printed copies available from the following:

NASA Center for AeroSpace Information
800 Elkridge Landing Road
Linthicum Heights, MD 21090-2934
(301) 621-0390

National Technical Information Service (NTIS)
5285 Port Royal Road
Springfield, VA 22161-2171
(703) 487-4650

Table of Contents

| | |
|---|-----|
| Abstract | 3. |
| 1. Introduction | 4. |
| 2. Description of Materials | 6. |
| 3. Standard Guide for the Instrumentation of Textile Composites | 16. |
| 4. Standard Method for Unnotched Tension Testing | 23. |
| 5. Standard Method for Unnotched Compression Testing | 32. |
| 6. Standard Method for Open Hole Tension Testing | 42. |
| 7. Standard Method for Open Hole Compression Testing | 49. |
| 8. Standard Method for Filled Hole Tension Testing | 60. |
| 9. Standard Method for Bolt-Bearing Testing | 68. |
| 10. Standard Method for Interlaminar Tension Testing | 76. |

Abstract

Standard testing methods for composite laminates reinforced with continuous networks of braided, woven, or stitched fibers have been evaluated. The microstructure of these "textile" composite materials differs significantly from that of tape laminates. Consequently, specimen dimensions and loading methods developed for tape type composites may not be applicable to textile composites. To this end, a series of evaluations were made to assess the applicability of testing practices currently used in the composite industry to textile composite materials.

Information was gathered from a variety of sources and analyzed to establish a series of recommended test methods. The current practices established for laminated composite materials by ASTM and the MIL-HDBK-17 Committee were considered. This document provides recommended test methods for determining both in-plane and out-of-plane properties. Specifically, test methods are suggested for:

- Unnotched Tension and Compression
- Open and Filled Hole Tension
- Open Hole Compression
- Bolt Bearing
- Interlaminar Tension

A detailed description of the material architectures evaluated is also provided, as is a recommended instrumentation practice.

Introduction

Textile composite materials have been extensively evaluated in NASA's Advanced Composite Technology (ACT) Program, which was initiated in 1990 to develop less costly composite aircraft structures. Composite laminates reinforced with continuous networks of braided, woven, knit, or stitched fibers have all been tested as a part of the program. Based on these test results, the viability of these material forms as potential alternatives to unidirectional prepreg tape has been established.

These new composite material forms bring with them potential testing problems. The test methods currently used to evaluate composite materials were developed for composite materials made of unidirectional prepreg tape or simple 2-D woven fabrics. The microstructure of these laminated composite materials differs significantly from the architectures of the braided, woven, knit, and stitched materials under investigation. Consequently, the applicability of the current test methods to the wide range of emerging materials bears investigation. The overriding concern is that the values measured are accurate representations of the true material response.

Fiber architecture plays a prime role in determining the mechanical response of textile composite materials. Inhomogeneous local displacement fields develop within the textile laminates, even under uniform axial extension, as a result of the interweaving and interlacing of the yarn bundles. This is not seen in laminates formed of unidirectional tape materials. Specimen dimensions and loading methods developed for tape type composites may, therefore, not be applicable to textile composites.

A program to establish a set of test methods to evaluate textile composites was developed to address these issues. The results of that program are summarized in this report.

Introduction

Information was gathered from a variety of sources and analyzed to establish the recommended test methods. The current practices established by ASTM and the MIL-HDBK-17 Committee for laminated composite materials were considered. Test data developed by the Boeing Defense and Space Group under contract to NASA was the primary source of information on test method development for textile composite materials. In addition, Lockheed Aeronautical Systems Company conducted an extensive materials evaluation program on braided and woven textile systems. The test practices and data developed in that program were also evaluated.

This report has been preceded by a series of contractor reports that extensively review the data and detail the analysis that led to the establishment of the individual test methods and practices. They are referenced in the following sections. The reader should seek additional details in these documents.

The following section provides a detailed description of the materials investigated. It is followed by a recommended instrumentation practice for textile composites and a series of recommended test methods.

Description of Materials

The primary contributor of test data to this report was the Boeing Defense and Space Group in Philadelphia, PA. Supplemental data, obtained from Lockheed Aeronautical Systems in Marietta, GA and West Virginia University (WVU) in Morgantown, WV, was also reviewed. Most of the data was derived from tests on two-dimensional triaxial braids and three-dimensional interlocking weaves. Test results obtained for three-dimensional braided materials by Lockheed and for stitched uniweaves by Boeing were also considered.

All 2-D and 3-D fabric preforms were constructed using Hercules AS4 fibers. They were manufactured by outside sources and then resin transfer molded (RTM) at Boeing or Lockheed facilities. The resin systems employed were formulated to have properties similar to Hercules 3501-6. They are low-cost brittle epoxy systems with low viscosity at melt temperature that lend themselves to the resin transfer molding process. The specifics of each material system are described in the following sections.

2-Dimensional Triaxial Braids

In a triaxially braided preform three yarns are intertwined to form a single layer of $0^\circ / \pm \Theta^\circ$ material. Each $+\Theta$ yarn crosses alternatively over and under two $-\Theta$ yarns and vice versa. The 0° yarns were inserted between the braided yarns. This yields a two-dimensional material; there is no through-the-thickness reinforcement. Figure 1 schematically illustrates the fiber architecture and establishes the nomenclature used in the paper.

Fiber Innovations Inc., of Norwood, MA, braided all the 2-D fabric preforms investigated. Boeing and WVU evaluated identical 2-D braided architectures; Lockheed's braids were slightly different. The Boeing and WVU material was RTM'd using Shell RSL-1895 epoxy resin and cured at Boeing. Details of their manufacturing process can be obtained in Ref. [1]. Lockheed's

Description of Materials

2-D material was RTM'd using PR-500 epoxy resin and was cured at Lockheed's facility in Marietta, GA.

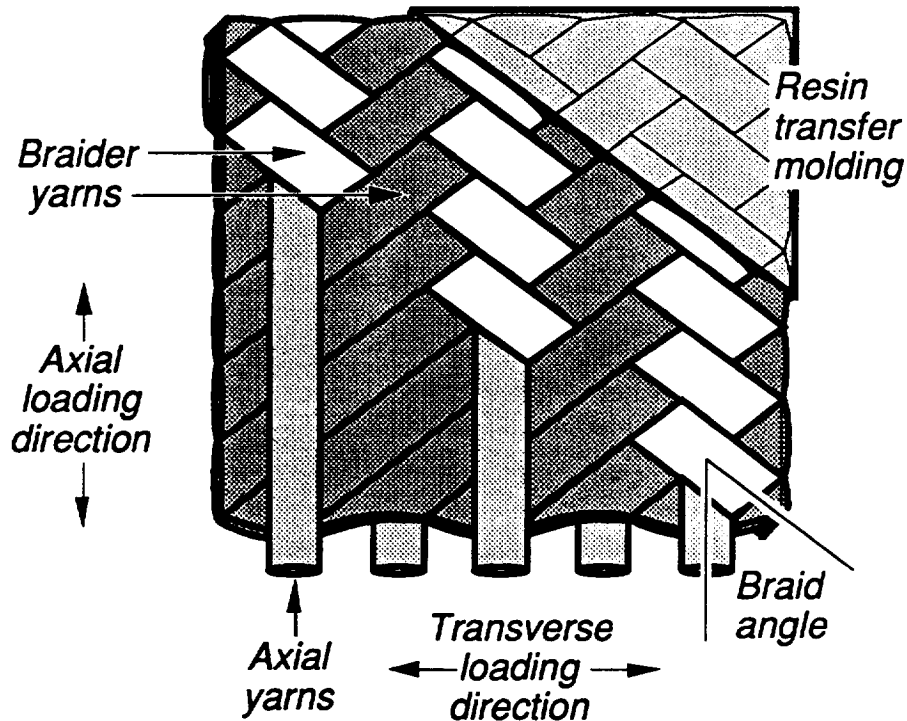

Figure 1. Illustration of a Typical 2-D Triaxial Braid.

A shorthand notation, similar to the practice used to define the stacking sequence of laminates formed of unidirectional prepreg tape, has been developed to define the braid architecture. The proposed notation is

$$[0^\circ \text{ xk} / \pm \Theta^\circ \text{ yk}] \text{ N\% Axial}$$

where: Θ indicates the braid angle,
x indicates the number of fibers in the axial yarn bundles,
y indicates the number of fibers in the braided yarn bundles,
k indicates thousands, and
N indicates the percentage by volume of axial yarns in the preform

Description of Materials

Boeing and WVU tested four 2-D triaxial braid architectures; Lockheed evaluated two. The specifics of each are given in Tables 1 and 2.

Table 1. Description of Boeing's 2-D Braided Architectures.

| Braid Code | Axial Yarn Size | Braided Yarn Size | Axial Yarn Content (%) | Braid Angle (°) | Unit Cell Width (inch) | Unit Cell Length (inch) |
|-------------------------------|-----------------|-------------------|------------------------|-----------------|------------------------|-------------------------|
| [030K/±70 ₆ K]46% | 30 k | 6 k | 46 | ±70 | 0.458 | 0.083 |
| [036K/±45 ₁₅ K]46% | 36 k | 15 k | 46 | ±45 | 0.415 | 0.207 |
| [075K/±70 ₁₅ K]46% | 75 k | 15 k | 46 | ±70 | 0.829 | 0.151 |
| [06K /±45 ₁₅ K]12% | 6 k | 15 k | 12 | ±45 | 0.415 | 0.207 |
| [015K/±70 ₃ K]46% | 15 k | 3 k | 46 | ±70 | 0.349 | 0.063 |
| [030K/±45 ₁₂ K]47% | 30 k | 12 k | 47 | ±45 | 0.349 | 0.175 |
| [015K/±45 ₆ K]47% | 15 k | 6 k | 47 | ±45 | 0.262 | 0.131 |

Table 2. Description of Lockheed's 2-D Braided Architectures.

| Braid Code | Axial Yarn Size | Braided Yarn Size | Axial Yarn Content (%) | Braid Angle (°) |
|------------------------------|-----------------|-------------------|------------------------|-----------------|
| [012K/±60 ₆ K]33% | 12 k | 6 k | 33.3 | ±60 |
| [024K/±60 ₆ K]50% | 24 k | 6 k | 50 | ±60 |

3-Dimensional Braids and Weaves

Although the largest portion of the data were gathered for 2-D braided materials, Boeing and Lockheed also evaluated a variety of materials reinforced with three-dimensional fibrous preforms. Boeing tested 3-D woven materials; Lockheed evaluated both 3-D woven and 3-D braided systems.

Description of Materials

Three types of 3-D interlocking weave configurations were investigated: through-the-thickness orthogonal interlock, through-the-thickness angle interlock, and a layer-to-layer interlock. They all provide true through-the-thickness reinforcement by interlacing yarns in the z direction. These three configurations are shown schematically in Figure 2. The specifics of each of the 3-D weave constructions investigated are given in Tables 3 and 4.

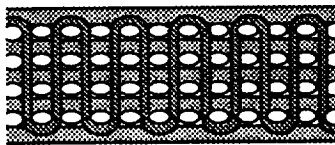

Orthogonal Interlock

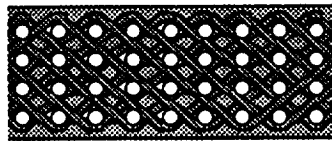

Angle Interlock

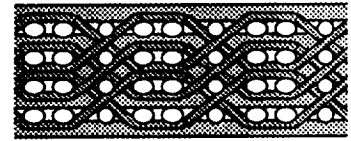

Layer-to-Layer Interlock

Figure 2. Schematics of the Three 3-D Interlock Weave Types Investigated.

Boeing evaluated six 3-D woven architectures. They are described in detail in Table 3. The preforms were produced by Textiles Technologies Inc. and, like the 2-D braids, molded and cured at Boeing using Shell RSL-1895 epoxy. As the table indicates, two yarn sizes were investigated for each of the three weave patterns studied.

Description of Materials

Table 3. Description of Boeing's 3-D Interlock Woven Architectures.

| Description | Warp Yarn | Weft Yarn | Weaver Yarn | Macro Cell (inch) | Unit Cell (inch) |
|---|------------|------------|-------------|-------------------|------------------|
| Through-the-Thickness Orthogonal Interlock | 24 k (59%) | 12 k (33%) | 6 k (7.4%) | — | — |
| | 12 k (58%) | 6 k (37%) | 3 k (6.1%) | 0.130 x 0.140 | 0.065 x 0.070 |
| Through-the-Thickness Angle Interlock | 24 k (57%) | 12 k (33%) | 6 k (9.8%) | 0.895 x 0.435 | 0.445 x 0.085 |
| | 12 k (56%) | 6 k (38%) | 3 k (5.8%) | 0.905 x 0.490 | 0.455 x 0.070 |
| Layer-to-Layer Interlock | 24 k (58%) | 12 k (34%) | 6 k (6.8%) | 0.375 x 0.355 | 0.185 x 0.070 |
| | 12 k (57%) | 6 k (36%) | 3 k (5.9%) | 0.355 x 0.565 | 0.180 x 0.080 |

Lockheed evaluated two interlocking weave constructions. They are described in Table 4. Their preforms were also produced by Textiles Technologies Inc. They were RTM'd at Lockheed using PR-500 epoxy. Although Lockheed's preforms were similar in design to Boeing's, they were constructed with different size tows and contained a different percentage of axial yarns. Thus, a direct comparison can not be made with Boeing's results.

Table 4. Description of Lockheed's 3-D Woven Architectures.

| Name | Description | Warp Yarn | Weft Yarn | Weaver Yarn |
|-------|--|--------------|-------------|-------------|
| TTT-2 | Through-the-Thickness Angle Interlock | 12 k (47.7%) | 6 k (44.4%) | 3 k (7.9%) |
| LTL-1 | Layer-to-Layer Interlock | 6 k (45.7%) | 6 k (46.1%) | 3 k (8.2%) |
| LTL-2 | | 12 k (46.3%) | 6 k (45.6%) | 3 k (8.1%) |

Lockheed also produced and tested three 3-D braid configurations. The specifics of each are described in Table 5. These 3-D fabrics were braided by Atlantic Research Corp. and then RTM'd at Lockheed using PR-500 epoxy resin.

Description of Materials

Table 5. Lockheed's 3-D Braided Architectures.

| Name | Braid Angle | Axial Tow | Bias Tow |
|-------|-------------|-------------|-------------|
| TTT-1 | ± 60 | 6 K (30.3%) | 6 K (69.7%) |
| TTT-2 | ± 60 | 18K (56.3%) | 6 K (43.7%) |
| TTT-3 | ± 60 | 6 K (38.9%) | 6 K (61.1%) |

Stitched Uniweaves

Stitched uniweaves were also evaluated by Boeing. The uniweave fabric was produced by Textile Technologies Inc., stitched by Cooper Composites, and then RTM'd at Boeing. All the materials tested featured a 48 ply quasi-isotropic, $[+45/0/-45/90]_6s$, layup. The stitching media and density were varied to provide a measure of their effect on performance. The specifics of each preform are described below in Table 6. An illustration of a typical stitched uniweave is shown in Figure 3.

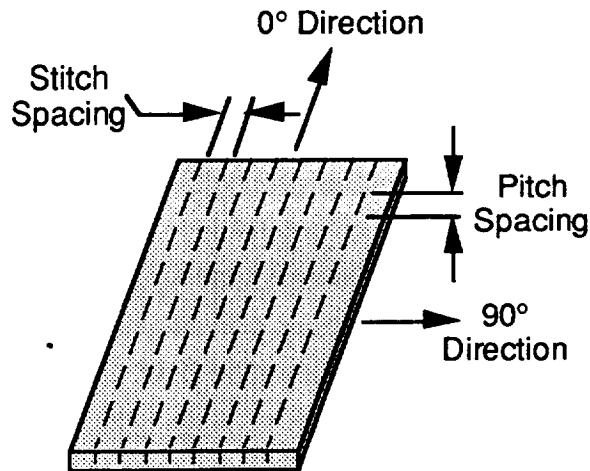

Figure 3. Illustration of the Stitched Uniweave Construction.

Description of Materials

Table 6. Description of Boeing's Stitched Uniweave Architectures.

| Name | Stitch Material | Pitch Spacing (Stitches /inch) | Stitch Spacing (inch) | Stitch Yarn Size |
|------|-----------------|-----------------------------------|--------------------------|---------------------|
| SU-1 | S2 Glass | 8 | 0.125 | 3 k |
| SU-2 | S2 Glass | 8 | 0.125 | 6 k |
| SU-3 | Kevlar 29 | 8 | 0.125 | 6 k |
| SU-4 | Kevlar 29 | 4 | 0.250 | 6 k |
| SU-5 | Kevlar 29 | 8 | 0.125 | 12 k |

The Unit Cell

A textile composite's preform architecture presents a variety of size effects that are not encountered in tape laminates. A convenient way to analyze a textile composite is to consider a unit cell of the material. A unit cell is defined as a unit of repeated fiber architecture. It may be considered the building block of the material. The size of the unit cell is dependent on a number of factors including the size of the yarns, the angle at which they are intertwined or interwoven, and the intricacy of the braid or weave pattern.

Figure 4 shows a repeated unit of the braid architecture that is sometimes referred to as the braid's natural unit cell. It represents the complete yarn or tow intertwinement pattern. It is desirable, for analysis purposes, to define the smallest unit cell possible. Rectangular unit cells are also preferable. The box outlined within the rhombic natural unit cell defines the smallest unit cell for the triaxial braids tested in this investigation [Ref. 2].

In a 2-D triaxial braid, the unit cell width is dependent on mandrel diameter and the number of yarns braided. The height of the unit cell is dependent on the cell width and the braid angle. In this document, the unit cell width of a 2-D braid is defined as twice the spacing of the axial tows. Axial tow spacing can be calculated by multiplying the braider mandrel diameter by π ,

Description of Materials

then dividing the result by the number of axial carrier yarns. The unit cell length is calculated by multiplying the cotangent of the braid angle by half the unit cell width. The sizes of the minimum unit cells for the braids tested at Boeing are summarized in Table 1.

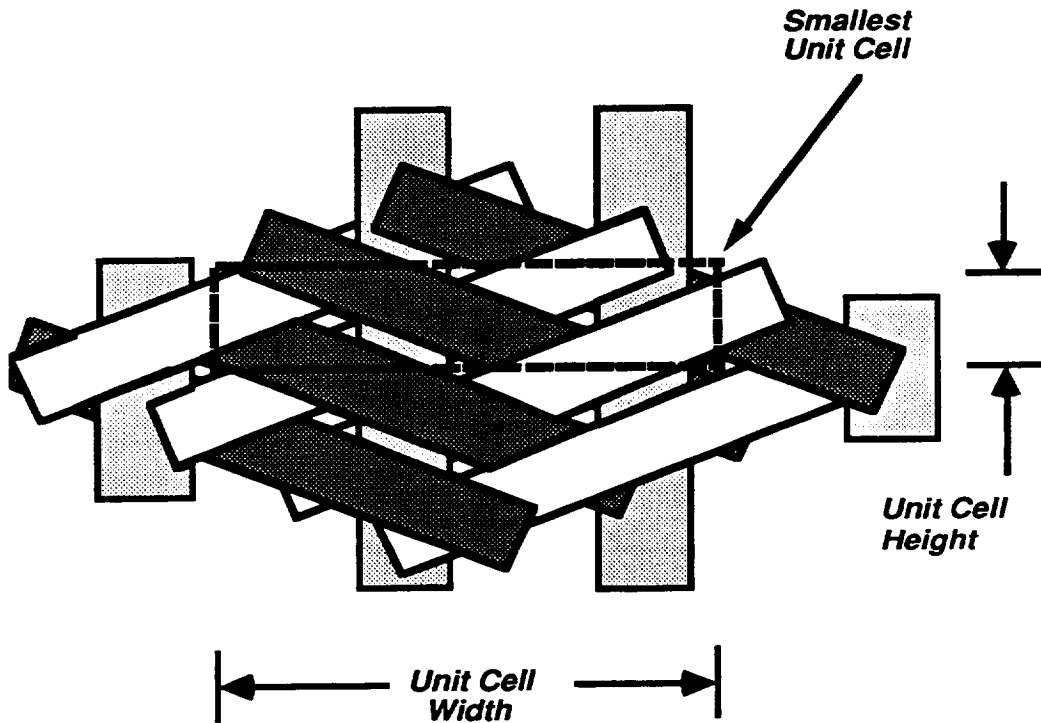

Figure 4. Definition of the Unit Cell in a 2-D Triaxial Braid.

Repeated units of fabric geometry, or unit cells, have also been defined for the 3-D woven materials. Chou et. al. [Ref. 3], for example, have defined macro unit cells for these woven laminates that are analogous to the natural unit cell defined for 2-D braids. The depth of these macro unit cells is equal to the laminate thickness. Their length is defined by the length of the periodic interlocking yarns. Figure 5a, for example, illustrates the cross section of a TS-1 through-the-thickness interlock laminate. In this case, the length of the macro unit cell is defined by the wavelength, a , of the yarn as it completes one cycle through the laminate thickness.

Description of Materials

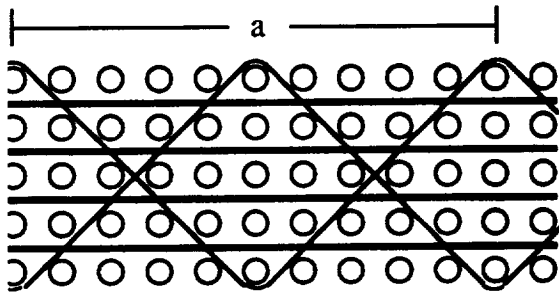

Fig. 5a. Cross Section No. 1.

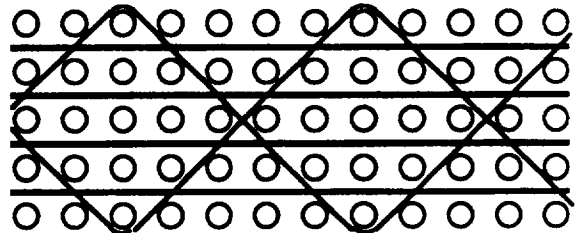

Fig. 5b. Cross Section No. 2.

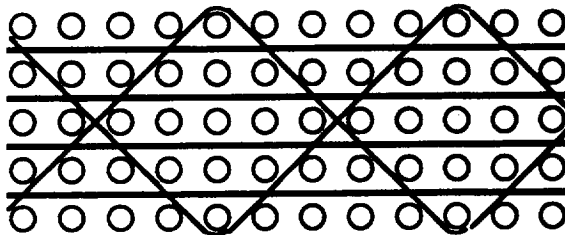

Fig. 5c. Cross Section No. 3.

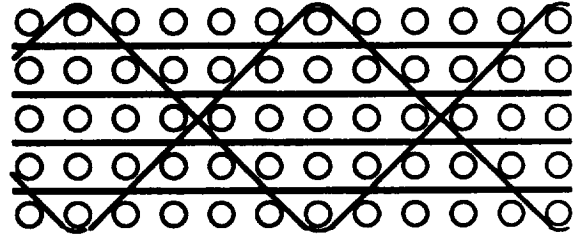

Fig. 5d. Cross Section No. 4.

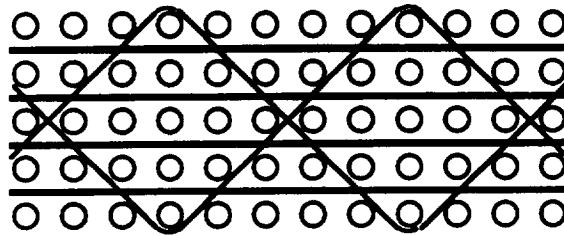

Fig. 5e. Cross Section No. 5.

Figure 5. Cross-Sections of Woven Laminate TS1.

In practice, the patterns of the yarns woven through the laminate's thickness, as shown in Figure 5a, are staggered across the width of the material. To demonstrate, Figure 5 illustrates five adjacent cross-sections of a TS-1 laminate. As the figure illustrates, the relative positions of the through-the-thickness yarns vary at each cross-section. The yarns would return to the positions shown in Figure 5a if a sixth cross section were illustrated. The widths of the macro cells were defined by the number of units required to complete this cycle. Schematic cross sections of the six interlocking weaves investigated in this study are illustrated in Ref. 4. The wavelengths of the yarns woven through

Description of Materials

the laminates' thicknesses are illustrated in the figures. The relative positions of these yarns in the adjacent laminate cross sections are also illustrated.

Table 3 lists the dimensions of the macro unit cells for the woven materials investigated at Boeing. The values listed in the table were experimentally determined through direct measurements of sectioned laminates [Ref. 3].

As in the case of the 2-D triaxial braids, smaller unit cells may also be defined within the macro cells of the woven laminates. For the woven laminates investigated in this study, they are defined as one half the interlocking yarn's wavelength, $a/2$. Their widths are determined by dividing the macro cell's width by the number of sections required to complete the cycle, i.e., five for the TS-1 and LS-1 laminates, seven for the TS-2 and LS-2 laminates, and four or two for the OS-1 and OS-2 laminates, respectively. The dimensions of these smaller, building block unit cells are also listed in Table 3 for each weave architecture.

References

1. Falcone, A., Dursch, H., Nelson, K., Avery, W., "Resin Transfer Molding of Textile Composites," NASA Contractor Report 191505, March 1993.
2. Masters, J. E., et. al., "Mechanical Properties Of Triaxially Braided Composites: Experimental And Analytical Results," Journal of Composites Technology and Research, JCTRER, Vol. 15, No. 2, Summer 1993.
3. Hardranft, D., Parvizi-Majidi, A., and Chou, T.-W., "Testing and Characterization of Through-the-thickness Properties of Multi-Directionally Reinforced Textile Composites," Quarterly Progress Report, NASA Advanced Composites Technology: Mechanics of Textile Composites Work Group, March 1994, pp. 219 - 249.
4. Masters, J. E., Strain Gage Selection Criteria for Textile Composite Materials, NASA Contractor Report 198286, Feb. 1996.

Standard Guide for the Instrumentation of Textile Composites

Introduction:

Inhomogeneous local displacement fields develop within textile composite materials even under uniaxial loading conditions as a result of the interweaving and interlacing of the yarn bundles. For example, significant variations in the applied normal strain, ϵ_y , have been measured in 2-D braided laminates subjected to uniform axial extension [Ref. 2.1.1]. In this instance the local normal strains within the material's unit cell varied by a factor of 2. The variations were located on the surface over the fiber bundles; normal strain was nearly constant throughout all of the resin rich zones between yarns. Inhomogeneous displacement fields of this type are not typically seen in laminates formed of unidirectional tape materials.

The preceding example illustrates the significance of the variations in displacement field homogeneity that have been identified in textile composite

specimens. Test specimens must, therefore, be designed to encompass representative volumes of material within their test sections to obtain characteristic measures of mechanical response. The size and type of instrumentation used plays a similarly critical role in obtaining accurate measurements.

There are, of course, two common methods of instrumenting test specimens: strain gages and extensometers. Extensometers provide a more global measure of material response and will cost less in the long run since they are reusable. They have been applied effectively to textile composite materials.

Extensometers are not, however, applicable to all test situations. For example, although suitable for coupon testing, extensometers cannot be easily mounted to large test panels. Once mounted, extensometers can also limit specimen handling. In most

Instrumentation Guide for Textile Composites

cases this would disturb the continuity of their measurements.

Strain gages are more versatile; they can be applied to a wider variety of test situations. They are permanently affixed to the specimen and, therefore, permit its removal from the test machine for inspection, etc. Strain gages do, however, provide only a local measure of the material response and are, therefore, subject to local inhomogeneity. In particular, the inhomogeneity of the local displacement fields that develop in textile composites present a special challenge to strain gage usage.

An experimental investigation [Ref. 2.1.2] was conducted to establish performance levels for strain gages on textile composites and to determine the sensitivity of strain measurements to the size of the strain gage. The results of that study were analyzed to establish a set of recommendations for the use of strain gages on textile composites. These recommendations are summarized in this guide.

1. Scope.

1.1 This guide defines recommended procedures for instrumenting textile composite materials to measure the strains that develop in these materials under mechanical and thermal loading. This guide does not attempt to address all the aspects of instrumentation. Rather, criteria that establish the minimum strain gage size required to yield reproducible measurements are presented. This method is limited to the textile architectures identified in Section 5.4.

2. Reference Documents.

2.1 *Reference Publications:*

2.1.1 Naik, R. A., Ifju, P. G., and Masters, J. E., "Effect of Fiber Architecture Parameters on Deformation Fields and Elastic Moduli of 2-D Braided Composites," *Journal of Composite Materials*, Vol. 28, No. 7/1994, pp. 656 - 681.

2.1.2 Masters, John E., "Strain Gage Selection Criteria for Textile Composite Materials," NASA CR 198286, Feb. 1996.

Instrumentation Guide for Textile Composites

2.1.3 Pastore, Christopher M., "Illustrated Glossary of Textile Terms for Composites", NASA CR 191539, Sept. 1993.

2.2 *ASTM Standards:*

D883 Terminology Relating to Plastics.

D3878 Terminology of High-Modulus Reinforced Fiber and Their Composites.

E6 Terminology Relating to Methods of Mechanical Testing.

E83-94 Practice for Verification and Classification of Extensometers.

E251-92 Standard Test Methods for Performance Characteristics of Metallic Bonded Resistance Strain Gages.

E456 Terminology Relating to Quality and Statistics.

E1237-93 Guide for Installing Bonded Resistance Strain Gages.

E1434 Guide for Development of Standard Data Records for

Computerization of Mechanical Test Data for High-Modulus Fiber-Reinforced Composite Materials.

OIML International Recommendation No. 62: "Performance Characteristics of Metallic Resistance Strain Gages."

3. Terminology.

3.1 *Definitions* — Definitions used in this guide are defined by various ASTM methods. ASTM method D3878 defines terms relating to high-modulus fiber and their composites. ASTM method D883 defines terms relating to plastics. ASTM method E6 defines terms relating to mechanical testing. ASTM method E456 defines terms relating to statistics. In the event of a conflict between definitions of terms, ASTM method D3878 shall have precedence over the other standards.

3.2 *Description of Terms Specific to This Guide:*

3.2.1 *Bonded Resistance Strain Gage*— a resistive element with a carrier that is attached by bonding to

Instrumentation Guide for Textile Composites

the base material so that the resistance of the element will vary as the surface of the base material to which it is attached is deformed. (For a complete definition of this term see ASTM Test Methods E 251.)

3.2.2 Throughout this guide the terms "strain gage" and "gage" are to be understood to represent the longer, but more accurate, "metallic bonded resistance strain gages."

3.2.3 Terms relating specifically to textile composites are defined by Reference 2.1.3;

3.2.4 *The Unit Cell* — In theory, textile composites have a repeating geometrical pattern based on manufacturing parameters. This repeating pattern is often called the material's "unit cell". It is defined as the smallest section of architecture required to repeat the textile pattern. Handling and processing can distort the "theoretical" unit cell. Although some parameters, such as tow size and fiber angle, may be explicitly defined, calculation of unit cell dimensions tend to be somewhat subjective. Unit cell dimensions are

based on varying interpretations of the textile architecture. Refer to Chapter 2 of this document for a description of the method used to determine 2-D braided and 3-D woven material unit cell dimensions.

4. Summary of Guide.

4.1 Bonded resistance strain gages and extensometers are used to measure material deformation that results when mechanical or thermal loads are applied to a material. The optimum and reproducible application of these sensors is dependent upon a variety of factors including: proper gage selection, surface preparation, gage installation, lead wire connection, and verification checks.

4.1.1 Several guides and methods have been developed to define the factors listed above. Strain gage installation guidelines have been established in E1237-93. Test methods that define the performance characteristics of strain gages and extensometers are given in E251-92 and E83-94, respectively.

Instrumentation Guide for Textile Composites

4.1.2 The surface preparation, gage installation, lead wire connection, and verification check procedures and practices defined in the above referenced documents are applicable to textile composites. This guide will address strain gage selection for textile composites.

5. Significance and Use.

5.1 The intent of this guide is to define strain gage size selection criteria for textile composites.

5.2 Textile composites have a less homogeneous nature than composites constructed from prepreg tape. Consequently, greater care must be taken in gage selection to adequately characterize these materials. Each textile architecture has an independent unit cell size. This repeating inhomogeneity may cause variability in the test results if strain gages are sized solely by using guidelines established for tape materials.

5.2.1 As a general rule, gage size should normally be small with respect to the dimensions of an immediately adjacent geometric

irregularity (hole, fillet, etc.) to minimize errors due to strain gradients over the gage area. However, the gage size should generally be large relative to the underlying material structure (grain size, fabric-reinforced composite weave or braid pattern).

5.3 This test method is the result of studies conducted by Lockheed Engineering and Science under contract to NASA Langley Research Center. Data was derived from tests on two dimensional triaxial braids, three dimensional interlocking weaves, and stitched uniweaves. An evaluation of the test results is available in reference document 2.1.2, Strain Gage Practice for Textile Composites, NASA CR 198286, Feb. 1996.

5.4 This guide is recommended for experiments conducted on 2-D braids, 3-D weaves, and stitched uniweave architectures evaluated in reference document 2.1.2. and described in Chapter 3 of this report. Specifically, the gage size selection criteria have only been evaluated using the textile composites described in Chapter 2 of this document.

Instrumentation Guide for Textile Composites

5.4.1 The 2-D braided materials' unit cells ranged from 0.415 inch to 0.829 inch in width and from 0.083 inch to 0.207 inch in height. The widths of the 3-D woven materials' unit cells ranged from 0.070 inch to 0.085 inch ; their heights ranged from 0.065 inch to 0.455 inch. All the stitched materials evaluated featured a stitch pitch of 8 stitches per inch; the rows of stitches were 1/8 inch apart.

6.0 Gage Selection.

6.1 *2-D Triaxial Braids.*

6.1.1 The experimental results indicate that gage length should, at a minimum, equal the length of the unit cell in the load direction. This applies to specimens loaded in the axial fiber direction (longitudinal direction) and to specimens loaded perpendicular to the axial fibers (transverse direction). No relationship between gage width and scatter in the data was discerned. Thus, a rectangular gage is sufficient. If rectangular gages are used, it is recommended that the gage length to width ratio be

kept at 2. Data were not gathered for other gage configurations.

6.2 *3-D Woven Laminates.*

6.2.1 Test results obtained for specimens loaded in the warp direction (longitudinal direction) indicate that reproducible results were obtained when gage length equaled the unit cell length in the load direction. This is a minimum. Both braided and woven laminate test results indicated that the scatter in the data is greatly decreased as the gage length increases.

6.2.2 A more restrictive gage selection criteria is required for specimens loaded in the fill direction (transverse direction). Test results obtained for these specimens indicated that the gage length must exceed unit cell length by a factor of four. The application of this criterion is mitigated since the unit cells, as defined in Chapter 2, are quite narrow. The criterion could be met with relatively standard and affordable 0.375 inch gages, for example, in the laminates evaluated in this report.

Instrumentation Guide for Textile Composites

6.3 *Stitched Laminates.*

6.3.1 The results of the evaluation of the stitched laminates indicated that strain gage size did not influence the modulus measurement or the scatter in the data. Acceptable results were obtained

using 0.125 inch gages even though their lengths and widths were equal to the stitch spacing and pitch. This should be considered a minimum gage size for this stitch configuration, however, until data are developed for smaller gages.

Standard Test Method for Unnotched Tension Testing of Textile Composites

1. Scope

1.1 This test method is a recommended procedure for determining the unnotched tension strength of textile composite materials. This recommendation does not attempt to address all aspects of unnotched tension testing of all textile architectures. Rather, procedures are recommended to establish a standard method of unnotched tension testing between testing laboratories. This method is limited to the textile architectures identified in Chapter 2 of this document.

1.2 This test method does not purport to address all of the safety issues associated with its use. It is the responsibility of the user to establish appropriate safety and health practices prior to initiating testing.

2. Reference Documents

2.1 *Reference Publications:*

2.1.1 Minguet, Pierre J., Fedro, Mark J., Gunther, Christian K., "Test Methods for Textile Composites" NASA CR 4609, July 1994.

2.1.2 Portanova, M.A., "Standard Methods for Unnotched Tension Testing of Textile Composites", NASA CR 198264, Dec. 1995.

2.1.3 Pastore, Christopher M., "Illustrated Glossary of Textile Terms for Composites", NASA CR 191539, Sept. 1993.

2.1.4 Masters, John E., "Strain Gage Practice for Textile Composites", NASA CR 198286, Feb. 1996.

2.2 *ASTM Standards:*

D792 Test Methods for Specific Gravity and Density of Plastics by Displacements.

D883 Terminology Relating to Plastics.

D2584 Test Method for Ignition Loss of Cured Reinforced Resins.

D2734 Test Methods for Void Content of Reinforced Plastics.

D3039 Test Method for Tensile Properties of Polymer Matrix Composite Materials.

D3171 Test Method for Fiber Content of Resin Matrix Composites by Matrix Digestion.

D3878 Terminology of High-Modulus Reinforced Fiber and Their Composites.

E6 Terminology Relating to Methods of Mechanical Testing.

Unnotched Tension Testing of Textile Composites

E177 Practice for use of Terms Precision and Bias in ASTM Test Methods.

E456 Terminology Relating to Quality and Statistics.

E1434 Guide for Development of Standard Data Records for Computerization of Mechanical Test Data for High-Modulus Fiber-Reinforced Composite Materials.

3. Terminology

3.1 Definitions — Definitions used in this test method are defined by various ASTM methods. ASTM method D3878 defines terms relating to high-modulus fiber and their composites. ASTM method D883 defines terms relating to plastics. ASTM method E6 defines terms relating to mechanical testing. ASTM methods E456 and E177 define terms relating to statistics. In the event of a conflict between definitions of terms, ASTM method D3878 shall have precedence over the other standards.

3.2 Description of Terms Specific to This Standard — Terms relating specifically to textile composites are defined by reference publication 2.1.3; Pastore, Christopher M., "Illustrated Glossary of Textile Terms for Composites", NASA CR 191539, Sept. 1993.

3.3 The Unit Cell — In theory, textile composites have a repeating geometrical pattern based on manufacturing parameters. This repeating pattern is often called the material's "unit cell". It is defined as the smallest section of architecture required to repeat the textile pattern. Handling and processing can distort the "theoretical" unit cell. Although some parameters, such as tow size and fiber angle, may be explicitly defined, calculation of unit cell dimensions tend to be somewhat subjective. Unit cell dimensions are based on varying interpretations of the textile architecture. For a description of the method used to determine the unit cell dimensions refer to Chapter 2 of this document.

4. Summary of Test Method

4.1 Uniaxial tension tests of a textile composite materials are performed in accordance with ASTM Standard Test Method D3039. The unnotched specimen shown in Figure 1 is mounted in the grips of the testing machine. Load cell and strain gage output must be recorded if modulus properties are desired. Otherwise, just load cell output is required.

Unnotched Tension Testing of Textile Composites

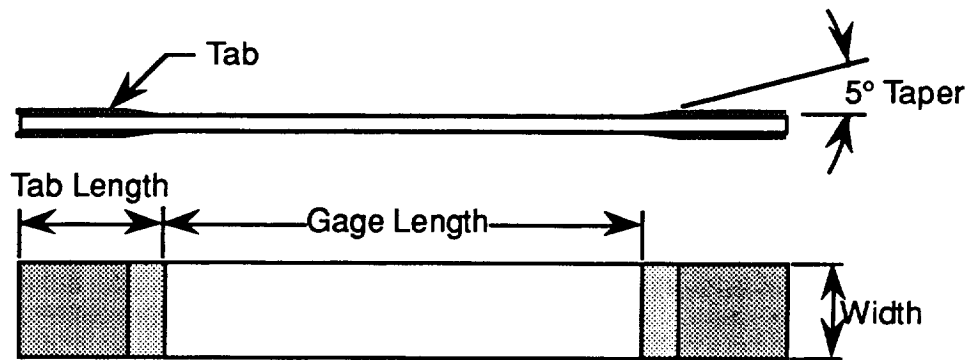

Figure 1. Unnotched Tension Test Specimen

5. Significance and Use

5.1 Textile composites have a less homogeneous nature than composites constructed from prepreg tape. Consequently, standard composite testing methods may not be adequate to characterize these materials. Each textile architecture has an independent unit cell size. This repeating inhomogeneity may cause variability in the test results if specimens are sized solely by using guidelines established for tape materials.

5.2 This test method is designed to produce unnotched tension property data for material specifications, research and development and design. The factors that influence tensile properties, and, therefore, should be reported are: textile architecture as described by section 3.2, the method of material and specimen preparation, conditioning, fiber volume fraction and void content, the environment of testing and speed of testing. Properties, in the

test direction, that may be obtained from this test method include:

- 5.2.1 Ultimate tensile strength,
- 5.2.2 Ultimate tensile strain,
- 5.2.3 Tensile modulus of elasticity,
- 5.2.4 Poisson's ratio in tension, and
- 5.2.5 Transition strain.

5.3 This test method is the result of studies conducted at three independent testing laboratories. The primary contributor of test data was Boeing Defense and Space Group in Philadelphia, PA. Supplemental data, obtained from Lockheed Aeronautical Systems in Marietta, GA and West Virginia University (WVU), was also examined. Most of the data was derived from tests on two

Unnotched Tension Testing of Textile Composites

dimensional triaxial braids and three dimensional interlocking weaves. Some results for stitched uniweaves were also evaluated. An evaluation of the test method was made using results from each of the named contributors and is available in reference document 2.1.2, Portanova, M.A., "Standard Methods for Unnotched Tension Testing of Textile Composites", NASA CR 198264, Dec. 1995.

5.4 This method is recommended for experiments conducted on 2-D braids, 3-D weaves, and similar textile architectures evaluated in reference document 2.1.2. Specifically, this test method has only been evaluated using the braids and weaves described in Chapter 2 of this document.

5.5 This test method has only been evaluated under room temperature - dry test conditions. Its applicability to testing textile

6.1 The test apparatus used shall be in accordance with ASTM Test Method D3039.

6.2 Additionally, required strain measurements shall be made using an extensometer or strain gages of sufficient size as compared to the textiles unit cell size. Unit cell calculations shall be made according to Section 3.3 of this method. Strain gage selection shall be made in accordance with reference publication 2.1.4 of this test method, Masters, John E., "Strain Gage Size Effects of Textile Composites", NASA CR 198286, Feb. 1996

7. Sampling & Test Specimens

7.1 *Sampling* — Test at least five specimens per series unless valid results can be obtained using less specimens, such as by using a designed experiment. For statistically significant data use the

Table 1. Unnotched Tension Test Specimen Specifications.

| Recommended Specimen Width and Gage Length | | | |
|--|------------|---------------------|----------|
| Specimen Width | | Minimum Gage Length | |
| mm | inch | mm | inch |
| 25.4±0.1 | 1.00±0.005 | 127±2.0 | 5.00±0.1 |

Note: Width specification was determined from data obtained for 2-D braids whose unit cell widths ranged from 0.829 to 0.415 inch.

composites under elevated temperature and moisture conditions has not been established.

6. Apparatus

procedure outlined in ASTM practice E 122. Report the method of sampling.

7.2 *Specimen Geometry* — The test specimen geometry shall be in accordance with ASTM Test Method D3039 for symmetric laminates. Specifically, the straight sided

Unnotched Tension Testing of Textile Composites

specimen geometry illustrated in Figure 1 shall be as described in Table 1. The test specimen shall have a constant rectangular cross section with a specimen width variation of no more than $\pm 1\%$ and a specimen thickness variation of no more than $\pm 4\%$.

7.2.1 Ratio of Specimen Width to Unit Cell Size — The recommended specimen width was determined through the evaluation of 2-D braided materials whose unit cells ranged from 0.415 inch to 0.829 inch in width. The evaluation of textile composites whose unit cells are wider may require test specimens of greater width.

7.3 Specimen Fabrication — The specimens may be molded individually without cut edges or machined from a plate after bonding on tab material. If cut from a plate, precautions must be taken to avoid notched, undercuts, or rough edges. When machined, each specimen should be saw cut oversized and ground to the final dimensions.

7.4 Tabbing — Tabs should be strain compatible with the composite being tested. The most consistently used bonded tab material has been continuous E-glass fiber-reinforced polymer matrix materials (woven or unwoven) in a $[0/90]_{ns}$ laminate configuration. The tab material is commonly applied at 45° to the loading direction to provide a soft interface.

Equation 1 can be used to estimate the minimum suggested tab length for bonded tabs. As this

equation does not account for the peaking stresses that are known to exist at the ends of bonded joints, the tab length calculated by this equation should normally be increased by some factor to reduce the chances of joint failure.

$$L_{min} = \frac{\sigma_c h}{2\tau} \quad 1.$$

where

| | | |
|------------|---|---|
| L_{min} | = | tab length |
| h | = | specimen thickness, |
| σ_c | = | estimated strength of the composite |
| τ | = | shear strength of the adhesive, specimen, or tab (whichever is lowest). |

The tabs used in Ref 2.1.1, which comprised the bulk of the data evaluated to establish this method, were 2.25 inches long. They featured a 5° taper.

8. Conditioning

8.1 Standard Conditioning Procedure — Unless a different environment is required, the test specimens shall be conditioned in accordance with ASTM Procedure C of Test Method D5229 / D5229M.. Store and test at standard laboratory conditions of $23\pm 1^\circ$ C [$73.4\pm 1.8^\circ$ F] and $50\pm 10\%$ relative humidity.

9. Procedure

9.1 General Instructions:

Unnotched Tension Testing of Textile Composites

9.1.1 Report any deviations from this test method, whether intentional or inadvertent.

9.1.2 Following final specimen machining and any conditioning, but before the tension testing, determine the area as $A = w \times h$ at three places in the gage section and report the area as the average of these three determinations, to an accuracy of ± 0.0001 in. in thickness measurements and ± 0.001 in. in width measurements. Record the minimum values of cross-sectional area so determined.

9.2 *Speed of Testing* — Testing speed shall set at a constant displacement rate of between 0.02 and 0.05 in/min as required to produce failure within 1 to 10 min.

9.3 *Specimen Insertion* — Place the specimen in the grips of the testing machine, taking care to align the long axis of the gripped specimen with the test direction. Tighten the grips, recording the pressure used on pressure controllable (hydraulic or pneumatic) grips.

9.4 *Transducer Installation* — If strain response is to be determined attach the strain-indication transducer(s) to the specimen, symmetrically about the mid-span, mid-width location. Attach the strain recording instrumentation to the transducers on the specimen.

9.5 *Loading* — Apply the load to the specimen at the specified rate until failure, while recording data.

9.6 *Data Recording* —

9.6.1 Record load versus strain (or transducer displacement) continuously, or at frequent regular intervals. If a transition region (marked by a change in the slope of the stress-strain curve) is noted, record the load, strain, and mode of damage at such points. If the specimen is to be failed, record the maximum load, the failure load, the strain (or transducer displacement) at, or as near as possible to, the moment of rupture.

9.6.2 Other valuable data that can be used in understanding testing anomalies and gripping or specimen slipping problems include load versus head displacement and load versus time data. These data may also be recorded.

9.6.3 When determining the modulus of elasticity it is recommended that at least one specimen per series be tested with back-to-back axial transducers to evaluate the percent bending, as determined by Equation 2. Determine the percent bending at the mid-point of the strain range used for modulus calculations. A single transducer may be used if the percent bending is less than 3%. When bending is greater than 3% averaged strains from back-to-back transducers of like kind are recommended.

$$B_y = \frac{|\varepsilon_f - \varepsilon_b|}{|\varepsilon_f + \varepsilon_b|} \times 100 \quad 2.$$

where:

Unnotched Tension Testing of Textile Composites

- B_y = percent bending in specimen.
 ϵ_f = indicated strain from front transducer, $\mu\epsilon$.
 ϵ_b = indicated strain from back transducer, $\mu\epsilon$.

9.7 *Failure Mode* — Record the mode and location of failure of the specimen.

9.8 *Grip/Tab Failures* — Re-examine the means of load introduction into the material if a significant fraction of the failures in a sample population occur within one specimen width of the tab or grip. Factors considered should include the tab alignment, tab material, tab angle, tab adhesive, grip type, grip pressure, and grip alignment.

10. Calculations

Calculations shall be made using the following equations:

10.1 *Tensile Strength* — Calculate tensile strength using the following equation. Report results to three significant digits.

$$\sigma_{ult} = \frac{P}{wt} \quad 3.$$

where

- σ_{ult} = ultimate tensile strength, MPa or Ksi.
 P = maximum load, N or lbf.

- w = minimum specimen width, mm or in.
 t = minimum specimen thickness, mm or in.

10.2 *Elastic Modulus* — Calculate the modulus of elasticity using equation 4. Longitudinal strain shall be determined by evaluating the linear range between 1000 and 3000 $\mu\epsilon$. Report results to three significant digits.

$$E = \left(\frac{\Delta P}{\Delta l} \right) \left(\frac{l}{wt} \right) = \frac{\Delta \sigma}{\Delta \epsilon} \quad 4.$$

where:

- E = modulus of elasticity, MPa or Ksi.
 $\Delta P/\Delta l$ = slope of the linear region of the load—deformation curve.
 l = gage length of strain measuring instrument, mm or in.
 w = minimum specimen width.
 t = minimum specimen thickness.

10.2.1 Tabulated strains should only be determined for materials that do not exhibit a significant change in the slope of the stress-strain curve. If a transition region occurs within the recommended strain range, then a more suitable strain range shall be used and reported.

Unnotched Tension Testing of Textile Composites

10.3 *Poisson's Ratio* — Calculate Poisson's ratio from equation 5 using 1000 to 3000 $\mu\epsilon$ data. Report calculation to three significant digits.

$$v = -\frac{\Delta\epsilon_x}{\Delta\epsilon_y} \quad 5.$$

where:

v = Poisson's Ratio.
 $\Delta\epsilon_x / \Delta\epsilon_y$ = Slope of the strain-strain curve in the linear region where ϵ_y denotes the strain in the loading direction and ϵ_x denotes the strain perpendicular to the loading direction.

10.4 *Transition Strain* — Where applicable, determine the transition strain from either the bilinear longitudinal stress versus longitudinal strain curve or the bilinear transverse strain versus longitudinal strain curve. Create a linear best fit for each of the two regions and extend the lines until they intersect. Determine the longitudinal strain that corresponds to the intersection point and record this value as the transition strain. Report this value to three significant figures. Also report the method of linear fit and the strain ranges over which the linear fit were determined.

10.5 *Statistics* — For each series of tests calculate and report to three

significant digits the average value, standard deviation, and percent coefficient of variation for each property determined. Use equation 6, 7, and 8 to determine these values.

$$\bar{X} = \frac{\left(\sum_{i=1}^n X_i \right)}{n} \quad 6.$$

$$S_{n-1} = \sqrt{\frac{\left(\sum_{i=1}^n x^2 - n\bar{X}^2 \right)}{(n-1)}} \quad 7.$$

$$\%CoV = 100 \times S_{n-1} / \bar{X} \quad 8.$$

where:

\bar{X} = sample mean (average).
 n = number of specimens.
 X_i = measured or derived property.
 S_{n-1} = sample standard deviation.
 $\%CoV$ = sample coefficient of variation, in percent.

Unnotched Tension Testing of Textile Composites

11. Report

11.1 The report shall include all appropriate parameters in accordance with ASTM Test Method D3039, making use of ASTM guides E1309, E1471, and E1434.

11.2 As a minimum, the report shall include the following:

11.2.1 A complete identification of the material tested using terms defined in reference publication 2.1.3; Pastore, Christopher M., "Illustrated Glossary of Textile Terms for Composites", NASA CR 191539, Sept. 1993.

11.2.2 The number of specimens tested.

11.2.3 The fiber and resin density used and how they were measured.

11.2.4 The average value and standard deviation of the fiber volume fraction of the composite and how it was measured.

11.2.5 The average value of ultimate strength and its coefficient of variation.

12. Precision and Bias

12.1 The following criteria should be used for judging the acceptability of the results:

12.1.1 *Repeatability* — The results should be considered suspect if two averages obtained by the same testing laboratory differ by more than 2 standard deviations.

12.1.2 *Reproducibility* — The results should be considered suspect if two averages obtained by different testing laboratories differ by more than 2.8 standard deviations.

Standard Test Method for Unnotched Compression Testing of Textile Composites

1. Scope

1.1 This test method determines the unnotched compression strength of textile composite materials. This recommendation does not attempt to address all aspects of unnotched compression testing of all textile architectures. Rather, procedures are recommended to establish a standard method of unnotched compression testing between testing laboratories. This method is limited to the textile architectures identified in Section 5.4.

1.2 This test method does not purport to address all of the safety issues associated with its use. It is the responsibility of the user to establish appropriate safety and health practices prior to initiating testing.

2. Reference Documents.

2.1 Reference Publications:

2.1.1 Minguet, Pierre J., Fedro, Mark J., Gunther, Christian K., "Test Methods for Textile Composites" NASA CR 4609, July 1994.

2.1.2 Masters, John E., "Compression Testing of Textile Composites", NASA CR 198285, Feb. 1996.

2.1.3 Pastore, Christopher M., "Illustrated Glossary of Textile Terms

for Composites", NASA CR 191539, Sept. 1993.

2.1.4 Masters, John E., "Strain Gage Practice for Textile Composites", NASA CR 198286, Feb. 1996.

2.2 ASTM Standards:

D792 Test Methods for Specific Gravity and Density of Plastics by Displacements.

D883 Terminology Relating to Plastics.

D2584 Test Method for Ignition Loss of Cured Reinforced Resins.

D2734 Test Methods for Void Content of Reinforced Plastics.

D3410-94 Compression Properties of Polymer Matrix Composite Materials with Unsupported Gage Sections by Shear Loading.

D3171 Test Method for Fiber Content of Resin Matrix Composites by Matrix Digestion.

D3878 Terminology of High-Modulus Reinforced Fiber and Their Composites.

E6 Terminology Relating to Methods of Mechanical Testing.

Unnotched Compression Testing of Textile Composites

E177 Practice for use of Terms Precision and Bias in ASTM Test Methods.

E456 Terminology Relating to Quality and Statistics.

E1434 Guide for Development of Standard Data Records for Computerization of Mechanical Test Data for High-Modulus Fiber-Reinforced Composite Materials.

3. Terminology.

3.1 *Definitions* — Definitions used in this test method are defined by various ASTM methods. ASTM method D3878 defines terms relating to high-modulus fiber and their composites. ASTM method D883 defines terms relating to plastics. ASTM method E6 defines terms relating to mechanical testing. ASTM methods E456 and E177 define terms relating to statistics. In the event of a conflict between definitions of terms, ASTM method D3878 shall have precedence over the other standards.

3.2 *Description of Terms Specific to This Standard:* — Terms relating specifically to textile composites are

defined by reference publication 2.1.3; Pastore, Christopher M., "Illustrated Glossary of Textile Terms for Composites", NASA CR 191539, Sept. 1993.

3.3 *The Unit Cell* — In theory, textile composites have a repeating geometrical pattern based on manufacturing parameters. This repeating pattern is often called the material's "unit cell". It is defined as the smallest section of architecture required to repeat the textile pattern. Handling and processing can distort the "theoretical" unit cell. Although some parameters, such as tow size and fiber angle, may be explicitly defined, calculation of unit cell dimensions tend to be somewhat subjective. Unit cell dimensions are based on varying interpretations of the textile architecture. Refer to Chapter 2 of this document for a description of the method used to determine 2-D braided and 3-D woven material unit cell dimensions.

4. Summary of Test Method.

4.1 A flat strip of material having a constant rectangular cross-section, as shown in Figure 1, is loaded in compression by a shear

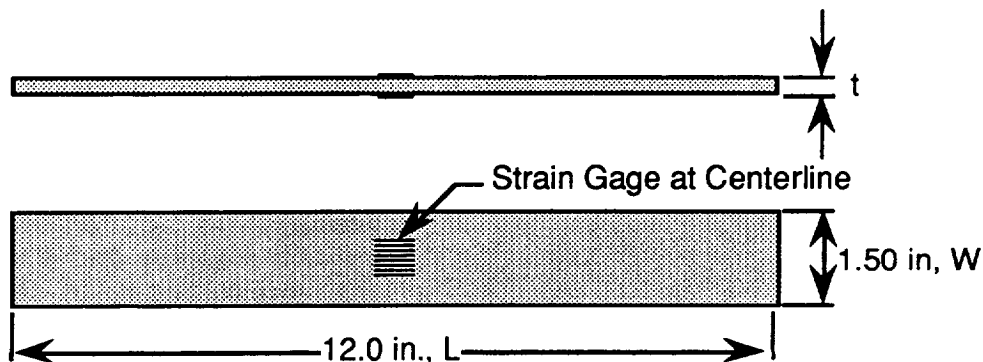

Figure 1. Compression Test Specimen.

Unnotched Compression Testing of Textile Composites

load acting along the grips. The shear load is applied via wedge grips.

4.2 To obtain compression test results, the specimen is inserted into the test fixture [Ref. 2.1.2] shown in Figure 2. The test fixture provides lateral support along the specimen length to prevent buckling. The untabbed specimen ends are then mounted in the testing machine grips. The specimen is then loaded in axial compression. The ultimate compression strength of the material, can be determined from the maximum load carried prior to

5. Significance and Use.

5.1 Textile composites have a less homogeneous nature than composites constructed from prepreg tape. Consequently, standard composite testing methods may not be adequate to characterize these materials. Each textile architecture has an independent unit cell size. This repeating inhomogeneity may cause variability in the test results if specimens are sized solely by using guidelines established for tape materials.

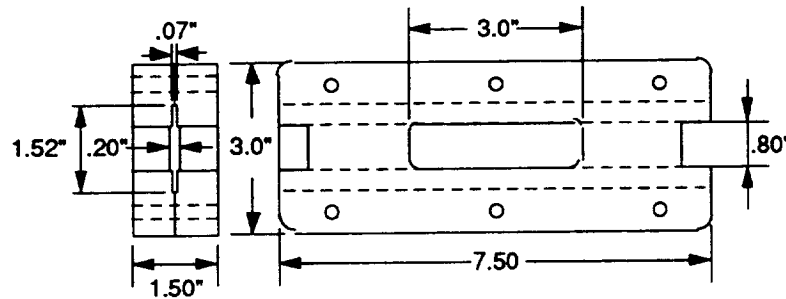

Figure 2. Unnotched Compression Test Fixture.

failure. Strain is monitored with strain or displacement transducers so the stress-strain response of the material can be determined. The ultimate compressive strain, the compression modulus of elasticity, Poisson's ratio in compression, and the transition strain can be determined from the stress-strain curve.

5.2 This test method is designed to produce unnotched compression property data for material specifications, research and development and design. The factors that influence compression properties and, therefore, should be reported are: textile architecture as described by section 3.2, the method of material and specimen preparation, conditioning, fiber volume fraction and void content, the environment of testing and speed of testing. Properties, in the test direction, that may be obtained from this test method include:

Unnotched Compression Testing of Textile Composites

5.2.1 Ultimate compressive strength,

5.2.2 Ultimate compressive strain,

5.2.3 Compressive modulus of elasticity,

5.2.4 Poison's ratio in compression, and

5.2.5 Transition strain.

5.3 This test method is the result of studies conducted at two independent testing laboratories. The primary contributor of test data was the Boeing Defense and Space Group in Philadelphia, PA. Supplemental data, obtained from Lockheed Aeronautical Systems in Marietta, GA, was also examined. Most of the data was derived from tests on two dimensional triaxial braids and three dimensional interlocking weaves. Some results for stitched uniweaves were also evaluated. An evaluation of the test method was made using results from each of the named contributors and is available in reference document 2.1.2 Masters, John E., "Compression Testing of Textile Composites", NASA CR 198285, Feb. 1995.

5.4 This method is recommended for experiments conducted on 2-D braids, 3-D weaves, and similar textile architectures evaluated in reference document 2.1.2. Specifically, this test method has only been evaluated using the braids and weaves described in Chapter 2 of this document.

5.4.1 The recommended test specimen geometry was determined through the evaluation of 2-D braided materials whose unit cells ranged from 0.415 inch to 0.829 inch in width. The evaluation of textile composites with wider unit cells may require test specimens of greater width.

5.4.2 The recommended test specimen geometry was determined through the evaluation of 0.125 inch thick 2-D braided materials whose moduli ranged from 4.9 to 10.6 MSI. Data establishing the viability of the test specimen geometry to textile composites with lower moduli and to thinner specimens are not available.

5.4.3 This test method has only been evaluated under room temperature - dry test conditions. Its applicability to testing textile composites under elevated temperature and moisture conditions has not been established.

6. Apparatus

6.1 The test fixture shown in Fig. 1 (Ref. 2.1.1) shall be used to support the test specimen. All other apparatus used shall be in accordance with ASTM Test Method D3410-94.

6.2 Strain-Indicating Device :

6.2.1 Longitudinal strain shall be simultaneously measured on opposite faces of the specimen to allow for a correction due to any bending of the specimen, and to enable detection of Euler (column)

Unnotched Compression Testing of Textile Composites

buckling. Back-to-back strain measurement shall be made for all five specimens when the minimum number of specimens allowed by this test method are tested. If more than five specimens are to be tested then a single strain-indicating device may be used for the additional specimens, provided all specimens are tested in a single test fixture that remains in the load frame throughout the tests, that no modifications to the specimens or the test procedure are made during the tests, and provided the bending requirements of Section 9.4.3 are met for the first five specimens. If these conditions are not met, then all specimens must be instrumented with back-to-back gages.

6.2.2 When the Poisson's ratio is to be determined, the specimen

an extensometer or strain gages of sufficient size as compared to the textiles unit cell size. Unit cell calculations shall be made according to Section 3.3 of this method. Strain gage selection shall be made in accordance with reference publication 2.1.4 of this test method, Masters; John E., "Strain Gage Size Effects of Textile Composites", NASA CR 198286, Feb. 1996

7. Sampling & Test Specimens

7.1 *Sampling* — Test at least five specimens per series unless valid results can be obtained using less specimens, such as by using a designed experiment. For statistically significant data use the procedure outlines in ASTM practice

Table 1. Unnotched Compression Test Specimen Specifications.

| Recommended Specimen Dimensions | | |
|----------------------------------|--------------------------------|------------------------------------|
| Width | Length | Thickness |
| 38.0±0.15 mm (1.50±0.005 in.) | 305.0±3.0 mm (12.0±0.1 in.) | 3.18±0.125 mm (0.125±0.005 in.) |

Note: Width specification was determined from data obtained for 2-D braids whose unit cell widths ranged from 0.829 to 0.415 inch.

shall be instrumented to measure strain in the lateral direction using the same type of transducer. The same type of strain transducer shall be used for all strain measurements on any single coupon. Attachment of the strain-indicating device to the coupon shall not cause damage to the specimen surface.

6.3 Additionally, required strain measurements shall be made using

E 122. Report the method of sampling.

7.2 *Specimen Geometry* — The straight sided test specimen geometry, illustrated in Figure 1, shall be in accordance with the dimensions listed in Table 1. The test specimen shall have a constant rectangular cross section with a specimen width variation of no more than ± 1% and a specimen

Unnotched Compression Testing of Textile Composites

thickness variation of no more than $\pm 4\%$.

7.2.1 The recommended specimen width was determined through the evaluation of 2-D braided materials whose unit cells ranged from 0.415 inch to 0.829 inch in width. The evaluation of textile composites whose unit cells are wider may require test specimens of greater width.

7.2.2 The recommended specimen thickness was determined through the evaluation of 0.125 inch thick 2-D braided materials whose moduli ranged from 4.9 to 10.6 MSI. The application of this method to thinner textile laminates or to material with a lower modulus may lead to Euler (column) buckling in the unsupported section of the test specimen. See Section 9.4.4.

7.3 *Specimen Fabrication* — The specimens may be molded individually without cut edges or machined from a plate. If cut from a plate, precautions must be taken to avoid notched, undercuts, or rough edges. When machined, each specimen should be saw cut oversized and ground to the final dimensions.

8. Conditioning

8.1 *Standard Conditioning Procedure* — Unless a different environment is required, the test specimens shall be conditioned in accordance with ASTM Procedure C of Test Method D5229 / D5229M. Store and test at standard laboratory

conditions of $23\pm 1^\circ\text{C}$ [$73.4\pm 1.8^\circ\text{F}$] and $50\pm 10\%$ relative humidity.

9. Procedure

9.1 General Instructions:

9.1.1 Report any deviation from this test method, whether intentional or inadvertent.

9.1.2 If specific gravity, density, reinforcement volume, or void volume are to be reported, then obtain these samples from the same panels as the test samples. Specific gravity and density may be evaluated by means of Test Method D792. Volume percent of the constituents may be evaluated by one of the matrix digestion procedures of Test Methods D3171, or, for certain reinforcement materials, such as glass, by the matrix burn-off technique of Test Method D2584. Void content may be evaluated from the equations of Test Method D2734, and are applicable to both Test Methods D2584 and D3171.

9.1.3 Following final specimen machining and any conditioning, but before the compression testing, measure the specimen area as $A = W \times t$ at three places in the gage section and report the area as the average of these three measurements to within 1% accuracy. Record the average area in units of in^2 .

9.1.4 Apply strain gages to both faces of the specimen as shown in Fig. 1.

Unnotched Compression Testing of Textile Composites

9.2 *Speed of Testing* — Set the speed of testing to effect a nearly constant strain rate in the gage section. Testing speed shall set at a constant displacement rate of between 0.02 and 0.05 in/min as required to produce failure within 1 to 10 min.

9.3 Fixture Installation and Specimen Insertion:

9.3.1 Check the alignment of the loading frame to ensure that the grips are in good condition and that they will load the specimen properly.

9.3.2 Check all load and strain gage recording instruments to insure that they are functioning properly.

9.3.3 Place the specimen in the Compression Test Fixture. The two halves of the support fixture should be only lightly bolted together to provide contact support to the specimen. Load the specimen and the fixture into the grips, taking care to maintain proper alignment of the long axis of the specimen with the loading direction..

9.4 Data Recording:

9.4.1 Record load versus strain (or displacement) continuously, or at frequent regular intervals. If a transition region (marked by a change in the slope of the stress-strain curve) is noted, record the load, strain, and mode of damage at such points. If the specimen is to be failed, record the maximum load, the failure load, and the strain at, or as near as possible to, the moment of failure.

9.4.2 Other valuable data that can be used in understanding testing anomalies and gripping or specimen slipping problems include load versus head displacement and load versus time data. These data may also be recorded.

9.4.3 A difference in the stress-strain or load-strain slope from opposite faces of the specimen indicates bending in the specimen. In order for the elastic property test results to be considered valid, percent bending in the specimen shall be less than 10% as determined by Equation 1. Determine the percent bending at the mid-point of the strain range used for modulus calculations. The same requirements shall be met at failure strain for strength and strain-to-failure data to be considered valid. This requirement shall be met for all five of the specimen requiring back-to-back strain measurements. If possible, a plot of the percent bending versus average strain should be recorded to aid in the determination of the failure mode.

$$B_y = \frac{|\epsilon_f - \epsilon_b|}{|\epsilon_f + \epsilon_b|} \times 100 \leq 10\% \quad 1.$$

where:

- B_y = percent bending in specimen.
 ϵ_f = indicated strain from front transducer, $\mu\epsilon$.
 ϵ_b = indicated strain from back transducer, $\mu\epsilon$.

Unnotched Compression Testing of Textile Composites

9.4.4 Rapid divergence of the strain readings of the opposite faces of the specimen, or rapid increase in percent bending, is indicative of the onset of Euler (column) buckling, which is not an acceptable compression failure mode for this test method. Record any indication of Euler buckling.

9.4.5 If the divergence is clearly due to the failure of only one of the strain gages and not the result of bending or twisting on the specimen, the results of the one working strain gage may be used and recorded as the longitudinal strain. The data report should clearly indicate this circumstance.

10. Calculations

10.1 Calculations of the elastic properties shall be made whenever possible using the following equations:

10.1.1 *Compression Strength* — Calculate the ultimate compression strength using Eqn. 2 and report results to three significant digits.

$$\sigma_{ult} = \frac{P}{wt} \quad 2.$$

where

σ_{ult} = ultimate compression strength, MPa or KSI.
 P = maximum load, N or lbf.
 w = minimum specimen width, mm or in.

t = minimum specimen thickness, mm or in.

10.1.2 *Compressive Modulus of Elasticity* — Calculate the modulus of elasticity from the stress-strain data using Equation 3. Data gathered over the 1000 to 3000 $\mu\epsilon$ strain range shall be used in these calculations. If data are not available at the exact strain range end points, use the closest available data point. Report the modulus of elasticity to three significant figures. Also report the strain range used in the calculation.

10.1.2.1 The recommended strain ranges should only be used for material that do not exhibit a transition region (a significant change in the slope of the stress-strain curve) within the recommended strain range. If a transition region occurs within the recommended strain range, then a more suitable strain range should be used and reported.

$$E = \left(\frac{\Delta P}{\Delta l} \right) \left(\frac{l}{wt} \right) = \frac{\Delta \sigma}{\Delta \epsilon} \quad 3.$$

where:

E = modulus of elasticity, MPa or KSI.
 $\Delta P / \Delta l$ = slope of the linear region of the load—deformation curve.
 l = gage length of strain measuring instrument, mm or in.
 w = minimum specimen width.

Unnotched Compression Testing of Textile Composites

t = minimum specimen thickness.

10.1.3 Poisson's Ratio — Determine the transverse strain (strain in the plane of the specimen and perpendicular to the applied load), ϵ_x , at each point over the longitudinal strain range of 1000 to 3000 $\mu\epsilon$. If data are not available at the exact strain range end points, use the closest available data point. Calculate Poisson's ratio from Equation 4. Report the results of the calculation to three significant digits.

$$v = -\frac{\Delta\epsilon_x}{\Delta\epsilon_y} \quad 4.$$

where:

v = Poisson's Ratio.
 $\Delta\epsilon_x / \Delta\epsilon_y$ = Slope of the strain-strain curve in the linear region where ϵ_y denotes the strain in the loading direction and ϵ_x denotes the strain perpendicular to the loading direction.

10.1.3.1 When determining the Poisson's ratio, match the transverse strain with the appropriate longitudinal strain. For instance, match the output from a single transverse strain gage with the output from the single longitudinal gage mounted in an adjacent location on the same side of the coupon. If back-to-back transverse gages are employed,

average their output and compare to the average longitudinal strain.

10.1.4 Transition Strain — Where applicable, determine the transition strain from either the bilinear longitudinal stress versus longitudinal strain curve or the bilinear transverse strain versus longitudinal strain curve. Create a linear best fit for each of the two regions and extend the lines until they intersect. Determine the longitudinal strain that corresponds to the intersection point and record this value as the transition strain. Report this value to three significant figures. Also report the method of linear fit and the strain ranges over which the linear fit were determined.

10.1.5 Statistics — For each series of tests calculate and report to three significant digits the average value, standard deviation, and percent coefficient of variation for each property determined. Use equation 5, 6, and 7 to determine these values.

$$\bar{X} = \frac{\left(\sum_{i=1}^n X_i \right)}{n} \quad 5.$$

$$S_{n-1} = \sqrt{\frac{\left(\sum_{i=1}^n x^2 - n\bar{X}^2 \right)}{(n-1)}} \quad 6.$$

$$\%CoV = 100 \times S_{n-1} / \bar{X} \quad 7.$$

Unnotched Compression Testing of Textile Composites

where:

- \bar{X} = sample mean (average).
n = number of specimens.
 X_i = measured or derived property.
 S_{n-1} = sample standard deviation.
%CoV = sample coefficient of variation, in percent.

11. Report

11.1 The report shall include all appropriate parameters in accordance with ASTM Test Method D3410-94, making use of ASTM guides E1309, E1471, and E1434.

11.2 As a minimum, the report shall include the following:

11.2.1 A complete identification of the material tested using terms defined in reference publication 2.1.3; Pastore, Christopher M., "Illustrated Glossary of Textile Terms for Composites", NASA CR 191539, Sept. 1993.

11.2.2 The number of specimens tested.

11.2.3 The fiber and resin densities used and how they were measured.

11.2.4 The average value and standard deviation of the fiber volume fraction of the composite and how it was measured.

11.2.5 The average values of the ultimate compressive strength, compressive modulus of elasticity, and their coefficients of variation.

11.3 Where applicable, the following may also be reported:

11.3.1 Ultimate compressive strain,

11.3.2 Compressive modulus of elasticity,

11.3.3 Poison's ratio in compression, and

11.3.4 Transition strain.

12. Precision and Bias

12.1 The following criteria should be used for judging the acceptability of the results:

12.1.1 *Repeatability* — The results should be considered suspect if two averages obtained by the same testing laboratory differ by more than 2 standard deviations.

12.1.2 *Reproducibility* — The results should be considered suspect if two averages obtained by different testing laboratories differ by more than 2.8 standard deviations.

Standard Test Method for Open Hole Tension Testing of Textile Composites

1. Scope

1.1 This test method determines the open hole tension strength of textile composite materials. This recommendation does not attempt to address all aspects of open hole tension testing of all textile architectures. Rather, procedures are recommended to establish a standard method of open hole tension testing between testing laboratories. This method is limited to the textile architectures identified in Chapter 2 of this document.

1.2 This test method does not purport to address all of the safety issues associated with its use. It is the responsibility of the user to establish appropriate safety and health practices prior to initiating testing.

2. Reference Documents

2.1 Reference Publications:

2.1.1 Minguet, Pierre J., Fedro, Mark J., Gunther, Christian K., "Test Methods for Textile Composites" NASA CR 4609, July 1994.

2.1.2 Portanova, M.A., "Standard Methods for Open Hole Tension Testing of Textile Composites", NASA CR 198262, Dec. 1995.

2.1.3 Pastore, Christopher M., "Illustrated Glossary of Textile Terms for Composites", NASA CR 191539, Sept. 1993.

2.1.4 Masters, John E., "Strain Gage Practice for Textile Composites", NASA CR 198286, Feb. 1996

2.2 ASTM Standards:

D792 Test Methods for Specific Gravity and Density of Plastics by Displacements.

D883 Terminology Relating to Plastics.

D2584 Test Method for Ignition Loss of Cured Reinforced Resins.

D2734 Test Methods for Void Content of Reinforced Plastics.

D3039 Test Method for Tensile Properties of Polymer Matrix Composite Materials.

D3171 Test Method for Fiber Content of Resin Matrix Composites by Matrix Digestion.

D3878 Terminology of High-Modulus Reinforced Fiber and Their Composites.

D5766/D5766M - 95 Standard Test Method for Open Hole Tensile Strength of Polymer Matrix Composite Laminates.

Open Hole Tension Testing of Textile Composites

E6 Terminology Relating to Methods of Mechanical Testing.

E177 Practice for use of Terms Precision and Bias in ASTM Test Methods.

E456 Terminology Relating to Quality and Statistics.

E1434 Guide for Development of Standard Data Records for Computerization of Mechanical Test Data for High-Modulus Fiber-Reinforced Composite Materials.

3. Terminology

3.1 *Definitions* — Definitions used in this test method are defined by various ASTM methods. ASTM method D3878 defines terms relating to high-modulus fiber and their composites. ASTM method D883 defines terms relating to plastics. ASTM method E6 defines terms relating to mechanical testing. ASTM methods E456 and E177 define terms relating to statistics. In the event of a conflict between definitions of terms, ASTM method D3878 shall have precedence over the other standards.

3.2 *Description of Terms Specific to This Standard* — Terms relating specifically to textile composites are defined by reference publication 2.1.3; Pastore, Christopher M., "Illustrated Glossary of Textile Terms for Composites", NASA CR 191539, Sept. 1993.

3.3 *The Unit Cell* — In theory, textile composites have a repeating geometrical pattern based on manufacturing parameters. This repeating pattern is often called the material's "unit cell". It is defined as the smallest section of architecture required to repeat the textile pattern. Handling and processing can distort the "theoretical" unit cell. Although some parameters, such as tow size and fiber angle, may be explicitly defined, calculation of unit cell dimensions tend to be somewhat subjective. Unit cell dimensions are based on varying interpretations of the textile architecture. For a description of the method used to determine the unit cell dimension refer to Chapter 2 of this document.

4. Summary of Test Method

4.1 Open Hole Tension Tests of a textile composite materials are performed in accordance with ASTM Standard Test Method D5766. The open hole tension specimen shown in Figure 1 is mounted in the grips of the testing machine and loaded in uniaxial tension to failure. Ultimate strength is calculated based on the gross cross-sectional area, disregarding the hole, and then corrected for finite width effects.

5. Significance and Use

5.1 Textile composites have a less homogeneous nature than composites constructed from prepreg tape. Consequently, standard composite testing methods may not be adequate to characterize these

Open Hole Tension Testing of Textile Composites

materials. Each textile architecture has an independent unit cell size. This repeating inhomogeneity may cause variability in the test results if specimens are sized solely by using guidelines established for tape materials.

5.2 This test method is designed to produce notched tension strength data for material specifications, research and development, design, and quality assurance. The factors that influence tensile properties, and therefore should be reported are: textile architecture as described by section 3.2, the method of material fabrication, specimen geometry (thickness, width, hole diameter), hole quality, specimen preparation, specimen fiber volume fraction and void content, the environment of testing and speed of testing. Properties that may be derived from this test method include the following:

5.2.1 Open hole (notched) tensile strength.

5.3 This test method is the result of studies conducted at three independent testing laboratories. The primary contributor of test data was Boeing Defense and Space Group in Philadelphia, PA. Supplemental data, obtained from Lockheed Aeronautical Systems in Marietta, GA and West Virginia University (WVU), was also examined. Most of the data was derived from tests on two dimensional triaxial braids and three dimensional interlocking weaves. Lockheed also evaluated a three dimensional braid. Some results for stitched uniweaves, tested at

Boeing, were also evaluated. A evaluation of test method was made using results from each of the contributors and is available in reference document 2.1.2 Portanova, M.A., "Standard Methods for Open Hole Tension Testing of Textile Composites", NASA CR 198262, Dec. 1995.

5.4 This method is recommended for experiments conducted on 2-D braids, 3-D weaves, and similar textile architectures evaluated in reference document 2.1.2. Specifically, this test method has only been evaluated using the braids and weaves described in Chapter 2 of this document.

5.5 This test method has only been evaluated under room temperature - dry test conditions. Its applicability to testing textile composites under elevated temperature and moisture conditions has not been established.

6. Apparatus

6.1 The test apparatus used shall be in accordance with ASTM Test Method D3039. However, the procedure herein does not measure material response, so strain or deflection measurement related discussion in Test Method D3039 do not apply. Additionally, a micrometer or gage capable of determining the hole diameter to 0.001 in. is required.

7. Sampling & Test Specimen

Open Hole Tension Testing of Textile Composites

7.1 *Sampling* — Test at least five specimens per series unless valid results can be obtained using less specimens, such as by using a designed experiment. For statistically significant data use the procedure outlined in ASTM practice E 122. Report the method of sampling.

7.2 *Specimen Geometry* — The test specimen geometry shall be in accordance with ASTM Test Method D5766. Specifically, the straight sided specimen geometry illustrated in Figure 1 shall be as follows:

7.2.1 *Specimen Width & Thickness* — A specimen width to

7.2.2 *Recommended Dimensions* — The specimen width shall be 36 ± 0.1 mm [1.50 ± 0.005 in.] and the length range is 200 — 300 mm [8.0 — 12.0 in.]. The centrally located hole shall be 6 ± 0.06 mm [0.250 ± 0.003 in.] diameter and be located within 0.13 mm [0.005 in.] of the axial centerline of the test specimen.

7.2.3 *Ratio of Specimen Width to Unit Cell Size* — The recommended specimen width was determined through the evaluation of 2-D braided materials whose unit cells ranged from 0.415 inch to 0.829 inch in width. The evaluation

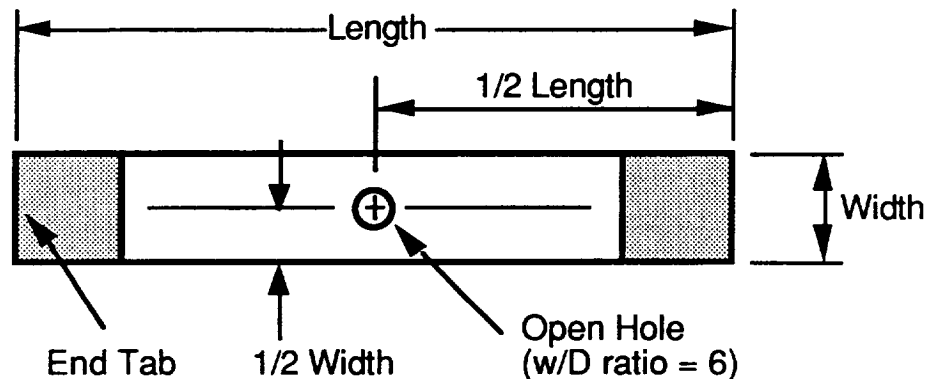

Figure 1. Open Hole Tension Test Specimen.

hole diameter ratio (W/d) of 6 must be maintained. A hole diameter to thickness ratio (d/t) of 1.5 — 3.0 is recommended. The test specimen shall have a constant rectangular cross section with a specimen width variation of no more than $\pm 1\%$ and a specimen thickness variation of no more than $\pm 4\%$.

of textile composites whose unit cells are wider may require test specimens of greater width.

7.3 *Specimen Fabrication* — The specimens may be molded individually without cut edges or machined from a plate after bonding on tab material. If cut from a plate, precautions must be taken to avoid

Open Hole Tension Testing of Textile Composites

notched, undercuts, or rough edges. When machined, each specimen should be saw cut oversized and ground to the final dimensions.

7.4 Hole Preparation — Due to the dominant presence of the notch, consistent preparation of the hole, without damage to the laminate, is important to meaningful results. Damage due to hole preparation will affect strength results. Some types of damage, such as delaminations, can blunt the stress concentration at the hole and increase the load-carrying capacity of the coupon.

7.5 End Tabs — Tabs are not required but may be used. Typically the hole induces a stress riser sufficient to force failure in the notched region.

8. Conditioning

8.1 Standard Conditioning Procedure — Unless a different environment is required, the test specimens shall be conditioned in accordance with ASTM Procedure C of Test Method D5229 / D5229M.. Store and test at standard laboratory conditions of $23\pm 1^{\circ}\text{C}$ [$73.4\pm 1.8^{\circ}\text{F}$] and $50\pm 10\%$ relative humidity.

9. Procedure

9.1 General Instructions:

9.1.1 Report any deviations from this test method, whether intentional or inadvertent.

9.1.2 Following final specimen machining and any conditioning, but before the tension testing, determine

the area as $A = w \times h$ at three places in the gage section and report the area as the average of these three determinations, to an accuracy of ± 0.0001 in. in thickness measurements and ± 0.001 in. in width measurements. Record the minimum values of cross-sectional area so determined. Also measure and report the specimen hole diameter to the nearest 0.001 in. Inspect the hole and areas adjacent to the hole for delaminations. Report the location and size of any delaminations found.

9.2 Speed of Testing — Testing speed shall set at a constant displacement rate of between 0.02 and 0.05 in/min. as required to produce failure within 1 to 10 min.

9.3 Specimen Insertion — Place the specimen in the grips of the testing machine, taking care to align the long axis of the gripped specimen with the test direction. Tighten the grips, recording the pressure used on pressure controllable (hydraulic or pneumatic) grips.

9.4 Loading — Apply the load to the specimen at the specified rate until failure, while recording data.

9.5 Data Recording —

9.5.1 If possible, record load continuously, or at frequent regular intervals. Record the maximum load and the failure load at, or as near as possible to, the moment of rupture.

9.5.2 Other valuable data that can be used in understanding testing anomalies and gripping or

Open Hole Tension Testing of Textile Composites

specimen slipping problems include load versus head displacement and load versus time data. These data may also be recorded.

9.6 *Failure Mode* — Record the mode and location of failure of the specimen. The failure is often heavily influenced by delamination and the failure mode may exhibit much delamination. Failures that do not occur at the hole are not acceptable failure modes and the data shall be noted as invalid.

10. Calculations

Calculations shall be made using the following equations:

10.1 *Ultimate Strength* — Calculate the ultimate open hole tensile strength using Equation 1. Report results to three significant digits.

$$\sigma_{ult} = \frac{P_{max}}{wt} \quad 1.$$

where:

- σ_{ult} = ultimate open hole tensile strength, MPa or Ksi.
- P_{max} = maximum load prior to failure, N or lbf.
- w = specimen width (neglecting the hole), mm or in.
- t = specimen thickness, mm or in.

10.2 *Data Correction* — The test data shall be corrected for finite width using the following isotropic

finite width correction factor. This factor is defined by equation 2.

$$\frac{\sigma_{\infty}}{\sigma_{gross}} = \frac{[2 + (1 - \frac{d}{W})^3]}{3(1 - \frac{d}{W})} \quad 2.$$

where

- σ_{∞} = Infinite stress, MPa or Ksi.
- σ_{gross} = Gross stress, MPa or Ksi.
- W = specimen width (neglecting the hole), mm or in.
- d = diameter of hole, mm or in.

10.3 *Width to Diameter Ratio*— Calculate the actual width to diameter ratio using equation 3. Report both the nominal ratio calculated using nominal values and the actual ratio calculated with measured dimensions.

$$\frac{W}{d} ratio = \frac{W}{d} \quad 3.$$

where

- W = specimen width (neglecting the hole), mm or in.
- d = diameter of hole, mm or in.

10.4 *Statistics* — For each series of tests calculate and report to three significant digits the average value, standard deviation, and percent coefficient of variation for each property determined. Use equations

Open Hole Tension Testing of Textile Composites

4, 5, and 6 to determine these values.

$$\bar{X} = \frac{\left(\sum_{i=1}^n X_i \right)}{n} \quad 4.$$

$$S_{n-1} = \sqrt{\frac{\left(\sum_{i=1}^n x^2 - n\bar{X}^2 \right)}{(n-1)}} \quad 5.$$

$$\%CoV = 100 \times S_{n-1} / \bar{X} \quad 6.$$

where

- \bar{X} = sample mean (average).
- n = number of specimens.
- X_i = measured or derived property.
- S_{n-1} = sample standard deviation.
- $\%CoV$ = sample coefficient of variation, in percent.

11. Report

11.1 The report shall include all appropriate parameters in accordance with ASTM Test Method D5766, making use of ASTM guides E1309, E1471, and E1434.

11.2 As a minimum, the report shall include the following:

11.2.1 A complete identification of the material tested using terms defined in reference publication 2.1.3; Pastore, Christopher M., "Illustrated Glossary of Textile Terms

for Composites", NASA CR 191539, Sept. 1993.

11.2.2 The number of specimens tested.

11.2.3 The fiber and resin density used and how they were measured.

11.2.4 The average value and standard deviation of the fiber volume fraction of the composite and how it was measured.

11.2.5 The average value of ultimate open hole strength, the corrected value of the open hole strength, the standard deviation, and the coefficient of variation for the population.

11.2.6 The nominal and actual width to diameter ratio (W/d).

11.2.7 Failure mode and location of failure for each specimen.

12. Precision and Bias

12.1 The following criteria should be used for judging the acceptability of the results:

12.1.1 *Repeatability* — The results should be considered suspect if two averages obtained by the same testing laboratory differ by more than 2 standard deviations.

12.1.2 *Reproducibility* — The results should be considered suspect if two averages obtained by different testing laboratories differ by more than 2.8 standard deviations.

Standard Test Method for Open Hole Compression Testing of Textile Composites

1. Scope

1.1 This test method determines the open hole compression strength of textile composite materials. This recommendation does not attempt to address all aspects of open hole compression testing of all textile architectures. Rather, procedures are recommended to establish a standard method of open hole compression testing between testing laboratories. This method is limited to the textile architectures identified in Chapter 2 of this document.

1.2 This test method does not purport to address all of the safety issues associated with its use. It is the responsibility of the user to establish appropriate safety and health practices prior to initiating testing.

2. Reference Documents

2.1 Reference Publications:

2.1.1 Minguet, Pierre J., Fedro, Mark J., Gunther, Christian K., "Test Methods for Textile Composites" NASA CR 4609, July 1994.

2.1.2 Pastore, Christopher M., "Illustrated Glossary of Textile Terms for Composites", NASA CR 191539, Sept. 1993.

2.1.3 Masters, John E., "Strain Gage Practice for Textile Composites", NASA CR 198286, Feb. 1996

2.2 ASTM Standards:

D792 Test Methods for Specific Gravity and Density of Plastics by Displacements.

D883 Terminology Relating to Plastics.

D2584 Test Method for Ignition Loss of Cured Reinforced Resins.

D2734 Test Methods for Void Content of Reinforced Plastics.

D3410-94 Compression Properties of Polymer Matrix Composite Materials with Unsupported Gage Sections by Shear Loading.

D3171 Test Method for Fiber Content of Resin Matrix Composites by Matrix Digestion.

D3878 Terminology of High-Modulus Reinforced Fiber and Their Composites.

E6 Terminology Relating to Methods of Mechanical Testing.

E177 Practice for use of Terms Precision and Bias in ASTM Test Methods.

E456 Terminology Relating to Quality and Statistics.

E1434 Guide for Development of Standard Data Records for Computerization of Mechanical Test

Open Hole Compression Testing of Textile Composites

Data for High-Modulus Fiber-Reinforced Composite Materials.

3. Terminology

3.1 *Definitions:* — Definitions used in this test method are defined by various ASTM methods. ASTM method D3878 defines terms relating to high-modulus fiber and their composites. ASTM method D883 defines terms relating to plastics. ASTM method E6 defines terms relating to mechanical testing. ASTM methods E456 and E177 define terms relating to statistics. In the event of a conflict between definitions of terms, ASTM method D3878 shall have precedence over the other standards.

3.2 *Description of Terms Specific to This Standard:* — Terms relating specifically to textile composites are defined by reference publication 2.1.3; Pastore, Christopher M., "Illustrated Glossary of Textile Terms for Composites", NASA CR 191539, Sept. 1993.

3.3 *The Unit Cell* — In theory, textile composites have a repeating geometrical pattern based on manufacturing parameters. This

repeating pattern is often called the material's "unit cell". It is defined as the smallest section of architecture required to repeat the textile pattern. Handling and processing can distort the "theoretical" unit cell. Although some parameters, such as tow size and fiber angle, may be explicitly defined, calculation of unit cell dimensions tend to be somewhat subjective. Unit cell dimensions are based on varying interpretations of the textile architecture. For a description of the method used to determine the unit cell dimension refer to Chapter 2 of this document.

4. Summary of Test Method

4.1 A flat strip of material having a constant rectangular cross-section and a centrally located hole, as shown in Figure 1, is loaded in compression by a shear load acting along the grips. The shear load is applied via wedge grips.

4.2 To obtain compression test results, the specimen is inserted into the test fixture [Ref. 2.1.1] shown in Figure 2. The test fixture provides lateral support along the specimen length to prevent buckling. The untabbed specimen ends are then

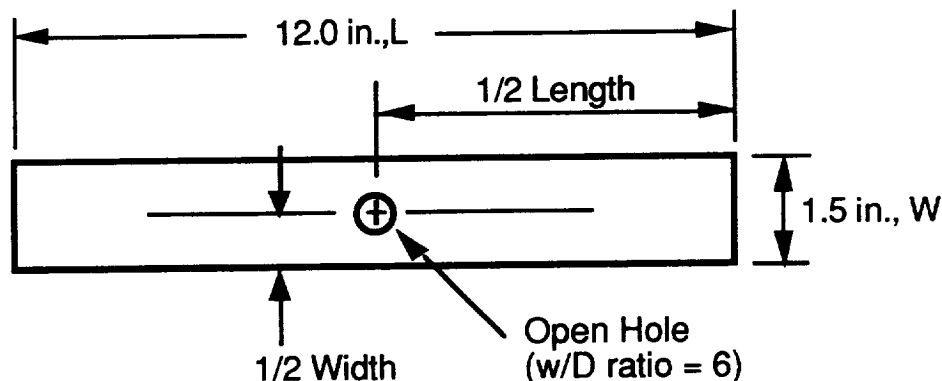

Figure 1. Open Hole Compression Test Specimen.

Open Hole Compression Testing of Textile Composites

mounted in the testing machine grips. The specimen is then loaded in axial compression. The ultimate compression strength of the material, as obtained with this test fixture and specimen, can be obtained from the maximum load carried prior to failure. The ultimate strength is calculated based on the gross cross-sectional area, disregarding the hole and then corrected for finite width effects. In addition, strain may be monitored with strain or displacement transducers mounted away from the hole so that the far-field stress-strain response of the material can be

has an independent unit cell size. This repeating inhomogeneity may cause variability in the test results if specimens are sized solely by using guidelines established for tape materials.

5.2 This test method is designed to produce notched compression property data for material specifications, research and development and design. The factors that influence compression properties and, therefore, should be reported are: textile architecture as described by section 3.2, the method of material and specimen

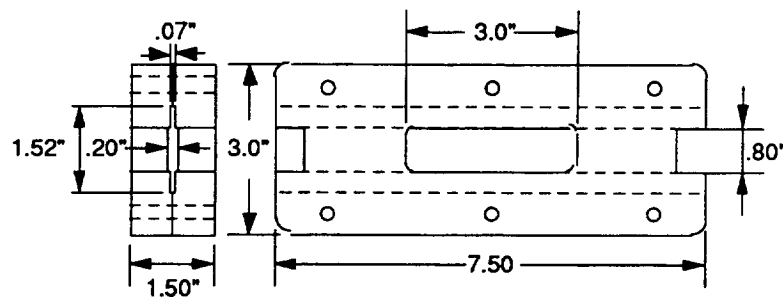

Figure 2. Open Hole Compression Test Fixture.

determined. The ultimate compressive strain, the compression modulus of elasticity, Poisson's ratio in compression, and the transition strain may be determined from the stress-strain curve.

5. Significance and Use

5.1 Textile composites have a less homogeneous nature than composites constructed from prepreg tape. Consequently, standard composite testing methods may not be adequate to characterize these materials. Each textile architecture

preparation, conditioning, fiber volume fraction and void content, the environment of testing and speed of testing. Properties, in the test direction, that may be obtained from this test method include:

5.2.1 Ultimate compressive strength,

5.2.2 Ultimate compressive strain,

5.2.3 Compressive modulus of elasticity,

5.2.4 Poisson's ratio in compression, and

Open Hole Compression Testing of Textile Composites

5.2.5 Transition strain.

5.3 This test method is the result of studies conducted at two independent testing laboratories. The primary contributor of test data was the Boeing Defense and Space Group in Philadelphia, PA. Supplemental data, obtained from Lockheed Aeronautical Systems in Marietta, GA, was also examined. Most of the data was derived from tests on two dimensional triaxial braids and three dimensional interlocking weaves. Some results for stitched uniweaves were also evaluated. An evaluation of the test method was made using results from each of the named contributors. A report summarizing this evaluation is being prepared and will be available in 1996.

5.4 This method is recommended for experiments conducted on 2-D braids, 3-D weaves, and similar textile architectures evaluated in reference document 2.1.2. Specifically, this test method has only been evaluated using the braids and weaves described in Chapter 2 of this document.

5.4.1 The recommended test specimen geometry was determined through the evaluation of 2-D braided materials whose unit cells ranged from 0.415 inch to 0.829 inch in width. The evaluation of textile composites with wider unit cells may require test specimens of greater width.

5.4.2 The recommended test specimen geometry was determined through the evaluation of 0.125 inch

thick 2-D braided materials whose moduli ranged from 4.9 to 10.6 MSI. Data establishing the viability of the test specimen geometry to textile composites with lower moduli and to thinner specimens are not available.

5.4.3 This test method has only been evaluated under room temperature - dry test conditions. Its applicability to testing textile composites under elevated temperature and moisture conditions has not been established.

6. Apparatus

6.1 The test fixture shown in Fig. 1 (Ref. 2.1.1) shall be used to support the test specimen. All other apparatus used shall be in accordance with ASTM Test Method D3410-94.

6.2 Strain-Indicating Device :

6.2.1 Although not required, longitudinal and transverse strains may be measured to determine the compressive modulus of elasticity and the Poisson's ratio. When applied, the strain measuring devices used to monitor these strains must be located at distances sufficiently far from the open hole to be removed from the stress risers that are associated with these discontinuities.

Longitudinal strain may also be simultaneously measured on opposite faces of the specimen to allow for a correction due to any bending of the specimen, and to

Open Hole Compression Testing of Textile Composites

enable detection of Euler (column) buckling.

6.2.2 When the Poisson's ratio is to be determined, the specimen shall be instrumented to measure strain in the lateral direction using the same type of transducer used to monitor the longitudinal strain. The same type of strain transducer shall be used for all strain measurements on any single coupon. Attachment of the strain-indicating device to the coupon shall not cause damage to the specimen surface.

6.3 Additionally, strain measurements may be made using an extensometer or strain gages of sufficient size as compared to the textiles unit cell size. Unit cell calculations shall be made according to Section 3.3 of this method. Strain gage selection shall be made in accordance with reference publication 2.1.4 of this test method, Masters, John E., "Strain Gage Size Effects of Textile Composites", NASA CR 198286, Feb. 1996

7. Sampling & Test Specimen

7.1 *Sampling* — Test at least five specimens per series unless valid results can be obtained using less specimens, such as by using a designed experiment. For statistically significant data use the procedure outlined in ASTM practice E 122. Report the method of sampling.

7.2 *Specimen Geometry* — The straight sided test specimen used in

this test is illustrated in Figure 1. The test specimen shall have a constant rectangular cross section with a specimen width variation of no more than $\pm 1\%$ and a specimen thickness variation of no more than $\pm 4\%$. Specific specimen dimensions shall be as follows:

7.2.1 *Specimen Width to Diameter & Diameter to Thickness Ratios* — A specimen width to hole diameter ratio (W/d) of 6 must be maintained. A hole diameter to thickness ratio (d/t) of 1.5 — 3.0 is recommended.

7.2.2 *Recommended Dimensions* — The specimen width shall be 1.50 ± 0.005 inch [36 ± 1 mm]; its length shall be 12.0 ± 0.10 inch [300 ± 2.5 mm]. The centrally located hole shall be 0.250 ± 0.003 inch [6 ± 0.06 mm] diameter. It shall be located within 0.005 inch [0.1 mm] of the axial centerline of the test specimen.

7.2.3 *Ratio of Specimen Width to Unit Cell Size* — The recommended specimen width was determined through the evaluation of 2-D braided materials whose unit cells ranged from 0.415 inch to 0.829 inch in width. The evaluation of textile composites whose unit cells are wider may require test specimens of greater width.

7.2.4 The recommended specimen thickness was determined through the evaluation of 0.125 inch thick 2-D braided materials whose moduli ranged from 4.9 to 10.6 MSI. The application of this method to thinner textile laminates or to

Open Hole Compression Testing of Textile Composites

material with a lower modulus may lead to Euler (column) buckling in the unsupported section of the test specimen. See Section 9.4.4.

7.3 Specimen Fabrication — The specimens may be molded individually without cut edges or machined from a plate after bonding on tab material. If cut from a plate, precautions must be taken to avoid notched, undercuts, or rough edges. When machined, each specimen should be saw cut oversized and ground to the final dimensions.

8. Conditioning

8.1 Standard Conditioning Procedure — Unless a different environment is required, the test specimens shall be conditioned in accordance with ASTM Procedure C of Test Method D5229 / D5229M. Store and test at standard laboratory conditions of $23\pm 1^\circ\text{C}$ [$73.4\pm 1.8^\circ\text{F}$] and $50\pm 10\%$ relative humidity.

9. Procedure

9.1 General Instructions:

9.1.1 Report any deviation from this test method, whether intentional or inadvertent.

9.1.2 If specific gravity, density, reinforcement volume, or void volume are to be reported, then obtain these samples from the same panels as the test samples. Specific gravity and density may be evaluated by means of Test Method D792. Volume percent of the constituents may be evaluated by

one of the matrix digestion procedures of Test Methods D3171, or, for certain reinforcement materials, such as glass, by the matrix burn-off technique of Test Method D2584. Void content may be evaluated from the equations of Test Method D2734, and are applicable to both Test Methods D2584 and D3171.

9.1.3 Following final specimen machining and any conditioning, but before testing, measure the specimen area as $A = W \times t$ at three places in the gage section and report the area as the average of these three measurements to within 1% accuracy. Record the average area in units of in^2 . Measure and report the specimen hole diameter to the nearest 0.001 inch [0.025 mm]. Inspect the hole to determine that it has been properly machined and free from delaminations.

9.1.4 If applicable, mount strain gages to both faces of the specimen.

9.2 Speed of Testing — Set the speed of testing to effect a nearly constant strain rate in the gage section. Testing speed shall be set at a constant displacement rate of between 0.02 and 0.05 in/min. as required to produce failure within 1 to 10 min.

9.3 Fixture Installation and Specimen Insertion:

9.3.1 Check the alignment of the loading frame to ensure that the grips are in good condition and that they will load the specimen properly.

Open Hole Compression Testing of Textile Composites

9.3.2 Check all load and strain gage recording instruments to insure that they are functioning properly.

9.3.3 Place the specimen in the Compression Test Fixture. The two halves of the support fixture should be only lightly bolted together to provide contact support to the specimen. Load the specimen and the fixture into the grips, taking care to maintain proper alignment of the long axis of the specimen with the loading direction..

9.4 Data Recording:

9.4.1 Record load versus strain (or displacement) continuously, or at frequent regular intervals. If a transition region (marked by a change in the slope of the stress-strain curve) is noted, record the load, strain, and mode of damage at such points. Record the maximum load, the failure load, and the strain at, or as near as possible to, the moment of failure.

9.4.2 Other valuable data that can be used in understanding testing anomalies and gripping or specimen slipping problems include load versus head displacement and load versus time data. These data may also be recorded.

9.4.3 A difference in the stress-strain or load-strain slope from opposite faces of the specimen indicates bending in the specimen. In order for the elastic property test results to be considered valid, percent bending in the specimen shall be less than 10% as determined by Equation 1.

Determine the percent bending at the mid-point of the strain range used for modulus calculations. The same requirements shall be met at failure strain for strength and strain-to-failure data to be considered valid. This requirement shall be met for all five of the specimen requiring back-to-back strain measurements. If possible, a plot of the percent bending versus average strain should be recorded to aid in the determination of the failure mode.

$$B_y = \frac{|\varepsilon_f - \varepsilon_b|}{|\varepsilon_f + \varepsilon_b|} \times 100 \leq 10\% \quad 1.$$

where:

- B_y = percent bending in specimen.
 ε_f = indicated strain from front transducer, $\mu\varepsilon$.
 ε_b = indicated strain from back transducer, $\mu\varepsilon$.

9.4.4 Rapid divergence of the strain readings of the opposite faces of the specimen, or rapid increase in percent bending, is indicative of the onset of Euler (column) buckling, which is not an acceptable compression failure mode for this test method. Record any indication of Euler buckling.

9.4.5 If the divergence is clearly due to the failure of only one of the strain gages and not the result of bending or twisting on the specimen, the results of the one working strain gage may be used

Open Hole Compression Testing of Textile Composites

and recorded as the longitudinal strain. The data report should clearly indicate this circumstance.

9.4.6 Test specimens that fail outside the hole are not valid and shall be discarded.

10. Calculations

10.1 Calculations of the elastic properties shall be made whenever possible using the following equations:

10.1.1 *Compression Strength* — Calculate the ultimate compression strength using Eqn. 2 and report results to three significant digits.

$$\sigma_{ult} = \frac{P}{wt} \quad 2.$$

where

- σ_{ult} = ultimate compression strength, MPa or KSI.
- P = maximum load, N or lbf.
- w = minimum specimen width, mm or in.
- t = minimum specimen thickness, mm or in.

10.1.2 *Compressive Modulus of Elasticity* — Calculate the modulus of elasticity from the stress-strain data using Equation 3. Data gathered over the 1000 to 3000 $\mu\epsilon$ strain range shall be used in these calculations. If data are not available at the exact strain range end points, use the closest available data point. Report the modulus of elasticity to three significant figures.

Also report the strain range used in the calculation.

10.1.2.1 The recommended strain ranges should only be used for material that do not exhibit a transition region (a significant change in the slope of the stress-strain curve) within the recommended strain range. If a transition region occurs within the recommended strain range, then a more suitable strain range should be used and reported.

$$E = \left(\frac{\Delta P}{\Delta l} \right) \left(\frac{l}{wt} \right) = \frac{\Delta \sigma}{\Delta \epsilon} \quad 3.$$

where:

- E = modulus of elasticity, MPa or KSI.
- $\Delta P / \Delta l$ = slope of the linear region of the load—deformation curve.
- l = gage length of strain measuring instrument, mm or in.
- w = minimum specimen width.
- t = minimum specimen thickness.

10.1.3 *Poisson's Ratio* — Determine the transverse strain (strain in the plane of the specimen and perpendicular to the applied load), ϵ_x , at each point over the longitudinal strain range of 1000 and 3000 $\mu\epsilon$. If data are not available at the exact strain range end points, use the closest available data point. Calculate Poisson's ratio from Equation 4. Report the results

Open Hole Compression Testing of Textile Composites

of the calculation to three significant digits.

$$\nu = -\frac{\Delta\varepsilon_x}{\Delta\varepsilon_y} \quad 4.$$

where:

ν = Poisson's Ratio.

$\Delta\varepsilon_x / \Delta\varepsilon_y$ = Slope of the strain-strain curve in the linear region where ε_y denotes the strain in the loading direction and ε_x denotes the strain perpendicular to the loading direction.

10.1.3.1 When determining the Poisson's ratio, match the transverse strain with the appropriate longitudinal strain. For instance, match the output from a single transverse strain gage with the output from the single longitudinal gage mounted in an adjacent location on the same side of the coupon. If back-to-back transverse gages are employed, average their output and compare to the average longitudinal strain.

10.1.4 *Transition Strain* — Where applicable, determine the transition strain from either the bilinear longitudinal stress versus longitudinal strain curve of the bilinear transverse strain versus longitudinal strain curve. Create a best linear fit for each of the two linear regions and extend the lines until they intersect. Determine the longitudinal strain that corresponds to the intersection point and record this value as the transition strain.

Report this value to three significant figures. Also report the method of linear fit and the strain ranges over which the linear fit were determined.

10.1.5 *Width to Diameter Ratio*— Calculate the width to diameter ratio using equation 5. Report both the nominal value and the actual calculated value from measured dimensions.

$$W/d \text{ ratio} = \frac{W}{d} \quad 5.$$

where

W = specimen width (neglecting the hole), mm or in.

d = diameter of hole, mm or in.

10.2 *Data Correction* — The test data shall be corrected for finite width using the following isotropic finite width correction factor. This factor is defined by equation 6.

$$\frac{\sigma_\infty}{\sigma_{gross}} = \frac{[2 + (1 - \frac{d}{W})^3]}{3(1 - \frac{d}{W})} \quad 6.$$

where

σ_∞ = Infinite stress, MPa or Ksi.

σ_{gross} = Gross stress, MPa or Ksi.

W = specimen width (neglecting the hole), mm or in.

d = diameter of hole, mm or in.

Open Hole Compression Testing of Textile Composites

10.3 **Statistics** — For each series of tests calculate and report to three significant digits the average value, standard deviation, and percent coefficient of variation for each property determined. Use equation 7, 8, and 9 to determine these values.

$$\bar{X} = \frac{\left(\sum_{i=1}^n X_i \right)}{n} \quad 7.$$

$$S_{n-1} = \sqrt{\frac{\left(\sum_{i=1}^n x^2 - n\bar{X}^2 \right)}{(n-1)}} \quad 8.$$

$$\%CoV = 100 \times S_{n-1} / \bar{X} \quad 9.$$

where

- \bar{X} = sample mean (average).
- n = number of specimens.
- X_i = measured or derived property.
- S_{n-1} = sample standard deviation.
- $\%CoV$ = sample coefficient of variation, in percent.

11. Report

11.1 The report shall include all appropriate parameters in accordance with ASTM Test Method D3410-94, making use of ASTM guides E1309, E1471, and E1434.

11.2 As a minimum, the report shall include the following:

11.2.1 A complete identification of the material tested using terms defined in reference publication 2.1.3; Pastore, Christopher M., "Illustrated Glossary of Textile Terms for Composites", NASA CR 191539, Sept. 1993.

11.2.2 The number of specimens tested.

11.2.3 The fiber and resin density used and how they were measured.

11.2.4 The average value and standard deviation of the fiber volume fraction of the composite and how it was measured.

11.2.5 The average value of ultimate open hole strength, the corrected value of the open hole strength, the standard deviation, and the coefficient of variation for the population.

11.2.6 The nominal and actual width to diameter ratio (W/d).

11.2.7 The nominal and actual diameter to thickness ratio (d/t).

11.2.8 Failure mode and location of failure for each specimen.

11.3 Where applicable, the following may also be reported:

11.3.1 Ultimate compressive strain,

11.3.2 Compressive modulus of elasticity,

Open Hole Compression Testing of Textile Composites

11.3.3 Poisson's ratio in compression, and

11.3.4 Transition strain.

12. Precision and Bias

12.1 The following criteria should be used for judging the acceptability of the results:

12.1.1 *Repeatability* — The results should be considered suspect if two averages obtained by the same testing laboratory differ by more than 2 standard deviations.

12.1.2 *Reproducibility* — The results should be considered suspect if two averages obtained by different testing laboratories differ by more than 2.8 standard deviations.

Standard Test Method for Filled Hole Tension Testing of Textile Composites

1. Scope

1.1 This test method determines the filled hole tension strength of textile composite materials. This recommendation does not attempt to address all aspects of filled hole tension testing of all textile architectures. Rather, procedures are recommended to establish a standard method of filled hole tension testing between testing laboratories. This method is limited to the textile architectures identified in Chapter 2 of this document.

1.2 This test method does not purport to address all of the safety issues associated with its use. It is the responsibility of the user to establish appropriate safety and health practices prior to initiating testing.

2. Reference Documents

2.1 Reference Publications:

2.1.1 Minguet, Pierre J., Fedro, Mark J., Gunther, Christian K., "Test Methods for Textile Composites" NASA CR 4609, July 1994.

2.1.2 Portanova, M.A., "Standard Methods for Filled Hole Tension Testing of Textile Composites", NASA CR 198263, Dec. 1995.

2.1.3 Pastore, Christopher M., "Illustrated Glossary of Textile Terms for Composites", NASA CR 191539, Sept. 1993.

2.1.4 Masters, John E., "Strain Gage Practice for Textile Composites", NASA CR 198286, Feb. 1996

2.2 ASTM Standards:

D792 Test Methods for Specific Gravity and Density of Plastics by Displacements.

D883 Terminology Relating to Plastics.

D2584 Test Method for Ignition Loss of Cured Reinforced Resins.

D2734 Test Methods for Void Content of Reinforced Plastics.

D3039 Test Method for Tensile Properties of Polymer Matrix Composite Materials.

D3171 Test Method for Fiber Content of Resin Matrix Composites by Matrix Digestion.

D3878 Terminology of High-Modulus Reinforced Fiber and Their Composites.

D5766 Standard Test Method for Open Hole Tensile Strength of Polymer Matrix Composite Laminates

Filled Hole Tension Testing of Textile Composites

E6 Terminology Relating to Methods of Mechanical Testing.

E177 Practice for use of Terms Precision and Bias in ASTM Test Methods.

E456 Terminology Relating to Quality and Statistics.

E1434 Guide for Development of Standard Data Records for Computerization of Mechanical Test Data for High-Modulus Fiber-Reinforced Composite Materials.

3. Terminology

3.1 *Definitions* — Definitions used in this test method are defined by various ASTM methods. ASTM method D3878 defines terms relating to high-modulus fiber and their composites. ASTM method D883 defines terms relating to plastics. ASTM method E6 defines terms relating to mechanical testing. ASTM methods E456 and E177 define terms relating to statistics. In the event of a conflict between definitions of terms, ASTM method D3878 shall have precedence over the other standards.

3.2 *Description of Terms Specific to This Standard*:— Terms relating specifically to textile composites are defined by reference publication 2.1.3; Pastore, Christopher M., "Illustrated Glossary of Textile Terms for Composites", NASA CR 191539, Sept. 1993.

3.3 *The Unit Cell* — In theory, textile composites have a repeating geometrical pattern based on manufacturing parameters. This repeating pattern is often called the material's "unit cell". It is defined as the smallest section of architecture required to repeat the textile pattern. Handling and processing can distort the "theoretical" unit cell. Although some parameters, such as tow size and fiber angle, may be explicitly defined, calculation of unit cell dimensions tend to be somewhat subjective. Unit cell dimensions are based on varying interpretations of the textile architecture. For a description of the method used to determine the unit cell dimensions refer to Chapter 2 of this document.

4. Summary of Test Method

4.1 Filled Hole Tension Tests of a textile composite materials are performed in accordance with ASTM Standard Test Method D5766. A titanium Hilok fastener is installed in the open hole tension specimen described in Section 6 of this report and illustrated in Figure 1. The fastener is torqued to 25 - 30 in•lbf. The specimen is then mounted in the grips of the testing machine and loaded in uniaxial tension to failure. Ultimate strength is calculated based on the gross cross-sectional area, disregarding the hole, and then corrected for finite width effects.

Filled Hole Tension Testing of Textile Composites

5. Significance and Use

5.1 Textile composites have a less homogeneous nature than composites constructed from prepreg tape. Consequently, standard composite testing methods may not be adequate to characterize these materials. Each textile architecture has an independent unit cell size. This repeating inhomogeneity may cause variability in the test results if specimens are sized solely by using guidelines established for tape materials.

5.2 This test method is designed to produce filled hole tension strength data for material specifications, research and development, design, and quality assurance. The factors that influence tensile properties, and therefore should be reported are: textile architecture as described by section 3.2, the method of material fabrication and overall thickness, specimen geometry, specimen preparation, specimen fiber volume fraction and void content, the environment of testing and speed of testing. Properties that may be derived from this test method include the following:

5.2.1 Filled hole (notched) tensile strength.

5.3 This test method is the result of studies conducted at two independent testing laboratories. The primary contributor of test data was Boeing Defense and Space Group in Philadelphia, PA. Supplemental data was obtained from Lockheed Aeronautical Systems in Marietta, GA. Most of the

data was derived from tests on two dimensional triaxial braids and three dimensional interlocking weaves. Lockheed also evaluated a three dimensional braid. An evaluation of test method was made using results from each of the contributors and is available in reference document 2.1.2 Portanova, M.A., "Standard Methods for Filled Hole Tension Testing of Textile Composites", NASA CR 198263, Dec. 1995.

5.4 This method is recommended for experiments conducted on 2-D braids, 3-D weaves, and similar textile architectures evaluated in reference document 2.1.2. Specifically, this test method has only been evaluated using the braids and weaves described in Chapter 2 of this document.

5.5 This test method has only been evaluated under room temperature - dry test conditions. Its applicability to testing textile composites under elevated temperature and moisture conditions has not been established.

6. Apparatus

6.1 The test apparatus used shall be in accordance with ASTM Test Method D3039. However, the procedure herein does not measure material response, so strain or deflection measurement related discussion in Test Method D3039 do not apply. Additionally, a micrometer or gage capable of determining the hole diameter to 0.001 in. is required.

Filled Hole Tension Testing of Textile Composites

7. Sampling & Test Specimen

7.1 *Sampling* — Test at least five specimens per series unless valid results can be obtained using less specimens, such as by using a designed experiment. For statistically significant data use the procedure outlined in ASTM practice E 122. Report the method of sampling.

7.2 *Specimen Geometry* — The test specimen geometry shall be in accordance with ASTM Test Method D5766. Specifically, the straight sided specimen geometry illustrated in Figure 1 shall be as follows:

7.2.2 *Recommended Dimensions* — The specimen width shall be 36 ± 0.1 mm [1.50 ± 0.005 in.] and the length range is 200 — 300 mm [8.0 — 12.0 in.]. The centrally located hole shall be 6.0 ± 0.006 mm [0.250 ± 0.003 in.] diameter and be located within 0.13 mm [0.005 in.] of the axial centerline of the test specimen.

7.2.3 *Ratio of Specimen Width to Unit Cell Size* — The recommended specimen width was determined through the evaluation of 2-D braided materials whose unit cells ranged from 0.415 inch to

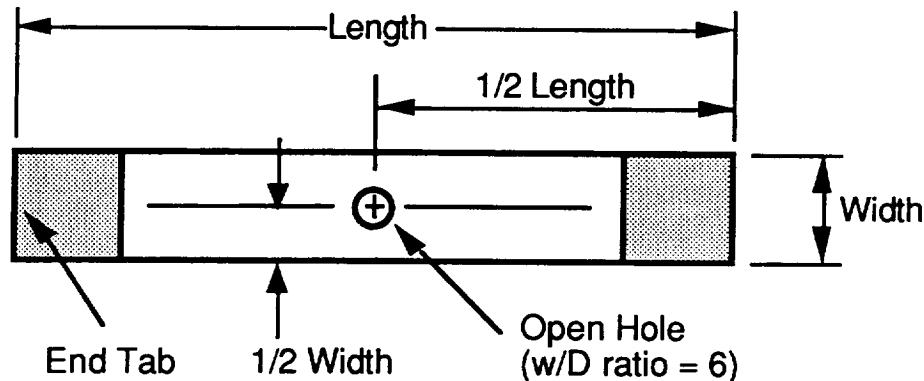

Figure 1. Filled Hole Tension Test Specimen.

7.2.1 *Specimen Width & Thickness* — A specimen width to hole diameter ratio (W/d) of 6 must be maintained. A hole diameter to thickness ratio (d/t) of 1.5 — 3.0 is recommended. The test specimen shall have a constant rectangular cross section with a specimen width variation of no more than $\pm 1\%$ and a specimen thickness variation of no more than $\pm 4\%$.

0.829 inch in width. The evaluation of textile composites whose unit cells are wider may require test specimens of greater width.

7.2.4 *Filled Hole* — The through hole shall be filled with a 0.250 in. diameter titanium Hilok fastener. This fastener shall be torqued to 25-30 in•lbf.

Filled Hole Tension Testing of Textile Composites

7.3 Specimen Fabrication — The specimens may be molded individually without cut edges or machined from a plate after bonding on tab material. If cut from a plate, precautions must be taken to avoid notched, undercuts, or rough edges. When machined, each specimen should be saw cut oversized and ground to the final dimensions.

7.4 Hole Preparation — Due to the dominant presence of the notch, consistent preparation of the hole, without damage to the laminate, is important to meaningful results. Damage due to hole preparation will affect strength results. Some types of damage, such as delaminations, can blunt the stress concentration at the hole and increase the load-carrying capacity of the coupon.

7.4 End Tabs — Tabs are not required but may be used. Typically the hole induces a stress riser sufficient to force failure in the notched region.

8. Conditioning

8.1 Standard Conditioning Procedure — Unless a different environment is required, the test specimens shall be conditioned in accordance with ASTM Procedure C of Test Method D5229 / D5229M.. Store and test at standard laboratory conditions of $23\pm 1^{\circ}\text{C}$ [$73.4\pm 1.8^{\circ}\text{F}$] and $50\pm 10\%$ relative humidity.

9. Procedure

9.1 General Instructions:

9.1.1 Report any deviations from this test method, whether intentional or inadvertent.

9.1.2 Following final specimen machining and any conditioning, but before testing, determine the area as $A = w \times h$ at three places in the gage section and report the area as the average of these three determinations, to an accuracy of ± 0.0001 in. in thickness measurements and ± 0.001 in. in width measurements. Record the minimum values of cross-sectional area so determined. Also measure and report the specimen hole diameter to the nearest 0.001 in. Inspect the hole and areas adjacent to the hole for delaminations. Report the location and size of any delaminations found.

9.2 Speed of Testing — Testing speed shall be set at a constant displacement rate of between 0.02 and 0.05 in/min. as required to produce failure within 1 to 10 min.

9.3 Specimen Insertion — Place the specimen in the grips of the testing machine, taking care to align the long axis of the gripped specimen with the test direction. Tighten the grips, recording the pressure used on pressure controllable (hydraulic or pneumatic) grips.

9.4 Loading — Apply the load to the specimen at the specified rate until failure, while recording data.

9.5 Data Recording —

9.5.1 If possible, record load continuously, or at frequent regular

Filled Hole Tension Testing of Textile Composites

intervals. Record the maximum load and the failure load at, or as near as possible to, the moment of rupture.

9.5.2 Other valuable data that can be used in understanding testing anomalies and gripping or specimen slipping problems include load versus head displacement and load versus time data. These data may also be recorded.

9.6 *Failure Mode* — Record the mode and location of failure of the specimen. The failure is often heavily influenced by delamination and the failure mode may exhibit much delamination. Failures that do not occur at the hole are not acceptable failure modes and the data shall be noted as invalid.

10. Calculations

Calculations shall be made using the following equations:

10.1 *Ultimate Strength* — Calculate the ultimate filled hole tensile strength using Equation 1. Report results to three significant digits.

$$\sigma_{ult} = \frac{P_{max}}{wt} \quad 1.$$

where:

σ_{ult} = ultimate open hole tensile strength, MPa or Ksi.
 P_{max} = maximum load prior to failure, N or lbf.

w = specimen width (neglecting the hole), mm or in.

t = specimen thickness, mm or in.

10.2 *Data Correction* — The test data shall be corrected for finite width using the following isotropic finite width correction factor. This factor is defined by equation 2.

$$\frac{\sigma_{\infty}}{\sigma_{gross}} = \frac{[2 + (1 - \frac{d}{W})^3]}{3(1 - \frac{d}{W})} \quad 2.$$

where

σ_{∞} = Infinite stress, MPa or Ksi.

σ_{gross} = Gross stress, MPa or Ksi.

W = specimen width (neglecting the hole), mm or in.

d = diameter of hole, mm or in.

10.3 *Width to Diameter Ratio*— Calculate the actual width to diameter ratio using equation 3. Report both the nominal ratio calculated using nominal values and the actual ratio calculated with measured dimensions.

$$W/d \text{ ratio} = \frac{W}{d} \quad 3.$$

where

Filled Hole Tension Testing of Textile Composites

W = specimen width (neglecting the hole), mm or in.

d = diameter of hole, mm or in.

10.4 *Statistics* — For each series of tests calculate and report to three significant digits the average value, standard deviation, and percent coefficient of variation for each property determined. Use equations 4, 5, and 6 to determine these values.

$$\bar{X} = \frac{\left(\sum_{i=1}^n X_i \right)}{n} \quad 4.$$

$$S_{n-1} = \sqrt{\frac{\left(\sum_{i=1}^n x^2 - n\bar{X}^2 \right)}{(n-1)}} \quad 5.$$

$$\%CoV = 100 \times S_{n-1} / \bar{X} \quad 6.$$

where

\bar{X} = sample mean (average).

n = number of specimens.

X_i = measured or derived property.

S_{n-1} = sample standard deviation.

$\%CoV$ = sample coefficient of variation, in percent.

11. Report

11.1 The report shall include all appropriate parameters in accordance with ASTM Test Method

D5766, making use of ASTM guides E1309, E1471, and E1434.

11.2 As a minimum, the report shall include the following:

11.2.1 A complete identification of the material tested using terms defined in reference publication 2.1.3; Pastore, Christopher M., "Illustrated Glossary of Textile Terms for Composites", NASA CR 191539, Sept. 1993.

11.2.2 The number of specimens tested.

11.2.3 The fiber and resin density used and how they were measured.

11.2.4 The average value and standard deviation of the fiber volume fraction of the composite and how it was measured.

11.2.5 The average value of ultimate filled hole strength, the corrected value of the filled hole strength, the standard deviation, and the coefficient of variation for the population.

11.2.6 The nominal and actual width to diameter ratio (W/d).

11.2.7 The nominal and actual diameter to thickness ratio (d/t).

11.2.8 Failure mode and location of failure for each specimen.

12. Precision and Bias

12.1 The following criteria should be used for judging the acceptability of the results:

Filled Hole Tension Testing of Textile Composites

12.1.1 *Repeatability* — The results should be considered suspect if two averages obtained by the same testing laboratory differ by more than 2 standard deviations.

12.1.2 *Reproducibility* — The results should be considered suspect if two averages obtained by different testing laboratories differ by more than 2.8 standard deviations.

Standard Test Method for Bolt-Bearing Testing of Textile Composites

1. Scope

1.1 This test method determines the bolt-bearing strength of textile composite materials. This recommendation does not attempt to address all aspects of bolt-bearing testing of all textile architectures. Rather, procedures are recommended to establish a standard method of bolt-bearing testing between testing laboratories. This method is limited to the textile architectures identified in Chapter 2 of this document.

1.2 This test method does not purport to address all of the safety issues associated with its use. It is the responsibility of the user to establish appropriate safety and health practices prior to initiating testing.

2. Reference Documents

2.1 Reference Publications:

2.1.1 Minguet, Pierre J., Fedro, Mark J., Gunther, Christian K., "Test Methods for Textile Composites" NASA CR 4609, July 1994.

2.1.2 Portanova, M.A., "Standard Methods for Bolt-Bearing Testing of Textile Composites", NASA CR 198266, Dec. 1995.

2.1.3 Pastore, Christopher M., "Illustrated Glossary of Textile Terms for Composites", NASA CR 191539, Sept. 1993.

2.2 ASTM Standards:

D792 Test Methods for Specific Gravity and Density of Plastics by Displacements.

D883 Terminology Relating to Plastics.

D2584 Test Method for Ignition Loss of Cured Reinforced Resins.

D2734 Test Methods for Void Content of Reinforced Plastics.

D3039 Test Method for Tensile Properties of Polymer Matrix Composite Materials.

D3171 Test Method for Fiber Content of Resin Matrix Composites by Matrix Digestion.

D3878 Terminology of High-Modulus Reinforced Fiber and Their Composites.

D5766 Standard Test Method for Open Hole Tensile Strength of Polymer Matrix Composite Laminates

E6 Terminology Relating to Methods of Mechanical Testing.

E177 Practice for use of Terms Precision and Bias in ASTM Test Methods.

E456 Terminology Relating to Quality and Statistics.

Bolt-Bearing Testing of Textile Composites

E1434 Guide for Development of Standard Data Records for Computerization of Mechanical Test Data for High-Modulus Fiber-Reinforced Composite Materials.

3. Terminology

3.1 Definitions — Definitions used in this test method are defined by various ASTM methods. ASTM method D3878 defines terms relating to high-modulus fiber and their composites. ASTM method D883 defines terms relating to plastics. ASTM method E6 defines terms relating to mechanical testing. ASTM methods E456 and E177 define terms relating to statistics. In the event of a conflict between definitions of terms, ASTM method D3878 shall have precedence over the other standards.

3.2 Description of Terms Specific to This Standard — Terms relating specifically to textile composites are defined by reference publication 2.1.3; Pastore, Christopher M., "Illustrated Glossary of Textile Terms for Composites", NASA CR 191539, Sept. 1993.

3.3 The Unit Cell — In theory, textile composites have a repeating geometrical pattern based on manufacturing parameters. This repeating pattern is often called the material's "unit cell". It is defined as the smallest section of architecture required to repeat the textile pattern. Handling and processing can distort the "theoretical" unit cell. Although some parameters, such as tow size and fiber angle, may be explicitly defined, calculation of unit cell

dimensions tend to be somewhat subjective. Unit cell dimensions are based on varying interpretations of the textile architecture. For a description of the method used to determine the unit cell dimensions refer to Chapter 2 of this document.

4. Summary of Test Method

4.1 Two flat, constant rectangular cross-section coupons with centerline holes located near their ends, as shown in Figure 1, are loaded at the holes in bearing. The bearing load is applied through close-tolerance, lightly-torqued fasteners that are reacted in double shear by a fixture that is shown in the figure. The bearing load is created by pulling the assembly in tension in a testing machine.

4.2 The applied load is monitored. The load is normalized by the projected hole area to create an effective bearing stress. The assembly is loaded until a load maximum has clearly been reached, whereupon the test is terminated. This prevents masking of the true failure mode by large-scale hole distortion and permits representative failure mode assessment. The ultimate bearing strength of the material is determined from the maximum load carried prior to test termination.

5. Significance and Use

5.1 Textile composites have a less homogeneous nature than composites constructed from prepreg tape. Consequently, standard

Bolt-Bearing Testing of Textile Composites

composite testing methods may not be adequate to characterize these materials. Each textile architecture has an independent unit cell size. This repeating inhomogeneity may cause variability in the test results if specimens are sized solely by using guidelines established for tape materials.

5.2 This test method is designed to produce bolt-bearing strength data for materials specifications, research and development, quality assurance, and structural design and analysis.

5.3 Factors that influence the bearing strength, and therefore should be reported are: textile architecture as described by section 3.2, the method of material fabrication, and overall thickness, specimen geometry (thickness, width, hole diameter, edge distance ratio, pitch distance ratio, and the diameter to thickness ratio), fastener torque, hole clearance, hole quality, specimen fiber volume fraction and void content, the environment of testing and speed of testing. Properties that may be derived from this test method include the following:

5.3.1 Bearing ultimate strength.

5.4 This test method is the result of a study conducted at Boeing Defense and Space Group in Philadelphia, PA. All of the data was derived from tests on two dimensional triaxial braids. Three different specimen configurations were examined, as were various pitch distance (W/D) and edge distance (e/D) ratios. An evaluation

of test method was made using results from Boeing's study and is available in reference document 2.1.2, Portanova, M.A., "Standard Methods for Bolt-Bearing Testing of Textile Composites", NASA CR 198266, Dec. 1995.

5.5 This method is recommended for experiments conducted on 2-D braids, 3-D weaves, and similar textile architectures evaluated in reference document 2.1.2. Specifically, this test method has only been evaluated using the braids and weaves described in Chapter 2 of this document.

5.6 This test method has only been evaluated under room temperature - dry test conditions. Its applicability to testing textile composites under elevated temperature and moisture conditions has not been established.

6. Apparatus

6.1 The test apparatus used shall be in accordance with ASTM Test Method D3039. However, the procedure herein does not measure material response, so strain or deflection measurement related discussion in Test Method D3039 do not apply. Additionally, a micrometer or gage capable of determining the hole diameter to 0.001 in. is required.

7. Sampling & Test Specimen

7.1 *Sampling* — Test at least five specimens per series unless valid

Bolt-Bearing Testing of Textile Composites

results can be obtained using less specimens, such as by using a designed experiment. For statistically significant data use the procedure outlines in ASTM practice E 122. Report the method of sampling.

7.2 Specimen Geometry — The test specimen geometry is illustrated in Figure 1.

7.2.1 Specimen Width, Thickness and Hole Diameter — A pitch distance ratio, (specimen width to hole diameter ratio, W/d) of 6 must

be maintained. An edge distance ratio (specimen edge distance to hole diameter ratio, e/D) of 3 or greater should be used. These dimensions are illustrated in Figure 2. A hole diameter to thickness ratio (d/t) of 1.5 — 3.0 is recommended. The test specimen shall have a constant rectangular cross section with a specimen width variation of no more than $\pm 1\%$ and a specimen thickness variation of no more than $\pm 4\%$.

7.2.2 Recommended Dimensions — The specimen width shall be 36 ± 0.1 mm [1.50 ± 0.003 in.]. The

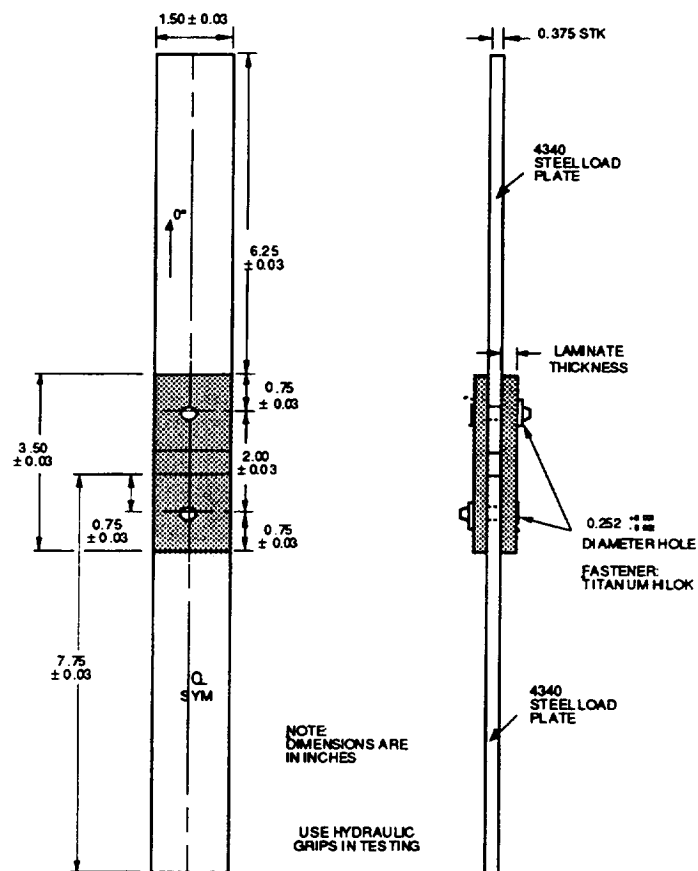

Figure 1. Bolt-Bearing Test Specimen.

Bolt-Bearing Testing of Textile Composites

specimen length shall be 89 ± 1 mm [3.50 ± 0.03 in.]. The centrally located holes shall be 6.0 ± 0.06 mm [0.250 ± 0.003 in.] diameter and be located within 0.13 mm [0.005 in.] of the axial centerline of the test specimen. The hole edge to specimen edge distance shall be $15.9\text{ mm}\pm 0.1\text{ mm}$ [0.625 ± 0.005 in.].

7.2.3 Ratio of Specimen Width to Unit Cell Size — The recommended specimen width was determined through the evaluation of 2-D braided materials whose unit cells ranged from 0.415 inch to 0.829 inch in width. The evaluation of textile composites whose unit cells are wider may require test specimens of greater width.

7.2.4 Fastener and Fastener Torque — Titanium Hilok fasteners should be used in the tests. The 0.250 in. diameter fasteners shall be torque to 25-30 in•lbf.

7.3 Specimen Fabrication — The specimens may be molded individually without cut edges or machined from a plate after bonding on tab material. If cut from a plate, precautions must be take to avoid notched, undercuts, or rough edges. When machined, each specimen should be saw cut oversized and ground to final dimensions.

7.4 Hole Preparation — Consistent preparation of the hole, without damage to the laminate, is important to meaningful results. Damage due to hole preparation will affect strength results. Some types of damage, such as delaminations,

can blunt the stress concentration at the hole and increase the load-carrying capacity of the coupon.

8. Conditioning

8.1 Standard Conditioning Procedure — Unless a different environment is required, the test specimens shall be conditioned in accordance with ASTM Procedure C of Test Method D5229 / D5229M.. Store and test at standard laboratory conditions of $23\pm 1^\circ\text{ C}$ [$73.4\pm 1.8^\circ\text{ F}$] and $50\pm 10\%$ relative humidity.

9. Procedure

9.1 General Instructions:

9.1.1 Report any deviations from this test method, whether intentional or inadvertent.

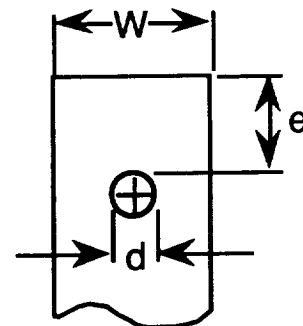

Figure 2. Bolt Bearing Specimen Dimensions.

9.1.2 Following final specimen machining and any conditioning, but before testing, measure the specimen width and thickness in the vicinity of the hole. Measure the hole diameter, the distance from the hole edge to the closest coupon side, and the distance from the hole edge to the coupon end. Inspect the

Bolt-Bearing Testing of Textile Composites

hole to determine that it has been properly machined and is free from delamination. Measure the fastener diameter at the bearing contact location. The accuracy of all measurements shall be within 1% of the dimension. Record the dimensions to three significant figures.

9.2 *Speed of Testing* — Testing speed shall set at a constant displacement rate of between 0.02 and 0.05 in/min. as required to produce failure within 1 to 10 min.

9.3 *Specimen Insertion* — Place the specimen in the grips of the testing machine, taking care to align the long axis of the gripped specimen with the test direction. Tighten the grips, recording the pressure used on pressure controllable (hydraulic or pneumatic) grips.

9.4 *Loading* — Apply the load to the specimen at the specified rate until failure, while recording data.

9.5 *Data Recording* —

9.5.1 If possible, record load continuously, or at frequent regular intervals. Record the maximum load and the failure load at, or as near as possible to, the moment of rupture.

9.5.2 Other valuable data that can be used in understanding testing anomalies and gripping or specimen slipping problems include load versus head displacement and load versus time data. These data may also be recorded.

9.6 *Failure Mode* — Record the mode and location of failure of the specimen.

10. **Calculations**

10.1 Calculations shall be made using the following equations.

10.1.1 *Bearing Strength* — Calculate the bolt-bearing strength using the following equation. Report results to three significant digits.

$$\sigma_b = \frac{P}{A} = \frac{P}{td} \quad 1.$$

where

- σ_b = ultimate bearing strength, MPa or Ksi.
- P = maximum load prior to failure, N or lbf.
- d = hole diameter, mm or in.
- t = specimen thickness, mm or in.

10.1.2 *Width to Diameter Ratio* — Calculate the width to diameter ratio (Fig. 1) using equation 2. Report both the nominal value and the actual calculated value from measured dimensions.

$$W/d \text{ ratio} = \frac{W}{d} \quad 2.$$

where

- W = specimen width (neglecting the hole), mm or in.
- d = diameter of hole, mm or in.

Bolt-Bearing Testing of Textile Composites

10.1.3 *Edge Distance to Hole Diameter Ratio* — Calculate the specimen edge distance to hole diameter ratio (Fig. 1) using equation 3. Report both the nominal value and the actual calculated value from measured dimensions.

$$\frac{e}{d} \text{ ratio} = \frac{e + (d/2)}{d} \quad 3.$$

where

- e = distance from hole to specimen edge, mm or in.
- d = diameter of hole, mm or in.

10.1.4 *Hole Diameter to Thickness Ratio* — Calculate the specimen hole diameter to thickness ratio using equation 4. Report the measured value.

$$\frac{d}{t} \text{ ratio} = \frac{d}{t} \quad 4.$$

where

- d = diameter of hole, mm or in.
- t = thickness, mm or in.

10.2 *Statistics* — For each series of tests calculate and report to three significant digits the average value, standard deviation, and percent coefficient of variation for each property determined. Use equations 5, 6, and 7 to determine these values.

$$\bar{X} = \frac{\left(\sum_{i=1}^n X_i \right)}{n} \quad 5.$$

$$S_{n-1} = \sqrt{\frac{\left(\sum_{i=1}^n x^2 - n\bar{X}^2 \right)}{(n-1)}} \quad 6.$$

$$\%CoV = 100 \times S_{n-1} / \bar{X} \quad 7.$$

where

- \bar{X} = sample mean (average).
- n = number of specimens.
- X_i = measured or derived property.
- S_{n-1} = sample standard deviation.
- $\%CoV$ = sample coefficient of variation, in percent.

11. Report

11.1 The report shall include all appropriate parameters making use of ASTM guides E1309, E1471, and E1434.

11.2 As a minimum, the report shall include the following:

11.2.1 A complete identification of the material tested using terms defined in reference publication 2.1.3; Pastore, Christopher M., "Illustrated Glossary of Textile Terms for Composites", NASA CR 191539, Sept. 1993.

Bolt-Bearing Testing of Textile Composites

11.2.2 The number of specimens tested.

11.2.3 The fiber and resin density used and how they were measured.

11.2.4 The average value and standard deviation of the fiber volume fraction of the composite and how it was measured.

11.2.5 The average value of bearing strength, the standard deviation, and the coefficient of variation for the population.

11.2.6 The nominal and actual width to diameter ratio.

11.2.7 The nominal and actual edge distance to diameter ratio.

11.2.8 Failure mode and location of failure for each specimen.

12. Precision and Bias

12.1 The following criteria should be used for judging the acceptability of the results:

12.1.1 *Repeatability* — The results should be considered suspect if two averages obtained by the same testing laboratory differ by more than 2 standard deviations.

12.1.2 *Reproducibility* — The results should be considered suspect if two averages obtained by different testing laboratories differ by more than 2.8 standard deviations.

Standard Test Method for Interlaminar Tension Testing of Textile Composites

1. Scope

1.1 This test method is a recommended procedure for determining the out-of-plane strength of textile composite materials. This recommendation does not attempt to address all aspects of out-of-plane testing of all textile architectures. Rather, procedures are recommended to establish a standard method of bolt-bearing testing between testing laboratories. This method is limited to the textile architectures identified in Chapter 2 of this document.

1.2 This test method does not purport to address all of the safety issues associated with its use. It is the responsibility of the user to establish appropriate safety and health practices prior to initiating testing.

2. Reference Documents

2.1 Reference Publications:

2.1.1 Minguet, Pierre J., Fedro, Mark J., Gunther, Christian K., "Test Methods for Textile Composites" NASA CR. 4609, July 1994.

2.1.2 Jackson, W. C. and Portanova, M. A., "Out-of-Plane Properties," NASA Conference Publication 3311, October 1995, pp. 315 - 349.

2.1.3 Pastore, Christopher M., "Illustrated Glossary of Textile Terms for Composites", NASA CR. 191539, Sept. 1993.

2.1.4 Jackson, W.C. and Ifju, P. "Through-the-Thickness Tensile Strength of Textile Composites," NASA TM 109115, May 1994

2.1.5 Jackson, W.C. and Martin, R.H., "An Interlaminar Tensile Strength Specimen," Composite Materials: Testing and Design (Eleventh Volume), ASTM STP 1206, E.T. Camponeschi, Jr., Ed., American Society for Testing and Materials, Philadelphia, Dec. 1993, pp. 333-354.

2.2 ASTM Standards:

D792 Test Methods for Specific Gravity and Density of Plastics by Displacements.

D883 Terminology Relating to Plastics.

D2584 Test Method for Ignition Loss of Cured Reinforced Resins.

D2734 Test Methods for Void Content of Reinforced Plastics.

D3039 Test Method for Tensile Properties of Polymer Matrix Composite Materials.

Interlaminar Tension Testing of Textile Composites

D3171 Test Method for Fiber Content of Resin Matrix Composites by Matrix Digestion.

D3878 Terminology of High-Modulus Reinforced Fiber and Their Composites.

E6 Terminology Relating to Methods of Mechanical Testing.

E177 Practice for use of Terms Precision and Bias in ASTM Test Methods.

E456 Terminology Relating to Quality and Statistics.

E1434 Guide for Development of Standard Data Records for Computerization of Mechanical Test Data for High-Modulus Fiber-Reinforced Composite Materials.

3. Terminology

3.1 *Definitions* — Definitions used in this test method are defined by various ASTM methods. ASTM method D3878 defines terms relating to high-modulus fiber and their composites. ASTM method D883 defines terms relating to plastics. ASTM method E6 defines terms relating to mechanical testing. ASTM methods E456 and E177 define terms relating to statistics. In the event of a conflict between definitions of terms, ASTM method D3878 shall have precedence over the other standards.

3.2 *Description of Terms Specific to This Standard* — Terms relating specifically to textile composites are defined by reference publication 2.1.3; Pastore, Christopher M., "Illustrated Glossary of Textile Terms for Composites", NASA CR 191539, Sept. 1993.

3.3 *The Unit Cell* — In theory, textile composites have a repeating geometrical pattern based on manufacturing parameters. This repeating pattern is often called the material's "unit cell". It is defined as the smallest section of architecture required to repeat the textile pattern. Handling and processing can distort the "theoretical" unit cell. Although some parameters, such as tow size and fiber angle, may be explicitly defined, calculation of unit cell dimensions tend to be somewhat subjective. Unit cell dimensions are based on varying interpretations of the textile architecture. For a description of the method used to determine the unit cell dimension refer to Chapter 2 of this document.

4. Summary of Test Method

4.1 Out-of-Plane Testing of textile composite materials are performed in accordance with following procedure. The out-of-plane specimen illustrated in Figure 1 is used for this test method. Through-the-thickness tension is induced in the test section through the application of a constant moment, which attempts to open the curved section of the specimen (Fig. 2).

Interlaminar Tension Testing of Textile Composites

Radial stresses, σ_r , are determined using the closed-form analysis given by Equation 1.

5. Significance and Use

5.1 Textile composites have a less homogeneous nature than composites constructed from prepreg tape. Consequently, standard composite testing methods may not be adequate to characterize these materials. Each textile architecture has an independent unit cell size. This repeating inhomogeneity may cause variability in the test results if specimens are sized solely by using guidelines established for tape materials.

5.2 This test method is designed to produce out-of-plane strength data for material specifications, research and development and design. The factors that influence out-of-plane properties, and therefore should be reported are: textile architecture as described by section 3.2, the method of material fabrication and overall thickness, specimen geometry, specimen preparation, specimen fiber volume fraction and void content, the environment of testing and speed of testing.

5.3 This test method is the result of an evaluation of studies conducted at Boeing Defense and Space Group in Philadelphia, PA. and NASA Langley Research Center, Hampton VA. Three different specimen configurations were examined. The results of

these investigations are summarized in reference documents 2.1.1 and 2.1.2.

5.4 This method is only recommended for experiments conducted on two dimensional textile architectures. Specifically, this test method has only been evaluated using the braids described in Chapter 2 of this document.

5.5 This test method has only been evaluated under room temperature - dry test conditions. Its applicability to testing textile composites under elevated temperature and moisture conditions has not been established.

6. Apparatus

6.1 Apparatus shall be fabricated to the dimensions given by Figure 2.

7. Sampling & Test Specimen

7.1 *Sampling* — Test at least five specimens per series unless valid results can be obtained using less specimens, such as by using a designed experiment. For statistically significant data use the procedure outlines in ASTM practice E 122. Report the method of sampling.

7.2 *Specimen Geometry* — The test specimen geometry shall be as shown in Figure 1.

Interlaminar Tension Testing of Textile Composites

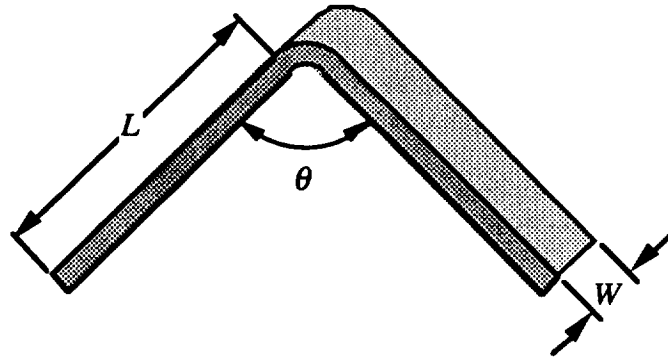

Figure 1. Four Point Bend Test Specimen.

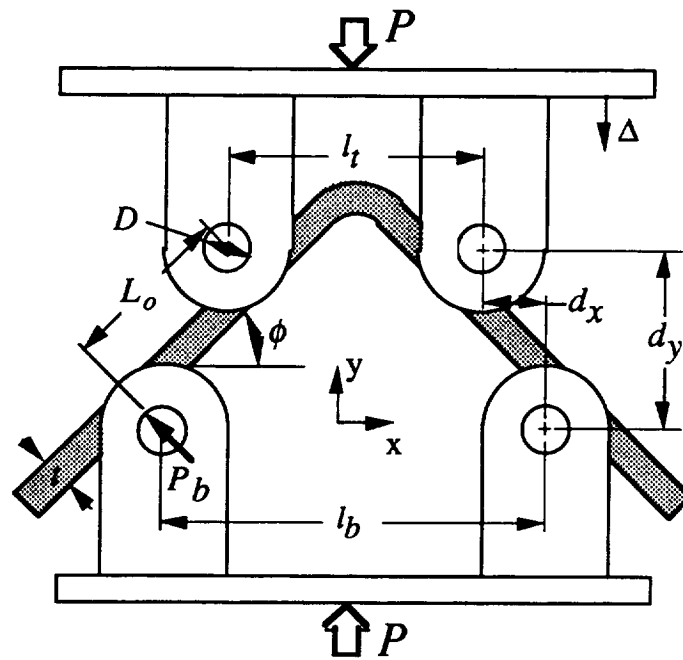

Figure 2. Four Point Bend Test Method.

where:

| | | |
|----------|-----|--------------------------|
| L | $=$ | >50.8 mm [>2.0 in.] |
| W | $=$ | 25.4 mm [1.0 in.] |
| t | $=$ | 6.35 mm [0.25 in.] |
| θ | $=$ | 90° |
| d_x | $=$ | 12.7 mm [0.5 in.] |
| D | $=$ | 12.7 mm [0.5 in.] |
| l_t | $=$ | 50.8 mm [2.0 in.] |
| l_b | $=$ | 76.2 mm [3.0 in.] |

Interlaminar Tension Testing of Textile Composites

7.3 Specimen Fabrication — The specimens may be molded individually without cut edges or machined from an angle shaped beam. If cut from a beam, precautions must be take to avoid notched, undercuts, or rough edges. When machined, each specimen should be saw cut oversized and ground to final dimensions. The test specimen shall have a constant rectangular cross section with a specimen width variation of no more than $\pm 1\%$ and a specimen thickness variation of no more than $\pm 4\%$.

7.2.3 Ratio of Specimen Width to Unit Cell Size — The recommended specimen width was determined through the evaluation of 2-D braided materials whose unit cells ranged from 0.415 inch to 0.829 inch in width. The evaluation of textile composites whose unit cells are wider may require test specimens of greater width.

8. Conditioning

8.1 Standard Conditioning Procedure — Unless a different environment is required, the test specimens shall be conditioned in accordance with ASTM Procedure C of Test Method D5229 / D5229M.. Store and test at standard laboratory conditions of $23\pm 1^\circ\text{C}$ [$73.4\pm 1.8^\circ\text{F}$] and $50\pm 10\%$ relative humidity.

9. Procedure

9.1 Measure and report the dimensions required, as given in Figures 1 and 2, to the nearest 0.025 mm [0.001 in.].

9.2 Speed of Testing — Testing speed shall set at a constant displacement rate of between 0.02 and 0.05 in/min.

9.3 Width and thickness should be measured in the radius section, at several locations to within 1%. Record the minimum values of cross-sectional area so determined.

9.4 Place the specimen between the upper and lower loading pins, taking care to maintain proper alignment between the loading rollers.

9.5 Place the loading fixture between two platens in a low capacity compression load frame. Ensure that the specimen is in line with the load frame centerline.

9.6 If possible, record load cell output continuously during testing.

9.7 Record the maximum load level achieved by the test specimen.

9.8 Test specimens that do not fail in out-of-plane tension are not valid and shall be discarded. For example, a failure that emanates from a radial crack is an invalid failure mode. Only failures that initiate from circumferential interlaminar cracks shall be considered valid.

Interlaminar Tension Testing of Textile Composites

10. Calculations

10.1 Calculations of the material response shall be made whenever possible using the following equations.

10.1.1 *Radial Stress* — Calculate the interlaminar strength using the following equations. Report results to three significant digits.

$$\sigma_r = -\frac{M}{r_o^2 W g} \left[1 - \frac{1 - \rho^{k+1}}{1 - \rho^{2k}} \left(\frac{r}{r_o} \right)^{k-1} - \frac{1 - \rho^{k-1}}{1 - \rho^{2k}} \rho^{k+1} \left(\frac{r_o}{r} \right)^{k+1} \right] \quad 1.$$

$$M = P_b L = \left(\frac{P}{2 \cos(\phi)} \right) \left(\frac{d_x}{\cos(\phi)} + (D + t) \tan(\phi) \right) \quad 2.$$

where:

$$g = \frac{1 - \rho^2}{2} - \frac{k}{k+1} \frac{(1 - \rho^{k+1})^2}{1 - \rho^{2k}} + \frac{k \rho^2}{k-1} \frac{(1 - \rho^{k-1})^2}{1 - \rho^{2k}}$$

$$k = \sqrt{\frac{E_\theta}{E_r}} \quad \& \quad \rho = \frac{r_i}{r_o}$$

and

- σ_r = radial stress, MPa or Ksi.
- r = centerline radius, mm or in.
- r_o = inner radius, mm or in.
- r_i = louter radius, mm or in.
- M = moment,
- d_x = horizontal distance between rollers, mm or in.
- d_y = vertical distance between rollers, mm or in.
- W = specimen width, mm or in.
- E_θ = moduli in the tangential direction
- E_r = moduli in the radial direction

Note: The tangential and radial moduli can be approximated by using the laminate's axial modulus and the neat resin's modulus, respectively.

Interlaminar Tension Testing of Textile Composites

10.2 *Statistics* — For each series of tests calculate and report to three significant digits the average value, standard deviation, and percent coefficient of variation for each property determined. Use equation 3, 4, and 5 to determine these values.

$$\bar{X} = \frac{\left(\sum_{i=1}^n X_i \right)}{n} \quad 3.$$

$$S_{n-1} = \sqrt{\frac{\left(\sum_{i=1}^n x^2 - n\bar{X}^2 \right)}{(n-1)}} \quad 4.$$

$$\%CoV = 100 \times S_{n-1} / \bar{X} \quad 5.$$

where

- \bar{X} = sample mean (average).
 n = number of specimens.
 X_i = measured or derived property.
 S_{n-1} = sample standard deviation.
 $\%CoV$ = sample coefficient of variation, in percent.

11. Report

11.1 The report shall include all appropriate parameters in accordance with ASTM Test Method D3039, making use of ASTM guides E1309, E1471, and E1434.

11.2 As a minimum, the report shall include the following:

11.2.1 A complete identification of the material tested using terms defined in reference publication 2.1.3; Pastore, Christopher M., "Illustrated Glossary of Textile Terms for Composites", NASA CR. 191539, Sept. 1993.

11.2.2 The number of specimens tested.

11.2.3 The fiber and resin density used and how they were measured.

11.2.4 The average value and standard deviation of the fiber volume fraction of the composite and how it was measured.

11.2.5 The average value of interlaminar strength, the standard deviation, and the coefficient of variation for the population.

11.2.6 Failure mode and location of failure for each specimen

12. Precision and Bias

12.1 The following criteria should be used for judging the acceptability of the results:

12.1.1 *Repeatability* — The results should be considered suspect if two averages obtained by the same testing laboratory differ by more than 2 standard deviations.

12.1.2 *Reproducibility* — The results should be considered suspect if two averages obtained by different testing laboratories differ by more than 2.8 standard deviations.

REPORT DOCUMENTATION PAGE

Form Approved
OMB No. 0704-0188

Public reporting burden for this collection of information is estimated to average 1 hour per response, including the time for reviewing instructions, searching existing data sources, gathering and maintaining the data needed, and completing and reviewing the collection of information. Send comments regarding this burden estimate or any other aspect of this collection of information, including suggestions for reducing the burden, to Washington Headquarters Services, Directorate for Information Operations and Reports, 1215 Jefferson Davis Highway, Suite 1204, Arlington, VA 22202-4302, and to the Office of Management and Budget, Paperwork Reduction Project (0704-0188), Washington, DC 20503.

| | | | | |
|---|---|--|---|--|
| 1. AGENCY USE ONLY (Leave Blank) | | 2. REPORT DATE September 1996 | 3. REPORT TYPE AND DATES COVERED Contractor Report | |
| 4. TITLE AND SUBTITLE Standard Test Methods for Textile Composites | | | 5. FUNDING NUMBERS C NAS1-19000 WU 505-63-10-10 | |
| 6. AUTHOR(S) John E. Masters & Marc A. Portanova | | | | |
| 7. PERFORMING ORGANIZATION NAME(S) AND ADDRESS(ES) Lockheed Martin Engineering & Sciences Company 144 Research Drive Hampton, VA 23666 | | | 8. PERFORMING ORGANIZATION REPORT NUMBER | |
| 9. SPONSORING/MONITORING AGENCY NAME(S) AND ADDRESS(ES) National Aeronautics and Space Administration Langley Research Center Hampton, VA 23681 | | | 10. SPONSORING/MONITORING AGENCY REPORT NUMBER NASA CR-4751 | |
| 11. SUPPLEMENTARY NOTES Langley Technical Monitor: Dr. Ivatury S. Raju | | | | |
| 12a. DISTRIBUTION/AVAILABILITY STATEMENT Unclassified-Unlimited Subject Category 24 | | | 12b. DISTRIBUTION CODE | |
| 13. ABSTRACT (Maximum 200 words) Standard testing methods for composite laminates reinforced with continuous networks of braided, woven, or stitched fibers have been evaluated. The microstructure of these "textile" composite materials differs significantly from that of tape laminates. Consequently, specimen dimensions and loading methods developed for tape type composites may not be applicable to textile composites. To this end, a series of evaluations were made comparing testing practices currently used in the composite industry. Information was gathered from a variety of sources and analyzed to establish a series of recommended test methods for textile composites. The current practices established for laminated composite materials by ASTM and the MIL-HDBK-17 Committee were considered. This document provides recommended test methods for determining both in-plane and out-of-plane properties. Specifically, test methods are suggested for: <ul style="list-style-type: none"> • unnotched tension and compression • open and filled hole tension • open hole compression • bolt bearing • interlaminar tension A detailed description of the material architectures evaluated is also provided, as is a recommended instrumentation practice. | | | | |
| 14. SUBJECT TERMS Textile Composites; Standard Test Methods; Size Effects | | | 15. NUMBER OF PAGES 83 | |
| | | | 16. PRICE CODE A05 | |
| 17. SECURITY CLASSIFICATION OF REPORT Unclassified | 18. SECURITY CLASSIFICATION OF THIS PAGE Unclassified | 19. SECURITY CLASSIFICATION OF ABSTRACT | 20. LIMITATION OF ABSTRACT | |