

NASA
Contractor Report 4760

Army Research Laboratory
Technical Report ARL-TR-1265

11-87
1-1-97

Demonstration of the Feasibility of High Temperature Bearing Lubrication From Carbonaceous Gases

Thierry A. Blanchet and W. Gregory Sawyer

CONTRACT NAS3-25950
DECEMBER 1996

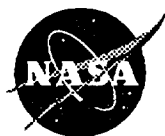

National Aeronautics and
Space Administration



NASA
Contractor Report 4760

Army Research Laboratory
Contractor Report ARL-TR-1265

Demonstration of the Feasibility of High Temperature Bearing Lubrication From Carbonaceous Gases

Thierry A. Blanchet and W. Gregory Sawyer
*Rensselaer Polytechnic Institute
Troy, New York*

Prepared for
U.S. Army Aviation Systems Command
and
Lewis Research Center
under Contract NAS3-25950



National Aeronautics and
Space Administration

Office of Management
Scientific and Technical
Information Program

1996





TABLE OF CONTENTS

| SECTION | PAGE |
|------------------------------------|-------------|
| Introduction..... | 1-3 |
| Historical Review..... | 4-13 |
| Materials and Instrumentation..... | 14-20 |
| Experimental Procedure..... | 21-24 |
| Experimental Results..... | 25-41 |
| Discussion..... | 42-44 |
| Conclusions..... | 45-46 |
| Suggested Investigations..... | 46-47 |
| References..... | 48-50 |
| Addendum..... | 51 |

SYNOPSIS - Research has been conducted on silicon nitride pin-on-disk sliding contacts at temperatures of up to 520°C, and four-ball rolling contacts with silicon nitride balls and 52100 steel or silicon nitride races at 590°C. These tests were conducted in a variety of gaseous environments in order to determine the effects of simulated engine exhaust gas on the carbonaceous gas decomposition lubrication scheme. In rolling tests with steel races and exhaust gas the wear track depth was roughly half that of tests run in nitrogen gas alone. The deposition of lubricous microcrystalline graphitic carbon on the rolling surfaces, generated from the carbon monoxide within the exhaust gas mixture, was verified by microfocused Raman spectroscopy. Ten-fold reductions in rolling wear could be achieved by the exhaust gas atmosphere in cases where water vapor was removed or not present. The exhaust gas mixture alone was not found to provide any lubricating effect on silicon nitride sliding contacts, where the rate of wear greatly exceeds the rate of carbon deposition. Directed admixture of acetylene (as low as 5% of the exhaust gas flow rates), has provided reductions in both wear volume and coefficient of friction by factors of 60x and 20x respectively for sliding contacts during the initial 80m of sliding distance. Exhaust gas atmosphere with the acetylene admixture provided 650x reductions in steady state wear rate compared to that measured for sliding contacts in dry N₂. Such acetylene admixture also augments the ability of the exhaust gas atmosphere to lubricate high-temperature rolling contacts, with up to 25-fold reductions in wear track depth compared to those measured in the presence of N₂ alone. In addition to providing some lubricating benefit itself, an important potential role of the exhaust gas from rich mixtures would be to shield bearings from O₂. Such shielding enables surface deposition of lubricous pyrolytic carbon from the acetylene admixture, instead of combustion, rendering feasible the continuously replenished solid lubrication of high-temperature bearing surfaces.

DEMONSTRATION OF THE FEASIBILITY OF HIGH TEMPERATURE BEARING LUBRICATION FROM CARBONACEOUS GASES

**Thierry A. Blanchet and W. Gregory Sawyer
Department of Mechanical Engineering
Rensselaer Polytechnic Institute
Troy, NY 12180**

INTRODUCTION

Gas turbine engines require high quality rolling element bearings to run at high speeds, loads and temperatures. The Integrated High-Performance Turbine Engine Technology (IHPTET) initiative has called for a doubling of the propulsion capacity of gas turbine engines. With demands for higher efficiency and thrust-to-weight ratio, and less environmentally damaging emissions, increased combustion and operating temperatures have been sought. IHPTET goals demand bearing to operate at 540°C for phase 2, and 815°C for phase 3. Silicon nitride's combination of low density, high toughness (for ceramic materials), and good high-temperature stability makes it an excellent candidate bearing material [Bhushan 1982].

The predisposition of ceramics to fatigue, fracture and high friction and wear rate in bearings can be reduced through lubrication. The limited range of viscosity and stability of currently available liquid lubricants [Kitamura 1993] will prevent them from being useful in environments with temperatures exceeding 400°C, such as those found in high performance turbine engines. Solid lubricants, however, have been shown to provide adequate lubrication on silicon nitride ceramic surfaces over a wide range of temperatures, loads, and sliding speeds [Murray 1993]. Solid lubricants are typically employed in the form of predeposited films. One major problem with predeposited solid lubricants is the difficulty in replenishing them as they inevitably wear during operation. Replenishment

may be accomplished through the use of solid lubricant-containing composite bearing materials [DellaCorte 1991], however the friction reported for such materials typically exceeds that provided by predeposited, continuous solid lubricant films.

Lubrication through the introduction of particles between sliding surfaces has been shown to reduce coefficients of friction and provide load bearing capabilities [Yu 1994, Heshmat 1991]. This technique may be capable of high temperature operation, however there is great difficulty in the continuous supply of such particles at a feed rate sufficiently low so as to not flood the bearing compartment and reduce internal bearing clearances resulting in excessive frictional torque. Many delivery mechanisms were investigated but none proved satisfactory. Furthermore, while the agglomeration of softer MoS₂ powders posed such delivery problems, harder TiO₂ particles used for powder lubrication actually resulted in distress of the bearing surface [Walton 1994].

Beckwith [1995] reported on attempts to lubricate a silicon nitride roller bearing at high temperature, utilizing predeposited solid lubricant films and in some cases a solid lubricant-containing cage material as well. The composite solid lubricant-containing cage was found incapable of providing any lubricating benefit, while the finite predeposited solid lubricant film and its wear presented radial clearance difficulties. As the desired bearing lifetime could not be achieved by these more conventional solid lubricant techniques, Beckwith recommended that alternative low cost, high temperature vapor deposition lubrication approaches be investigated. An example of such an approach, lubrication via hydrocarbon gases directed into the contact area has been shown to be an effective technique of replenishing solid lubricious carbon deposits in the wear tracks of high temperature silicon nitride sliding and rolling contacts [Lauer and Davis 1993].

A two-stage Rich burn-Quick quench-Lean burn (RQL) technique has been developed enabling turbine engines to minimize the production of environmentally

damaging nitrogen oxides [Varrasi 1996]. An initial rich burn zone minimizes NO_x production. Additional air is introduced for the subsequent lean fuel burning stage. The engine exhaust from the initial rich burn stage is estimated to have an abundant amount of carbon monoxide (CO) and hydrogen (H_2). CO and H_2 gas mixtures have previously been found effective at forming lubricous carbon deposits on silicon nitride tribological contacts at 520°C [Blanchet 1993, 1994]. It is feasible that the CO and H_2 present in rich burn exhaust gas would deposit such carbon on high-temperature silicon nitride bearing surfaces, and that replenishment of this solid lubricant could be augmented by a hydrocarbon gas admixture.

Exhaust gases formed during the initial rich burn stage contain little unreacted O_2 and could be used to shield any such hydrocarbon gas admixture from combustion prior to lubricous pyrolytic carbon deposition on bearing surfaces. Graphitic carbon will readily combust at temperatures above 315°C in an environment containing O_2 [Finkin 1973]; for this reason it is imperative that high concentrations of O_2 are not present during high temperature operation.

HISTORICAL REVIEW

Engineering Ceramic Materials for Bearing Applications

With demands for greater efficiency and performance, turbine engines with higher maximum temperatures and higher shafts speeds have been proposed. This desire to operate gas turbines at higher speeds and temperatures has made engineering ceramics ideal candidate bearing materials. At relatively modest temperatures of 315°C (600°F) high temperature bearing steels such as AISI M50 can no longer be safely used for extended periods of time [Dalal 1975]. Operating temperatures up to as well as in excess of 800°C have been proposed for such projects as the High Performance Turbine Engine (HPTE) project [Braza 1989a].

The ceramic materials most often considered as candidates for these demanding environments include alumina (Al_2O_3), silicon carbide (SiC), silicon nitride (Si_3N_4), and partially stabilized zirconia (PSZ) [Braza 1989b]. These materials, as a group, have many advantages over common bearing steels. These ceramics have high hardnesses, high melting points, low densities, and low coefficients of thermal expansion. The major disadvantage of ceramic materials is their low fracture toughness, as compared to the bearing steels, and high manufacturing costs.

| Selected properties of AISI M50 steel and candidate ceramic bearing materials | | | | | | | |
|---|----------------------|----------------------------|------------------------------|-----------------------------|---------------------------------|--------|---|
| Material | Hardness Rc at 20 °C | Maximum Useful Temperature | Density (g/cm ³) | Modulus of elasticity (GPa) | Thermal Conductivity Cal/s m °C | | Fracture Toughness KIC (Mpa m ^{.5}) |
| | | Rc = 57 | | | 20°C | 800 °C | |
| AISI M50 Steel | 64 | 320 °C | 7.6 | 190 | 13.4 | - | 16.2 |
| alumina | 85 | 1000 °C | 3.9 | 350 | 7.2 | 1.7 | 4-5 |
| silicon carbide | 90 | 1200 °C | 3.2 | 410 | 35.0 | 12.0 | 4.0 |
| silicon nitride | 78 | 1200 °C | | | 7.3 | 4.7 | |
| •hot pressed + MgO | 17.9 | Knoop Hardness GPa | 3.3 | 270 | | | 5.4 |
| •low pressure sintering | 15.9 | | 3.2 | 310 | | | 6-7 |
| •reaction bonded | 17.0 | | 3.3 | 310 | | | 6.0 |

Table 1 Selected Properties of Candidate Bearing Materials [Braza 1989a, Bhushan 1982]

It is clear from table 1 that silicon nitride has many advantageous properties. Silicon carbide and silicon nitride both have comparable maximum useful temperatures and densities, however silicon nitride has a greater fracture toughness. This fact alone makes silicon nitride stand apart from the other major ceramics. Silicon nitride also has a lower modulus of elasticity than silicon carbide or alumina, helping to reduce contact pressures and subsurface shear stresses. In addition to having the highest fracture toughness among the ceramics, silicon nitride also has the highest tensile strength, helping to resist wear failures. This high strength is maintained over a wide range of temperatures, as can be seen in figure 1.

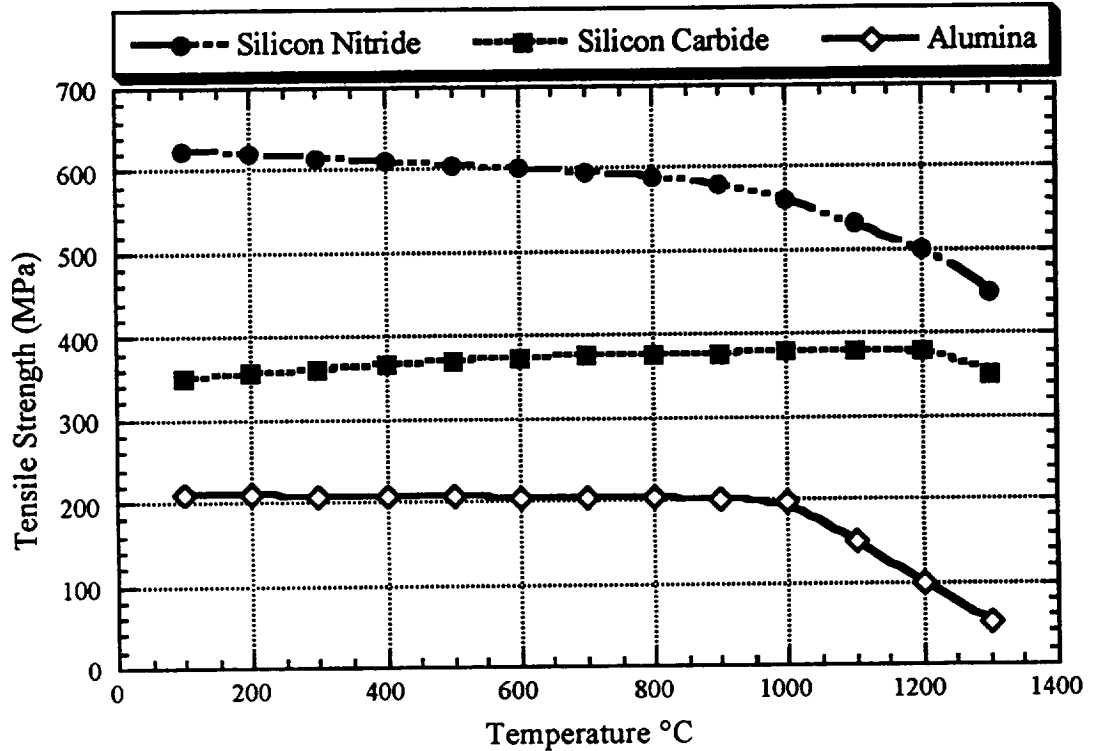

Figure 1 Tensile Strength vs. Temperature, Various Engineering Ceramics

The various ceramics discussed here possess densities which are approximately 60% less than the density of bearing steels. The lower densities of ceramics can drastically reduce the centrifugal forces in high speed rolling element bearings. Silicon nitride also has the lowest coefficient of thermal expansion among the ceramics considered (Si_3N_4 $2.9 \cdot 10^{-6} \frac{\text{m}}{\text{m}^\circ\text{C}}$, SiC $5.0 \cdot 10^{-6} \frac{\text{m}}{\text{m}^\circ\text{C}}$, Al_2O_3 $8.5 \cdot 10^{-6} \frac{\text{m}}{\text{m}^\circ\text{C}}$, AISI M50 $12.4 \cdot 10^{-6} \frac{\text{m}}{\text{m}^\circ\text{C}}$) [Bhushan 1982]. This property is desirable for homogeneous material mechanisms, however, it can be detrimental to multi-material mechanisms which experience large operating temperature ranges, and mismatches of coefficients of thermal expansions.

Friction and Wear of Silicon Nitride Ceramics

In direct contrast to most bearing steels, ceramics display only limited plasticity. This causes, not surprisingly, the failure mechanism in ceramic/ceramic tribological contacts to be one of primarily brittle fracture. The inability of ceramic materials to plastically deform rapidly, and relieve locally high stresses through this plastic deformation, causes sites of porosity, inclusions in the material, and discontinuities on the material surface to be likely sites for crack initiation.

In addition to mechanical wear mechanisms such as three-body abrasion, microfracture and grain pullout, silicon nitride experiences tribochemical reactions in the presence of water. In either argon, nitrogen, or air the wear rate of silicon nitride/silicon nitride sliding contacts is reduced 100-fold with the addition of water vapor at 98% relative humidity. This wear reduction is believed to be caused by the formation of an amorphous oxide layer. This thin layer in contrast to the bulk material appears to be softer and plastically deformable [Tomizawa 1986a]. This softer layer reduces contact stresses by distributing the load support and also causes a reduction in the coefficient of friction. Bowden and Tabor proposed the following formulation (1) for the coefficient of friction μ due to adhesive contributions.

$$\mu = \frac{k_{\text{(surface layer)}}}{H_{\text{(bulk material)}}} \quad (1)$$

Where k is the shear strength of the surface material and H is the indentation hardness of the bulk material. This formula for coefficient of friction shows that for ceramic materials, which possess high values of indentation hardness, a reduction of the surface shear stress could result in significant reductions in the coefficient of friction. Tomizawa and Fischer [1986] have shown coefficients of friction between $\mu=0.2$ and $\mu=0.3$ at

relative humidities between 40% and 98%, compared to a coefficient of friction in dry sliding of $\mu=0.80 \pm 0.05$. They have also shown that friction is independent of sliding velocity and temperature. Therefore measured coefficients of $\mu=0.2$ to $\mu=0.3$ for sliding contacts in water vapor constitute a 60% reduction in friction force over dry sliding. Above 800°C the friction coefficient increases to the levels found in dry sliding, regardless of the water vapor content.

It has also been observed that a relatively soft and continuous, plastically deformable surface film forms as the relative humidity is increased above a threshold level. It is also important to note that Auger spectroscopy and electron diffraction reveal that this amorphous layer contains both silicon and oxygen, and it is believed that this layer is a silicon oxide (SiO_2) layer. However, oxygen alone has proven ineffective in producing a surface layer capable of reducing either friction or wear of silicon nitride/silicon nitride contacts. It is well known that Si_3N_4 oxidizes in dry air only above 700 °C. However, this reaction is accelerated by the presence of water, and can be enabled at lower temperatures [Tomizawa 1986a].

The work of Tomizawa and Fisher [1986a] involved silicon nitride/silicon nitride sliding contacts at a variety of relative humidities and temperatures. The research also showed that oxygen was ineffective at producing thin SiO_2 film (2-5 nm at the sliding interface) without water vapor. The proposed low temperature oxidation mechanism is therefore believed to be one where the oxide forms out of a chemical reaction with water.

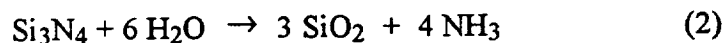

This chemical reaction has also been proposed as an explanation for the presence of NH_3 during the water-cooled grinding of silicon nitride. The creation of SiO_2 is the first step in

the tribochemical wear process. The dissolution of SiO₂ in water is believed to occur through a second chemical reaction that forms silicic acid (Si(OH)₄) [Tomizawa 1986b]. Equation (3) shows this dissolution reaction of silicon dioxide and water.



Tomizawa and Fischer propose that the rate of dissolution of SiO₂ depends on the structure of the material, and the dissolution rate is increased when the water is basic. Instead of reducing wear, it is feasible that excessive levels of water alternatively may augment rates of removal of silicon nitride through tribochemical wear.

High Temperature Vapor Phase Lubrication

The lubrication of ceramics and alloys through vapor phase delivery systems has been studied and reported on by a variety of researchers. Smith, Furey and Kajdas [1995] have successfully lubricated sliding contacts of self-mated alumina (Al₂O₃) specimens, through tribopolymerization of vinyl octadecyl ether or lauryl methacrylate. These tests were run on a modified pin-on-disk tribometer with initial maximum Hertzian contact pressures of 2.4 GPa, sliding speeds of 25 $\frac{\text{cm}}{\text{s}}$, modest background temperatures of 145°C, and sliding distances of 500m. Nitrogen gas with vaporized monomers was flowed into the contact region for 10 to 15 seconds prior to initiation of loading and sliding. At a monomer delivery temperature of 165°C vinyl octadecyl ether was found to provide a 99% reduction in pin wear volume and a coefficient of friction reduction of 38% ($\mu \approx 0.50$), compared to tests performed in a nitrogen gas environment at background temperatures of 145°C.

Graham and Klaus [1986] demonstrated the ability of tricresyl phosphate (TCP) and tributyl phosphate (TBP) vapors delivered to M50 bearing steel sliding surfaces to produce lubricous polymer films at temperatures of 370°C. Hanyaloglu, Graham, Oreskovic, and Hajj [1995] were able to lubricate sliding contacts of IN 800, IN 825, and MN 400 superalloys through a vapor delivery of triaryl phosphate ester (TAP). These tests were run on a universal reciprocating wear tester with a modest average Hertzian contact pressure of 0.66 MPa, sliding speeds of $12.7 \frac{\text{cm}}{\text{s}}$, background temperatures of 500°C, and a typical sliding distance of 450m. A predeposited film was generated on the test specimens through exposure to TAP for a 15 minute duration prior to the initiation of loading and sliding. Coefficients of friction of $\mu \approx 0.02$ and $\mu \approx 0.03$ were found for MN 400 and IN 800 respectively. In both cases wear of the base alloy was not observed.

Lubricous surface film formation by vapor phase lubrication is believed in some cases to be limited to bearing surfaces with a high content of active metal, necessary to catalyze the tribochemical reaction of precursor vapor. Furthermore, the work of Rao et al. [1995] suggests that vapor phase lubrication may in some cases induce tribochemical wear, as wear experiences a minima as a function of vapor concentration. Increased concentration beyond this optimum yields increased wear. Thus, it appears that the bearing material itself is a product in the tribochemical reaction.

To avoid these drawbacks, Lauer and colleagues at Rensselaer Polytechnic Institute have instead been developing techniques whereby carbon solid lubricants deposit on high-temperature bearing surfaces through the decomposition of carbonaceous gases provided to the bearing environment. The bearing material itself is not a reactant in the formation of such films, and thus is not prone to tribochemical wear. Lauer and Bunting [1988] were able to lubricate nickel-containing surfaces through the catalytic dissociation of solid carbon from ethylene-containing atmospheres. These ethylene-containing

atmospheres were either ethylene-argon gas mixtures, or ethylene-argon-hydrogen gas mixtures. A variety of material combinations were tested in argon atmospheres as well as ethylene-containing atmospheres. These tests were run with a 3/16-in diameter hemispherically-tipped pin on a flat counterface, $0.2 \frac{\text{cm}}{\text{s}}$ sliding speeds, 500°C background temperatures, and a small 60g normal load. Coefficients of friction between 0.04 and 0.14 were found for nickel-containing counterfaces and sapphire pins sliding at 500°C in an ethylene-hydrogen-argon gas mixture. This represents a two- to five-fold reduction in coefficient of friction over tests run in an argon atmosphere. Reductions in wear volume measurements were not reported.

Lauer and Dwyer [1991] successfully lubricated sialon and silicon carbide (SiC) sliding contacts at 500°C through the pyrolytic decomposition of ethylene. Zirconia/Alumina ($\text{ZrO}_2+\text{Al}_2\text{O}_3$) materials were, however, not able to be successfully lubricated with ethylene gas. This was believed to be due to an inactivity of the $\text{ZrO}_2+\text{Al}_2\text{O}_3$ material at temperatures up to 500°C. For the silicon carbide and the sialon materials coefficients of friction were less than $\mu=0.05$ at 500°C in the presence of ethylene gas. These tests were conducted at a variety of background temperatures between 80°C and 700°C, 290g normal load, and $5.2 \frac{\text{cm}}{\text{s}}$ sliding speed. The coefficient of friction was continually recorded for these tests. Once again, no wear volume reductions were reported.

Lauer, Vlcek, and Sargent [1993a] were able to lubricate silicon nitride sliding contacts over a 10 minute sliding duration. Initial contact pressures of 2.66 GPa, sliding speeds of $5 \frac{\text{cm}}{\text{s}}$, and a background temperature of 520°C were used for the study. Tests with ethylene flowing over a heated catalytic nichrome pre-nucleation wire upstream of the contact produced pin wear scar areas of 0.03mm^2 . The catalytic surface, however, was not necessary for carbon deposition. Tests with ethylene in the absence of a

prenucleation wire also resulted in reduced pin wear scar areas of 0.09mm^2 , compared to tests without ethylene which had pin wear scar areas of 0.57mm^2 . The ethylene flows also produced low coefficients of sliding friction.

Lauer, Blanchet, Vlcek and Sargent [1994] showed that sliding as well as rolling contacts of steel and silicon nitride could be lubricated at temperatures above 500°C through the pyrolysis of ethylene or other carbonaceous gases. Rolling four-ball contacts of silicon nitride balls and steel races were found to be capable of enduring high temperature environments, and the ethylene flow was found to be capable of providing wear reductions of the race at 590°C . The presence of plate-like lubricous carbon deposits was verified through Raman spectroscopy.

Lauer and Blanchet [1993b] were able to lubricate sliding contacts on self-mated silicon nitride through the pyrolytic decomposition of ethylene as well as acetylene gases. Mixtures of carbon monoxide and hydrogen gases were also found to be capable of forming lubricious carbon deposits on silicon nitride sliding surfaces. Blanchet, Lauer and Rhee [1993] reported on tests in which carbon monoxide and hydrogen gases were directed at the sliding interface on pin-on-disk tests, and the gas flow was initiated after an initial sliding distance of 0.5m . The tests were run on a pin-on-disk tribometer with initial maximum Hertzian contact pressures of 1.7 GPa , sliding speeds of $4.4\frac{\text{cm}}{\text{s}}$, background temperatures of 520°C , and typical sliding distances of 80m . Tests with CO/H_2 mixtures yielded reductions of wear over the 80m sliding distance of $50\times$ and coefficient of friction reductions of $10\times$ ($\mu=0.04$) compared to control tests run in an argon environment at 520°C . Steady-state sliding wear rate of silicon nitride was reduced from $155 \times 10^{-6}\text{ mm}^3/\text{Nm}$ to $0.29 \times 10^{-6}\text{ mm}^3/\text{Nm}$ upon addition of the CO/H_2 mixture to the argon atmosphere. In that study, CO/H_2 mixtures were also shown to provide large reductions in high-temperature rolling contacts, as determined through examination of

upper ball wear track depth in four-ball rolling tests conducted with silicon nitride balls at 590°C.

MATERIALS AND INSTRUMENTATION

Materials and Specimen Preparation

For pin-on-disc sliding tests, silicon nitride (Si_3N_4) balls and disks were finished to between 25 and 40 nm RMS roughness. The modulus of elasticity and Poisson's ratio for the Noralide NBD-200 silicon nitride material, as supplied by the manufacturer, were $E=310$ GPa and $\nu=0.26$ respectively. The 1/16-in radius hemispherically-tipped Noralide NBD-200 silicon nitride pins were grade 5 quality. The disks were 25 mm by 25 mm square, and were secured in a steel holder for pin-on-disk tests. Though each pin was only used for a single test, the flat disks could be polished and reused. The disks were refinished by lapping on a cast iron wheel with a 15 μm diamond polishing solution, and subsequent polishing through various degrees of diamond grits. The final polishing step was on a 0.1 μm diamond abrasive-impregnated cloth wheel. The disks were then rinsed in hot water and dried in compressed air. Prior to testing, all specimens were cleaned in a vibratory bath with anhydrous methyl alcohol.

Four-ball rolling tests were conducted using Noralide NBD-200 silicon nitride balls which were of grade 5 quality and were of 1/2-in diameter. The silicon nitride conformal races used were of similar quality (grade 5) and roughnesses as the silicon nitride balls, but were made of NC-132 silicon nitride. Conformal races made of 52100 bearing steel with identical geometry as the silicon nitride races were also tested. The modulus of elasticity and Poisson's ratio for the 52100 bearing steel material were $E=290$ GPa and $\nu=0.30$ respectively. Prior to testing, all specimens were cleaned in a vibratory ultrasonic bath with anhydrous methyl alcohol for approximately 5 minutes.

Pin-on-Disk Tribometer

The pin-on-disk tribometer (figure 2) was the same as that used by Lauer et al. [1993] in previous studies. The tribometer is made from stainless steel, steel, and aluminum. It is composed of an inner and outer chamber, and is capable of testing at up to 520°C in a variety of gaseous environments.

The inner chamber contains the rotating silicon nitride disk, and the stationary 1/16-in radius hemispherically-tipped silicon nitride pin. The inner chamber has a gas diffuser line that is used to provide a background atmosphere, and a stainless steel lubricant line that is used to direct carbonaceous gases towards the pin/disk contact. The inner chamber houses an electrically resistive heater rod that is bent into a circle. The test specimens are positioned in the center of this circular heating coil. The inner chamber is also equipped with two type K thermocouple probes, located on the circular heating element and on the silicon nitride counterface. These thermocouples are used to maintain a constant disk surface temperature during operation by providing feedback to the temperature controllers located outside of the tribometer housing, and to assure that the resistive element does not overheat.

The silicon nitride disk and disk holder rotate below the stationary silicon nitride pin. The angular velocity of the disk holder is controlled by an A.C. inductive motor controller. The motor is capable of angular velocities from 70 RPM to 1400 RPM. The linear sliding velocity (V) that is reported from pin-on-disk testing is a function of the angular velocity (ω) of the disk holder, and the radial position (R) of the pin from the axis of rotation for the disk ($V = \omega R$).

The pin is attached to one end of a strain arm whose other end is pivoted outside of the tribometer, with pivot rotation limiting the strain arm to a vertical plane. The strain arm runs from its pivoted end through the outer chamber and penetrates into the inner

chamber, where the pin/disk contact is located. It is instrumented with four strain gauges at the pivoted end. The strain gauges measure arm deflection along the velocity vector, and the strain gauge bridge is fully compensated for temperature variations in the strain arm. Normal loading is accomplished by suspending dead weights from the strain arm.

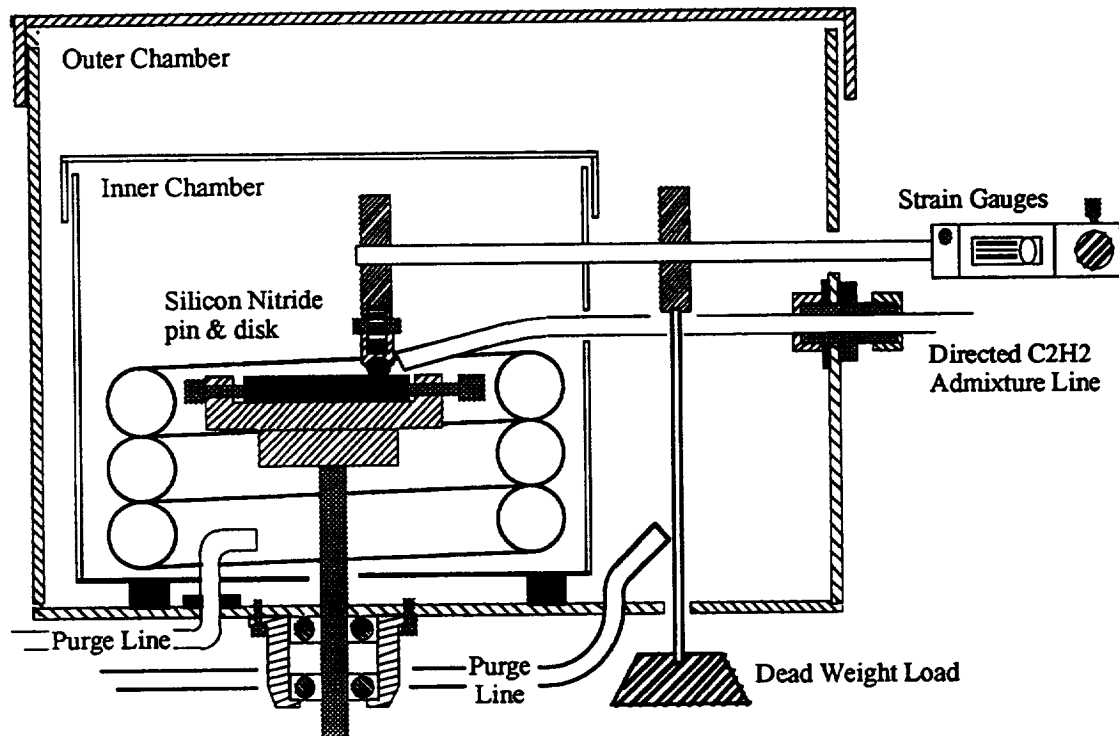

Figure 2 Schematic of Pin-on-Disk Tribometer

Wear volume calculations are made post-test using optical microscopy to measure dimensions of the circular wear scar formed on the stationary silicon nitride pin. The outer chamber is continually purged with $6 \frac{\text{liters}}{\text{min}}$ of N_2 gas during heat up and cool down, and $12 \frac{\text{liters}}{\text{min}}$ of N_2 gas during the sliding test.

High Temperature Rolling Four-Ball Tribometer

A rolling four-ball tribometer capable of spindle speeds of 10,800 rpm was kindly donated to Rensselaer Polytechnic Institute by the Allison Engine Company. This tribometer had to be modified and instrumented at Rensselaer to enable test temperatures of up to 590°C, to control test atmospheres, and to direct hydrocarbon gas admixtures towards the contact region. This tribometer is shown in detail in figure 3. The four-ball tribometer is comprised of a cylindrical inner and outer chamber. A slight baffle separates the inner chamber from the outer chamber. The inner chamber sits directly above a heating block containing 3 electrically resistive cartridge heaters, which are capable of delivering 1600W power under maximum electrical loading conditions. The conduction of heat out of the heating block is responsible for raising the inner chamber temperature to 590°C. The temperature of the inner chamber is measured on the underside surface of the stationary race, through a type K thermocouple probe. This thermocouple probe acts as feedback for the temperature controller. The lower spindle bearing temperature is also monitored through a type K thermocouple probe mounted on the outer race of the bearing on the side closest to the inner chamber.

The four-ball rolling apparatus rotates the upper ball at an angular velocity of 10,800 RPM. The lower three rolling balls sit in a conformal race, and are driven through the contact forces that the upper rotating ball transmits to them. The drive spindle assembly is located directly above the inner chamber and contains two precision rolling element thrust bearings and one precision radial positioning rolling element bearing used for alignment. Because of the location of the driving spindle, and the high angular velocities of the spindle, a laboratory water chiller connected to copper cooling lines is used to help remove heat from the spindle assembly.

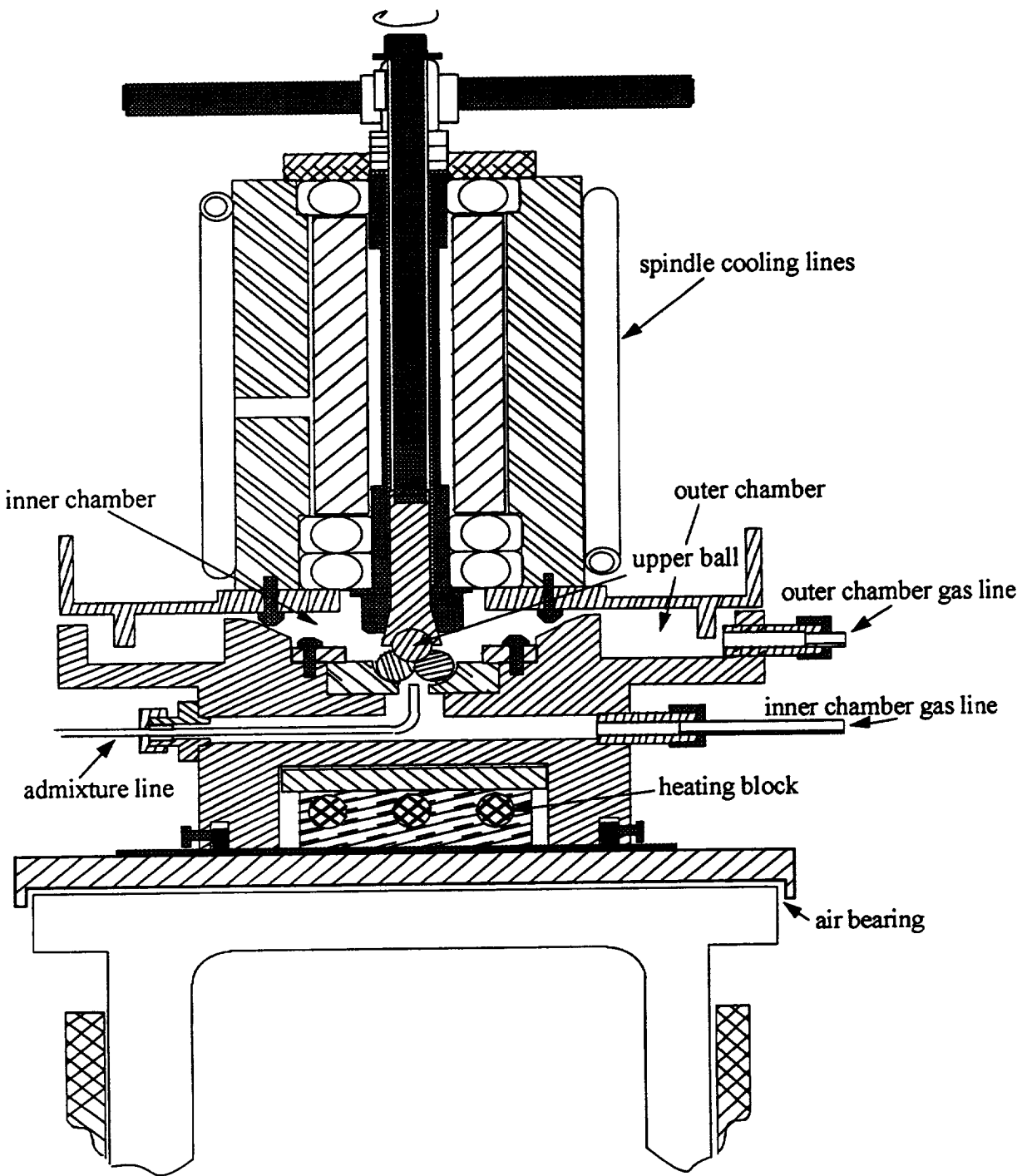

Figure 3 High-Temperature Rolling Four-Ball Tribometer

The lower balls and race are contained in the inner chamber and are loaded against the upper ball through a pneumatic cylinder and air bearing. The air bearing provides a low coefficient of friction mounting, which will permit the inner chamber assembly to align itself along the axis of rotation of the upper ball. Prior to testing the lower heating block and testing chamber are secured to two torque arms which prevent rotation of the lower assembly during testing. Wear is measured post-test by stylus profilometry, allowing quantification of the cross-section of the circular wear track formed on the upper ball.

Computer Data Acquisition System

The computer data acquisition system is comprised of a 486/8 MRAM Gateway computer, with an NIDAC card, and Labview™ software. The card has eight channel single ended inputs with 16 bit resolution, approximately 1mV per bit. The system is currently used only on the pin-on-disk tribometer to monitor the coefficient of friction.

The computer data acquisition system converts the analog voltage signal to a digital value at a rate of 1000 Hertz. The computer system converts these values to corresponding coefficient of friction, then averages these values over a discrete time step to report an average value of coefficient of friction and the standard deviation of that value at a given sliding distance. The computer data acquisition system continually displays the coefficient of friction history and the averaged values. All of the averaged values and their standard deviation are then written to a tab-delineated text file. This format can be easily imported into a variety of spreadsheet programs, on a variety of computer operating systems.

Microfocused Raman Spectroscopy

Microfocused Raman spectroscopy was used to identify the presence of microcrystalline graphitic carbon deposits on the post-test tribological surfaces of silicon nitride. Raman spectroscopy is based on a wavenumber shift of radiation scattered from a surface subjected to a focused argon laser beam. The spectra are plotted as intensity (count rate) against wavenumber (cm^{-1}) relative to that of the incident radiation. Raman spectra distinctive peaks of intensity versus relative wavenumber plots. For carbon-carbon bonding the particular relative wavenumbers of interest are roughly 1350 RCM^{-1} and 1580 RCM^{-1} , corresponding to sp^3 (D or disorder) bonding and sp^2 (G or graphitic) bonding respectively.

EXPERIMENTAL PROCEDURE

Gaseous Environments

Pin-on-disk sliding tests and high temperature rolling four-ball tests were conducted in a variety of gaseous environments. These gaseous environments are inner chamber test conditions at 520°C for the pin-on-disk tribometer or 590°C for the rolling four-ball tribometer. The outer chambers of these tribometers were purged with N₂ during testing.

The simulated rich-burn exhaust was procured in a pressurized cylinder with all major gas species present, except the water vapor. Though gas turbine engines normally operate with a great deal of free oxygen (~16% typically) in the exhaust, and less than 100ppm carbon monoxide, NASA has advocated a new two-stage rich-lean combustion for low emissions, as previously discussed for RQL. Combustion of the rich mixture is estimated to produce exhaust gas with approximate molar composition of 62.7% N₂, 13.4% CO, 12.5% H₂O, 6.7% H₂, and 4.7% CO₂. During both sliding and rolling tests the 'dry' components of the exhaust gas were supplied 'dry' at a flowrate of $3.0 \frac{\text{liters}}{\text{min}}$, and various percentages of water were added on top of this flowrate as desired.

Water was added to this gas mixture by flowing the 'dry' exhaust gas through a gas diffuser stone submerged in a beaker of heated water. The mole fraction of water added to the system, and the average flowrate of the water vapor over a period of time, was calculated from the measured volume of water lost from the beaker per unit time. Prior to the initiation of testing, nitrogen gas was bubbled through the beaker for approximately 40 minutes in an effort to reduce the amount of dissolved gases present in the water at room temperature. Tests with varying mole fractions of water vapor were obtained by controlling the temperature of the water within the heated beaker.

Baseline tests for high-temperature silicon nitride sliding and rolling contacts were run in nitrogen. The nitrogen gas environment is inert, and the $3.0 \frac{\text{liters}}{\text{min}}$ flowrate is adequate to provide a slight positive pressure in the inner chamber capable of maintaining a non-reactive environment, without oxygen, for baseline testing. Water vapor, if desired, is added to the nitrogen environment through the heated beaker of water and gas diffuser stone. Some tests involving the addition of water vapor to the nitrogen gas were used to isolate the effects of water vapor as a variable for rolling and sliding tribological testing. For example in exhaust gas environments, this water likely has an effect that differs from that of the carbonaceous constituents. The nitrogen gas is supplied in a pressurized cylinder as a gas, and is guaranteed dry to 25 ppm water vapor.

In addition to the exhaust gas, some tests involved small additions of acetylene, to either represent unburnt hydrocarbons, or to represent admixtures that could supplement the lubricating effect of exhaust gas. An in-line flowmeter regulates the addition of the acetylene through the admixture line located in the inner chamber of the pin-on-disk and rolling four-ball tribometer, directed towards the contact (see figures 2 and 3). Admixture flowrate, for both the pin-on-disk tests and the high temperature rolling four ball tests, was $0.15 \frac{\text{liters}}{\text{min}}$ unless noted otherwise.

Pin-on-Disk Sliding Tests

The pin-on-disk tribometer inner chamber gas environments are controlled and varied through pressure regulators and in-line flow meters. The disk temperature is set to 520°C and maintained for the duration of the test. The sliding distances are 80m, and the sliding velocity is $0.044 \frac{\text{m}}{\text{s}}$. This corresponds to a testing time of 30 minutes. To maintain the $0.044 \frac{\text{m}}{\text{s}}$ sliding speed the angular rotation and wear track diameter are held constant at 70 RPM and 1.2 cm respectively.

The reported pin wear volume is measured and calculated after the completion of the test using optical microscopy to quantify the wear scar diameter (D) formed on the R =1/16-in radius of curvature hemispherical pin . The area of the wear scar $A=\pi D^2/4$ is determined, and used in the determination of the volume (V) of material lost, given by equation (4).

$$V = \pi \left(\frac{2}{3} R^3 - R^2 \cdot \sqrt{R^2 - \frac{A}{\pi}} + \frac{1}{3} \left(R^2 - \frac{A}{\pi} \right)^{3/2} \right) \quad (4)$$

The steady-state pin wear rates were found by conducting long duration sliding tests of 475m at the previously described conditions for a variety of inner chamber gaseous environments. These tests were interrupted periodically for measurement of pin wear volume as a function of sliding distance. The wear rate (units: mm³/Nm) is the volume of material lost per unit sliding distance under steady-state conditions (linear increase in wear volume with sliding distance), divided by the normal load.

For most pin-on-disk sliding tests, a ball/disk contact force of $F_n=2.26$ N was used. The maximum Hertzian contact pressure (p_{max}) of the two spherical bodies can be calculated from a series of simple equations. In these equations E' is a composite modulus, R' is an effective radius of curvature, F_n is the contact force, and the subscripts 1&2 represent the two contacting bodies (both silicon nitride in these tests).

$$\frac{1}{R'} = 2 \left(\frac{1}{R_1} + \frac{1}{R_2} \right) \quad (5)$$

$$\frac{2}{E'} = \frac{(1-\nu_1^2)}{E_1} + \frac{(1-\nu_2^2)}{E_2} \quad (6)$$

$$p_{max} = \frac{1}{\pi} \sqrt[3]{\frac{3F_n E'^2}{8R'^2}} \quad (7)$$

For the pin-on-disk tests the initial maximum Hertzian contact pressure is 1.7 GPa, and the average Hertzian contact pressure is 1.1 GPa. This initial Hertzian contact pressure

will rapidly decrease as wear will dictate a circular flat spot on the contacting surface of the hemispherically-tipped pin. The average contact pressure P_{ave} over the flat contact spot on a worn surface can be easily estimated as the quotient of the normal load F_N and the area of the wear scar A .

High-Temperature Rolling Four-Ball Tests

The high-temperature rolling tests are all conducted at constant temperature, load, and speed. The inner chamber temperature is 590°C, and is measured on the bottom surface of the stationary race. The angular velocity of the upper ball is maintained at 10,800RPM. The contact force between the upper ball and each of the lower three balls is 20.6N, and the initial maximum Hertzian contact pressure, given by equation (7), is 2.2 GPa. Both the inner chamber gas species and the race materials are varied for this test program.

The circular wear track on the upper ball of each of the tests was measured using a stylus profilometer. All traces are 1.27 mm in length to facilitate comparisons of the wear track damage between different test conditions, and samples. The profilometer trace was then used to measure the maximum depth of the wear track, the width of the wear track, and any buildup or accumulation of deposits or debris outside of the wear track. The reported value of the measurements for a given test specimen is the arithmetic mean of all of the profilometric traces taken. Two traces were taken of each test ball, and occasionally three if there was a large discrepancy between the first two traces.

EXPERIMENTAL RESULTS

Pin-on-Disk Sliding Contact Tests

For self-mated silicon nitride sliding contacts under a nitrogen gas atmosphere at a temperature of 520°C, in the absence of any lubricating gas flow, friction force measurements indicated a friction coefficient of $\mu \approx 0.7$. This is consistent with previously reported coefficients of friction for self-mated silicon nitride in dry sliding [Tomizawa 1986a]. During tests in a nitrogen gas atmosphere for 80 m sliding distance, under a load of 2.2N (initial maximum Hertzian contact pressure of 1.7 GPa) and speed of $4.4 \frac{\text{cm}}{\text{s}}$, wear scar measurements indicated an average pin volume loss of $2.3 \times 10^{-2} \text{ mm}^3$. Optical microscopy revealed a wide wear track on the disk surface that was bordered by small piles of a fine white debris.

Tests with an inner chamber gas composition of the previously described exhaust gas mixture delivered at a flowrate of $3 \frac{\text{liters}}{\text{min}}$ without water vapor, with $0.43 \frac{\text{liters}}{\text{min}}$ of water vapor, and with $1.05 \frac{\text{liters}}{\text{min}}$ of water vapor all had high coefficients of friction $\mu \approx 0.7$ and high wear volumes $3.3 \times 10^{-2} \text{ mm}^3$, $4.3 \times 10^{-2} \text{ mm}^3$, and $6.7 \times 10^{-2} \text{ mm}^3$ respectively. These tests also showed large wear tracks and fine white debris piled outside of the wear track. Although not quantified, it did appear that the amount of fine white debris was larger for tests involving water vapor. This would not be an entirely surprising result considering the wear volume increased monotonically with increasing water vapor concentration.

Tests with the exhaust gas mixture with water vapor and a directed acetylene admixture delivered at $0.15 \frac{\text{liters}}{\text{min}}$ had low coefficients of friction $\mu \approx 0.03$. The coefficient of friction remained high for the first couple of disk rotations, and then gradually decreased over the first 6 minutes to a value between $\mu \approx 0.02$ and $\mu \approx 0.04$. Once

established, the coefficient of friction remained low unless the flow of acetylene was interrupted. If the acetylene flow was shut off, the coefficient of friction would rapidly transition back to a high value of $\mu \approx 0.70$, indicative of unlubricated high temperature sliding contacts of silicon nitride.

The tests with a directed admixture of acetylene also had low pin wear volumes, on average they were $4.9 \times 10^{-4} \text{ mm}^3$. Tests with the directed acetylene admixture have shown a reduction in coefficient of friction of over 20x and a reduction in wear volume of 87x over test runs in the simulated exhaust gas environment without acetylene admixture. The friction and wear behavior of these 80m sliding tests are summarized in figures 4 and 5 respectively.

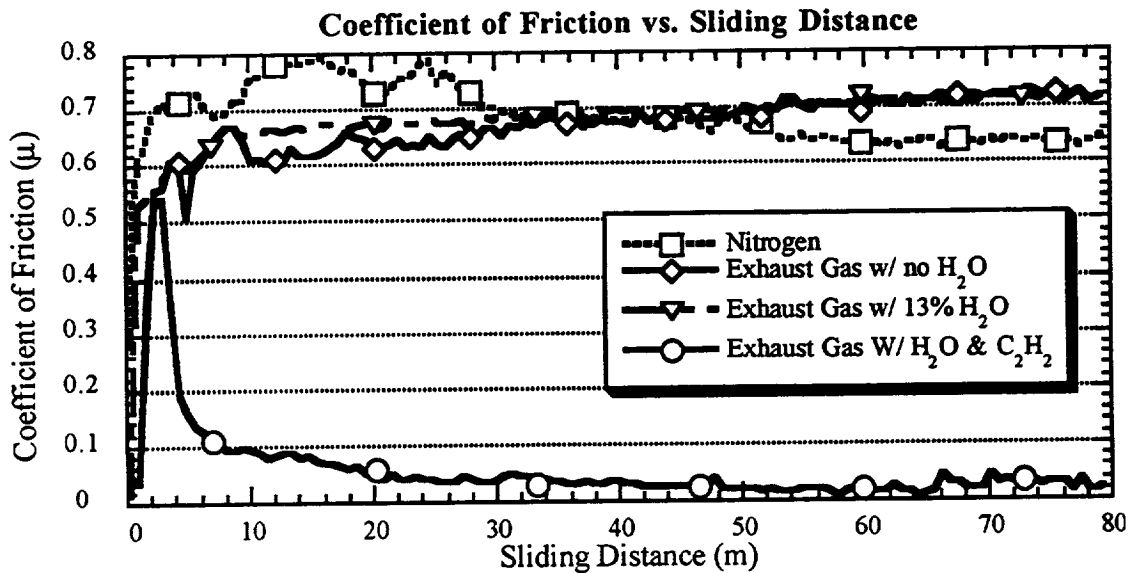

Figure 4 Coefficient of Friction vs. Sliding Distance

Coefficient of friction measurements for silicon nitride on silicon nitride pin-on-disk tests conducted at $4.4 \frac{\text{cm}}{\text{s}}$ sliding speeds, 80m sliding distances, 2.2N normal loads, and 520°C background temperatures in a variety of gas atmospheres.

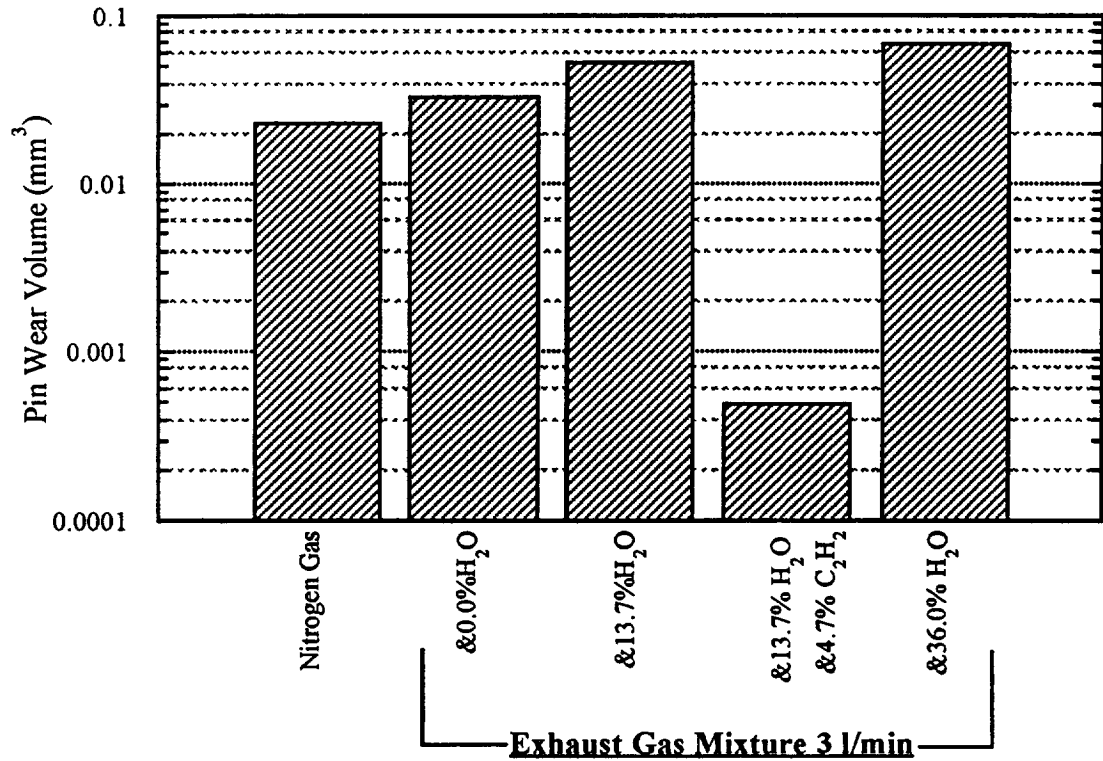

Figure 5 Sliding Wear Volumes (pin) as a Function of Inner Chamber Environment

Pin wear volume measurements for silicon nitride on silicon nitride pin-on-disk tests conducted at $4.4 \frac{\text{cm}}{\text{s}}$ sliding speeds, 80m sliding distances, 2.2N normal loads, and 520°C background temperatures in a variety of gas atmospheres.

Optical microscopy inspection of the circular wear track formed on the silicon nitride counterface for tests involving acetylene admixture showed no fine white granular debris. This debris was previously observed on all tests without the acetylene admixture. The wear track was also thinner in cross section due to a smaller pin wear scar diameter.

Tests with acetylene admixture showed dark non-continuous deposits of carbon across the disk surface and wear track.

Stylus profilometry of the circular wear tracks formed on the silicon nitride disk counterface reveals a dramatic difference between the wear track cross-sectional shapes for the tests run with acetylene admixture and the tests run without acetylene admixture. Figure 6 shows the profilometry trace of two wear tracks superimposed onto one plot.

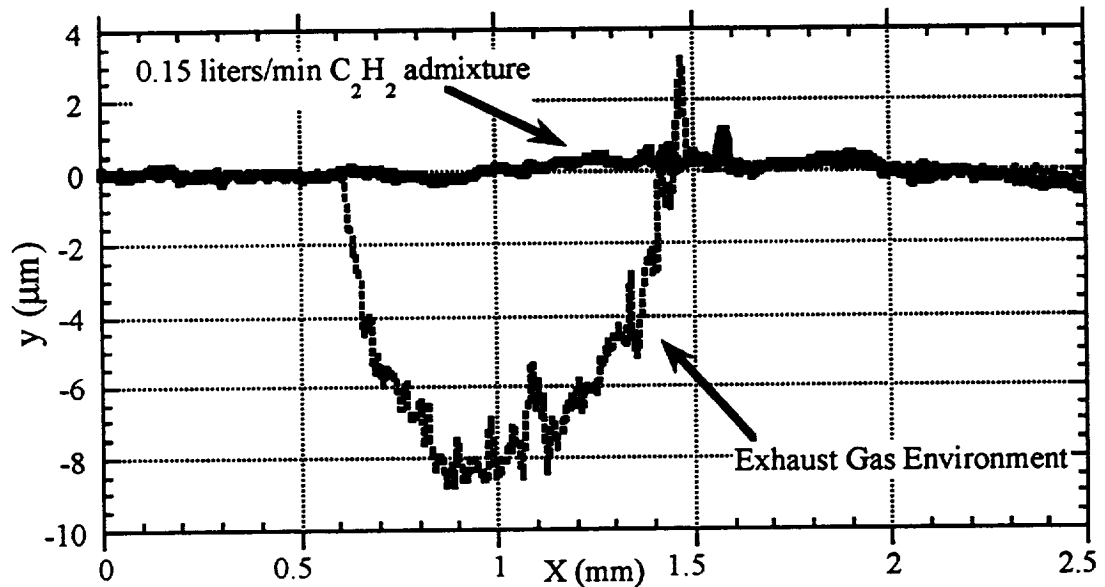

Figure 6 Stylus Profilometry of Sliding Wear Tracks

Stylus profilometry of silicon nitride counterface from silicon nitride on silicon nitride pin-on-disk tests conducted at $4.4 \frac{\text{cm}}{\text{s}}$ sliding speeds, 80m sliding distances, 2.2N normal loads, and 520°C background temperatures with an exhaust gas environment and a $0.15 \frac{\text{liters}}{\text{min}}$ acetylene admixture, or an exhaust gas environment with no acetylene admixture.

The wear track formed during sliding operation in a simulated exhaust gas environment is easily identifiable from the stylus profilometry plot. On the contrary the track from the test run in the simulated exhaust gas environment with acetylene admixture is barely detectable, as a result of minimal wear.

Steady-State Sliding Wear Rate Tests

Steady-state wear rates of tribological contacts are determined from the slope of the linear region on wear volume vs. sliding distance plot. This method of finding a steady-state wear rate ignores wear occurring during the initial transient run-in period, a sizable contributor to the total wear volumes previously reported during the limited duration 80m sliding tests. Tests run in a simulated exhaust gas environment and sliding distances of 475m had steady-state wear rates of $4.5 \times 10^{-4} \frac{\text{mm}^3}{\text{N m}}$. Tests run in a nitrogen gas environment showed slightly lower, but still unacceptably high, wear rates of $3.0 \times 10^{-4} \frac{\text{mm}^3}{\text{N m}}$. Tests run under identical conditions with simulated exhaust gas inner chamber environments and a directed $0.15 \frac{\text{liters}}{\text{min}}$ C_2H_2 admixture for 475 m sliding distances had greatly reduced steady-state wear rates of $4.5 \times 10^{-7} \frac{\text{mm}^3}{\text{N m}}$. This represents a reduction in steady-state wear rate, imparted by the acetylene admixture, of 1000-fold compared to that measured in exhaust gas alone, or 650-fold compared to that measured in nitrogen alone. Figure 7 shows the volume of material removed as a function of sliding distance, on a semi-log plot so that the low-wear behavior in environments containing acetylene admixture may be compared on the same graph to the high-wear behavior in its absence.

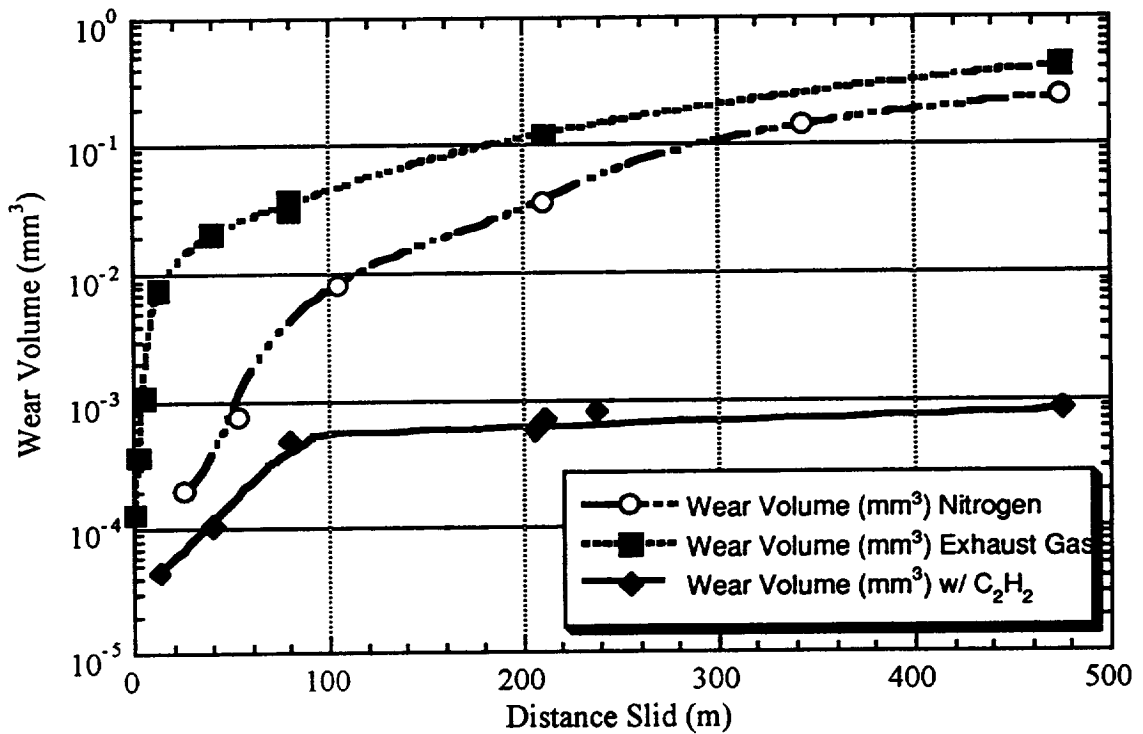

Figure 7 Wear Volume as a Function of Sliding Distance

Pin wear volumes from silicon nitride on silicon nitride pin-on-disk test conducted at $4.4 \frac{\text{cm}}{\text{s}}$ sliding speeds, 2.2N normal loads, and 520°C background temperatures in various gas environments (Nitrogen, Exhaust Gas, and Exhaust Gas with $0.15 \frac{\text{liters}}{\text{min}}$ acetylene admixture).

In these sliding tests contact between the flat disc and the hemispherically-tipped pin is initially concentrated, with average contact pressures greater than 1×10^6 Pa. However as wear generates a flat, conforming circular wear scar on the pin surface, average contact pressure drops markedly. The pin wear scar diameter data, collected over extended sliding distances, enables average contact pressure reductions due to increased wear scar area to be plotted as a function of sliding distance under constant normal load in figure 8.

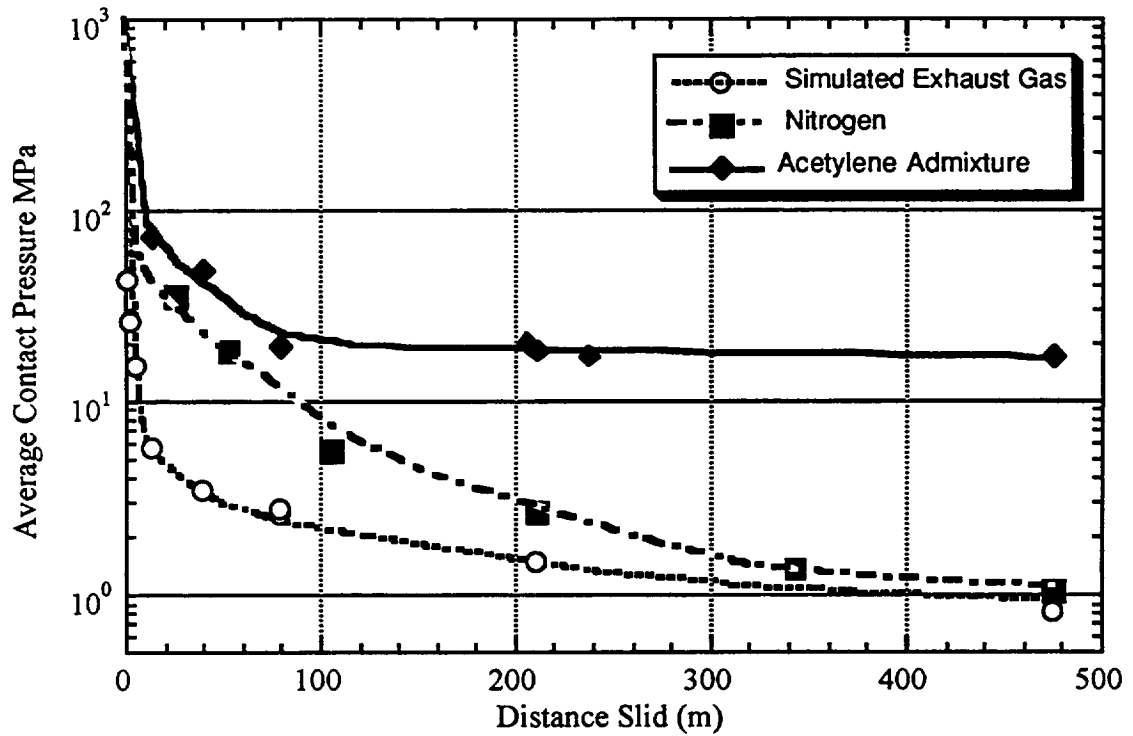

Figure 8 Average Contact Pressure as a Function of Sliding Distance

Contact pressures calculated from pin wear scar areas from silicon nitride on silicon nitride pin-on-disk test conducted at $4.4 \frac{\text{cm}}{\text{s}}$ sliding speeds, 2.2N normal loads, and 520°C background temperatures in various gas environments (Nitrogen, Exhaust Gas, and Exhaust Gas with $0.15 \frac{\text{liters}}{\text{min}}$ acetylene admixture).

It can be seen that the average contact pressure decreases rapidly from the initial value of 1.1 GPa. Once a wear scar is formed, the average contact pressure is at least 10x higher for test with acetylene admixture when compared to tests in either the nitrogen or the exhaust gas mixture.

Measurement of Lubrication Capacity

Lubrication by carbonaceous gas decomposition depends upon a favorable balance of the rate of solid carbon deposition on the contacting surfaces from the gas relative to

the rate of carbon removal from the surfaces due to slip and wear in the contact zone [Blanchet 1994]. Increased flow of precursor feed gases will increase the rate of carbon deposition, as is also expected of increased temperature as deposition reactions are controlled by combined thermal activation and mass transport. On the other hand, the primary result expected of increased normal load or slip speed would be an increase in the rate of carbon removal through wear. If adequate excursions are made in gas flow, temperature, and/or normal load during a test, transitions between adequate and inadequate lubrication regimes would be anticipated. The transition from an adequate lubrication regime to an inadequate lubrication regime in sliding contacts of silicon nitride would be denoted by an increase in friction coefficient, which is measured continuously and could be used instantaneously during a sliding test to denote transition. When inadequate amounts of carbon are present on the silicon nitride surfaces during sliding pin-on-disk tests, the data acquisition system will reveal increases in the coefficient of friction, eventually returning to the $\mu=0.7$ value previously described for unlubricated high-temperature sliding of silicon nitride. These transition points are recorded at various loads, flowrates, and temperatures.

Initially tests were conducted at constant background temperatures of 520°C and sliding speeds of $0.044 \frac{\text{m}}{\text{s}}$. The tests were conducted in an inner chamber environment with the previously described exhaust gas mixture. The tests were started without the acetylene admixture. A steady and high coefficient of friction ($\mu \approx 0.7$) was established during the first 10m of sliding distance. Once stable, the acetylene precursor feed gas admixture was initiated. Flowrates of the admixture gas were increased until the coefficient of friction began to drop. When the coefficient of friction stabilized at a low value ($\mu \approx 0.03$) the acetylene admixture flowrate was decreased until the coefficient of friction began to rise, eventually returning to the high coefficient of friction previously

described. This method of toggling across the boundary between adequate and inadequate lubrication regimes enabled a quick determination of the transition acetylene admixture flowrate at that combination of load and temperature. Figure 9 shows a plot of transition acetylene admixture flowrates versus load at a constant background temperature of 520°C.

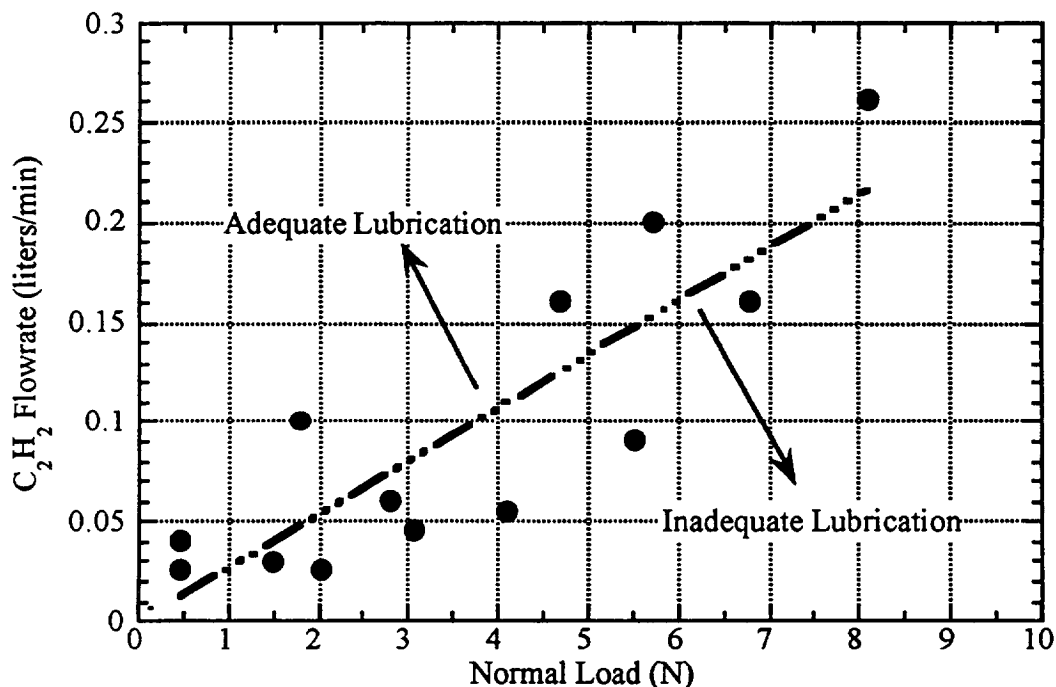

Figure 9 Load/Flow rate Transition Combinations at 520°C

Transition data points of flowrate and normal load combinations for silicon nitride on silicon nitride pin-on-disk tests at 520°C background temperatures and 0.44 $\frac{\text{cm}}{\text{s}}$ sliding speeds.

Information in the plot in figure 9 of flow rate and load combinations at a constant background temperature of 520°C was duplicated for a variety of background temperatures between 360°C and 520°C. At each of these temperatures, transition points fell along a straight line with zero-intercept on the flow rate vs. load space, as

previously shown in figure 9. However, the slope of this transition line or boundary increased with decreasing temperature. This is an expected result, as the deposition reaction is thermally activated, and the probability that an acetylene molecule decomposes and deposits carbon decreases with temperature reduction. At reduced temperature, a greater flow rate would therefore be necessary to maintain the deposition rate necessary to balance removal.

A previous study using CO and H₂ gas mixtures [Blanchet 1994] showed that the carbon lubricant deposition rate could be described by an Arrhenius temperature dependence as well as being proportional to the flow rate of carbonaceous feed gas. The rate of removal of carbon deposits from the surfaces of sliding contacts due to wear is once again considered to be proportional to the product of normal load and sliding velocity, as suggested by the Archard wear relation. The proposed model for the rate of accumulation of carbon on the surface $\frac{\partial C}{\partial t}$ is therefore as given by equation (8).

$$\frac{\partial C}{\partial t} = A_1 f \exp(-E_a/\mathcal{R}T) - B_1 V F_n \quad (8)$$

In this equation f represents the acetylene gas flowrate (mol/s), T is temperature (°K), \mathcal{R} is the universal gas constant, E_a is the Arrhenius activation energy for the deposition term, V is the sliding velocity (m/s), and F_n is the normal load (N). The constants A_1 and B_1 are coefficients for the deposition and removal terms respectively, and are specific to the tribosystem geometry under study.

At the transition from adequate lubrication to inadequate lubrication the rate of carbon deposition should equal the rate of carbon removal, and therefore $\frac{\partial C}{\partial t}$ should be zero. Equation (8) can then be simplified into the equivalent equations of (9) or (10).

$$\exp(-E_a/\mathcal{R}T) = \frac{B_1}{A_1} \frac{V F_n}{f} \quad (9)$$

$$-E_a \left(\frac{1}{\mathcal{R}T} \right) = \ln \left(\frac{B_1}{A_1} \right) + \ln \left(\frac{VF_n}{f} \right) \quad (10)$$

Equation (10) is then rearranged into a more recognizable slope-intercept form (11).

$$\ln \left(\frac{VF_n}{f} \right) = -E_a \cdot \frac{1}{\mathcal{R}T} - \ln \left(\frac{B_1}{A_1} \right) \quad (11)$$

It is suggested from equation (11) that the transition combinations of background temperatures, loads, and flow rates should fall along a straight line on a plot of the quantity $\ln\left(\frac{VF_n}{f}\right)$ versus $\frac{1}{\mathcal{R}T}$. The slope of the least squares regression fit for these data points is used to determine the activation energy E_a for the Arrhenius temperature dependence. Figure 10 displays a linear region for the data between $\frac{1}{\mathcal{R}T}$ values of 1.5×10^{-4} and $2.0 \times 10^{-4} \frac{\text{mol}}{\text{J}}$ (or temperatures from 520°C to 360°C), supporting the assumed model based upon balanced deposition and removal rates. The least squares regression of this region yields an activation energy based on ambient temperature of $E_a = 42 \frac{\text{KJ}}{\text{mol}}$.

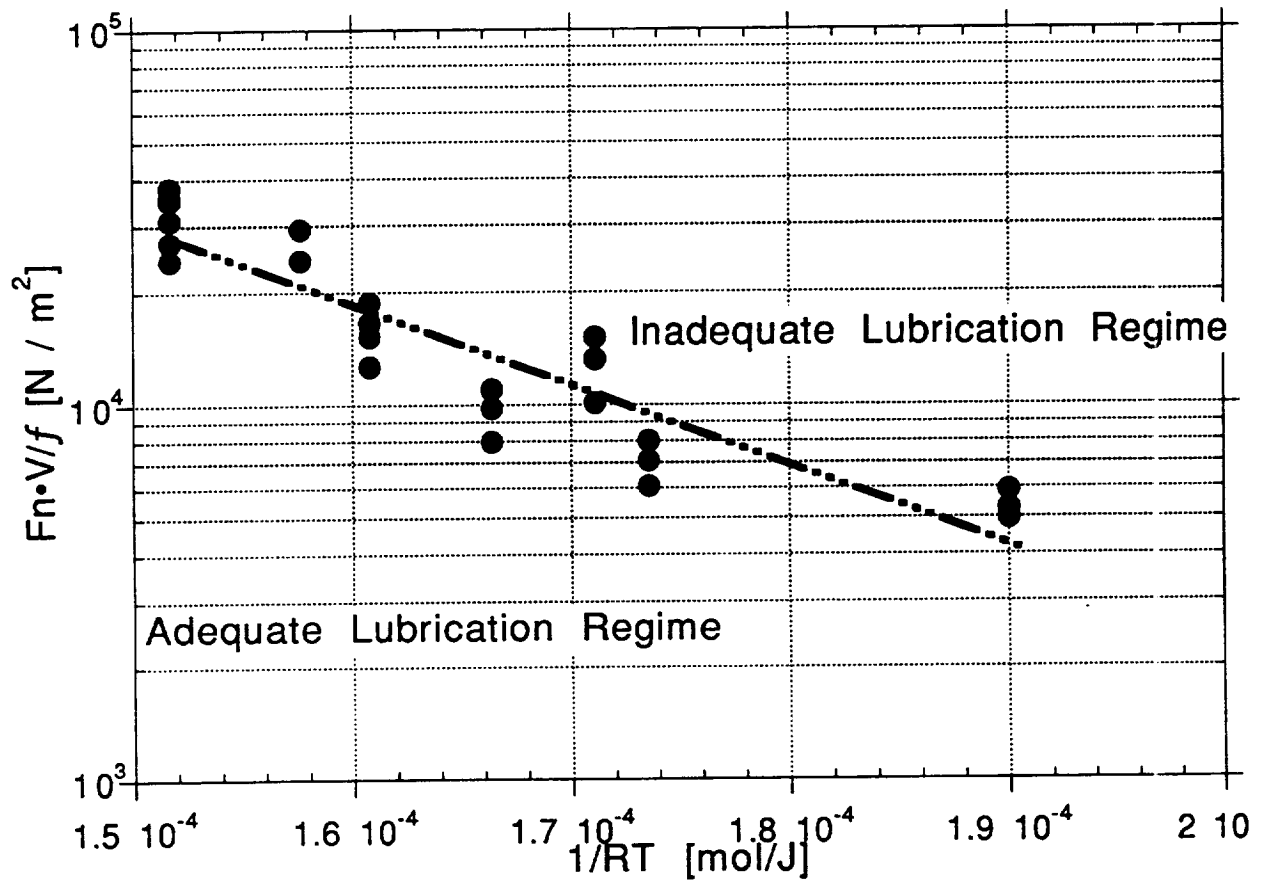

Figure 10 Load/Flow Rate/Temperature Combinations Representing Transitions in Lubrication Regime

Transition data points of flow rate and normal load combinations for silicon nitride on silicon nitride pin-on-disk tests at various background temperatures and constant $0.44 \frac{cm}{s}$ sliding speed.

Rolling Four-Ball Tests with Silicon Nitride Races

Tests run in a variety of inner chamber gas environments with silicon nitride balls and stationary silicon nitride races experiencing 20.6 N ball/ball contact forces and upper ball velocities of 10,800 RPM were each run for five minute durations. Inner chamber gas flows were initiated at the onset of rolling. Upper ball wear track depths were measured

using stylus profilometry and are reported here as an indication of the success or failure of a particular gas environment to lubricate silicon nitride rolling contacts. For tests run in a nitrogen environment average wear track depths were 3.90 μm . Tests run in the previously described exhaust gas without water vapor had average wear track depths of 1.87 μm . Tests run in a simulated exhaust gas environment with water vapor had an average wear track depth of 5.64 μm . Tests run in a simulated exhaust gas environment with water vapor and a directed acetylene admixture of 0.15 $\frac{\text{liters}}{\text{min}}$ had an average wear track depth of 0.53 μm . The acetylene admixture provided more than a 10x reduction in wear track depth over tests run in a simulated exhaust gas mixture with water vapor. These high-temperature rolling wear data are summarized in figure 11.

Rolling Four-Ball Tests with 52100 Steel Races

Tests run in a variety of inner chamber gas environments with silicon nitride balls and stationary 52100 steel races experiencing 20.6 N ball/ball contact forces and upper ball velocities of 10,800 RPM were run for five minutes. For tests run in a nitrogen environment at 3.0 $\frac{\text{liters}}{\text{min}}$ without H₂O, with 12.5% H₂O, and with 56% H₂O, average wear track depths were 3.75 μm , 3.07 μm , and 0.57 μm respectively. Tests run in the previously described exhaust gas without water vapor, with 12.5% H₂O, and with 56% H₂O had average wear track depths of 0.37 μm , 1.96 μm , and 0.67 μm respectively. Tests run in a simulated exhaust gas environment with no water vapor and 5% acetylene admixture (0.15 $\frac{\text{liters}}{\text{min}}$), and tests with 12.5% water vapor and 5% acetylene admixture had average wear track depths of 0.24 μm and 0.15 μm respectively. The acetylene admixture to exhaust gas with H₂O provided a 25x reduction in wear track depth compared to tests run in a nitrogen environment. These high-temperature rolling wear results, involving steel races, are also summarized in figure 11. Example profilometry

traces of upper ball wear tracks for various inner chamber environments are shown in figure 12.

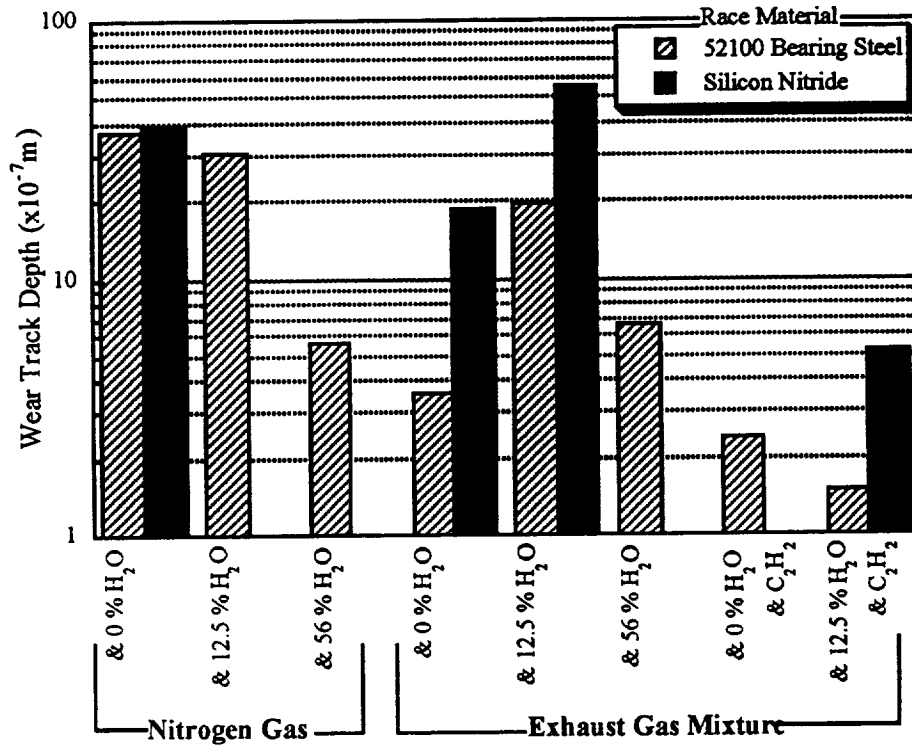

Figure 11 High-temperature Rolling Wear Track Depth

Upper ball wear track depths from four-ball tests conducted with silicon nitride 0.5" diameter balls at 10,800 RPM, 20.6 N ball/ball contact loads, 5 minutes operating time, and 590°C background temperatures in various gas environments and either steel or silicon nitride race materials.

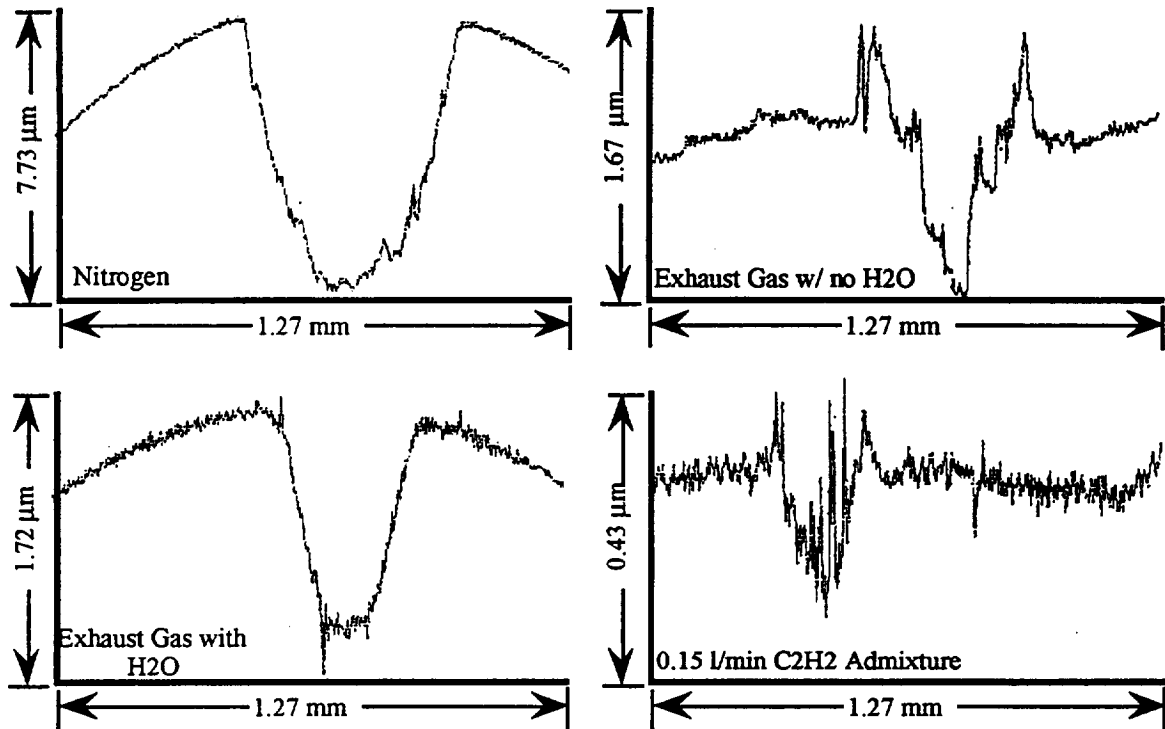

Figure 12 Cross-section of Upper Ball Rolling Wear Tracks

Profilometry traces of upper ball wear track depths from four-ball tests conducted with silicon nitride $\frac{1}{2}$ " diameter balls at 10,800 RPM, 20.6 N ball/ball contact loads, 5 minutes operating time, and 590°C background temperatures in various gas environments on 52100 bearing steel races.

Raman Spectroscopy

Lubricous carbon deposits displaying characteristic disorder (sp^3 bonding) and graphitic (sp^2 bonding) peaks centered at relative wavenumbers of approximately 1350 and 1580 Rcm^{-1} in the Raman spectra are shown in figure 13. It is clear that carbon deposition is greatly aided by acetylene admixture, as the resultant Raman spectra most clearly displays the characteristic carbon peaks. However, the presence of carbon deposits in the absence of acetylene admixture (spectra B and C of figure 13) suggest that the exhaust gas mixtures themselves are capable of forming such carbon. It is postulated

that the carbon monoxide and the hydrogen gas present in the exhaust gas mixture are reacting to form these carbon deposits, as previously demonstrated by Blanchet [1993, 1994] and Lauer [1993b]. Equation (12) shows a possible reaction yielding solid carbon as a product.

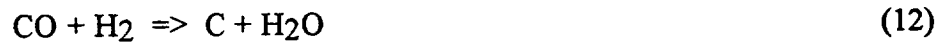

In addition to the possible formation of solid carbon from the reaction of carbon monoxide and hydrogen gas, water vapor is also a product species. Of course no deposits were observed for inner chamber environments of nitrogen alone.

Figure 13 Raman Spectra of Upper Ball Wear Tracks formed in Various Test Environments (figures on following page)

Raman spectroscopy from upper ball wear tracks of four-ball tests conducted with silicon nitride $\frac{1}{2}$ " diameter balls at 10,800 RPM, 20.6 N ball/ball contact loads, 5 minutes operating time, stationary silicon nitride races, and 590°C background temperatures in [A] nitrogen alone, [B] exhaust gas without H₂O, [C] exhaust gas with H₂O [D] exhaust gas with H₂O and 0.15 $\frac{\text{liters}}{\text{min}}$ of acetylene admixture. The scale of the Y-axis (intensity) is common for all four spectra.

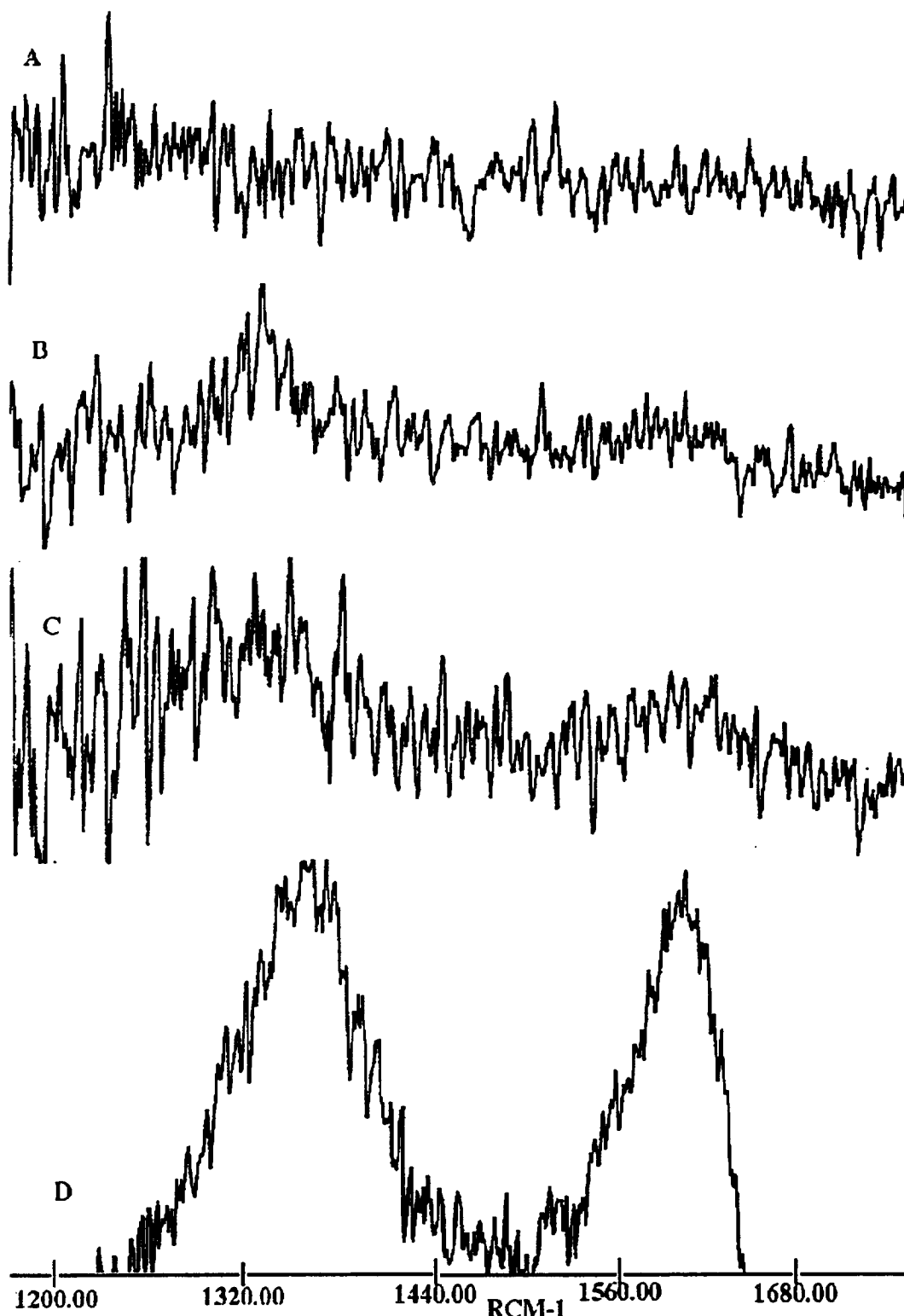

Figure 13 Raman Spectra of Rolling Wear Tracks (Details on preceding page)

DISCUSSION

The concept of high-temperature solid lubrication of Si_3N_4 rolling and sliding surfaces in an engine exhaust environment by carbon deposits which are continuously replenished from a directed flow of C_2H_2 has been validated. The in situ deposition of the lubricous carbon from C_2H_2 admixture does not require the presence of catalytic metals to provide adequate high-temperature lubrication to ceramics. The exhaust gas mixture alone, without C_2H_2 admixture, was able to provide some reduction of wear in rolling contacts at 590°C , but was not successful at providing lubrication in sliding contacts. Lubrication of high-temperature $\text{Si}_3\text{N}_4/\text{Si}_3\text{N}_4$ rolling contacts by exhaust gas alone was aided by the removal of water vapor, and by the use of a steel race (hybrid bearing) which may have provided some catalytic enhancement.

In $\text{Si}_3\text{N}_4/\text{Si}_3\text{N}_4$ rolling contacts the carbon deposited from the exhaust gas itself, without additional C_2H_2 admixture, provides some lubricating benefit. Lubricating carbon deposits, displaying characteristic disorder (D) and graphitic (G) peaks in the Raman spectra, were noted within the wear tracks of upper Si_3N_4 balls in the rolling four-ball tests employing exhaust gas (with or without the water vapor) without C_2H_2 admixture. These carbon deposits are believed to derive from the considerable CO and H_2 constituents which exist within this rich-burn exhaust. Such carbon deposition is expected to also yield water vapor as a reaction product [Blanchet 1993, 1994]. Of course, the amount of carbon detected on the rolling surfaces is greatly enhanced by addition of a C_2H_2 admixture. It is believed that the ability of exhaust gas alone to provide a measurable lubricating effect only in the rolling contacts results from the very limited amount of slip (microslip only) occurring in such contacts. Microslip reduces the rate of carbon removal, thus enabling a favorable balance of lubricant deposition relative to removal in accordance with equation 8. A catalytic effect from the use of a steel race may

additionally augment the deposition term, further enhancing lubrication in the exhaust atmosphere. In spite of many efforts to produce a similarly favorable balance on the pin-on-disk tribometer (by decreasing normal load and sliding speed, and increasing temperature and exhaust gas flow rate), it was not possible to produce a measurable lubricating effect in the sliding contact from the simulated exhaust gas alone. Actual rich-burn turbine engine exhaust, however, will also contain unburnt hydrocarbons which may enhance carbon deposition from exhaust.

The effects of water vapor on wear in the pin-on-disk sliding tests and the four-ball rolling tests are quite different. In the case of sliding at 4.4cm/s in an atmosphere consisting solely of exhaust gas, pin wear increases with increasing concentration of water vapor (figure 11). It is expected that hydrated silicon oxide or silicate surface films will form more rapidly with increasing water concentration at the test temperature. Since Si_3N_4 is a reactant in the production of these films which are inevitably removed as debris, and since in sliding contacts wear is relatively rapid and film formation is the limiting step in the film production/removal process, sliding wear is expected to increase with increasing water concentration. Tomizawa and Fischer [1986a] have shown that the destruction of such surface films due to high loads and speeds exceeding some threshold combination will result in high sliding friction.

In the case of rolling contacts, only microslip takes place in the contact. Thus film removal may be slow relative to formation, becoming the limiting step. For tests run in N_2 atmosphere, surface layers from tribochemical reactions between Si_3N_4 and water may provide reduction in contact stress and friction, and subsequently reduce rolling wear. Results from tests run in N_2 atmosphere, indicating monotonic increases in rolling wear track depth with decreasing concentration of water, may be explained by such a hypothesis.

In the presence of exhaust gas, rolling wear track depths at water concentrations of 56% and 12.5% are very similar to those measured in atmospheres of N₂ with 56% and 12.5% water. As water concentration is further reduced to zero, however, rolling wear in the exhaust environment diminishes due to the carbon deposition. The similarity between the tests at water concentrations of 12.5% and 56% suggests that the wear mechanism here is one of tribochemical reaction with H₂O, and not one of carbon deposition. The presence of water may inhibit the formation of lubricous carbon, as H₂O is also a product of the deposition reaction involving exhaust CO and H₂ as reactants.

CONCLUSIONS

(1) C₂H₂ admixture to a simulated exhaust gas environment is capable of lubricating Si₃N₄/Si₃N₄ concentrated sliding contacts at 520°C. Friction reductions as large as 20-fold, with resultant friction coefficients as low as $\mu < 0.05$, were achieved. Steady state wear rate was found to be 4.5×10^{-7} mm³/Nm for <5% directed C₂H₂ admixture to a simulated exhaust gas environment. This is a reduction in steady state wear rate of over 1000-fold from that measured in exhaust gas without hydrocarbon admixture, or 650-fold from that measured in N₂ alone.

(2) Continuous admixture flow provided adequate lubrication at 520°C for extended sliding distances (~475m) for self-mated Si₃N₄ contacts, without predeposition or the use of any catalytic metals.

(3) The directed admixture of C₂H₂ provided roughly ten-fold reductions in the depth of wear tracks formed in Si₃N₄/Si₃N₄ concentrated rolling contacts at 590°C, compared to those measured in exhaust gas alone.

(4) Exhaust gas alone was able to provide some wear reduction in Si₃N₄/Si₃N₄ rolling contacts when compared to wear occurring in the presence of N₂ alone. Exhaust gas however did not alone provide adequate lubricating benefit in sliding contacts.

(5) Raman spectroscopy confirms the deposition of lubricous carbon from C₂H₂ admixtures, as well as from the exhaust gas itself.

(6) A model based on the relative rates of deposition and removal of carbon solid lubricant on sliding surfaces provides good agreement with experimental results. This model predicts lubrication to be enhanced by higher background temperatures and lighter contact forces, as well as higher concentrations of carbonaceous precursor gases.

(7) In addition to aiding the deposition of lubricous carbon deposits itself, exhaust gas from combustion of rich fuel mixtures serves as a protective carrier within

which admixed hydrocarbon gases such as acetylene may be delivered to bearing surfaces. As such exhaust gas contains negligibly little O₂, it prevents burning of the hydrocarbon admixture prior to pyrolytic carbon deposition at the bearing surface.

SUGGESTED INVESTIGATIONS

In this study, instrumentation capabilities limited test temperatures to 520°C or less on the pin-on-disk sliding contact tribometer and to 590°C or less on the four-ball rolling contact tribometer. Actual bearing temperatures in high performance turbine engines may extend to 815°C [Lauer and Davis 1993] or higher.

At first glance it would appear that such increased temperature would aid the carbonaceous gas decomposition technique for solid lubricant deposition and replenishment, according to the Arrhenius temperature dependence that has been demonstrated. However, this assumes that the rate of carbon deposition remains limited by the combined effect of mass transport and kinetics. It has been suggested that as temperature is increased, eventually the formation of carbon from some hydrocarbon precursors such as ethylene becomes thermodynamically limited, with deposition rate dropping to zero, as the free energy change of the pyrolytic reaction becomes increasingly positive (endothermic). Such high temperature limitations of the carbonaceous gas decomposition solid lubrication technique are not yet known.

The Advanced Solid Lubrication Laboratory at Rensselaer Polytechnic Institute has recently acquired a Wedeven Associates WAM-1 tribometer capable of either pure sliding, pure rolling, or combined rolling/sliding contact to temperatures of 870°C. Investigations on WAM-1 could increase the range of temperatures over which the feasibility carbonaceous gas decomposition solid lubrication technique has been

investigated by 350°C in sliding contacts and 280°C in rolling contacts beyond those reported here. Additionally, combined roll/slide gear contacts could be investigated. Furthermore, the combined roll/slide capability decouples the deposition and entrainment of solid lubricant on the surfaces from the slip and accompanying removal that the lubricant experiences within the contact. This enables greater flexibility in investigating and modeling the capabilities and limitations of the lubrication technique, and better gauging its capacity relative to lubrication demands in applications of interest.

LITERATURE CITED

- L. Beckwith, 1995, "Solid Lube Ceramic Bearing". *Wright Laboratory Technical Report 95-2015*.
- B. Bhushan and L.B. Sibley, 1982, "Silicon Nitride Rolling Bearings for Extreme Operating Conditions." *ASLE Transactions*, vol. 25, pp.417-428.
- T.A. Blanchet, J.L. Lauer, and S.J. Rhee, 1993, "High Temperature Lubrication by Solid Reaction Products Generated from Carbon Monoxide and Hydrogen." *Contact Problems and Surface Interactions in Manufacturing and Tribological Systems*. ASME PED-Vol.67/TRIB-Vol.4, p.269.
- T.A. Blanchet, J.L. Lauer, Y.F. Liew, S.J. Rhee and W.G. Sawyer, 1994, "Solid Lubrication by Decomposition of Carbon Monoxide and Other Gases." *Surface and Coatings Technology*. vol. 68/69, p.446.
- J. F. Braza, H. S. Cheng and M. E. Fine, 1989a, "Silicon nitride wear mechanisms: Rolling and sliding contact", *Tribology Transactions*, vol.32, pp.439-446.
- J. F. Braza, H. S. Cheng, M. E. Fine, A. K. Gangopadhyay, L. M. Keer and R. E. Worden, 1989b, "Mechanical failure mechanisms in ceramic sliding and rolling contacts", *Tribology Transactions*, vol.32, pp.1-8.
- H. M. Dalal, Y. P. Chiu and E. Rabinowitz, 1975, "Evaluation of hot-pressed silicon nitride as a rolling bearing material", *ASLE Transactions*, vol.18, pp.211-219.
- C. DellaCorte and H.E. Sliney, 1991, "Tribological Properties of PM212 - A High-temperature, Self-lubricating, Powder Metallurgy Composite." *Lubrication Engineering*, vol.47, pp. 298-303.
- E.F. Finkin, S.J. Calabrese and M.B. Peterson, 1973, "Evaluation of Materials for Sliding at 600° - 1800°F in Air." *Lubrication Engineering*, vol.29, pp.97-204.
- T. E. Fischer and H. Tomizawa, 1985, "Interaction of tribochemistry and microfracture in the effect of friction and wear of silicon nitride", *Wear*, vol.105, pp. 29-45.
- E.E. Graham and E.E. Klaus, 1986, "Lubrication from the Vapor Phase at High Temperature." *ASLE Transactions*, vol.29, pp.229-234.
- H. Heshmat, 1991, "The Rheology and Hydrodynamics of Dry Powder Lubrication." *Tribology Transactions*. vol.34, pp.433-439.

B.F. Hanyaloglu, E.E. Graham, T. Oreskovic and C.G. Hajj, 1995, "Vapor Phase Lubrication of High Temperature Alloys." *Lubrication Engineering*, vol.51, p.503.

K. Kitamura, Y. Imada and K. Nakajima, 1993, "Effect of Soot Introduced Between Sliding Ceramic Surfaces." *Lubrication Engineering*, vol.49, pp.185-190.

J.L. Lauer and B.G. Bunting, 1988, "High Temperature Lubrication by Catalytically Generated Carbon." *Tribology Transactions*, vol.31, p.338.

J.L. Lauer and S.R. Dwyer, 1991, "Tribochemical Lubrication of Ceramics by Carbonaceous Vapors." *Tribology Transactions*, vol.34, pp.521-528.

J.L. Lauer, T.B. Blanchet, B.L. Vlcek and B.L. Sargent, 1993, "Lubrication of Si₃N₄ and Steel Rolling and Sliding Contacts by Deposits of Pyrolyzed Carbonaceous Gases." *Surface and Coatings Technology*, vol.62, p.399.

J.L. Lauer and T.A. Blanchet, 1993, "Lubrication by Components of Engine Exhaust-A New Concept of Solid Lubrication." *SAE Transactions Journal of Commercial Vehicles*, vol.102, pp.431-436.

J.L. Lauer, B.L. Vlcek and B.L. Sargent, 1993, "Wear Reduction by Pyrolytic Carbon on Tribosurfaces." *Wear*, vol.162/164, pp.498-507.

J.L. Lauer and L.C. Davis, 1993, "Wear Reduction in Ceramic Bearings by Surface Generated Pyrolytic Carbon Continuously Replenished by Ethylene Gas." *NASA CR 189214*.

S.F. Murray and S.J. Calabrese, 1993, "Effect of Solid Lubricants on Low Speed Sliding Behavior of Silicon Nitride at Temperatures to 800°C." *Lubrication Engineering*, vol.49, pp.955-964.

A. Rao, N. Forster and E.E. Graham, 1995, "Application of Cyclophosphazene for Vapor Phase Lubrication." *STLE Annual Meeting, Chicago IL*.

J.C. Smith, M.J. Furey and C. Kajdas, 1995, "An Exploratory Study of Vapor-Phase Lubrication of Ceramics by Monomers." *Wear*, vol.181/183, pp.581-593.

H. Tomizawa and T. E. Fischer, 1986a, "Friction and wear of silicon nitride at 150°C to 800°C", *ASLE Transactions*, vol.29, pp. 481-488.

H. Tomizawa and T. E. Fischer, 1986b, "Friction and wear of silicon nitride and silicon carbide in water: hydrodynamic lubrication at low sliding speed obtained by tribochemical wear", *ASLE Transactions*, vol.30, p.41-46.

J. Varrasi, 1996, "After the Concorde." *Lubrication Engineering*. vol. 52, p.488.

J.F. Walton and R. Gilbert, 1994, "Solid-lubricated Roller Bearing Development: Ceramic Roller Bearing Design and Experimental Evaluation." *Wright Laboratory Technical Report 94-2027*.

C.M. Yu, K.C. Craig and J.A. Tichy, 1994, "Granular Collision Lubrication." *Journal of Rheology*, vol.38, pp.921-936.

Addendum

The Allison Engine company is pleased with the work completed for this contract by Rensselaer Polytechnic Institute (RPI). The work fulfilled the contract objective of evaluating exhaust gas products as a potential gaseous lubricant. Future work in this area should build upon the success of this contract and past work between Allison and RPI.

This method of high temperature lubrication must overcome some barriers before it can be considered for practical gas turbine applications. The single most troublesome consideration is the need for an inert (antioxidizing) environment. This environment is needed to prevent the reactive hydrocarbon gasses from either burning or exploding but it is also believed that free oxygen would hinder the carbon deposition reaction at the tribological surfaces. Inert sump designs have been developed and tested but they require a complicated sealing scheme and a source of inert gas¹. The added complexity and weight of this ancillary hardware negates the benefits of using the simple gaseous lubrication system. Therefore future work should focus on modifying the gaseous lubrications concept so that an inert environment is not needed or focus on improved inert sump designs. Neither of these future options are simple or straightforward.

¹ Johnson, R. L., Loomis, W. R., Ludwig, L. P., "Performance and Analysis of Seals for Inerted Lubrication Systems of Turbine Engines", Aug. 1968, NASA Technical Note, TN D-4761.

REPORT DOCUMENTATION PAGE

Form Approved
OMB No. 0704-0188

Public reporting burden for this collection of information is estimated to average 1 hour per response, including the time for reviewing instructions, searching existing data sources, gathering and maintaining the data needed, and completing and reviewing the collection of information. Send comments regarding this burden estimate or any other aspect of this collection of information, including suggestions for reducing this burden, to Washington Headquarters Services, Directorate for Information Operations and Reports, 1215 Jefferson Davis Highway, Suite 1204, Arlington, VA 22202-4302, and to the Office of Management and Budget, Paperwork Reduction Project (0704-0188), Washington, DC 20503.

| | | | |
|---|--|--|----------------------------|
| 1. AGENCY USE ONLY (Leave blank) | 2. REPORT DATE December 1996 | 3. REPORT TYPE AND DATES COVERED Final Contractor Report | |
| 4. TITLE AND SUBTITLE Demonstration of the Feasibility of High Temperature Bearing Lubrication From Carbonaceous Gases | | 5. FUNDING NUMBERS WU-581-30-13 1L161102AH45 C-NAS3-25950 | |
| 6. AUTHOR(S) Thierry A. Blanchet and W. Gregory Sawyer | | 8. PERFORMING ORGANIZATION REPORT NUMBER E-10581 | |
| 7. PERFORMING ORGANIZATION NAME(S) AND ADDRESS(ES) Rensselaer Polytechnic Institute Department of Mechanical Engineering Troy, New York 12180 | | 10. SPONSORING/MONITORING AGENCY REPORT NUMBER NASA CR-4760 ARL-TR-1265 | |
| 9. SPONSORING/MONITORING AGENCY NAME(S) AND ADDRESS(ES) Vehicle Propulsion Directorate U.S. Army Research Laboratory Cleveland, Ohio 44135-3191 and NASA Lewis Research Center Cleveland, Ohio 44135-3191 | | 11. SUPPLEMENTARY NOTES Project Manager, Harold H. Coe, Structures and Acoustics Division, NASA Lewis Research Center, organization code 5950, (216) 433-3971. Work funded by NASA Contract NAS3-25950 with Allison Engine Company, P.O. Box 420, Indianapolis, Indiana 46206-0420 and subcontracted to Rensselaer Polytechnic Institute. | |
| 12a. DISTRIBUTION/AVAILABILITY STATEMENT Unclassified - Unlimited Subject Category 37 This publication is available from the NASA Center for AeroSpace Information, (301) 621-0390. | | 12b. DISTRIBUTION CODE | |
| 13. ABSTRACT (Maximum 200 words) Research has been conducted on silicon nitride pin-on-disk sliding contacts at temperatures of up to 520°C, and four-ball rolling contacts with silicon nitride balls and 52100 steel or silicon nitride races at 590°C. These tests were conducted in a variety of gaseous environments in order to determine the effects of simulated engine exhaust gas on the carbonaceous gas decomposition lubrication scheme. In rolling tests with steel races and exhaust gas the wear track depth was roughly half that of tests run in nitrogen gas alone. The deposition of lubricous microcrystalline graphitic carbon on the rolling surfaces, generated from the carbon monoxide within the exhaust gas mixture, was verified by microfocused Raman spectroscopy. Ten-fold reductions in rolling wear could be achieved by the exhaust gas atmosphere in cases where water vapor was removed or not present. The exhaust gas mixture alone was not found to provide any lubricating effect on silicon nitride sliding contacts, where the rate of wear greatly exceeds the rate of carbon deposition. Directed admixture of acetylene (as low as 5% of the exhaust gas flow rates), has provided reductions in both wear volume and coefficient of friction by factors of 60X and 20X respectively for sliding contacts during the initial 80m of sliding distance. Exhaust gas atmosphere with the acetylene admixture provided 650X reductions in steady state wear rate compared to that measured for sliding contacts in dry N ₂ . Such acetylene admixture also augments the ability of the exhaust gas atmosphere to lubricate high-temperature rolling contacts, with up to 25-fold reductions in wear track depth compared to those measured in the presence of N ₂ alone. In addition to providing some lubricating benefit itself, an important potential role of the exhaust gas from rich mixtures would be to shield bearing from O ₂ . Such shielding enables surface deposition of lubricous pyrolytic carbon from the acetylene admixture, instead of combustion, rendering feasible the continuously replenished solid lubrication of high-temperature bearing surfaces. | | | |
| 14. SUBJECT TERMS Ceramics; Bearings; Lubrication; High temperature; Carbon | | 15. NUMBER OF PAGES 56 | |
| | | 16. PRICE CODE A04 | |
| 17. SECURITY CLASSIFICATION OF REPORT Unclassified | 18. SECURITY CLASSIFICATION OF THIS PAGE Unclassified | 19. SECURITY CLASSIFICATION OF ABSTRACT | 20. LIMITATION OF ABSTRACT |