

NASA TN D-403

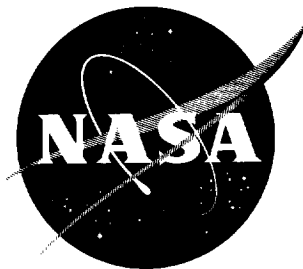

*11-02*  
*393712*

# TECHNICAL NOTE

## D-403

LOW-SPEED AERODYNAMIC CHARACTERISTICS OF A MODEL OF A  
HYPERSONIC RESEARCH AIRPLANE AT ANGLES OF ATTACK  
UP TO 90° FOR A RANGE OF REYNOLDS NUMBERS

By James S. Bowman, Jr., and William D. Grantham

Langley Research Center  
Langley Field, Va.

NATIONAL AERONAUTICS AND SPACE ADMINISTRATION  
WASHINGTON

September 1960

10

11

12

C

NATIONAL AERONAUTICS AND SPACE ADMINISTRATION

---

TECHNICAL NOTE D-403

---

LOW-SPEED AERODYNAMIC CHARACTERISTICS OF A MODEL OF A  
HYPERSONIC RESEARCH AIRPLANE AT ANGLES OF ATTACK  
UP TO 90° FOR A RANGE OF REYNOLDS NUMBERS

By James S. Bowman, Jr., and William D. Grantham

L  
9  
0  
E

SUMMARY

Static force tests have been made at low subsonic speeds for a model of a hypersonic research airplane in the Langley high-speed 7-by 10-foot tunnel to determine the aerodynamic forces and moments up to an angle of attack of 90° for a range of Reynolds numbers. The Reynolds numbers, based on the mean aerodynamic chord, ranged from 740,000 to 1,900,000, which correspond to dynamic pressures from 15 to 100 lb/sq ft (Mach numbers from 0.10 to 0.27). The model was tested in the clean configuration with various horizontal-tail settings, horizontal tail off, lower rudder off, fuselage alone, and with various size strakes and slats on the nose of the model. Representative results of the present investigation are presented in plotted form, and a tabulation of all the data obtained is presented in a table. Appreciable effects on side force, yawing moment, and pitching moment are indicated by changes in Reynolds number for angles of attack of 40° to 90°.

INTRODUCTION

In recent years, there has been increasing interest in large-angle motions of airplanes at high attitude angles. The analyses of dynamic-model tests related to these motions are becoming very difficult without the aid of force-test data at high attitude angles. Also, such data are essential for analytical studies of large-angle motions. The present investigation was undertaken to measure the forces and moments on a model of a modern research airplane. The tests were made at subsonic speeds and were conducted in the Langley high-speed 7-by 10-foot tunnel for angles of attack from 0° to 90° and for sideslip angles from 10° to -30°. The Reynolds numbers covered in the investigation ranged from 740,000 to 1,900,000, based on the mean aerodynamic chord, or 335,000 to 865,000, based on the maximum depth of the fuselage, which correspond to dynamic pressures of 15 to 100 lb/sq ft (Mach numbers from 0.10 to 0.27). Since the majority of the data discussed is for

high angles of attack and since the larger effects of Reynolds number are obtained at these angles of attack, the Reynolds numbers referred to are generally based on the maximum depth of the fuselage.

Spin and recovery characteristics of many airplane designs have been evaluated reliably based on tests of small dynamic models in the spin tunnel. However, due to configuration changes leading to long nose lengths on airplanes, special cognizance must be taken of possible significant effects of Reynolds number. The magnitude of the side force on the fuselage portion forward of the wing-fuselage intersection (hereinafter referred to as the nose) may have large variations with Reynolds number depending on the cross section of the nose with a resulting variation in yawing moment and a corresponding damping or propelling influence in the spin (refs. 1 to 3). Although the tests were made primarily to assist in the evaluation of the spin and recovery characteristics of the present configuration, the results are considered to be of general interest.

L  
9  
0  
5

#### SYMBOLS

The aerodynamic coefficients of this investigation are referenced to the body system of axes shown in figure 1. The moment coefficients are given about a moment center corresponding to 20 percent of the wing mean aerodynamic chord.

$C_N$  normal-force coefficient,  $\frac{-F_Z}{qS}$

$C_A$  axial-force coefficient,  $\frac{-F_X}{qS}$

$C_m$  pitching-moment coefficient,  $\frac{M_Y}{qS\bar{c}}$

$C_l$  rolling-moment coefficient,  $\frac{M_X}{qSb}$

$C_n$  yawing-moment coefficient,  $\frac{M_Z}{qSb}$

$C_Y$  lateral-force coefficient,  $\frac{F_Y}{qS}$

$$C_{Y\beta} = \frac{\partial C_Y}{\partial \beta}$$

$$C_{n\beta} = \frac{\partial C_n}{\partial \beta}$$

$M_X$	rolling moment acting about X body axis, ft-lb
$M_Y$	pitching moment acting about Y body axis, ft-lb
$M_Z$	yawing moment acting about Z body axis, ft-lb
$F_X$	longitudinal force acting along X body axis, lb
$F_Y$	lateral force acting along Y body axis, lb
$F_Z$	normal force acting along Z body axis, lb
$b$	wing span, ft
$\bar{c}$	wing mean aerodynamic chord, ft
$q$	dynamic pressure, $\frac{\rho V^2}{2}$ , lb/sq ft
$M$	Mach number
$S$	wing area, sq ft
$V$	free-stream velocity, ft/sec
$\rho$	air density, slugs/cu ft
$l$	maximum depth of fuselage at wing-fuselage intersection, ft
$\nu$	kinematic viscosity, sq ft/sec
$\alpha$	angle of attack of fuselage center line, deg
$\beta$	angle of sideslip, deg
$\alpha_1$	turntable angle, deg
$\phi$	roll angle, deg
$L/D$	ratio of lift to drag

R	Reynolds number, $\frac{Vl}{\nu}$ or $\frac{V\bar{c}}{\nu}$
$\delta_H$	deflection of horizontal tail, positive when trailing edge down, deg

#### MODEL DESCRIPTION

A drawing of the model is shown in figure 2 and the dimensional characteristics are given in table I. The model was tested in the clean configuration with various horizontal-tail settings, horizontal tail off, lower rudder off, fuselage alone, and with various size strakes and slats on the nose of the model. The strakes and slats were made of 1/16-inch-thick metal, and the location and size of the strakes and slats tested are shown in table II and figures 3 and 4.

L  
9  
0  
5

#### TESTS, CORRECTIONS, AND ACCURACY

##### Tests

The model was mounted on a six-component internal strain-gage balance in the Langley high-speed 7- by 10-foot tunnel and was supported with a U-shape, sting support system. A sketch of the model support system is shown in figure 5, and photographs are shown in figure 6. As previously indicated, the tests were conducted for an angle-of-attack range of  $0^\circ$  to  $90^\circ$  and for a range of sideslip angles of  $10^\circ$  to  $-30^\circ$ ; the Reynolds numbers, based on the maximum depth of the model fuselage nose section, ranged from 335,000 to 865,000 which correspond to a dynamic pressure of 15 to 100 lb/sq ft. For convenience, a plot of dynamic pressure against Reynolds number is presented in figure 7.

The desired combination of angle of attack  $\alpha$  and sideslip  $\beta$  could not be obtained for a given run without going into the test section of the tunnel and changing the model roll angle  $\phi$  with each change in the turntable angle  $\alpha_1$ . Of course, the time required for this type of operation would be prohibitive; therefore, the model tests were made by setting the model at a given roll angle and rotating the turntable through its angle range by remote control. Constant values of angle of attack were then obtained for given values of sideslip by cross-plotting. The relationship of angle of attack and angle of sideslip with turntable angle and roll angle are shown in figure 8.

### Corrections

Blockage corrections, as determined by reference 4, were applied to the dynamic pressure. The model angles of attack and sideslip have been corrected for deflection of the balance and sting support under load. The jet-boundary corrections were not applied to the angle of attack; the maximum angle of attack increase due to the jet-boundary-correction method of reference 5 would be about  $0.35^\circ$ . This increase occurs at an angle of attack of about  $40^\circ$  and decreases to zero as  $\alpha$  approaches  $90^\circ$ .

### Accuracy

The accuracy of the measurement of the forces and moments has been computed based on the maximum load limits of the strain-gage balance used, and is as follows:

$C_N$	±0.0300
$C_A$	±0.0021
$C_m$	±0.0040
$C_l$	±0.0009
$C_n$	±0.0009
$C_y$	±0.0063

## RESULTS AND DISCUSSION

Representative results of the present investigation are presented in figures 9 to 16, and a tabulation of all the data obtained and an explanation of the code for the various configurations tested are presented in table III. The data were reproduced from an automatic computing machine, and the minus signs are to the right of the numbers to which they apply.

The longitudinal coefficients are presented in figures 9 and 10 and indicate that an appreciable effect of Reynolds number is obtained for the pitching moment. The major effect of Reynolds number on pitching moment is shown to be in the angle-of-attack range from  $30^\circ$  to  $75^\circ$  and indicates larger nose-down pitching moments for higher Reynolds numbers. The relatively small effects of Reynolds number on the normal force are considered to be in the right direction from the effects seen on pitching moment. The apparent effects of Reynolds number on axial force between angles of attack of  $40^\circ$  and  $90^\circ$  are relatively large percentagewise, but the actual value of the coefficient for either the low or high Reynolds numbers would probably be insignificant at these attitudes.

The lateral coefficients are presented on figures 11 to 13. Figure 11 shows little or no effect of Reynolds number on the rolling-moment coefficient  $C_l$ , whereas figures 12 and 13 indicate that relatively large effects of Reynolds number may be expected on the side-force coefficient  $C_Y$  and yawing-moment coefficient  $C_n$ . Figure 12 shows that, for the angle-of-attack range between  $40^\circ$  and  $70^\circ$ , smaller negative values of  $C_{Y\beta}$  were obtained for the higher Reynolds numbers.

Test results indicate that the largest effect of Reynolds number on yawing moment is between angles of attack of  $50^\circ$  and  $70^\circ$  (fig. 13). In general,  $C_{n\beta}$  was more positive (or less negative) for the higher Reynolds numbers.

The data of figures 11 to 13 indicate that large variations in side-force, yawing-moment, and rolling-moment coefficients are possible at a sideslip angle of  $0^\circ$  for low Reynolds numbers and relatively high angles of attack. For example, the side-force coefficient at a Reynolds number of 335,000 and an angle of attack of  $60^\circ$  may vary from 0.15 to -0.24. These results might be explained by asymmetrical vortices being shed from the nose as suggested in reference 6. It should be emphasized, therefore, that in this range of Reynolds number and angle of attack, large asymmetric side forces and yawing moments are likely to occur at a sideslip angle of  $0^\circ$  for a given configuration, even to the extent of being of opposite sign.

As was previously indicated, the primary effect of Reynolds number on side force and yawing moment occurred at angles of attack from about  $50^\circ$  to  $70^\circ$ . In analyzing the results, it is to be expected that the wing and tail surfaces, at these high angles of attack, would be more like flat plates insofar as effects of Reynolds number are concerned, and in addition, these flat surfaces would be expected to spoil any effect of Reynolds number on the fuselage rearward of the wing leading edge. The nose section has no such surfaces to spoil the flow and is, therefore, more susceptible to various flow changes due to Reynolds number. As pointed out in references 2 and 3, large changes in side force due to Reynolds number can be obtained for various cross-sectional shapes for two-dimensional bodies. Somewhat similar effects of Reynolds number would be expected to occur on three-dimensional bodies such as the nose section. If the nose is then considered to cause most of the effects of Reynolds number, a positive yawing-moment increment would be expected. The increment in side force due to Reynolds number for an angle of attack of  $60^\circ$  (fig. 12) and an angle of sideslip of  $7^\circ$  is about 0.32. As can be seen from figure 13 ( $\alpha = 60^\circ$ ;  $\beta = 7^\circ$ ), a positive yawing-moment increment of about 0.18 is obtained. The lever arm of the side force, required to obtain this increment in yawing moment, is about three-fourths the nose length. It is considered, therefore,



that most of the effects of Reynolds number observed in side force and yawing moment were caused by the nose section.

In order to determine if the range of Reynolds numbers had been sufficiently covered, side-force coefficients were plotted against Reynolds number for the spinning angle-of-attack range of the model ( $40^\circ$  to  $90^\circ$ ) in figure 14. Side force was chosen because of its large variation with increasing Reynolds number for cylinders of various cross-sectional shapes. (See refs. 2 and 3.) The test results indicate that for a sideslip angle of  $0^\circ$  the critical Reynolds number region, based on the maximum fuselage depth, was between 500,000 and 600,000.

However, for sideslip angles of  $5^\circ$  to  $-20^\circ$ , figure 14 indicates that the critical Reynolds number region increases. This effect agrees with three-dimensional static data of other designs (unpublished) at high angles of attack which show an increase in the critical Reynolds number region with increase in sideslip angle. At the lower Reynolds numbers, the side-force slope indicates that the subcritical region was not obtained completely. It should be pointed out that even though the results of this investigation indicate a given effect of Reynolds number for this design, other designs which have different fuselage cross-sectional shapes would be expected to have different critical Reynolds number regions.

In an effort to obtain an indication of the type and size of an auxiliary control device which would be required to make the side force and yawing moment acting on the spin-tunnel model ( $R = 50,000$ ) more nearly representative of the side force and yawing moment present on the full-scale airplane ( $R \approx 8 \times 10^6$ ), strakes and slats were placed on the nose of the force test model and tested at a Reynolds number of about 335,000. Strakes were used as transition strips to change the air flow, and slats were used to direct the air flow (figs. 3 and 4). A representative plot showing the effects of a strake (B-2R) on side force, at an angle of attack of  $70^\circ$ , is shown on figure 15. As can be seen from this figure, a side-force increment of about -0.35 is indicated between the minimum and maximum Reynolds numbers of the present investigation. The increment added by the B-2R strake is approximately -0.30 and allows the data for the low Reynolds numbers to represent more closely the characteristics of the high Reynolds numbers. Indications are, therefore, that a strake approximating the size and location of the B-2R strake could be used on the dynamic spin model to aid in correcting effects of Reynolds number on side force and yawing moment at spinning angles of attack ( $40^\circ$  to  $90^\circ$ ) and a range of sideslip angles of  $\pm 15^\circ$ .

Brief tests were made to determine the effects of the lower rudder on the value of maximum trim  $L/D$  and the angle of attack at which it

takes place. These results are presented on figure 16. These tests were made at a dynamic pressure of 100 lb/sq ft ( $R = 1,900,000$  based on  $\bar{c}$ ) with the model in the clean condition, landing gear retracted. Test results indicate that the maximum  $(L/D)_{trim}$  was somewhat greater with the lower rudder off than with it on but both occurred at an angle of attack of about  $6^\circ$ .

#### CONCLUDING REMARKS

Based on a static force test investigation for a range of Reynolds numbers on a model of a modern research airplane configuration, the following is concluded:

1. For an angle-of-attack range of  $40^\circ$  to  $90^\circ$  and sideslip angle of  $0^\circ$ , the critical Reynolds number region, based on the maximum depth of the fuselage, for side-force coefficient  $C_Y$  and yawing-moment coefficient  $C_n$  is between 500,000 and 600,000.

2. In general, for sideslip angles of  $5^\circ$  to  $-20^\circ$ , the critical Reynolds number, based on the maximum fuselage depth, is greater than 800,000.

3. Large increments in pitching moment are obtained due to change in Reynolds number for the angle-of-attack range from  $30^\circ$  to about  $75^\circ$ . Higher Reynolds numbers indicate larger nose-down pitching moments.

4. Effects of Reynolds number on normal and axial forces and on rolling moment were found to be small.

5. Large increments in yawing moments and side force were obtained for the range of Reynolds numbers tested for angles of attack of  $50^\circ$  to  $70^\circ$ .

6. For an angle-of-attack range of  $40^\circ$  to  $60^\circ$ , and at low Reynolds numbers, large asymmetric side forces and yawing moments are likely to occur at a sideslip angle of  $0^\circ$  for a given configuration, even to the extent of being of opposite sign.

7. It was found that a strake placed on the nose of the model helped to compensate for the effects of Reynolds number on side force and yawing moment.

Langley Research Center,  
National Aeronautics and Space Administration,  
Langley Field, Va., March 24, 1960.

## REFERENCES

1. Neihouse, Anshal I., Klinar, Walter J., and Scher, Stanley H.:  
Status of Spin Research for Recent Airplane Designs. NASA  
TR R-57, 1960. (Supersedes NACA RM L57F12.)
2. Polhamus, Edward C.: Effect of Flow Incidence and Reynolds Number  
on Low-Speed Aerodynamic Characteristics of Several Noncircular  
Cylinders With Applications to Directional Stability and Spinning.  
NASA TR R-29, 1959. (Supersedes NACA TN 4176.)
3. Polhamus, Edward C., Geller, Edward W., and Grunwald, Kalman J.:  
Pressure and Force Characteristics of Noncircular Cylinders as  
Affected by Reynolds Number With a Method Included for Determining  
the Potential Flow About Arbitrary Shapes. NASA TR R-46, 1959.
4. Allen, H. Julian, and Vincenti, Walter G.: Wall Interference in a  
Two-Dimensional-Flow Wind Tunnel, With Consideration of the Effect  
of Compressibility. NACA Rep. 782, 1944. (Supersedes NACA  
WR A-63.)
5. Theodorsen, Theodore: The Theory of Wind-Tunnel Wall Interference.  
NACA Rep. 410, 1931.
6. Letko, William: A Low-Speed Experimental Study of the Directional  
Characteristics of a Sharp-Nosed Fuselage Through a Large Angle-  
of-Attack Range at Zero Angle of Sideslip. NACA TN 2911, 1953.

L  
9  
0  
5

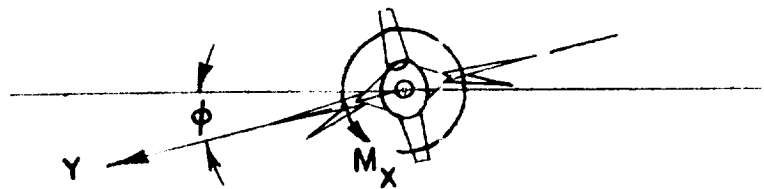
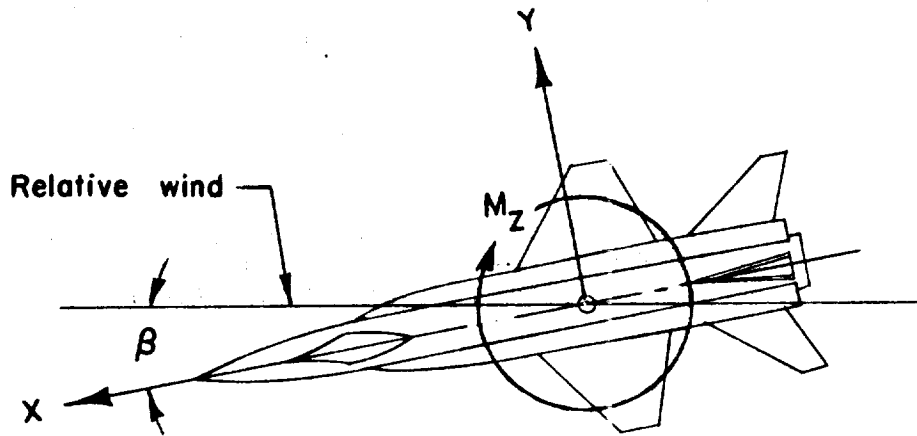
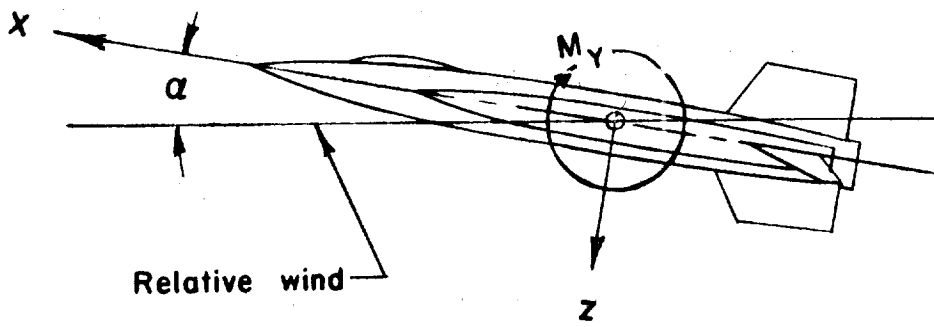

Figure 1.- Body system of axes and related angles.

L-905

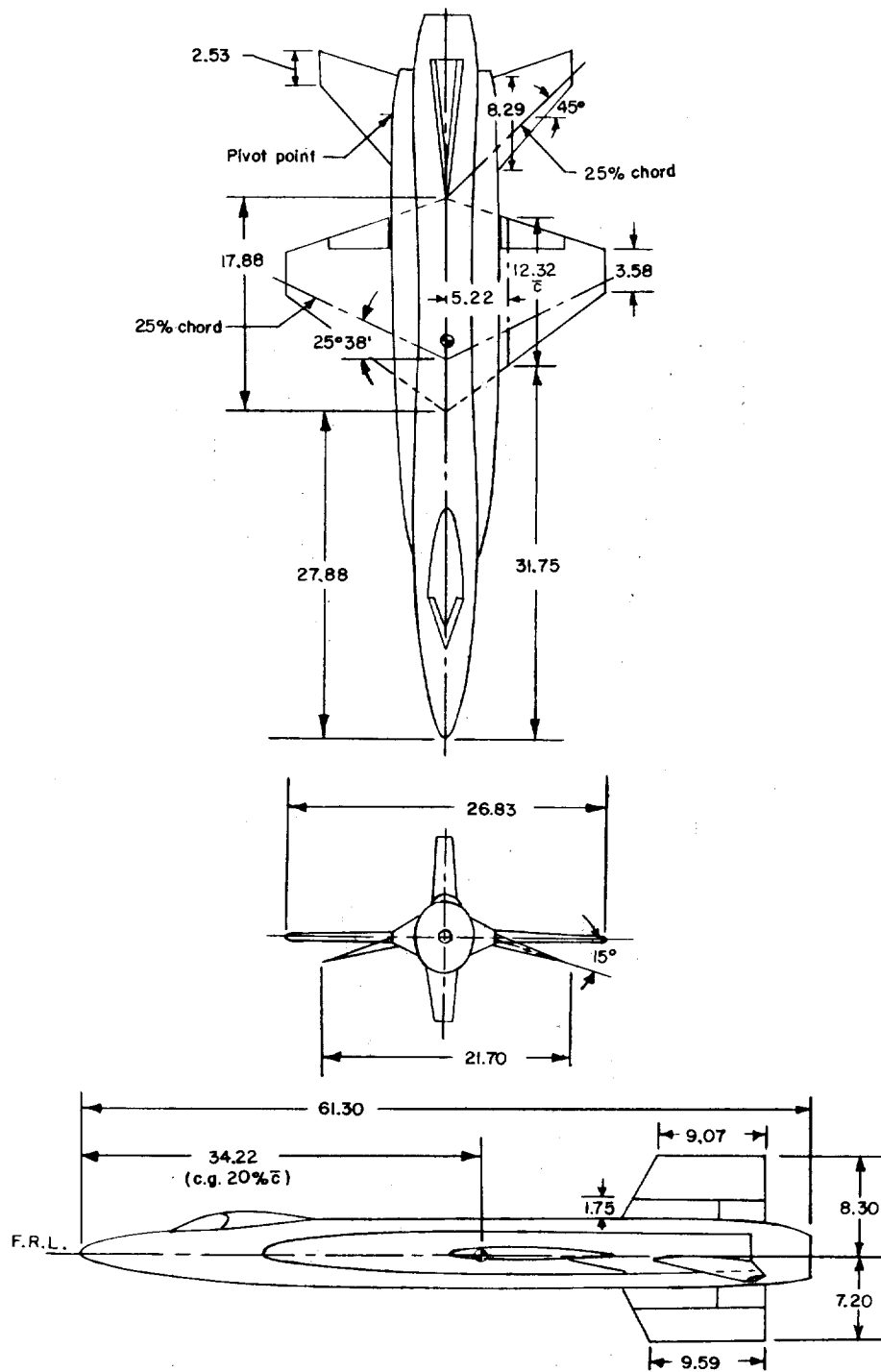

Figure 2.- Three-view drawing of the model. (All dimensions are in inches.)

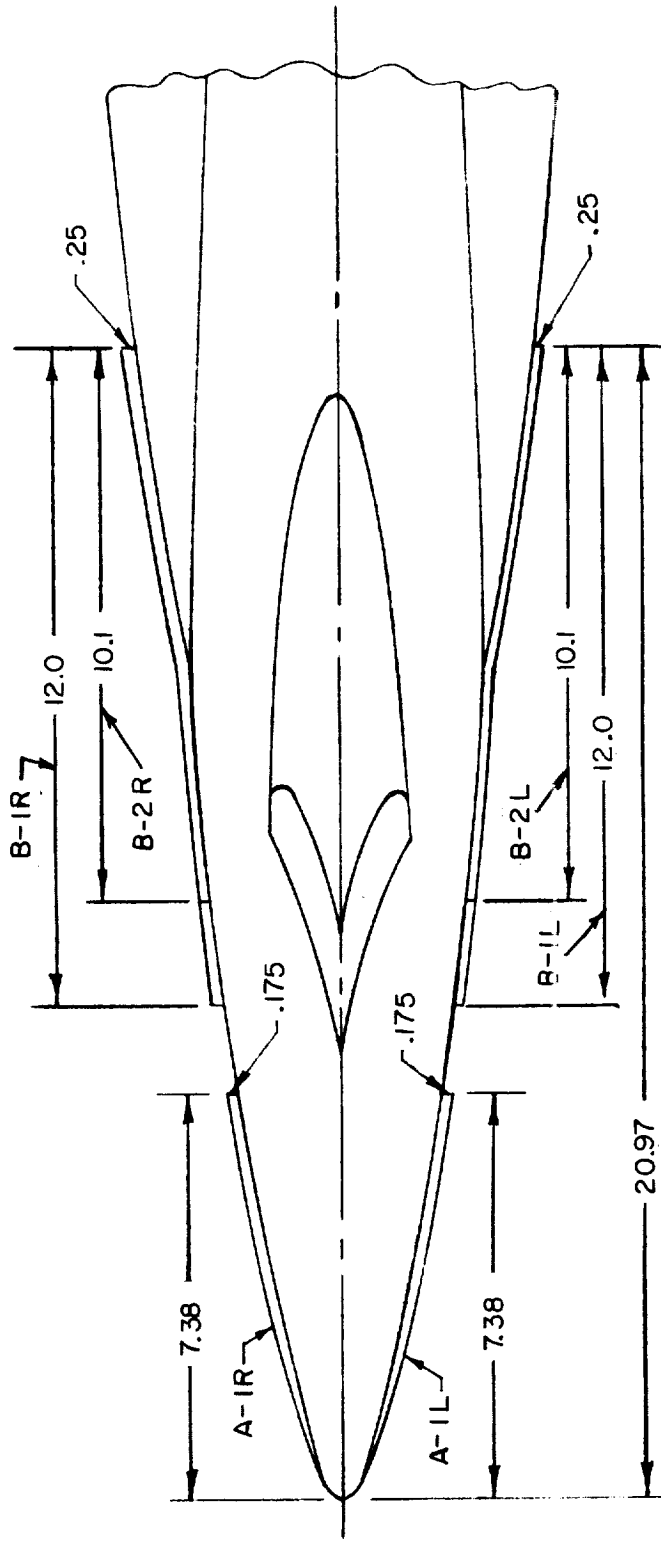

Figure 3.- Sketch of nose of model indicating size and location of strakes. (Strakes located on fuselage reference line; all dimensions are in inches.)

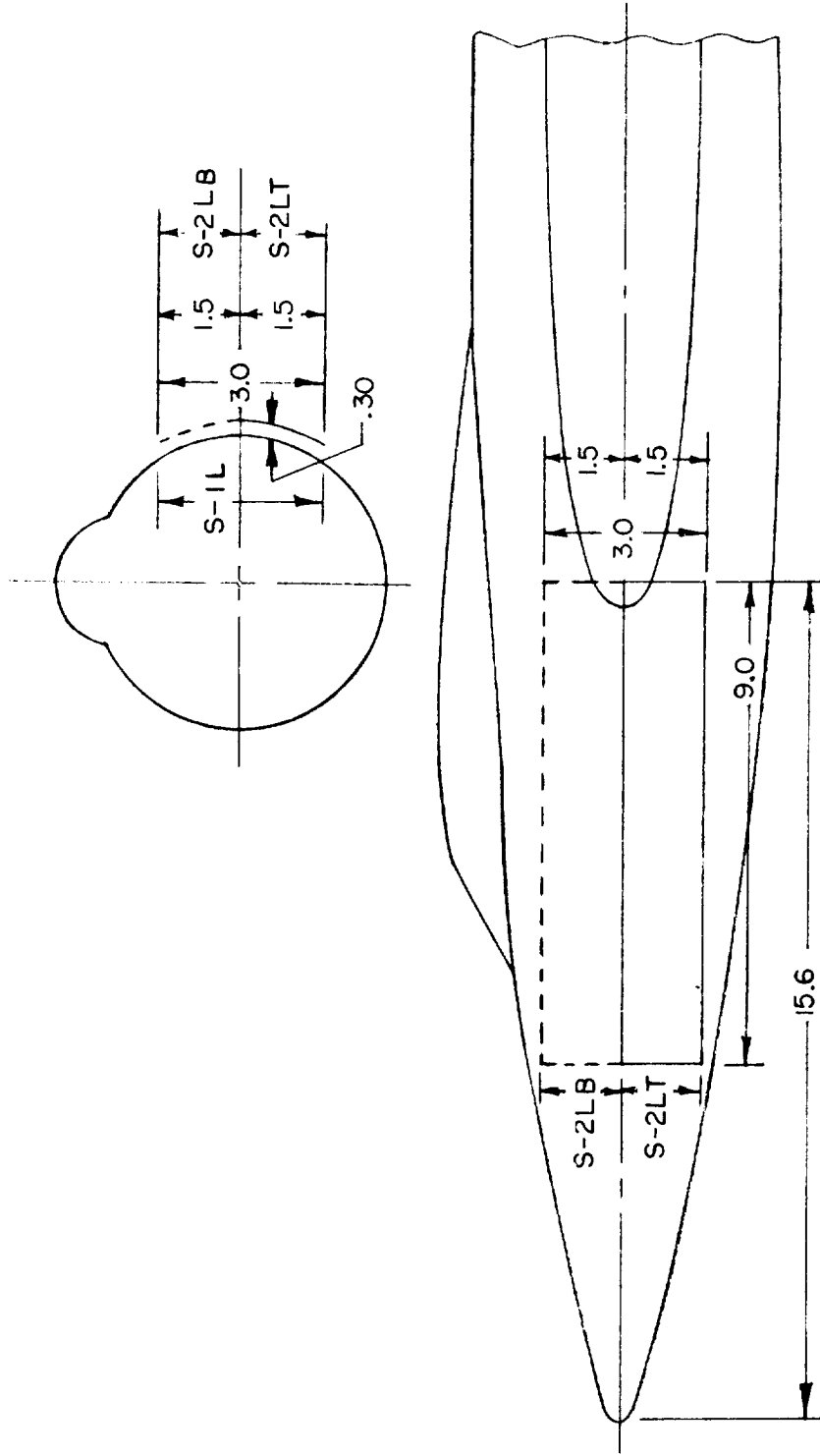

Figure 4.- Two-view sketch of nose indicating size and location of slats. (All dimensions are in inches.)

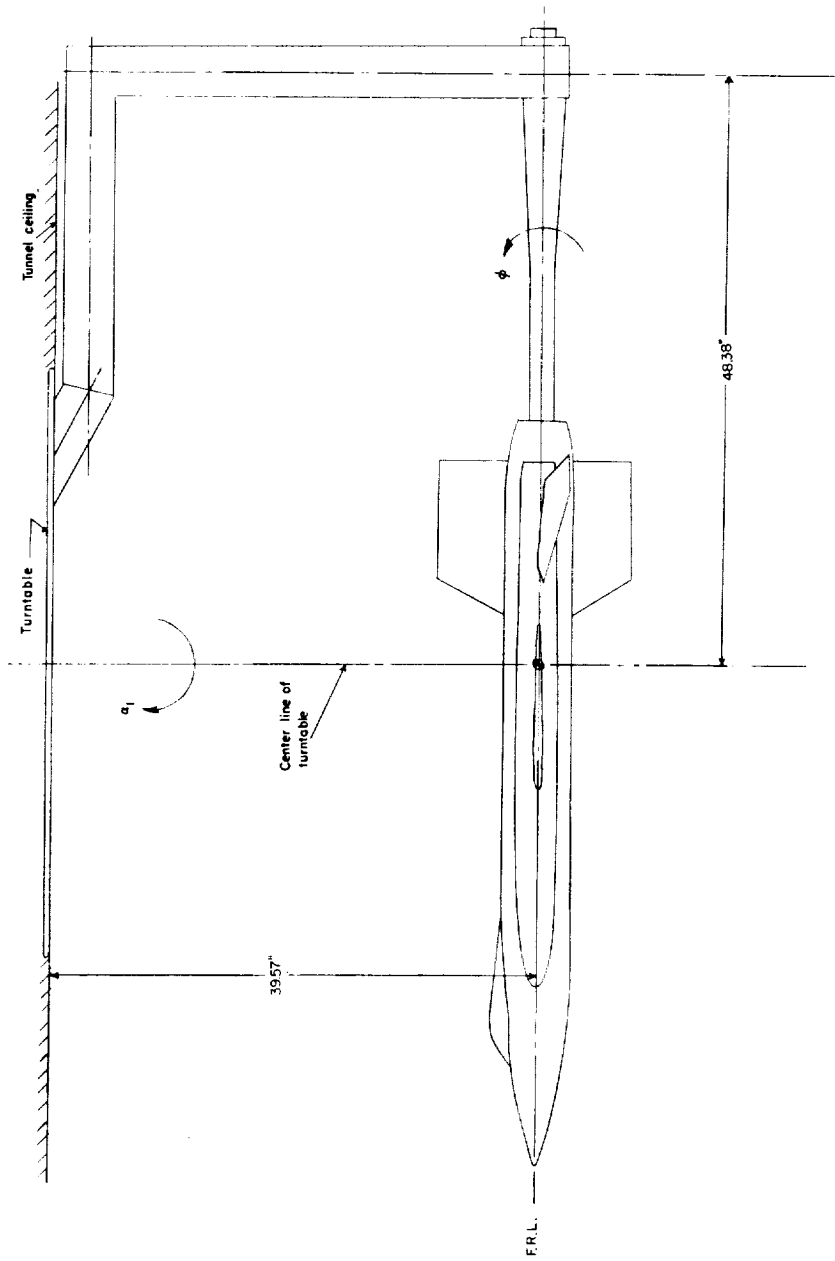

Figure 5.- Sketch showing model and sting arrangement used in Langley high-speed 7- by 10-foot tunnel.



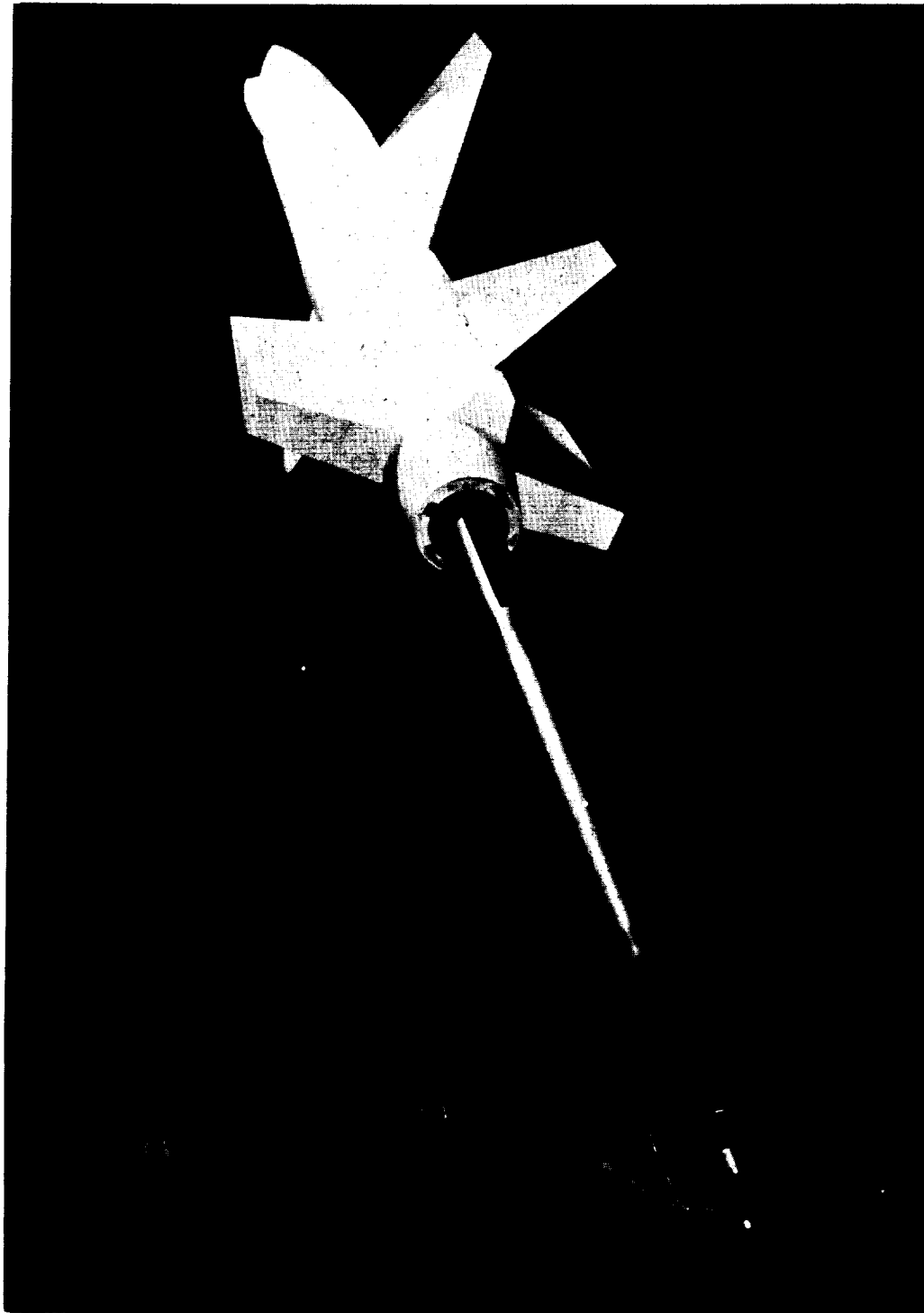
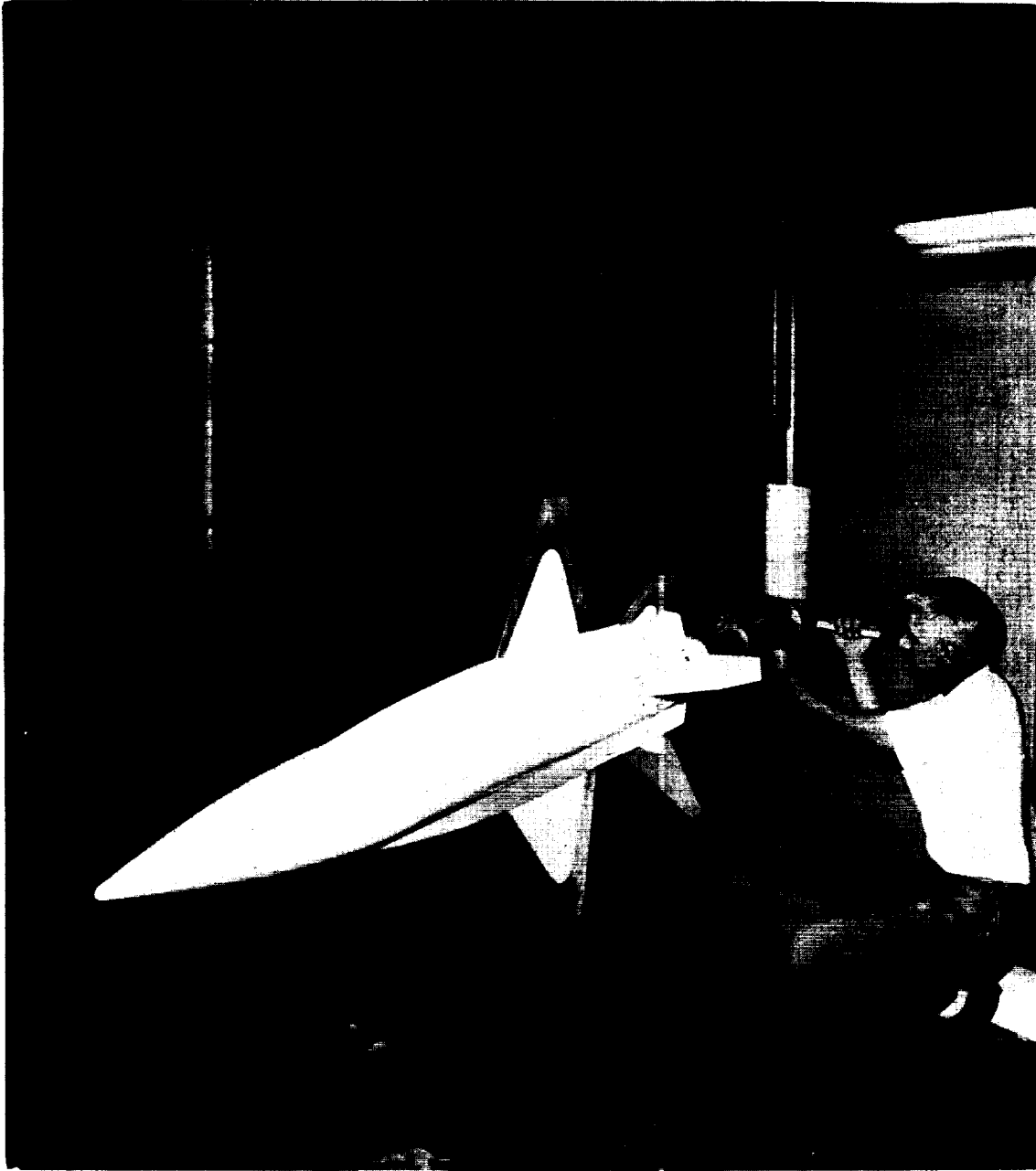

Figure 6.- Photographs of research model mounted on sting in Langley high-speed 7- by 10-foot tunnel.



L-905

Figure 6.- Concluded.

L-58-2956.1

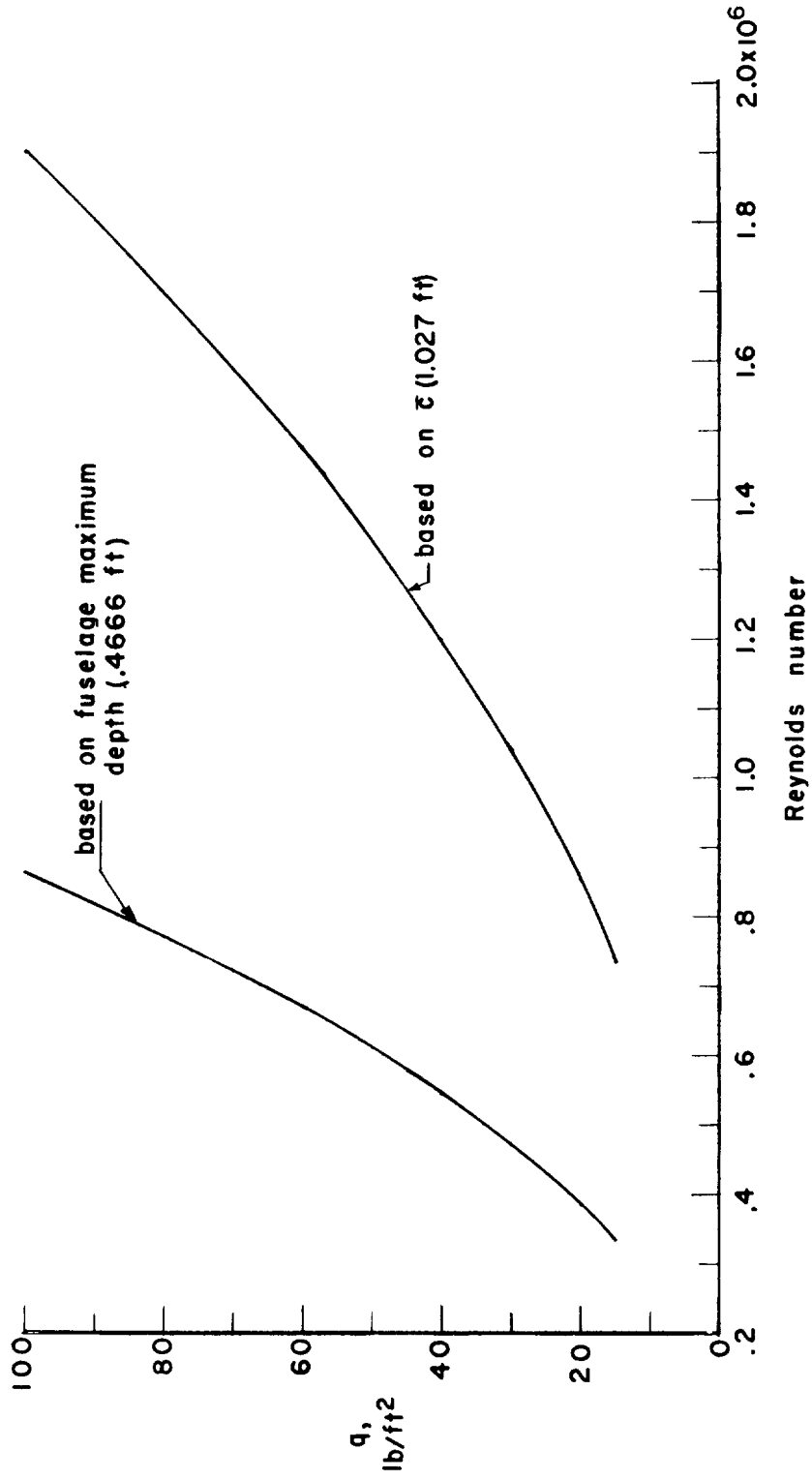

Figure 7.- Variations of Reynolds number with dynamic pressure.

$$\beta = \sin^{-1}(\sin \alpha_1 \sin \phi)$$

$$\alpha = \tan^{-1}(\tan \alpha_1 \cos \phi)$$

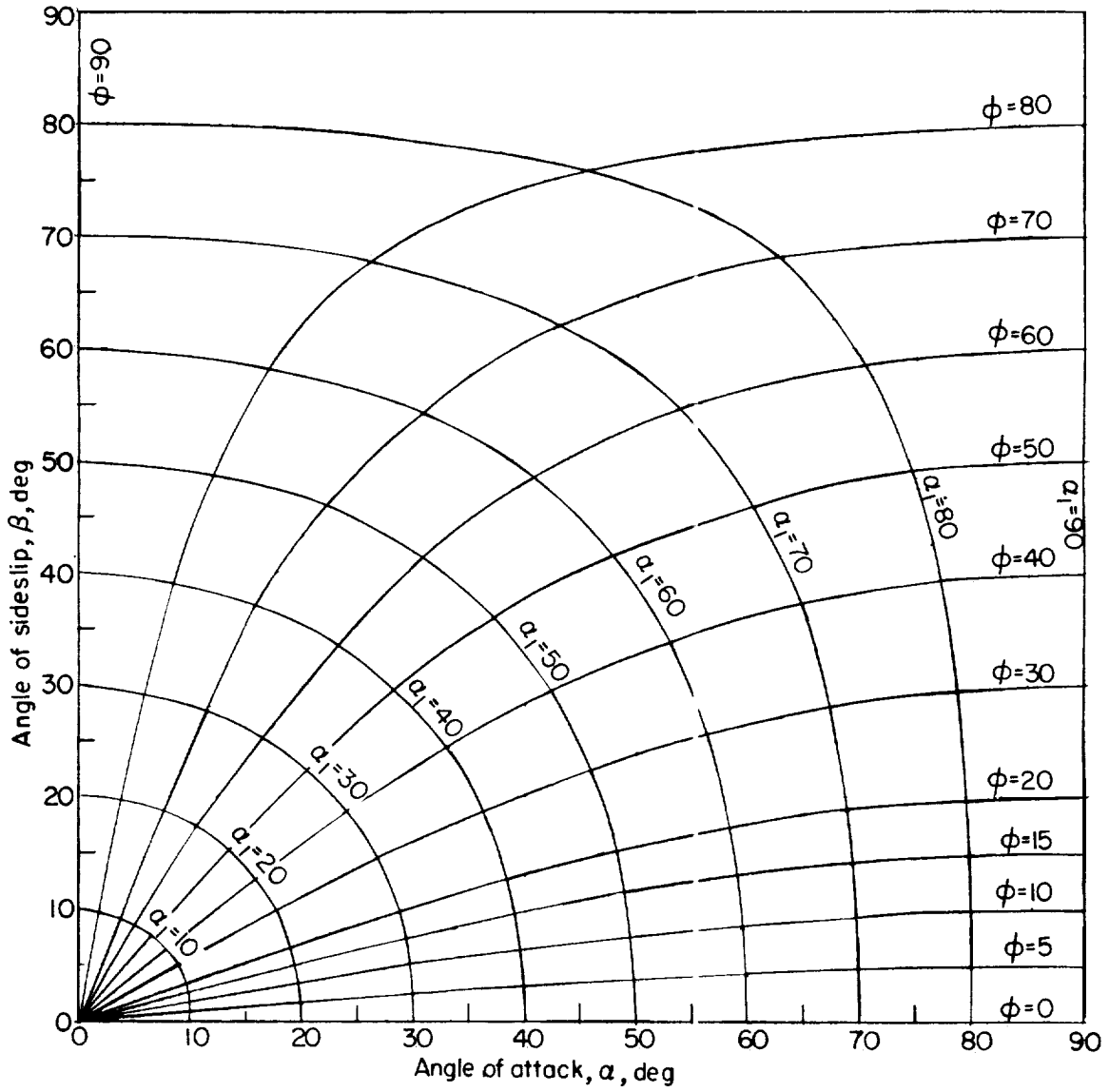

Figure 8.- Plot showing relationship of turntable angle and roll angle to angle of attack and sideslip.

606-T

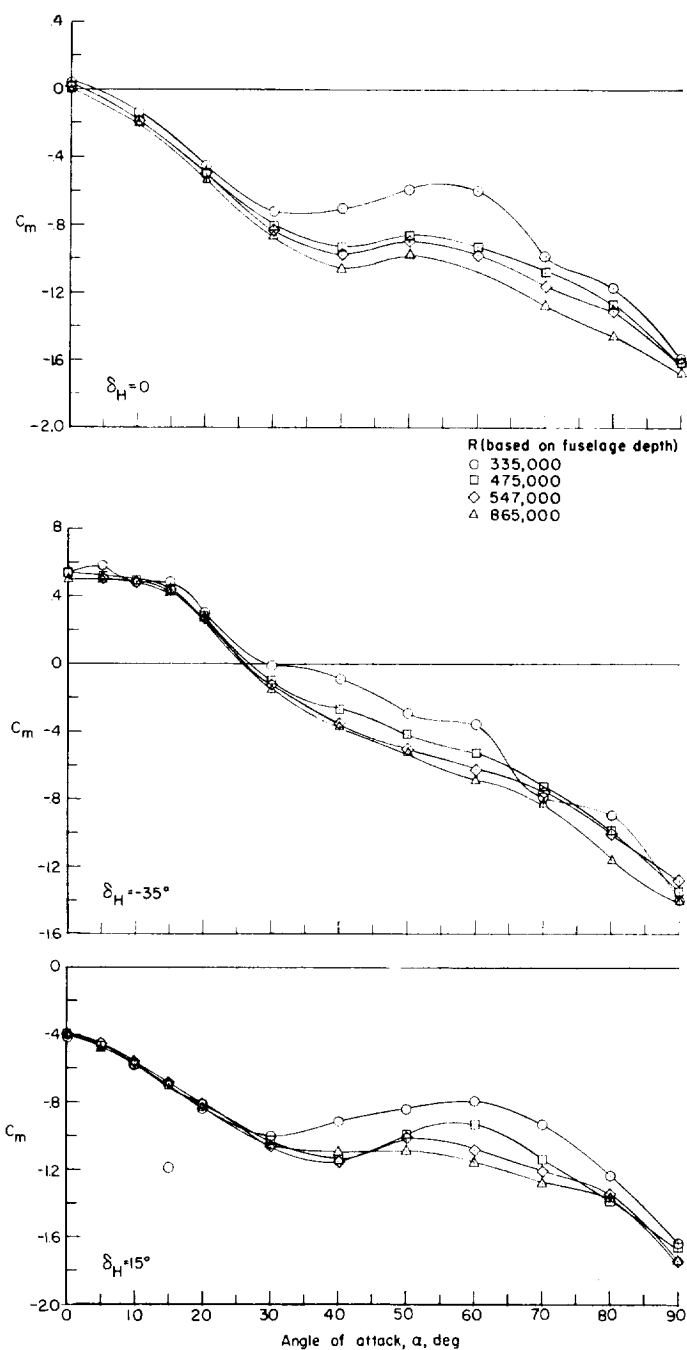
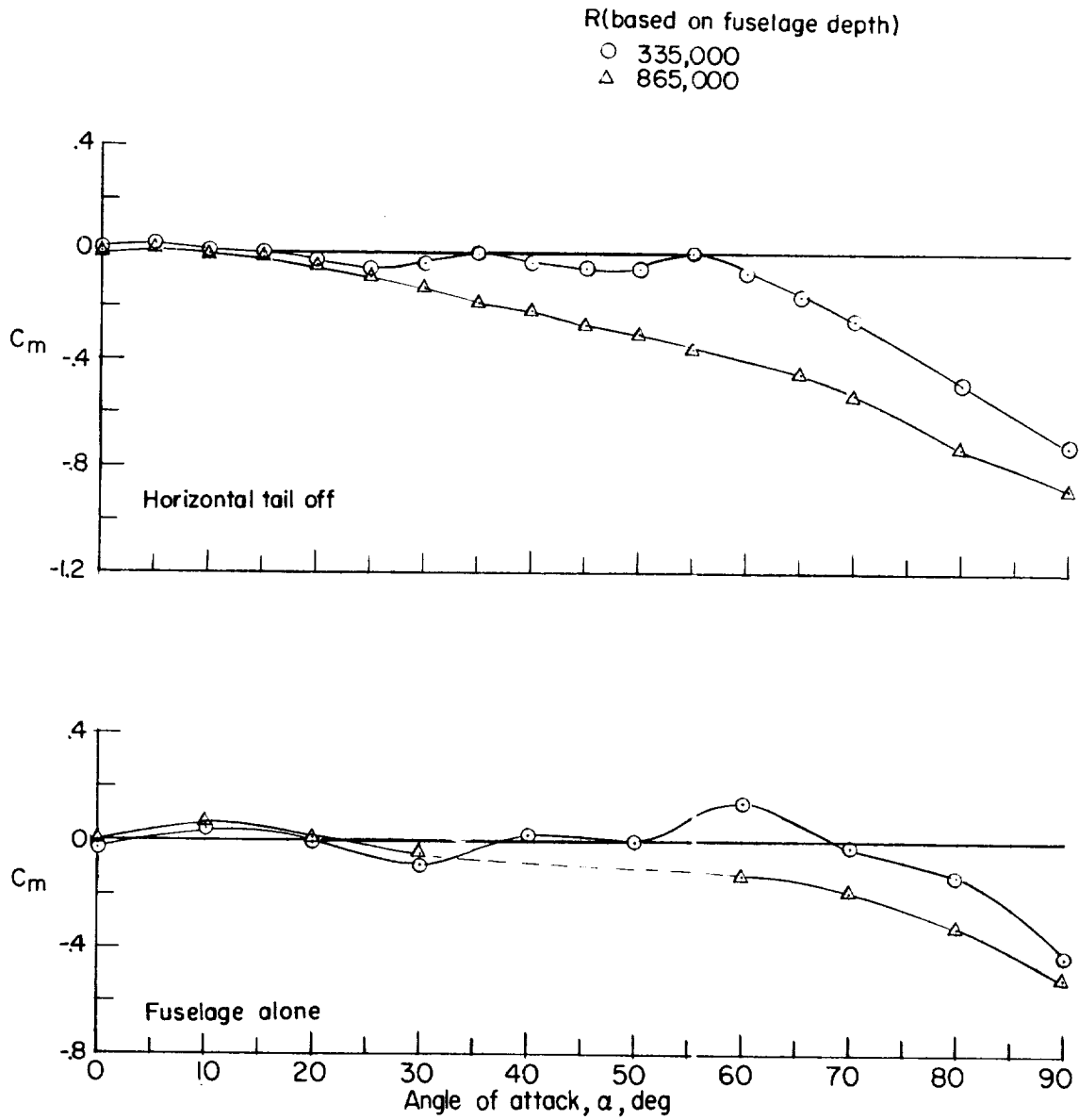

Figure 9.- Variations of pitching-moment coefficient with angle of attack and Reynolds number for various horizontal-tail positions. ( $\beta = 0$ ; center-of-gravity location, 20 percent  $\bar{c}$ .)



(b) Horizontal tail off and fuselage alone.

Figure 9.- Concluded.

L-905

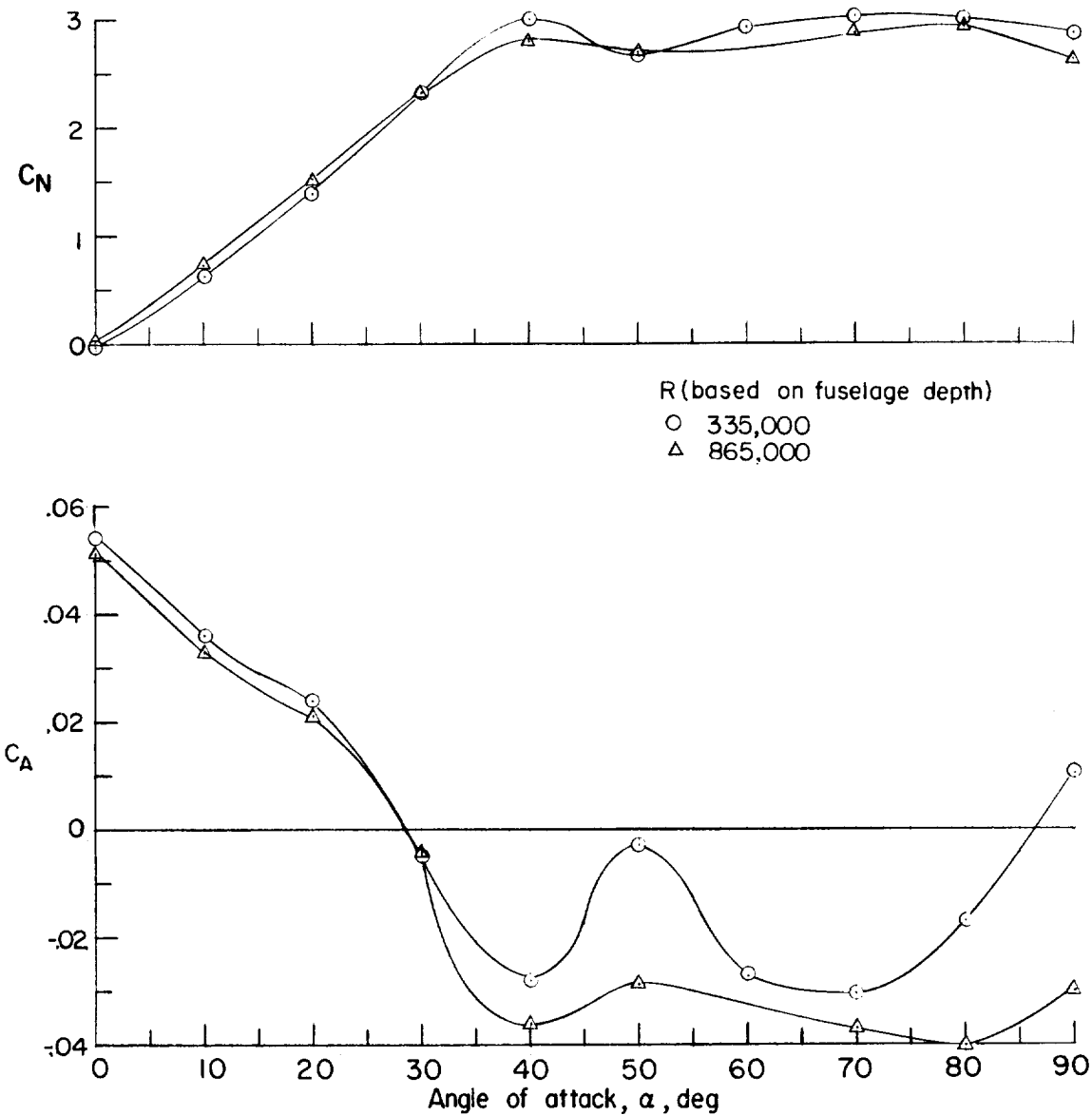

Figure 10.- Representative variations of the normal- and axial-force coefficients with angle of attack for the minimum and maximum Reynolds numbers tested. (Complete model,  $\beta = 0$ .)

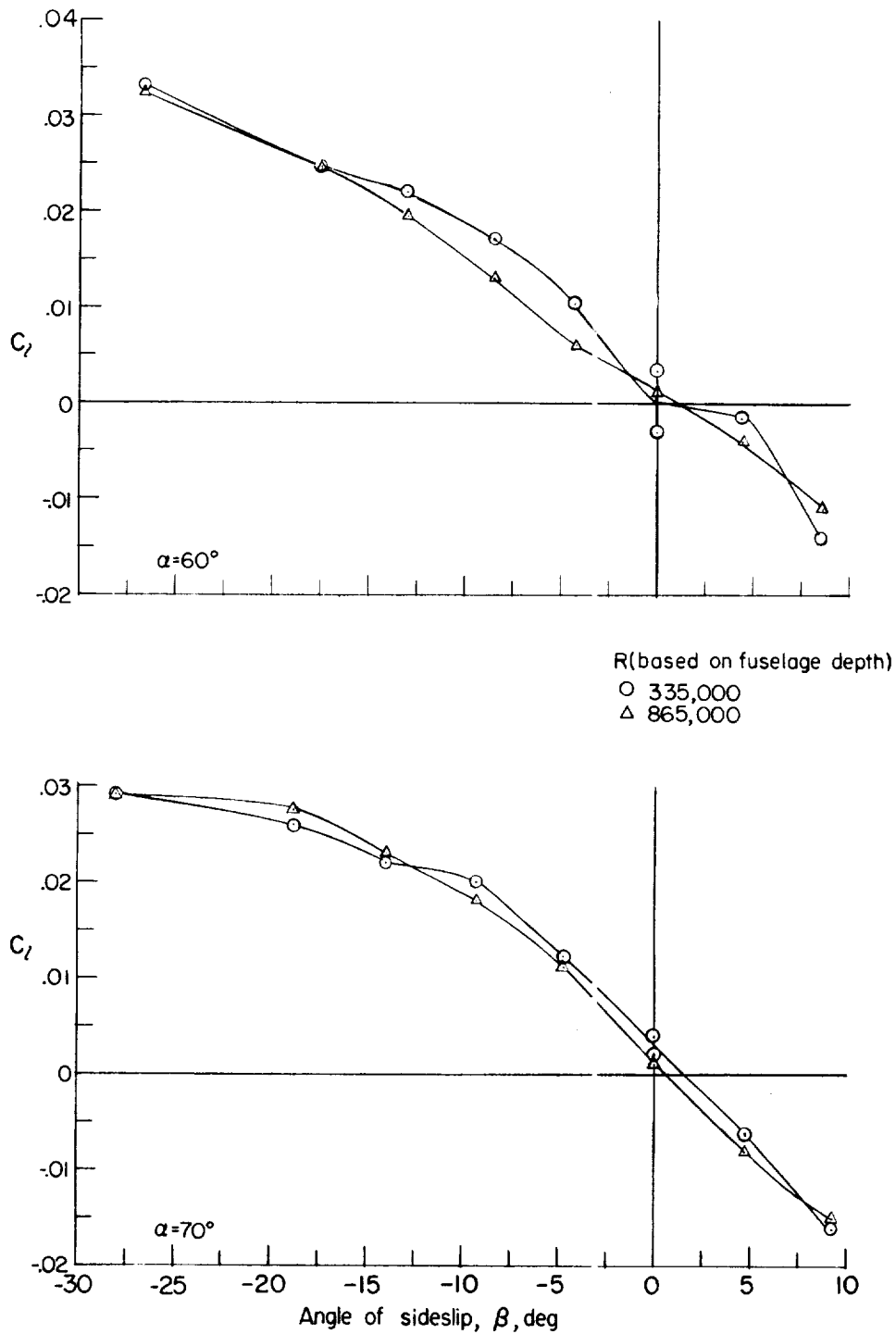

Figure 11.- Variation of rolling-moment coefficient with sideslip for the maximum and minimum Reynolds numbers tested. (Complete model.)



CONF-77

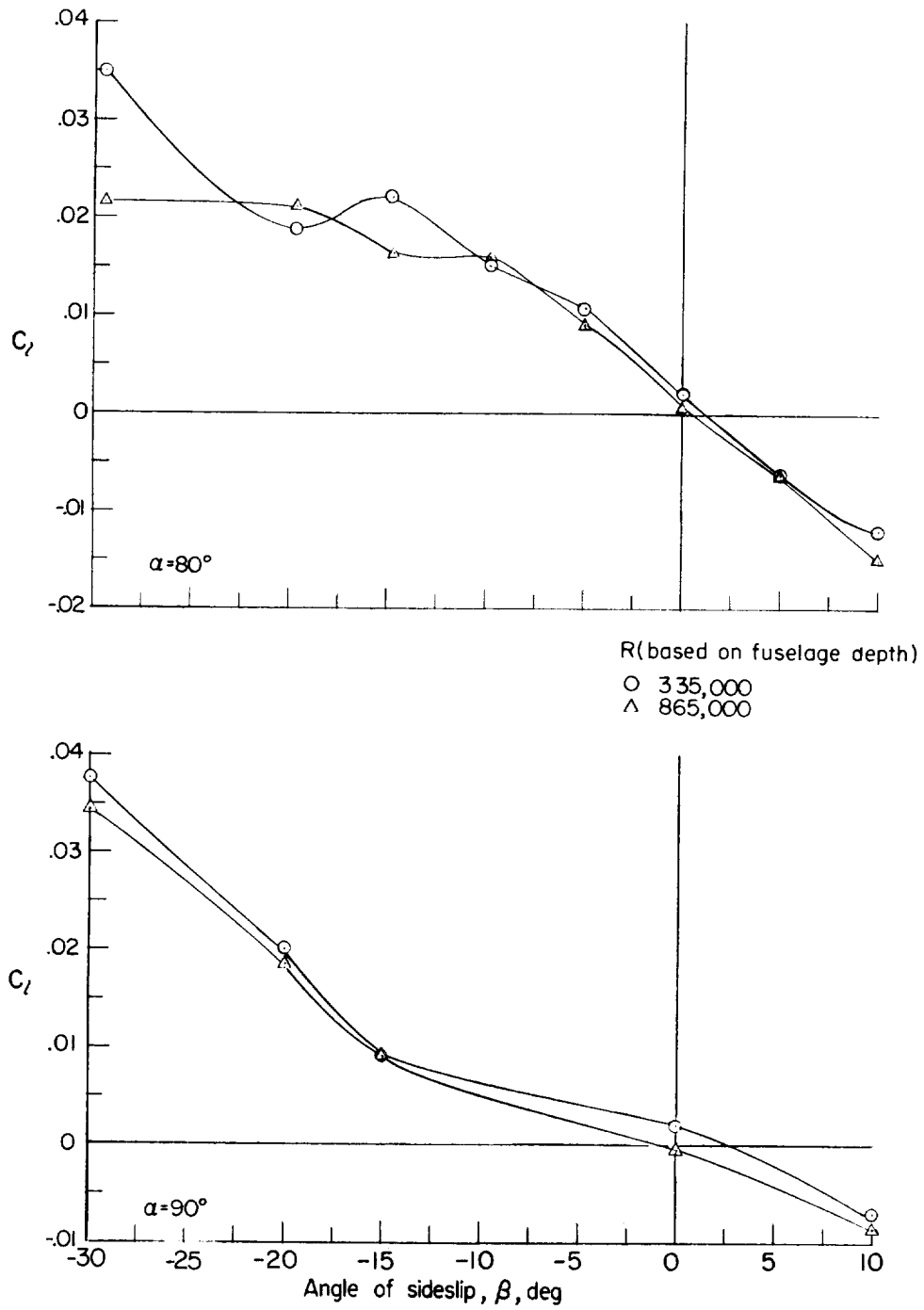

Figure 11.- Concluded.

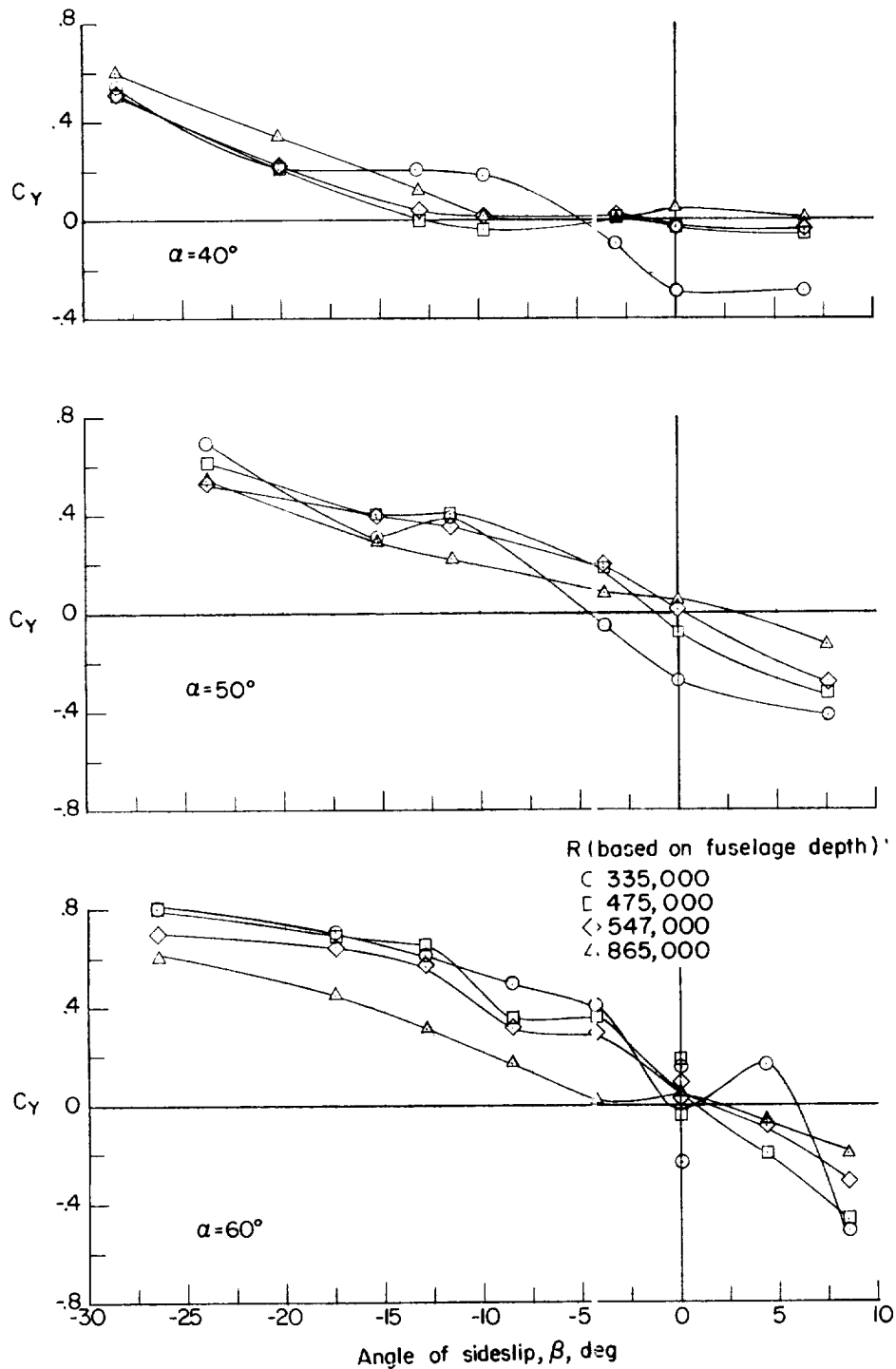

Figure 12.- Variation of side-force coefficient with sideslip for various Reynolds numbers and angles of attack. (Complete model.)

I-905

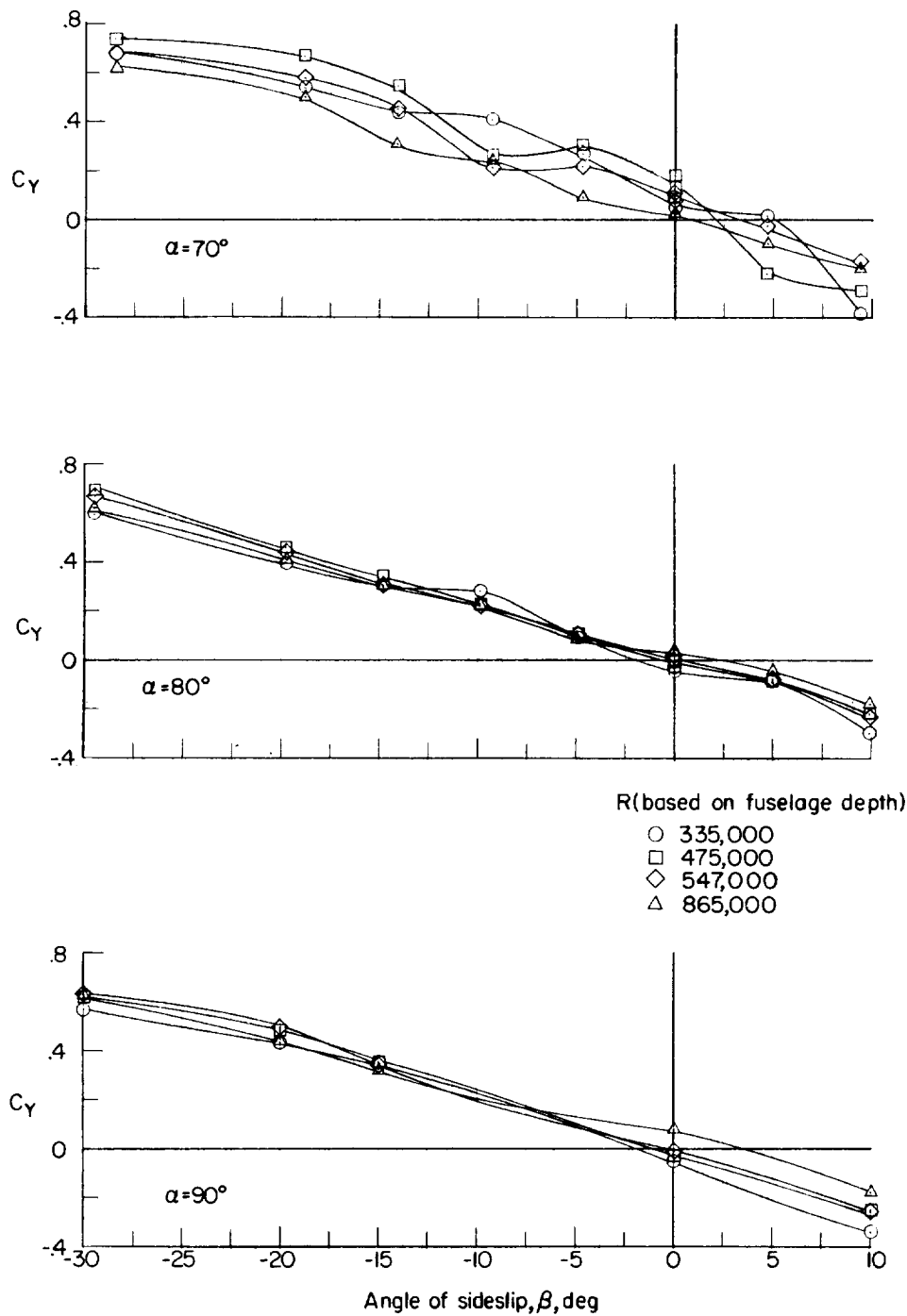

Figure 12.- Concluded.

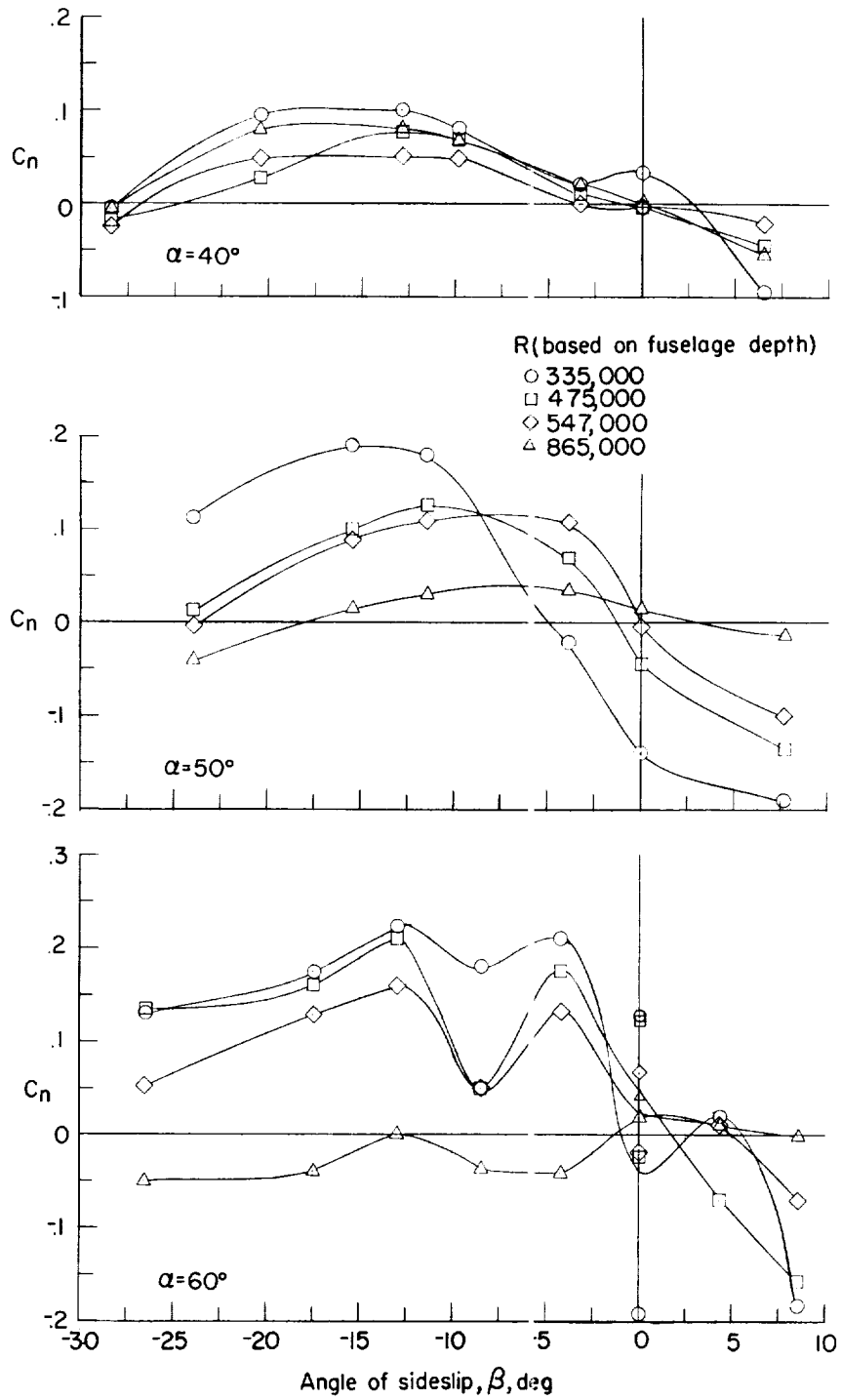

Figure 13.- Variation of yawing-moment coefficient with sideslip for various Reynolds numbers and angles of attack. (Complete model.)

L-905

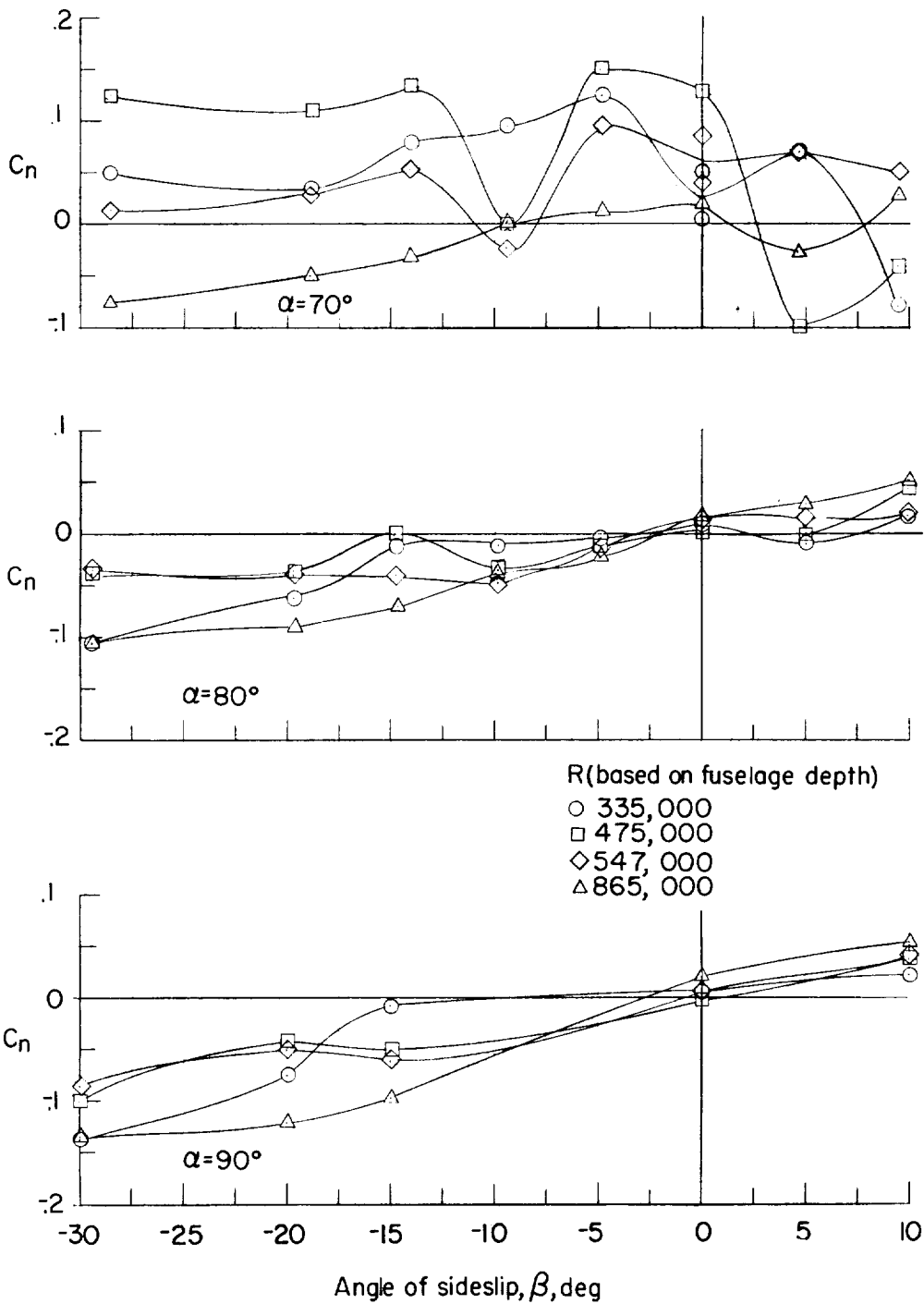
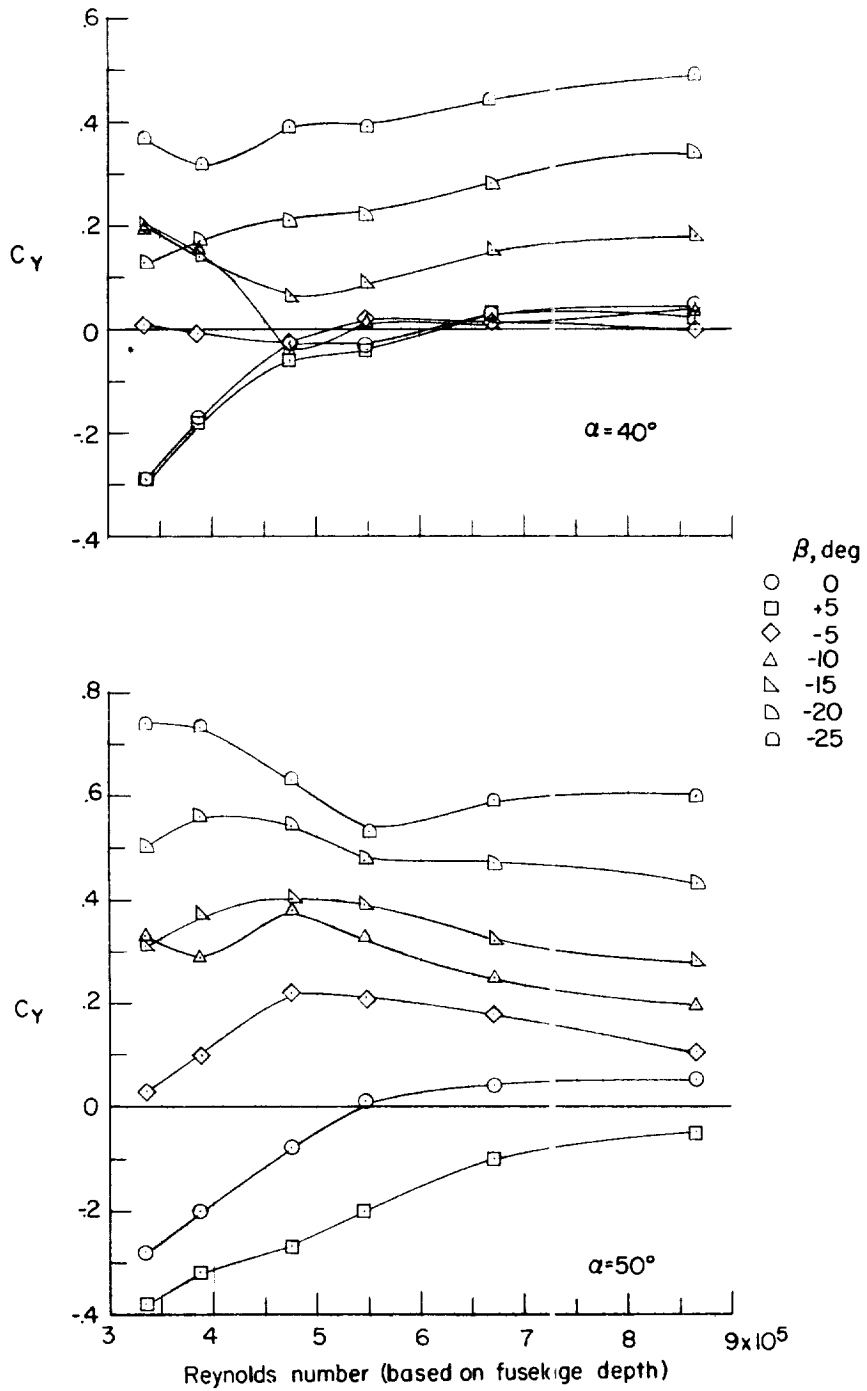

Figure 13.- Concluded.



L-905

Figure 14.- Variation of side-force coefficient with Reynolds number for various sideslip angles and angles of attack. (Complete model.)

L-905

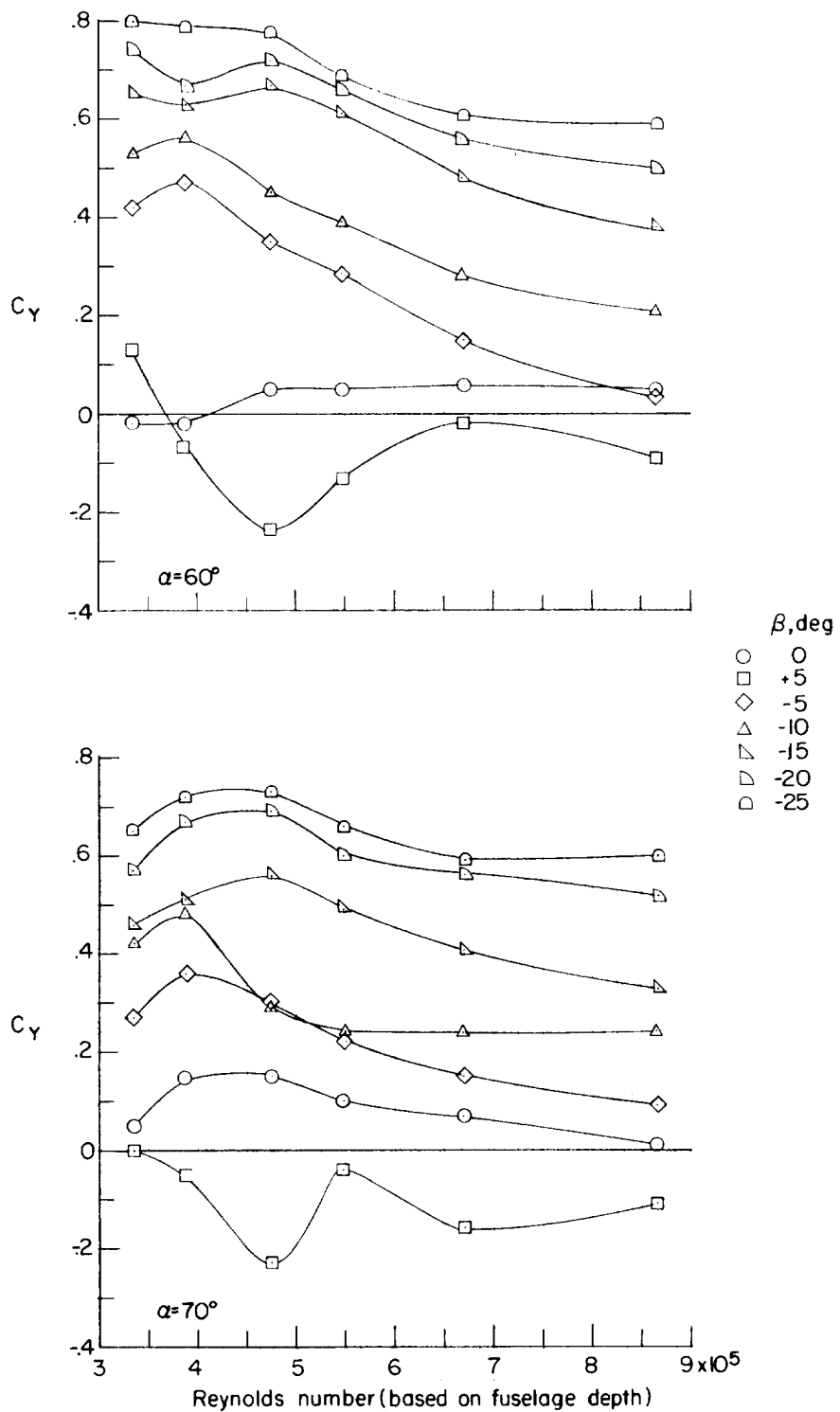
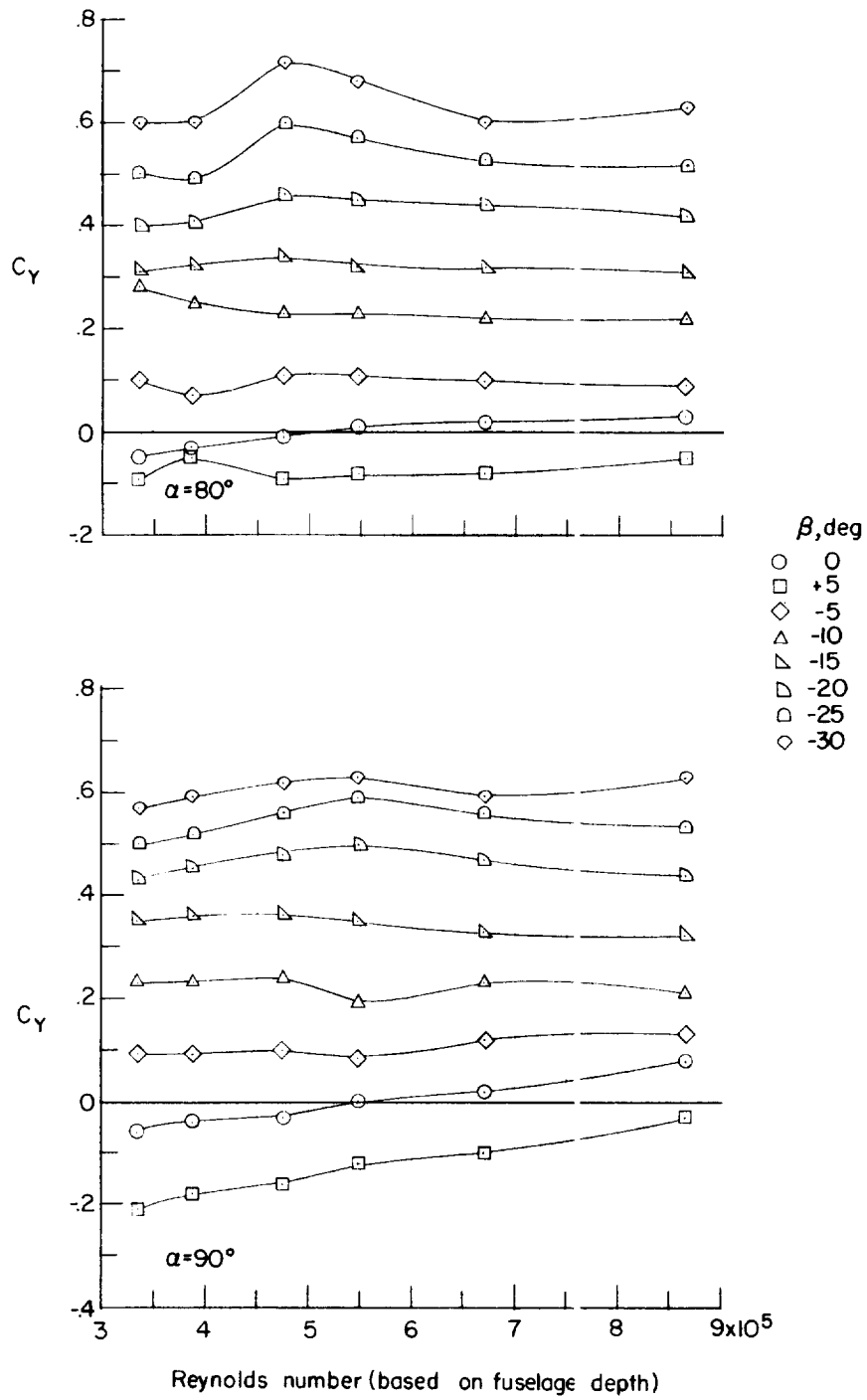

Figure 14.- Continued.



L-905

Figure 14.- Concluded.



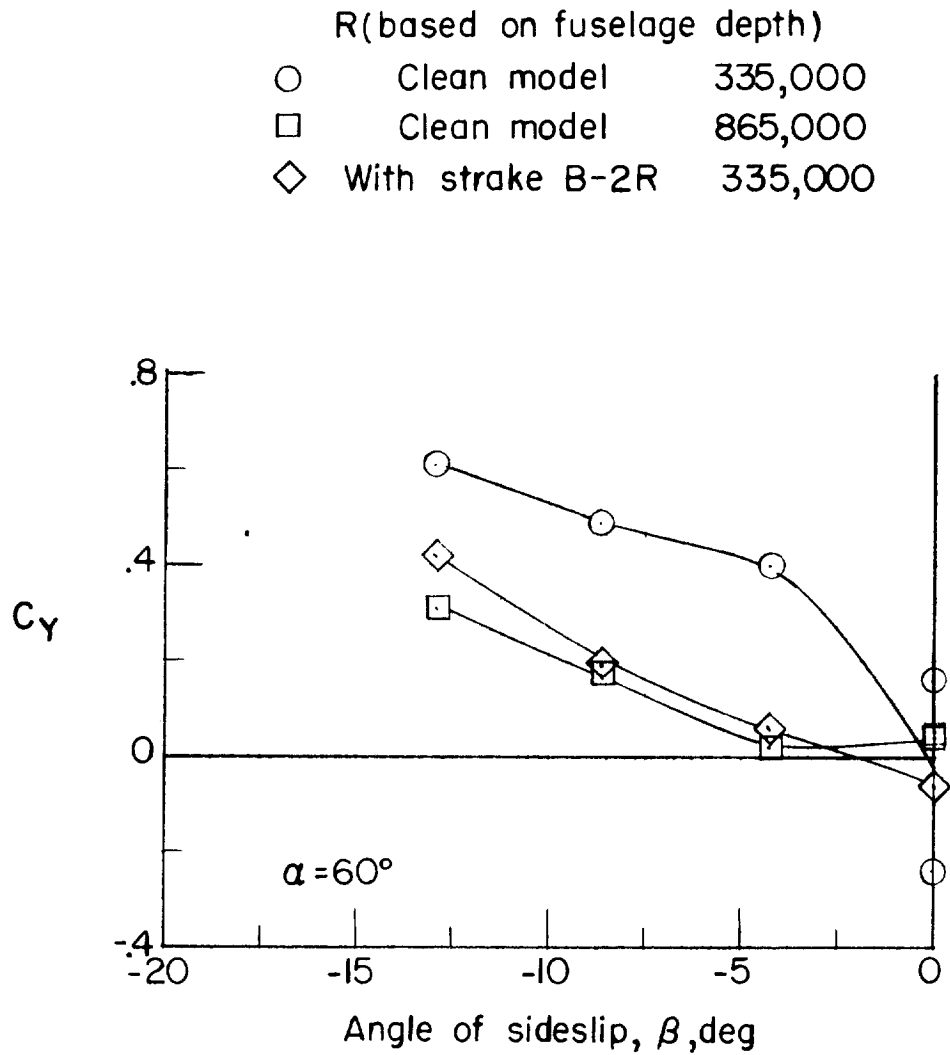

Figure 15.- Representative variation of side-force coefficient with side-slip angle showing strake effectiveness.

$R = 1,900,000$  (based on M.A.C.)

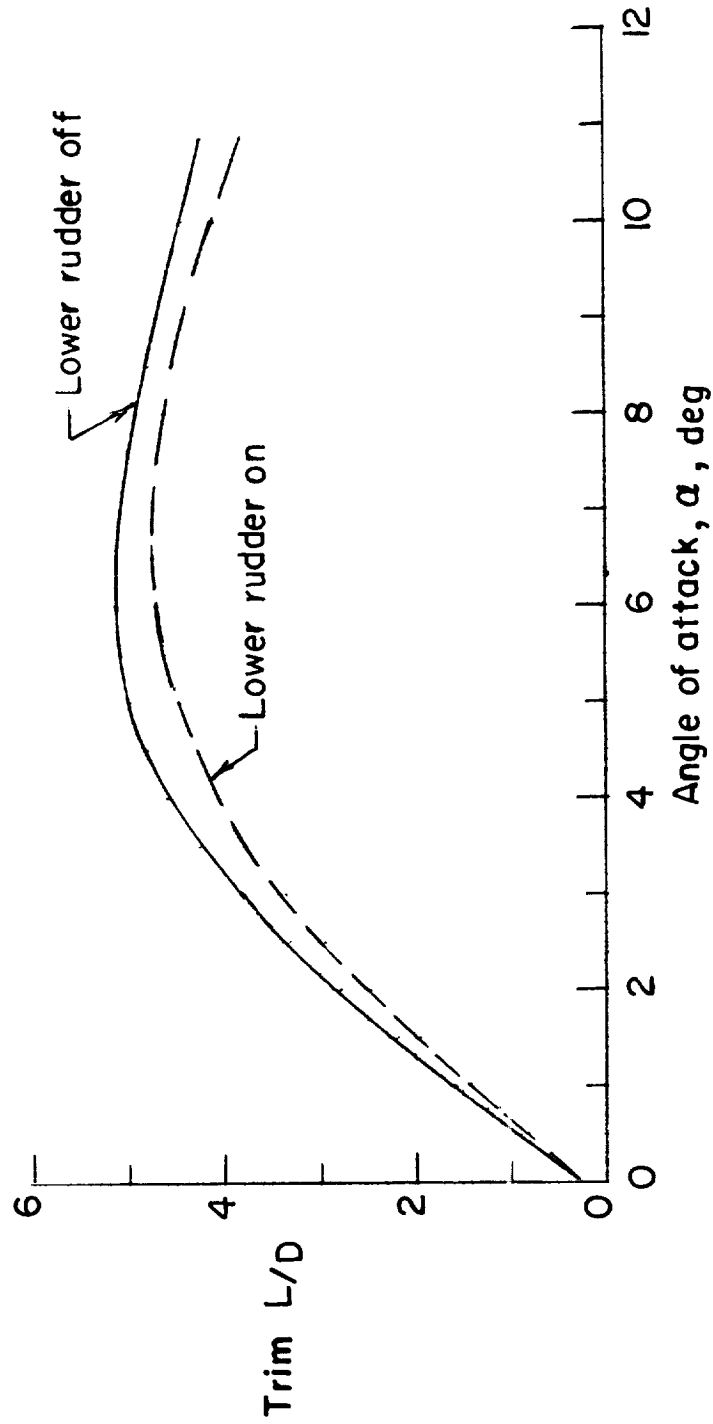

Figure 16.- Variation of trim lift-drag ratio with angle of attack.

TABLE I.- DIMENSIONAL CHARACTERISTICS OF MODEL

Overall length, ft . . . . .	5.11
Wing:	
Area, sq ft . . . . .	2.00
Span, ft . . . . .	2.24
Aspect ratio . . . . .	2.50
Mean aerodynamic chord, in. . . . .	12.32
Sweepback (25-percent-chord line), deg . . . . .	25.64
Incidence, deg . . . . .	0
Dihedral, deg . . . . .	0
Horizontal tail:	
Area (exposed), sq ft . . . . .	0.52
Span, ft . . . . .	1.81
Sweepback (25-percent-chord line), deg . . . . .	45.00
Dihedral, deg . . . . .	-15.00
Vertical tail (upper):	
Area (exposed), sq ft . . . . .	0.41
Sweepback (leading edge), deg . . . . .	30.00
Movable tail area, sq ft . . . . .	0.26
Vertical tail (lower):	
Area (exposed), sq ft . . . . .	0.34
Movable tail area, sq ft . . . . .	0.20
Sweepback (leading edge), deg . . . . .	30.00
Maximum fuselage depth, ft . . . . .	0.467

L  
9  
0  
5

TABLE II.- SIZE AND LOCATION OF STRAKES AND SLATS

## (a) Nose strakes (located on fuselage reference line)

Strake	Location on fuselage	Distance from nose to forward end of strake, in.	Distance from nose to rearward end of strake, in.	Approximate length, in.	Approximate width, in.
A-1L	Left side	0	7.38	7.38	0.175
A-1R	Right side	0	7.38	7.38	0.175
B-1L	Left side	8.97	20.97	12.00	0.250
B-1R	Right side	8.97	20.97	12.00	0.250
B-2L	Left side	10.87	20.97	10.10	0.250
B-2R	Right side	10.87	20.97	10.10	0.250

## (b) Nose slats

[Distance from nose to forward end of slat, 6.6 in.; distance from nose to rearward end of slat, 15.6 in.; approximate length, 9.0 in.; approximate distance between fuselage curvature and slat, 0.30 in.]

Slat	Location on fuselage	Approximate width, in.	Distance from top of slat to fuselage reference line, in.
S-1L	Left side	3.0	1.5
S-1R	Right side	3.0	1.5
S-2LT	Left side	1.5	0
S-2RT	Right side	1.5	0
S-2LB	Left side	1.5	1.5
S-2RB	Right side	1.5	1.5

TABLE III.- AERODYNAMIC COEFFICIENTS OF MODEL  
FOR THE COMPLETE INVESTIGATION

Configuration Code

First digit:

L  
9  
0  
5

Complete model . . . . .	1
Fuselage alone . . . . .	2
Horizontal tail off . . . . .	3
Lower rudder off . . . . .	4

Second digit (A and B considered to be part of second digit):\*

No strakes or slats . . . . .	0
A-1L and A-1R . . . . .	1
B-1L . . . . .	2
B-1R . . . . .	3
B-2L . . . . .	4
B-2R . . . . .	5
S-1L . . . . .	6
S-1R . . . . .	7
S-2LT . . . . .	8A
S-2RT . . . . .	8B
S-2LB . . . . .	9A
S-2RB . . . . .	9B

Third digit:

$\delta_H = 0^\circ$ . . . . .	0
$\delta_H = -4^\circ$ . . . . .	2
$\delta_H = -8^\circ$ . . . . .	4
$\delta_H = -35^\circ$ . . . . .	6
$\delta_H = +15^\circ$ . . . . .	7

For example, configuration 18B4 means:

1	Complete model
8B	S-2LB
0	$\delta_H = 0^\circ$

\*See table II for explanation of code for strakes and slats.

TABLE III. - AERODYNAMIC COEFFICIENTS OF MODEL FOR THE COMPLETE INVESTIGATION - Continued<sup>†</sup>

Config.	Run	Point	$\alpha_1$ , deg	$\beta$ , deg	q, lb/sq ft	$\alpha$ , deg	$\beta$ , deg	$C_N$	$C_A$	$C_m$	$C_i$	$C_n$	$C_y$
100	1	1	.00	.00	15.00	.00	.00	.0606-	.0336	.0410	.0011	.0068	.0061-
100	1	2	.00	.00	20.00	.00	.00	.0574-	.0334	.0389	.0011	.0036	.0058-
100	1	3	.00	.00	40.00	.00	.00	.0123-	.0312	.0165	.0010	.0027	.0019-
100	1	4	.00	.00	60.00	.00	.00	.0024-	.0308	.0111.	.0009	.0013	.0014-
100	1	5	.00	.00	100.00	.00	.00	.0083	.0312	.0057	.0007	.0009	.0017-
100	1	42	.00	.00	30.00	.00	.00	.0174	.0306	.0018	.0009	.0101	.0320-
100	2	6	10.00	.00	15.00	10.03	.00	.6306	.0360	.1345-	.0016	.0017	.0039
100	2	7	10.00	.00	20.00	10.04	.00	.6719	.0357	.1525-	.0009	.0008	.0063
100	2	8	10.00	.00	40.00	10.09	.00	.6919	.0333	.1677-	.0010	.0003	.0072
100	2	9	10.00	.00	60.00	10.15	.00	.7153	.0325	.1802-	.0008	.0007	.0018
100	2	10	10.00	.00	100.00	10.26	.00	.7322	.0327	.1882-	.0009	.0000	.0017
100	2	41	10.00	.00	30.00	10.07	.00	.7053	.0339	.1768-	.0007	.0079	.0242-
100	3	11	20.00	.00	15.00	20.08	.00	1.3895	.0238	.4532-	.0010	.0009	.0050
100	3	12	20.00	.00	20.00	20.10	.00	1.3989	.0257	.4915-	.0006	.0008-	.0106
100	3	13	20.00	.00	40.00	20.21	.00	1.4140	.0225	.4995-	.0007	.0025	.0015-
100	3	14	20.00	.00	60.00	20.32	.00	1.4395	.0220	.5126-	.0008	.0011	.0005-
100	3	15	20.00	.00	100.00	20.56	.00	1.5231	.0214	.5330-	.0005	.0002-	.0005
100	3	40	20.00	.00	30.00	20.16	.00	1.4269	.0116-	.5064-	.0002-	.0092	.0268-
100	4	16	30.00	.00	15.16	30.13	.00	2.3285	.0356-	.7217-	.0013	.0004-	.0002
100	4	17	30.00	.00	20.21	30.17	.00	2.2298	.0312-	.7666-	.0005	.0077	.0153
100	4	18	30.00	.00	40.42	30.33	.00	2.1873	.0317-	.8297-	.0006-	.0077-	.0058-
100	4	19	30.00	.00	60.64	30.50	.00	2.2187	.0323-	.8493-	.0013	.0002	.0050
100	4	20	30.00	.00	101.06	30.87	.00	2.3128	.0346-	.8619-	.0030	.0069-	.0287
100	4	39	30.00	.00	30.32	30.25	.00	2.2009	.0300	.8119-	.0018-	.0041	.0137-
100	5	21	40.00	.00	15.34	40.17	.00	3.0153	.0283-	.7051-	.0355-	.0319	.2980-
100	5	22	40.00	.00	20.45	40.22	.00	2.8667	.0351-	.7661-	.0146-	.0023-	.1731-
100	5	23	40.00	.00	40.90	40.41	.00	2.6921	.0307-	.9827-	.0098	.0045-	.0185-
100	5	24	40.00	.00	61.35	40.63	.00	2.7598	.0339-	1.0549-	.0021-	.0095	.0242
100	5	25	40.00	.00	102.25	41.07	.00	2.8251	.0357-	1.0618-	.0075-	.0009	.0567
100	5	38	40.00	.00	30.68	40.31	.00	2.7469	.0323-	.9305-	.0084	.0006	.0292-
100	6	26	50.00	.00	15.57	50.15	.00	2.6664	.0327-	.5950-	.0309-	.1426-	.2737-
100	6	27	50.00	.00	20.76	50.21	.00	2.6963	.0351-	.5926-	.0072	.1935-	.0072
100	6	28	50.00	.00	41.53	50.41	.00	2.6702	.0362-	.8958-	.0008	.0046-	.0108
100	6	29	50.00	.00	62.29	50.61	.00	2.6457	.0373-	.9508-	.0019	.0251	.0421
100	6	30	50.00	.00	103.82	51.04	.00	2.7070	.0387-	.9816-	.0020	.0149	.0479
100	6	37	50.00	.00	31.15	50.32	.00	2.7399	.0330-	.8634-	.0112	.0349-	.0733-
100	7	31	60.00	.00	15.83	60.17	.00	2.9237	.0271-	.6021-	.0036-	.1930-	.2409-
100	7	32	60.00	.00	21.10	60.22	.00	2.8646	.0364-	.7411-	.0019-	.1468-	.2218-
100	7	33	60.00	.00	42.20	60.43	.00	2.7430	.0386-	.9854-	.0018	.0227-	.0169-
100	7	34	60.00	.00	63.30	60.66	.00	2.8030	.0344-	1.0658-	.0024	.0345	.0594
100	7	36	60.00	.00	31.65	60.33	.00	2.7738	.0349-	.9312-	.0015	.0290-	.0490-
100	8	43	70.00	.00	16.13	70.18	.00	3.0646	.0306-	.9791-	.0047	.0997	.0510
100	8	44	70.00	.00	21.50	70.23	.00	2.9218	.0336-	.9896-	.0045	.1346	.1314
100	8	45	70.00	.00	32.25	70.34	.00	2.8308	.0309-	1.0860-	.0052	.1282	.1358
100	8	46	70.00	.00	43.00	70.45	.00	2.8319	.0307-	1.1646-	.0039	.0844	.0863
100	8	47	70.00	.00	64.50	70.69	.00	2.8827	.0336-	1.2436-	.0021	.0433	.0462
100	8	48	70.00	.00	107.50	71.14	.00	2.8697	.0372-	1.2748-	.0011	.0162	.0297
100	9	49	80.00	.00	16.22	80.19	.00	3.0305	.0372-	1.1701-	.0022	.0066	.0528-
100	9	50	80.00	.00	21.62	80.24	.00	3.0031	.0349-	1.1822-	.0026	.0028-	.0447
100	9	51	80.00	.00	32.43	80.36	.00	2.8820	.0333-	1.2750-	.0025	.0032-	.0262
100	9	52	80.00	.00	43.24	80.46	.00	2.8558	.0340-	1.3089-	.0028	.0114	.0043
100	9	53	80.00	.00	64.86	80.70	.00	2.8791	.0330-	1.3708-	.0019	.0069	.0117
100	9	54	80.00	.00	108.10	81.18	.00	2.9118	.0304-	1.4582-	.0013	.0185	.0389
100	10	55	90.00	.00	16.28	90.17	.00	2.8692	.0304	1.5946-	.0015	.0064	.0518-
100	10	56	90.00	.00	21.70	90.23	.00	2.8612	.0371	1.5922-	.0018	.0033	.0430
100	10	57	90.00	.00	32.55	90.33	.00	2.7745	.0321-	1.6099-	.0009	.0004-	.0213
100	10	58	90.00	.00	43.40	90.44	.00	2.7418	.0303-	1.6209-	.0012	.0068	.0065
100	10	59	90.00	.00	65.10	90.66	.00	2.7261	.0342-	1.6920-	.0002	.0137	.0076
100	10	60	90.00	.00	108.50	91.06	.00	2.6405	.0300-	1.6829-	.0003	.0125	.0790
100	11	61	10.00	10.00	15.00	9.87	1.73	.6079	.0355	.1279-	.0009-	.0143	.0421
100	11	62	10.00	10.00	20.00	9.89	1.74	.6447	.0348	.1522-	.0009-	.0145	.0427
100	11	63	10.00	10.00	30.00	9.91	1.74	.6486	.0341	.1501-	.0012-	.0151	.0441
100	11	64	10.00	10.00	40.00	9.94	1.75	.6605	.0323	.1584-	.0016-	.0143	.0424
100	11	65	10.00	10.00	60.00	9.99	1.75	.6885	.0318	.1717-	.0014-	.0151	.0472
100	11	66	10.00	10.00	100.00	10.10	1.77	.7159	.0313	.1827-	.0012-	.0138	.0439
100	12	67	20.00	10.00	15.00	19.79	3.41	1.2767	.0341	.4028-	.0012-	.0000	.0678-
100	12	68	20.00	10.00	20.00	19.82	3.42	1.3315	.0363	.4545-	.0017-	.0002	.0600
100	12	69	20.00	10.00	30.00	19.87	3.43	1.3432	.0339	.4732-	.0010	.0031-	.0585-
100	12	70	20.00	10.00	40.00	19.92	3.44	1.3603	.0332	.4784-	.0009	.0048-	.0583
100	12	71	20.00	10.00	60.00	20.03	3.45	1.4084	.0314	.4928-	.0001	.0067-	.0591-
100	12	72	20.00	10.00	100.00	20.24	3.49	1.4564	.0306	.5111-	.0007-	.0093-	.0605-

<sup>†</sup>Minus signs are to the right of the numbers to which they apply.

TABLE III. - AERODYNAMIC COEFFICIENTS OF MODEL FOR THE COMPLETE INVESTIGATION - Continued<sup>†</sup>

Config.	Run	Point	$\alpha_1$ , deg	$\beta$ , deg	q, lb/sq ft	$\alpha$ , deg	$\beta$ , deg	C <sub>N</sub>	C <sub>A</sub>	C <sub>m</sub>	C <sub>l</sub>	C <sub>n</sub>	C <sub>Y</sub>
100	13	73	30.00	10.00	15.16	29.74	5.00	2.2130	.0004-	.6875-	.0043	.0292-	.0198-
100	13	74	30.00	10.00	20.21	29.78	5.00	2.2001	.0007	.7368-	.0018-	.0287-	.0207-
100	13	75	30.00	10.00	30.32	29.86	5.01	2.1467	.0033	.8006-	.0025-	.0229-	.0180-
100	13	76	30.00	10.00	40.42	29.93	5.02	2.1121	.0028	.8124-	.0071-	.0157-	.0232-
100	13	77	30.00	10.00	60.64	30.10	5.05	2.1925	.0009-	.8408-	.0028-	.0215-	.0383-
100	13	78	30.00	10.00	101.06	30.43	5.10	2.2147	.0033-	.8284-	.0041-	.0237-	.0894-
100	14	79	40.00	10.00	15.34	39.71	6.43	2.7285	.0187-	.6844-	.0489-	.0867-	.2779-
100	14	80	40.00	10.00	20.45	39.76	6.43	2.7250	.0252-	.7605-	.0346-	.0487-	.1650-
100	14	81	40.00	10.00	30.68	39.86	6.45	2.7022	.0274-	.8917-	.0267-	.0444-	.0587-
100	14	82	40.00	10.00	40.90	39.94	6.46	2.5646	.0274-	.9860-	.0367-	.0216-	.0461-
100	14	83	40.00	10.00	61.35	40.16	6.49	2.6620	.0201-	1.0170-	.0291-	.0350-	.0276-
100	14	84	40.00	10.00	102.25	40.58	6.54	2.7406	.0127-	1.0230-	.0075-	.0567-	.0070-
100	15	85	50.00	10.00	15.57	49.72	7.66	2.6956	.0215-	.5099-	.0170-	.1886-	.4128-
100	15	86	50.00	10.00	20.76	49.78	7.66	2.7414	.0226-	.6503-	.0169-	.1848-	.3873-
100	15	87	50.00	10.00	31.15	49.86	7.67	2.5612	.0141-	.8532-	.0061	.1336-	.3226-
100	15	88	50.00	10.00	41.53	49.95	7.68	2.5268	.0169-	.8797-	.0054	.1002-	.2735-
100	15	89	50.00	10.00	62.29	50.15	7.71	2.5736	.0178-	.9332-	.0031	.0274-	.1569-
100	15	90	50.00	10.00	103.82	50.56	7.75	2.6161	.0208-	.9624-	.0013-	.0048-	.1261-
100	16	91	60.00	10.00	15.83	59.77	8.66	2.6321	.0155-	.7300-	.0136-	.1871-	.5107-
100	16	92	60.00	10.00	21.10	59.83	8.66	2.7726	.0286-	.8120-	.0137-	.1837-	.5246-
100	16	93	60.00	10.00	31.65	59.93	8.67	2.6632	.0308-	.8791-	.0136-	.1569-	.4670-
100	16	94	60.00	10.00	42.20	60.03	8.68	2.6672	.0359-	.9454-	.0126-	.0666-	.3196-
100	16	95	60.00	10.00	63.30	60.24	8.70	2.7040	.0436-	1.0186-	.0107-	.0405-	.1651-
100	16	96	60.00	10.00	105.50	60.67	8.74	2.7195	.0453-	1.0386-	.0117-	.0034-	.1977-
100	17	97	70.00	10.00	16.13	69.88	9.40	2.7005	.0261-	.8327-	.0161-	.0805-	.3760-
100	17	98	70.00	10.00	21.50	69.94	9.40	2.7614	.0312-	.9497-	.0162-	.1261-	.4472-
100	17	99	70.00	10.00	32.25	70.05	9.41	2.7866	.0350-	1.0716-	.0166-	.0433-	.2892-
100	17	100	70.00	10.00	43.00	70.15	9.41	2.7698	.0342-	1.1128-	.0154-	.0528	.1616-
100	18	103	80.00	10.00	16.22	80.03	9.85	2.9235	.0158-	1.1496-	.0121-	.0188	.2990-
100	18	104	80.00	10.00	21.62	80.09	9.85	2.9258	.0225-	1.1813-	.0123-	.0457	.2363-
100	18	105	80.00	10.00	32.43	80.19	9.85	2.7685	.0253-	1.1988-	.0127-	.0421	.2205-
100	18	106	80.00	10.00	43.24	80.29	9.86	2.7517	.0216-	1.2742-	.0140-	.0205	.2378-
100	18	107	80.00	10.00	64.86	80.52	9.86	2.7768	.0317-	1.3343-	.0154-	.0324	.2171-
100	18	108	80.00	10.00	108.10	81.00	9.88	2.8750	.0386-	1.4137-	.0150-	.0614	.1780-
100	19	109	90.00	10.00	16.28	90.17	10.00	2.8797	.0170	1.6486-	.0071-	.0218	.3409-
100	19	110	90.00	10.00	21.70	90.23	10.00	2.8496	.0103	1.6496-	.0073-	.0215	.2988-
100	19	111	90.00	10.00	32.55	90.32	10.00	2.7309	.0011-	1.6233-	.0073-	.0405	.2521-
100	19	112	90.00	10.00	43.40	90.44	10.00	2.7167	.0099-	1.6633-	.0077-	.0426	.2536-
100	19	113	90.00	10.00	65.10	90.68	10.00	2.8419	.0224-	1.7826-	.0091-	.0634	.2194-
100	19	114	90.00	10.00	108.50	91.05	10.00	2.6148	.0261-	1.6725-	.0081-	.0540	.1894-
100	20	115	10.00	20.00	15.00	9.43	3.41	.6449	.0358	.1624-	.0031-	.0266	.0787-
100	20	116	10.00	20.00	20.00	9.44	3.42	.6370	.0365	.1553-	.0026-	.0283	.0853-
100	20	117	10.00	20.00	30.00	9.46	3.43	.6552	.0341	.1628-	.0029-	.0290	.0884-
100	20	118	10.00	20.00	40.00	9.49	3.43	.6698	.0334	.1696-	.0029-	.0291	.0899-
100	20	119	10.00	20.00	60.00	9.53	3.45	.6828	.0326	.1784-	.0028-	.0285	.0883-
100	20	120	10.00	20.00	100.00	9.63	3.48	.7027	.0319	.1844-	.0029-	.0271	.0862-
100	21	121	20.00	20.00	15.00	18.95	6.74	1.3268	.0295	.4548-	.0022-	.0170	.1545-
100	21	122	20.00	20.00	20.00	18.97	6.74	1.3566	.0277	.4806-	.0018-	.0133	.1424-
100	21	123	20.00	20.00	30.00	19.01	6.76	1.3379	.0263	.4784-	.0014-	.0120	.1412-
100	21	124	20.00	20.00	40.00	19.06	6.78	1.3410	.0257	.4819-	.0005-	.0118	.1371-
100	21	125	20.00	20.00	60.00	19.16	6.81	1.3743	.0250	.4939-	.0014	.0093	.1344-
100	21	126	20.00	20.00	100.00	19.35	6.87	1.4091	.0237	.5030-	.0023	.0068	.1336-
100	22	127	30.00	20.00	15.16	28.59	9.88	2.1589	.0081	.7379-	.0163-	.0242-	.1506-
100	22	128	30.00	20.00	20.21	28.63	9.89	2.1259	.0095	.7605-	.0124-	.0307-	.1355-
100	22	129	30.00	20.00	30.32	28.69	9.91	2.1206	.0092	.7939-	.0033-	.0220-	.1457-
100	22	130	30.00	20.00	40.42	28.77	9.93	2.0999	.0076	.8100-	.0066-	.0220-	.1668-
100	22	131	30.00	20.00	60.64	28.93	9.98	2.1601	.0052	.8315-	.0034-	.0322-	.1933-
100	22	132	30.00	20.00	101.06	29.22	10.07	2.1727	.0027	.8268-	.0014	.0453-	.1964-
100	23	133	40.00	20.00	15.34	38.38	12.73	2.4009	.1033-	.6631-	.0210-	.1303-	.1509-
100	23	134	40.00	20.00	20.45	38.44	12.75	2.7347	.1159-	.8492-	.0164-	.1345-	.0512-
100	24	139	50.00	20.00	15.57	48.36	15.22	2.3621	.0039	.5569-	.0256-	.2084-	.3422-
100	24	140	50.00	20.00	20.76	48.40	15.23	2.2890	.0113	.6361-	.0143-	.1800-	.3157-

<sup>†</sup> Minus signs are to the right of the numbers to which they apply.

L-905

TABLE III. - AERODYNAMIC COEFFICIENTS OF MODEL FOR THE COMPLETE INVESTIGATION - Continued<sup>†</sup>

Config.	Run	Point	$\alpha_1$ , deg	$\beta$ , deg	$q$ , lb/sq ft	$\alpha$ , deg	$\beta$ , deg	$C_N$	$C_A$	$C_m$	$C_l$	$C_n$	$C_Y$
100	25	145	60.00	20.00	15.83	8.54	17.25	1.8888	.0409-	.4086-	.0208-	.1090-	.7580-
100	26	149	10.00	20.00	15.00	9.46	3.42-	1.0641	.0279	.4010-	.0164	.0531-	.0604
100	26	150	10.00	20.00	20.00	9.46	3.43-	.9830	.0329	.3474-	.0134	.0476-	.0729
100	26	151	10.00	20.00	30.00	9.49	3.43-	.8956	.0332	.2972-	.0104	.0412-	.0783
100	26	152	10.00	20.00	40.00	9.51	3.44-	.8312	.0317	.2635-	.0088	.0366-	.0756
100	26	153	10.00	20.00	60.00	9.55	3.46-	.7846	.0320	.2318-	.0076	.0334-	.0799
100	26	154	10.00	20.00	100.00	9.65	3.49-	.7567	.0321	.2145-	.0065	.0307-	.0803
100	27	155	20.00	20.00	15.00	18.97	6.74-	1.7568	.0226	.6877-	.0139	.0378-	.1241
100	27	156	20.00	20.00	20.00	18.99	6.75-	1.6495	.0248	.6383-	.0121	.0368-	.1266
100	27	157	20.00	20.00	30.00	19.03	6.77-	1.5657	.0249	.5974-	.0085	.0221-	.1279
100	27	158	20.00	20.00	40.00	19.07	6.78-	1.4587	.0246	.5461-	.0071	.0203-	.1282
100	27	159	20.00	20.00	60.00	19.17	6.81-	1.4348	.0243	.5354-	.0045	.0177-	.1308
100	27	160	20.00	20.00	100.00	19.36	6.88-	1.4602	.0234	.5299-	.0024	.0119-	.1275
100	28	161	30.00	20.00	15.16	28.61	9.88-	2.5441	.0011	.9348-	.0225	.0141-	.1028
100	28	162	30.00	20.00	20.21	28.65	9.89-	2.4550	.0063	.9172-	.0240	.0079-	.1218
100	28	163	30.00	20.00	30.32	28.71	9.92-	2.3098	.0098	.9001-	.0190	.0052	.1234
100	28	164	30.00	20.00	40.42	28.79	9.94-	2.2418	.0092	.8817-	.0122	.0054	.1352
100	28	165	30.00	20.00	60.64	28.94	9.98-	2.2407	.0008	.9413-	.0029	.0212	.1561
100	28	166	30.00	20.00	101.06	29.24	10.08-	2.2083	.0032	.8467-	.0033	.0335	.0207
100	29	167	40.00	20.00	15.34	38.40	12.74-	2.7214	.0365-	.8169-	.0123	.0772	.1987
100	29	168	40.00	20.00	20.45	38.44	12.75-	2.6707	.0121-	.8396-	.0111	.0831	.1348
100	29	169	40.00	20.00	30.68	38.53	12.77-	2.6413	.0102	.8921-	.0176	.0719	.0093-
100	29	170	40.00	20.00	40.90	38.60	12.79-	2.4935	.0006-	.9149-	.0234	.0434	.0291
100	29	171	40.00	20.00	61.35	38.79	12.85-	2.5603	.0041-	.9934-	.0359	.0361	.0929
100	29	172	40.00	20.00	102.25	39.24	12.97-	2.8102	.0020-	1.0683-	.0526	.0804	.1224
100	30	173	50.00	20.00	15.57	48.58	15.22-	2.7453	.0002	.7866-	.0198	.1827	.2729
100	30	174	50.00	20.00	20.76	48.42	15.23-	2.5608	.0095	.8098-	.0138	.1683	.0209
100	30	175	50.00	20.00	31.15	48.51	15.25-	2.5156	.0047-	.8164-	.0150	.0893	.0315
100	30	176	50.00	20.00	41.53	48.60	15.27-	2.4931	.0076-	.8741-	.0155	.0796	.0386
100	30	177	50.00	20.00	62.29	48.77	15.31-	2.4624	.0089-	.8844-	.0170	.0386	.2895
100	30	178	50.00	20.00	103.82	49.12	15.39-	2.4467	.0057-	.9248-	.0370	.0230	.2741
100	31	179	60.00	20.00	15.83	58.58	17.25-	2.6055	.0241-	.8698-	.0243	.1866	.6932
100	31	180	60.00	20.00	21.10	58.62	17.26-	2.4899	.0294-	.8615-	.0225	.1925	.6406
100	31	181	60.00	20.00	31.65	58.72	17.28-	2.5203	.0331-	.9303-	.0217	.1614	.6721
100	31	182	60.00	20.00	42.20	58.81	17.30-	2.4859	.0333-	.9721-	.0211	.1305	.6408
100	31	183	60.00	20.00	63.30	59.1	17.33-	2.5206	.0341-	.9643-	.0214	.0129	.6954
100	31	184	60.00	20.00	105.50	59.41	17.40-	2.5743	.0344-	1.0492-	.0243	.0392-	.6434
100	32	185	70.00	20.00	16.13	68.98	18.77-	2.6488	.0256-	.9189-	.0260	.0445	.5517
100	32	186	70.00	20.00	21.50	69.02	18.77-	2.5686	.0329-	1.0103-	.0253	.0922	.6599
100	32	187	70.00	20.00	32.25	69.12	18.78-	2.4750	.0311-	1.1098-	.0246	.1228	.6842
100	32	188	70.00	20.00	43.00	69.21	18.79-	2.5010	.0299-	1.1653-	.0263	.0352	.5861
100	32	189	70.00	20.00	64.50	69.41	18.82-	2.5015	.0390-	1.1723-	.0269	.0062-	.5446
100	32	190	70.00	20.00	107.50	69.84	18.87-	2.5848	.0516-	1.1988-	.0269	.0520-	.5037
100	33	191	80.00	20.00	16.22	79.54	19.69-	2.6570	.0314	1.3264-	.0192	.0605-	.4052
100	33	192	80.00	20.00	21.62	79.58	19.70-	2.5878	.0223	1.2712-	.0193	.0568-	.4134
100	33	193	80.00	20.00	32.43	79.68	19.70-	2.5465	.0109	1.3549-	.0189	.0356-	.4585
100	33	194	80.00	20.00	43.24	79.77	19.71-	2.4426	.0003	1.3268-	.0204	.0407-	.4626
100	33	195	80.00	20.00	64.86	79.98	19.72-	2.5322	.0101-	1.4353-	.0195	.0726-	.4351
100	33	196	80.00	20.00	108.10	80.43	19.74-	2.6412	.0226-	1.5450-	.0201	.1056-	.4082
100	34	197	90.00	20.00	16.28	90.16	20.00-	2.6744	.0205	1.5016-	.0202	.0734-	.4282
100	34	198	90.00	20.00	21.70	90.21	20.00-	2.5882	.0127	1.4916-	.0195	.0579-	.4434
100	34	199	90.00	20.00	32.55	90.31	20.00-	2.5525	.0021	1.5416-	.0194	.0436-	.4812
100	34	200	90.00	20.00	43.40	90.40	20.00-	2.5277	.0061-	1.5703-	.0195	.0486-	.4972
100	34	201	90.00	20.00	65.10	90.59	20.00-	2.4918	.0136-	1.5889-	.0182	.0703-	.4668
100	34	202	90.00	20.00	108.50	91.20	20.00-	3.0039	.0306-	1.9225-	.0181	.1215-	.4410
100	35	203	10.00	30.00	15.00	8.70	4.99-	.5825	.0392	.1375-	.0059	.0350-	.1183
100	35	204	10.00	30.00	20.00	8.71	5.00-	.5980	.0363	.1514-	.0061	.0370-	.1201
100	35	205	10.00	30.00	30.00	8.73	5.01-	.5966	.0362	.1479-	.0057	.0368-	.1186
100	35	206	10.00	30.00	40.00	8.74	5.02-	.5982	.0354	.1511-	.0059	.0375-	.1175
100	35	207	10.00	30.00	60.00	8.78	5.04-	.6208	.0351	.1607-	.0057	.0390-	.1200
100	35	208	10.00	30.00	100.00	8.85	5.08-	.6365	.0351	.1655-	.0059	.0396-	.1211
100	36	209	20.00	30.00	15.00	17.55	9.87-	1.2175	.0286	.4160-	.0023	.0320-	.2110
100	36	210	20.00	30.00	20.00	17.56	9.88-	1.2629	.0283	.4432-	.0019	.0314-	.1998
100	36	211	20.00	30.00	30.00	17.60	9.90-	1.2431	.0273	.4388-	.0019	.0320-	.2073
100	36	212	20.00	30.00	40.00	17.64	9.92-	1.2506	.0276	.4412-	.0010	.0321-	.2083
100	36	213	20.00	30.00	60.00	17.71	9.96-	1.2618	.0256	.4427-	.0011	.0347-	.2137
100	36	214	20.00	30.00	100.00	17.86	10.04-	1.2852	.0257	.4489-	.0004-	.0320-	.2106

<sup>†</sup> Minus signs are to the right of the numbers to which they apply.



TABLE III. - AERODYNAMIC COEFFICIENTS OF MODEL FOR THE COMPLETE INVESTIGATION - Continued<sup>†</sup>

Config.	Run	Point	$\alpha_1$ , deg	$\beta$ , deg	q, lb/sq ft	$\alpha$ , deg	$\beta$ , deg	$C_N$	$C_A$	$C_m$	$C_l$	$C_n$	$C_Y$
100	37	215	30.00	30.00	15.16	26.65	14.52	1.9247	.0141	.6563-	.0002-	.0426	.2112
100	37	216	30.00	30.00	20.21	26.69	14.53	1.9882	.0159	.7087-	.0005	.0328	.2340
100	37	217	30.00	30.00	30.32	26.74	14.56	1.9419	.0173	.7190-	.0026-	.0478	.2334
100	37	218	30.00	30.00	40.42	26.80	14.59	1.8973	.0151	.7256-	.0024-	.0456	.2654
100	37	219	30.00	30.00	60.64	26.91	14.64	1.9274	.0147	.7503-	.0013-	.0311	.3079
100	37	220	30.00	30.00	101.06	27.15	14.76	1.9547	.0119	.7561-	.0040	.0328	.3248
100	38	221	40.00	30.00	15.34	36.12	18.80	2.6133	.0166	.8323-	.0379	.1010	1.1484
100	38	222	40.00	30.00	20.45	36.15	18.81	2.9030	.0154	.8497-	.0373	.0878	1.3392
100	38	223	40.00	30.00	30.68	36.23	18.85	2.4349	.0165	.8536-	.0474	.0413	1.2570
100	38	224	40.00	30.00	40.90	36.31	18.88	2.4210	.0098	.8667-	.0504	.0668	1.4256
100	38	225	40.00	30.00	61.35	36.49	18.95	2.5790	.0028	1.0092-	.0678	.0824	1.2576
100	38	226	40.00	30.00	102.25	36.84	19.10	2.6488	.0011-	1.0367-	.0840	.0941	1.5050
100	39	227	50.00	30.00	15.57	46.02	22.57	2.4909	.0164	.8750-	.0276	.0865	.4835
100	39	228	50.00	30.00	20.76	46.06	22.58	2.4319	.0150	.8093-	.0304	.0539	.4580
100	39	229	50.00	30.00	31.15	46.13	22.60	2.3167	.0155	.7432-	.0294	.0053-	.4073
100	39	230	50.00	30.00	41.53	46.21	22.63	2.3251	.0093	.8522-	.0206	.0442-	.4109
100	39	231	50.00	30.00	62.29	46.38	22.69	2.3434	.0026	.9600-	.0298	.0075	.4346
100	39	232	50.00	30.00	103.82	46.67	22.79	2.2676	.0018-	.9096-	.0256	.0039-	.4735
100	40	233	60.00	30.00	15.83	56.44	25.69	2.3106	.0399-	.8134-	.0341	.1479	.8085
100	40	234	60.00	30.00	21.10	56.47	25.70	2.2799	.0384-	.8492-	.0302	.1336	.7814
100	40	235	60.00	30.00	31.65	56.56	25.73	2.2666	.0349-	.9689-	.0276	.1269	.7981
100	40	236	60.00	30.00	42.20	56.65	25.75	2.3340	.0317-	.9754-	.0264	.0558	.6893
100	40	237	60.00	30.00	63.30	56.80	25.79	2.2681	.0302-	.9520-	.0272	.0043-	.6148
100	40	238	60.00	30.00	105.50	57.15	25.88	2.3335	.0418-	.9453-	.0321	.0432-	.5935
100	41	239	70.00	30.00	16.13	67.33	28.05	2.3178	.0256-	.9494-	.0280	.0820	.7054
100	41	240	70.00	30.00	21.50	67.37	28.06	2.2283	.0317-	1.1002-	.0249	.1544	.7900
100	41	241	70.00	30.00	32.25	67.44	28.07	2.1712	.0269-	1.1844-	.0256	.1381	.7538
100	42	245	80.00	30.00	16.22	78.65	29.51	2.4306	.0281	1.2462-	.0347	.0971-	.6102
100	42	246	80.00	30.00	21.62	78.68	29.52	2.3678	.0243	1.2294-	.0342	.0898-	.5971
100	42	247	80.00	30.00	32.43	78.77	29.53	2.2824	.0028	1.3513-	.0340	.0257-	.6979
100	42	248	80.00	30.00	43.24	78.84	29.53	2.1576	.0042	1.3445-	.0331	.0245-	.6714
100	42	249	80.00	30.00	64.86	79.03	29.55	2.2498	.0096-	1.3490-	.0355	.1021-	.5829
100	42	250	80.00	30.00	108.10	79.39	29.58	2.2634	.0114-	1.3802-	.0204	.1037-	.6221
100	43	251	90.00	30.00	16.28	90.15	30.00	2.4979	.0300	1.3968-	.0379	.1383-	.5684
100	43	252	90.00	30.00	21.70	90.20	30.00	2.3808	.0298	1.3682-	.0377	.1277-	.5841
100	43	253	90.00	30.00	32.55	90.26	30.00	2.2787	.0068	1.4039-	.0351	.1024-	.6149
100	43	254	90.00	30.00	43.40	90.36	30.00	2.1995	.0058-	1.4428-	.0352	.0893-	.6309
100	43	255	90.00	30.00	65.10	90.53	30.00	2.2075	.0200-	1.4476-	.0344	.1330-	.5854
100	43	256	90.00	30.00	108.50	90.88	30.00	2.1887	.0299-	1.4716-	.0346	.1342-	.6230
100	44	257	10.00	40.00	15.00	7.70	6.42	.5864	.0285	.1667-	.0043	.0581-	.1589
100	44	258	10.00	40.00	20.00	7.71	6.42	.5686	.0283	.1624-	.0041	.0569-	.1649
100	44	259	10.00	40.00	30.00	7.73	6.44	.5497	.0277	.1522-	.0042	.0576-	.1656
100	44	260	10.00	40.00	40.00	7.73	6.44	.5535	.0288	.1525-	.0036	.0576-	.1660
100	44	261	10.00	40.00	60.00	7.76	6.47	.5596	.0293	.1508-	.0048	.0586-	.1702
100	44	262	10.00	40.00	100.00	7.81	6.51	.5599	.0299	.1508-	.0049	.0582-	.1683
100	45	263	20.00	40.00	15.00	15.61	12.73	1.1156	.0143	.3941-	.0079	.0822-	.3339
100	45	264	20.00	40.00	20.00	15.62	12.74	1.1352	.0163	.3953-	.0082	.0852-	.3496
100	45	265	20.00	40.00	30.00	15.66	12.76	1.1221	.0169	.3942-	.0064	.0808-	.3353
100	45	266	20.00	40.00	40.00	15.68	12.78	1.1029	.0168	.3876-	.0055	.0785-	.3306
100	45	267	20.00	40.00	60.00	15.73	12.82	1.1045	.0165	.3920-	.0051	.0770-	.3274
100	45	268	20.00	40.00	100.00	15.83	12.90	1.1144	.0172	.3917-	.0039	.0734-	.3224
100	46	269	30.00	40.00	15.16	23.93	18.80	1.7502	.0016	.6445-	.0005	.0348-	.4529
100	46	270	30.00	40.00	20.21	23.95	18.81	1.7857	.0014	.6740-	.0012	.0278-	.4655
100	46	271	30.00	40.00	30.32	23.99	18.84	1.6861	.0007	.6580-	.0056	.0181-	.4556
100	46	272	30.00	40.00	40.42	24.02	18.86	1.6504	.0008-	.6705-	.0067	.0230-	.4693
100	46	273	30.00	40.00	60.64	24.10	18.91	1.6453	.0008	.6697-	.0007	.0251-	.4710
100	46	274	30.00	40.00	101.06	24.26	19.02	1.6504	.0021	.6693-	.0003	.0170-	.4729
100	47	275	40.00	40.00	15.34	32.81	24.46	2.1546	.0034-	.7545-	.0695	.0284	.4979
100	47	276	40.00	40.00	20.45	32.85	24.48	2.2117	.0050-	.8045-	.0690	.0135	.5007
100	47	277	40.00	40.00	30.68	32.91	24.52	2.2726	.0062-	.8586-	.0751	.0218	.4926
100	47	278	40.00	40.00	40.90	32.97	24.55	2.2482	.0085-	.8839-	.0810	.0154	.5101
100	47	279	40.00	40.00	61.35	33.09	24.62	2.2694	.0089-	.9374-	.0961	.0023	.5430
100	47	280	40.00	40.00	102.25	33.34	24.76	2.2747	.0164-	.9835-	.0943	.0355	.5767
100	48	281	50.00	40.00	15.57	42.50	29.55	2.3509	.0224-	.7936-	.0298	.0231-	.5342
100	48	282	50.00	40.00	20.76	42.53	29.56	2.2465	.0166-	.7191-	.0275	.0614-	.4851
100	48	283	50.00	40.00	31.15	42.60	29.60	2.2264	.0127-	.7885-	.0259	.0496-	.5062
100	48	284	50.00	40.00	41.53	42.65	29.62	2.1060	.0101-	.7812-	.0260	.0531-	.5224
100	48	285	50.00	40.00	62.29	42.79	29.69	2.2195	.0168-	.8916-	.0390	.0421-	.5281
100	48	286	50.00	40.00	103.82	43.02	29.79	2.0822	.0176-	.8530-	.0335	.0297-	.5037

<sup>†</sup>Minus signs are to the right of the numbers to which they apply.

506-T

TABLE III - AERODYNAMIC COEFFICIENTS OF MODEL FOR THE COMPLETE INVESTIGATION - Continued<sup>†</sup>

Config.	Run	Point	$\alpha_1$ , deg	$\beta$ , deg	$q$ , lb/sq ft	$\alpha$ , deg	$\beta$ , deg	$C_N$	$C_A$	$C_m$	$C_l$	$C_n$	$C_Y$
100	49	287	10.00	50.00-	15.00	6.47	7.66-	.4658	.6274	.1072-	.0046	.0709-	.1914
100	49	288	10.00	50.00-	20.00	6.47	7.66-	.4704	.6290	.1105-	.0043	.0712-	.1905
100	49	289	10.00	50.00-	30.00	6.48	7.66-	.4536	.6279	.1188-	.0041	.0679-	.1888
100	49	290	10.00	50.00-	40.00	6.49	7.67-	.4483	.6290	.1099-	.0043	.0698-	.1951
100	49	291	10.00	50.00-	60.00	6.50	7.69-	.4548	.6301	.1131-	.0044	.0725-	.1996
100	49	292	10.00	50.00-	100.00	6.53	7.72-	.4682	.6304	.1202-	.0044	.0730-	.2010
100	50	293	20.00	50.00-	15.00	13.18	15.21-	.9107	.0138	.3017-	.0137	.1449-	.4647
100	50	294	20.00	50.00-	20.00	13.19	15.22-	.8886	.0148	.2905-	.0137	.1413-	.4570
100	50	295	20.00	50.00-	30.00	13.20	15.23-	.8842	.0147	.2904-	.0129	.1362-	.4546
100	50	296	20.00	50.00-	40.00	13.22	15.25-	.8619	.0139	.2792-	.0126	.1305-	.4413
100	50	297	20.00	50.00-	60.00	13.25	15.29-	.8831	.0144	.2908-	.0121	.1306-	.4458
100	50	298	20.00	50.00-	100.00	13.31	15.34-	.8923	.0149	.2932-	.0118	.1306-	.4400
100	51	299	30.00	50.00-	15.16	20.40	22.56-	1.3587	.0001-	.5140-	.0251	.1671-	.7132
100	51	300	30.00	50.00-	20.21	20.41	22.57-	1.3851	.0017-	.5413-	.0207	.1603-	.7054
100	51	301	30.00	50.00-	30.32	20.44	22.59-	1.3374	.0024-	.5390-	.0142	.1466-	.6821
100	51	302	30.00	50.00-	40.42	20.46	22.62-	1.3568	.0044-	.5655-	.0079	.1397-	.7047
100	51	303	30.00	50.00-	60.64	20.51	22.67-	1.3644	.0065-	.5858-	.0046	.1344-	.7279
100	51	304	30.00	50.00-	101.06	20.60	22.75-	1.3473	.0063-	.5816-	.0062	.1301-	.7188
100	52	305	40.00	50.00-	15.34	28.40	29.55-	1.7973	.0134-	.7161-	.0972	.1630-	.8908
100	52	306	40.00	50.00-	20.45	28.42	29.56-	1.8359	.0086-	.7665-	.1057	.1638-	.9194
100	52	307	40.00	50.00-	30.68	28.45	29.59-	1.7697	.0124-	.7522-	.1024	.1576-	.8786
100	52	308	40.00	50.00-	40.90	28.49	29.62-	1.7550	.0118-	.7704-	.1039	.1559-	.8777
100	52	309	40.00	50.00-	61.35	28.56	29.68-	1.7582	.0127-	.8338-	.0983	.1546-	.9120
100	52	310	40.00	50.00-	102.25	28.70	29.78-	1.7067	.0169-	.8594-	.0895	.1422-	.9479
100	53	311	10.00	60.00-	15.00	5.04	8.65-	.3459	.0370	.0829-	.0045	.0879-	.2386
100	53	312	10.00	60.00-	20.00	5.04	8.65-	.3745	.0375	.0979-	.0041	.0909-	.2501
100	53	313	10.00	60.00-	30.00	5.04	8.66-	.3329	.0336	.0834-	.0046	.0834-	.2293
100	53	314	10.00	60.00-	40.00	5.05	8.67-	.3449	.0336	.0883-	.0025	.0852-	.2311
100	53	315	10.00	60.00-	60.00	5.05	8.68-	.3560	.0337	.0928-	.0028	.0869-	.2352
100	53	316	10.00	60.00-	100.00	5.06	8.70-	.3467	.0331	.0862-	.0029	.0854-	.2304
100	54	317	20.00	60.00-	15.00	10.32	17.25-	.6642	.0153	.2122-	.0116	.1909-	.5564
100	54	318	20.00	60.00-	20.00	10.32	17.26-	.6886	.0161	.2229-	.0110	.1911-	.5596
100	54	319	20.00	60.00-	30.00	10.33	17.26-	.6878	.0158	.2222-	.0108	.1865-	.5569
100	54	320	20.00	60.00-	40.00	10.34	17.27-	.6617	.0150	.2105-	.0101	.1813-	.5438
100	54	321	20.00	60.00-	60.00	10.35	17.29-	.6651	.0149	.2113-	.0100	.1817-	.5491
100	54	322	20.00	60.00-	100.00	10.38	17.34-	.6759	.0171	.2167-	.0054	.1811-	.5530
100	55	323	30.00	60.00-	15.16	16.12	25.69-	.9671	.0034	.3779-	.0235	.2528-	.8521
100	55	324	30.00	60.00-	20.21	16.12	25.69-	1.0028	.0036	.4023-	.0230	.2530-	.8436
100	55	325	30.00	60.00-	30.32	16.14	25.71-	1.0102	.0036	.4239-	.0206	.2523-	.8612
100	55	326	30.00	60.00-	40.42	16.14	25.72-	.9705	.0041	.4174-	.0179	.2443-	.8432
100	55	327	30.00	60.00-	60.64	16.17	25.75-	.9699	.0001-	.4300-	.0108	.2408-	.8523
100	55	328	30.00	60.00-	101.06	16.21	25.81-	.9768	.0013	.4379-	.0119	.2382-	.8587
100	56	329	40.00	60.00-	15.34	22.79	33.86-	1.3148	.0114-	.5465-	.0911	.2844-	1.0527
100	56	330	40.00	60.00-	20.45	22.80	33.87-	1.2733	.0068-	.5378-	.0867	.2986-	1.0840
100	56	331	40.00	60.00-	30.68	22.81	33.88-	1.2387	.0031-	.5624-	.0906	.2969-	1.0639
100	56	332	40.00	60.00-	40.90	22.83	33.90-	1.2130	.0003	.5954-	.0915	.3006-	1.0838
100	56	333	40.00	60.00-	61.35	22.86	33.94-	1.2021	.0020	.6423-	.0958	.3036-	1.1203
100	56	334	40.00	60.00-	102.25	22.94	34.02-	1.2608	.0007-	.6705-	.1028	.2961-	1.1149
100	57	335	5.00	70.00-	15.00	1.71	4.70-	.1611	.0428	.0497-	.0005	.0536-	.1270
100	57	336	5.00	70.00-	20.00	1.71	4.70-	.1578	.0424	.0478-	.0006	.0512-	.1193
100	57	337	5.00	70.00-	30.00	1.71	4.70-	.1377	.0440	.0365-	.0006	.0511-	.1219
100	57	338	5.00	70.00-	40.00	1.71	4.70-	.1279	.0397	.0390-	.0006	.0499-	.1200
100	57	339	5.00	70.00-	60.00	1.71	4.70-	.1225	.0416	.0333-	.0004	.0497-	.1224
100	57	340	5.00	70.00-	100.00	1.72	4.71-	.1236	.0411	.0317-	.0006	.0479-	.1210
100	58	341	10.00	70.00-	15.00	3.45	9.39-	.2442	.0375	.0689-	.0006	.1005-	.2549
100	58	342	10.00	70.00-	20.00	3.45	9.40-	.2450	.0377	.0659-	.0011	.1021-	.2626
100	58	343	10.00	70.00-	30.00	3.45	9.40-	.2467	.0371	.0702-	.0015	.0959-	.2495
100	58	344	10.00	70.00-	40.00	3.45	9.40-	.2344	.0370	.0619-	.0017	.0966-	.2507
100	58	345	10.00	70.00-	60.00	3.45	9.41-	.2358	.0361	.0639-	.0014	.0954-	.2496
100	58	346	10.00	70.00-	100.00	3.46	9.42-	.2358	.0365	.0617-	.0017	.0955-	.2500
100	59	347	20.00	70.00-	15.00	7.09	18.76-	.4908	.0162	.1788-	.0011	.2545-	.6555
100	59	348	20.00	70.00-	20.00	7.09	18.76-	.4560	.0158	.1667-	.0005	.2439-	.6292
100	59	349	20.00	70.00-	30.00	7.10	18.77-	.4458	.0162	.1669-	.0003	.2393-	.6242
100	59	350	20.00	70.00-	40.00	7.10	18.77-	.4540	.0163	.1673-	.0001-	.2402-	.6332
100	59	351	20.00	70.00-	60.00	7.10	18.78-	.4452	.0170	.1595-	.0005	.2393-	.6394
100	59	352	20.00	70.00-	100.00	7.11	18.80-	.4436	.0171	.1592-	.0001-	.2210-	.6320
100	60	353	30.00	70.00-	15.16	11.17	28.04-	.5778	.0075	.2364-	.0100	.3036-	.9279
100	60	354	30.00	70.00-	20.21	11.17	28.05-	.6090	.0084	.2628-	.0076	.3171-	.9373
100	60	355	30.00	70.00-	30.32	11.17	28.05-	.5966	.0096	.2719-	.0075	.3145-	.9234
100	60	356	30.00	70.00-	40.42	11.18	28.05-	.5806	.0097	.2728-	.0068	.3074-	.9122
100	60	357	30.00	70.00-	60.64	11.18	28.06-	.5715	.0097	.2776-	.0068	.3084-	.9236
100	60	358	30.00	70.00-	101.06	11.20	28.09-	.5604	.0096	.2792-	.0055	.3010-	.9241

<sup>†</sup> Minus signs are to the right of the numbers to which they apply.

TABLE III. - AERODYNAMIC COEFFICIENTS OF MODEL FOR THE COMPLETE INVESTIGATION - Continued<sup>†</sup>

Config.	Run	Point	$\alpha_1$ , deg	$\beta$ , deg	q, lb/sq ft	$\alpha$ , deg	$\beta$ , deg	C <sub>N</sub>	C <sub>A</sub>	C <sub>m</sub>	C <sub>l</sub>	C <sub>n</sub>	C <sub>y</sub>
100	61	359	40.00	70.00-	15.34	16.01	37.17-	.7664	.0106	.3136-	.0644	.3411-	1.1909
100	61	360	40.00	70.00-	20.45	16.02	37.18-	.7295	.0161	.3177-	.0546	.3496-	1.1655
100	61	361	40.00	70.00-	30.68	16.03	37.19-	.7485	.0191	.3810-	.0496	.3456-	1.1690
100	61	362	40.00	70.00-	40.90	16.03	37.19-	.6369	.0212	.3483-	.0488	.3250-	1.1256
100	61	363	40.00	70.00-	61.35	16.03	37.20-	.5285	.0216	.3311-	.0531	.3173-	1.1289
100	61	364	40.00	70.00-	102.25	16.05	37.22-	.5485	.0224	.3285-	.0551	.3192-	1.1216
100	62	359	5.00	80.00-	15.00	.87	4.92-	.0804	.0431	.0175-	.0015-	.0658-	.1713
100	62	360	5.00	80.00-	20.00	.87	4.92-	.0859	.0434	.0234-	.0010-	.0597-	.1605
100	62	361	5.00	80.00-	30.00	.87	4.92-	.0803	.0432	.0243-	.0005-	.0595-	.1506
100	62	362	5.00	80.00-	40.00	.87	4.92-	.0725	.0433	.0200-	.0006-	.0554-	.1411
100	62	363	5.00	80.00-	60.00	.87	4.92-	.0641	.0424	.0173-	.0004-	.0537-	.1371
100	62	364	5.00	80.00-	100.00	.87	4.92-	.0655	.0425	.0165-	.0002-	.0518-	.1336
100	63	365	10.00	80.00-	15.00	1.75	9.84-	.1464	.0397	.0407-	.0015-	.1132-	.3005
100	63	366	10.00	80.00-	20.00	1.75	9.84-	.1467	.0394	.0409-	.0012-	.1071-	.2816
100	63	367	10.00	80.00-	30.00	1.75	9.84-	.1385	.0396	.0403-	.0010-	.1045-	.2739
100	63	368	10.00	80.00-	40.00	1.75	9.84-	.1280	.0394	.0355-	.0008-	.1028-	.2699
100	63	369	10.00	80.00-	60.00	1.75	9.84-	.1214	.0398	.0335-	.0005-	.1030-	.2687
100	63	370	10.00	80.00-	100.00	1.75	9.85-	.1214	.0393	.0337-	.0003-	.1010-	.2628
100	64	371	20.00	80.00-	15.00	3.61	19.69-	.2381	.0255	.0986-	.0087-	.2855-	.6973
100	64	372	20.00	80.00-	20.00	3.61	19.69-	.2528	.0238	.1108-	.0087-	.2751-	.6709
100	64	373	20.00	80.00-	30.00	3.61	19.69-	.2236	.0247	.0972-	.0081-	.2729-	.6703
100	64	374	20.00	80.00-	40.00	3.61	19.69-	.2171	.0239	.0969-	.0083-	.2642-	.6540
100	64	375	20.00	80.00-	60.00	3.61	19.69-	.2090	.0238	.0910-	.0084-	.2666-	.6645
100	64	376	20.00	80.00-	100.00	3.61	19.69-	.2051	.0239	.0881-	.0085-	.2675-	.6697
100	65	377	30.00	80.00-	15.16	5.72	29.50-	.2503	.0249	.1048-	.0082-	.3515-	1.0130
100	65	378	30.00	80.00-	20.21	5.72	29.50-	.2551	.0263	.1156-	.0095-	.3590-	.9652
100	65	379	30.00	80.00-	30.32	5.72	29.50-	.2400	.0247	.1324-	.0098-	.3750-	.9795
100	65	380	30.00	80.00-	40.42	5.72	29.51-	.2327	.0232	.1507-	.0121-	.3657-	.9712
100	65	381	30.00	80.00-	60.64	5.72	29.51-	.2088	.0240	.1583-	.0147-	.3642-	.9859
100	65	382	30.00	80.00-	101.06	5.72	29.51-	.1692	.0233	.1386-	.0170-	.3475-	.9656
100	66	383	40.00	80.00-	15.34	8.29	39.27-	.2730	.0237	.0999-	.0296	.3394-	1.2370
100	66	384	40.00	80.00-	20.45	8.29	39.27-	.2554	.0293	.0826-	.0194	.3388-	1.1720
100	66	385	40.00	80.00-	30.68	8.29	39.27-	.2250	.0336	.1112-	.0128	.3550-	1.1528
100	66	386	40.00	80.00-	40.90	8.29	39.27-	.1884	.0308	.1525-	.0040	.3536-	1.1316
100	66	387	40.00	80.00-	61.35	8.29	39.27-	.1220	.0288	.2126-	.0016	.3594-	1.1529
100	66	388	40.00	80.00-	102.25	8.29	39.28-	.0975	.0306	.2001-	.0017	.3592-	1.1854
100	67	389	2.50	90.00-	15.00	.00	2.50-	.0282	.0458	.0130-	.0012	.0293-	.0553
100	67	390	2.50	90.00-	20.00	.00	2.50-	.0204	.0457	.0093-	.0004	.0250-	.0421
100	67	400	2.50	90.00-	30.00	.00	2.50-	.0123	.0444	.0122-	.0006	.0276-	.0557
100	67	401	2.50	90.00-	40.00	.00	2.50-	.0100	.0441	.0075-	.0004	.0241-	.0574
100	67	402	2.50	90.00-	60.00	.00	2.50-	.0053	.0445	.0082-	.0002	.0257-	.0560
100	67	403	2.50	90.00-	100.00	.00	2.50-	.0079	.0446	.0083-	.0001-	.0246-	.0593
100	68	404	5.00	90.00-	15.00	.00	5.00-	.0057-	.0461	.0034	.0006	.0527-	.1303
100	68	405	5.00	90.00-	20.00	.00	5.00-	.0051-	.0467	.0031	.0002	.0523-	.1303
100	68	406	5.00	90.00-	30.00	.00	5.00-	.0043	.0427	.0021-	.0003-	.0518-	.1304
100	68	407	5.00	90.00-	40.00	.00	5.00-	.0044-	.0431	.0017-	.0000	.0484-	.1222
100	68	408	5.00	90.00-	60.00	.00	5.00-	.0086	.0443	.0052-	.0004	.0493-	.1225
100	68	409	5.00	90.00-	100.00	.00	5.00-	.0035	.0439	.0058-	.0005-	.0501-	.1244
100	69	410	7.50	90.00-	15.00	.00	7.50-	.0065-	.0442	.0041	.0005-	.0745-	.1849
100	69	411	7.50	90.00-	20.00	.00	7.50-	.0064-	.0463	.0041	.0009-	.0786-	.1958
100	69	412	7.50	90.00-	30.00	.00	7.50-	.0033	.0441	.0027-	.0011-	.0769-	.1958
100	69	413	7.50	90.00-	40.00	.00	7.50-	.0075	.0443	.0057-	.0010-	.0757-	.1918
100	69	414	7.50	90.00-	60.00	.00	7.50-	.0033	.0434	.0034-	.0011-	.0748-	.1904
100	69	415	7.50	90.00-	100.00	.00	7.50-	.0027	.0429	.0022-	.0012-	.0753-	.1924
100	70	416	10.00	90.00-	15.00	.00	10.00-	.0078-	.0468	.0050	.0012-	.1065-	.2715
100	70	417	10.00	90.00-	20.00	.00	10.00-	.0069-	.0451	.0046	.0023-	.1042-	.2612
100	70	418	10.00	90.00-	30.00	.00	10.00-	.0107	.0426	.0093-	.0020-	.1030-	.2615
100	70	419	10.00	90.00-	40.00	.00	10.00-	.0065	.0417	.0060-	.0023-	.1017-	.2574
100	70	420	10.00	90.00-	60.00	.00	10.00-	.0109	.0424	.0087-	.0024-	.1026-	.2589
100	70	421	10.00	90.00-	100.00	.00	10.00-	.0012	.0414	.0041-	.0020-	.1013-	.2580
100	71	422	15.00	90.00-	15.00	.00	15.00-	.0113-	.0423	.0023	.0050-	.1735-	.4259
100	71	423	15.00	90.00-	20.00	.00	15.00-	.0105-	.0428	.0012	.0059-	.1716-	.4185
100	71	424	15.00	90.00-	30.00	.00	15.00-	.0083	.0397	.0141-	.0057-	.1670-	.4156
100	71	425	15.00	90.00-	40.00	.00	15.00-	.0094-	.0385	.0026-	.0054-	.1647-	.4097
100	71	426	15.00	90.00-	60.00	.00	15.00-	.0052-	.0383	.0045-	.0055-	.1695-	.4232
100	71	427	15.00	90.00-	100.00	.00	15.00-	.0127-	.0376	.0009-	.0057-	.1719-	.4261
100	72	428	20.00	90.00-	15.00	.00	20.00-	.0166-	.0355	.0125-	.0131-	.2814-	.6604
100	72	429	20.00	90.00-	20.00	.00	20.00-	.0173-	.0338	.0121-	.0135-	.2814-	.6528
100	72	430	20.00	90.00-	30.00	.00	20.00-	.0146-	.0320	.0162-	.0142-	.2779-	.6555
100	72	431	20.00	90.00-	40.00	.00	20.00-	.0200-	.0307	.0155-	.0144-	.2726-	.6445
100	72	432	20.00	90.00-	60.00	.00	20.00-	.0300-	.0313	.0103-	.0143-	.2777-	.6681
100	72	433	20.00	90.00-	100.00	.00	20.00-	.0404-	.0311	.0051-	.0145-	.2768-	.6710

<sup>†</sup>Minus signs are to the right of the numbers to which they apply.

L-905

TABLE III. - AERODYNAMIC COEFFICIENTS OF MODEL FOR THE COMPLETE INVESTIGATION - Continued<sup>†</sup>

Config.	Run	Point	$\alpha$ , deg	$\beta$ , deg	q, lb/sq ft	$\alpha$ , deg	$\beta$ , deg	C <sub>N</sub>	C <sub>A</sub>	C <sub>m</sub>	C <sub>l</sub>	C <sub>n</sub>	C <sub>y</sub>
100	73	434	25.00	90.00-	15.00	.00	25.00-	.0584-	.0353	.0040-	.0203-	.3407-	.8558
100	73	435	25.00	90.00-	20.00	.00	25.00-	.0613-	.0357	.0023-	.0225-	.3508-	.8505
100	73	436	25.00	90.00-	30.00	.00	25.00-	.0581-	.0336	.0145-	.0259-	.3581-	.8662
100	73	437	25.00	90.00-	40.00	.00	25.00-	.0702-	.0323	.0051-	.0257-	.3470-	.8399
100	73	438	25.00	90.00-	60.00	.00	25.00-	.0809-	.0325	.0045-	.0259-	.3455-	.8489
100	73	439	25.00	90.00-	100.00	.00	25.00-	.1054-	.0306	.0014-	.0271-	.3404-	.8500
100	74	440	30.00	90.00-	15.16	.00	30.00-	.1000-	.0342	.00382	.0152-	.3366-	.9540
100	74	441	30.00	90.00-	20.21	.00	30.00-	.1292-	.0385	.0050	.0176-	.3592-	.9831
100	74	442	30.00	90.00-	30.32	.00	30.00-	.0985-	.0371	.0192	.0231-	.3783-	.9695
100	74	443	30.00	90.00-	40.42	.00	30.00-	.1038-	.0347	.0034-	.0270-	.3835-	.9715
100	74	444	30.00	90.00-	60.64	.00	30.00-	.1408-	.0321	.0062-	.0318-	.3930-	.9984
100	74	445	30.00	90.00-	101.06	.00	30.00-	.1957-	.0306	.0096-	.0326-	.3851-	1.0167
100	75	446	40.00	15.00-	15.34	39.18	9.61-	2.9298	.0521-	.8125-	.0556	.0685	.1680
100	75	447	40.00	15.00-	20.45	39.23	9.62-	2.8506	.0408-	.8516-	.0325	.0619	.1516
100	75	448	40.00	15.00-	30.68	39.33	9.64-	2.7864	.0231-	.9375-	.0140	.0599	.0374-
100	75	449	40.00	15.00-	40.90	39.40	9.65-	2.6119	.0220-	.9412-	.0291	.0451	.0043-
100	75	450	40.00	15.00-	61.35	39.59	9.69-	2.5969	.0222-	.9849-	.0365	.0385	.0114
100	75	451	40.00	15.00-	102.25	39.99	9.77-	2.6483	.0156-	.9770-	.0153	.0721	.0275
100	76	452	50.00	15.00-	15.57	49.18	11.46-	2.8262	.0354-	.6552-	.0238	.1720	.3631
100	76	453	50.00	15.00-	20.76	49.23	11.47-	2.8515	.0355-	.7534-	.0239	.1772	.3148
100	76	454	50.00	15.00-	31.15	49.30	11.48-	2.5445	.0236-	.8332-	.0045	.1163	.3640
100	76	455	50.00	15.00-	41.53	49.40	11.50-	2.5741	.0259-	.8839-	.0059	.1002	.3284
100	76	456	50.00	15.00-	62.29	49.58	11.53-	2.5294	.0248-	.8879-	.0109	.0768	.2767
100	76	457	50.00	15.00-	103.82	49.97	11.59-	2.5485	.0230-	.9137-	.0125	.0388	.2252
100	77	458	60.00	15.00-	15.83	59.29	12.97-	2.8517	.0432-	.8946-	.0217	.2250	.6296
100	77	459	60.00	15.00-	21.10	59.34	12.98-	2.7287	.0476-	.8590-	.0186	.2148	.6158
100	77	460	60.00	15.00-	31.65	59.45	12.99-	2.7352	.0539-	.9420-	.0194	.2130	.6531
100	77	461	60.00	15.00-	42.20	59.53	13.00-	2.5773	.0513-	.9177-	.0194	.1598	.5577
100	77	462	60.00	15.00-	63.30	59.74	13.03-	2.6510	.0529-	.9710-	.0185	.0438	.4190
100	77	463	60.00	15.00-	105.50	60.15	13.08-	2.6486	.0498-	.9907-	.0195	.0072-	.3385
100	78	464	70.00	15.00-	16.13	69.53	14.09-	2.9538	.0495-	.9915-	.0233	.0854	.4344
100	78	465	70.00	15.00-	21.50	69.58	14.09-	2.8106	.0501-	1.0313-	.0240	.1309	.5071
100	78	466	70.00	15.00-	32.25	69.66	14.10-	2.6380	.0460-	1.0942-	.0227	.1439	.5497
100	78	467	70.00	15.00-	43.00	69.77	14.11-	2.6558	.0439-	1.1616-	.0228	.0552	.4499
100	78	468	70.00	15.00-	64.50	69.98	14.13-	2.6432	.0506-	1.1802-	.0226	.0027	.3837
100	78	469	70.00	15.00-	107.50	70.44	14.17-	2.7618	.0630-	1.2365-	.0230	.0258-	.3433
100	79	470	80.00	15.00-	16.22	79.84	14.77-	2.9603	.0273-	1.2168-	.0217	.0114-	.3082
100	79	471	80.00	15.00-	21.62	79.89	14.78-	2.8343	.0159-	1.2171-	.0168	.0054-	.3104
100	79	472	80.00	15.00-	32.43	79.99	14.78-	2.7412	.0229-	1.2245-	.0198	.0000	.3423
100	79	473	80.00	15.00-	43.24	80.08	14.78-	2.6533	.0085-	1.4147-	.0124	.0408-	.3017
100	79	474	80.00	15.00-	64.86	80.30	14.79-	2.6548	.0192-	1.4810-	.0126	.0632-	.3124
100	79	475	80.00	15.00-	108.10	80.72	14.81-	2.6720	.0310-	1.4889-	.0153	.0768-	.3194
100	80	476	90.00	15.00-	16.28	90.18	15.00-	2.9087	.0049-	1.7219-	.0083	.0067-	.3531
100	80	477	90.00	15.00-	21.70	90.22	15.00-	2.7364	.0057-	1.6379-	.0079	.0125-	.3592
100	80	478	90.00	15.00-	32.55	90.32	15.00-	2.6712	.0112-	1.6140-	.0085	.0510-	.3544
100	80	479	90.00	15.00-	43.40	90.43	15.00-	2.6810	.0203-	1.6722-	.0085	.0578-	.3317
100	80	480	90.00	15.00-	65.10	90.66	15.00-	2.7285	.0321-	1.7422-	.0091	.0830-	.3322
100	80	481	90.00	15.00-	108.50	91.09	15.00-	2.7177	.0383-	1.8024-	.0085	.0959-	.3301
100	81	482	30.00	5.00-	15.16	30.03	2.51-	2.3427	.0174-	.7473-	.0012-	.0236	.0428
100	81	483	30.00	5.00-	20.21	30.08	2.51-	2.4039	.0181-	.8129-	.0008-	.0264	.0417
100	81	484	30.00	5.00-	30.32	30.15	2.52-	2.4432	.0159-	.8313-	.0001	.0102	.0234
100	81	485	30.00	5.00-	40.42	30.23	2.52-	2.2115	.0116-	.8336-	.0024	.0072	.0101
100	81	486	30.00	5.00-	60.64	30.40	2.53-	2.2033	.0109-	.8344-	.0004	.0111	.0086
100	81	487	30.00	5.00-	101.06	30.75	2.56-	2.2681	.0138-	.8407-	.0018-	.0155	.0245
100	82	488	40.00	5.00-	15.34	40.07	3.22-	3.1040	.0500-	.8043-	.0040-	.0190	.1031-
100	82	489	40.00	5.00-	20.45	40.12	3.23-	3.0071	.0449-	.8686-	.0103	.0039	.0691-
100	82	490	40.00	5.00-	30.68	40.22	3.23-	2.8806	.0429-	.9478-	.0273	.0105	.0128
100	82	491	40.00	5.00-	40.90	40.30	3.24-	2.7023	.0381-	.9676-	.0278	.0026-	.0208
100	82	492	40.00	5.00-	61.35	40.52	3.25-	2.8023	.0411-	1.0584-	.0252	.0004	.0067
100	82	493	40.00	5.00-	102.25	40.90	3.28-	2.6808	.0288-	.9915-	.0060-	.0217	.0301
100	83	494	50.00	5.00-	15.57	50.06	3.84-	2.8758	.0195-	.7223-	.0018-	.0258-	.0548
100	83	495	50.00	5.00-	20.76	50.12	3.84-	2.9530	.0406-	.6759-	.0256	.0049	.0355
100	83	496	50.00	5.00-	31.15	50.21	3.84-	2.7689	.0382-	.8722-	.0051-	.0587	.1839
100	83	497	50.00	5.00-	41.53	50.31	3.85-	2.7520	.0381-	.9415-	.0001-	.1055	.2023
100	83	498	50.00	5.00-	62.29	50.51	3.86-	2.6848	.0336-	.9892-	.0038-	.0833	.1683
100	83	499	50.00	5.00-	103.82	50.90	3.88-	2.5998	.0319-	.9649-	.0025-	.0363	.1060

<sup>†</sup> Minus signs are to the right of the numbers to which they apply.

TABLE III. - AERODYNAMIC COEFFICIENTS OF MODEL FOR THE COMPLETE INVESTIGATION - Continued<sup>†</sup>

Config.	Run	Point	$\alpha_1$ , deg	$\beta$ , deg	q, lb/sq ft	$\alpha$ , deg	$\beta$ , deg	C <sub>N</sub>	C <sub>A</sub>	C <sub>m</sub>	C <sub>L</sub>	C <sub>n</sub>	C <sub>y</sub>
100	84	500	60.00	5.00-	15.83	60.07	4.33-	2.8512	.0517-	.6951-	.0108	.2131	.3942
100	84	501	60.00	5.00-	21.10	60.13	4.34-	2.9441	.0614-	.8547-	.0127	.2176	.4555
100	84	502	60.00	5.00-	31.65	60.23	4.34-	2.8083	.0579-	.9048-	.0105	.1740	.3611
100	84	503	60.00	5.00-	42.20	60.33	4.34-	2.7533	.0573-	.9815-	.0105	.1309	.2958
100	84	504	60.00	5.00-	63.30	60.54	4.35-	2.7595	.0572-	1.0319-	.0081	.0175	.1311
100	84	505	60.00	5.00-	105.50	60.99	4.37-	2.8064	.0590-	1.0508-	.0069	.0394-	.0491
100	85	506	70.00	5.00-	16.13	70.11	4.70-	3.0066	.0582-	.9627-	.0122	.1264	.2652
100	85	507	70.00	5.00-	21.50	70.16	4.70-	2.9351	.0566-	1.0345-	.0141	.1748	.3485
100	85	508	70.00	5.00-	32.25	70.27	4.71-	2.8156	.0492-	1.0930-	.0115	.1475	.2985
100	85	509	70.00	5.00-	43.00	70.38	4.71-	2.8278	.0473-	1.1726-	.0122	.0858	.2185
100	85	510	70.00	5.00-	64.50	70.60	4.71-	2.8151	.0523-	1.2083-	.0111	.0394	.1475
100	85	511	70.00	5.00-	107.50	71.06	4.73-	2.8423	.0552-	1.2578-	.0100	.0164	.1198
100	86	512	80.00	5.00-	16.22	80.15	4.92-	3.0592	.0383-	1.1596-	.0104	.0058-	.0973
100	86	513	80.00	5.00-	21.62	80.20	4.92-	2.8704	.0388-	1.1160-	.0095	.0063-	.0827
100	86	514	80.00	5.00-	32.43	80.32	4.93-	2.9144	.0429-	1.2712-	.0100	.0126-	.0884
100	86	515	80.00	5.00-	43.24	80.42	4.93-	2.8145	.0386-	1.2714-	.0102	.0175-	.0913
100	86	516	80.00	5.00-	64.86	80.66	4.93-	2.8950	.0470-	1.3847-	.0105	.0215-	.0947
100	86	517	80.00	5.00-	108.10	81.11	4.94-	2.8644	.0554-	1.4277-	.0084	.0193-	.1008
100	176	1051	60.00	.00	15.83	60.18	.00	3.0775	.0589-	.7584-	.0035	.1274	.1554
100	176	1052	60.00	.00	21.10	60.22	.00	2.8456	.0559-	.7587-	.0052	.1182	.1938
100	176	1053	60.00	.00	31.65	60.33	.00	2.8107	.0530-	.9273-	.0032	.1241	.1755
100	176	1054	60.00	.00	42.20	60.44	.00	2.8241	.0550-	1.0273-	.0027	.0647	.0892
100	176	1055	60.00	.00	63.30	60.66	.00	2.8046	.0584-	1.0720-	.0020	.0408	.0590
100	177	1057	70.00	.00	16.13	70.18	.00	3.0738	.0426-	.9626-	.0021	.0674	.0854
100	177	1058	70.00	.00	21.50	70.24	.00	2.9591	.0463-	1.0007-	.0017	.1244	.1570
100	177	1059	70.00	.00	32.25	70.35	.00	2.8902	.0463-	1.0966-	.0027	.1336	.1776
100	177	1060	70.00	.00	43.00	70.46	.00	2.9080	.0470-	1.1934-	.0030	.0781	.0967
100	177	1061	70.00	.00	64.50	70.69	.00	2.8800	.0501-	1.2374-	.0013	.0440	.0591
100	177	1062	70.00	.00	107.50	71.15	.00	2.8883	.0541-	1.2790-	.0013	.0164	.0265
100	178	1063	80.00	.00	16.22	80.20	.00	3.1020	.0286-	1.1955-	.0016	.0001-	.0515
100	178	1064	80.00	.00	21.62	80.24	.00	3.0466	.0272-	1.2045-	.0009	.0042-	.0240
100	178	1065	80.00	.00	32.43	80.36	.00	2.9563	.0332-	1.3127-	.0018	.0008	.0127
100	178	1066	80.00	.00	43.24	80.46	.00	2.8575	.0364-	1.3039-	.0013	.0110	.0167
100	178	1067	80.00	.00	64.86	80.70	.00	2.8924	.0464-	1.3730-	.0013	.0098	.0164
100	178	1068	80.00	.00	108.10	81.16	.00	2.8819	.0523-	1.4366-	.0007	.0211	.0506
100	179	1069	60.00	5.00	15.83	60.08	4.33	3.0021	.0497-	.6386-	.0017-	.1997	.1569
100	179	1070	60.00	5.00	21.10	60.13	4.34	2.9489	.0531-	.7635-	.0028-	.0500	.0212-
100	179	1071	60.00	5.00	31.65	60.21	4.34	2.6967	.0466-	.8686-	.0062-	.0713-	.2035-
100	179	1072	60.00	5.00	42.20	60.33	4.34	2.7757	.0516-	1.0005-	.0049-	.0115	.0681-
100	179	1073	60.00	5.00	63.30	60.54	4.35	2.7292	.0549-	1.0303-	.0059-	.0153-	.0989-
100	179	1074	60.00	5.00	105.50	60.98	4.37	2.7725	.0597-	1.0355-	.0043-	.0036	.0718-
100	180	1075	70.00	5.00	16.13	70.11	4.70	2.9920	.0339-	.9165-	.0064-	.0680	.0114
100	180	1076	70.00	5.00	21.50	70.16	4.70	2.9208	.0432-	.9387-	.0056-	.0376	.0500-
100	180	1077	70.00	5.00	32.25	70.26	4.70	2.7820	.0388-	1.0887-	.0103-	.1093-	.2185-
100	180	1078	70.00	5.00	43.00	70.38	4.71	2.8356	.0461-	1.1231-	.0068-	.0590	.0015-
100	180	1079	70.00	5.00	64.50	70.60	4.71	2.8290	.0448-	1.2159-	.0091-	.0735-	.1637-
100	180	1080	70.00	5.00	107.50	71.06	4.73	2.8603	.0544-	1.2747-	.0084-	.0305-	.1080-
100	181	1081	80.00	5.00	16.22	80.15	4.92	2.9385	.0215-	1.1037-	.0064-	.0090-	.0858-
100	181	1082	80.00	5.00	21.62	80.20	4.92	2.8775	.0302-	1.1373-	.0067-	.0176	.0455-
100	181	1083	80.00	5.00	32.43	80.30	4.93	2.7580	.0292-	1.2077-	.0065-	.0041	.0735-
100	181	1084	80.00	5.00	43.24	80.43	4.93	2.8853	.0359-	1.3235-	.0075-	.0129	.0791-
100	181	1085	80.00	5.00	64.86	80.64	4.93	2.8122	.0434-	1.3370-	.0071-	.0159	.0741-
100	181	1086	80.00	5.00	108.10	81.08	4.94	2.7840	.0526-	1.3759-	.0054-	.0367	.0430-
100	182	1087	60.00	10.00-	15.83	59.78	8.66-	2.7334	.0441-	.7525-	.0169	.1813	.4946
100	182	1088	60.00	10.00-	21.10	59.84	8.67-	2.8144	.0536-	.8171-	.0157	.1832	.5344
100	182	1089	60.00	10.00-	31.65	59.94	8.67-	2.7809	.0517-	.8650-	.0138	.0513	.3479
100	182	1090	60.00	10.00-	42.20	60.04	8.68-	2.7091	.0545-	.9386-	.0163	.0426	.3095
100	182	1091	60.00	10.00-	63.30	60.24	8.70-	2.6935	.0577-	.9858-	.0127	.0167-	.2225
100	182	1092	60.00	10.00-	105.50	60.67	8.74-	2.7202	.0597-	1.0074-	.0128	.0339-	.1759
100	183	1093	70.00	10.00-	16.13	69.89	9.40-	2.9077	.0552-	.9279-	.0196	.0931	.4115
100	183	1094	70.00	10.00-	21.50	69.94	9.40-	2.8421	.0548-	.9884-	.0178	.1248	.4755
100	183	1095	70.00	10.00-	32.25	70.05	9.41-	2.8230	.0483-	1.0626-	.0172	.0043	.2622
100	183	1096	70.00	10.00-	43.00	70.15	9.41-	2.7405	.0491-	1.0820-	.0168	.0237-	.2281
100	183	1097	70.00	10.00-	64.50	70.36	9.43-	2.7413	.0564-	1.1807-	.0179	.0163-	.2254
100	183	1098	70.00	10.00-	107.50	70.63	9.45-	2.7941	.0664-	1.2257-	.0182	.0021	.2443
100	184	1099	80.00	10.00-	16.22	80.03	9.85-	2.8801	.0379-	1.0968-	.0153	.0110-	.2739
100	184	1100	80.00	10.00-	21.62	80.08	9.85-	2.8252	.0437-	1.1001-	.0165	.0019	.2472
100	184	1101	80.00	10.00-	32.43	80.20	9.85-	2.8356	.0412-	1.2212-	.0154	.0398-	.2310
100	184	1102	80.00	10.00-	43.24	80.30	9.86-	2.7832	.0432-	1.2682-	.0150	.0488-	.2194
100	184	1103	80.00	10.00-	64.86	80.52	9.86-	2.7904	.0508-	1.3238-	.0173	.0598-	.2173
100	184	1104	80.00	10.00-	108.10	80.97	9.88-	2.7816	.0574-	1.3741-	.0154	.0468-	.2156

<sup>†</sup>Minus signs are to the right of the numbers to which they apply.

I-905

TABLE III - AERODYNAMIC COEFFICIENTS OF MODEL FOR THE COMPLETE INVESTIGATION - Continued<sup>†</sup>

Config.	Run	Point	$\alpha_1$ , deg	$\phi$ , deg	$q$ , lb/sq ft	$\alpha$ , deg	$\beta$ , deg	$C_N$	$C_A$	$C_m$	$C_l$	$C_n$	$C_Y$
100	185	1105	60.00	15.00	15.83	59.30	12.97	2.9501	.0354-	.7940-	.0213-	.1074-	.4826-
100	185	1106	60.00	15.00	21.10	59.34	12.98	2.7669	.0308-	.8366-	.0189-	.1574-	.5741-
100	185	1107	60.00	15.00	31.65	59.43	12.99	2.6929	.0422-	.8833-	.0182-	.1799-	.6129-
100	185	1108	60.00	15.00	42.20	59.54	13.00	2.6372	.0472-	.9070-	.0180-	.0936-	.4791-
100	185	1109	60.00	15.00	63.30	59.74	13.03	2.6296	.0495-	1.0081-	.0187-	.1085-	.4949-
100	185	1110	60.00	15.00	105.50	60.14	13.08	2.6336	.0540-	1.0315-	.0181-	.0345-	.3691-
100	186	1111	70.00	15.00	16.13	69.51	14.09	2.8092	.0436-	.9240-	.0206-	.0555-	.4836-
100	186	1112	70.00	15.00	21.50	69.58	14.09	2.9176	.0928-	.9692-	.0232-	.0575-	.4186-
100	187	1117	80.00	15.00	16.22	79.82	14.77	2.7730	.0244-	1.1358-	.0171-	.0257	.3419-
100	187	1118	80.00	15.00	21.62	79.88	14.78	2.7338	.0234-	1.1509-	.0168-	.0188	.3464-
100	187	1119	80.00	15.00	32.43	79.98	14.78	2.7033	.0403-	1.2207-	.0170-	.0297	.3534-
100	187	1120	80.00	15.00	43.24	80.09	14.79	2.7230	.0238-	1.4013-	.0164-	.0358	.3477-
100	187	1121	80.00	15.00	64.86	80.29	14.79	2.6417	.0242-	1.4790-	.0139-	.0364	.3208-
100	187	1122	80.00	15.00	108.10	80.74	14.81	2.7030	.0439-	1.5119-	.0156-	.0885	.2548-
100	188	1123	60.00	20.00	15.83	58.58	17.25	2.6076	.0499-	.7935-	.0219-	.1975-	.6761-
100	188	1124	60.00	20.00	21.10	58.63	17.26	2.6531	.0323-	.8657-	.0210-	.1891-	.7009-
100	188	1125	60.00	20.00	31.65	58.72	17.28	2.5703	.0581-	.9838-	.0200-	.2536-	.8178-
100	188	1126	60.00	20.00	42.20	58.81	17.30	2.5039	.0387-	.9487-	.0208-	.1890-	.7141-
100	188	1127	60.00	20.00	63.30	59.00	17.33	2.4959	.0447-	.9760-	.0202-	.0684-	.5487-
100	188	1128	60.00	20.00	105.50	59.39	17.39	2.5559	.0465-	1.0360-	.0219-	.0175-	.4693-
100	189	1129	70.00	20.00	16.13	68.98	18.77	2.6949	.0582-	.7637-	.0231-	.0234	.4011-
100	189	1130	70.00	20.00	21.50	69.03	18.77	2.6559	.0438-	.8611-	.0234-	.0040-	.5012-
100	189	1131	70.00	20.00	32.25	69.13	18.78	2.5465	.0388-	1.0516-	.0238-	.0953-	.6291-
100	189	1132	70.00	20.00	43.00	69.21	18.79	2.4443	.0390-	1.0201-	.0241-	.0200-	.5430-
100	189	1133	70.00	20.00	64.50	69.43	18.82	2.5742	.0518-	1.0526-	.0259-	.1148	.3909-
100	189	1134	70.00	20.00	107.50	69.84	18.87	2.5872	.0700-	1.1283-	.0259-	.1094	.3969-
100	190	1135	80.00	20.00	16.22	79.54	19.69	2.6123	.0058	1.2955-	.0192-	.0202	.3943-
100	190	1136	80.00	20.00	21.62	79.59	19.70	2.6141	.0101	1.2994-	.0177-	.0276	.4230-
100	190	1137	80.00	20.00	32.43	79.67	19.70	2.5146	.0017-	1.3582-	.0175-	.0119-	.4744-
100	190	1138	80.00	20.00	43.24	79.78	19.71	2.5443	.0075-	1.4172-	.0190-	.0024	.4844-
100	190	1139	80.00	20.00	64.86	79.99	19.72	2.5885	.0175-	1.5117-	.0197-	.0309	.4565-
100	190	1140	80.00	20.00	108.10	80.41	19.74	2.5886	.0328-	1.4947-	.0198-	.0833	.3795-
100	285	1526	80.00	15.00	16.22	79.82	14.77	2.7170	.0197-	1.1057-	.0179	.0459-	.3650
100	285	1527	80.00	15.00	108.10	80.73	14.81	2.6863	.0332-	1.5861-	.0132	.0590-	.3626
100	286	1528	80.00	15.00	16.22	79.84	14.77	2.9346	.0069-	1.2760-	.0147-	.0345	.3565-
100	286	1529	80.00	15.00	108.10	80.75	14.81	2.7489	.0308-	1.4922-	.0163-	.0878	.2695-
100	287	1530	80.00	15.00	16.22	79.84	14.77	2.8856	.0097-	1.1796-	.0180	.0320-	.3815
100	287	1531	80.00	15.00	21.62	79.88	14.78	2.7563	.0306-	1.1274-	.0205	.0447-	.3528
100	287	1532	80.00	15.00	32.43	79.99	14.78	2.7212	.0398-	1.1404-	.0192	.1827-	.2023
100	287	1533	80.00	15.00	43.24	80.08	14.78	2.6568	.0487-	1.3389-	.0169	.1331-	.2200
100	287	1534	80.00	15.00	64.86	80.29	14.79	2.6304	.0180-	1.3713-	.0131	.0988-	.2779
100	287	1535	80.00	15.00	108.10	80.72	14.81	2.6679	.0411-	1.4755-	.0152	.0831-	.3137
100	288	1534	70.00	15.00	16.13	69.51	14.09	2.8070	.0520-	.8279-	.0197	.0217-	.3297
100	288	1535	70.00	15.00	21.50	69.57	14.09	2.7797	.0457-	.9218-	.0228	.0121-	.3713
100	288	1536	70.00	15.00	32.25	69.68	14.10	2.7594	.0415-	1.0544-	.0075	.0825-	.2496
100	288	1537	70.00	15.00	43.00	69.77	14.11	2.6653	.0487-	1.0962-	.0216	.0713-	.2825
100	288	1538	70.00	15.00	64.50	70.00	14.13	2.7191	.0606-	1.2193-	.0204	.0106-	.3751
100	288	1539	70.00	15.00	107.50	70.43	14.17	2.7413	.0716-	1.2174-	.0229	.0308-	.3560
100	294	1545	70.00	15.00	16.13	69.53	14.09	2.9123	.0433-	.9500-	.0219-	.0262	.3653-
100	314	1617	.00	.00	100.00	.00	.00	.0127	.0444	.0005-	.0004	.0018-	.0052
100	314	1618	2.00	.00	100.00	2.00	.00	.1394	.0420	.0226-	.0004	.0004-	.0033
100	314	1619	4.00	.00	100.00	4.00	.00	.2790	.0377	.0520-	.0006	.0006-	.0044
100	314	1620	6.00	.00	100.00	6.15	.00	.4292	.0336	.0900-	.0004	.0010-	.0063
100	314	1621	8.00	.00	100.00	8.20	.00	.5795	.0301	.1353-	.0002	.0013-	.0073
100	314	1622	10.00	.00	100.00	10.26	.00	.7401	.0271	.1942-	.0001	.0011-	.0059
102	315	1623	.00	.00	100.00	.00	.00	.0433-	.0474	.0841	.0003	.0018-	.0058
102	315	1624	2.00	.00	100.00	2.00	.00	.0860	.0446	.0585	.0004	.0010-	.0056
102	315	1625	4.00	.00	100.00	4.00	.00	.2253	.0396	.0289	.0006	.0009-	.0069
102	315	1626	6.00	.00	100.00	6.13	.00	.3697	.0344	.0008-	.0005	.0010-	.0066
102	315	1627	8.00	.00	100.00	8.18	.00	.5191	.0305	.0399-	.0007	.0015-	.0069
102	315	1628	10.00	.00	100.00	10.24	.00	.6668	.0264	.0895-	.0004	.0011-	.0053

<sup>†</sup>Minus signs are to the right of the numbers to which they apply.

TABLE III. - AERODYNAMIC COEFFICIENTS OF MODEL FOR THE COMPLETE INVESTIGATION - Continued<sup>†</sup>

Config.	Run	Point	$\alpha_1$ , deg	$\beta$ , deg	q, lb/sq ft	$\alpha$ , deg	$\beta$ , deg	C <sub>N</sub>	C <sub>A</sub>	C <sub>m</sub>	C <sub>l</sub>	C <sub>n</sub>	C <sub>y</sub>
104	316	1629	.00	.00	100.00	.05-	.00	.1274-	.0577	.2024	.0015-	.0039-	.0068
104	316	1630	2.00	.00	100.00	2.00	.00	.0069	.0535	.1699	.0016-	.0027-	.0055
104	316	1631	4.00	.00	100.00	4.05	.00	.1490	.0480	.1405	.0016-	.0018-	.0056
104	316	1632	6.00	.00	100.00	6.10	.00	.2986	.0419	.0996	.0013-	.0018-	.0055
104	316	1633	8.00	.00	100.00	8.15	.00	.4453	.0368	.0612	.0009-	.0013-	.0042
104	316	1634	10.00	.00	100.00	10.21	.00	.5951	.0323	.0145	.0010-	.0015-	.0037
106	191	1141	.00	.00	15.00	.02-	.00	.3728-	.2203	.5428	.0017	.0021-	.0118
106	191	1142	.00	.00	20.00	.03-	.00	.3995-	.2196	.5588	.0020	.0018-	.0149
106	191	1143	.00	.00	30.00	.04-	.00	.3666-	.2184	.5362	.0019	.0025-	.0142
106	191	1144	.00	.00	40.00	.05-	.00	.3642-	.2118	.5256	.0026	.0041-	.0144
106	191	1145	.00	.00	60.00	.08-	.00	.3522-	.2084	.5144	.0027	.0030-	.0089
106	191	1146	.00	.00	100.00	.13-	.00	.3382-	.2079	.5025	.0033	.0026-	.0091
106	192	1147	5.00	.00	15.00	4.99	.00	.1321-	.2161	.5841	.0009	.0117-	.0503
106	192	1148	5.00	.00	20.00	4.99	.00	.1172-	.2136	.5674	.0014	.0073-	.0336
106	192	1149	5.00	.00	30.00	4.99	.00	.1002-	.2050	.5334	.0011	.0049-	.0241
106	192	1150	5.00	.00	40.00	4.99	.00	.0868-	.1938	.5075	.0018	.0027-	.0119
106	192	1151	5.00	.00	60.00	4.97	.00	.0736-	.2017	.5196	.0020	.0025-	.0119
106	192	1152	5.00	.00	100.00	4.97	.00	.0565-	.1987	.5085	.0027	.0016-	.0087
106	193	1153	10.00	.00	15.00	10.01	.00	.2295	.1835	.4904	.0002	.0084-	.0331
106	193	1154	10.00	.00	20.00	10.01	.00	.2447	.1816	.4707	.0009	.0048-	.0193
106	193	1155	10.00	.00	30.00	10.02	.00	.2339	.1836	.4819	.0012	.0016-	.0090
106	193	1156	10.00	.00	40.00	10.02	.00	.2348	.1838	.4846	.0011	.0015-	.0080
106	193	1157	10.00	.00	60.00	10.04	.00	.2432	.1847	.4863	.0013	.0014-	.0066
106	193	1158	10.00	.00	100.00	10.08	.00	.2509	.1835	.4788	.0018	.0009-	.0046
106	194	1159	15.00	.00	15.00	15.03	.00	.5723	.1806	.4745	.0005-	.0013-	.0089
106	194	1160	15.00	.00	20.00	15.03	.00	.5541	.1696	.4074	.0008	.0006-	.0038
106	194	1161	15.00	.00	30.00	15.04	.00	.4926	.1693	.4261	.0002	.0010	.0020-
106	194	1162	15.00	.00	40.00	15.08	.00	.5063	.1721	.4379	.0003-	.0002-	.0010
106	194	1163	15.00	.00	60.00	15.11	.00	.5153	.1707	.4286	.0004-	.0005-	.0034
106	194	1164	15.00	.00	100.00	15.19	.00	.5246	.1714	.4335	.0008-	.0007-	.0011
106	195	1165	20.00	.00	15.00	20.05	.00	.9210	.1346	.2990	.0021-	.0067	.0209-
106	195	1166	20.00	.00	20.00	20.07	.00	.8819	.1242	.2531	.0013-	.0064	.0192-
106	195	1167	20.00	.00	30.00	20.10	.00	.8603	.1274	.2678	.0024-	.0066	.0132-
106	195	1168	20.00	.00	40.00	20.12	.00	.8284	.1232	.2646	.0018-	.0047	.0083-
106	195	1169	20.00	.00	60.00	20.19	.00	.8641	.1252	.2617	.0020-	.0027	.0061-
106	195	1170	20.00	.00	100.00	20.33	.00	.8848	.1237	.2625	.0021-	.0017	.0058-
106	196	1171	30.00	.00	15.16	30.10	.00	1.8400	.0172	.0149-	.0071	.0006	.0030-
106	196	1172	30.00	.00	20.21	30.13	.00	1.7276	.0156	.0733-	.0041	.0050-	.0277
106	196	1173	30.00	.00	30.32	30.18	.00	1.5824	.0117	.1048-	.0027-	.0025	.0061
106	196	1174	30.00	.00	40.42	30.23	.00	1.5420	.0077	.1305-	.0033-	.0008	.0089-
106	196	1175	30.00	.00	60.64	30.36	.00	1.5841	.0078	.1395-	.0009-	.0016	.0027-
106	196	1176	30.00	.00	101.06	30.62	.00	1.6517	.0058	.1392-	.0000	.0038-	.0046-
106	197	1177	40.00	.00	15.34	40.14	.00	2.5065	.0750-	.0907-	.0005	.0031-	.0868
106	197	1178	40.00	.00	20.45	40.19	.00	2.4446	.0920-	.1706-	.0014	.0011	.0497
106	197	1179	40.00	.00	30.68	40.24	.00	2.1462	.0750-	.2701-	.0063-	.0083	.0318
106	197	1180	40.00	.00	40.90	40.33	.00	2.1652	.0808-	.3601-	.0036-	.0147	.0095
106	197	1181	40.00	.00	61.35	40.49	.00	2.1409	.0829-	.3886-	.0027-	.0042	.0060-
106	197	1182	40.00	.00	102.25	40.80	.00	2.1233	.0827-	.3733-	.0017	.0562-	.0393-
106	198	1183	50.00	.00	15.57	50.14	.00	2.4009	.0865-	.2883-	.0204-	.1214-	.2504-
106	198	1184	50.00	.00	20.76	50.19	.00	2.5300	.1098-	.2692-	.0002-	.0671-	.2223-
106	198	1185	50.00	.00	31.15	50.27	.00	2.3722	.1150-	.4222-	.0024	.0257-	.0361-
106	198	1186	50.00	.00	41.53	50.37	.00	2.4044	.1196-	.4968-	.0010	.1101-	.1511-
106	198	1187	50.00	.00	62.29	50.52	.00	2.2733	.1209-	.5208-	.0000	.0652-	.0882-
106	198	1188	50.00	.00	103.82	50.87	.00	2.2715	.1252-	.5224-	.0018-	.0859-	.1287-
106	199	1189	60.00	.00	15.83	60.16	.00	2.7886	.1535-	.3587-	.0009-	.1930-	.2807-
106	199	1190	60.00	.00	21.10	60.20	.00	2.6178	.1486-	.4544-	.0021	.1771-	.2694-
106	199	1191	60.00	.00	31.65	60.30	.00	2.5233	.1555-	.5312-	.0007-	.2503-	.3169-
106	199	1192	60.00	.00	42.20	60.39	.00	2.4854	.1618-	.6221-	.0027-	.1873-	.2698-
106	199	1193	60.00	.00	63.30	60.58	.00	2.4790	.1758-	.6968-	.0015-	.0760-	.1089-
106	199	1194	60.00	.00	105.50	60.97	.00	2.4766	.1795-	.6868-	.0007	.0091-	.0194-
106	200	1195	70.00	.00	16.13	70.17	.00	2.8419	.1775-	.7848-	.0008	.0429-	.0834-
106	200	1196	70.00	.00	21.50	70.21	.00	2.6541	.1609-	.6545-	.0004	.0531-	.1108-
106	200	1197	70.00	.00	32.25	70.30	.00	2.5446	.1594-	.7275-	.0018	.0814-	.1109-
106	200	1198	70.00	.00	43.00	70.39	.00	2.4499	.1588-	.7622-	.0018-	.0305	.0212
106	200	1199	70.00	.00	64.50	70.60	.00	2.5174	.1737-	.8673-	.0010-	.0582	.0513
106	200	1200	70.00	.00	107.50	70.98	.00	2.4614	.1830-	.8511-	.0010	.0706	.0546
106	201	1201	80.00	.00	16.22	80.17	.00	2.7819	.1356-	.9046-	.0001	.0108	.0400-
106	201	1202	80.00	.00	21.62	80.21	.00	2.6792	.1362-	.8836-	.0005	.0025-	.0416-
106	201	1203	80.00	.00	32.43	80.32	.00	2.6326	.1480-	.9762-	.0005	.0097	.0249-
106	201	1204	80.00	.00	43.24	80.41	.00	2.5494	.1541-	1.0053-	.0003	.0143	.0148-
106	201	1205	80.00	.00	64.86	80.60	.00	2.4881	.1629-	1.0276-	.0005	.0194	.0043
106	201	1206	80.00	.00	108.10	81.03	.00	2.5834	.1819-	1.1562-	.0005	.0271	.0151

<sup>†</sup> Minus signs are to the right of the numbers to which they apply.

I-905

TABLE III. - AERODYNAMIC COEFFICIENTS OF MODEL FOR THE COMPLETE INVESTIGATION - Continued<sup>†</sup>

Config.	Run	Point	$\alpha_1$ , deg	$\beta$ , deg	$q$ , lb/sq ft	$\alpha$ , deg	$\beta$ , deg	$C_N$	$C_A$	$C_m$	$C_l$	$C_n$	$C_Y$
106	202	1207	90.00	.00	16.28	90.18	+00	2.9868	.1914-	1.4061-	.0003-	.0041	.0165-
106	202	1208	90.00	.00	21.70	90.22	+00	2.7364	.1815-	1.2846-	.0007-	.0067	.0261-
106	202	1209	90.00	.00	32.55	90.33	+00	2.7504	.1995-	1.3542-	.0007-	.0018-	.0133-
106	202	1210	90.00	.00	43.40	90.41	+00	2.5760	.1933-	1.2830-	.0005-	.0058	.0075-
106	202	1211	90.00	.00	65.10	90.61	+00	2.5410	.2086-	1.3424-	.0007-	.0102	.0026-
106	202	1212	90.00	.00	108.50	91.03	+00	2.5637	.2169-	1.3993-	.0005-	.0320	.0269-
107	203	1213	.00	.00	15.00	.02	+00	.3393	.0889	.4310-	.0013	.0136	.0317-
107	203	1214	.00	.00	20.00	.02	+00	.3084	.0910	.4078-	.0010	.0066	.0100-
107	203	1215	.00	.00	30.00	.03	+00	.2945	.0888	.3956-	.0010	.0035	.0010
107	203	1216	.00	.00	40.00	.05	+00	.3071	.0923	.4075-	.0006	.0040	.0042-
107	203	1217	.00	.00	60.00	.07	+00	.3062	.0916	.4057-	.0006	.0027	.0023-
107	203	1218	.00	.00	100.00	.11	+00	.2900	.0917	.3929-	.0005	.0009	.0035
107	204	1219	5.00	.00	15.00	5.03	+00	.6508	.0904	.4725-	.0009	.0103	.0096-
107	204	1220	5.00	.00	20.00	5.04	+00	.6453	.0889	.4723-	.0007	.0091	.0106-
107	204	1221	5.00	.00	30.00	5.06	+00	.6486	.0941	.4784-	.0005	.0060	.0061-
107	204	1222	5.00	.00	40.00	5.08	+00	.6300	.0909	.4662-	.0009	.0048	.0051-
107	204	1223	5.00	.00	60.00	5.13	+00	.6293	.0895	.4652-	.0006	.0028	.0030-
107	204	1224	5.00	.00	100.00	5.24	+00	.6393	.0917	.4683-	.0005	.0012	.0002
107	205	1225	10.00	.00	15.00	10.05	+00	1.0132	.0953	.5829-	.0008	.0151	.0253-
107	205	1226	10.00	.00	20.00	10.07	+00	1.0596	.0922	.6023-	.0006	.0130	.0239-
107	205	1227	10.00	.00	30.00	10.10	+00	1.0196	.0959	.5815-	.0006	.0089	.0123-
107	205	1228	10.00	.00	40.00	10.14	+00	.9858	.0922	.5635-	.0007	.0064	.0104-
107	205	1229	10.00	.00	60.00	10.22	+00	1.0132	.0941	.5789-	.0005	.0026	.0036-
107	205	1230	10.00	.00	100.00	10.36	+00	1.0069	.0959	.5734-	.0005	.0011	.0004
107	206	1231	15.00	.00	15.00	15.11	+00	2.2457	.0913	1.1864-	.0005	.0196	.0311-
107	206	1232	15.00	.00	20.00	15.10	+00	1.3572	.0987	.6974-	.0009	.0147	.0278-
107	206	1233	15.00	.00	30.00	15.14	+00	1.3653	.1041	.7068-	.0001	.0087	.0149-
107	206	1234	15.00	.00	40.00	15.19	+00	1.3309	.1012	.6880-	.0002	.0061	.0053-
107	206	1235	15.00	.00	60.00	15.29	+00	1.3429	.1023	.6931-	.0006	.0031	.0029-
107	206	1236	15.00	.00	100.00	15.50	+00	1.3572	.1075	.6962-	.0010	.0017	.0012-
107	207	1237	20.00	.00	15.00	20.10	+00	1.7737	.0003	.8397-	.0002	.0166	.0329-
107	207	1238	20.00	.00	20.00	20.13	+00	1.7601	.0039	.8512-	.0002	.0176	.0380-
107	207	1239	20.00	.00	30.00	20.19	+00	1.6939	.0018	.8172-	.0003	.0119	.0237-
107	207	1240	20.00	.00	40.00	20.25	+00	1.6823	.0006	.8100-	.0014	.0105	.0165-
107	207	1241	20.00	.00	60.00	20.38	+00	1.7053	.0021	.8163-	.0010	.0070	.0095-
107	207	1242	20.00	.00	100.00	20.65	+00	1.7472	.0047	.8267-	.0008	.0050	.0029-
107	208	1243	30.00	.00	15.16	30.15	+00	2.6746	.0792	1.0130-	.0012	.0093	.0228-
107	208	1244	30.00	.00	20.21	30.19	+00	2.4975	.0835	1.0217-	.0014	.0196	.0153-
107	208	1245	30.00	.00	30.32	30.27	+00	2.3967	.0856	1.0437-	.0002	.0072	.0057-
107	208	1246	30.00	.00	40.42	30.36	+00	2.3947	.0858	1.0666-	.0007	.0002	.0092-
107	208	1247	30.00	.00	60.64	30.55	+00	2.4386	.0878	1.0932-	.0007	.0037	.0040
107	208	1248	30.00	.00	101.06	30.92	+00	2.4713	.0870	1.0725-	.0004	.0018	.0085
107	209	1249	40.00	.00	15.34	40.19	+00	3.3244	.0478	.9168-	.0345	.0599	.3678-
107	209	1250	40.00	.00	20.45	40.24	+00	3.1884	.0523	.9852-	.0136	.0141	.0945-
107	209	1251	40.00	.00	30.68	40.34	+00	2.9816	.0574	1.1250-	.0083	.0018	.0372-
107	209	1252	40.00	.00	40.90	40.43	+00	2.8471	.0579	1.1475-	.0000	.0069	.0119-
107	209	1253	40.00	.00	61.35	40.64	+00	2.8184	.0580	1.1654-	.0039	.0122	.0513-
107	209	1254	40.00	.00	102.25	41.03	+00	2.7126	.0628	1.0877-	.0116	.0011	.0852-
107	210	1255	50.00	.00	15.57	50.18	+00	3.0498	.0594	.8413-	.0092	.1412	.2922-
107	210	1256	50.00	.00	20.76	50.23	+00	2.9594	.0457	.7954-	.0113	.0771	.2451-
107	210	1257	50.00	.00	31.15	50.34	+00	2.9360	.0477	.9833-	.0080	.1213	.2022-
107	210	1258	50.00	.00	41.53	50.42	+00	2.7359	.0479	1.0167-	.0045	.0647	.1148-
107	210	1259	50.00	.00	62.29	50.64	+00	2.7584	.0488	1.0960-	.0005	.0486	.0723-
107	210	1260	50.00	.00	103.82	51.07	+00	2.7833	.0483	1.0882-	.0015	.0677	.0933-
107	211	1261	60.00	.00	15.83	60.18	+00	3.0995	.0301	.7872-	.0031	.1790	.3101-
107	211	1262	60.00	.00	21.10	60.23	+00	2.9972	.0294	.8906-	.0025	.1813	.3045-
107	211	1263	60.00	.00	31.65	60.33	+00	2.8560	.0237	.9314-	.0033	.2578	.3571-
107	211	1264	60.00	.00	42.20	60.45	+00	2.8701	.0200	1.0778-	.0002	.0649	.1078-
107	211	1265	60.00	.00	63.30	60.68	+00	2.8871	.0181	1.1513-	.0001	.0362	.0491-
107	211	1266	60.00	.00	105.50	61.13	+00	2.8832	.0141	1.1567-	.0007	.0068	.0061
107	212	1267	70.00	.00	16.13	70.18	+00	3.0665	.0167	.9290-	.0044	.0769	.0331
107	212	1268	70.00	.00	21.50	70.24	+00	3.0348	.0213	1.0098-	.0011	.0806	.1285-
107	212	1269	70.00	.00	32.25	70.35	+00	2.9397	.0253	1.1390-	.0009	.0482	.0765-
107	212	1270	70.00	.00	43.00	70.47	+00	2.9340	.0227	1.2074-	.0043	.0781	.0716
107	212	1271	70.00	.00	64.50	70.70	+00	2.9256	.0241	1.2692-	.0018	.0541	.0544
107	212	1272	70.00	.00	107.50	71.16	+00	2.9202	.0183	1.2809-	.0011	.0717	.0720
107	213	1273	80.00	.00	16.22	80.20	+00	3.1069	.0450	1.2231-	.0019	.0118	.0403-
107	213	1274	80.00	.00	21.62	80.24	+00	3.0476	.0366	1.2144-	.0010	.0011	.0307-
107	213	1275	80.00	.00	32.43	80.38	+00	3.0763	.0417	1.3733-	.0006	.0050	.0108-
107	213	1276	80.00	.00	43.24	80.48	+00	2.9180	.0360	1.3422-	.0004	.0121	.0002
107	213	1277	80.00	.00	64.86	80.72	+00	2.9729	.0306	1.4210-	.0000	.0084	.0017
107	213	1278	80.00	.00	108.10	81.10	+00	2.7339	.0247	1.3616-	.0001	.0141	.0174

<sup>†</sup>Minus signs are to the right of the numbers to which they apply.



TABLE III. - AERODYNAMIC COEFFICIENTS OF MODEL FOR THE COMPLETE INVESTIGATION - Continued <sup>†</sup>

Config.	Run	Point	$\alpha_1$ , deg	$\beta$ , deg	q, lb/sq ft	$\alpha$ , deg	$\beta$ , deg	C <sub>N</sub>	C <sub>A</sub>	C <sub>m</sub>	C <sub>l</sub>	C <sub>n</sub>	C <sub>Y</sub>
107	214	1279	90.00	.00	16.28	90.17	.00	2.8731	.1049	1.6357-	.0001-	.0168	.0207-
107	214	1280	90.00	.00	21.70	90.23	.00	2.8730	.0977	1.6683-	.0000	.0123	.0422-
107	214	1281	90.00	.00	32.55	90.33	.00	2.7551	.0938	1.6587-	.0001-	.0031	.0310-
107	214	1282	90.00	.00	43.40	90.45	.00	2.8232	.0927	1.7422-	.0010-	.0070	.0131-
107	214	1283	90.00	.00	65.10	90.67	.00	2.7713	.0810	1.7751-	.0006-	.0084	.0006
107	214	1284	90.00	.00	108.50	91.06	.00	2.6451	.0752	1.7387-	.0010-	.0220	.0272
110	215	1285	.00	.00	15.00	.00	.00	.0198	.0425	.0020-	.0009-	.0086	.0365-
110	215	1286	.00	.00	20.00	.00	.00	.0145	.0448	.0007	.0007-	.0058	.0274-
110	215	1287	.00	.00	30.00	.00	.00	.0273	.0441	.0093-	.0005-	.0044	.0182-
110	215	1288	.00	.00	40.00	.00	.00	.0268	.0451	.0086-	.0001-	.0038	.0139-
110	215	1289	.00	.00	60.00	.00	.00	.0178	.0442	.0029-	.0001-	.0016	.0068-
110	215	1290	.00	.00	100.00	.01	.00	.0210	.0449	.0027-	.0000	.0014	.0045-
110	216	1291	5.00	.00	15.00	5.01	.00	.3634	.0365	.0723-	.0012-	.0095	.0443-
110	216	1292	5.00	.00	20.00	5.03	.00	.3756	.0376	.0855-	.0001-	.0089	.0351-
110	216	1293	5.00	.00	30.00	5.03	.00	.3796	.0371	.0886-	.0001-	.0067	.0259-
110	216	1294	5.00	.00	40.00	5.04	.00	.3621	.0377	.0742-	.0001-	.0061	.0221-
110	216	1295	5.00	.00	60.00	5.07	.00	.3708	.0373	.0771-	.0002-	.0049	.0155-
110	216	1296	5.00	.00	100.00	5.13	.00	.3696	.0364	.0770-	.0003	.0031	.0098-
110	217	1297	10.00	.00	15.00	10.04	.00	.8287	.0272	.2348-	.0005-	.0239	.0916-
110	217	1298	10.00	.00	20.00	10.05	.00	.8281	.0277	.2408-	.0005-	.0202	.0792-
110	217	1299	10.00	.00	30.00	10.08	.00	.7944	.0285	.2229-	.0002-	.0130	.0520-
110	217	1300	10.00	.00	40.00	10.11	.00	.7836	.0283	.2122-	.0003-	.0118	.0437-
110	217	1301	10.00	.00	60.00	10.16	.00	.7676	.0282	.2068-	.0002	.0078	.0285-
110	217	1302	10.00	.00	100.00	10.27	.00	.7601	.0189	.2022-	.0001	.0045	.0165-
110	218	1303	15.00	.00	15.00	15.06	.00	1.2606	.0202	.4219-	.0003-	.0397	.1456-
110	218	1304	15.00	.00	20.00	15.09	.00	1.2302	.0233	.4065-	.0001	.0321	.1131-
110	218	1305	15.00	.00	30.00	15.12	.00	1.1589	.0221	.3871-	.0001-	.0224	.0788-
110	218	1306	15.00	.00	40.00	15.17	.00	1.1476	.0230	.3697-	.0003-	.0188	.0648-
110	218	1307	15.00	.00	60.00	15.26	.00	1.1622	.0223	.3715-	.0001-	.0126	.0408-
110	218	1308	15.00	.00	100.00	15.42	.00	1.1381	.0226	.3563-	.0012-	.0076	.0244-
110	219	1309	20.00	.00	15.00	20.09	.00	1.7082	.0113	.6042-	.0002-	.0530	.2003-
110	219	1310	20.00	.00	20.00	20.12	.00	1.6339	.0125	.5852-	.0001	.0385	.1448-
110	219	1311	20.00	.00	30.00	20.18	.00	1.5912	.0127	.5648-	.0002-	.0263	.0961-
110	219	1312	20.00	.00	40.00	20.23	.00	1.5630	.0134	.5458-	.0003-	.0222	.0780-
110	219	1313	20.00	.00	60.00	20.34	.00	1.5332	.0129	.5237-	.0004	.0149	.0506-
110	219	1314	20.00	.00	100.00	20.57	.00	1.5525	.0128	.5178-	.0001-	.0078	.0290-
110	220	1315	30.00	.00	15.16	30.14	.00	2.5809	.0127-	.9347-	.0012	.0552	.2147-
110	220	1316	30.00	.00	20.21	30.19	.00	2.4840	.0131-	.9049-	.0031	.0346	.1494-
110	220	1317	30.00	.00	30.32	30.27	.00	2.3840	.0114-	.8637-	.0014	.0263	.1034-
110	220	1318	30.00	.00	40.42	30.35	.00	2.3655	.0119-	.8546-	.0008	.0178	.0712-
110	220	1319	30.00	.00	60.64	30.52	.00	2.3218	.0115-	.8238-	.0005	.0139	.0534-
110	220	1320	30.00	.00	101.06	30.87	.00	2.3250	.0225-	.7999-	.0021	.0024	.0219-
110	221	1321	40.00	.00	15.34	40.18	.00	3.2248	.0456-	.9791-	.0096	.0537	.2309-
110	221	1322	40.00	.00	20.45	40.24	.00	3.1705	.0431-	.9722-	.0124	.0403	.1848-
110	221	1323	40.00	.00	30.68	40.34	.00	2.9724	.0390-	.9522-	.0107	.0257	.1123-
110	221	1324	40.00	.00	40.90	40.44	.00	2.9289	.0385-	.9597-	.0067	.0208	.0761-
110	221	1325	40.00	.00	61.35	40.64	.00	2.8290	.0354-	.9279-	.0031-	.0142	.0413-
110	221	1326	40.00	.00	102.25	41.09	.00	2.8800	.0359-	.9231-	.0015-	.0121	.0313-
110	222	1327	50.00	.00	15.57	50.19	.00	3.3417	.1661-	2.5560-	.0037	.0021	.0274-
110	223	1333	60.00	.00	15.83	60.19	.00	3.1600	.1260	.6789-	.0048	.0454	.1613-
110	223	1334	60.00	.00	21.10	60.23	.00	2.9893	.0808	.6592-	.0035	.0525	.1291-
110	224	1339	70.00	.00	16.13	70.20	.00	3.2754	.1254	.9460-	.0012	.0555	.1781-
110	224	1340	70.00	.00	21.50	70.25	.00	3.1909	.0852	.9833-	.0024	.0617	.1147-
110	224	1341	70.00	.00	32.25	70.35	.00	2.8923	.0533	.9787-	.0028	.0428	.0701-
110	224	1342	70.00	.00	43.00	70.45	.00	2.8569	.0383	1.0051-	.0013	.0251	.0589-
110	224	1343	70.00	.00	64.50	70.70	.00	2.9332	.0179	1.0836-	.0012	.0158	.0398-
110	224	1344	70.00	.00	107.50	71.18	.00	2.9690	.0025	1.1319-	.0011	.0093	.0236-
110	225	1345	80.00	.00	16.22	80.20	.00	3.0967	.1383	1.1482-	.0023	.0456	.2030-
110	225	1346	80.00	.00	21.62	80.24	.00	3.0452	.0993	1.1386-	.0014	.0375	.1531-
110	225	1347	80.00	.00	32.43	80.36	.00	2.9954	.0563	1.2348-	.0009	.0247	.0862-
110	225	1348	80.00	.00	43.24	80.48	.00	3.0010	.0317	1.2598-	.0015	.0193	.0618-
110	225	1349	80.00	.00	64.86	80.72	.00	2.9614	.0116	1.2665-	.0006	.0108	.0433-
110	225	1350	80.00	.00	108.10	81.14	.00	2.8104	.0008-	1.2302-	.0008	.0005-	.0257-

<sup>†</sup>Minus signs are to the right of the numbers to which they apply.

L-905

TABLE III. - AERODYNAMIC COEFFICIENTS OF MODEL FOR THE COMPLETE INVESTIGATION - Continued<sup>†</sup>

Config.	Run	Point	$\alpha_1$ , deg	$\beta$ , deg	$q$ , lb/sq ft	$\alpha$ , deg	$\beta$ , deg	$C_N$	$C_A$	$C_m$	$C_l$	$C_n$	$C_Y$
110	226	1351	90.00	.00	16.28	90.19	.00	3.1161	.1403	1.6648-	.0021	.0789	.1603-
110	226	1352	90.00	.00	21.70	90.24	.00	2.9875	.1031	1.6209-	.0008	.0362	.1681-
110	226	1353	90.00	.00	32.55	90.35	.00	2.8734	.0651	1.6033-	.0007	.0237	.1150-
110	226	1354	90.00	.00	43.40	90.47	.00	2.9080	.0449	1.6407-	.0000	.0174	.0808-
110	226	1355	90.00	.00	65.10	90.69	.00	2.8611	.0226	1.6267-	.0002	.0136	.0486-
110	226	1356	90.00	.00	108.50	91.09	.00	2.7196	.0105	1.5799-	.0003-	.0038	.0289-
110	227	1357	30.00	5.00-	15.16	30.05	2.51-	2.4626	.0142-	.8365-	.0018	.0114	.0511-
110	227	1358	30.00	5.00-	30.32	30.15	2.52-	2.2632	.0135-	.7759-	.0042-	.0117	.0420-
110	227	1359	30.00	5.00-	101.06	30.75	2.56-	2.2694	.0143-	.7663-	.0075	.0142	.0447-
110	228	1360	40.00	5.00-	15.34	40.07	3.22-	3.0925	.0438-	.8599-	.0299	.0040-	.0843-
110	229	1363	50.00	5.00-	15.57	50.07	3.84-	3.0498	.0262-	.6048-	.0053	.0517-	.0517-
110	229	1364	50.00	5.00-	31.15	50.21	3.84-	2.7766	.0427-	.6174-	.0145	.0426-	.0223
110	230	1366	60.00	5.00-	15.83	60.07	4.33-	2.9952	.0213-	.6711-	.0086	.0286-	.0870
110	230	1367	60.00	5.00-	31.65	60.24	4.34-	2.8761	.0331-	.6734-	.0065	.0313-	.0663
110	230	1368	60.00	5.00-	105.50	61.04	4.38-	2.9335	.0360-	.8622-	.0081	.0047-	.0966
110	231	1369	70.00	5.00-	16.13	70.11	4.70-	2.9588	.0294-	.8120-	.0085	.0018-	.1042
110	231	1370	70.00	5.00-	32.25	70.28	4.71-	2.9574	.0229-	1.0307-	.0098	.0064-	.0889
110	231	1371	70.00	5.00-	107.50	71.08	4.73-	2.8952	.0192-	1.1143-	.0102	.0157	.0599
110	232	1372	80.00	5.00-	16.22	80.15	4.92-	3.0362	.0162-	1.1034-	.0034	.0029	.1186
110	232	1373	80.00	5.00-	32.43	80.31	4.93-	2.8404	.0186-	1.1735-	.0089	.0048-	.1114
110	232	1374	80.00	5.00-	108.10	81.11	4.94-	2.8650	.0212-	1.2685-	.0080	.0093-	.1069
110	233	1375	90.00	5.00-	16.28	90.17	5.00-	2.9035	.0080-	1.5453-	.0044	.0418	.1709
110	233	1376	90.00	5.00-	32.55	90.35	5.00-	2.8853	.0115-	1.6218-	.0040	.0047-	.1242
110	233	1377	90.00	5.00-	108.50	91.13	5.00-	2.8204	.0151-	1.6752-	.0035	.0203-	.1063
110	234	1378	10.00	10.00-	15.00	9.88	1.74-	.7394	.0244	.1852-	.0034	.0061-	.0130
110	234	1379	10.00	10.00-	30.00	9.92	1.74-	.7224	.0259	.1815-	.0049	.0097-	.0263
110	234	1380	10.00	10.00-	100.00	10.11	1.77-	.7304	.0272	.1841-	.0028	.0144-	.0387
110	235	1381	20.00	10.00-	15.00	19.80	3.42-	1.4542	.0093	.4538-	.0010-	.0024-	.0089
110	235	1382	20.00	10.00-	30.00	19.88	3.43-	1.4376	.0114	.4800-	.0013-	.0039-	.0231
110	235	1383	20.00	10.00-	100.00	20.26	3.49-	1.5132	.0066	.6455-	.0044-	.0133-	.0535
110	236	1384	30.00	10.00-	15.16	29.75	5.00-	2.3418	.0134-	.7340-	.0003-	.0049	.0463-
110	236	1385	30.00	10.00-	30.32	29.88	5.02-	2.3147	.0126-	.7579-	.0030-	.0107	.0812-
110	236	1386	30.00	10.00-	101.06	30.45	5.10-	2.2528	.0132-	.7525-	.0103	.0222	.0717-
110	237	1387	40.00	10.00-	15.34	39.73	6.43-	3.1021	.0611-	.8634-	.0114	.0252-	.1051-
110	237	1388	40.00	10.00-	30.68	39.88	6.45-	2.8295	.0345-	.8138-	.0055	.0109-	.1962-
110	237	1389	40.00	10.00-	102.25	40.58	6.54-	2.7381	.0302-	.7983-	.0311	.0563-	.0097-
110	238	1390	50.00	10.00-	15.57	49.73	7.66-	2.7784	.0234-	.4878-	.0041	.1379-	.0566-
110	238	1391	50.00	10.00-	31.15	49.88	7.68-	2.7517	.0203-	.5648-	.0129	.1434-	.0092-
110	238	1392	50.00	10.00-	103.82	50.60	7.76-	2.7082	.0243-	.7142-	.0010	.0661-	.1001
110	239	1393	60.00	10.00-	15.83	59.79	8.66-	2.9225	.0322-	.5547-	.0104	.1178-	.1217
110	239	1394	60.00	10.00-	31.65	59.95	8.67-	2.8499	.0355-	.6105-	.0126	.0900-	.1315
110	239	1395	60.00	10.00-	105.50	60.71	8.74-	2.7939	.0358-	.8097-	.0142	.0214-	.1918
110	240	1396	70.00	10.00-	16.13	69.89	9.40-	2.8367	.0348-	.7818-	.0167	.0136-	.2480
110	240	1396	70.00	10.00-	32.25	70.06	9.41-	2.8550	.2385-	.9666-	.0181	.0287-	.2018
110	240	1397	70.00	10.00-	107.50	70.83	9.45-	2.8059	.0251-	1.0757-	.0179	.0181-	.2244
110	241	1398	80.00	10.00-	16.22	80.04	9.85-	2.9607	.0174-	1.1295-	.0171	.0021	.2521
110	241	1399	80.00	10.00-	32.43	80.20	9.85-	2.8683	.0184-	1.1893-	.0156	.0198-	.2391
110	241	1400	80.00	10.00-	108.10	80.95	9.87-	2.7294	.0223-	1.2195-	.0134	.0091-	.2192
110	242	1401	90.00	10.00-	16.28	90.17	10.00-	2.9454	.0095-	1.6304-	.0074	.0109	.3406
110	242	1402	90.00	10.00-	32.55	90.33	10.00-	2.7968	.0130-	1.6155-	.0082	.0104	.2880
110	242	1403	90.00	10.00-	108.50	91.15	10.00-	2.8547	.0169-	1.7016-	.0072	.0376-	.2650
110	243	1405	20.00	15.00-	30.00	19.53	5.11-	1.4519	.0147	.4726-	.0049-	.0155-	.0705
110	243	1404	20.00	15.00-	15.00	19.45	5.09-	1.4963	.0126	.4715-	.0039-	.0126-	.0623
110	243	1406	20.00	15.00-	100.00	19.88	5.20-	1.4751	.0141	.4777-	.0071-	.0150-	.0637
110	244	1407	30.00	15.00-	15.16	29.27	7.46-	2.2784	.0016-	.6750-	.0003-	.0022-	.1058-
110	244	1408	30.00	15.00-	30.32	29.40	7.49-	2.3615	.0036	.7585-	.0046	.0057-	.1182-
110	244	1409	30.00	15.00-	101.06	29.93	7.61-	2.2090	.0038-	.7267-	.0108	.0182	.0944-

<sup>†</sup> Minus signs are to the right of the numbers to which they apply.

L-905

TABLE III. - AERODYNAMIC COEFFICIENTS OF MODEL FOR THE COMPLETE INVESTIGATION - Continued †

Config.	Run	Point	$\alpha_1$ , deg	$\beta$ , deg	q, lb/sq ft	$\alpha$ , deg	$\beta$ , deg	C <sub>N</sub>	C <sub>A</sub>	C <sub>m</sub>	C <sub>i</sub>	C <sub>n</sub>	C <sub>y</sub>
110	245	1410	40.00	15.00-	15.34	39.19	9.61-	3.0072	.0275-	.7958-	.0051-	.0095-	.2441-
110	245	1411	40.00	15.00-	30.68	39.33	9.64-	2.7929	.0212-	.7957-	.0002	.0232-	.2225-
110	245	1412	40.00	15.00-	102.25	40.00	9.77-	2.6833	.0268-	.7553-	.0344	.0848-	.0217
110	246	1413	10.00	20.00-	15.00	9.44	3.42-	.6866	.0273	.1772-	.0048	.0328-	.0897
110	246	1414	10.00	20.00-	30.00	9.46	3.43-	.7026	.0287	.1786-	.0050	.0321-	.0909
110	246	1415	10.00	20.00-	100.00	9.63	3.48-	.7014	.0283	.1779-	.0051	.0307-	.0855
110	247	1416	20.00	20.00-	15.00	18.96	6.74-	1.5452	.0157	.5122-	.0014-	.0295-	.1069
110	247	1417	20.00	20.00-	30.00	19.02	6.76-	1.4491	.0162	.4779-	.0029-	.0295-	.1084
110	247	1418	20.00	20.00-	100.00	19.36	6.88-	1.4636	.0162	.4795-	.0062-	.0253-	.0931
110	248	1419	30.00	20.00-	15.16	28.60	9.88-	2.2518	.0048	.6618-	.0129	.0382-	.0738-
110	248	1420	30.00	20.00-	30.32	28.71	9.92-	2.2833	.0133	.7225-	.0130	.0369-	.0866-
110	248	1421	30.00	20.00-	101.06	29.23	10.07-	2.1998	.0065	.7043-	.0170	.0062	.0648-
110	249	1422	10.00	30.00-	15.00	8.70	4.99-	.6705	.0289	.1734-	.0041	.0362-	.0911
110	249	1423	10.00	30.00-	30.00	8.73	5.01-	.6666	.0307	.1680-	.0060	.0417-	.1132
110	249	1424	10.00	30.00-	100.00	8.86	5.08-	.6427	.0299	.1625-	.0062	.0438-	.1204
110	250	1425	20.00	30.00-	15.00	17.55	9.87-	1.3421	.0185	.4271-	.0100	.0468-	.1377
110	250	1426	20.00	30.00-	30.00	17.61	9.91-	1.3525	.0213	.4412-	.0071	.0444-	.1443
110	250	1427	20.00	30.00-	100.00	17.87	10.05-	1.3390	.0193	.4399-	.0055	.0503-	.1528
110	251	1428	10.00	50.00-	15.00	6.47	7.66-	.5022	.0362	.1328-	.0038	.0767-	.2137
110	251	1429	10.00	50.00-	30.00	6.48	7.66-	.4796	.0343	.1238-	.0045	.0750-	.2095
110	251	1430	10.00	50.00-	100.00	6.53	7.72-	.4666	.0322	.1150-	.0050	.0757-	.2054
110	252	1431	20.00	50.00-	15.00	13.18	15.21-	.9557	.0191	.2794-	.0201	.1771-	.4436
110	252	1432	20.00	50.00-	30.00	13.21	15.24-	.9445	.0168	.2795-	.0215	.1640-	.4377
110	252	1433	20.00	50.00-	100.00	13.52	15.36-	.9479	.0173	.2886-	.0202	.1491-	.3999
110	253	1434	10.00	70.00-	15.00	3.45	9.40-	.2759	.0414	.0760-	.0033	.1090-	.2854
110	253	1435	10.00	70.00-	30.00	3.45	9.40-	.2370	.0399	.0594-	.0026	.0997-	.2645
110	253	1436	10.00	70.00-	100.00	3.46	9.42-	.2373	.0370	.0582-	.0022	.0968-	.2527
110	254	1437	10.00	90.00-	15.00	.00	10.00-	.0464	.0472	.0142-	.0024-	.1082-	.2818
110	254	1438	10.00	90.00-	30.00	.00	10.00-	.0207	.0434	.0081-	.0023-	.1036-	.2713
110	254	1439	10.00	90.00-	100.00	.00	10.00-	.0070	.0419	.0044-	.0023-	.1017-	.2610
110	255	1440	30.00	5.00	15.16	30.03	2.51	2.3507	.0120-	.7860-	.0072-	.0180-	.0570
110	255	1441	30.00	5.00	30.32	30.17	2.52	2.3113	.0107-	.7945-	.0007-	.0212-	.0726
110	255	1442	30.00	5.00	101.06	30.76	2.56	2.3093	.0154-	.7901-	.0054-	.0192-	.0581
110	256	1443	40.00	5.00	15.34	40.05	3.22	2.8563	.0379-	.8053-	.0276-	.0075	.0459
110	256	1444	40.00	5.00	30.68	40.21	3.23	2.8203	.0369-	.8360-	.0299-	.0132	.0541
110	256	1445	40.00	5.00	102.25	40.96	3.28	2.8328	.0368-	.8897-	.0188-	.0119	.0091
110	257	1446	50.00	5.00	15.57	50.06	3.84	3.0133	.0297-	.6011-	.0214-	.0453	.0111
110	257	1447	50.00	5.00	31.15	50.21	3.84	2.8128	.0274-	.6731-	.0167-	.0345	.0347-
110	257	1448	50.00	5.00	103.82	50.97	3.89	2.8177	.0292-	.7778-	.0037-	.0334	.0579-
110	258	1449	60.00	5.00	15.83	60.08	4.33	3.0690	.0331-	.6384-	.0102-	.0633	.0243-
110	258	1450	60.00	5.00	31.65	60.23	4.34	2.8289	.0361-	.6455-	.0060-	.0483	.0392-
110	258	1451	60.00	5.00	105.50	61.05	4.38	2.9593	.0353-	.8757-	.0067-	.0079	.0986-
110	259	1452	70.00	5.00	16.13	70.11	4.70	3.0583	.0266-	.8417-	.0063-	.0055-	.0910-
110	259	1453	70.00	5.00	32.25	70.28	4.71	2.9357	.0235-	1.0146-	.0075-	.0240	.0718-
110	259	1454	70.00	5.00	107.50	71.10	4.73	2.9421	.0196-	1.1346-	.0090-	.0081-	.1078-
110	260	1455	80.00	5.00	16.22	80.16	4.92	3.1730	.0133-	1.1724-	.0063-	.0001	.1471-
110	260	1456	80.00	5.00	32.43	80.32	4.93	2.9516	.0187-	1.2160-	.0073-	.0098	.1284-
110	260	1457	80.00	5.00	108.10	81.15	4.94	2.9542	.0243-	1.3401-	.0076-	.0006	.1218-
110	261	1458	90.00	5.00	16.28	90.18	5.00	3.0036	.0003-	1.6146-	.0046-	.0141-	.1843-
110	261	1459	90.00	5.00	32.55	90.36	5.00	2.9606	.0113-	1.6577-	.0051-	.0027	.1555-
110	261	1460	90.00	5.00	108.50	91.17	5.00	2.9123	.0118-	1.7132-	.0048-	.0125	.1062-
110	262	1461	10.00	10.00	15.00	9.88	1.74	.7625	.0242	.1841-	.0024-	.0186	.0616-
110	262	1462	10.00	10.00	30.00	9.92	1.74	.7448	.0264	.1869-	.0024-	.0209	.0640-
110	262	1463	10.00	10.00	100.00	10.11	1.77	.7434	.0270	.1901-	.0025-	.0161	.0453-
110	263	1464	20.00	10.00	15.00	19.80	3.42	1.5530	.0095-	.4959-	.0008	.0215	.0770-
110	263	1465	20.00	10.00	30.00	19.88	3.43	1.4571	.0122	.4903-	.0027	.0141	.0572-
110	263	1466	20.00	10.00	100.00	20.27	3.49	1.5228	.0118	.4958-	.0027	.0099	.0356-
110	264	1467	30.00	10.00	15.16	29.75	5.00	2.3340	.0155-	.7503-	.0036-	.0068-	.0617
110	264	1468	30.00	10.00	30.32	29.88	5.02	2.3475	.0096-	.7693-	.0004-	.0182-	.0851
110	264	1469	30.00	10.00	101.06	30.47	5.11	2.2994	.0219-	.7761-	.0070-	.0187-	.0880
110	265	1470	40.00	10.00	15.34	39.72	6.43	2.9063	.0467-	.7877-	.0318-	.0379	.0187
110	265	1471	40.00	10.00	30.68	39.89	6.45	2.9094	.0430-	.8403-	.0212-	.0330	.1031
110	265	1472	40.00	10.00	102.25	40.61	6.54	2.7992	.0346-	.8535-	.0308-	.0299	.0101-

† Minus signs are to the right of the numbers to which they apply.

I-905

TABLE III. - AERODYNAMIC COEFFICIENTS OF MODEL FOR THE COMPLETE INVESTIGATION - Continued<sup>†</sup>

Config.	Run	Point	$\alpha_1$ , deg	$\beta$ , deg	$q$ , lb/sq ft	$\alpha$ , deg	$\beta$ , deg	$C_N$	$C_A$	$C_m$	$C_l$	$C_n$	$C_y$
110	266	1473	50.00	10.00	15.57	49.74	7.66	2.9594	.0419-	.5356-	.0131-	.0684	.0086-
110	266	1474	50.00	10.00	31.15	49.92	7.68	3.1134	.1809-	1.2729-	.0211-	.2749	.1851-
110	266	1475	50.00	10.00	103.82	50.61	7.76	2.7480	.0308-	.7554-	.0009	.0608	.1059-
110	267	1476	60.00	10.00	15.83	59.79	8.66	2.8928	.0367-	.5530-	.0076-	.1315	.0652-
110	267	1477	60.00	10.00	31.65	59.95	8.67	2.8908	.0419-	.6276-	.0096-	.1120	.0812-
110	267	1478	60.00	10.00	105.50	60.16	8.69	1.4044	.0237-	.0452-	.0198-	.0179	.2032-
110	268	1479	70.00	10.00	16.13	69.90	9.40	3.1260	.0278-	.8856-	.0418-	.0222	.1968-
110	268	1480	70.00	10.00	32.25	70.06	9.41	2.8962	.0291-	.9641-	.0160-	.0399	.1787-
110	268	1481	70.00	10.00	107.50	70.84	9.45	2.8614	.0221-	1.0824-	.0178-	.0173	.2154-
110	269	1482	80.00	10.00	16.22	80.04	9.85	3.0707	.0168-	1.1525-	.0137-	.0012-	.2741-
110	269	1483	80.00	10.00	32.43	80.19	9.85	2.8203	.0216-	1.1675-	.0140-	.0019-	.2272-
110	269	1484	80.00	10.00	108.10	80.98	9.88	2.8225	.0225-	1.2740-	.0138-	.0063	.2326-
110	270	1485	90.00	10.00	16.28	90.17	10.00	2.8699	.0000	1.5803-	.0064-	.0257-	.3200-
110	270	1486	90.00	10.00	32.55	90.33	10.00	2.8161	.0138-	1.6245-	.0075-	.0082	.2604-
110	270	1487	90.00	10.00	108.50	91.17	10.00	2.9066	.0177-	1.7194-	.0080-	.0294	.2309-
110	271	1488	20.00	15.00	15.00	19.46	5.10	1.6221	.0114	.5375-	.0038	.0285	.0983-
110	271	1489	20.00	15.00	30.00	19.53	5.11	1.4519	.0134	.4905-	.0060	.0163	.0735-
110	271	1490	20.00	15.00	100.00	19.90	5.21	1.5426	.0136	.4993-	.0072	.0155	.0584-
110	272	1491	30.00	15.00	15.16	29.27	7.46	2.4789	.0352-	.7909-	.0025-	.0013	.1054
110	272	1492	30.00	15.00	30.32	29.40	7.49	2.3581	.0316-	.7785-	.0045-	.0007-	.0973
110	272	1493	30.00	15.00	101.06	29.95	7.62	2.2638	.0344-	.7547-	.0060-	.0229-	.1120
110	273	1494	40.00	15.00	15.34	39.17	9.60	2.8071	.0300-	.7481-	.0029-	.0177	.2227
110	273	1495	40.00	15.00	30.68	39.32	9.63	2.7733	.0305-	.7820-	.0029-	.0309	.1974
110	273	1496	40.00	15.00	102.25	40.01	9.77	2.7163	.0324-	.7922-	.0334-	.0779	.0291-
110	274	1497	10.00	20.00	15.00	9.44	3.42	.6967	.0269	.1554-	.0028-	.0287	.0731-
110	274	1498	10.00	20.00	30.00	9.46	3.43	.6797	.0265	.1651-	.0043-	.0258	.0686-
110	274	1499	10.00	20.00	100.00	9.63	3.48	.7021	.0272	.1783-	.0048-	.0274	.0747-
110	275	1500	20.00	20.00	15.00	18.96	6.74	1.5340	.0142	.4936-	.0037	.0256	.0778-
110	275	1501	20.00	20.00	30.00	19.02	6.76	1.4128	.0156	.4564-	.0049	.0247	.0760-
110	275	1502	20.00	20.00	100.00	19.36	6.88	1.4721	.0153	.4667-	.0084	.0175	.0759-
110	276	1503	30.00	20.00	15.16	28.60	9.88	2.3246	.0150	.6823-	.0111-	.0094	.1335
110	276	1504	30.00	20.00	30.32	28.71	9.92	2.2428	.0162	.7200-	.0110-	.0081	.1076
110	276	1505	30.00	20.00	101.06	29.25	10.08	2.2507	.0229-	.8947-	.0139-	.0199-	.1007
110	277	1506	10.00	30.00	15.00	8.70	4.99	.7206	.0287	.1818-	.0063-	.0548	.1457-
110	277	1507	10.00	30.00	30.00	8.73	5.01	.6496	.0272	.1698-	.0062-	.0500	.1361-
110	277	1508	10.00	30.00	100.00	8.86	5.08	.6537	.0284	.1676-	.0063-	.0455	.1248-
110	278	1509	20.00	30.00	15.00	17.55	9.87	1.3442	.0215	.3000-	.0111-	.0674	.1916-
110	278	1510	20.00	30.00	30.00	17.61	9.91	1.3402	.0194	.4388-	.0077-	.0529	.1615-
110	278	1511	20.00	30.00	100.00	17.88	10.05	1.3677	.0271	.4482-	.0038-	.0529	.1554-
110	279	1512	10.00	50.00	15.00	6.47	7.66	.4986	.0116	.1281-	.0048-	.0794	.2161-
110	279	1513	10.00	50.00	30.00	6.48	7.66	.4784	.0155	.1186-	.0193-	.0738	.1955-
110	279	1514	10.00	50.00	100.00	6.54	7.73	.4868	.0201	.1230-	.0049-	.0727	.1967-

<sup>†</sup>Minus signs are to the right of the numbers to which they apply.

TABLE III. - AERODYNAMIC COEFFICIENTS OF MODEL FOR THE COMPLETE INVESTIGATION - Continued<sup>†</sup>

Config.	Run	Point	$\alpha_1$ , deg	$\beta$ , deg	q, lb/sq ft	$\alpha$ , deg	$\beta$ , deg	$C_N$	$C_A$	$C_m$	$C_i$	$C_n$	$C_y$
110	280	1515	20.00	50.00	15.00	13.19	15.22	1.0116	.0122	.3125-	.0236-	.1622	.4314-
110	280	1516	20.00	50.00	30.00	13.21	15.24	.9667	.0130	.3023-	.0186-	.1513	.4134-
110	280	1517	20.00	50.00	100.00	13.32	15.36	.9706	.0135	.3047-	.0199-	.1450	.3930-
110	281	1518	10.00	70.00	15.00	3.45	9.39	.2547	.0382	.0601-	.0045	.0999	.2678-
110	281	1519	10.00	70.00	30.00	3.45	9.40	.2270	.0379	.0467-	.0014	.0957	.2503-
110	281	1520	10.00	70.00	100.00	3.46	9.42	.2395	.0357	.0604-	.0004-	.0940	.2485-
110	282	1521	10.00	90.00	15.00	.00	10.00	.0080	.0450	.0026-	.0018	.1087	.2722-
110	282	1522	10.00	90.00	30.00	.00	10.00	.0064	.0419	.0030-	.0028	.1022	.2561-
110	282	1523	10.00	90.00	100.00	.00	10.00	.0081	.0409	.0073-	.0032	.1082	.2619-
120	295	1546	70.00	15.00	16.13	69.53	14.09	2.9747	.0368-	.8063-	.0179-	.0904	.2536-
120	295	1547	80.00	15.00	16.22	79.82	14.77	2.8198	.0163-	1.0619-	.0159-	.0544	.2990-
120	317	1635	70.00	10.00-	16.13	69.89	9.40-	2.9007	.0547-	.7686-	.0364	.0567	.3405
120	317	1636	80.00	10.00-	16.22	80.03	9.85-	2.9145	.0086-	1.1139-	.0173	.0746-	.3621
120	318	1637	70.00	15.00-	16.13	69.51	14.09-	2.8542	.0509-	.7532-	.0254	.0421	.5266
120	318	1638	80.00	15.00-	16.22	79.82	14.77-	2.6993	.0008	1.0706-	.0222	.0056	.4534
130	319	1639	70.00	10.00	16.13	69.90	9.40	3.0832	.0391-	.8752-	.0192-	.0306-	.2859-
130	319	1640	80.00	10.00	16.22	80.03	9.85	2.9126	.0082-	1.1267-	.0170-	.0247-	.3125-
140	325	1651	70.00	10.00-	16.13	69.89	9.40-	2.9222	.0402-	.8159-	.0148	.0528	.3133
140	325	1652	80.00	10.00-	16.22	80.04	9.85-	2.9737	.0123-	1.1364-	.0172	.0167	.2969
140	331	1669	50.00	5.00	15.57	50.06	3.84	2.9063	.0220-	.6838-	.0115	.0290-	.0535-
140	331	1670	60.00	5.00	15.83	60.07	4.33	2.9862	.0460-	.5067-	.0028	.2738	.2287
140	331	1671	70.00	5.00	16.13	70.12	4.70	3.1538	.0406-	.9438-	.0003-	.1394	.0791
140	331	1672	80.00	5.00	16.22	80.15	4.92	3.0539	.0301-	1.1052-	.0032-	.0722	.0227-
140	332	1673	50.00	10.00	15.57	49.74	7.66	3.0114	.0149-	.7343-	.0060	.0624-	.0757-
140	332	1674	60.00	10.00	15.83	59.79	8.66	3.0268	.0476-	.5246-	.0043-	.2100	.0770
140	332	1675	70.00	10.00	16.13	69.90	9.40	3.1045	.0424-	.9157-	.0097-	.1422	.0136-
140	332	1676	80.00	10.00	16.22	80.04	9.85	3.0409	.0286-	1.1351-	.0110-	.0590	.1435-
140	333	1677	50.00	15.00	15.57	49.19	11.46	3.0910	.0144-	.7225-	.0041	.1547-	.1631-
140	333	1678	60.00	15.00	15.83	59.28	12.97	2.7069	.0146-	.7432-	.0154-	.0930-	.4716-
140	333	1679	70.00	15.00	16.13	69.51	14.09	2.8320	.0372-	.7772-	.0187-	.0576	.2921-
140	333	1680	80.00	15.00	16.22	79.82	14.77	2.7914	.0078-	1.0960-	.0141-	.0598	.2866-
140	334	1681	50.00	.00	15.57	50.18	.00	3.1173	.0453-	.5734-	.0056-	.0534-	.0050
140	334	1682	60.00	.00	15.83	60.17	.00	2.9553	.0331-	.7292-	.0016	.0489	.0936
140	334	1683	70.00	.00	16.13	70.19	.00	3.1196	.0351-	.9766-	.0039	.0039	.0279
140	334	1684	80.00	.00	16.22	80.19	.00	3.0739	.0216-	1.1244-	.0024	.0326	.0581
150	326	1653	70.00	10.00	16.13	69.90	9.40	3.0129	.0390-	.8911-	.0178-	.0143-	.2656-
150	326	1654	80.00	10.00	16.22	80.03	9.85	2.9208	.0116-	1.1311-	.0169-	.0116-	.2957-
150	327	1655	70.00	15.00	16.13	69.51	14.09	2.8299	.0408-	.8016-	.0255-	.0294-	.4321-
150	327	1656	80.00	15.00	16.22	79.82	14.77	2.8356	.0005-	1.2582-	.0190-	.0118-	.3833-
150	328	1657	50.00	5.00-	15.57	50.06	3.84-	2.9497	.0188-	.6461-	.0092-	.0568-	.0579-
150	328	1659	70.00	5.00-	16.13	70.11	4.70-	3.0834	.0393-	.9316-	.0075	.0276-	.1333
150	328	1660	80.00	5.00-	16.22	80.16	4.92-	3.0969	.0228-	1.1556-	.0054	.0760-	.0984
150	329	1661	50.00	10.00-	15.57	49.74	7.66-	3.0918	.0475-	.5821-	.0042	.0587	.1530
150	329	1662	60.00	10.00-	15.83	59.79	8.66-	3.0001	.0386-	.6409-	.0149	.0320-	.1887
150	329	1663	70.00	10.00-	16.13	69.89	9.40-	2.9437	.0450-	.8174-	.0141	.0955-	.1090
150	329	1664	80.00	10.00-	16.22	80.04	9.85-	3.0093	.0304-	1.1072-	.0140	.0663-	.1971

<sup>†</sup>Minus signs are to the right of the numbers to which they apply.

TABLE III. - AERODYNAMIC COEFFICIENTS OF MODEL FOR THE COMPLETE INVESTIGATION - Continued<sup>†</sup>

Config.	Run	Point	$\alpha_1$ , deg	$\beta$ , deg	q, lb/sq ft	$\alpha$ , deg	$\beta$ , deg	$C_N$	$C_A$	$C_m$	$C_l$	$C_n$	$C_y$
150	330	1665	50.00	15.00-	15.57	49.18	11.46-	2.9051	.0435-	.5678-	.0080	.1431	.3217
150	330	1666	60.00	15.00-	15.83	59.29	12.97-	2.8304	.0355-	.6469-	.0194	.0746	.4292
150	330	1667	70.00	15.00-	16.13	69.53	14.09-	2.8886	.0452-	.8236-	.0205	.0637-	.3416
150	330	1668	80.00	15.00-	16.22	79.82	14.77-	2.7791	.0071-	1.1033-	.0157	.0869-	.3221
150	335	1685	50.00	.00	15.57	50.18	.00	3.1205	.0384-	.6344-	.0020	.0730-	.2143-
150	335	1686	60.00	.00	15.83	60.18	.00	2.9854	.0306-	.7346-	.0031	.0224-	.0603-
150	335	1687	70.00	.00	16.13	70.19	.00	3.1478	.0450-	1.0197-	.0045-	.2099-	.2990-
150	335	1688	80.00	.00	16.22	80.20	.00	3.0800	.0217-	1.1710-	.0006-	.0435-	.0629-
160	283	1524	80.00	15.00	16.22	79.84	14.77	2.9086	.0319-	1.1097-	.0178-	.0060	.4407-
160	284	1525	80.00	15.00-	16.22	79.82	14.77-	2.8149	.0012	1.3598-	.0121	.0970-	.2999
160	289	1540	70.00	15.00-	16.13	69.51	14.09-	2.8120	.0436-	.8783-	.0211	.0265-	.3819
160	289	1541	70.00	15.00-	21.50	69.57	14.09-	2.7855	.0410-	.9587-	.0219	.0141-	.4035
160	290	1542	70.00	15.00	16.13	69.51	14.09	2.7871	.0431-	.9674-	.0207-	.0844-	.5594-
160	291	1542	70.00	15.00-	16.13	69.53	14.09-	2.8913	.0441-	.9126-	.0222	.0259-	.3812
170	292	1543	70.00	15.00-	16.13	69.53	14.09-	2.8765	.0472-	.9731-	.0219	.0468	.5655
170	293	1544	70.00	15.00	16.13	69.51	14.09	2.8078	.0406-	.8969-	.0216-	.0095	.3634-
200	104	620	.00	.00	15.00	.00	.00	.0614	.0092	.0355-	.0000	.0057	.0236-
200	104	621	.00	.00	20.00	.00	.00	.0332	.0071	.0154-	.0000	.0051	.0184-
200	104	622	.00	.00	30.00	.00	.00	.0299	.0080	.0120-	.0006	.0031	.0142-
200	104	623	.00	.00	40.00	.00	.00	.0093	.0079	.0007-	.0004	.0024	.0096-
200	104	624	.00	.00	60.00	.00	.00	.0061	.0082	.0016	.0004	.0019	.0067-
200	104	625	.00	.00	100.00	.00	.00	.0116	.0083	.0018-	.0003	.0011	.0042-
200	105	626	10.00	.00	15.00	10.01	.00	.1610	.0071	.0382	.0009	.0060	.0247-
200	105	627	10.00	.00	20.00	10.01	.00	.1710	.0081	.0410	.0010	.0022	.0139-
200	105	628	10.00	.00	30.00	10.01	.00	.1388	.0076	.0499	.0009	.0026	.0146-
200	105	629	10.00	.00	40.00	10.01	.00	.1358	.0075	.0501	.0006	.0014	.0080-
200	105	630	10.00	.00	60.00	10.02	.00	.1241	.0078	.0598	.0005	.0010	.0043-
200	105	631	10.00	.00	100.00	10.04	.00	.1250	.0081	.0574	.0005	.0009	.0023-
200	106	632	20.00	.00	15.00	20.02	.00	.4479	.0333-	.0089-	.0039	.0051-	.0008-
200	106	633	20.00	.00	20.00	20.03	.00	.4397	.0320-	.0119-	.0024	.0044-	.0022
200	106	634	20.00	.00	30.00	20.05	.00	.4209	.0319-	.0037-	.0019	.0028-	.0011
200	106	635	20.00	.00	40.00	20.06	.00	.4381	.0330-	.0125-	.0020	.0018-	.0029
200	106	636	20.00	.00	60.00	20.09	.00	.4240	.0328-	.0031-	.0016	.0008-	.0014
200	106	637	20.00	.00	100.00	20.16	.00	.4253	.0329-	.0107	.0014	.0003	.0013
200	107	638	30.00	.00	15.16	30.06	.00	.9916	.0256-	.0927-	.0011	.0176-	.0463
200	107	639	30.00	.00	20.21	30.07	.00	.9477	.0254-	.1291-	.0006	.0343-	.0954
200	107	640	30.00	.00	30.32	30.09	.00	.8429	.0274-	.1110-	.0047	.0088	.0148-
200	107	641	30.00	.00	40.42	30.12	.00	.8210	.0269-	.0907-	.0048	.0199	.0549-
200	107	642	30.00	.00	60.64	30.18	.00	.8209	.0288-	.0666-	.0030	.0038-	.0103
200	107	643	30.00	.00	101.06	30.31	.00	.8379	.0292-	.0471-	.0015	.0122-	.0300
200	108	644	40.00	.00	15.34	40.09	.00	1.5405	.0240-	.0201	.0119	.0642	.4027-
200	108	645	40.00	.00	20.45	40.12	.00	1.5214	.0265-	.0508-	.0109	.0723	.3608-
200	108	646	40.00	.00	30.68	40.15	.00	1.3317	.0320-	.1109-	.0037	.0062	.0302-
200	108	647	40.00	.00	40.90	40.19	.00	1.2543	.0353-	.1398-	.0047	.0433	.1059-
200	109	650	50.00	.00	15.57	50.10	.00	1.7886	.0301-	.0030-	.0072	.2444-	.3447-
200	109	651	50.00	.00	20.76	50.13	.00	1.6999	.0738-	.0739	.0080	.0874-	.3424-
200	109	652	50.00	.00	31.15	50.18	.00	1.5740	.0351-	.0632-	.0003-	.0354-	.0213
200	109	653	50.00	.00	41.53	50.23	.00	1.4929	.0379-	.1128-	.0011	.0247	.0150
200	109	654	50.00	.00	62.29	50.34	.00	1.4836	.0391-	.1452-	.0023	.0607	.0029
200	110	656	60.00	.00	15.83	60.11	.00	1.8215	.0714-	.1444	.0026	.0220-	.1300-
200	110	657	60.00	.00	21.10	60.13	.00	1.6643	.0321-	.1316	.0015	.0567	.0788
200	110	658	60.00	.00	31.65	60.19	.00	1.6324	.0319-	.0636-	.0038	.1013	.1106
200	110	659	60.00	.00	42.20	60.25	.00	1.5920	.0369-	.1265-	.0034	.0778	.0958
200	110	660	60.00	.00	63.30	60.37	.00	1.5737	.0368-	.1618-	.0024	.0679	.0707
200	110	661	60.00	.00	105.50	60.60	.00	1.5235	.0310-	.1312-	.0011-	.0426	.0085

<sup>†</sup>Minus signs are to the right of the numbers to which they apply.

TABLE III. - AERODYNAMIC COEFFICIENTS OF MODEL FOR THE COMPLETE INVESTIGATION - Continued<sup>†</sup>

Config.	Run	Point	$\alpha$ , deg	$\beta$ , deg	q, lb/sq ft	$\alpha$ , deg	$\beta$ , deg	$C_N$	$C_A$	$C_m$	$C_l$	$C_n$	$C_Y$
200	111	662	70.00	.00	16.13	70.10	.00	1.6712	.0672-	.0170-	.0014	.1097	.0706
200	111	663	70.00	.00	21.50	70.13	.00	1.6091	.0746-	.0047-	.0021	.1806	.1633
200	111	664	70.00	.00	32.25	70.19	.00	1.5908	.0787-	.0854-	.0018	.1825	.2076
200	111	665	70.00	.00	43.00	70.24	.00	1.5332	.0777-	.1490-	.0008	.1275	.1259
200	111	666	70.00	.00	64.50	70.37	.00	1.5554	.0887-	.1851-	.0012	.0847	.0866
200	111	667	70.00	.00	107.50	70.60	.00	1.5648	.0904-	.1877-	.0007	.0553	.0390
200	112	668	80.00	.00	16.22	80.11	.00	1.6081	.0474-	.1253-	.0013	.0191	.0726-
200	112	669	80.00	.00	21.62	80.13	.00	1.5596	.0494-	.1133-	.0015	.0133	.0677-
200	112	670	80.00	.00	32.43	80.19	.00	1.5166	.0544-	.1719-	.0011	.0214	.0256-
200	112	671	80.00	.00	43.24	80.24	.00	1.4635	.0573-	.2292-	.0012	.0228	.0143-
200	112	672	80.00	.00	64.86	80.36	.00	1.4958	.0656-	.2912-	.0009	.0215	.0034-
200	112	673	80.00	.00	108.10	80.59	.00	1.4541	.0667-	.3205-	.0007	.0053	.0054-
200	113	674	90.00	.00	16.28	90.10	.00	1.6059	.0039	.4247-	.0000	.0124-	.0092-
200	113	675	90.00	.00	21.70	90.12	.00	1.5031	.0017	.4105-	.0005	.0149-	.0023
200	113	676	90.00	.00	32.55	90.18	.00	1.4841	.0160-	.4369-	.0003	.0149-	.0077-
200	113	677	90.00	.00	43.40	90.23	.00	1.4407	.0322-	.4447-	.0004	.0167	.0430
200	113	678	90.00	.00	65.10	90.35	.00	1.4357	.0380-	.4798-	.0003	.0003	.0366
200	113	679	90.00	.00	108.50	90.56	.00	1.3971	.0460-	.5108-	.0004	.0154	.0498
200	114	680	.00	5.00-	15.00	.00	.00	.0064-	.0069	.0105	.0011-	.0067	.0249-
200	114	681	.00	5.00-	20.00	.00	.00	.0054-	.0077	.0102	.0004-	.0051	.0190-
200	114	682	.00	5.00-	30.00	.00	.00	.0037-	.0081	.0095	.0003-	.0035	.0129-
200	114	683	.00	5.00-	40.00	.00	.00	.0027-	.0071	.0101	.0002-	.0031	.0101-
200	114	684	.00	5.00-	60.00	.00	.00	.0019-	.0073	.0081	.0000	.0024	.0069-
200	114	685	.00	5.00-	100.00	.00	.00	.0010-	.0072	.0080	.0000	.0015	.0029-
200	115	686	10.00	5.00-	15.00	9.97	.87-	.0957	.0047	.0802	.0001-	.0127	.0266-
200	115	687	10.00	5.00-	20.00	9.97	.87-	.0969	.0060	.0744	.0003	.0112	.0227-
200	115	688	10.00	5.00-	30.00	9.97	.87-	.1163	.0070	.0693	.0004	.0100	.0145-
200	115	689	10.00	5.00-	40.00	9.97	.87-	.1065	.0075	.0706	.0003	.0095	.0138-
200	115	690	10.00	5.00-	60.00	9.98	.87-	.1135	.0076	.0685	.0006	.0079	.0083-
200	115	691	10.00	5.00-	100.00	10.00	.87-	.1144	.0074	.0634	.0006	.0061	.0017-
200	116	692	20.00	5.00-	15.00	19.95	1.71-	.4345	.0073-	.0118	.0073	.0210	.0275-
200	116	693	20.00	5.00-	20.00	19.96	1.71-	.4087	.0049-	.0116	.0019	.0182	.0161-
200	116	693	20.00	5.00-	30.00	19.97	1.71-	.4031	.0047-	.0037	.0014	.0166	.0068-
200	116	694	20.00	5.00-	40.00	19.99	1.71-	.3863	.0041-	.0115	.0018	.0145	.0014
200	116	695	20.00	5.00-	60.00	20.02	1.72-	.4086	.0044-	.0030	.0020	.0118	.0096
200	116	696	20.00	5.00-	100.00	20.08	1.72-	.4128	.0040-	.0087	.0022	.0118	.0091
200	117	697	30.00	5.00-	15.16	29.96	2.50-	.9168	.0303-	.0458-	.0034	.0325	.0137-
200	117	698	30.00	5.00-	20.21	29.97	2.50-	.9210	.0296-	.1046-	.0041	.0445	.0400-
200	117	699	30.00	5.00-	30.32	30.00	2.50-	.8534	.0252-	.1239-	.0069	.0875	.1681-
200	117	700	30.00	5.00-	40.42	30.03	2.51-	.8121	.0236-	.1141-	.0070	.0845	.1690-
200	117	701	30.00	5.00-	60.64	30.09	2.51-	.8322	.0244-	.1138-	.0060	.0708	.1268-
200	117	702	30.00	5.00-	101.06	30.21	2.52-	.8327	.0295-	.0823-	.0053	.0420	.0322-
200	118	703	40.00	5.00-	15.34	39.98	3.22-	1.5064	.0409-	.0269-	.0151	.1114	.4251-
200	118	704	40.00	5.00-	20.45	40.00	3.22-	1.4589	.0397-	.1453-	.0176	.1119	.4545-
200	118	705	40.00	5.00-	30.68	40.04	3.22-	1.3354	.0476-	.1818-	.0132	.1220	.3135-
200	118	706	40.00	5.00-	40.90	40.08	3.22-	1.2673	.0473-	.2146-	.0136	.1158	.3264-
200	118	707	40.00	5.00-	61.35	40.18	3.23-	1.2832	.0455-	.2374-	.0148	.1275	.3494-
200	118	708	40.00	5.00-	102.25	40.37	3.24-	1.2734	.0466-	.2003-	.0147	.1211	.3292-
200	119	709	50.00	5.00-	15.57	49.99	3.83-	1.7185	.0629-	.0684	.0115	.0721-	.2905-
200	119	710	50.00	5.00-	20.76	50.02	3.83-	1.7010	.0704-	.0145	.0146	.0158	.2743-
200	119	711	50.00	5.00-	31.15	50.07	3.84-	1.5373	.0778-	.1172-	.0108	.0938	.0890-
200	119	712	50.00	5.00-	41.53	50.12	3.84-	1.5329	.0829-	.1852-	.0110	.1220	.0610-
200	119	713	50.00	5.00-	62.29	50.24	3.85-	1.5142	.0804-	.1980-	.0130	.1127	.1058-
200	119	714	50.00	5.00-	103.82	50.47	3.86-	1.5219	.0785-	.1839-	.0119	.0853	.1280-
200	120	715	60.00	5.00-	15.83	60.00	4.33-	1.7283	.0843-	.1411	.0059	.2233	.3169
200	120	716	60.00	5.00-	21.10	60.03	4.33-	1.6888	.0918-	.0464	.0065	.2478	.3724
200	120	717	60.00	5.00-	31.65	60.09	4.33-	1.5993	.0980-	.0619-	.0073	.2194	.2948
200	120	718	60.00	5.00-	42.20	60.14	4.34-	1.5578	.0933-	.1355-	.0068	.1816	.2543
200	120	719	60.00	5.00-	63.30	60.26	4.34-	1.5427	.0990-	.1321-	.0074	.0599	.0664
200	120	720	60.00	5.00-	105.50	60.51	4.35-	1.5668	.0992-	.1254-	.0063	.0023	.0107-
200	121	721	70.00	5.00-	16.13	70.03	4.70-	1.6204	.0821-	.0001-	.0055	.2003	.2451
200	121	722	70.00	5.00-	21.50	70.05	4.70-	1.5632	.0835-	.0423-	.0049	.2245	.3101
200	121	723	70.00	5.00-	32.25	70.12	4.70-	1.5598	.0815-	.1059-	.0059	.2162	.3084
200	121	724	70.00	5.00-	43.00	70.17	4.70-	1.5186	.0800-	.1599-	.0055	.1427	.2230
200	121	725	70.00	5.00-	64.50	70.29	4.71-	1.5302	.0857-	.2024-	.0059	.0480	.0971
200	121	726	70.00	5.00-	107.50	70.53	4.71-	1.5084	.0894-	.2106-	.0058	.0317	.0146-
200	122	727	80.00	5.00-	16.22	80.07	4.92-	1.7039	.0605-	.1286-	.0050	.0361	.0328
200	122	728	80.00	5.00-	21.62	80.10	4.92-	1.5778	.0634-	.0951-	.0047	.0312	.0461
200	122	729	80.00	5.00-	32.43	80.15	4.92-	1.4860	.0643-	.1727-	.0054	.0128	.0417
200	122	730	80.00	5.00-	43.24	80.21	4.92-	1.4883	.0674-	.2244-	.0057	.0027	.0530
200	122	731	80.00	5.00-	64.86	80.32	4.93-	1.4507	.0627-	.2854-	.0060	.0032	.0557
200	122	732	80.00	5.00-	108.10	80.53	4.93-	1.4071	.0785-	.2976-	.0057	.0003-	.0627

<sup>†</sup> Minus signs are to the right of the numbers to which they apply.

TABLE III. - AERODYNAMIC COEFFICIENTS OF MODEL FOR THE COMPLETE INVESTIGATION - Continued<sup>†</sup>

Config.	Run	Point	$\alpha_1$ , deg	$\beta$ , deg	q, lb/sq ft	$\alpha$ , deg	$\beta$ , deg	$C_N$	$C_A$	$C_m$	$C_l$	$C_n$	$C_y$
200	123	733	90.00	5.00-	16.28	90.09	5.00-	1.5151	.0031-	.3989-	.0036	.0364	.0098
200	123	734	90.00	5.00-	21.70	90.13	5.00-	1.5722	.0100-	.4397-	.0040	.0073	.0398
200	123	735	90.00	5.00-	32.55	90.19	5.00-	1.5445	.0223-	.4396-	.0048	.0220	.0203
200	123	736	90.00	5.00-	43.40	90.23	5.00-	1.4226	.0230-	.4307-	.0042	.0124-	.0248
200	123	737	90.00	5.00-	65.10	90.35	5.00-	1.4496	.0376-	.4629-	.0058	.0056-	.0617
200	123	738	90.00	5.00-	108.50	90.56	5.00-	1.4035	.0430-	.5186-	.0052	.0054	.0825
200	124	739	.00	10.00-	15.00	.00	.00	.0271	.0048	.0111-	.0011	.0025	.0038-
200	124	740	.00	10.00-	20.00	.00	.00	.0058-	.0072	.0063	.0008	.0018	.0031-
200	124	741	.00	10.00-	30.00	.00	.00	.0135	.0071	.0014-	.0006	.0013	.0023-
200	124	742	.00	10.00-	40.00	.00	.00	.0027-	.0068	.0091	.0004	.0018	.0023-
200	124	743	.00	10.00-	60.00	.00	.00	.0022	.0074	.0052	.0004	.0010	.0016-
200	124	744	.00	10.00-	100.00	.00	.00	.0013-	.0073	.0074	.0002	.0003	.0003
200	125	745	10.00	10.00-	15.00	9.86	1.73-	.1142	.0073	.0698	.0021	.0107	.0039
200	125	746	10.00	10.00-	20.00	9.86	1.73-	.1371	.0060	.0579	.0025	.0122	.0007-
200	125	747	10.00	10.00-	30.00	9.86	1.73-	.1177	.0069	.0617	.0016	.0103	.0011
200	125	748	10.00	10.00-	40.00	9.86	1.73-	.1080	.0079	.0687	.0013	.0093	.0051
200	125	749	10.00	10.00-	60.00	9.87	1.73-	.1195	.0075	.0631	.0013	.0101	.0016
200	125	750	10.00	10.00-	100.00	9.88	1.74-	.1157	.0076	.0618	.0011	.0082	.0055
200	126	751	20.00	10.00-	15.00	19.74	3.41-	.4310	.0016-	.0233-	.0031	.0201	.0281
200	126	752	20.00	10.00-	20.00	19.75	3.41-	.4277	.0018-	.0091-	.0040	.0215	.0293
200	126	753	20.00	10.00-	30.00	19.76	3.41-	.3911	.0028-	.0031-	.0032	.0206	.0288
200	126	754	20.00	10.00-	40.00	19.78	3.41-	.3849	.0029-	.0083	.0029	.0174	.0353
200	126	755	20.00	10.00-	60.00	19.81	3.42-	.3913	.0032-	.0160	.0034	.0155	.0412
200	126	756	20.00	10.00-	100.00	19.86	3.43-	.3895	.0027-	.0185	.0031	.0153	.0435
200	127	757	30.00	10.00-	15.16	29.67	4.99-	.9420	.0191-	.0684-	.0090	.0856	.0830-
200	127	758	30.00	10.00-	20.21	29.69	4.99-	.9015	.0184-	.1162-	.0091	.0834	.0834-
200	127	759	30.00	10.00-	30.32	29.71	4.99-	.8233	.0163-	.1408-	.0113	.1063	.1694-
200	127	760	30.00	10.00-	40.42	29.74	5.00-	.8369	.0177-	.1432-	.0114	.1099	.1801-
200	127	761	30.00	10.00-	60.64	29.81	5.01-	.8384	.0182-	.1339-	.0108	.1091	.1704-
200	127	762	30.00	10.00-	101.06	29.93	5.02-	.8366	.0256-	.1021-	.0065	.0763	.0166-
200	128	763	40.00	10.00-	15.34	39.64	6.42-	1.4924	.0318-	.1114-	.0215	.1289	.3118-
200	128	764	40.00	10.00-	20.45	39.67	6.42-	1.4754	.0190-	.1889-	.0219-	.1212	.3362-
200	128	765	40.00	10.00-	30.68	39.70	6.42-	1.2590	.0353-	.1656-	.0216	.1029	.3710-
200	128	766	40.00	10.00-	40.90	39.75	6.43-	1.2997	.0373-	.2475-	.0199	.1063	.3363-
200	128	767	40.00	10.00-	61.35	39.85	6.44-	1.2986	.0395-	.2562-	.0215	.1103	.3452-
200	128	768	40.00	10.00-	102.25	40.05	6.47-	1.3134	.0394-	.2173-	.0224	.0939	.3293-
200	129	769	50.00	10.00-	15.57	49.66	7.65-	1.6715	.0640-	.1672	.0190	.1463	.0775
200	129	770	50.00	10.00-	20.76	49.70	7.66-	1.7029	.0600-	.0388	.0205	.1510	.0018
200	129	771	50.00	10.00-	31.15	49.73	7.66-	1.4451	.0620-	.0974-	.0165	.1122	.0065
200	129	772	50.00	10.00-	41.53	49.79	7.67-	1.4656	.0705-	.1778-	.0181	.1311	.0294-
200	129	773	50.00	10.00-	62.29	49.91	7.68-	1.4966	.0723-	.2021-	.0192	.1077	.0937-
200	129	774	50.00	10.00-	103.82	50.12	7.70-	1.4476	.0727-	.1512-	.0175	.0646	.1209-
200	130	775	60.00	10.00-	15.83	59.72	8.65-	1.6756	.0714-	.0506	.0132	.2491	.4757
200	130	776	60.00	10.00-	21.10	59.74	8.66-	1.5892	.0787-	.0354	.0112	.2343	.4291
200	130	777	60.00	10.00-	31.65	59.80	8.66-	1.5416	.0964-	.0554-	.0129	.2465	.4257
200	130	778	60.00	10.00-	42.20	59.85	8.67-	1.4912	.0964-	.1119-	.0128	.2126	.3459
200	130	779	60.00	10.00-	63.30	59.96	8.68-	1.4931	.0894-	.1305-	.0130	.0907	.1412
200	130	780	60.00	10.00-	105.50	60.20	8.70-	1.5126	.0400-	.1110-	.0111	.0220	.0244
200	131	781	70.00	10.00-	16.13	69.80	9.39-	1.5154	.0666-	.0383	.0105	.1900	.3692
200	131	782	70.00	10.00-	21.50	69.84	9.40-	1.5256	.0730-	.0495-	.0114	.2496	.4414
200	131	783	70.00	10.00-	32.25	69.89	9.40-	1.4641	.0703-	.1032-	.0129	.2479	.4376
200	131	784	70.00	10.00-	43.00	69.94	9.40-	1.4277	.0393-	.1473-	.0109	.1582	.3387
200	131	785	70.00	10.00-	64.50	70.06	9.41-	1.4556	.0809-	.1762-	.0114	.0501	.1927
200	131	786	70.00	10.00-	107.50	70.29	9.42-	1.4421	.0867-	.1813-	.0110	.0127	.1334
200	132	787	80.00	10.00-	16.22	79.95	9.85-	1.5193	.0464-	.0504-	.0115	.0547	.1886
200	132	788	80.00	10.00-	21.62	79.98	9.85-	1.5445	.0573-	.0634-	.0118	.0682	.1778
200	132	789	80.00	10.00-	32.43	80.03	9.85-	1.4042	.0556-	.1144-	.0109	.0238	.1682
200	132	790	80.00	10.00-	43.24	80.09	9.85-	1.4349	.0550-	.1911-	.0118	.0033	.1490
200	132	791	80.00	10.00-	64.86	80.20	9.85-	1.4377	.0607-	.2594-	.0117	.0046	.1529
200	132	792	80.00	10.00-	108.10	80.40	9.86-	1.3706	.0651-	.2819-	.0110	.0115	.1494
200	133	793	90.00	10.00-	16.28	90.09	10.00-	1.4983	.0061	.3717-	.0092	.0581	.2093
200	133	794	90.00	10.00-	21.70	90.12	10.00-	1.5221	.0002-	.3741-	.0098	.0479	.2036
200	133	795	90.00	10.00-	32.55	90.17	10.00-	1.4102	.0088-	.3770-	.0102	.0258	.1748
200	133	796	90.00	10.00-	43.40	90.22	10.00-	1.3820	.0219-	.3846-	.0100	.0134	.1466
200	133	797	90.00	10.00-	65.10	90.33	10.00-	1.3877	.0345-	.4224-	.0103	.0167-	.1219
200	133	798	90.00	10.00-	108.50	90.54	10.00-	1.3462	.0414-	.4753-	.0056	.0092-	.1380
200	134	799	.00	15.00-	15.00	.00	.00	.0056-	.0084	.0062-	.0001	.0056	.0132-
200	134	800	.00	15.00-	20.00	.00	.00	.0088	.0071	.0099-	.0000	.0042	.0100-
200	134	801	.00	15.00-	30.00	.00	.00	.0031-	.0077	.0002-	.0000	.0024	.0068-
200	134	802	.00	15.00-	40.00	.00	.00	.0026-	.0080	.0020	.0002	.0019	.0054-
200	134	803	.00	15.00-	60.00	.00	.00	.0017-	.0077	.0040	.0001	.0006	.0012-
200	134	804	.00	15.00-	100.00	.00	.00	.0010-	.0076	.0044	.0002	.0009	.0010-

<sup>†</sup> Minus signs are to the right of the numbers to which they apply.

L-905



TABLE III. - AERODYNAMIC COEFFICIENTS OF MODEL FOR THE COMPLETE INVESTIGATION - Continued<sup>†</sup>

Config.	Run	Point	$\alpha_1$ , deg	$\beta$ , deg	$q$ , lb/sq ft	$\alpha$ , deg	$\beta$ , deg	$C_N$	$C_A$	$C_m$	$C_i$	$C_n$	$C_Y$
200	135	805	10.00	15.00-	15.00	9.67	2.58-	.1163	.0067	.0524	.0024	.0207	.0166-
200	135	806	10.00	15.00-	20.00	9.67	2.58-	.1394	.0076	.0447	.0016	.0132	.0006
200	135	807	10.00	15.00-	30.00	9.67	2.58-	.1284	.0080	.0558	.0017	.0147	.0005
200	135	808	10.00	15.00-	40.00	9.68	2.58-	.1161	.0079	.0570	.0017	.0142	.0012
200	135	809	10.00	15.00-	60.00	9.68	2.58-	.1127	.0076	.0622	.0015	.0135	.0039
200	135	810	10.00	15.00-	100.00	9.70	2.59-	.1172	.0073	.0590	.0016	.0121	.0065
200	136	811	20.00	15.00-	15.00	19.39	5.08-	.4366	.0021-	.0317-	.0039	.0338	.0264
200	136	812	20.00	15.00-	20.00	19.40	5.08-	.4340	.0017-	.0306-	.0042	.0315	.0371
200	136	813	20.00	15.00-	30.00	19.41	5.09-	.3964	.0018-	.0181-	.0039	.0280	.0439
200	136	814	20.00	15.00-	40.00	19.42	5.09-	.3718	.0014-	.0005-	.0033	.0275	.0465
200	136	815	20.00	15.00-	60.00	19.45	5.09-	.3776	.0025-	.0076	.0031	.0268	.0562
200	136	816	20.00	15.00-	100.00	19.50	5.11-	.3723	.0022-	.0175	.0036	.0339	.0290
200	137	817	30.00	15.00-	15.16	29.15	7.43-	.0870	.0073-	.3465	.0128	.1247	.1629-
200	137	818	30.00	15.00-	20.21	29.22	7.45-	.9205	.0131-	.1650-	.0120	.1175	.1386-
200	137	819	30.00	15.00-	30.32	29.64	7.45-	.8314	.0049-	.1747-	.0129	.1293	.1807-
200	137	820	30.00	15.00-	40.42	29.27	7.46-	.8457	.0070-	.1863-	.0141	.1389	.1969-
200	137	821	30.00	15.00-	60.64	29.33	7.47-	.8505	.0124-	.1824-	.0144	.1401	.1723-
200	137	822	30.00	15.00-	101.06	29.44	7.50-	.8417	.0155-	.1620-	.0115	.1413	.0684-
200	138	823	40.00	15.00-	15.34	39.09	9.59-	1.3665	.0386-	.0922-	.0178	.1455	.0807-
200	138	824	40.00	15.00-	20.45	39.13	9.60-	1.4925	.0321-	.2287-	.0240	.1825	.3043-
200	138	825	40.00	15.00-	30.68	39.16	9.60-	1.2529	.0276-	.1692-	.0242	.0716	.3563-
200	138	826	40.00	15.00-	40.90	39.21	9.61-	1.2839	.0328-	.2314-	.0245	.0879	.3506-
200	138	827	40.00	15.00-	61.35	39.30	9.63-	1.2803	.0334-	.2598-	.0247	.1026	.3389-
200	138	828	40.00	15.00-	102.25	39.51	9.67-	1.3289	.0343-	.2278-	.0263	.0966	.3069-
200	139	829	50.00	15.00-	15.57	49.11	11.45-	1.6207	.0513-	.0398	.0211	.1625	.1179
200	139	830	50.00	15.00-	20.76	49.14	11.45-	1.6356	.0544-	.0101-	.0207	.1181	.1395
200	139	831	50.00	15.00-	31.15	49.19	11.46-	1.4996	.0602-	.1415-	.0205	.0860	.0308
200	139	832	50.00	15.00-	41.53	49.25	11.47-	1.5299	.0631-	.2300-	.0211	.0817	.0054
200	139	833	50.00	15.00-	62.29	49.36	11.49-	1.5467	.0592-	.2469-	.0214	.0421	.0233-
200	139	834	50.00	15.00-	103.82	49.58	11.53-	1.5117	.0621-	.1857-	.0217	.0262	.0439-
200	140	835	60.00	15.00-	15.83	59.22	12.96-	1.5861	.0789-	.0342	.0142	.2658	.4782
200	140	836	60.00	15.00-	21.10	59.25	12.97-	1.5650	.0840-	.0274-	.0137	.2683	.5023
200	140	837	60.00	15.00-	31.65	59.29	12.97-	1.4152	.0867-	.0495-	.0153	.2657	.4654
200	140	838	60.00	15.00-	42.20	59.34	12.98-	1.3814	.0854-	.0896-	.0148	.2104	.3663
200	140	839	60.00	15.00-	63.30	59.47	12.99-	1.4357	.0874-	.1138-	.0145	.1088	.2111
200	140	840	60.00	15.00-	105.50	59.67	13.02-	1.4104	.0864-	.0926-	.0131	.0433	.1141
200	141	841	70.00	15.00-	16.13	69.44	14.08-	1.4748	.0745-	.0309	.0123	.1999	.3980
200	141	842	70.00	15.00-	21.50	69.46	14.09-	1.4214	.0772-	.0664-	.0129	.2671	.5011
200	141	843	70.00	15.00-	32.25	69.50	14.09-	1.3203	.0708-	.1191-	.0132	.2634	.4949
200	141	844	70.00	15.00-	43.00	69.56	14.09-	1.3277	.0785-	.1483-	.0117	.1727	.3939
200	141	845	70.00	15.00-	64.50	69.67	14.10-	1.3639	.0917-	.1504-	.0135	.1041	.3034
200	141	846	70.00	15.00-	107.50	69.90	14.12-	1.3708	.0906-	.1565-	.0137	.0484	.2226
200	142	847	80.00	15.00-	16.22	79.74	14.77-	1.3931	.0484-	.0952	.0120	.0749	.2712
200	142	848	80.00	15.00-	21.62	79.77	14.77-	1.4539	.0650-	.0551-	.0123	.0904	.3044
200	142	849	80.00	15.00-	32.43	79.82	14.77-	1.3547	.0540-	.1317-	.0125	.0608	.2598
200	142	850	80.00	15.00-	43.24	79.88	14.78-	1.3840	.0635-	.1720-	.0132	.0118	.2076
200	142	851	80.00	15.00-	64.86	79.98	14.78-	1.3283	.0692-	.2146-	.0134	.0179	.2096
200	142	852	80.00	15.00-	108.10	80.18	14.79-	1.3029	.0759-	.2489-	.0135	.0175	.1827
200	143	853	90.00	15.00-	16.28	90.08	15.00-	1.3982	.0010-	.3703-	.0107	.0544	.2887
200	143	854	90.00	15.00-	21.70	90.11	15.00-	1.3568	.0017-	.3747-	.0121	.0717	.3049
200	143	855	90.00	15.00-	32.55	90.15	15.00-	1.2957	.0103-	.3744-	.0121	.0791	.3187
200	143	856	90.00	15.00-	43.40	90.21	15.00-	1.3022	.0243-	.3816-	.0131	.0368	.2752
200	143	857	90.00	15.00-	65.10	90.32	15.00-	1.3113	.0349-	.4083-	.0133	.0068	.2458
200	143	858	90.00	15.00-	108.56	90.52	15.00-	1.2965	.0454-	.4745-	.0131	.0177-	.2078
200	144	859	.00	20.00-	15.00	.00	.00	.0821	.0057	.0496-	.0000	.0030	.0022-
200	144	860	.00	20.00-	20.00	.00	.00	.0616	.0069	.0372-	.0000	.0023	.0016-
200	144	861	.00	20.00-	30.00	.00	.00	.0329	.0064	.0186-	.0000	.0015	.0013-
200	144	862	.00	20.00-	40.00	.00	.00	.0177	.0072	.0052-	.0000	.0017	.0016-
200	144	863	.00	20.00-	60.00	.00	.00	.0163	.0071	.0060-	.0000	.0014	.0011-
200	144	864	.00	20.00-	100.00	.00	.00	.0097	.0070	.0011-	.0001	.0006	.0007
200	145	865	10.00	20.00-	15.00	9.41	3.41-	.1713	.0051	.0191	.0023	.0191	.0050
200	145	866	10.00	20.00-	20.00	9.41	3.41-	.1713	.0018	.0762-	.0023	.0156	.0177
200	145	867	10.00	20.00-	30.00	9.41	3.41-	.1311	.0064	.0435	.0017	.0180	.0062
200	145	868	10.00	20.00-	40.00	9.42	3.41-	.1247	.0064	.0503	.0019	.0166	.0087
200	145	869	10.00	20.00-	60.00	9.42	3.41-	.1188	.0067	.0547	.0020	.0165	.0089
200	145	870	10.00	20.00-	100.00	9.44	3.42-	.1139	.0069	.0575	.0020	.0164	.0091
200	146	871	20.00	20.00-	15.00	18.90	6.72-	.4471	.0045-	.0481-	.0030	.0502	.0354
200	146	872	20.00	20.00-	20.00	18.91	6.72-	.4424	.0035-	.0554-	.0044	.0465	.0443
200	146	873	20.00	20.00-	30.00	18.92	6.73-	.3952	.0014-	.0322-	.0044	.0416	.0533
200	146	874	20.00	20.00-	40.00	18.93	6.73-	.3908	.0014-	.0262-	.0049	.0440	.0451
200	146	875	20.00	20.00-	60.00	18.96	6.74-	.3827	.0008-	.0182-	.0048	.0432	.0451
200	146	876	20.00	20.00-	100.00	19.00	6.76-	.3782	.0009-	.0071-	.0049	.0437	.0444

<sup>†</sup> Minus signs are to the right of the numbers to which they apply.

L-905

TABLE III - AERODYNAMIC COEFFICIENTS OF MODEL FOR THE COMPLETE INVESTIGATION - Continued<sup>†</sup>

Config.	Run	Point	$\alpha$ , deg	$\beta$ , deg	q, lb/sq ft	$\alpha$ , deg	$\beta$ , deg	$C_N$	$C_A$	$C_m$	$C_i$	$C_n$	$C_Y$
200	147	877	30.00	20.00	15.16	28.53	9.86	.9375	.0114	.1916	.0138	.1267	.1193
200	147	878	30.00	20.00	20.21	28.54	9.86	.9193	.0123	.2101	.0121	.1271	.0981
200	147	879	30.00	20.00	30.32	28.57	9.87	.8212	.0119	.2006	.0129	.1383	.1137
200	147	880	30.00	20.00	40.42	28.60	9.88	.8178	.0082	.2285	.0151	.1649	.1696
200	147	881	30.00	20.00	60.64	28.66	9.90	.8571	.0058	.2327	.0171	.1751	.1641
200	147	882	30.00	20.00	101.06	28.76	9.93	.8372	.0115	.2000	.0140	.1645	.0539
200	148	883	40.00	20.00	15.34	38.33	12.72	1.4497	.0295	.2264	.0236	.1887	.2095
200	148	884	40.00	20.00	20.45	38.35	12.72	1.4589	.0262	.2752	.0253	.1819	.2763
200	148	885	40.00	20.00	30.68	38.39	12.74	1.3054	.0279	.1987	.0274	.0765	.3375
200	148	886	40.00	20.00	40.90	38.43	12.75	1.2399	.0277	.2151	.0249	.0473	.3066
200	148	887	40.00	20.00	61.35	38.51	12.77	1.2170	.0290	.2590	.0258	.1001	.2689
200	148	888	40.00	20.00	102.25	38.70	12.82	1.3015	.0322	.2476	.0288	.1260	.2257
200	149	889	50.00	20.00	15.57	48.32	15.21	1.6682	.0499	.0782	.0243	.0571	.1917
200	149	890	50.00	20.00	20.76	48.34	15.21	1.5894	.0458	.0994	.0220	.0426	.2055
200	149	891	50.00	20.00	31.15	48.40	15.23	1.5701	.0467	.1681	.0227	.0114	.1283
200	149	892	50.00	20.00	41.53	48.45	15.24	1.5385	.0487	.2291	.0232	.0036	.1317
200	149	893	50.00	20.00	62.29	48.58	15.27	1.5652	.0490	.2547	.0235	.0259	.1043
200	149	894	50.00	20.00	103.82	48.78	15.31	1.4892	.0496	.2380	.0223	.0252	.1185
200	150	895	60.00	20.00	15.83	58.51	17.24	1.4675	.0767	.0322	.0177	.3090	.5493
200	150	896	60.00	20.00	21.10	58.54	17.25	1.4200	.0747	.0676	.0174	.2724	.5106
200	150	897	60.00	20.00	31.65	58.59	17.26	1.4053	.0783	.0911	.0182	.2431	.4724
200	150	898	60.00	20.00	42.20	58.64	17.27	1.3725	.0753	.1235	.0173	.2021	.4247
200	150	899	60.00	20.00	63.30	58.75	17.29	1.4248	.0772	.1290	.0188	.0807	.2474
200	150	900	60.00	20.00	105.50	58.96	17.32	1.3945	.0786	.1169	.0185	.0396	.1857
200	151	901	70.00	20.00	16.13	68.92	18.76	1.5239	.0794	.0161	.0172	.2255	.4770
200	151	902	70.00	20.00	21.50	68.94	18.76	1.4161	.0789	.0788	.0167	.2526	.5321
200	151	903	70.00	20.00	32.25	68.98	18.77	1.3255	.0839	.1811	.0185	.2869	.6041
200	151	904	70.00	20.00	43.00	69.01	18.77	1.2355	.0837	.1915	.0179	.2421	.5489
200	151	905	70.00	20.00	64.50	69.14	18.79	1.3163	.0853	.1934	.0184	.1508	.4189
200	151	906	70.00	20.00	107.50	69.34	18.81	1.2985	.0885	.1953	.0183	.1000	.3575
200	152	907	80.00	20.00	16.22	79.46	19.69	1.4936	.0625	.0680	.0176	.0954	.3621
200	152	908	80.00	20.00	21.62	79.49	19.69	1.4614	.0654	.0857	.0175	.0953	.3753
200	152	909	80.00	20.00	32.43	79.54	19.69	1.3498	.0605	.1664	.0186	.1104	.3949
200	152	910	80.00	20.00	43.24	79.59	19.70	1.3152	.0596	.1935	.0184	.0823	.3694
200	152	911	80.00	20.00	64.86	79.68	19.70	1.2798	.0682	.2130	.0183	.0271	.2862
200	152	912	80.00	20.00	108.10	79.88	19.71	1.2591	.0671	.2567	.0186	.0171	.2571
200	153	913	90.00	20.00	16.28	90.08	20.00	1.4320	.0023	.3771	.0179	.0538	.3610
200	153	914	90.00	20.00	21.70	90.12	20.00	1.4115	.0038	.3031	.0176	.0581	.3738
200	153	915	90.00	20.00	32.55	90.16	20.00	1.3078	.0085	.4123	.0184	.0858	.4267
200	153	916	90.00	20.00	43.40	90.20	20.00	1.2638	.0172	.4222	.0179	.0770	.4137
200	153	917	90.00	20.00	65.10	90.30	20.00	1.2524	.0309	.4031	.0184	.0329	.3360
200	153	918	90.00	20.00	108.50	90.51	20.00	1.2641	.0478	.4268	.0175	.0311	.2349
200	154	919	.00	30.00	15.00	.00	.00	.0045	.0066	.0014	.0001	.0057	.0137
200	154	920	.00	30.00	20.00	.00	.00	.0034	.0076	.0031	.0001	.0045	.0105
200	154	921	.00	30.00	30.00	.00	.00	.0019	.0080	.0033	.0000	.0020	.0019
200	154	922	.00	30.00	40.00	.00	.00	.0017	.0083	.0056	.0000	.0012	.0016
200	154	923	.00	30.00	60.00	.00	.00	.0013	.0085	.0072	.0002	.0012	.0015
200	154	924	.00	30.00	100.00	.00	.00	.0008	.0077	.0059	.0001	.0009	.0011
200	155	925	10.00	30.00	15.00	8.68	4.98	.0889	.0079	.0652	.0030	.0261	.0133
200	155	926	10.00	30.00	20.00	8.69	4.98	.0938	.0102	.0681	.0027	.0265	.0098
200	155	927	10.00	30.00	30.00	8.69	4.98	.0908	.0094	.0661	.0024	.0245	.0096
200	155	928	10.00	30.00	40.00	8.69	4.98	.0892	.0085	.0641	.0024	.0224	.0156
200	155	929	10.00	30.00	60.00	8.69	4.99	.0914	.0078	.0639	.0029	.0218	.0183
200	155	930	10.00	30.00	100.00	8.70	4.99	.0910	.0009	.0643	.0028	.0223	.0199
200	156	931	20.00	30.00	15.00	17.51	9.85	.3670	.0053	.0252	.0076	.0748	.0318
200	156	932	20.00	30.00	20.00	17.51	9.85	.3447	.0042	.0212	.0074	.0641	.0495
200	156	933	20.00	30.00	30.00	17.52	9.86	.3258	.0041	.0150	.0060	.0641	.0457
200	156	934	20.00	30.00	40.00	17.53	9.86	.3144	.0034	.0101	.0075	.0667	.0426
200	156	935	20.00	30.00	60.00	17.55	9.87	.3255	.0041	.0155	.0080	.0695	.0372
200	156	936	20.00	30.00	100.00	17.58	9.89	.3270	.0031	.0120	.0080	.0698	.0406
200	157	937	30.00	30.00	15.16	26.60	14.49	.7437	.0015	.1552	.0184	.1648	.0207
200	157	938	30.00	30.00	20.21	26.61	14.50	.7466	.0000	.1741	.0201	.1691	.0423
200	157	939	30.00	30.00	30.32	26.63	14.51	.7238	.0011	.1921	.0216	.1762	.0734
200	157	940	30.00	30.00	40.42	26.65	14.52	.7196	.0003	.2187	.0209	.1832	.0650
200	157	941	30.00	30.00	60.64	26.70	14.54	.7279	.0004	.2297	.0207	.2005	.0479
200	157	942	30.00	30.00	101.06	26.79	14.58	.7311	.0036	.2076	.0200	.1871	.0026
200	158	943	40.00	30.00	15.34	36.06	18.77	1.2546	.0179	.1769	.0345	.1286	.1196
200	158	944	40.00	30.00	20.45	36.07	18.78	1.2490	.0176	.1610	.0345	.0986	.0882
200	158	945	40.00	30.00	30.68	36.11	18.80	1.1780	.0197	.1788	.0326	.0834	.1223
200	158	946	40.00	30.00	40.90	36.14	18.81	1.1418	.0208	.2090	.0340	.0869	.1662
200	158	947	40.00	30.00	61.35	36.22	18.84	1.1714	.0256	.3001	.0350	.1621	.1165
200	158	948	40.00	30.00	102.25	36.37	18.90	1.1512	.0253	.2840	.0320	.1497	.0081

<sup>†</sup>Minus signs are to the right of the numbers to which they apply.

I-905

TABLE III. - AERODYNAMIC COEFFICIENTS OF MODEL FOR THE COMPLETE INVESTIGATION - Continued<sup>†</sup>

Config.	Run	Point	$\alpha_1$ , deg	$\beta$ , deg	q, lb/sq ft	$\alpha$ , deg	$\beta$ , deg	C <sub>N</sub>	C <sub>A</sub>	C <sub>m</sub>	C <sub>i</sub>	C <sub>n</sub>	C <sub>y</sub>
200	159	949	50.00	30.00-	15.57	45.97	22.55-	1.4228	.0340-	.0037	.0295	.0416	.2036
200	159	950	50.00	30.00-	20.76	45.99	22.55-	1.3583	.0319-	.0091	.0290	.0010	.2467
200	159	951	50.00	30.00-	31.15	46.04	22.57-	1.3797	.0353-	.0109	.0308	.0011	.1251
200	159	952	50.00	30.00-	41.53	46.08	22.59-	1.3571	.0349-	.0403-	.0300	.0252-	.1047
200	159	953	50.00	30.00-	62.29	46.18	22.62-	1.3852	.0424-	.1961-	.0275	.0204-	.2516
200	159	954	50.00	30.00-	103.82	46.36	22.68-	1.3542	.0497-	.1700-	.0273	.0286	.2759
200	160	955	60.00	30.00-	15.83	56.37	25.68-	1.2468	.0611-	.0089	.0255	.2924	.7097
200	160	956	60.00	30.00-	21.10	56.40	25.68-	1.1369	.0539-	.0233-	.0250	.2536	.6063
200	160	957	60.00	30.00-	31.65	56.44	25.69-	1.1618	.0551-	.0530-	.0253	.1999	.5420
200	160	958	60.00	30.00-	42.20	56.49	25.71-	1.2431	.0553-	.0820-	.0274	.1314	.4489
200	160	959	60.00	30.00-	63.30	56.57	25.73-	1.1921	.0536-	.0709-	.0277	.0693	.2847
200	160	960	60.00	30.00-	105.50	56.75	25.77-	1.2160	.0581-	.0858-	.0274	.0684	.3834
200	161	961	70.00	30.00-	16.13	67.27	28.04-	1.1835	.0662-	.0304	.0236	.2154	.6227
200	161	962	70.00	30.00-	21.50	67.28	28.04-	1.0656	.0646-	.0848-	.0240	.2447	.6606
200	161	963	70.00	30.00-	32.25	67.32	28.05-	1.0293	.0713-	.1707-	.0254	.2547	.6806
200	162	967	80.00	30.00-	16.22	78.56	29.51-	1.2021	.0543-	.0125-	.0254	.1191	.5531
200	162	968	80.00	30.00-	21.62	78.59	29.51-	1.1418	.0577-	.0530-	.0257	.1411	.5601
200	162	969	80.00	30.00-	32.43	78.62	29.51-	1.0198	.0533-	.1480-	.0250	.1345	.5571
200	162	970	80.00	30.00-	43.24	78.66	29.52-	1.0284	.0525-	.2017-	.0254	.1281	.5605
200	162	971	80.00	30.00-	64.86	78.76	29.52-	1.0848	.0647-	.1802-	.0280	.0592	.4270
200	162	972	80.00	30.00-	108.10	78.93	29.54-	1.0997	.0686-	.2181-	.0277	.0376	.4024
200	163	973	90.00	30.00-	16.28	90.07	30.00-	1.1199	.0142	.2978-	.0257	.0442	.4864
200	163	974	90.00	30.00-	21.70	90.08	30.00-	1.0707	.0166	.2998-	.0251	.0452	.4867
200	163	975	90.00	30.00-	32.55	90.13	30.00-	1.0550	.0109	.3492-	.0260	.0550	.4766
200	163	976	90.00	30.00-	43.40	90.17	30.00-	1.0620	.0003	.4018-	.0275	.0632	.4668
200	163	977	90.00	30.00-	65.10	90.25	30.00-	1.0567	.0203-	.3609-	.0280	.0011	.2849
200	163	978	90.00	30.00-	108.50	90.41	30.00-	1.0388	.0299-	.3679-	.0274	.0121-	.2654
200	164	979	60.00	5.00	15.83	60.00	4.33	1.7732	.0680-	.1444	.0063-	.1991-	.2288-
200	164	980	60.00	5.00	21.10	60.03	4.33	1.7175	.0777-	.0256	.0047-	.1574-	.2470-
200	164	981	60.00	5.00	31.65	60.09	4.33	1.6079	.0869-	.1034-	.0035-	.0869-	.1226-
200	164	982	60.00	5.00	42.20	60.13	4.34	1.5043	.0875-	.1308-	.0024-	.0297-	.0295-
200	164	983	60.00	5.00	63.30	60.26	4.34	1.5434	.0961-	.1476-	.0025-	.0171	.0250
200	164	984	60.00	5.00	105.50	60.50	4.35	1.5529	.0950-	.1241-	.0024-	.0244	.0303
200	165	985	70.00	5.00	16.13	70.03	4.70	1.6028	.0650-	.0262	.0027-	.0695	.0203
200	165	986	70.00	5.00	21.50	70.06	4.70	1.6832	.0771-	.0044-	.0032-	.1156	.0868
200	165	987	70.00	5.00	32.25	70.12	4.70	1.5563	.0785-	.0920-	.0043-	.1075	.0814
200	165	988	70.00	5.00	43.00	70.17	4.70	1.5179	.0828-	.1406-	.0043-	.0807	.0354
200	165	989	70.00	5.00	64.50	70.30	4.71	1.5514	.0879-	.1751-	.0038-	.0572	.0080
200	165	990	70.00	5.00	107.50	70.52	4.71	1.4858	.0864-	.1805-	.0026-	.0404	.0907-
200	166	991	80.00	5.00	16.22	80.07	4.92	1.5904	.0606-	.0280-	.0037-	.0216-	.1022-
200	166	992	80.00	5.00	21.62	80.10	4.92	1.5887	.0598-	.0544-	.0034-	.0142	.0722-
200	166	993	80.00	5.00	32.43	80.15	4.92	1.5036	.0632-	.1643-	.0041-	.0079	.0596-
200	166	994	80.00	5.00	43.24	80.20	4.92	1.4550	.0591-	.2147-	.0038-	.0066	.0606-
200	166	995	80.00	5.00	64.86	80.32	4.93	1.4517	.0719-	.2791-	.0043-	.0013-	.0608-
200	166	996	80.00	5.00	108.10	80.53	4.93	1.4088	.0740-	.2903-	.0038-	.0109	.0566-
200	167	997	90.00	5.00	16.28	90.10	5.00	1.6223	.0021-	.4167-	.0024-	.0336-	.0817-
200	167	998	90.00	5.00	21.70	90.13	5.00	1.5902	.0061-	.4123-	.0035-	.0214-	.0623-
200	167	999	90.00	5.00	32.55	90.18	5.00	1.4893	.0146-	.4148-	.0044-	.0302-	.0671-
200	167	1000	90.00	5.00	43.40	90.23	5.00	1.4391	.0253-	.4162-	.0043-	.0325-	.0700-
200	167	1001	90.00	5.00	65.10	90.35	5.00	1.4643	.0387-	.4766-	.0041-	.0021	.0248-
200	167	1002	90.00	5.00	108.50	90.56	5.00	1.5943	.0451-	.5037-	.0038-	.0146	.0033-
200	168	1003	60.00	10.00	15.83	59.72	8.65	1.7073	.0686-	.0914	.0121-	.2499-	.4657-
200	168	1004	60.00	10.00	21.10	59.74	8.66	1.6201	.0713-	.0058-	.0104-	.2097-	.2946-
200	168	1005	60.00	10.00	31.65	59.80	8.66	1.5280	.0772-	.0541-	.0097-	.1397-	.2728-
200	168	1006	60.00	10.00	42.20	59.85	8.67	1.5202	.0839-	.1109-	.0094-	.0876-	.1726-
200	168	1007	60.00	10.00	63.30	59.97	8.68	1.5117	.0988-	.1137-	.0085-	.0131	.0042
200	168	1008	60.00	10.00	105.50	60.21	8.70	1.5289	.0956-	.1390-	.0078-	.0355-	.0411-
200	169	1009	70.00	10.00	16.13	69.82	9.39	1.6164	.0685-	.0230	.0094-	.1835-	.3906-
200	169	1010	70.00	10.00	21.50	69.84	9.40	1.5843	.0691-	.0593-	.0092-	.2082-	.4246-
200	169	1011	70.00	10.00	32.25	69.90	9.40	1.5098	.0779-	.1066-	.0095-	.0852-	.2619-
200	169	1012	70.00	10.00	43.00	69.96	9.40	1.5099	.0797-	.1021-	.0091-	.0532	.0861-
200	169	1013	70.00	10.00	64.50	70.07	9.41	1.4794	.0877-	.1742-	.0097-	.0414-	.1726-
200	169	1014	70.00	10.00	107.50	70.31	9.42	1.5136	.0947-	.1704-	.0079-	.0486-	.1562-
200	170	1015	80.00	10.00	16.22	79.95	9.85	1.5360	.0550-	.0478-	.0074-	.0434-	.2148-
200	170	1016	80.00	10.00	21.62	79.98	9.85	1.5109	.0583-	.0579-	.0078-	.0287-	.1743-
200	170	1017	80.00	10.00	32.43	80.03	9.85	1.4725	.0601-	.1319-	.0083-	.0046	.1329-
200	170	1018	80.00	10.00	43.24	80.09	9.85	1.4357	.0565-	.2116-	.0090-	.0188-	.1603-
200	170	1019	80.00	10.00	64.86	80.20	9.85	1.4167	.0629-	.2530-	.0095-	.0069-	.1321-
200	170	1020	80.00	10.00	108.10	80.46	9.86	1.3799	.0633-	.2663-	.0089-	.0120	.1136-

<sup>†</sup>Minus signs are to the right of the numbers to which they apply.

TABLE III. - AERODYNAMIC COEFFICIENTS OF MODEL FOR THE COMPLETE INVESTIGATION - Continued †

Config.	Run	Point	$\alpha$ , deg	$\beta$ , deg	q, lb/sq ft	$\alpha$ , deg	$\beta$ , deg	C <sub>N</sub>	C <sub>A</sub>	C <sub>m</sub>	C <sub>i</sub>	C <sub>n</sub>	C <sub>y</sub>
200	171	1021	90.00	10.00	16.28	90.09	10.00	1.5440	.0003-	.3855-	.0071-	.0433-	.1910-
200	171	1022	90.00	10.00	21.70	90.12	10.00	1.5104	.0043-	.3718-	.0072-	.0464-	.1695-
200	171	1023	90.00	10.00	32.55	90.17	10.00	1.4333	.0173-	.3899-	.0081-	.0443-	.1654-
200	171	1024	90.00	10.00	43.40	90.23	10.00	1.4227	.0231-	.4212-	.0084-	.0499-	.1654-
200	171	1025	90.00	10.00	65.10	90.33	10.00	1.3960	.0383-	.4134-	.0088-	.0143-	.1198-
200	171	1026	90.00	10.00	108.50	90.57	10.00	1.4136	.0448-	.4743-	.0082-	.0161	.0781-
200	172	1027	60.00	15.00	15.83	59.22	12.96	1.6684	.0584-	.0541	.0149-	.2957-	.5085-
200	172	1028	60.00	15.00	21.10	59.25	12.97	1.5368	.0604-	.0172	.0139-	.2562-	.4283-
200	172	1029	60.00	15.00	31.65	59.30	12.97	1.5192	.0731-	.0154-	.0129-	.1552-	.3015-
200	172	1030	60.00	15.00	42.20	59.37	12.98	1.4963	.0780-	.0581-	.0127-	.0671-	.1605-
200	172	1031	60.00	15.00	63.30	59.48	13.00	1.5119	.0871-	.1265-	.0121-	.0071	.0093-
200	172	1032	60.00	15.00	105.50	59.68	13.02	1.4178	.0864-	.1034-	.0103-	.0281-	.0775-
200	173	1033	70.00	15.00	16.13	69.44	14.08	1.5850	.0618-	.0029	.0132-	.2233-	.4085-
200	173	1034	70.00	15.00	21.50	69.46	14.09	1.4876	.0605-	.0137	.0122-	.1782-	.3672-
200	174	1039	80.00	15.00	16.22	79.75	14.77	1.5217	.0506-	.0522-	.0117-	.0770-	.2448-
200	174	1040	80.00	15.00	21.62	79.77	14.77	1.4527	.0489-	.0443-	.0121-	.0632-	.2581-
200	174	1041	80.00	15.00	32.43	79.84	14.77	1.4256	.0475-	.0589-	.0126-	.0487-	.2240-
200	174	1042	80.00	15.00	43.24	79.89	14.78	1.4100	.0572-	.0992-	.0125-	.0427-	.2384-
200	174	1043	80.00	15.00	64.86	79.98	14.78	1.3475	.0593-	.2334-	.0128-	.0219-	.1793-
200	174	1044	80.00	15.00	108.10	80.21	14.79	1.3616	.0651-	.2513-	.0124-	.0045	.1442-
200	175	1045	90.00	15.00	16.28	90.08	15.00	1.4518	.0067	.3514-	.0115-	.0631-	.2516-
200	175	1046	90.00	15.00	21.70	90.11	15.00	1.4249	.0006	.3672-	.0120-	.0819-	.2640-
200	175	1047	90.00	15.00	32.55	90.16	15.00	1.4164	.0129-	.3806-	.0125-	.0663-	.2499-
200	175	1048	90.00	15.00	43.40	90.22	15.00	1.3814	.0242-	.3888-	.0125-	.0597-	.2447-
200	175	1049	90.00	15.00	65.10	90.33	15.00	1.3569	.0360-	.4106-	.0127-	.0404-	.2078-
200	175	1050	90.00	15.00	108.50	90.54	15.00	1.3331	.0465-	.4181-	.0122-	.0110	.1509-
300	87	518	.00	.00	15.00	.00	.00	.0209	.0428	.0109	.0006-	.0000	.0042
300	87	519	.00	.00	20.00	.00	.00	.0104-	.0417	.0247	.0000	.0016	.0024
300	87	520	.00	.00	30.00	.00	.00	.0192	.0420	.0019	.0000	.0011	.0018
300	87	521	.00	.00	40.00	.00	.00	.0147	.0419	.0033	.0000	.0016	.0011
300	87	522	.00	.00	60.00	.00	.00	.0182	.0422	.0005-	.0001	.0009	.0006
300	87	523	.00	.00	100.00	.01	.00	.0158	.0433	.0010	.0002	.0004-	.0032
300	88	524	5.00	.00	15.00	5.01	.00	.2776	.0355	.0323	.0005-	.0042-	.0228
300	88	525	5.00	.00	20.00	5.01	.00	.3112	.0351	.0072	.0004-	.0002	.0063
300	88	526	5.00	.00	30.00	5.03	.00	.2923	.0355	.0114	.0002	.0000	.0050
300	88	527	5.00	.00	40.00	5.03	.00	.2835	.0340	.0131	.0003	.0010	.0039
300	88	528	5.00	.00	60.00	5.06	.00	.3046	.0346	.0029	.0005	.0002	.0033
300	88	529	5.00	.00	100.00	5.11	.00	.3055	.0341	.0033	.0005	.0006-	.0043
300	89	530	10.00	.00	15.00	10.02	.00	.5856	.0270	.0087	.0002-	.0006-	.0116
300	89	531	10.00	.00	20.00	10.03	.00	.5932	.0273	.0016	.0003-	.0013-	.0098
300	89	532	10.00	.00	30.00	10.06	.00	.5927	.0266	.0004	.0004	.0005	.0037
300	89	533	10.00	.00	40.00	10.08	.00	.6050	.0275	.0115-	.0001	.0002-	.0042
300	89	534	10.00	.00	60.00	10.12	.00	.5948	.0275	.0006	.0005	.0004	.0016
300	89	535	10.00	.00	100.00	10.22	.00	.6122	.0280	.0058-	.0005	.0012-	.0043
300	90	536	15.00	.00	15.00	15.04	.00	.8254	.0252	.0037-	.0004-	.0024	.0013
300	90	537	15.00	.00	20.00	15.06	.00	.8897	.0271	.0364-	.0002	.0013	.0002
300	90	538	15.00	.00	30.00	15.09	.00	.8498	.0266	.0245-	.0002	.0002	.0043
300	90	539	15.00	.00	40.00	15.11	.00	.8298	.0260	.0185-	.0000	.0007	.0028
300	90	540	15.00	.00	60.00	15.19	.00	.8521	.0253	.0209-	.0003-	.0000	.0028
300	90	541	15.00	.00	100.00	15.32	.00	.8611	.0249	.0192-	.0004-	.0013-	.0060
300	91	542	20.00	.00	15.00	20.06	.00	1.1349	.0180	.0279-	.0004-	.0022-	.0217
300	91	543	20.00	.00	20.00	20.08	.00	1.1227	.0191	.0611-	.0004-	.0004	.0081
300	91	544	20.00	.00	30.00	20.12	.00	1.0746	.0187	.0446-	.0009-	.0016	.0071
300	91	545	20.00	.00	40.00	20.16	.00	1.1012	.0178	.0514-	.0009-	.0012	.0059
300	91	546	20.00	.00	60.00	20.25	.00	1.1182	.0172	.0504-	.0006-	.0017	.0042
300	91	547	20.00	.00	100.00	20.42	.00	1.1421	.0168	.0507-	.0012-	.0001	.0046
300	92	548	25.00	.00	15.00	25.08	.00	1.4456	.0090	.0663-	.0001	.0032	.0110
300	92	549	25.00	.00	20.00	25.10	.00	1.3809	.0081	.0939-	.0003	.0022	.0150
300	92	550	25.00	.00	30.00	25.15	.00	1.3433	.0078	.0805-	.0030-	.0054	.0009-
300	92	551	25.00	.00	40.00	25.20	.00	1.3484	.0074	.0866-	.0028-	.0032	.0066
300	92	552	25.00	.00	60.00	25.30	.00	1.3693	.0067	.0994-	.0018-	.0027	.0111
300	92	553	25.00	.00	100.00	25.52	.00	1.3921	.0058	.0881-	.0000	.0002	.0123

† Minus signs are to the right of the numbers to which they apply.

TABLE III. - AERODYNAMIC COEFFICIENTS OF MODEL FOR THE COMPLETE INVESTIGATION - Continued<sup>†</sup>

Config.	Run	Point	$\alpha_1$ , deg	$\beta$ , deg	q, lb/sq ft	$\alpha$ , deg	$\beta$ , deg	C <sub>N</sub>	C <sub>A</sub>	C <sub>m</sub>	C <sub>l</sub>	C <sub>n</sub>	C <sub>Y</sub>
300	93	554	30.00	.00	15.16	30.10	.00	1.8039	.0115-	.0336-	.0027-	.0017	.0132
300	93	555	30.00	.00	20.21	30.13	.00	1.7100	.0060-	.1043-	.0004	.0017	.0229
300	93	556	30.00	.00	30.32	30.18	.00	1.5861	.0058-	.1147-	.0041-	.0046	.0120
300	93	557	30.00	.00	40.42	30.23	.00	1.5565	.0081-	.1324-	.0044-	.0002-	.0013-
300	93	558	30.00	.00	60.64	30.35	.00	1.5683	.0075-	.1412-	.0033-	.0053	.0034
300	93	559	30.00	.00	101.06	30.61	.00	1.6354	.0087-	.1382-	.0003	.0009	.0117
300	94	560	35.00	.00	15.16	35.11	.00	2.1098	.0300-	.0035-	.0107-	.0111	.0621-
300	94	561	35.00	.00	20.21	35.15	.00	2.0643	.0241-	.0532-	.0080-	.0061	.0469-
300	94	562	35.00	.00	30.32	35.20	.00	1.8930	.0231-	.1375-	.0026-	.0007	.0038-
300	94	563	35.00	.00	40.42	35.26	.00	1.7980	.0220-	.1686-	.0019	.0045-	.0247-
300	94	564	35.00	.00	60.64	35.40	.00	1.8298	.0242-	.1929-	.0029	.0065-	.0022-
300	94	565	35.00	.00	101.06	35.69	.00	1.8656	.0047-	.1872-	.0037	.0040-	.0013
300	95	566	40.00	.00	15.34	40.15	.00	2.5870	.0460-	.0430-	.0277-	.0348	.2765-
300	95	567	40.00	.00	20.45	40.18	.00	2.3366	.0462-	.0617-	.0135-	.0026-	.1819-
300	95	568	40.00	.00	30.68	40.24	.00	2.1137	.0406-	.1469-	.0054	.0102-	.0140-
300	95	569	40.00	.00	40.90	40.30	.00	2.0000	.0372-	.2153-	.0060	.0034-	.0160-
300	95	570	40.00	.00	61.35	40.42	.00	1.8560	.0396-	.1849-	.0031	.0074-	.0018
300	95	571	40.00	.00	102.25	40.74	.00	1.9581	.0443-	.2180-	.0075-	.0268	.0247
300	96	572	45.00	.00	15.34	45.14	.00	2.4525	.0316-	.0604-	.0186-	.0743-	.2200-
300	96	573	45.00	.00	20.45	45.18	.00	2.3901	.0527-	.0533-	.0347-	.0282-	.0282-
300	96	574	45.00	.00	30.68	45.25	.00	2.2034	.0475-	.1632-	.0116	.0318-	.0299-
300	96	575	45.00	.00	40.90	45.33	.00	2.1479	.0523-	.2439-	.0068	.0109-	.0059-
300	96	576	45.00	.00	61.35	45.49	.00	2.1419	.0537-	.3034-	.0001	.0139	.0207
300	96	577	45.00	.00	102.25	45.79	.00	2.0920	.0505-	.2736-	.0025-	.0508	.0452
300	97	578	50.00	.00	15.57	50.13	.00	2.2908	.0332-	.0590-	.0154-	.1524-	.2538-
300	97	579	50.00	.00	20.76	50.18	.00	2.3224	.0404-	.0669-	.0099-	.1053-	.2188-
300	97	580	50.00	.00	31.15	50.25	.00	2.1967	.0458-	.2014-	.0054	.0596-	.0449-
300	97	581	50.00	.00	41.53	50.33	.00	2.1615	.0546-	.2552-	.0041	.0455-	.0274-
300	97	582	50.00	.00	62.29	50.49	.00	2.1069	.0513-	.2764-	.0021	.0104	.0354
300	97	583	50.00	.00	103.82	50.81	.00	2.0981	.0522-	.2974-	.0031	.0468	.0818
300	98	584	55.00	.00	15.57	55.14	.00	2.4400	.0438-	.0041	.0069-	.1675-	.2271-
300	98	585	55.00	.00	20.76	55.17	.00	2.2608	.0492-	.0601-	.0011-	.1156-	.1857-
300	98	586	55.00	.00	31.15	55.26	.00	2.2931	.0528-	.2756-	.0012	.0417-	.0533-
300	98	587	55.00	.00	41.53	55.35	.00	2.2450	.0535-	.3414-	.0003	.0213-	.0034-
300	98	588	55.00	.00	62.29	55.51	.00	2.2026	.0561-	.3691-	.0010	.0276	.0426
300	98	589	55.00	.00	103.82	55.84	.00	2.1806	.0578-	.3591-	.0007	.0389	.0584
300	99	590	60.00	.00	15.83	60.14	.00	2.4533	.0592-	.0757-	.0070	.0676	.1074
300	99	591	60.00	.00	21.10	60.19	.00	2.3772	.0678-	.1337-	.0010	.0754	.1491
300	99	592	60.00	.00	31.65	60.27	.00	2.2700	.0650-	.2948-	.0004	.0391	.1973
300	99	593	60.00	.00	42.20	60.35	.00	2.2309	.0599-	.3568-	.0006	.0262	.1312
300	99	594	60.00	.00	63.30	60.52	.00	2.2230	.0630-	.4016-	.0012	.0479	.0783
300	100	596	65.00	.00	15.83	65.14	.00	2.3765	.0502-	.1628-	.0006-	.1078	.1534
300	100	597	65.00	.00	21.10	65.18	.00	2.3432	.0548-	.2184-	.0007-	.1537	.2190
300	100	598	65.00	.00	31.65	65.27	.00	2.3247	.0567-	.3760-	.0022-	.1514	.1809
300	100	599	65.00	.00	42.20	65.36	.00	2.2909	.0599-	.4376-	.0013-	.1676	.0820
300	100	600	65.00	.00	63.30	65.52	.00	2.2036	.0574-	.4084-	.0011-	.0831	.0992
300	100	601	65.00	.00	105.50	65.89	.00	2.2868	.0597-	.4475-	.0001	.0433	.0611
300	101	602	70.00	.00	16.13	70.14	.00	2.4060	.0534-	.2470-	.0001-	.0486	.0508
300	101	603	70.00	.00	21.50	70.19	.00	2.3598	.0496-	.3059-	.0006-	.0901	.1452
300	101	604	70.00	.00	32.25	70.27	.00	2.2347	.0431-	.3685-	.0010-	.1319	.1865
300	101	605	70.00	.00	43.00	70.36	.00	2.2450	.0434-	.4606-	.0014-	.0807	.0932
300	101	606	70.00	.00	64.50	70.52	.00	2.1909	.0437-	.4883-	.0025-	.0633	.0461
300	101	607	70.00	.00	107.50	70.87	.00	2.1928	.0436-	.5255-	.0020-	.0290	.0008
300	102	608	80.00	.00	16.22	80.15	.00	2.3731	.0224-	.4896-	.0004-	.0043-	.0022-
300	102	609	80.00	.00	21.62	80.20	.00	2.3681	.0257-	.4895-	.0004	.0168-	.0134-
300	102	610	80.00	.00	32.43	80.49	.00	2.3396	.0242-	.5728-	.0001-	.0080-	.0000
300	102	611	80.00	.00	43.24	80.38	.00	2.3005	.0230-	.6541-	.0016-	.0016	.0109
300	102	612	80.00	.00	64.86	80.54	.00	2.2148	.0219-	.6384-	.0010-	.0115	.0167
300	102	613	80.00	.00	108.10	80.90	.00	2.2347	.0300-	.7279-	.0017-	.0120	.0300
300	103	614	90.00	.00	16.28	90.14	.00	2.3063	.0103-	.7159-	.0005-	.0314	.0066
300	103	615	90.00	.00	21.70	90.19	.00	2.3207	.0110-	.7733-	.0002	.0013	.0051
300	103	616	90.00	.00	32.55	90.27	.00	2.2621	.0147-	.8024-	.0002-	.0050-	.0007
300	103	617	90.00	.00	43.40	90.37	.00	2.2972	.0208-	.8188-	.0010-	.0011-	.0126
300	103	618	90.00	.00	65.10	90.53	.00	2.1943	.0295-	.8399-	.0009-	.0020	.0142
300	103	619	90.00	.00	108.50	90.87	.00	2.1743	.0398-	.8762-	.0008-	.0177	.0391
400	296	1548	.00	.00	100.00	.00	.00	.0132	.0375	.0020-	.0004	.0012	.0013-
400	296	1549	5.00	.00	100.00	5.12	.00	.3591	.0288	.0752-	.0006	.0006	.0005
400	296	1550	10.00	.00	100.00	10.17	.00	.4729	.0203	.0428-	.0004	.0000	.0017-
400	301	1563	70.00	.00	16.13	70.18	.00	3.0270	.0161-	.9491-	.0021	.0715	.0855
400	301	1564	70.00	.00	32.25	70.34	.00	2.8212	.0399-	1.1253-	.0152	.0887-	.0857-
400	301	1565	70.00	.00	107.50	71.15	.00	2.8866	.0599-	1.2819-	.0008	.0121	.0250

<sup>†</sup>Minus signs are to the right of the numbers to which they apply.

L-905

TABLE III. - AERODYNAMIC COEFFICIENTS OF MODEL FOR THE COMPLETE INVESTIGATION - Continued<sup>†</sup>

Config.	Run	Point	$\alpha_1$ , deg	$\beta$ , deg	q, lb/sq ft	$\alpha$ , deg	$\beta$ , deg	$C_N$	$C_A$	$C_m$	$C_l$	$C_n$	$C_y$
400	302	1566	80.00	.00	16.22	80.19	.00	3.0578	.0085	1.1832-	.0017	.0051	.0220-
400	302	1567	80.00	.00	32.43	80.36	.00	2.9579	.0339-	1.3333-	.0029	.0520-	.1113-
400	302	1568	80.00	.00	108.10	81.16	.00	2.8997	.0493-	1.4425-	.0015	.0193	.0321
400	303	1575	70.00	5.00	16.13	70.11	4.70	3.0963	.0531-	.9812-	.0105-	.0911	.0674
400	303	1576	70.00	5.00	32.25	70.27	4.71	2.8587	.0472-	1.1525-	.0139-	.1291-	.2190-
400	303	1577	70.00	5.00	107.50	71.09	4.73	2.9356	.0645-	1.3062-	.0142-	.0290-	.0342
400	304	1578	80.00	5.00	16.22	80.15	4.92	3.0170	.0444-	1.1469-	.0124-	.0396-	.0502-
400	304	1579	80.00	5.00	32.43	80.32	4.93	2.9272	.0444-	1.2887-	.0120-	.0046-	.0275-
400	304	1580	80.00	5.00	108.10	81.15	4.94	2.9563	.0597-	1.4645-	.0151-	.0482	.0048
400	305	1581	70.00	10.00	16.13	69.90	9.40	3.1206	.0416-	.9833-	.0511-	.0686	.0500-
400	305	1582	70.00	10.00	32.25	70.05	9.41	2.7917	.0466-	1.1738-	.0298-	.1127-	.3207-
400	305	1583	70.00	10.00	107.50	70.86	9.45	2.8830	.0625-	1.2929-	.0268-	.0151-	.1512-
400	306	1584	80.00	10.00	16.22	80.04	9.85	2.9647	.0280-	1.1544-	.0266-	.0150-	.2825-
400	306	1585	80.00	10.00	32.43	80.20	9.85	2.8943	.0441-	1.2479-	.0261-	.0157	.1230-
400	306	1586	80.00	10.00	108.10	81.00	9.88	2.8650	.0457-	1.4392-	.0259-	.0555	.0744-
400	307	1587	70.00	5.00-	16.13	70.11	4.70-	2.9993	.0584-	.9348-	.0168	.0924	.1723
400	307	1588	70.00	5.00-	32.25	70.27	4.71-	2.8963	.0547-	1.1159-	.0138	.0477-	.0243
400	307	1589	70.00	5.00-	107.50	71.07	4.73-	2.8800	.0633-	1.2681-	.0151	.0183	.0800
400	308	1590	80.00	5.00-	16.22	80.15	4.92-	3.0571	.0333-	1.1966-	.0144	.0312-	.0754
400	308	1591	80.00	5.00-	32.43	80.32	4.93-	2.9057	.0354-	1.2440-	.0138	.1127-	.0955-
400	308	1592	80.00	5.00-	108.10	81.13	4.94-	2.9138	.0353-	1.4517-	.0147	.0009	.0943
400	309	1593	70.00	10.00-	16.13	69.90	9.40-	3.0312	.0360-	.9297-	.0294	.0187	.1309
400	309	1594	70.00	10.00-	32.25	70.05	9.41-	2.8145	.0444-	1.0941-	.0272	.0340-	.0762
400	309	1595	70.00	10.00-	107.50	70.86	9.45-	2.8735	.0528-	1.2581-	.0291	.0177	.1537
400	310	1596	80.00	10.00-	16.22	80.04	9.85-	2.9856	.0406-	1.2162-	.0002-	.0178	.2181
400	310	1597	80.00	10.00-	32.43	80.18	9.85-	2.7353	.0469-	1.1312-	.0265	.1493-	.0185-
400	310	1598	80.00	10.00-	108.10	80.99	9.88-	2.8495	.0444-	1.3946-	.0286	.0122-	.1468
400	311	1599	.00	.00	100.00	.00	.00	.0101	.0373	.0021	.0005	.0001	.0001
400	311	1600	2.00	.00	100.00	2.04	.00	.1395	.0348	.0219-	.0004	.0005	.0015
400	311	1601	4.00	.00	100.00	4.09	.00	.2766	.0311	.0498-	.0005	.0007	.0011
400	311	1602	6.00	.00	100.00	6.15	.00	.4288	.0265	.0878-	.0006	.0006	.0012
400	311	1603	8.00	.00	100.00	8.21	.00	.5841	.0228	.1339-	.0005	.0004	.0020
400	311	1604	10.00	.00	100.00	10.26	.00	.7294	.0194	.1858-	.0003	.0007	.0006
402	312	1605	.00	.00	100.00	.02-	.00	.0540-	.0106	.0904	.0003	.0002	.0023-
402	312	1606	2.00	.00	100.00	2.03	.00	.0727	.0179	.0659	.0004	.0012	.0026-
402	312	1607	4.00	.00	100.00	4.07	.00	.2173	.0131	.0334	.0005	.0015	.0027-
402	312	1608	6.00	.00	100.00	6.12	.00	.3642	.0183	.0030	.0006	.0013	.0016-
402	312	1609	8.00	.00	100.00	8.18	.00	.5035	.0135	.0312-	.0006	.0010	.0012-
402	312	1610	10.00	.00	100.00	10.23	.00	.6535	.0092	.0821-	.0004	.0011	.0028-
404	313	1611	.00	.00	100.00	.05-	.00	.1230-	.0090	.1885	.0006-	.0029-	.0060
404	313	1612	2.00	.00	100.00	2.00	.00	.0116	.0051	.1587	.0007-	.0019-	.0044
404	313	1613	4.00	.00	100.00	4.05	.00	.1485	.0088	.1259	.0005-	.0012-	.0045
404	313	1614	6.00	.00	100.00	6.11	.00	.3109	.0035	.0869	.0004-	.0006-	.0027
404	313	1615	8.00	.00	100.00	8.16	.00	.4523	.0088	.0506	.0000	.0005-	.0014
404	313	1616	10.00	.00	100.00	10.21	.00	.5997	.0038	.0020	.0001-	.0014-	.0044

<sup>†</sup> Minus signs are to the right of the numbers to which they apply.

TABLE III. - AERODYNAMIC COEFFICIENTS OF MODEL FOR THE COMPLETE INVESTIGATION - Concluded †

Config.	Run	Point	$\alpha_1$ , deg	$\beta_1$ , deg	$q$ , lb/sq ft	$\alpha$ , deg	$\beta$ , deg	$C_N$	$C_A$	$C_m$	$C_l$	$C_n$	$C_Y$
19A0	336	1689	50.00	.00	15.57	50.17	.00	2.9799	.0280-	.7885-	.0163	.0985-	.1158-
19A0	336	1690	60.00	.00	15.83	60.17	.00	2.9027	.0456-	.7889-	.0033	.0961	.1514
19A0	336	1691	70.00	.00	16.13	70.18	.00	3.0205	.0515-	1.0077-	.0036	.1043	.1613
19A0	336	1692	80.00	.00	16.22	80.19	.00	2.9885	.0360-	1.1934-	.0020	.0681	.1097
19A0	337	1693	50.00	5.00	15.57	50.05	3.84	2.8665	.0300-	.8049-	.0059	.1014-	.1810-
19A0	337	1694	60.00	5.00	15.83	60.07	4.33	2.8926	.0363-	.7436-	.0046-	.1049	.1398
19A0	337	1695	70.00	5.00	16.13	70.11	4.70	3.0224	.0442-	.9905-	.0058-	.1125	.0760
19A0	337	1696	80.00	5.00	16.22	80.15	4.92	2.9771	.0324-	1.1742-	.0069-	.0608	.0164-
19A0	338	1697	50.00	10.00	15.57	49.74	7.66	3.0102	.0200-	.8630-	.0085-	.1527-	.1791-
19A0	338	1698	60.00	10.00	15.83	59.78	8.66	2.8357	.0351-	.6862-	.0133-	.1431	.0119-
19A0	338	1699	70.00	10.00	16.13	69.89	9.40	2.9134	.0445-	.9345-	.0182-	.0770	.1139-
19A0	338	1700	80.00	10.00	16.22	80.04	9.85	2.9761	.0251-	1.2104-	.0165-	.0710	.1435-
19A0	339	1701	50.00	15.00	15.57	49.17	11.46	2.7266	.0004	.8613-	.0072-	.1295-	.2555-
19A0	339	1702	60.00	15.00	15.83	59.28	12.97	2.7050	.0160-	.8262-	.0183-	.0480	.4410-
19A0	339	1703	70.00	15.00	16.13	69.51	14.09	2.8463	.0399-	.8725-	.0211-	.0969	.3272-
19A0	339	1704	80.00	15.00	16.22	79.84	14.77	2.8761	.0109-	1.2178-	.0153-	.0788	.3097-
1980	340	1705	50.00	15.00	15.57	49.18	11.46	2.7896	.0154-	.7936-	.0083-	.1619-	.2855-
1980	340	1706	60.00	15.00	15.83	59.29	12.97	2.7514	.0242-	.8341-	.0210-	.1082-	.5189-
1980	340	1707	70.00	15.00	16.13	69.51	14.09	2.8422	.0340-	.8701-	.0225-	.0804	.3148-
1980	340	1708	80.00	15.00	16.22	79.82	14.77	2.8133	.0074-	1.1331-	.0183-	.0495	.3650-
1980	341	1709	50.00	10.00	15.57	49.74	7.66	2.9356	.0281-	.7577-	.0078-	.1733-	.3789-
1980	341	1710	60.00	10.00	15.83	59.78	8.66	2.8254	.0351-	.6679-	.0114-	.1226	.0009-
1980	341	1711	70.00	10.00	16.13	69.90	9.40	2.9762	.0440-	.9199-	.0153-	.0549	.1343-
1980	341	1712	80.00	10.00	16.22	80.04	9.85	3.0198	.0315-	1.1860-	.0141-	.0115	.2143-
1980	342	1713	50.00	5.00	15.57	50.05	3.84	2.8001	.0277-	.7686-	.0073	.1021-	.2800-
1980	342	1714	60.00	5.00	15.83	60.07	4.33	2.9307	.0458-	.7089-	.0033-	.1442	.1372
1980	342	1715	70.00	5.00	16.13	70.11	4.70	2.9758	.0443-	.9077-	.0066-	.0442	.0323-
1980	342	1716	80.00	5.00	16.22	80.16	4.92	3.1086	.0413-	1.1858-	.0073-	.0078	.0782-
1980	343	1717	50.00	.00	15.57	50.17	.00	2.8745	.0251-	.7430-	.0094	.1660-	.2271-
1980	343	1718	60.00	.00	15.83	60.17	.00	2.9104	.0420-	.7816-	.0022	.0942-	.0218
1980	343	1719	70.00	.00	16.13	70.19	.00	3.1481	.0472-	1.0368-	.0014	.0533	.0727
1980	343	1720	80.00	.00	16.22	80.19	.00	3.0643	.0389-	1.1864-	.0003-	.0067-	.0463
18A0	344	1721	50.00	.00	15.57	50.17	.00	2.8977	.0337-	.8608-	.0141	.0458-	.0340
18A0	344	1722	60.00	.00	15.83	60.17	.00	2.9344	.0484-	.8780-	.0038	.0822	.1700
18A0	344	1723	70.00	.00	16.13	70.18	.00	3.0834	.0438-	1.1387-	.0029	.0370	.1060
18A0	344	1724	80.00	.00	16.22	80.19	.00	2.9745	.0295-	1.2608-	.0010	.0022	.0824
18A0	345	1725	50.00	5.00	15.57	50.06	3.84	2.8763	.0319-	.8657-	.0091-	.0360	.1569
18A0	345	1726	60.00	5.00	15.83	60.07	4.33	2.9068	.0455-	.8708-	.0086	.0459	.2423
18A0	345	1727	70.00	5.00	16.13	70.11	4.70	2.9926	.0455-	1.0759-	.0113	.0382	.2149
18A0	345	1728	80.00	5.00	16.22	80.15	4.92	3.0755	.0239-	1.2059-	.0026	.0934-	.0792
18A0	346	1729	50.00	10.00	15.57	49.73	7.66	2.7860	.0289-	.8259-	.0040-	.0491	.2222
18A0	346	1730	60.00	10.00	15.83	59.79	8.66	2.8798	.0471-	.8866-	.0134	.0435	.3211
18A0	346	1731	70.00	10.00	16.13	69.89	9.40	2.9113	.0561-	1.0512-	.0201	.0245	.3197
18A0	346	1732	80.00	10.00	16.22	80.13	9.85	2.9489	.0322-	1.1741-	.0199	.0787-	.1778
18A0	347	1733	50.00	15.00	15.57	49.17	11.46	2.7568	.0236-	.8769-	.0032	.0928	.3663
18A0	347	1734	60.00	15.00	15.83	59.29	12.97	2.8318	.0360-	.9030-	.0186	.0458	.4675
18A0	347	1735	70.00	15.00	16.13	69.51	14.09	2.8258	.0407-	1.0689-	.0239	.0238-	.4546
18A0	347	1736	80.00	15.00	16.22	79.82	14.77	2.8284	.0046-	1.3798-	.0120	.1046-	.3025
1880	348	1737	50.00	15.00	15.57	49.17	11.46	2.7060	.0227-	.8634-	.0072	.1715	.5307
1880	348	1738	60.00	15.00	15.83	59.29	12.97	2.8172	.0443-	.9090-	.0204	.1456	.6164
1880	348	1739	70.00	15.00	16.13	69.51	14.09	2.7177	.0386-	.9849-	.0213	.0608	.5146
1880	348	1740	80.00	15.00	16.22	79.82	14.77	2.7187	.0096	1.3182-	.0125	.0654-	.3916
1880	349	1741	50.00	10.00	15.57	49.72	7.66	2.6926	.0275-	.7810-	.0011-	.1055	.3299
1880	349	1742	60.00	10.00	15.83	59.78	8.66	2.7596	.0479-	.8261-	.0156	.1321	.4603
1880	349	1743	70.00	10.00	16.13	69.89	9.40	2.9524	.0500-	1.0283-	.0206	.0819	.4107
1880	349	1744	80.00	10.00	16.22	80.14	9.85	2.9802	.0298-	1.1530-	.0130	.0347-	.2226
1880	350	1745	50.00	5.00	15.57	50.06	3.84	2.9091	.0334-	.8035-	.0039-	.0675	.2315
1880	350	1746	60.00	5.00	15.83	60.07	4.33	2.8860	.0513-	.8528-	.0116	.1718	.3944
1880	350	1747	70.00	5.00	16.13	70.11	4.70	2.9568	.0509-	1.0477-	.0115	.1067	.2681
1880	350	1748	80.00	5.00	16.22	80.15	4.92	2.9900	.0365-	1.1583-	.0094	.0329-	.1328
1880	351	1749	50.00	.00	15.57	50.17	.00	2.9491	.0331-	.7104-	.0013	.0301	.1175
1880	351	1750	60.00	.00	15.83	60.17	.00	2.8998	.0469-	.8394-	.0057	.1203	.3304
1880	351	1751	70.00	.00	16.13	70.18	.00	2.9295	.0495-	1.0068-	.0040	.1291	.1990
1880	351	1752	80.00	.00	16.22	80.19	.00	2.9934	.0315-	1.2209-	.0010	.0710	.1213

† Minus signs are to the right of the numbers to which they apply.

L-905

