

Cop

NASA TN D-1068

NASA TN D-1068



# TECHNICAL NOTE

## D-1068

SATELLITE ATTITUDE CONTROL UTILIZING THE EARTH'S  
MAGNETIC FIELD

By John S. White, Fred H. Shigemoto, and Kent Bourquin

Ames Research Center  
Moffett Field, Calif.

NATIONAL AERONAUTICS AND SPACE ADMINISTRATION  
WASHINGTON

August 1961



## NATIONAL AERONAUTICS AND SPACE ADMINISTRATION

## TECHNICAL NOTE D-1068

SATELLITE ATTITUDE CONTROL UTILIZING THE EARTH'S  
MAGNETIC FIELD

By John S. White, Fred H. Shigemoto, and Kent Bourquin

## SUMMARY

A study was conducted to determine the feasibility of a satellite attitude fine-control system using the interaction of the earth's magnetic field with current-carrying coils to produce torque. The approximate intensity of the earth's magnetic field was determined as a function of the satellite coordinates. Components of the magnetic field were found to vary essentially sinusoidally at approximately twice orbital frequency. Amplitude and distortion of the sinusoidal components were a function of satellite orbit.

Two systems for two-axis attitude control evolved from this study, one using three coils and the other using two coils. The torques developed by the two systems differ only when the component of magnetic field along the tracking line is zero. For this case the two-coil system develops no torque whereas the three-coil system develops some effective torque which allows partial control. The equations which describe the three-coil system are complex in comparison to those of the two-coil system and require the measurement of all three components of the magnetic field as compared with only one for the two-coil case.

Intermittent three-axis torquing can also be achieved. This torquing can be used for coarse attitude control, or for dumping the stored momentum of inertia reaction wheels. Such a system has the advantage of requiring no fuel aboard the satellite.

For any of these magnetic torquing schemes the power required to produce the magnetic moment and the weight of the coil seem reasonable.

## INTRODUCTION

For most satellites some form of attitude control is required, and in many cases the control must be fairly precise. The fine control of the attitude of a near-earth satellite utilizing the earth's magnetic field is the subject of this report. Other methods of control studied at Ames Research Center have used inertia wheels and gyros. Reference 1 discusses in detail the use of inertia wheels for fine control.

To utilize the earth's magnetic field for control purposes, some knowledge of its shape is necessary. Accordingly, there will be presented the results of a brief study of the variation of the components of the earth's magnetic field at the satellite, in vehicle coordinates. It will then be shown how this field can be used to point the vehicle in a specified direction. Brief mention will be made of how the field can be used to dump momentum from the vehicle. It will be shown that the power and weight required for this system are reasonable, and that the transient response depends, in part, on the relative orientation of the field.

The requirements placed on satellite attitude control systems vary from one satellite to another; however, it can be stated generally that a tracking line in the satellite must be maintained in alignment with some external reference line of sight to a specified accuracy. Tracking of the external reference line is to be maintained in the presence of disturbing torques and satellite orbital motion.

A  
4  
7  
4

As a representative example for this report an attitude control system utilizing the earth's magnetic field will be analyzed to determine whether it can meet the design requirements for the fine control of the attitude of the Orbiting Astronomical Observatory (OAO) which is an earth satellite currently under study by NASA. This satellite will carry a rigidly mounted telescope whose optical axis defines the tracking line. The telescope is to be used to observe stars for various experiments; the external reference line is therefore defined as a line from the satellite to the star. Precise attitude control of this satellite is required about two axes, while roll about the tracking line should be limited to  $\pm 45^\circ$ . The most stringent requirement of the OAO is a pointing accuracy of 1/10 second of arc.

#### NOMENCLATURE

All units are in the rationalized MKS system.

A	angular error: the angle between the tracking line and the external reference line, radians
a	area enclosed by coil, meters <sup>2</sup>
B	magnetic induction, Webers/meter <sup>2</sup>
b	coil cross-sectional area, meters <sup>2</sup>
D	coil diameter, meters
G(s)	open-loop transfer function, volts/radian
H	angular momentum, kilogram-meter <sup>2</sup> /sec

$I$	coil current, amperes
$\bar{i}, \bar{j}, \bar{k}$	unit vectors along the x,y, and z axes, respectively
$J$	moment of inertia about vehicle axis, kilogram-meter <sup>2</sup>
$K_S$	sensor gain, volts/radian
$K_1$	amplifier gain, volts/volt
$K_2$	rate gain, volts/volt/sec
LS	line of sight to target
$l$	coil circumference, meters
$M$	magnetic moment of coil; ampere-meter <sup>2</sup>
$m$	mass, kilograms
$N$	number of coil turns
$P$	power, watts
$P_H$	earth equivalent magnetic dipole moment, ampere-meter <sup>2</sup>
$R$	resistance, ohms
$r$	distance from dipole center to field point, meters
$s$	Laplace transform variable
$T$	torque, Newton-meters
TL	tracking line of vehicle
$T_d$	disturbance torque, Newton-meters
$x, y, z$	orthogonal vehicle axes, x along tracking line
$\zeta$	dimensionless damping ratio
$\mu_0$	permeability of free space; henrys/meter
$\rho$	resistivity; ohm-meters
$\sigma$	density; kilogram/meter <sup>3</sup>
$\psi$	angle that $r$ makes with the dipole axis, radians

4

$\omega$  wheel angular velocity; radians/sec  
 $\omega_n$  undamped natural frequency; radians/sec

Subscripts

Lim sensor output limited  
r radial component  
T tangential component  
x,y,z axes of the vehicle  
( ) vector

A  
4  
7  
4

THE EARTH'S MAGNETIC FIELD

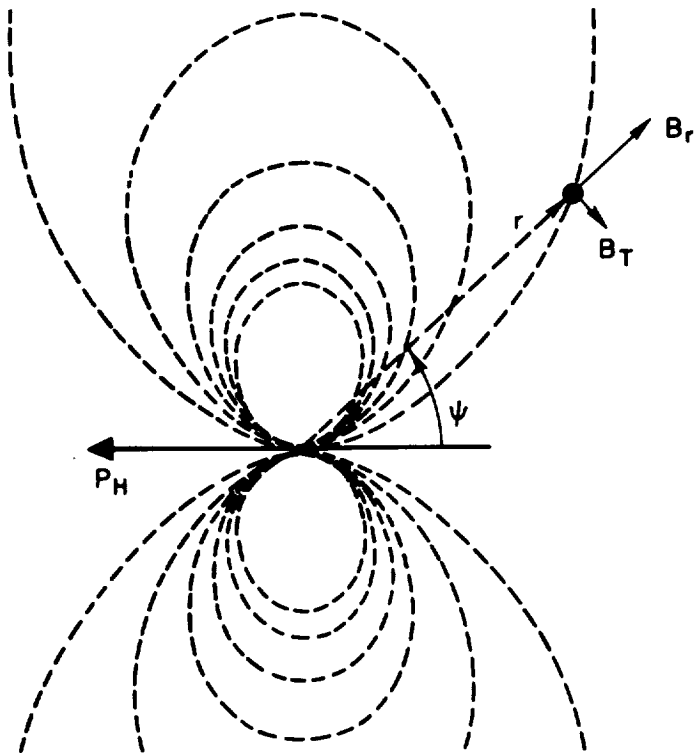

The analysis of a control system making use of the earth's magnetic field requires knowledge of the field in vehicle coordinates as a function of the satellite's position in orbit. Accordingly, the equations of the earth's magnetic field at the satellite were derived as functions of satellite position. It was assumed in this analysis that the earth's magnetic field can be expressed in terms of a magnetic dipole set along the geomagnetic axis, positive toward the geographic south pole. The declination of the axis was assumed to be  $17^\circ$ . The satellite position at any instant is expressed in terms of the polar coordinates  $r$  and  $\psi$ , as shown in the adjacent sketch.

Sketch (a)

Then the equations

$$\left. \begin{aligned} B_r &= -\frac{2\mu_0 P_H}{4\pi r^3} \cos \psi \\ B_T &= \frac{\mu_0 P_H}{4\pi r^3} \sin \psi \end{aligned} \right\} \quad (1)$$

define the components of the magnetic field at the satellite (ref. 2, p. 425). These assumptions give a magnetic field which is a reasonable approximation of the actual field at satellite altitudes (ref. 3).

Equations (1), plus those representing the motion of the earth and the satellite, must be analyzed to determine the variation of the field at the satellite in vehicle coordinates. Appendix A gives in detail all these equations, and a method for combining them to give the desired results. However, it is difficult to visualize the variation of the magnetic field components from the equations. In order to allow better visualization, the equations were programmed on an analog computer, for a satellite with an inertially fixed attitude, such as the OAO.

A portion of a typical record of the magnetic field in vehicle coordinates as a function of time for one orbit is shown in figure 1 for a near-earth circular orbit at an inclination of  $35^\circ$  to the equatorial plane. The vehicle coordinates are inertially fixed in space with the z axis parallel to the earth's polar axis. The magnitude of the magnetic field has been normalized with respect to  $B_{ref}$  which corresponds to the magnitude of the field intensity directly above the magnetic pole and is about  $0.25(10)^{-4}$  webers/meter<sup>2</sup> at orbital altitude. Records of the type shown in figure 1 were taken for various orbital inclinations with the satellite rotating about the earth in the same direction the earth rotates about its own axis. The results in figure 2 show the variation over a 24-hour period. As is shown in figure 1 the vector sum of the components varied slightly in magnitude while changing in direction. Equations (1) show that this variation cannot be more than 2:1 for a circular orbit. Each field component consists essentially of two sinusoids, one of which varies at approximately twice orbital frequency and the other at approximately the frequency of earth rotation. These results can be visualized as follows:

A  
4  
7  
4

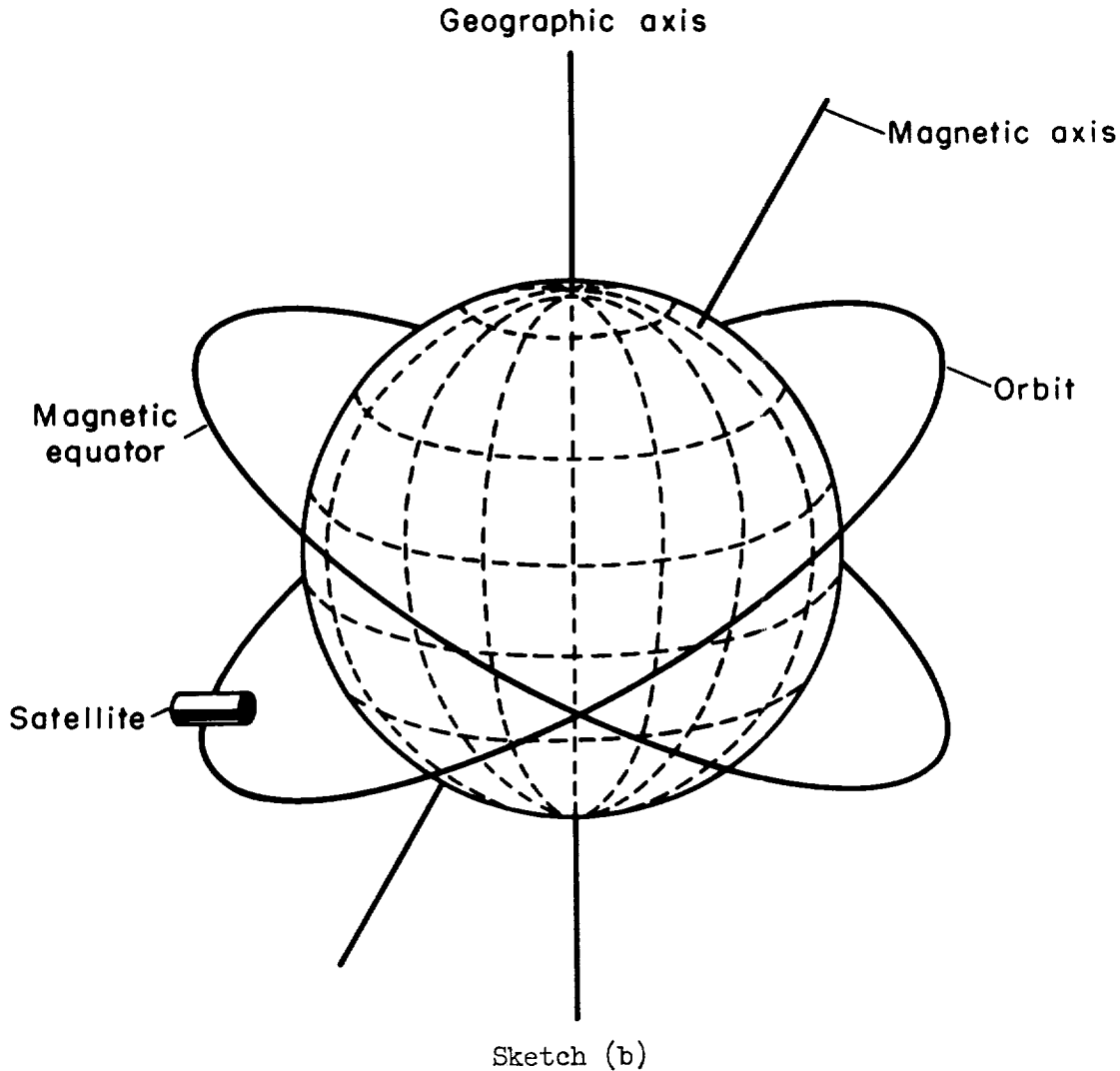

Sketch (a) shows the lines of force of the magnetic field, which are symmetrical about the magnetic pole. Equations (1), along with the sketch, show that the magnitude of the field, at a given altitude, is a minimum on the magnetic equator. Sketch (b) shows that a satellite will, in general, cross this equator twice per orbit. As a result, there will be two minimums, and hence two cycles, per orbit. Because of the earth's rotation the period will only approximate twice orbital period. If the satellite orbits directly along the magnetic equator, the field at the satellite, in an inertially fixed vehicle coordinate system, will be constant. However, such an orbit can be achieved only momentarily since the magnetic axis moves in inertial space because of the earth's rotation. Therefore, for any orbit, the components of the magnetic field in an inertially fixed coordinate system can never remain constant.



As a polar orbit is approached, peculiar variations in the field are seen by the satellite. The magnetic field vector has its greatest magnitude at the magnetic poles. The resulting plot of the field components versus orbital time is a distorted sinusoidal wave as shown in figures 2(c) and (d).

It is apparent from this study that the prediction of the instantaneous field is quite difficult, being a complicated function of time and the orbital elements. In addition, extraterrestrial effects, such as sun spots, will alter the magnetic field. Since knowledge of the magnetic-field vector is essential to the type of control system to be discussed, and since prediction of the field is unsatisfactory, the magnetic field must be measured aboard the satellite.

#### TWO-AXIS CONTINUOUS CONTROL

In the preceding section the earth's magnetic field as a function of satellite position was discussed. In this section it will be shown how this field can be used to generate a torque useful in controlling the attitude of the vehicle. Such a torque can be generated by developing a magnetic moment,  $\bar{M}$ , aboard the vehicle, which will interact with the earth's field. Accordingly, a known field will be postulated and a determination will be made of the magnetic moment which will give the desired values of torque. In the computation of the torque, the assumptions will be made that there is a uniform, nonvarying field,  $\bar{B}$ , and a constant moment,  $\bar{M}$ , which have a constant relative orientation. For the nearly inertially fixed vehicle, the effects neglected, as a result of these assumptions, are small.

Given a magnetic moment,  $\bar{M}$ , and a magnetic field,  $\bar{B}$ , a torque will be created, equal to the vector or cross product,  $\bar{M} \times \bar{B}$  (ref. 2). In order to control the magnitude and direction of the torque one of these two quantities must be varied, and since  $\bar{M}$  is developed aboard the satellite, it will be the quantity to be varied. For the purpose of discussion, we will assume that  $\bar{M}$  is obtained in terms of its components, by passing currents through coils in the vehicle. Assume three coils, as shown in figure 3, which develop the three moments  $M_x$ ,  $M_y$ ,  $M_z$  along the vehicle axes, with

$$\bar{M} = \bar{i}M_x + \bar{j}M_y + \bar{k}M_z$$

The torque developed is then

$$\bar{T} = \bar{M} \times \bar{B}$$

where

$$\bar{T} = \bar{i}T_x + \bar{j}T_y + \bar{k}T_z$$

and

$$\bar{B} = \bar{i}B_x + \bar{j}B_y + \bar{k}B_z$$

The vector product can be expanded as

$$\left. \begin{aligned} T_x &= M_y B_z - M_z B_y \\ T_y &= M_z B_x - M_x B_z \\ T_z &= M_x B_y - M_y B_x \end{aligned} \right\} \quad (2)$$

The natural inclination is to equate the above torque components to the desired torque components, proportional to the angular errors about the three axes.

The three resulting equations, however, cannot be simultaneously satisfied for arbitrary values of desired torque because of the nature of the vector cross product. The resulting torque, by its definition, must lie in a plane perpendicular to  $\bar{B}$ . This factor is one restriction on the vector, and only two additional restrictions may be specified. Thus, it is impossible to provide simultaneous proportional control about all three axes by means of coils interacting with the magnetic field.

For the particular case of interest here, namely, a vehicle with an inertially fixed attitude, whose x axis is to be pointed in a specified direction,  $T_y$  and  $T_z$  should be directly commanded as a function of the y and z errors; that is, the desired torques are

$$\left. \begin{aligned} T_y &= G(s)A_y \\ T_z &= G(s)A_z \end{aligned} \right\} \quad (3)$$

where  $G(s)$  is that transfer function which will produce a satisfactory system response. Since the torque vector is then completely specified, equations (2) and (3) can be solved for the remaining torque component,  $T_x$ , in terms of the field and the errors, giving

$$T_x = -G(s) \left( \frac{A_z B_z + A_y B_y}{B_x} \right) \quad (4)$$

This equation immediately points out a difficulty. If  $T_y$  and  $T_z$  are always obtained as specified by equations (3) then at times when  $B_x = 0$ ,  $T_x = \infty$ , which in turn means that  $\bar{T} = \infty$  and so  $\bar{M} = \infty$ , which is not physically realizable. Thus, when  $B_x = 0$ , or becomes sufficiently small, equations (3) can no longer be satisfied. For the moment, this condition will be neglected.

It is desired to solve equations (2) and (3) for the three components of  $\bar{M}$ . However, since there are really only two equations, one additional restriction on  $\bar{M}$  can be made. One attractive restriction would be that  $\bar{M}$  should be a minimum, that is,  $\bar{M}$  should be perpendicular to  $\bar{B}$  or

$$\bar{M} \cdot \bar{B} = 0 \quad (5)$$

Another possible restriction, which only requires two coils aboard the vehicle, is

$$M_x = 0 \quad (6)$$

The system developed from the first of these restrictions will be called the three-coil system, while that from the second will be called the two-coil system. For the first case, the equations to be solved are as follows:

$$\left. \begin{aligned} T_y &= M_z B_x - M_x B_z = G(s) A_y \\ T_z &= M_x B_y - M_y B_x = G(s) A_z \\ M_x B_x + M_y B_y + M_z B_z &= 0 \end{aligned} \right\} \quad (7)$$

If these equations are solved, the coil magnetic moments are found to be

$$\left. \begin{aligned} M_x &= -G(s) \left[ \frac{A_y B_z}{B^2} - \frac{A_z B_y}{B^2} \right] \\ M_y &= -G(s) \left[ \frac{A_y B_y B_z}{B_x B^2} + \frac{A_z (B_x^2 + B_z^2)}{B_x B^2} \right] \\ M_z &= G(s) \left[ \frac{A_z B_y B_z}{B_x B^2} + \frac{A_y (B_x^2 + B_y^2)}{B_x B^2} \right] \\ \text{for } B_x &\neq 0 \end{aligned} \right\} \quad (8)$$

If these are the control equations used, we should consider what happens when  $B_x \rightarrow 0$ . When this condition occurs,  $M_y$  and  $M_z$  will become large and, as a practical matter, will reach a limiting value;  $T_x$  will also be large. When  $B_x = 0$ , equation (2) shows that both  $T_y$  and  $T_z$  will be controlled by  $M_x$ , reacting with  $B_y$  and  $B_z$ , and these torques will change  $A_y$  and  $A_z$  in equation (8) and reduce  $M_x$  toward zero. Thus the control system, when  $B_x = 0$ , reduces the quantity  $A_y B_z - A_z B_y$  to zero. For example, if, in addition,  $B_y = 0$ , then  $A_y$  will be controlled to zero, and  $A_z$  will be uncontrolled.

The second restriction,  $M_x = 0$  (two-coil system), gives the following equations to be solved:

$$\left. \begin{aligned} T_y &= M_z B_x = G(s)A_y \\ T_z &= -M_y B_x = G(s)A_z \end{aligned} \right\} \quad (9)$$

Solving these equations for  $M$  gives:

$$\left. \begin{aligned} M_z &= \frac{G(s)A_y}{B_x} \\ M_y &= -\frac{G(s)A_z}{B_x} \\ \text{for } B_x &\neq 0 \end{aligned} \right\} \quad (10)$$

These equations are simpler than the corresponding equations (8) for the three-coil system and require only knowledge of  $B_x$ . In addition, the controls for the two axes are uncoupled since each torque is a function of only one error.

However, if these equations are used at times when  $B_x = 0$ , both  $M_z$  and  $M_y$  will be saturated and there will be no control of the vehicle about any axis. The two- and three-coil systems have similar limitations under the action of an externally applied torque. If such torque is perpendicular to  $\bar{B}$ , then the control system will exert a countertorque to hold the vehicle fixed, and the position error developed will be determined by  $G(s)$ . If, however, the external torque is applied parallel to  $\bar{B}$ , the system will be unable to keep the vehicle from rotating about an axis parallel to  $\bar{B}$ . Since  $\bar{B}$  is constantly changing in direction, the effect of the torque can be eliminated over a period of time. Further study is necessary to determine the short-term effects of this torque on the vehicle pointing errors.

Thus both of these systems have difficulties when  $B_x$  approaches zero and when an external torque is applied parallel to  $\bar{B}$ . Further study is necessary to determine which of these systems, the three-coil system (using lower power, maintaining partial control when  $B_x = 0$ , and with more complex computations), or the two-coil system (using more power, complete loss of control when  $B_x = 0$ , but with simpler computation), is to be preferred for a particular application. The actual orbit of the vehicle must be considered in such a study, since this will control the times at which  $B_x = 0$ .

## THREE-AXIS INTERMITTENT CONTROL

The previous section has shown that continuous control of the vehicle can be maintained magnetically about two axes, except for short periods when the field vector is perpendicular to the desired pointing axis. It is also possible to control all three axes intermittently but less accurately. However, for coarse control, or for the unloading of momentum stored in inertia wheels, the accuracy might well be good enough.

Suppose it is desired to change the total momentum of the vehicle by an amount  $\bar{H}$ , where  $\bar{H}$  might be stored momentum to be dumped, or a desired momentum, as a function of error, such as to reduce the error to zero. If the equation for the magnetic moment of the coil is selected as

$$\bar{M} = - \frac{K(\bar{B} \times \bar{H})}{B^2} \quad (11)$$

the torque developed will be

$$\bar{T} = \bar{M} \times \bar{B} = - \frac{K(\bar{B} \times \bar{H}) \times \bar{B}}{B^2} = -K\bar{H}_\perp \quad (12)$$

where  $\bar{H}_\perp$  represents the component of  $\bar{H}$  perpendicular to  $\bar{B}$ . The resultant torque vector is parallel to  $\bar{H}_\perp$  and thus cannot change that component of momentum parallel to the magnetic field, but will be such as to obtain the desired  $\bar{H}_\perp$ . Since the magnetic field is continually changing its direction, the total momentum will be controlled. Thus current coils can provide a smooth control when periods of absence of torque about one axis over part of an orbit are of no consequence. (Gas jets can also be used for this purpose and do the job as well. However, the gas system necessitates carrying some form of compressed gas aboard and is thus limited in useful life, whereas the magnetic system can utilize solar energy and so can operate indefinitely.) This system will not be discussed further, although it appears to be a simple and straightforward method for controlling, or dumping, vehicular angular momentum about all three axes.

## COIL CHARACTERISTICS

If a magnetic moment is to be used for torquing the vehicle, the coil weight and power required must be considered. The magnetic moment of a coil with no ferro-magnetic material of enclosed area  $a$ , current  $I$ , and turns  $N$  is

$$\bar{M} = N\bar{I}a \quad (13)$$

where the maximum magnitude of  $M$  required is determined by the particular satellite and its anticipated orbit. The maximum magnitude of  $M$  is to be used in calculating the coil characteristics. Assume that the coil has the following properties: a combined wire cross-section area,  $b$ , in meters<sup>2</sup>, wire length per turn,  $l$ , in meters, wire resistivity,  $\rho$ , in ohm-meters, and wire density,  $\sigma$ , in kg/m<sup>3</sup>. Also let  $b$  be divided among  $N$  conductors each of cross-sectional area  $b/N$ . Then,

$$R = \frac{N^2 l \rho}{b} \quad (14)$$

and, considering only the coil losses,

$$P = I^2 R = \frac{(NI)^2 l \rho}{b} = \frac{M^2 l \rho}{a^2 b} \quad (15)$$

If  $a$  and  $l$  are expressed as functions of the coil diameter  $D$ , equation (15) becomes

$$P = \frac{16M^2}{\pi D^3 b} \quad (16)$$

In a similar manner mass can be expressed as,

$$m = b \sigma l = \pi D b \sigma \quad (17)$$

It is considered desirable to keep both  $P$  and  $m$  as small as possible. Since their magnitudes are different functions of the same parameters, this can be accomplished if their product

$$Pm = \frac{16M^2 \rho \sigma}{D^2} \quad (18)$$

is kept small.

It can be seen that this product varies inversely as  $D^2$ , and directly as  $M^2$ , so that a large coil diameter and small maximum torque will tend to reduce the product. The coil area,  $b$ , may be used to control the trade between power and mass. The choice of  $b$  will thus depend on the relative penalties associated with power and mass, although this choice may be restricted by considerations of coil heating. The available power supply voltage,  $E$ , will then be used to determine the number of turns,

$$N = \frac{bED}{4M\rho} \quad (19)$$

and may further restrict the choice of  $b$ .

Consider, as a numerical example, the case of the OAO, where there will be disturbance torques due to gravity gradient, solar pressure, etc. An early estimate of this disturbance torque was 100 dyne cm (ref. 4). Later estimates have shown that the torques due to magnetic effects may be several times this value. In order for the system to recover from an initial error in a reasonable time, a torque of 5000 dyne cm is required. This value seems more than adequate to take care of the steady-state torques. If a magnetic field of 0.1 gauss is assumed, with a 2.44 meter diameter coil, only 10.7 ampere-turns are required to obtain the desired torque. With, for example,  $I = 100$  ma,  $N = 107$  turns of copper wire of gage No. 29 the power dissipated is 2.21 watts and the coil mass is 0.473 kg. The power calculated for the particular case is quite small, and the weight is reasonable.

A  
4  
7  
4

#### CONTROL SYSTEM RESPONSE

The basic control system considered in both the analytical and experimental phases of the analysis is shown for a single axis in figure 4 along with the over-all transfer function. The stability of the system is determined by the transfer functions as shown in the figure. The sensor provides a voltage proportional to the angular deviation from the desired line of sight to the star under observation. The signal voltage is amplified and added with its derivative to obtain the command torque. The magnetic moment is then varied by changing the coil currents (see the previously developed equation (8) or (10)) so that the interaction of the earth's magnetic field with the magnetic moment of the coil develops a torque which will reduce the error. Equations (7) and (9) both specify that the transfer function  $T/G(s)A$  is unity, even though the moments  $M$  are functions of  $B$ .

The undamped natural frequency and dimensionless damping ratio, as determined from figure 4, are:

$$\omega_n = \sqrt{\frac{K_S K_1}{J}} \quad \zeta = \frac{K_2}{2} \sqrt{\frac{K_S}{J K_1}}$$

It can be seen that  $K_2$  should be chosen to provide the desired degree of damping.

A study of the magnetic control system that used three coils was made on an analog computer. For this study the constants of the system were selected to provide adequate damping and a reasonable settling time. Settling time is defined as the time from detection of the initial angle error to the time the error is reduced to within specified tracking accuracy. The prime concern of this analysis was to determine what effects changes in the earth's magnetic field would have on the system

response, and no attempt was made to find the optimum control system. The maximum current available for producing magnetic moment was assumed to be limited by an amplifier, so that the maximum torque available for a given magnetic field would be limited. To simulate this limitation, and also sensor saturation, limiters were incorporated in the computer program. Values of the field were determined from the data obtained from the field analysis previously described. (See fig. 2, for example.) During the initial phases of the study, the earth's field was assumed constant during any one run and was changed only in direction between runs. This was acceptable since the field variation was small during any one run. System response to initial error and other conditions that the satellite may encounter, such as roll about the line of sight and disturbing steady-state torques acting on the satellite, were determined. Typical computer results are shown in figure 5, as plots of sensor output, in seconds of arc, against time. In figures 5(a), 5(b), and 6 the sensor output was limited to  $\pm 1.2$  seconds of arc, while in figures 5(c) and (d) it was limited to  $\pm 3$  seconds of arc. On these last two figures the ordinate scale is such that the initial portion of the transient is not shown. This change in limit value had very little effect on the general characteristics of the transient response. In each case the initial error was 6 seconds of arc.

A  
4  
7  
4

Figure 5(a) shows the system response when  $B_x$  is fairly small. The response for larger values of  $B_x$  is the same. At this value of  $B_x/B = 0.05$ , however, the response of the system will be affected if either  $B_y$  or  $B_z = 0$ , as shown in figure 5(b). Here  $B_y = 0$  and the response of the  $z$  channel is somewhat worse, with more overshoot and a longer settling time.

Figure 5(c) shows the effect of very much smaller  $B_x$ . Here the response is worse, with a settling time of around 100 seconds. The response is still stable; however, figure 5(d) shows the case where  $B_x = 0$ , and the response is divergent.

Computer tests were also conducted in which the rate of change of the field component was constant, which is a much better approximation to the actual conditions in orbit. This changing field did not affect the response of the system except when the satellite passed through a point at which  $B_x$  was zero as shown in figure 5. Instability will occur only when an angular error exists simultaneously with  $B_x = 0$ . Due to the displacement of the earth's geomagnetic axis with respect to the polar axis, combined with the earth's rotation about the polar axis, the magnetic field components at the satellite in any practical orbit would always be changing. In particular, times at which  $B_x$  is small enough to cause difficulties are few and of short duration; consequently, control can be maintained for a greater part of the orbit.

Steady-state torques about the  $y$  or  $z$  axis will result in steady-state errors about the respective axis. These errors will be proportional to the torque necessary to cancel the existing disturbing torque. Also



such errors will couple torque about the line of sight. The magnitude of the roll torque depends upon the magnitude and direction of the angular errors, as can be seen from equation (7). If angular rotation about the vehicle x axis is not to be tightly controlled, this torque may be tolerated.

Errors can be made very small by increasing system gains or can be eliminated by inserting an integrating network. However, if an integrating network is used, a supplementary compensating network must be incorporated to maintain stability.

A  
4  
7  
+  
An experimental model of a two-axis magnetic control system using two coils was built and tested on a platform supported by an air bearing. The results of the tests showed no significant deviation from the theoretical analysis.

#### SUMMARY OF RESULTS

A study was made of the variation of the components of the earth's magnetic field at a satellite, in vehicle coordinates, for a vehicle with an inertially fixed orientation. These components vary in an approximately sinusoidal fashion with time, but the exact variation is difficult to compute. Thus, on-board magnetometers must be used to determine the relative orientation of the magnetic field.

Simultaneous proportional control about three axes cannot be achieved by the use of torque developed by the interaction of the earth's magnetic field with a vehicle-developed magnetic moment. Control is possible, however, about two axes with the third axis uncontrolled, except when the tracking line is perpendicular to the field, a condition which can only occur for short periods of time.

The magnetic moment aboard the vehicle can be developed by means of current-carrying coils. If only two coils are used, the system is quite simple, but when the tracking line is perpendicular to the field, all control of the vehicle is lost. If three coils are used, the system is more complex, but less power is used and some control of the vehicle is retained when the field becomes perpendicular to the tracking line. In either case there will be an undesired torque about the tracking line, which may be acceptable. The power and weight requirements for the coils appear reasonable.

It is possible to obtain torque about all three axes of the vehicle on an intermittent basis. This torque will change the vehicle angular momentum. The change in momentum can be used directly to produce a desired change of the vehicle orientation, or it may be used as a dump of stored momentum (desaturation of a wheel control system). The equations for obtaining this type of control are relatively simple.

The use of the magnetic field for desaturation or fine control has the advantage that no fuel is required and the lifetime will be unlimited, discounting failures. In addition, for the fine control system, no auxiliary system for momentum dumping is required.

Ames Research Center  
National Aeronautics and Space Administration  
Moffett Field, Calif., May 18, 1961

A  
4  
7  
4

## APPENDIX A

DERIVATION OF THE EARTH'S MAGNETIC FIELD AS A FUNCTION OF  
SATELLITE COORDINATES

In an analytical study of the effects of the earth's magnetic field, it is first necessary to determine the components of the magnetic field in satellite coordinates, and how they vary as the satellite moves in its orbit. This is a two-step process, the first of which is to determine the location of the satellite with respect to the field; the second step is to determine the magnitude of the components of the field at the satellite in the satellite coordinate system.

This process involves several orthogonal coordinate systems and the transformations between them. The principal systems, all of which are right handed, are: (1) an inertial coordinate system, which can be either vehicle or earth centered; (2) a vehicle coordinate system, which is vehicle centered; (3) a magnetic coordinate system, which is earth centered; and (4) a geographic coordinate system which is earth centered.

The systems are defined as follows: The inertial coordinate system (fig. 7) has its axis  $Z_I$  pointed at the north celestial pole and  $X_I - Y_I$  define the equatorial plane.

The magnetic coordinate system has its  $X_M$  axis along the earth's magnetic dipole, positive toward the geographic north pole, and is oriented so that the satellite is always located in the  $X_M Z_M$  plane, with a negative  $Z_M$  component (fig. 8).

The vehicle coordinate system is fixed to the vehicle, and describes its attitude. The system has its  $X_S$  axis along the vehicle tracking line, to track the target star, with  $Y_S$  and  $Z_S$  perpendicular (fig. 7).

The geographic coordinate system has its  $X_G$  axis along the vector from the earth center to the satellite (fig. 9). The orientation of its y and z axes is immaterial in the following discussion and is not defined.

We must now define the angular relationship between these coordinate systems, and this will be done using several auxiliary systems. The rotations involved are shown in figures 7 through 9 as positive rotations about the appropriate axis, although in some cases a negative angle is drawn. First, let us define the angles between the inertial and vehicle systems as follows (fig. 7):

Intermediate coordinate system 1 is obtained from the inertial system by a rotation about  $Z_I = Z_1$  through the angle  $RA_S$ .

A  
4  
7  
4

System 2 is then obtained by a further rotation about  $Y_1 = Y_2$  through the angle  $-D_S$  so that  $X_2$  is aligned with  $X_S$ . Thus  $RA_S$  and  $D_S$  are the right ascension and declination of the point on the celestial sphere at which the satellite is looking. One additional rotation about  $X_2 = X_S$  through the angle  $\phi_S$  is necessary to completely define the vehicle coordinate system with respect to inertial space.

Next, to define the magnetic system with respect to the inertial system, consider first the intermediate system 3 (fig. 8). This is obtained by rotating about  $Z_I = Z_3$  through the angle  $RA_M$ . The angle  $RA_M$  is the right ascension of the earth's north magnetic pole and can be written as  $RA_M = RA_{M0} + \omega_e t$ , where  $\omega_e$  is the angular velocity of earth rotation. System 4 is obtained from system 3 by a rotation about  $Y_3 = Y_4$  through the angle  $-L_M$  (equal to latitude of the earth's north magnetic pole) so that  $X_4$  is along  $X_M$ . A final rotation about  $X_4 = X_M$  to bring the satellite into the  $X_M Z_M$  plane with a negative  $Z_M$  is required. This angle is  $\phi_M$  and completes the specification of the orientation of the magnetic coordinate system with respect to the inertial coordinate system.

A  
4  
7  
4

Finally, to define the geographic system with respect to the magnetic system, consider system 5 (fig. 8). It is obtained by a rotation about  $Y_M = Y_5$  through the angle  $\psi$  until  $X_5$  is aligned with  $X_G$ . The angle about  $X_5 = X_G$  between system 5 and the geographic coordinate system is not required. Thus, the angles  $RA_M$ ,  $L_M$ ,  $\phi_M$ , and  $\psi$  define the location of the X axis of the geographic coordinate system, and hence locate the satellite with respect to inertial space. At this point  $\phi_M$  and  $\psi$  are unknown.

In matrix notation, if  $\bar{R} = \bar{l}_{XGR}$  is a vector pointed toward the satellite, its components in the inertial coordinate system,  $\bar{R}_I$ , are given by the following expression:

$$\bar{R}_I = [-RA_M]_z [L_M]_y [-\phi_M]_x [-\psi]_y \bar{l}_{XGR} \quad (A1)$$

The satellite can also be located with respect to inertial space through the orbital elements as follows (fig. 9): System 6 is obtained by a rotation about  $Z_I = Z_6$  through the angle  $\Omega$ , aligning the  $X_6$  axis along the line of nodes. Rotation about  $X_6 = X_7$  through the inclination angle  $i$  locates system 7, with  $X_7 Y_7$  defining the orbital plane. A further rotation through the angle  $\theta$  about  $Z_7 = Z_8$  until  $X_8$  is along  $X_G$  locates system 8. The angle  $\theta$  represents orbital motion, and can be written as  $\theta = \theta_0 + \omega_0 t$  where  $\omega_0$  is orbital velocity. The angle about  $X_8 = X_G$  between system 8 and the geographic coordinate system is not needed.

In matrix notation:

$$\bar{R}_I = [-\Omega]_z [-i]_x [-\theta]_z \bar{I}_{XGR} \quad (A2)$$

Equations (A1) and (A2) may now be equated and by premultiplying the resulting equation by  $[RA_M]_z$  and then  $[-L_M]_y$  the following expression is obtained:

$$[-\phi_M]_x [-\psi]_y \bar{I}_{XGR} = [-L_M]_y [RA_M]_z [-\Omega]_z [-i]_x [-\theta]_z \bar{I}_{XGR} \quad (A3)$$

A  
4  
7  
4 where the two sides of the equation are different means for determining the components of  $\bar{R}$  in coordinate system 4. All angles on the right-hand side are known and if the indicated multiplications are carried out, the components of  $\bar{R}$  in coordinate system 4 can be determined.

$$\bar{R} = \begin{bmatrix} R_{x_4} \\ R_{y_4} \\ R_{z_4} \end{bmatrix} \quad (A4)$$

where  $R_{x_4}$ ,  $R_{y_4}$ , and  $R_{z_4}$  represent the components of  $\bar{R}$  in coordinate system 4.

Explicitly carrying out the multiplication indicated on the left-hand side of equation (A3) gives

$$\begin{bmatrix} 1 & 0 & 0 \\ 0 & c\phi & -s\phi \\ 0 & s\phi & c\phi \end{bmatrix} \begin{bmatrix} c\psi & 0 & s\psi \\ 0 & 1 & 0 \\ -s\psi & 0 & c\psi \end{bmatrix} \begin{bmatrix} 1 \\ 0 \\ 0 \end{bmatrix} R = \begin{bmatrix} c\psi \\ s\phi s\psi \\ -c\phi s\psi \end{bmatrix} R \quad (A5)$$

where c and s represent cosine and sine, respectively. Equating (A4) and (A5) and solving for the cosine and sine of each of the angles gives

$$\left. \begin{aligned} c\psi &= \frac{R_{x_4}}{R} & s\psi &= \sqrt{1 - \frac{R_{x_4}^2}{R^2}} = \frac{1}{R} \sqrt{R_{y_4}^2 + R_{z_4}^2} \\ s\phi &= \frac{R_{y_4}}{\sqrt{R_{y_4}^2 + R_{z_4}^2}} & c\phi &= \frac{-R_{z_4}}{\sqrt{R_{y_4}^2 + R_{z_4}^2}} \end{aligned} \right\} \quad (A6)$$

so that, if desired, the angles  $\phi$  and  $\psi$  can be explicitly determined.

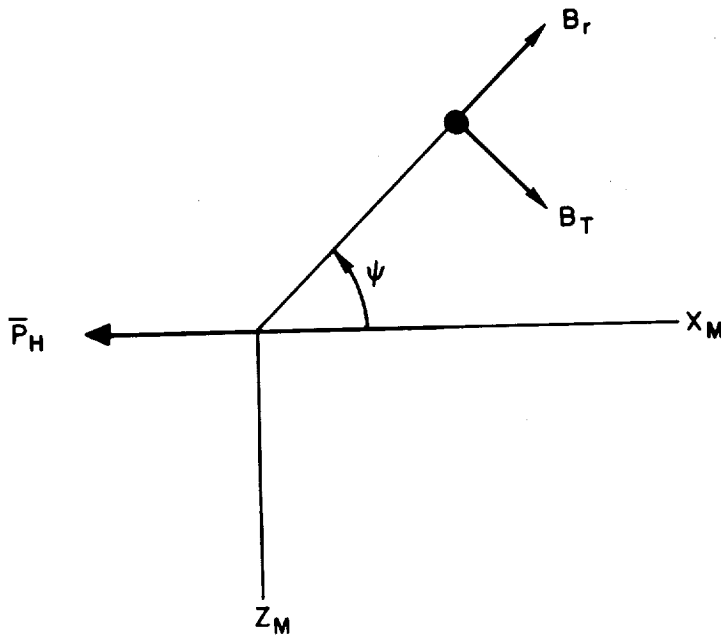

Sketch (c)

We have now located the satellite in the magnetic field by means of the angles  $\psi$  and  $\psi$ , and the components of the magnetic field vector in satellite coordinates can now be determined.

It is assumed that the magnetic field of the earth can be represented by a simple magnetic moment, with components as shown in the accompanying sketch. The axes  $X_M$  and  $Z_M$  of the magnetic coordinate system are shown. The satellite is located by definition in the  $X_M Z_M$  plane with a negative  $Z_M$ . The field at the satellite has the components

A  
4  
7  
4

$$B_r = - \frac{2\mu_0 P_H \cos \psi}{4\pi R^3}$$

$$B_T = \frac{\mu_0 P_H \sin \psi}{4\pi R^3}$$

where  $P_H$  represents the magnetic moment.

To determine the inertial components of  $B$ , the given polar components must first be rotated through the angle  $-\psi$  to the rectangular magnetic coordinates and then through the angles  $-\phi$ ,  $L_m$ , and  $-R_{AM}$ . Further rotations through the angles  $R_{AS}$ ,  $-D_s$ , and  $\phi_s$  will then give the components of  $\bar{B}$  in satellite coordinates resulting in the following equations:

$$\bar{B}_I = [-R_{AM}]_z [L_M]_y [-\phi_M]_x [-\psi]_y \begin{bmatrix} -2c\psi \\ 0 \\ s\psi \end{bmatrix} \frac{\mu_0 P_H}{4\pi R^3} \tag{A7}$$

$$\bar{B}_s = [\phi_s]_x [-D_s]_y [R_{AS}]_z \bar{B}_I \tag{A8}$$

It should be noted that  $\bar{B}$  in coordinate system 4 is a function of  $\phi$  and  $\psi$  only, and can be expressed in terms of the components of  $R$  in the same coordinate system. In particular:

$$\begin{aligned} \bar{B}_4 &= [-\phi_M]_x [-\psi]_y \begin{bmatrix} -2c\psi \\ 0 \\ s\psi \end{bmatrix} \frac{\mu_0 P_H}{4\pi R^3} \\ &= \begin{bmatrix} -2c^2\psi + s^2\psi \\ -3s\phi c\psi s\psi \\ 3c\phi c\psi s\psi \end{bmatrix} \frac{\mu_0 P_H}{4\pi R^3} \end{aligned} \quad (A9)$$

Substituting (A6) into (A9) gives

$$\bar{B}_4 = - \begin{bmatrix} 1 - \frac{3R_{x_4}^2}{R^2} \\ \frac{3R_{x_4} R_{y_4}}{R^2} \\ \frac{3R_{x_4} R_{z_4}}{R^2} \end{bmatrix} \frac{\mu_0 P_H}{4\pi R^3} \quad (A10)$$

Then

$$\bar{B}_I = [-R_{Mz}]_z [L_M]_y \bar{B}_4 \quad (A11)$$

Combining equations (A11), (A10), and (A3) then gives the components of the earth's magnetic field, in satellite coordinates.

## REFERENCES

1. White, John S., and Hansen, Q. Marion: Study of Systems Using Inertia Wheels for Precise Attitude Control of a Satellite. NASA TN D-691, 1961.
2. Page, Leigh; Introduction to Theoretical Physics. Third ed., D. Van Nostrand Co., 1952.
3. Parkinson, W. D., and Cleary, J.: The Eccentric Geomagnetic Dipole. Geophysical Journal of the Royal Astronomical Society (Letter to the Editor), vol. 1, no. 4, Dec. 1958.
4. Triplett, William C.: Design Considerations for an Orbiting Astronomical Observatory. ARS Paper 1184-60, 1960.

A  
4  
7  
4



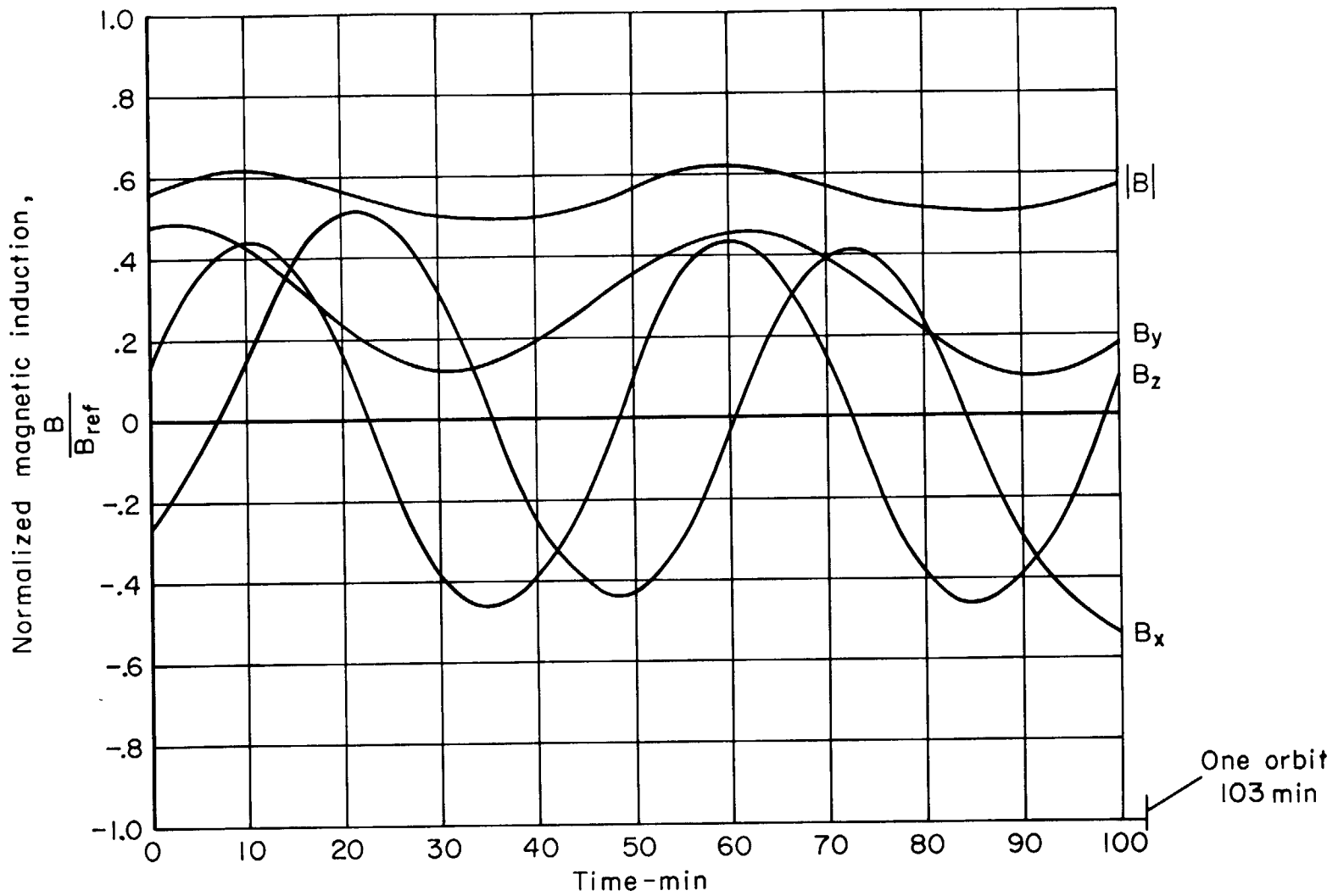
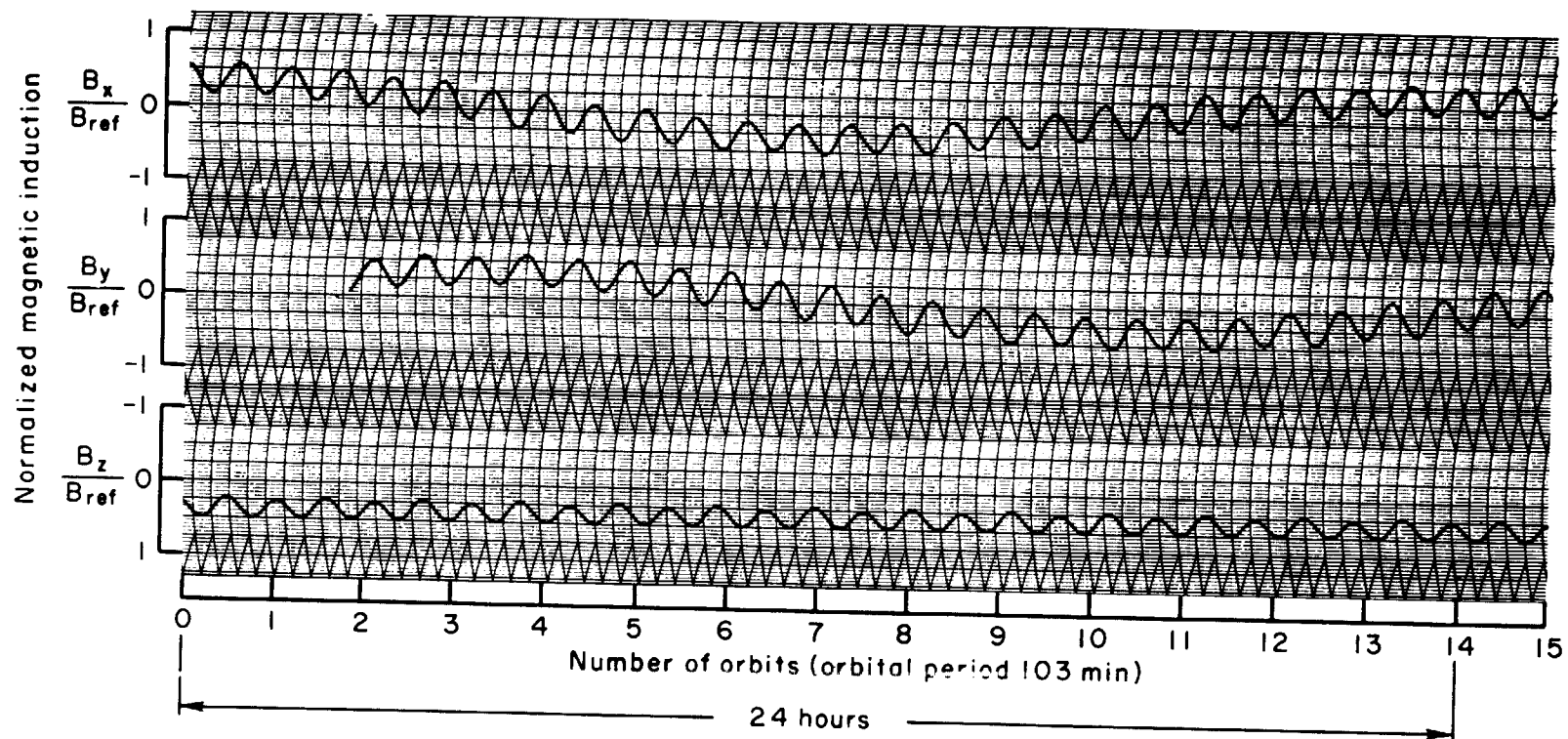
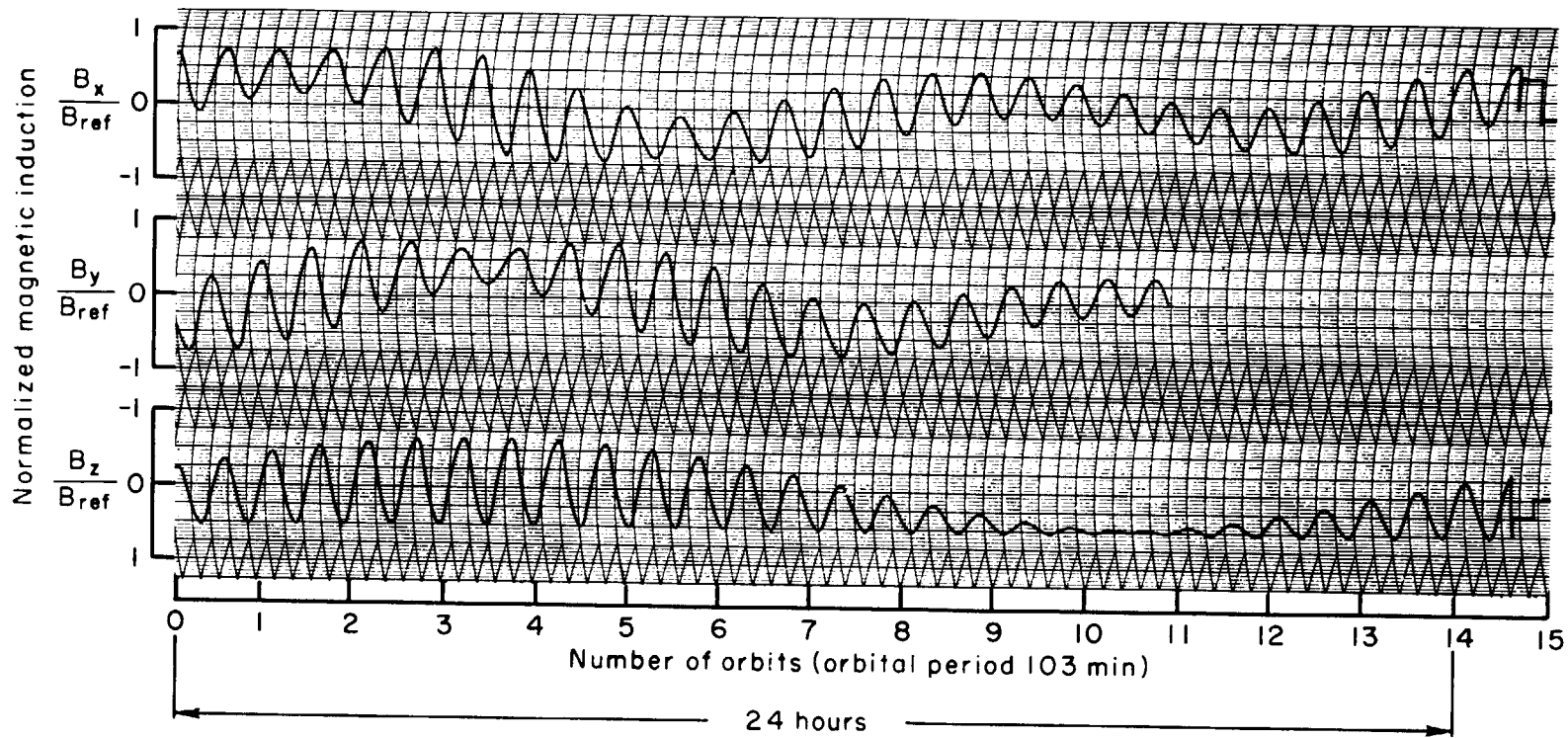

Figure 1.- Components of earth's magnetic field in vehicle coordinates for a typical orbit of  $35^\circ$  inclination.



(a) 1° orbital inclination.

Figure 2.- Components of earth's magnetic field in vehicle coordinates for various orbital inclinations.



(b)  $35^\circ$  orbital inclination.

Figure 2.- Continued.

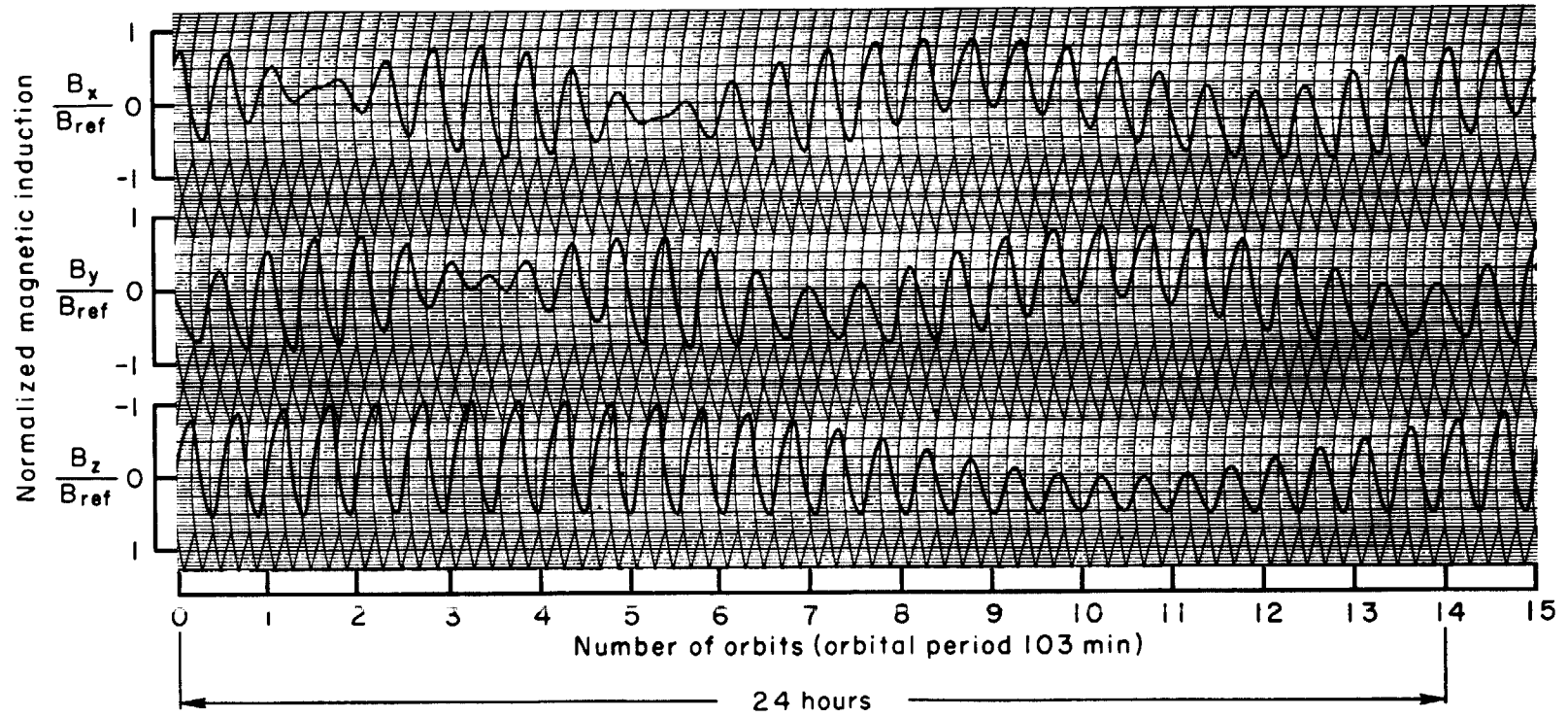

(c)  $60^\circ$  orbital inclination.

Figure 2.- Continued.

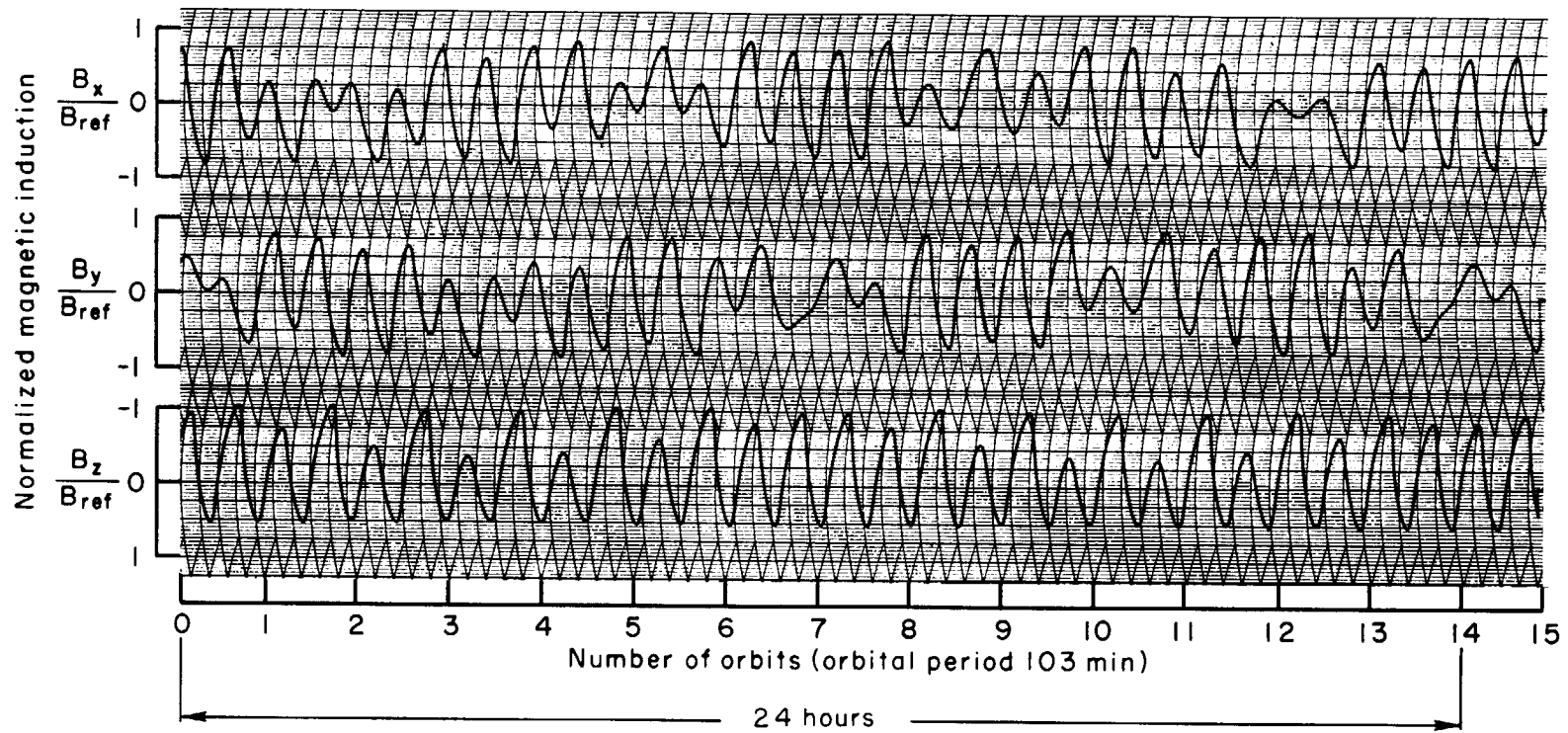

(d)  $75^\circ$  orbital inclination.

Figure 2.- Continued.

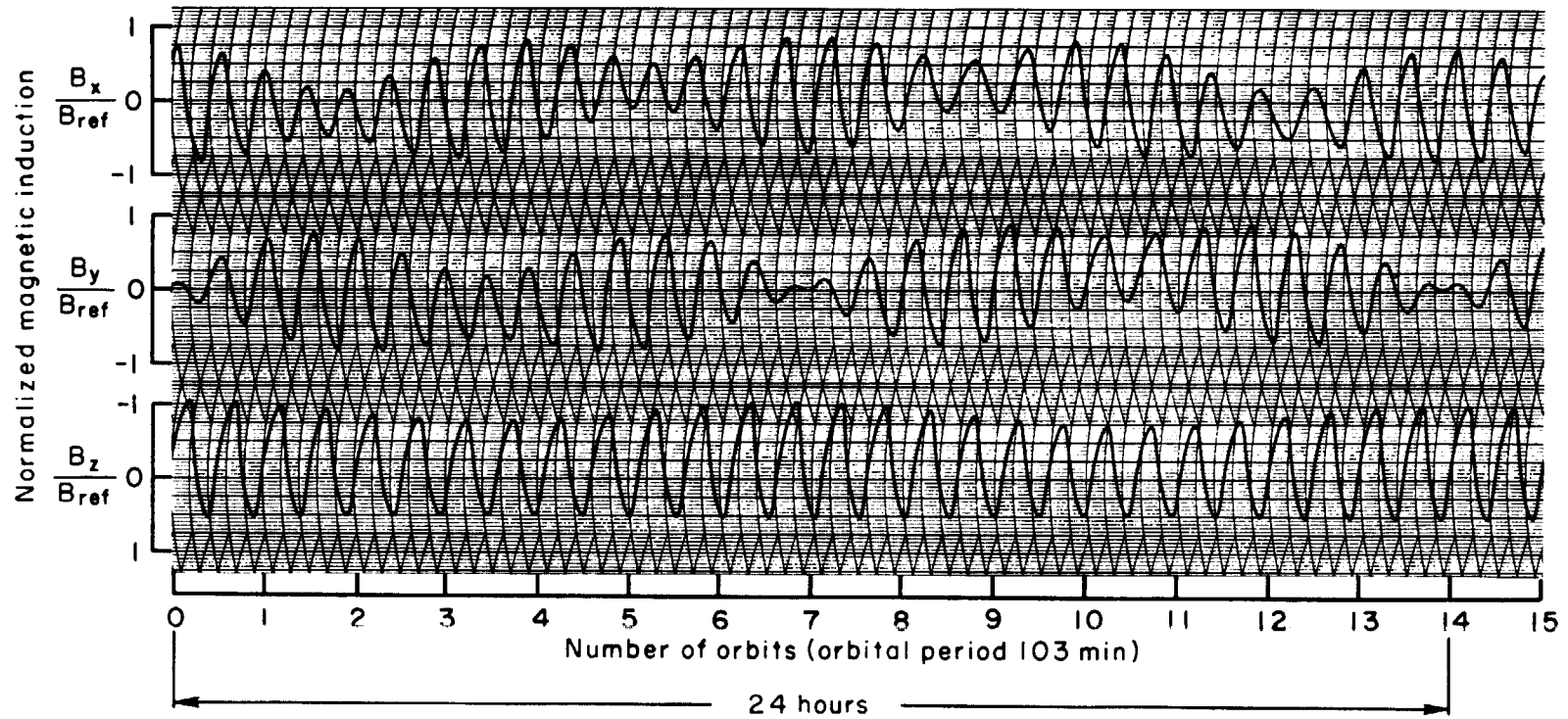

(e)  $89^\circ$  orbital inclination.

Figure 2.- Concluded.

A  
4  
7  
4

Figure 3.- Configuration of errors and coils in vehicle coordinate system.



A  
4  
7  
4

Open-loop response

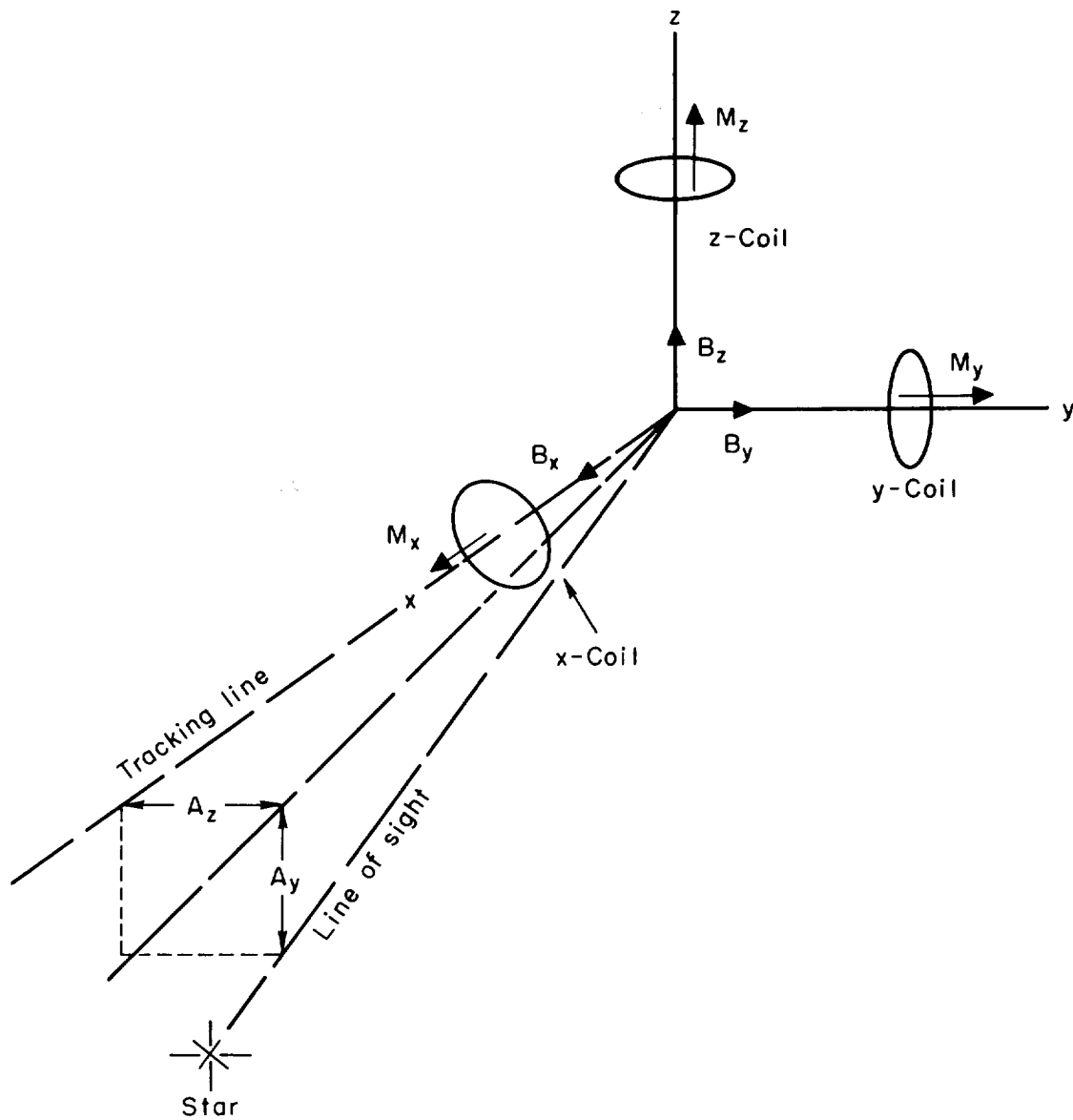
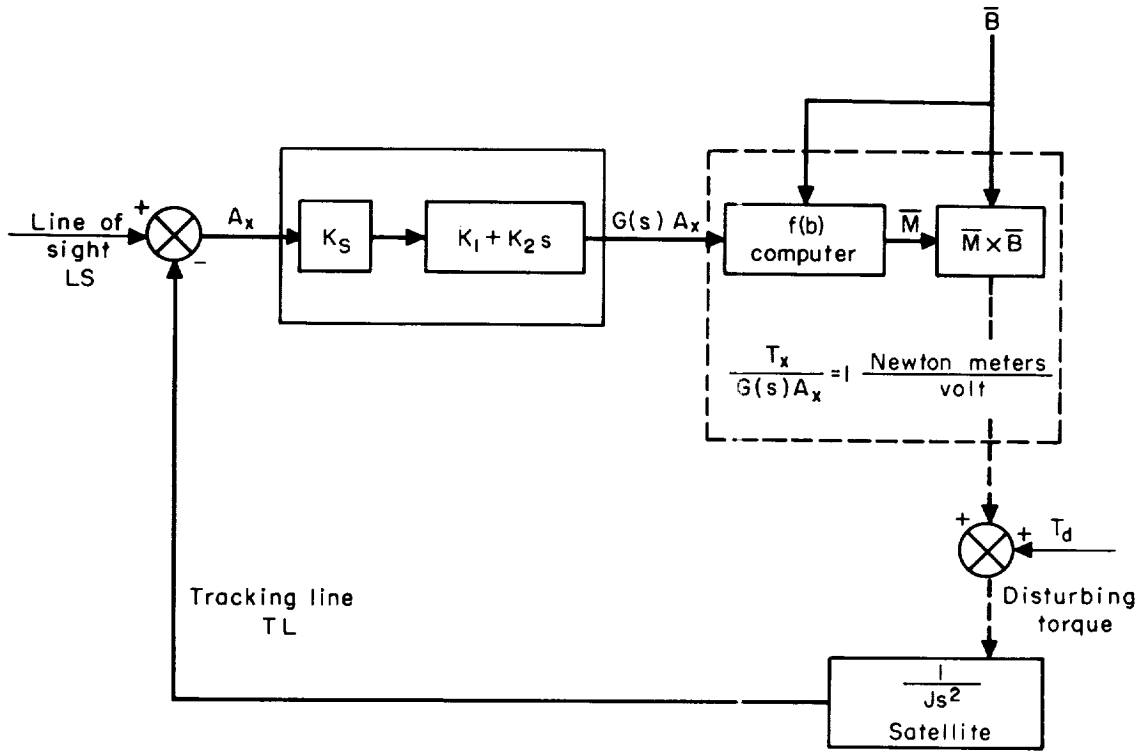
$$TL = \frac{A_x G(s) + T_d}{Js^2}$$

Closed loop response

$$TL = \frac{LS \left( \frac{K_I + K_2 s}{J} \right) K_S + \frac{T_d}{J}}{s^2 + \frac{K_2 K_S}{J} s + \frac{K_I K_S}{J}}$$

Figure 4.- Block diagram of one axis of magnetic control system.



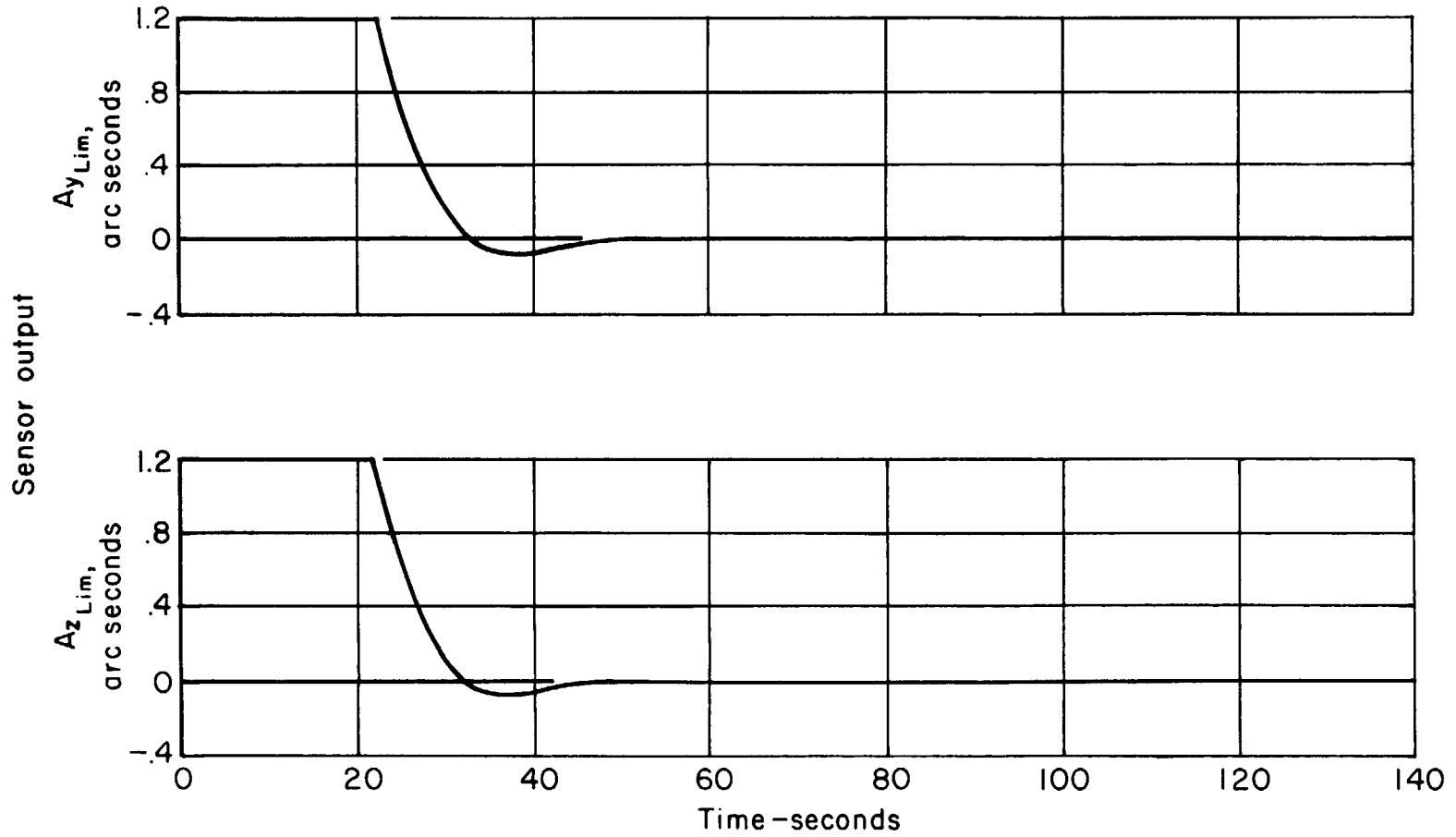

(a)  $B_x/B_{\text{ref}} = 0.05$ ,  $B_y/B_{\text{ref}} = 0.28$ , and  $B_z/B_{\text{ref}} = 0.47$

Figure 5.- Transient response of a two-axis, three-coil magnetic control system.

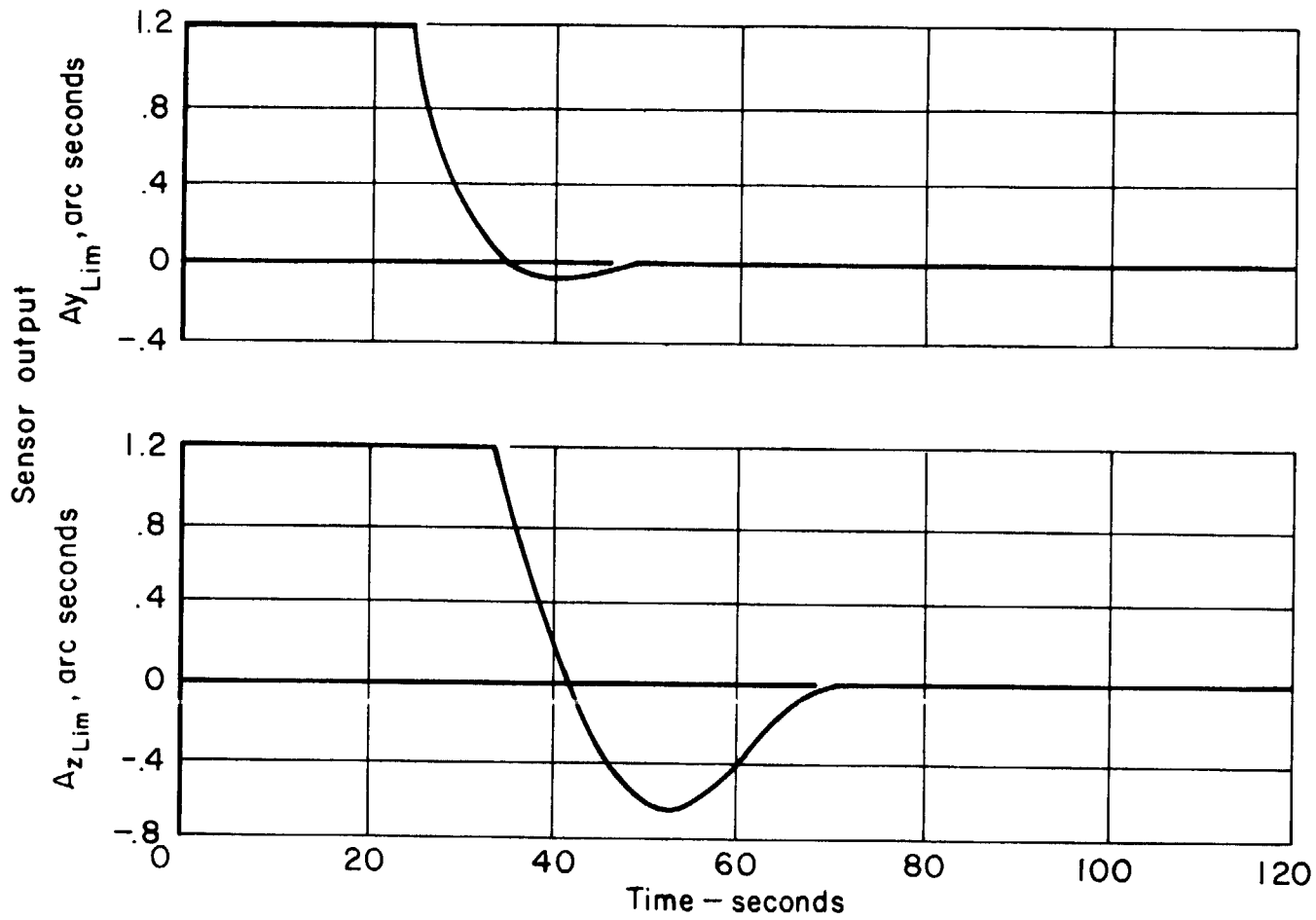

(b)  $B_x/B_{ref} = 0.05$ ,  $B_y/B_{ref} = 0$ , and  $B_z/B_{ref} = 0.55$

Figure 5.- Continued.

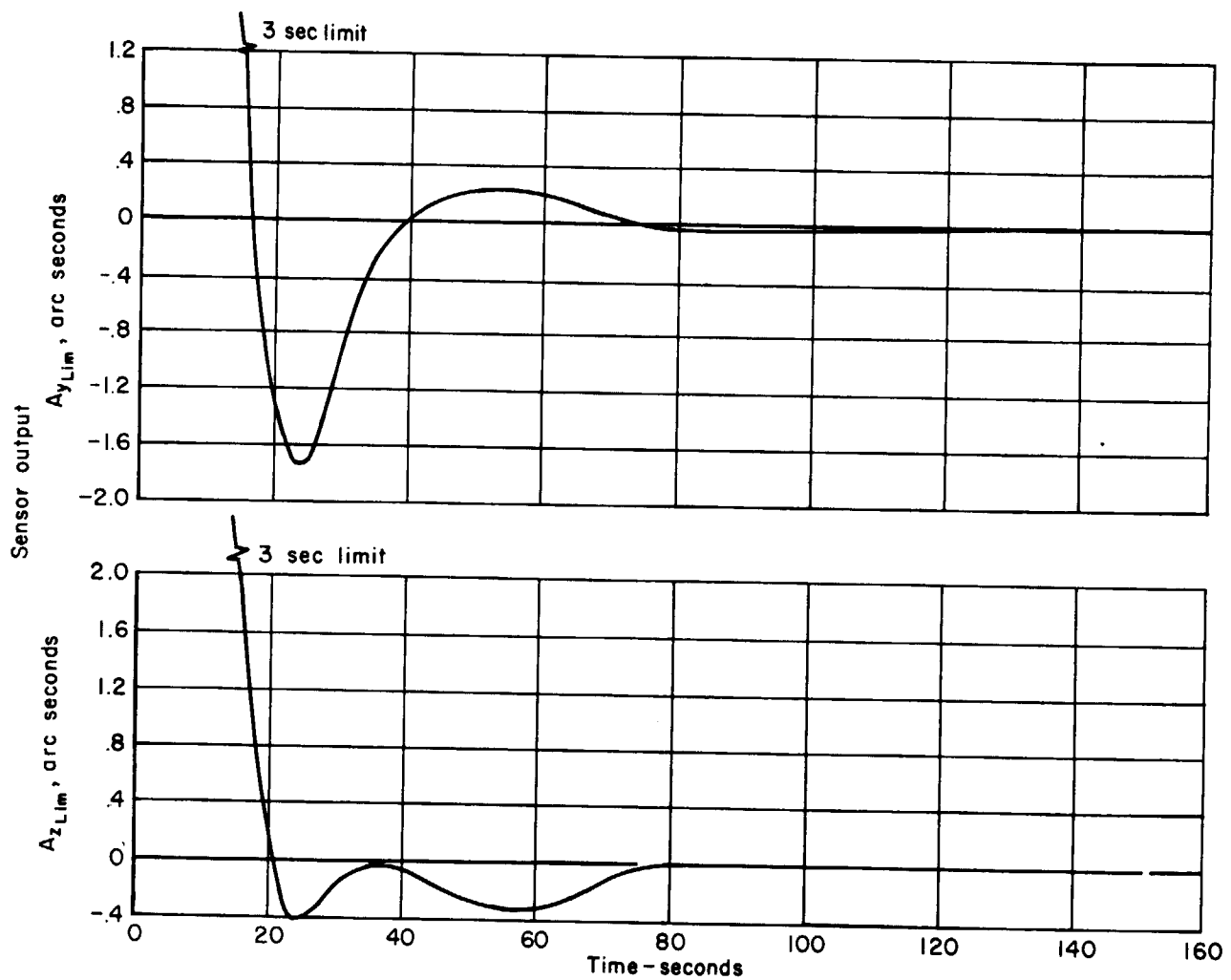

(c)  $B_x/B_{ref} = 0.01$ ,  $B_y/B_{ref} = 0.36$ , and  $B_z/B_{ref} = 0.51$

Figure 5.- Continued.

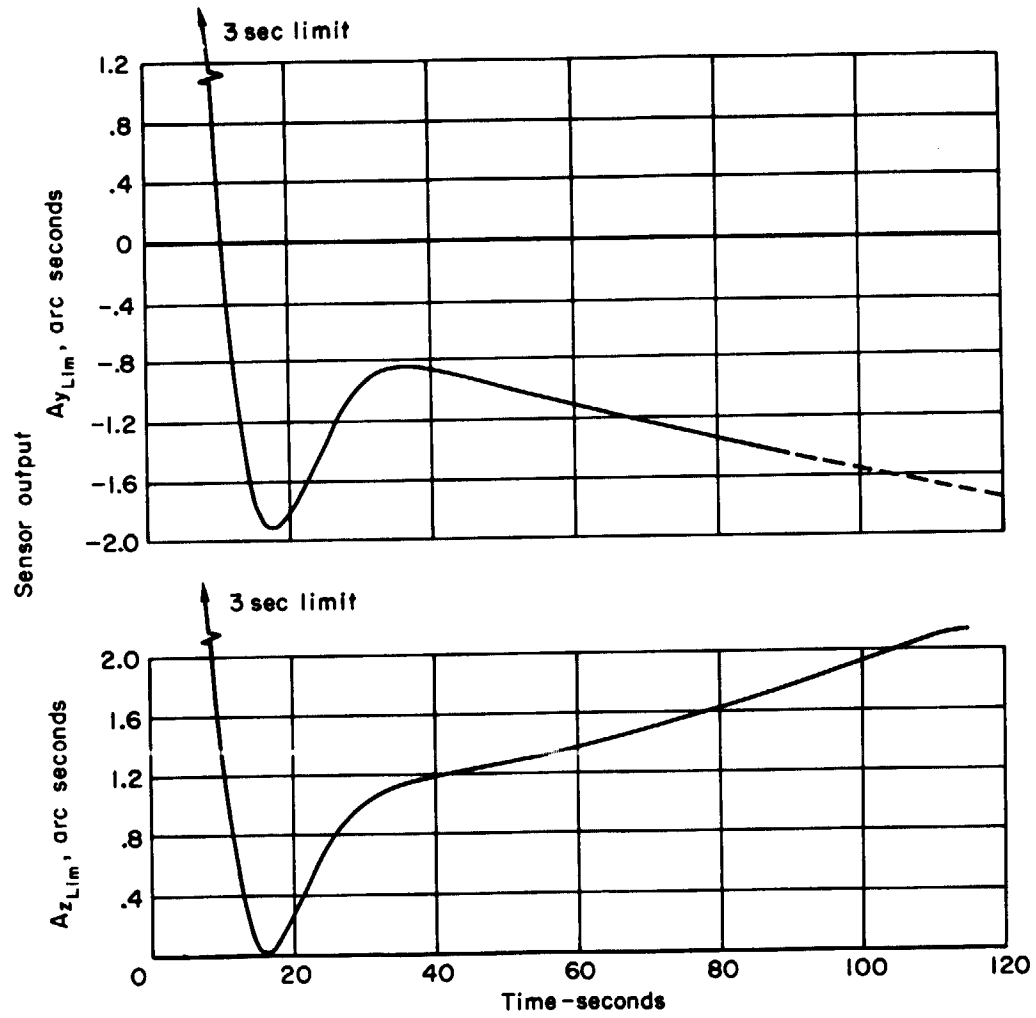

(d)  $B_x/B_{ref} = 0$ ,  $B_y/B_{ref} = 0.36$ , and  $B_z/B_{ref} = 0.51$

Figure 5.- Concluded.

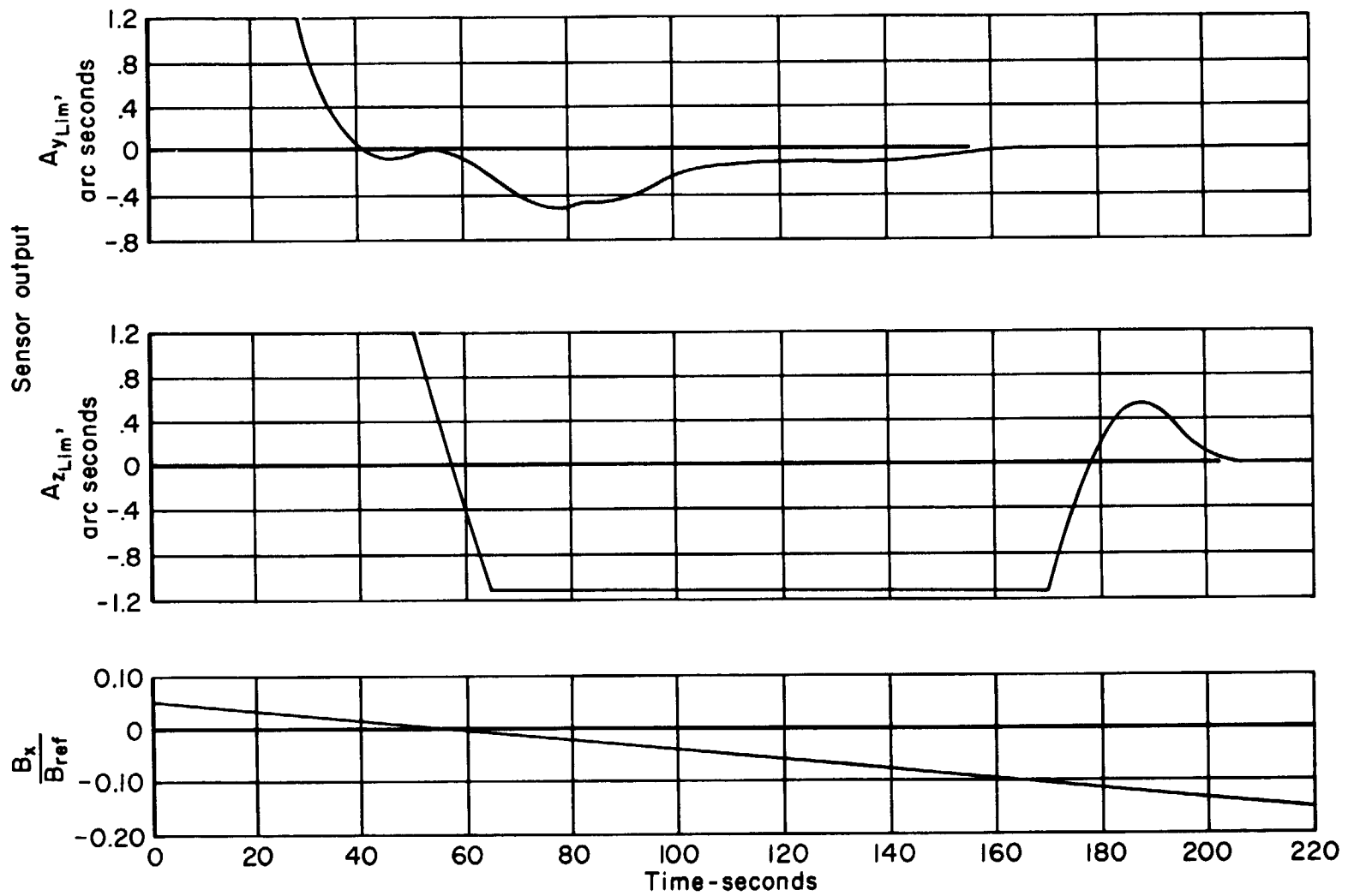

Figure 6.- Transient response of a two-axis, three-coil magnetic control system with variable magnetic field;  $B_x$  crossing through zero.

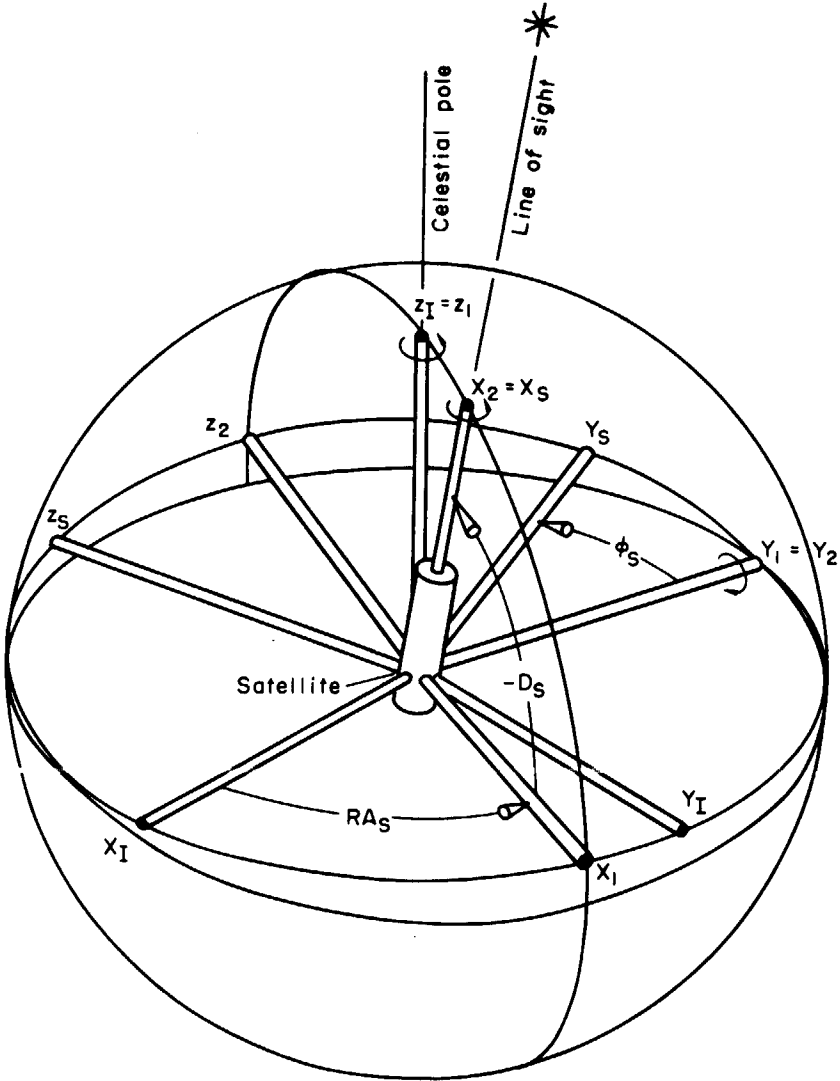

Figure 7.- Transformations between the inertial and the vehicle coordinate systems.

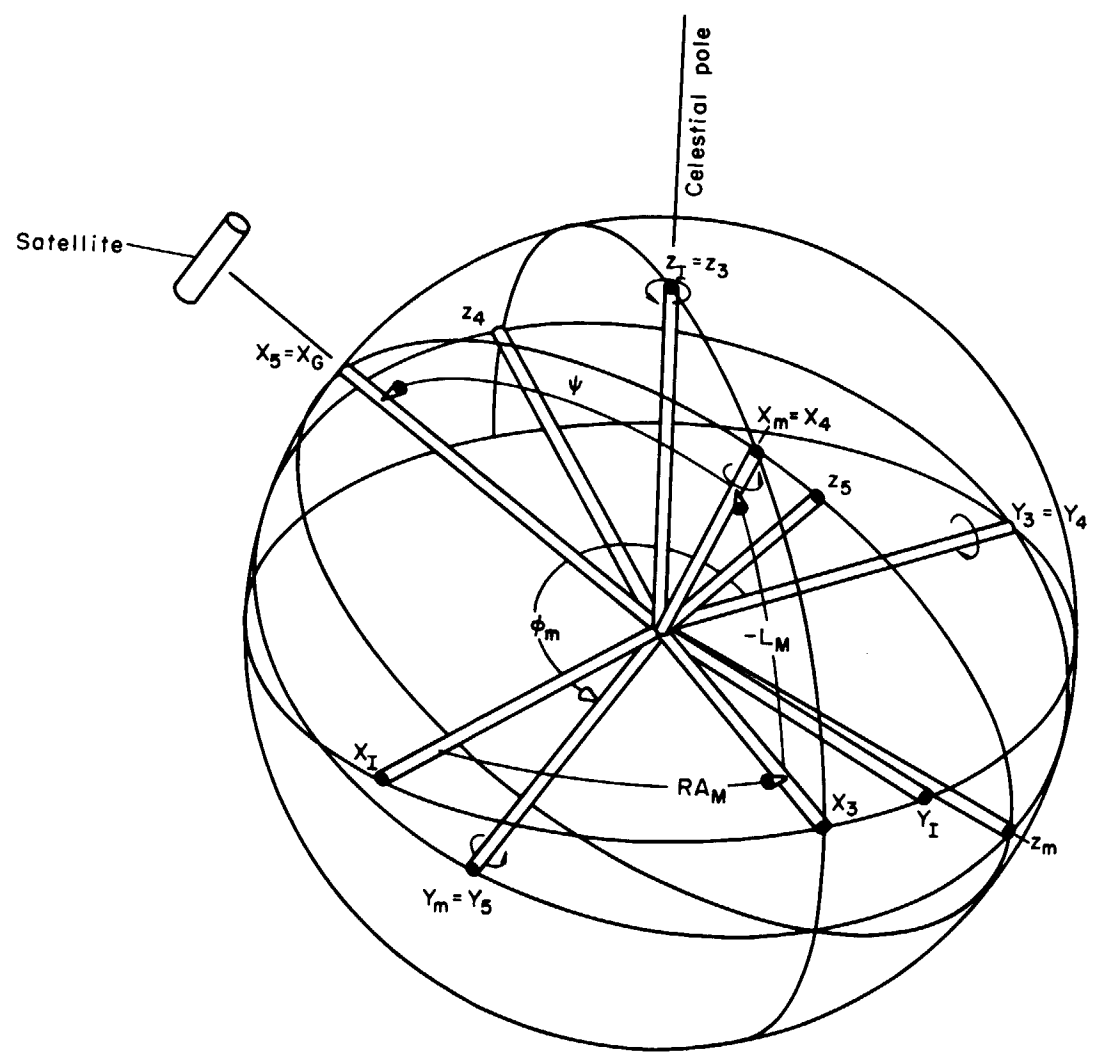

Figure 8.- Transformations between the inertial and geographic coordinate systems via the magnetic coordinate system.

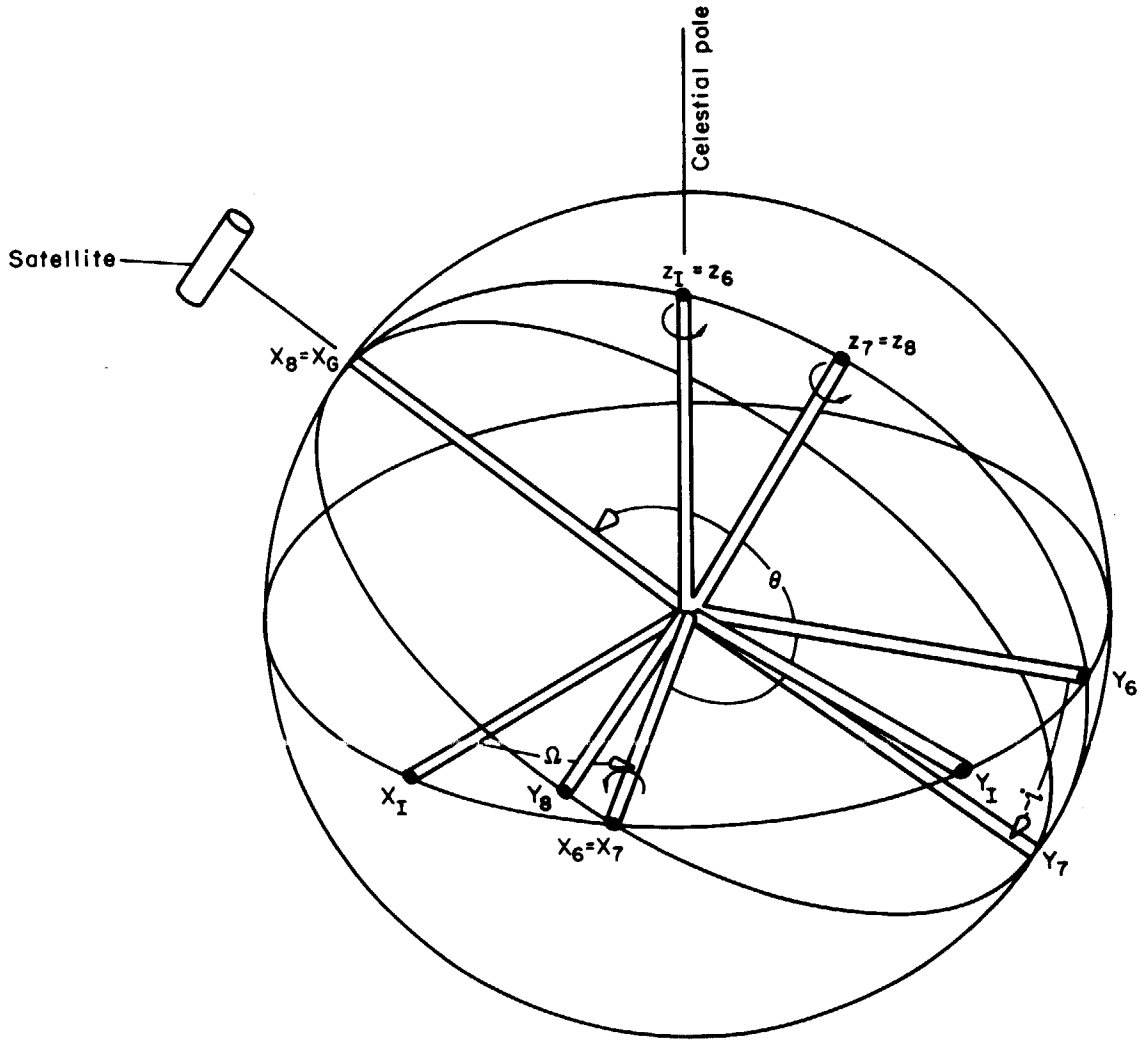

Figure 9.- Transformations between the inertial and geographic coordinate systems via the orbital elements.





