



COMSAT LABORATORIES

LOCKHEED MARTIN 

EOS-AM1 Nickel Hydrogen Cell Interim Life Test Report

by

C.W. Bennett

Lockheed Martin Missiles and Space

NA 44

3000000

D.J. Keys, G.M. Rao
NASA/GSFC

H.E. Wannemacher
Jackson and Tull

H. Vaidyanathan
COMSAT Laboratories

(Performed under NASA Contracts NAS5-32500 and NAS5-32600)

Abstract



LOCKHEED MARTIN



This paper reports the interim results of the Earth Observing System AM-1 project (EOS-AM-1) nickel hydrogen cell life test being conducted under contract to National Aeronautics and Space Administration (NASA) Goddard Space Flight Center (GSFC) at the Lockheed Martin Missiles and Space (LMMS) facility in East Windsor, NJ; and at COMSAT Labs., Clarksburg, MD. The purpose of the tests is to verify that the EOS-AM-1 cell design can meet five years of real-time Low Earth Orbit (LEO) cycling. The tests include both real-time LEO and accelerated stress tests. At LMMS, the first real-time LEO simulated 99 minute orbital cycle started on February 7, 1994 and the test has been running continuously since that time, with 18202 LEO cycles completed as of September 1, 1997. Each cycle consists of a 64 minute charge (VT at 1.507 volts per cell, 1.06 C/D ratio, followed by 0.6 ampere trickle charge) and a 35 minute constant power discharge at 177 watts (22.5% DOD). At COMSAT, the accelerated stress test consists of 90 minute orbital cycles at 60% DOD with a 30 minute discharge at 60 amperes and a 60 minute charge at 40 amperes (VT at 1.54 volts per cell to 1.09 C/D ratio, followed by 0.6 ampere trickle charge).

The real-time LEO life test battery consists of seven, 50AH (nameplate rating) Eagle-Picher, Inc. (EPI) Mantech cells manufactured into three, 3-cell pack assemblies (there are two place holder cells that are not part of the life test electrical circuit). The test pack is configured to simulate the conductive thermal design of the spacecraft battery, including: conductive aluminum sleeves, 3-cell pack aluminum baseplate, and honeycomb panel all mounted to a liquid (-5°C) cold plate. The entire assembly is located in a thermal chamber operating at +3°C. The accelerated stress test unit consists of five cells mounted in machined aluminum test sleeves and is operating at +10°C.

The real-time LEO life test battery has met all performance requirements through the first 18,202 cycles, including: end of charge and discharge cell voltages and voltage gradients; end of charge and discharge cell pressures; within cell and between cell temperature gradients; discharge capacity; current and power levels; and all charge parameters. The accelerated stress test battery has completed 11998 cycles when the test was terminated. The stress test unit met all test parameters. This paper reports battery performances as a function of cycle life for both the real-time LEO and the accelerated life test regimes.



LOCKHEED MARTIN

Battery Assembly/Spacecraft Interface

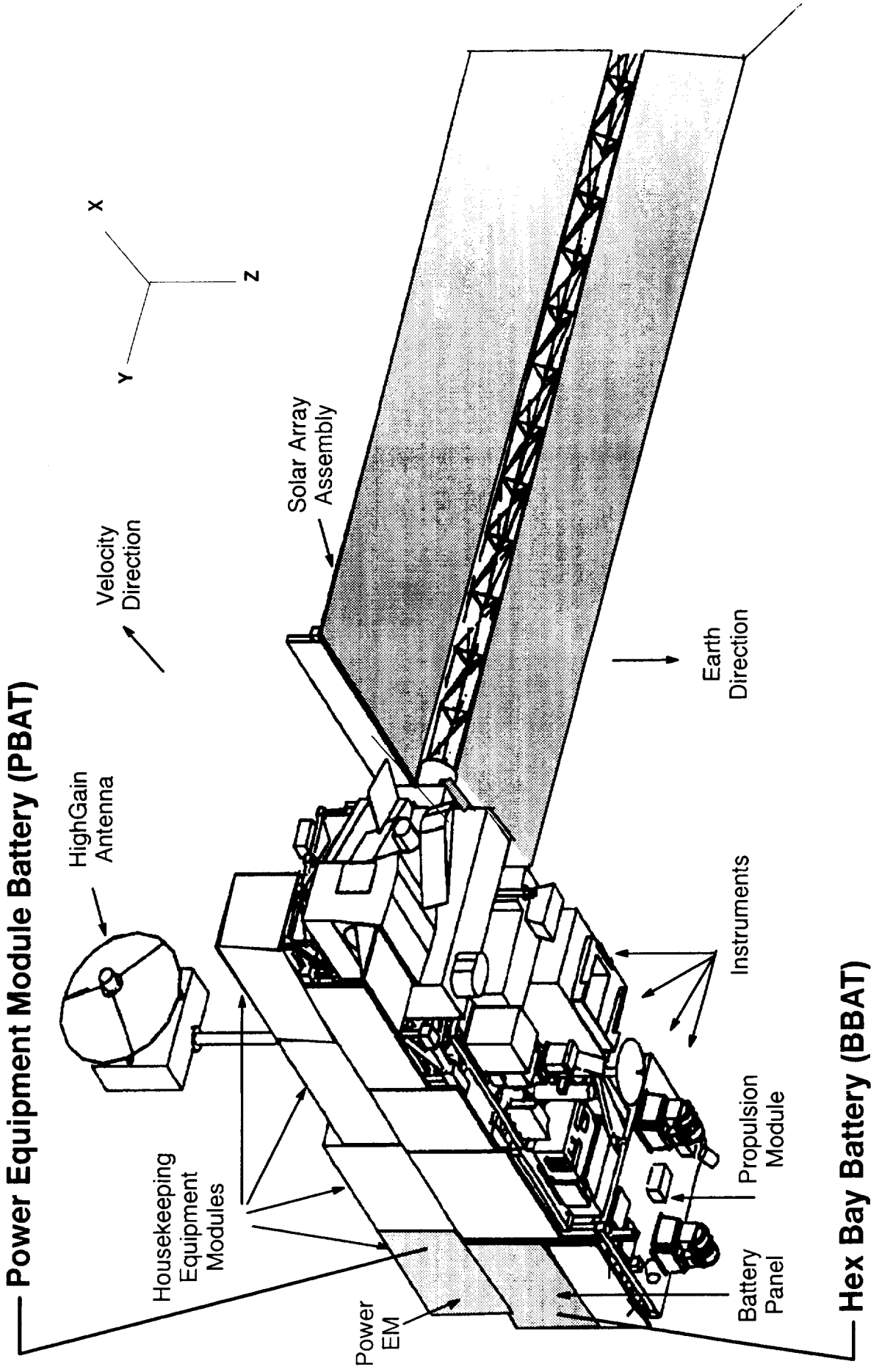



Outline

- **EOS-AM cell parameters**
- **Real-time LEO test conditions**
- **Real-time LEO test results**
 - **Figures 1–9**
- **Accelerated LEO stress test conditions**
- **Accelerated LEO stress test results**
 - **Figures 10–18**
- **Summary and conclusions**



LOCKHEED MARTIN

EOS-AM Cell Parameters

- **Single stack, IPV, Mantech design**
- **Rabbit ear terminals**
- **40, 30 mil slurry electrodes**
- **Back to back with double layer Zircar, catalyzed wall wick**
- **31% KOH, nickel precharge**
- **Average cell weight = 1490 grams**
- **Average delivered capacity (C/2 discharge)**
 - 10°C: 75 AH**
 - 0°C: 71 AH**
 - +10°C: 63 AH**
 - +20°C: 56 AH**
 - +30°C: 51 AH**
 - +10°C, 72 hour charge retention: 92% lot ave, 89% minimum**



Real-time LEO Test Conditions

- **Performed at LMMS, East Windsor, NJ**
- **Number of cells: 7**
- **Cell configuration:**
 - **Conductive thermal design with same configuration as spacecraft**
 - **Machined aluminum sleeves and baseplate**
 - **Chotherm and RTV 566 isolation**
 - **Mounted to spacecraft honeycomb panel with Al face sheets**
 - **Liquid cooled (-5°C) cold plate**
- **Discharge regime: 177 watts (total) constant power discharge for 35 minutes**
- **Depth of discharge: 22.5% nominal**
- **Charge regime:**
 - **12.3 ampere to 1.507 V/T (per cell), taper to 1.06 C/D, 0.6 A trickle**
 - **64 minute total charge time**

LMMS Test History

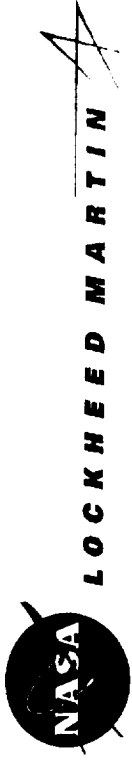

Schedule of Test Interruptions and Changes

Event	Date	Cycle	Description
1	2/21/94	200	Charge time reached prior to VT limit. Several test aborts
2	4/26/94	1110	Cells discharged ~ 45 AH without recharge. Charge time limit reached prior to VT limit
3	10/21/94	3500	VT changed from 10.550 to 10.626
4	10/28/94	3750	Discharge load changed from 177 watts to 88 watts
5	11/5/94	3850	Discharge load changed from 88 watts to 177 watts
6	11/7/94	3900	VT changed from 10.626 to 10.550
7	2/7/95-3/26/95	5200-5900	Data printouts not found
8	5/15/95	6600	Several short duration test aborts
9	6/30/95-7/3/95	7200	Test cells on open circuit due to STE problems
10	9/1/95-9/28/95	8100	Test cells on open circuit due to STE problems
11	11/10/95-11/11/95	8700	Test cells on open circuit due to STE problems
12	9/1/96	12950	Test cells on open circuit due to STE problems
13	2/24/97	15501	Charge parameters changed: Current 12.25A to 15.0A, V/T 10.55 to 10.70, C/D 1.05 to 1.20
14	3/3/97	15601	Charge parameters changed: Current 15.0A to 12.25A, V/T 10.70 to 10.55, C/D 1.20 to 1.05
15	4/7/97	16101	Charge parameters changed: Current 12.25A to 15.0A, V/T 10.55 to 10.70, C/D 1.05 to 1.20
16	4/15/97	16201	Charge parameters changed: Current 15.0A to 12.25A, V/T 10.70 to 10.55, C/D 1.20 to 1.05
17	4/28/97	16401	Charge parameters changed: Current 12.25A to 15.0A, V/T 10.55 to 10.70, C/D 1.05 to 1.20
18	5/5/97	16501	Charge parameters changed: Current 15.0A to 12.25A, V/T 10.70 to 10.55, C/D 1.20 to 1.05
19	8/18/97	18001	Charge parameters changed: Current 12.25A to 11.9A, V/T 10.55 to 10.48, Trickle 0.60A to 2.0A. No C.D. Discharge load 177W to 86.5W
20	8/25/97	18101	Change to standard orbit: 177W discharge, 12.25A charge, V/T=10.55V, C/D=1.05. Trickle=0.60A
21	9/1/97	18202	Final orbital cycle prior to shutdown for move to new facility
22	9/3/97-9/10/97	18205	Special test sequence: 10°C capacity, 10°C 72 hour charge retention, 10°C capacity



LOCKHEED MARTIN



Fig 1

End of Charge and Discharge Battery Voltage vs LEO Cycle

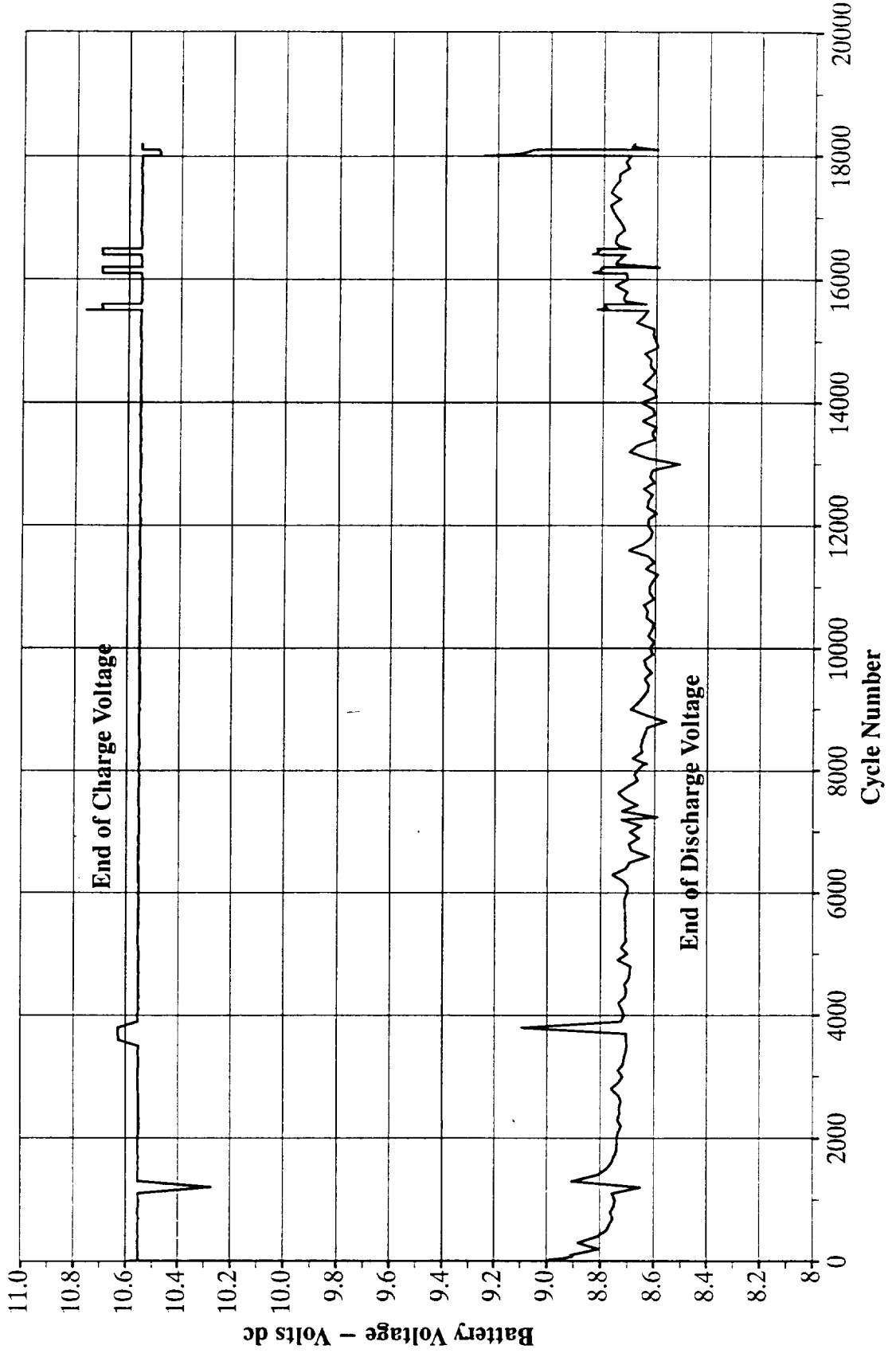
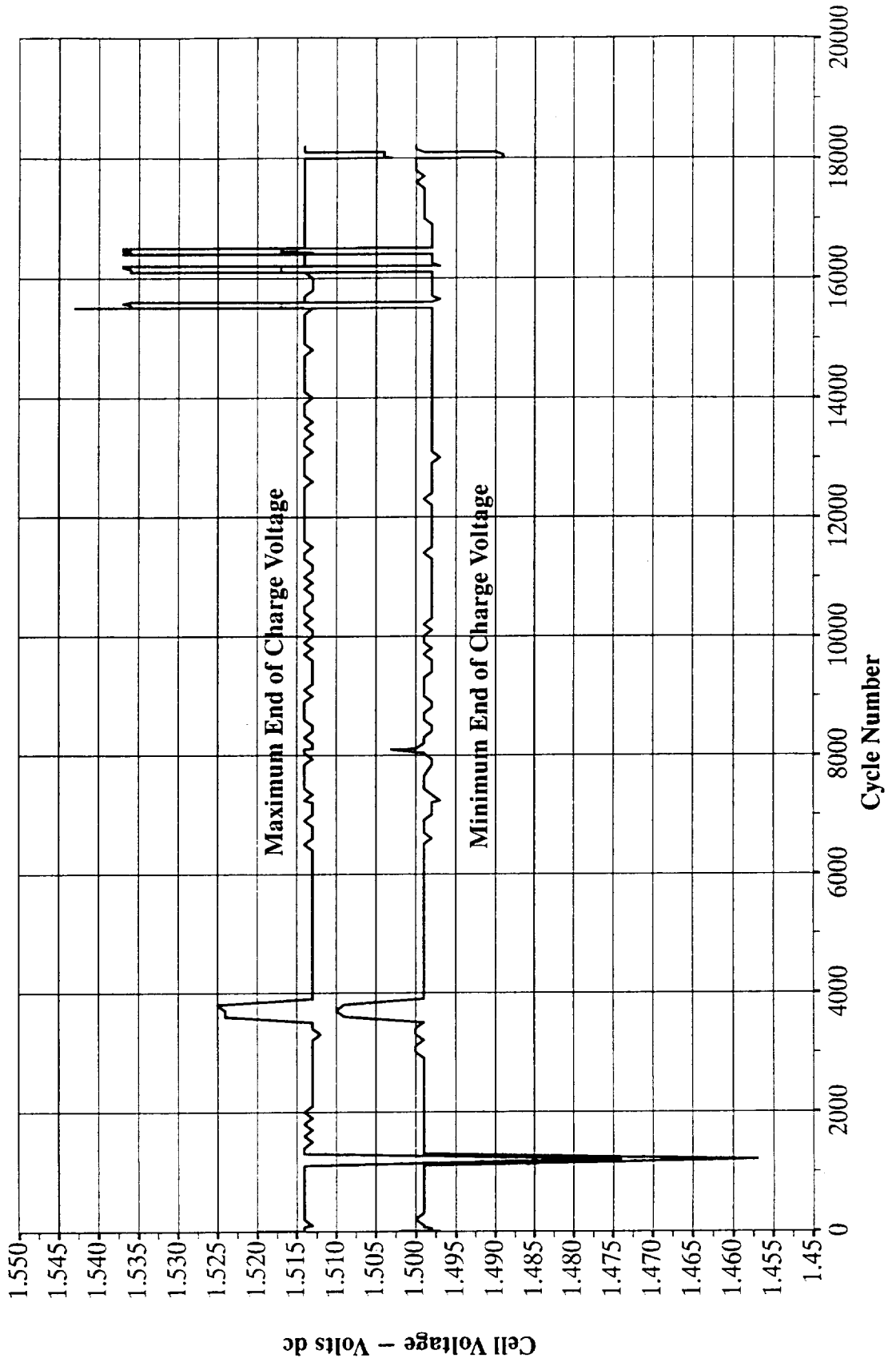

Fig 2**Minimum and Maximum Cell End of Charge Voltage vs LEO Cycle**



LOCKHEED MARTIN

Fig 3

Minimum and Maximum Cell End of Discharge Voltage vs LEO Cycle

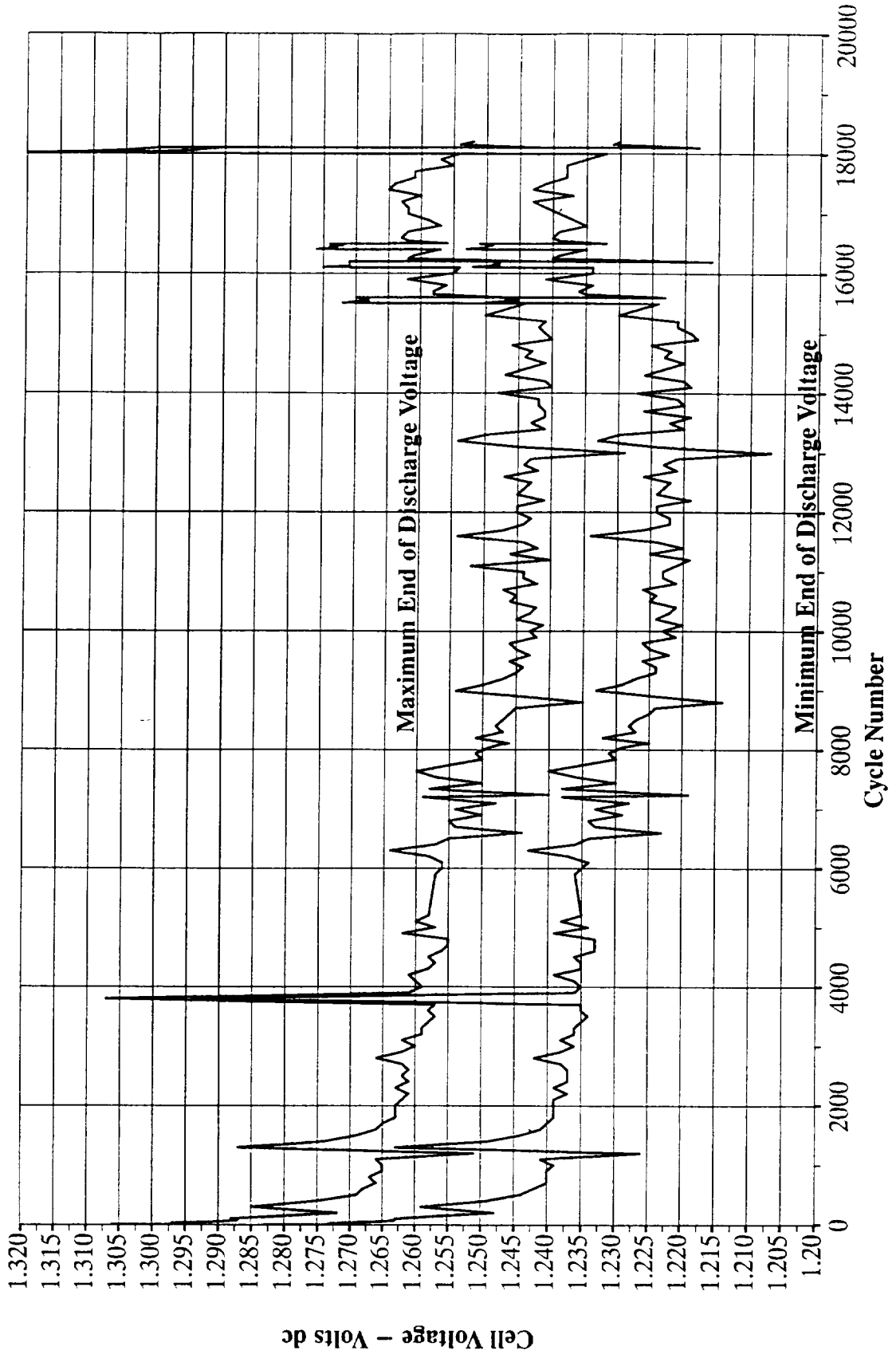

Fig 4

End of Discharge Cell Voltage Gradient vs LEO Cycle

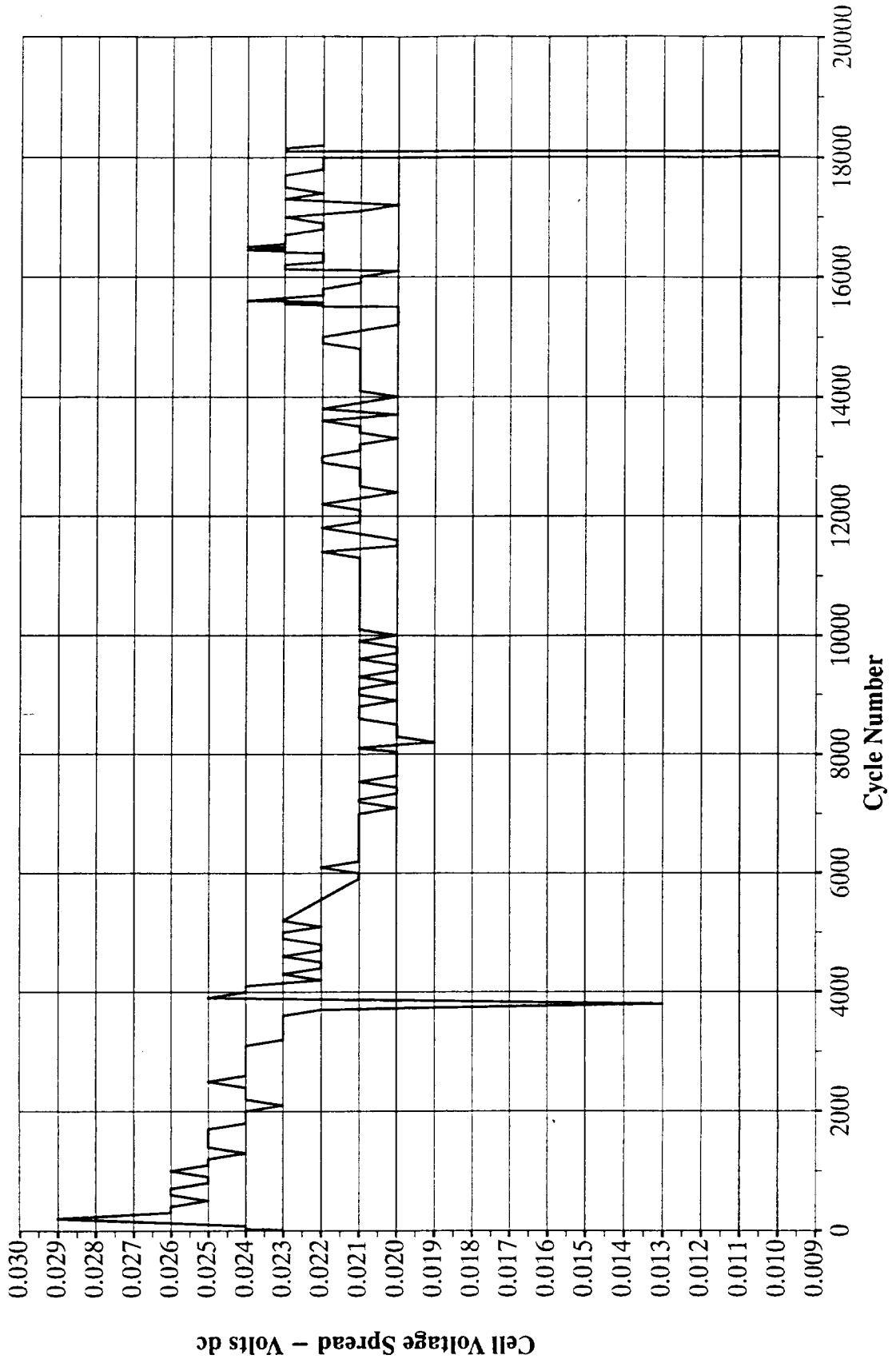
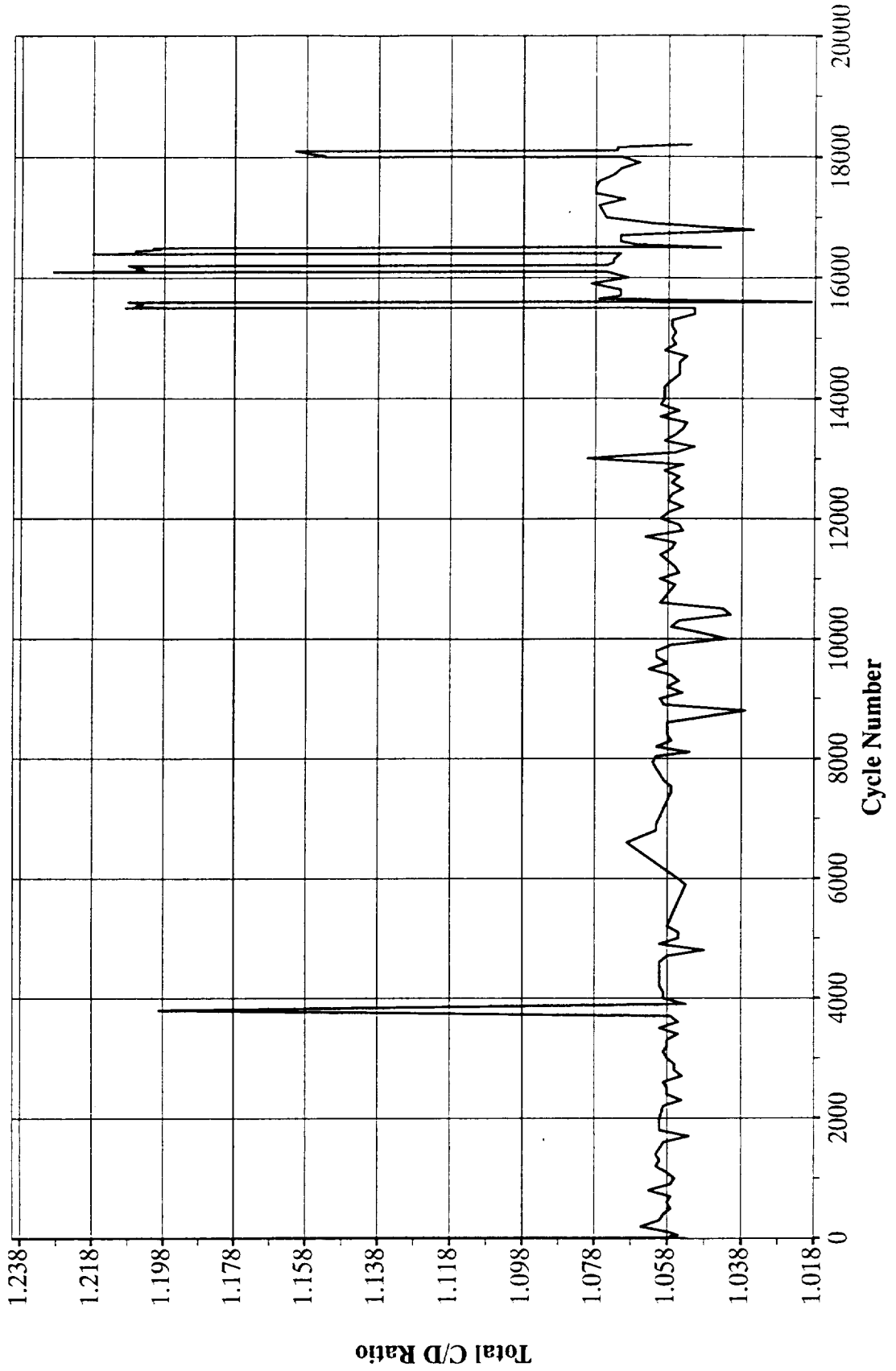

Fig 5

C/D Ratio (Total Charge Capacity/Total Discharge Capacity) vs LEO Cycle





LOCKHEED MARTIN

Fig 6

Cell 1 Pressure vs LEO Cycle

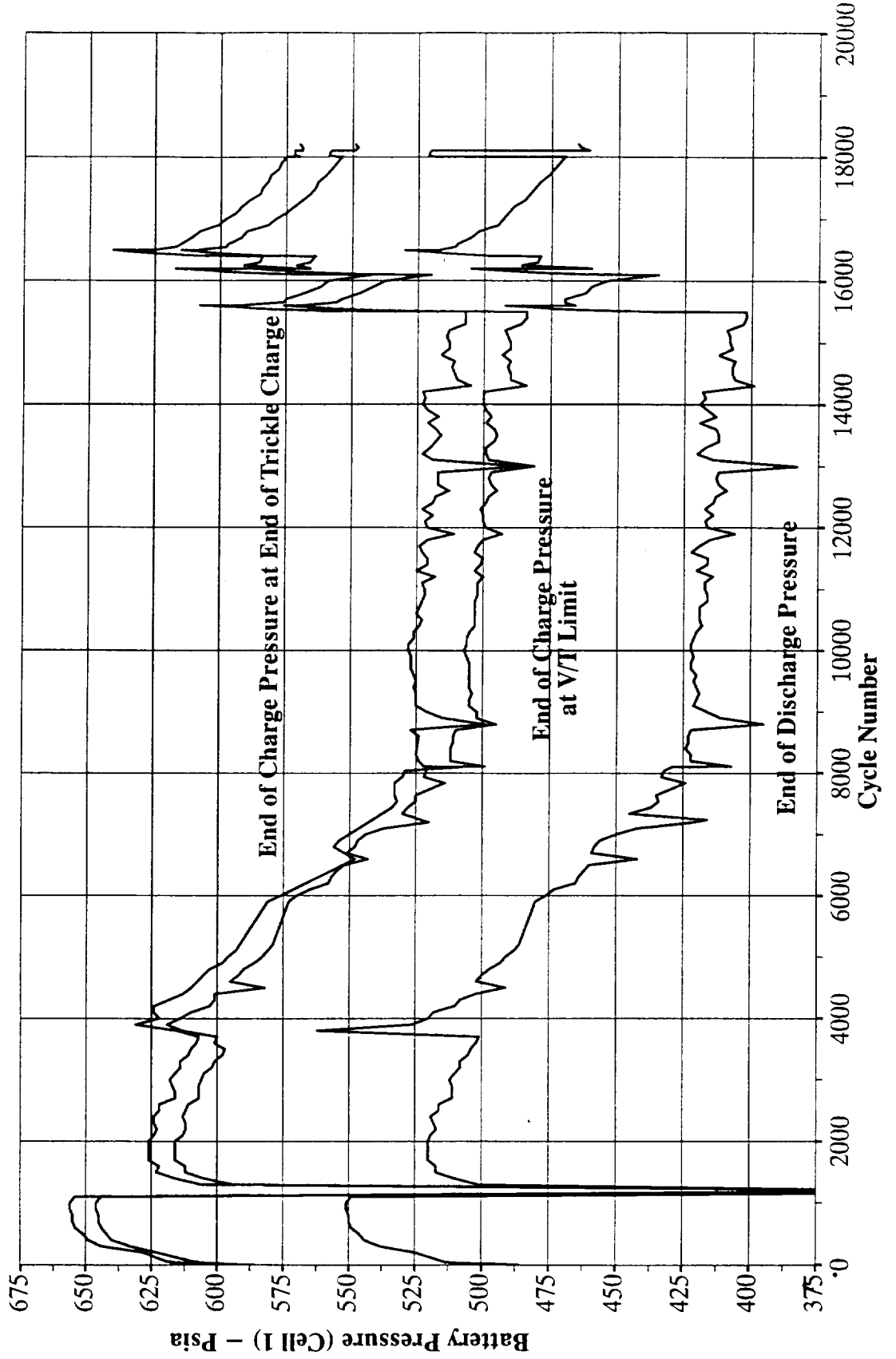



LOCKHEED MARTIN

Fig 7

Individual Cell Charge Voltage for Cycle 17830

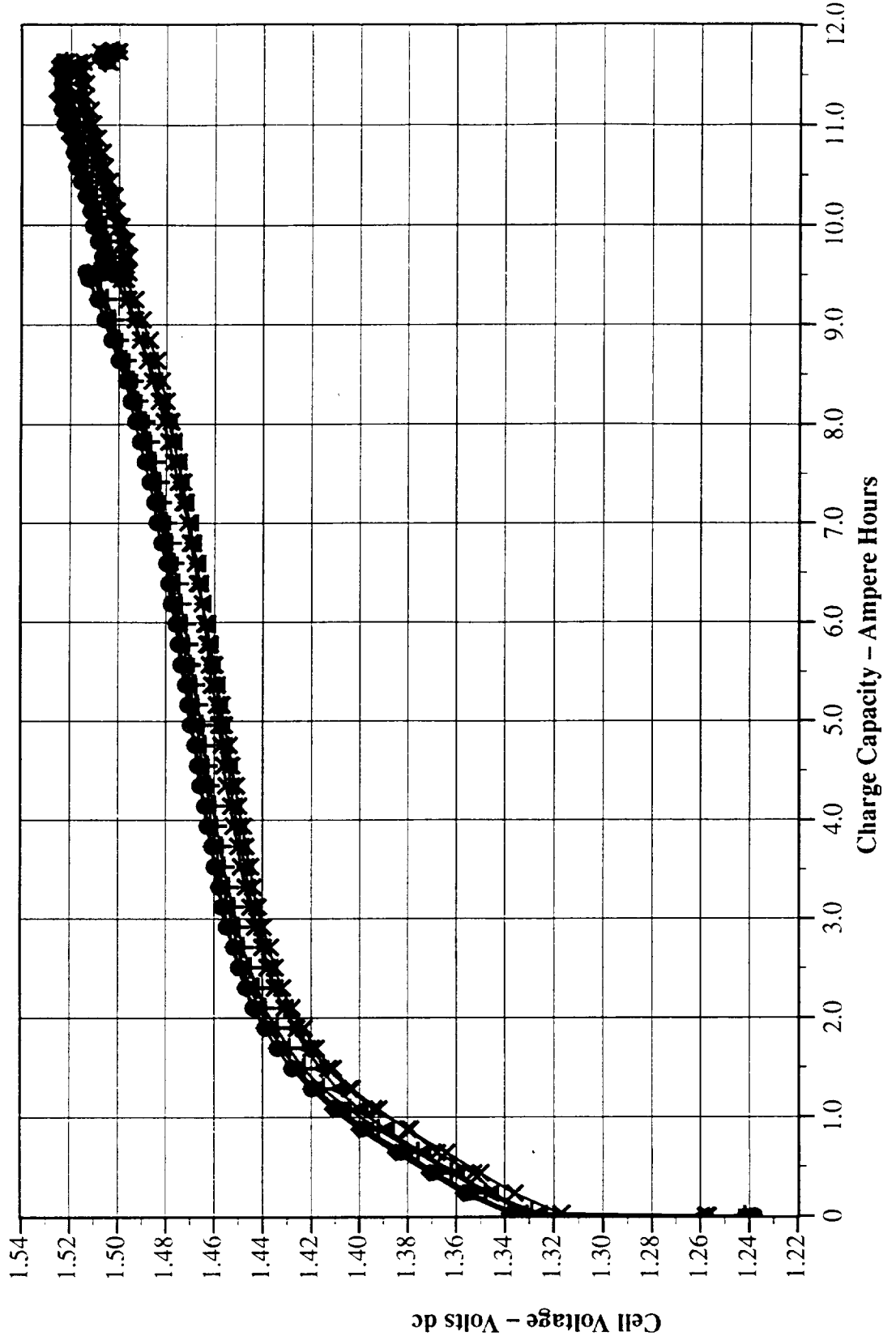
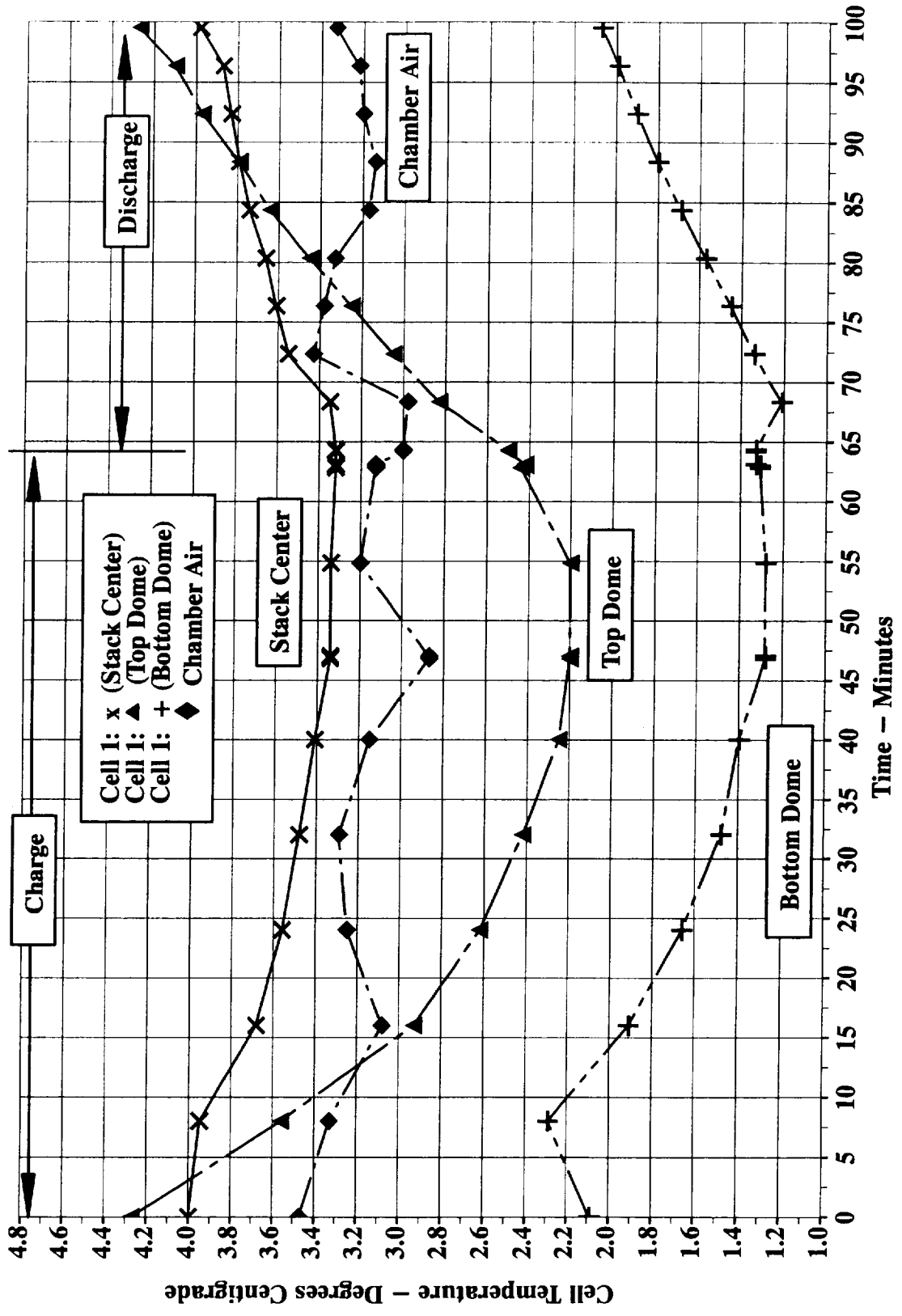

Fig 9

Cell 1 Temperature Profile for Cycle 11800





Accelerated Stress Test Conditions

- **Performed at COMSAT Laboratories**
- **Number of cells: 5**
- **Cell configuration:**
 - **Machined aluminum sleeves**
 - **Mounted on a cold plate**
 - **Chootherm and RTV 566 isolation**
- **Test temperature: 10°C**
- **Discharge regime:**
 - **60 amperes for 30 minutes**
- **Depth of discharge: 60%**
- **Charge regime:**
 - **40 ampere to 1.54 V/T (per cell), taper to 1.09 C/D, 0.6 A trickle**
 - **60 minute total charge time**



Fig 10

Voltage and Current Profiles for Cycle 11998

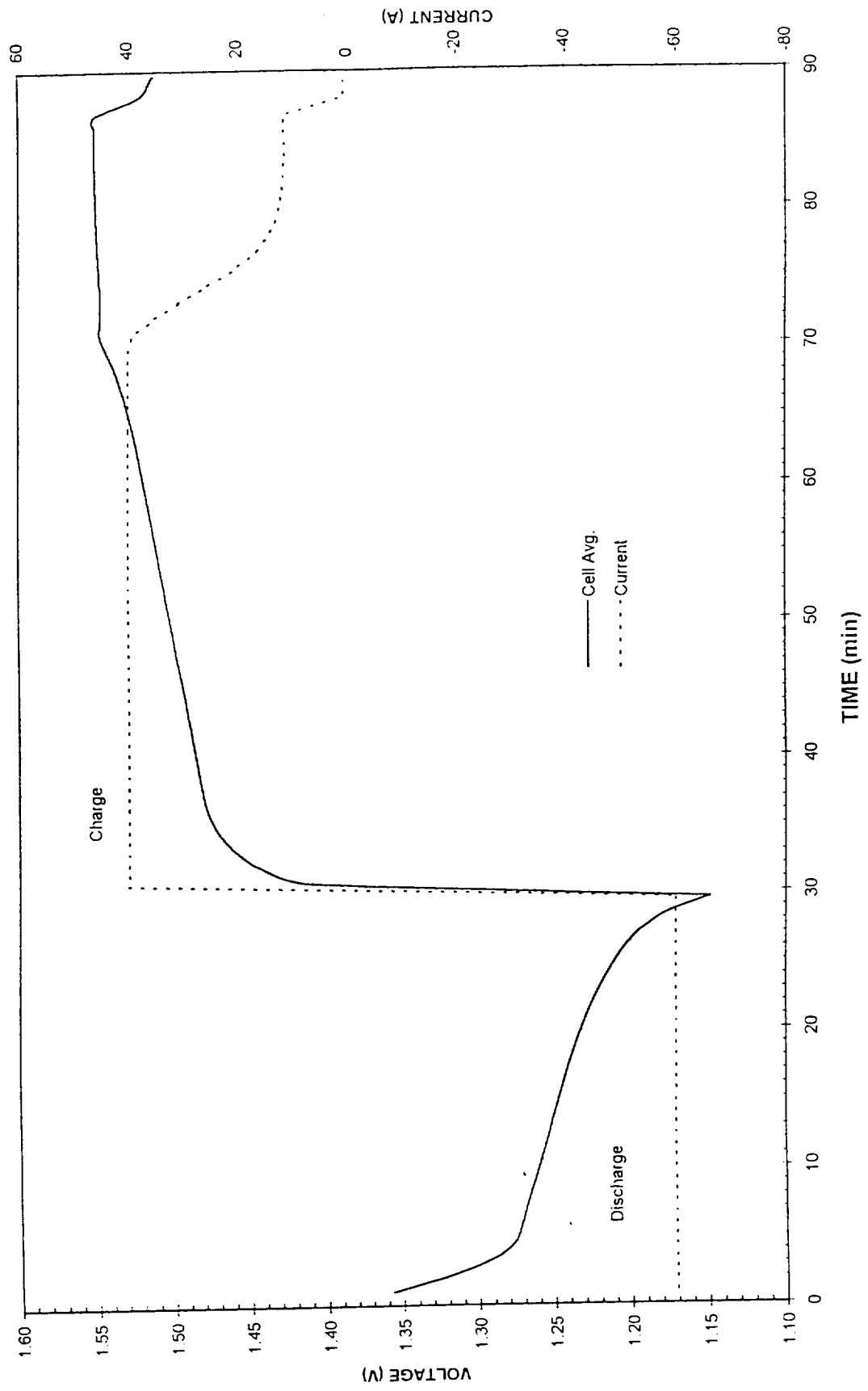

Fig 11



COMSAT LABORATORIES

C/D Ratio

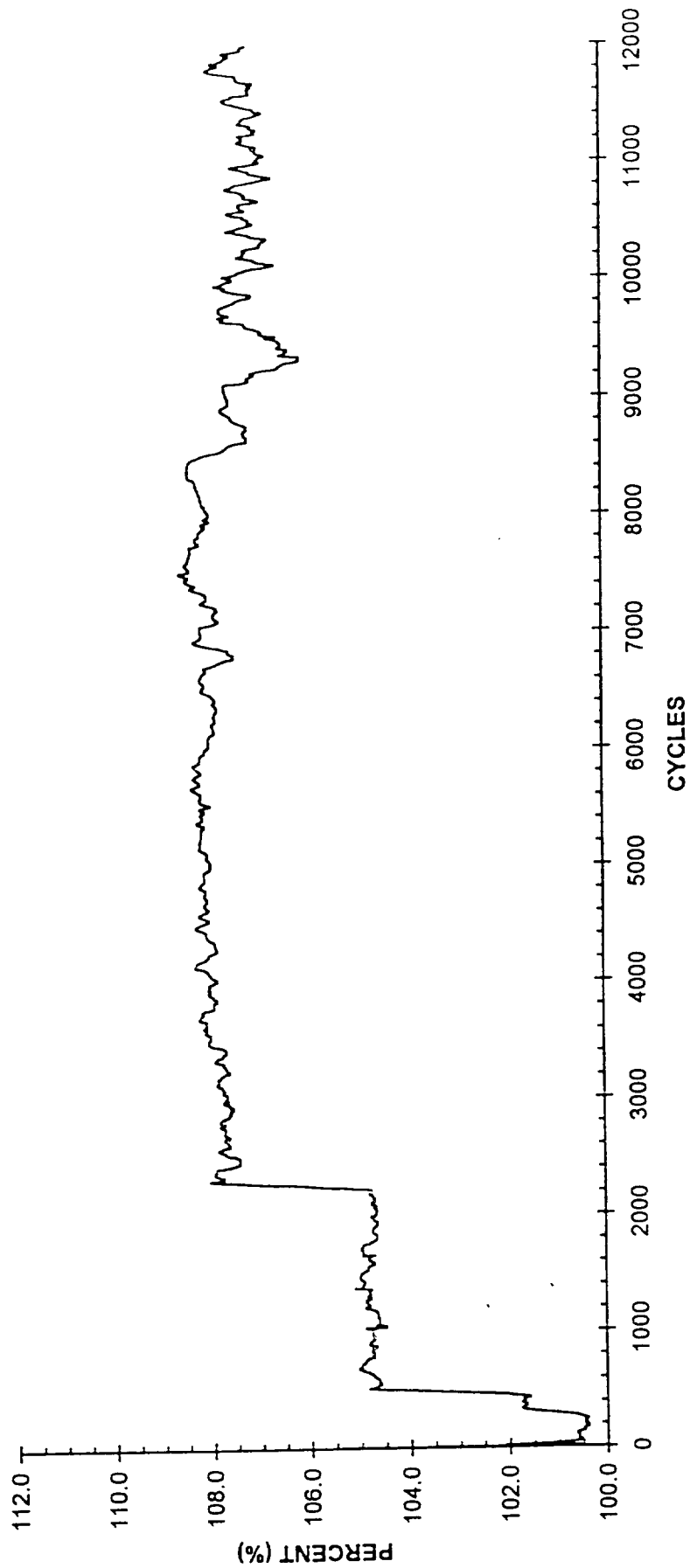

Fig 12



COMSAT LABORATORIES

End of Discharge Sleeve Temperature

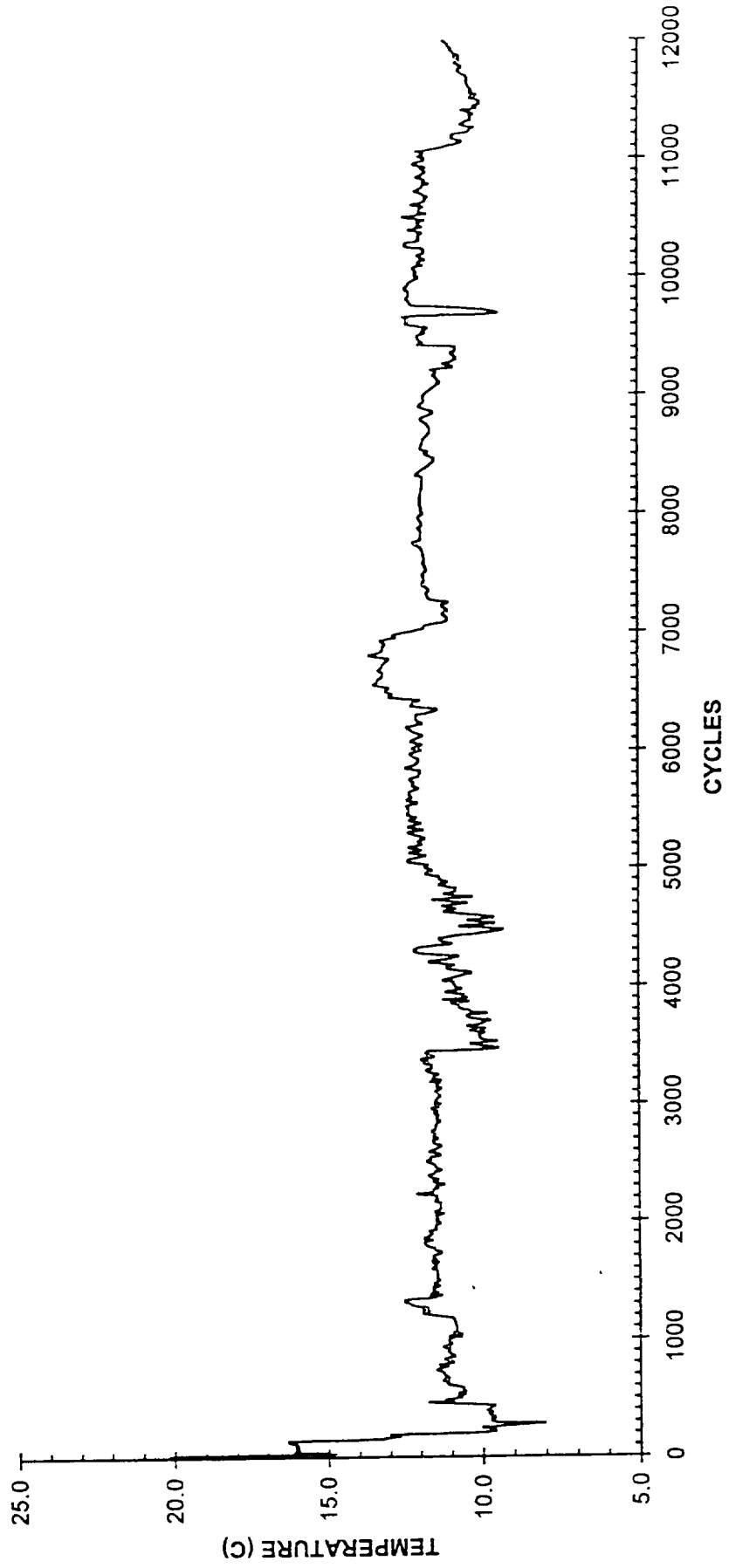

Fig 13



COMSAT LABORATORIES

End of Discharge Average Cell Voltage

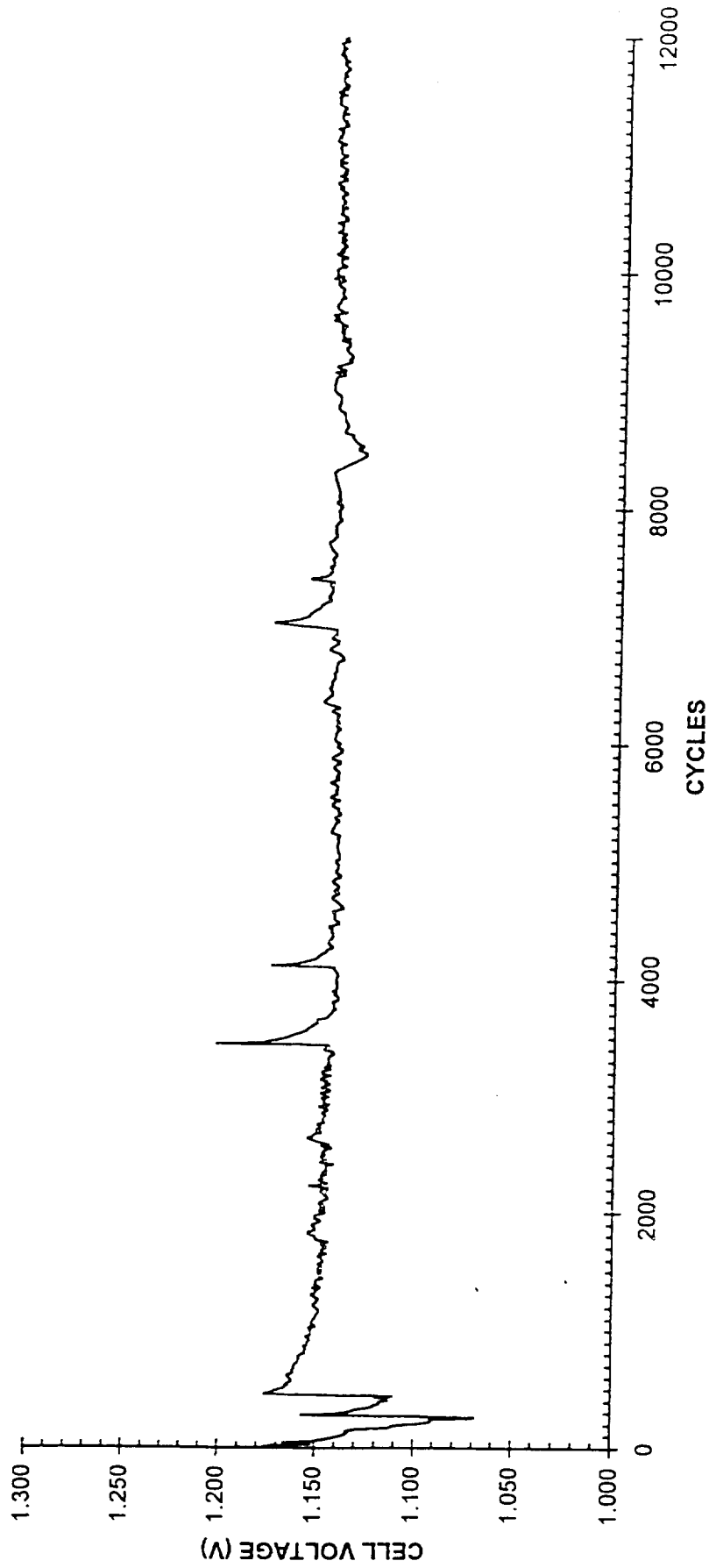

Fig 14



COMSAT LABORATORIES

End of Discharge Individual Cell Voltages

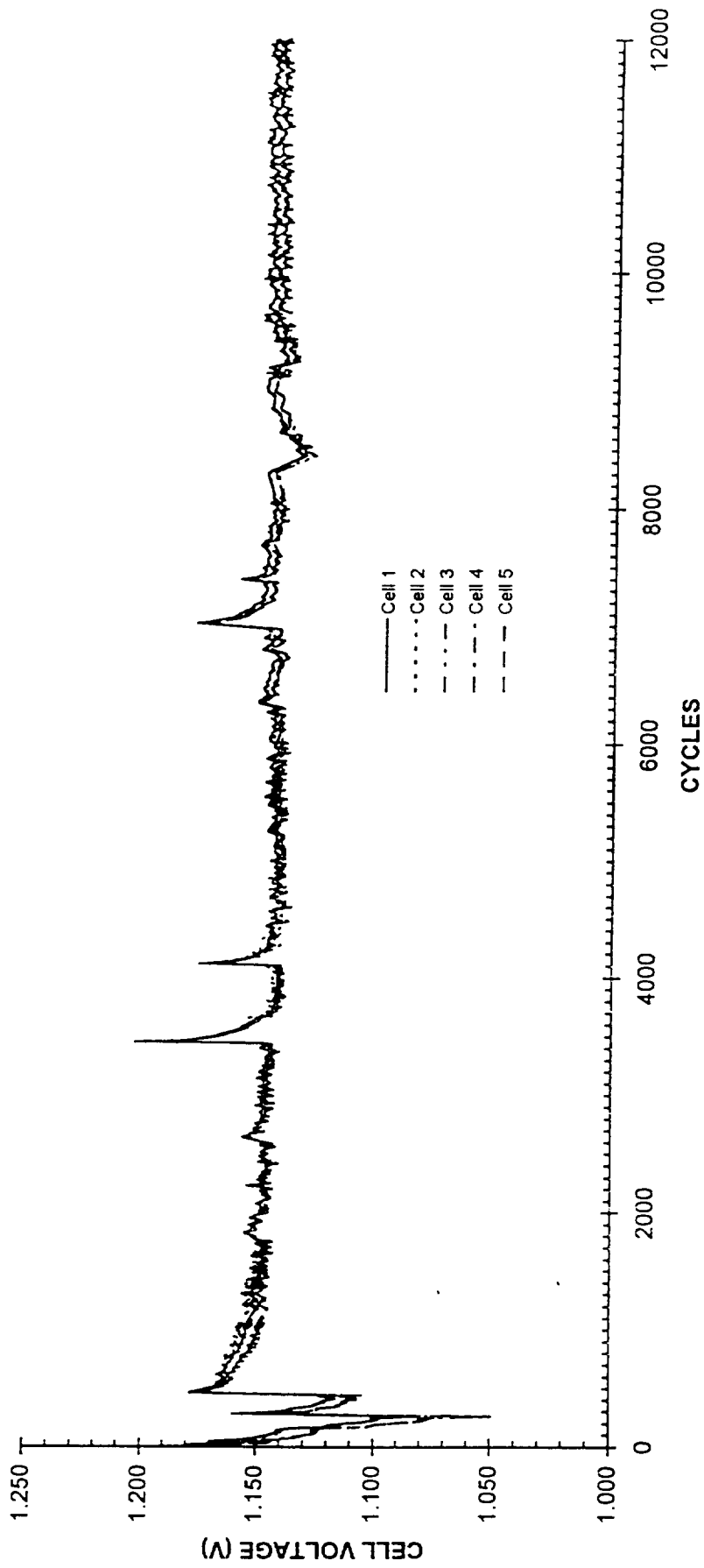

Fig 15



COMSAT LABORATORIES

End of Charge Pressure

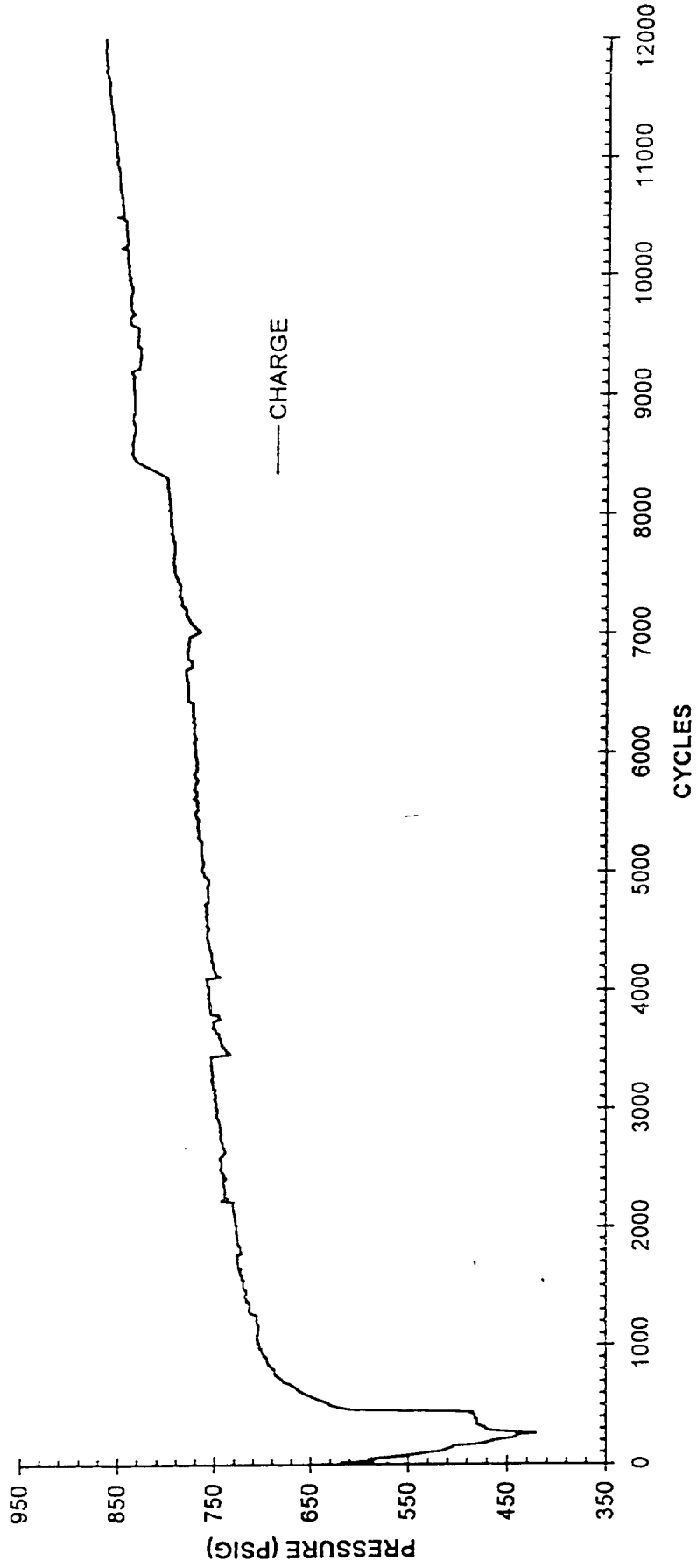

Fig 16



COMSAT LABORATORIES

End of Discharge Pressure

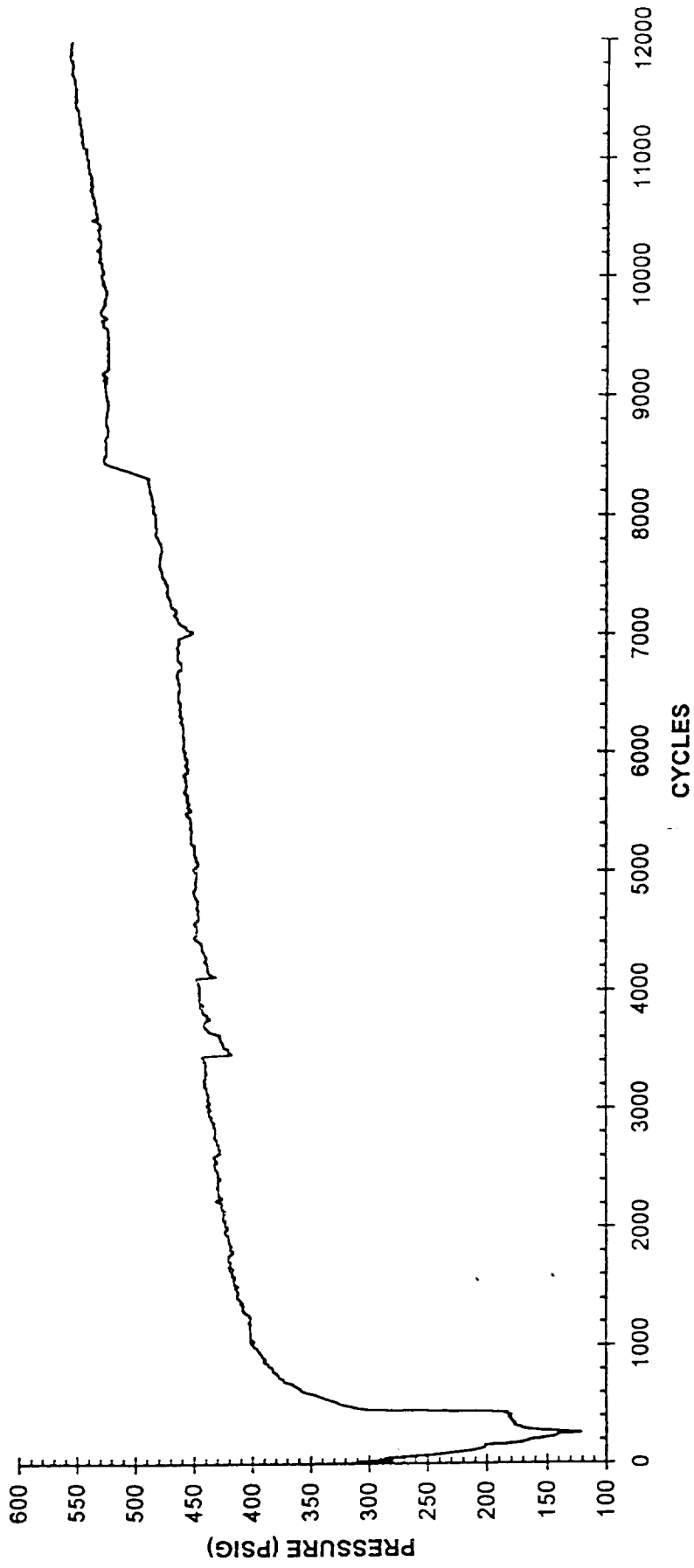

Fig 17



COMSAT LABORATORIES

End of Charge Current

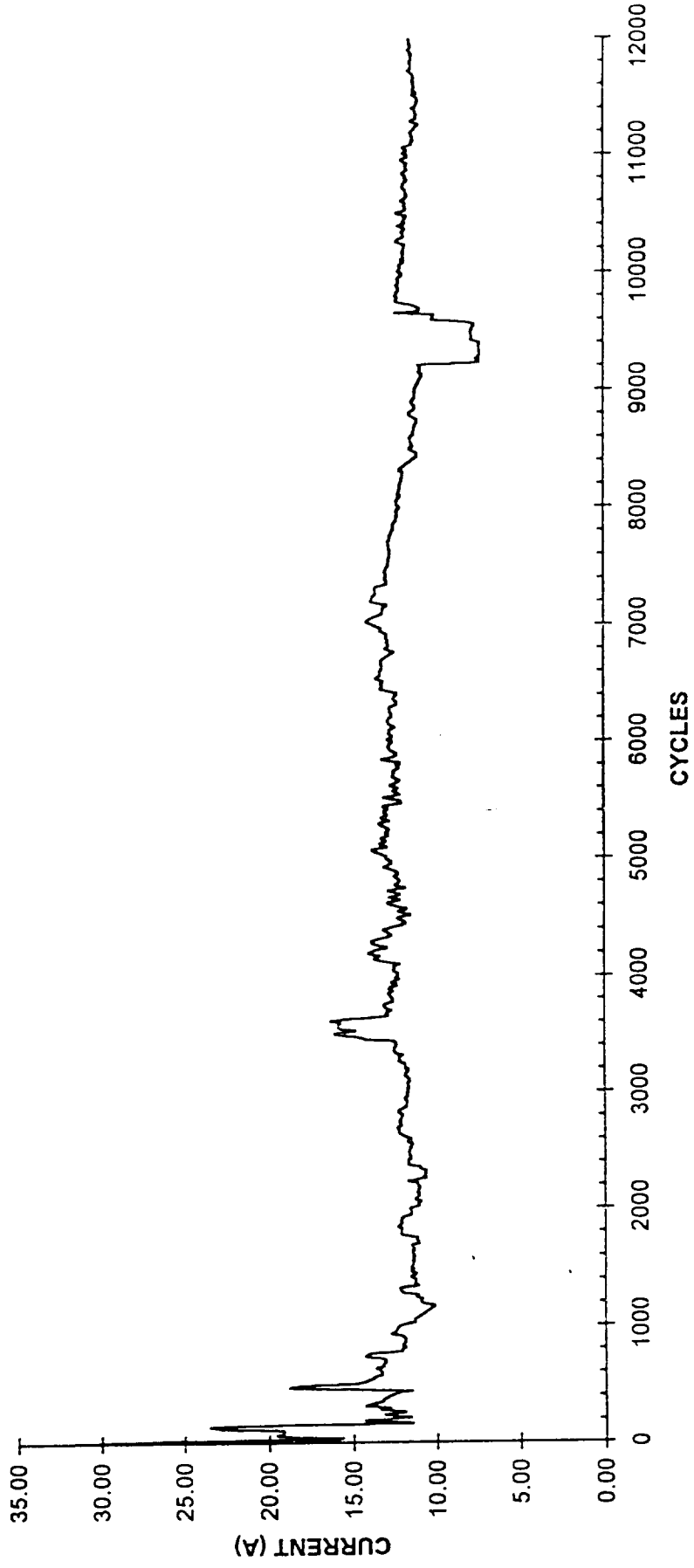
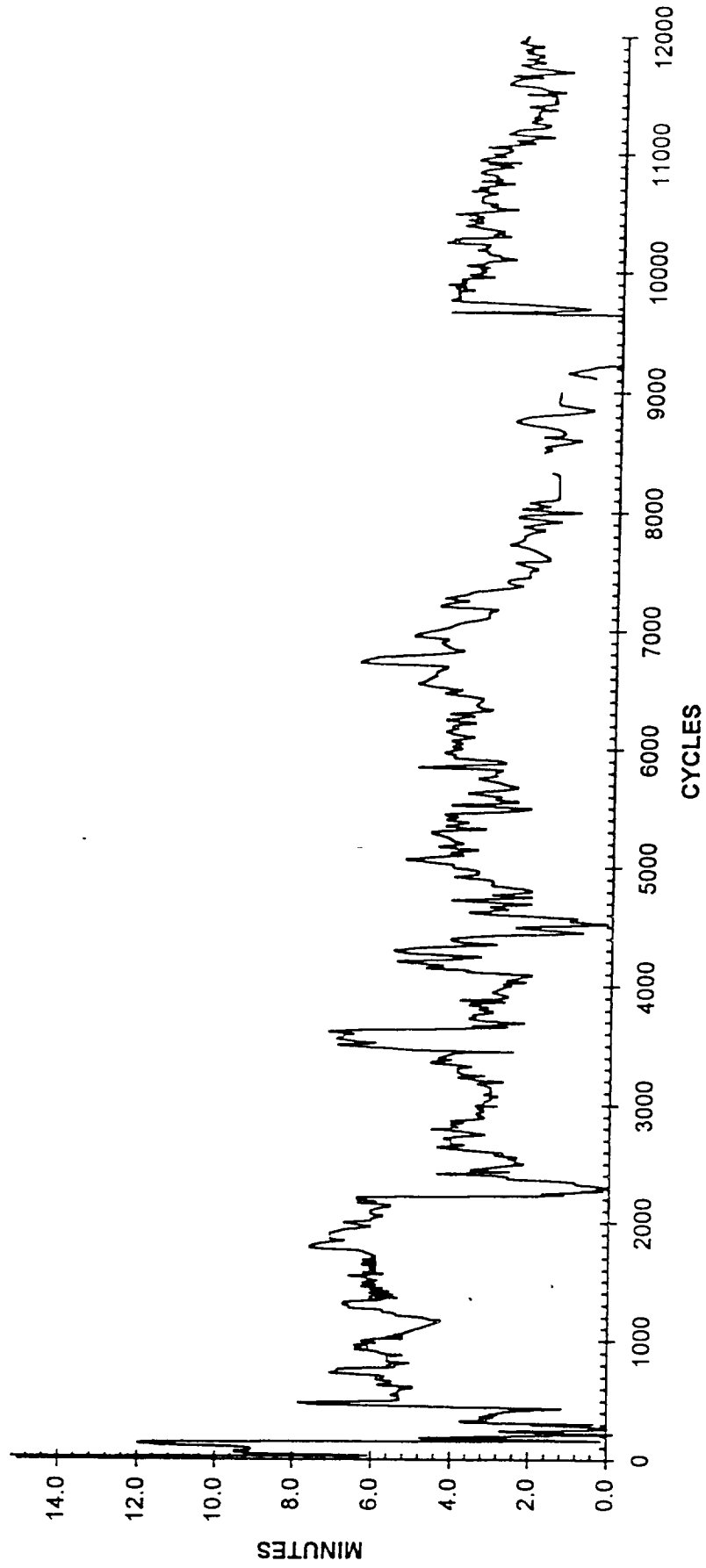

Fig 18



COMSAT LABORATORIES

Trickle Charge Period Duration





Summary and Conclusions

- **Real-time LEO life test at Lockheed Martin Missles and Space**
 - **Cells have completed 18203 cycles as of 9/1/97**
 - **End of discharge voltage decreased initially and has stabilized**
 - **Variation in end of discharge cell voltage has converged with cycling**
 - **Cell EODP and EOCP stabilized after 8000 cycles**
 - – **1.51 V/T limit and 1.06 C/D insufficient to makeup for early test problems (cells on open circuit during all test outages)**
 - **There was no full reconditioning performed during the first 18203 cycles**
- **Accelerated LEO stress test at COMSAT Labs.**
 - **Cells have completed 11998 cycles**
 - **End of discharge voltage decreased initially and has stabilized**
 - **Charge termination at 1.55 V and 1.08 C/D is appropriate for 60% DOD cycling**
 - **EOC and EOD Pressure have increased with cycling**
 - **Two reconditioning cycles performed**
 - – **Temporary voltage improvement for approximately 100 cycles**