

JOHNSON SPACE CENTER RESEARCH & TECHNOLOGY 1997 ANNUAL REPORT

NASA Technical Memorandum 104827

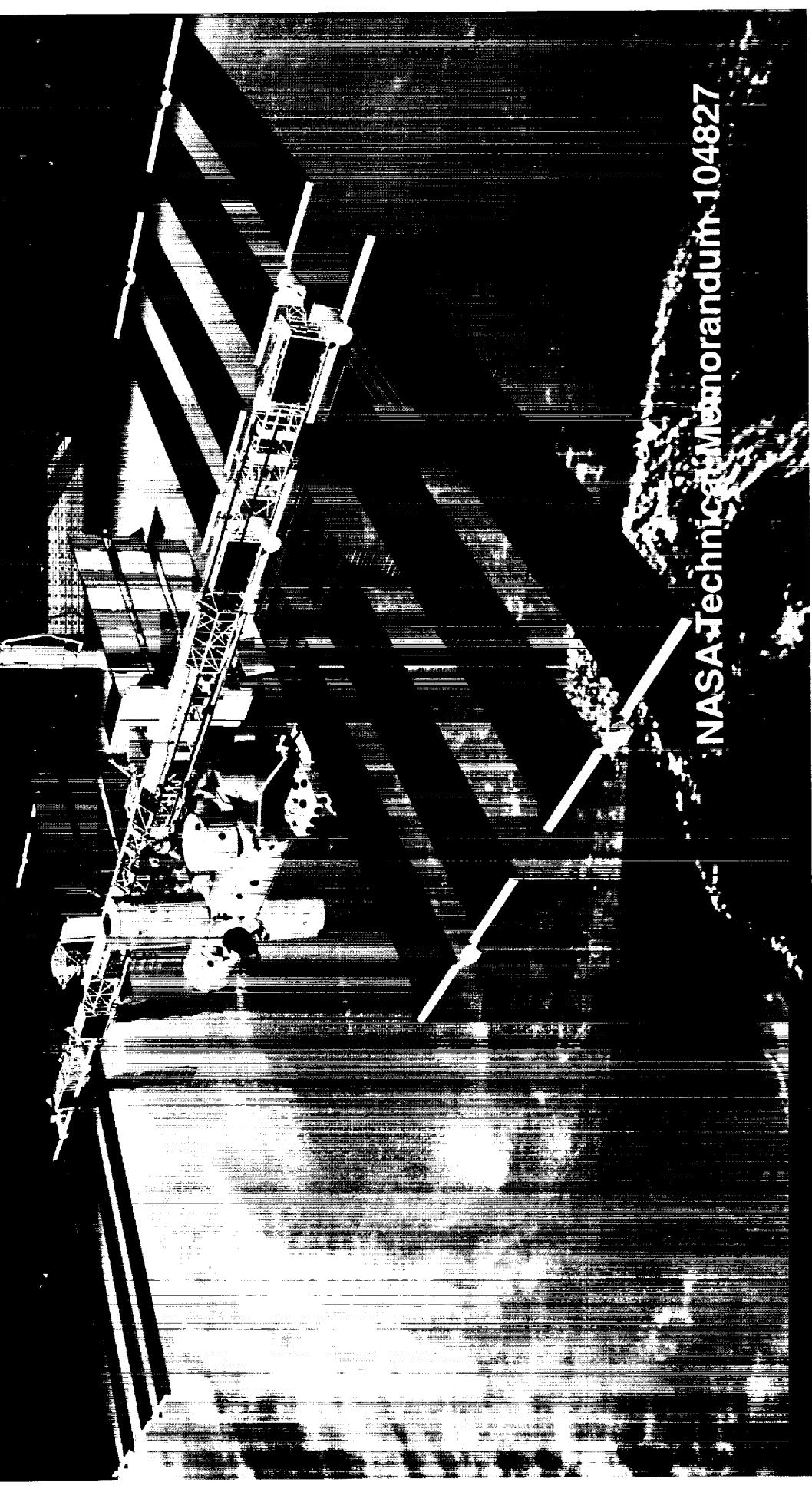



<p>REPORT DOCUMENTATION PAGE</p> <p>Form Approved OMB No. 0704-0188</p>		<p>Public reporting burden for this collection of information is estimated to average 1 hour per response, including the time for reviewing instructions, searching existing data sources, gathering and making the data needed, and completing and reviewing the collection of information. Send comments regarding this burden estimate or any other aspect of the collection of information, including suggestions for reducing this burden, to Washington Headquarters Services, Directorate for Information Operations and Reports, 1215 Jefferson Davis Highway, Suite 1204, Arlington, VA 22202-4302, and to the Office of Management and Budget, Paperwork Reduction Project (0704-0188), Washington, DC 20503.</p>	
<p>1. AGENCY USE ONLY (Leave Blank)</p>		<p>2. REPORT DATE August 1998</p>	<p>3. REPORT TYPE AND DATES COVERED Technical Memorandum</p>
<p>4. TITLE AND SUBTITLE Johnson Space Center Research & Technology 1997 Annual Report</p>			
<p>6. AUTHOR(S)</p>			
<p>7. PERFORMING ORGANIZATION NAME(S) AND ADDRESS(ES) Lyndon B. Johnson Space Center Houston, Texas 77058</p>		<p>8. REPORT NUMBERS S-830</p>	
<p>9. SPONSORING/MONITORING AGENCY NAME(S) AND ADDRESS(ES) National Aeronautics and Space Administration Washington, D.C. 20546-0001</p>		<p>10. SPONSORING/MONITORING AGENCY REPORT NUMBER TM-1998-104827</p>	
<p>11. SUPPLEMENTARY NOTES</p>			
<p>12a. DISTRIBUTION/AVAILABILITY STATEMENT Unclassified/Unlimited Available from the NASA Center for Aerospace Information (CASI)</p>		<p>12b. DISTRIBUTION CODE Subject Category: 99</p>	
<p>13. ABSTRACT (Maximum 200 words) This report highlights key projects and technologies at Johnson Space Center for 1997. The report focuses on the commercial potential of the projects and technologies and is arranged by CorpTech Major Products Groups. Emerging technologies in these major disciplines are summarized: solar system sciences, life sciences, technology transfer, computer sciences, space technology, and human support technology. These NASA advances have a range of potential commercial applications, from a school internet manager for networks to a liquid metal mirror for optical measurements. For general commercial information or commercialization information about a specific technology, contact the NASA JSC Office of Technology Transfer and Commercialization at: NASA JSC, mail code HA, 2101 NASA Rd 1, Houston, TX, 77058-3696; Tel: (281) 483-3809; Fax: (281) 244-8452; E-mail: commercialization@jsc.nasa.gov; Web page: http://technology.jsc.nasa.gov</p>			
<p>14. SUBJECT TERMS Research Projects, Research and Development, NASA Programs, Technology Utilization, Space Technology Experiments</p>			
<p>15. NUMBER OF PAGES 93</p>		<p>16. PRICE CODE Unlimited</p>	
<p>17. SECURITY CLASSIFICATION OF REPORT Unclassified</p>		<p>18. SECURITY CLASSIFICATION OF THIS PAGE Unclassified</p>	
<p>19. SECURITY CLASSIFICATION OF ABSTRACT Unclassified</p>		<p>20. LIMITATION OF ABSTRACT Unlimited</p>	

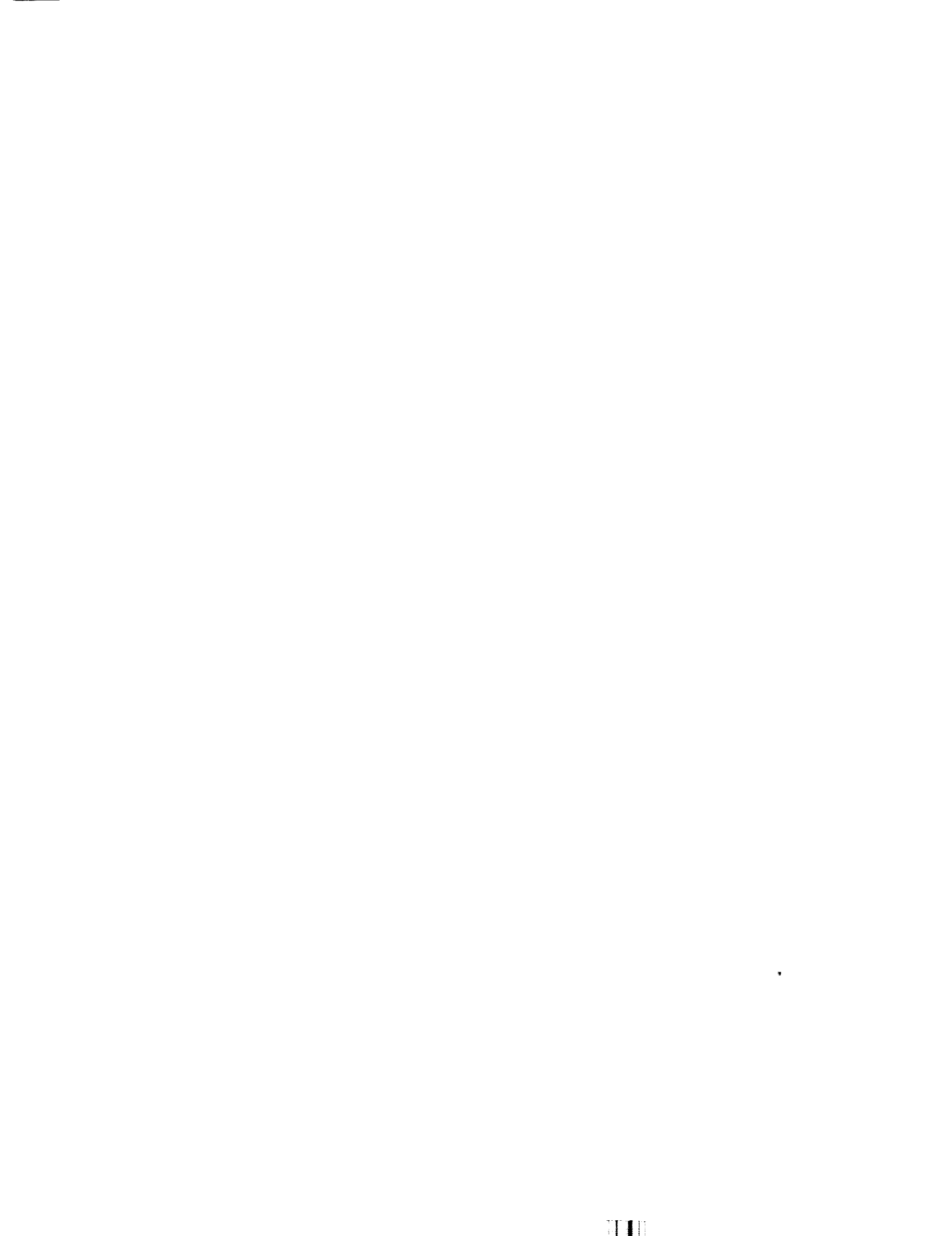

Johnson Space Center

NASA Technical Memorandum 104827

Johnson Space Center
Research and
Technology

Annual Report 1997



Foreword

The 1997 NASA Johnson Space Center Research and Technology report highlights key projects and technologies at Johnson Space Center throughout 1997. This year, special attention is given to the commercial potential of these projects and technologies. With that in mind, this report is arranged by CorpTech® Major Product Groups.

For additional technical information on a particular project, contact the technical point of contact listed at the bottom of each page. For general commercialization information or commercialization information about a specific technology, contact the NASA-JSC Office of Technology Transfer and Commercialization at: NASA/JSC, Mail Code HA, 2101 NASA Rd 1, Houston, TX 77058-3696. Tel: (281) 483-3809, Fax: (281) 244-8452, E-mail: commercialization@jsc.nasa.gov, Web page: <http://technology.jsc.nasa.gov>.



Contents

Foreword	iii
Automation	
Automated Control Center Demonstration Project (ACCDP)	3
Improved Human Productivity in Advanced Life Support	5
Robonaut	7
RMS Assistant Project	9
Chemicals	
Zeoponic Plant Growth Media Research and Development	11
Computer Hardware	
Field Deployable Trainer	13
Computer Software	
A Computational Fluid Dynamics/Direct Simulation Monte Carlo Analysis	15
Advanced Training Technologies	17
Cooperating Expert System (CoopES)	19
Electronic Documentation Project (EDP)	21
Extravehicular Activity (EVA) Display Assembly	23
Human Interaction Design for Cooperating Automation and Anomaly Response Systems	25
High Volume Data Management (HVDM)	27
Information-Sharing Protocol (ISP) Technology	29
Intelligent Computer-Aided Training Tool Development	31
Intelligent Flight Activity Planner (IFAP)	33
Internet Library Information Access Device	35
School Internet Manager Over Networks	37
Effects of Lighting on Human Performance in Training	39
SINDA/FLUJINT Version 3.2	41
Space Operations Intelligent Computer Aided Training (ICAT)	43
Simulation Virtual Machine (SVM)	45
Thermal Synthesizer System, Version 6.0	47
Shared Virtual Environments for Team Training	49
Visual Proximity Operations Processor (VPOP)	51

Energy	
Electrohydrodynamic Heat Pipe Loop Studies	53
Electrolysis Performance Improvement Concept Study (EPICS) Flight Experiment	55
New Lithium-BCX D Cell Development for Flight Applications	57
Solar Heat Pump Development	59
Environmental	
Advanced Technology Space Suit	61
Lunar-Mars Life Support Test Project	63
Medical	
Multi-Channel BioLog With FETRODES	65
Telecommunications	
Autonomous Extravehicular Robotic Camera (AERCam) II Integrated Ground Demonstration	67
Autonomous Extravehicular Robotic Camera (AERCam) Sprint	69
Globally Interconnected Advanced Network Telepresence (GIANT)	71
Test and Measurement	
Flammability Testing of Composites Using Cone Calorimetry	73
Fluid Flow Measurements Using Series Probes	75
Fluid Flow Volume Measurements	77
Instrumented Mechanical Impact Test (IMIT) Facility	79
Liquid Metal Mirror for Optical Measurements of Orbital Debris	81
Regolith Evolved Gas Analyzer (REGA)	83
Camera Images From Luminance Maps	85
Transportation	
Variable Specific Impulse Magnetoplasma Propulsion	87
X-38 Project	89

ACCDP/GNC Operations Assistant System Architecture

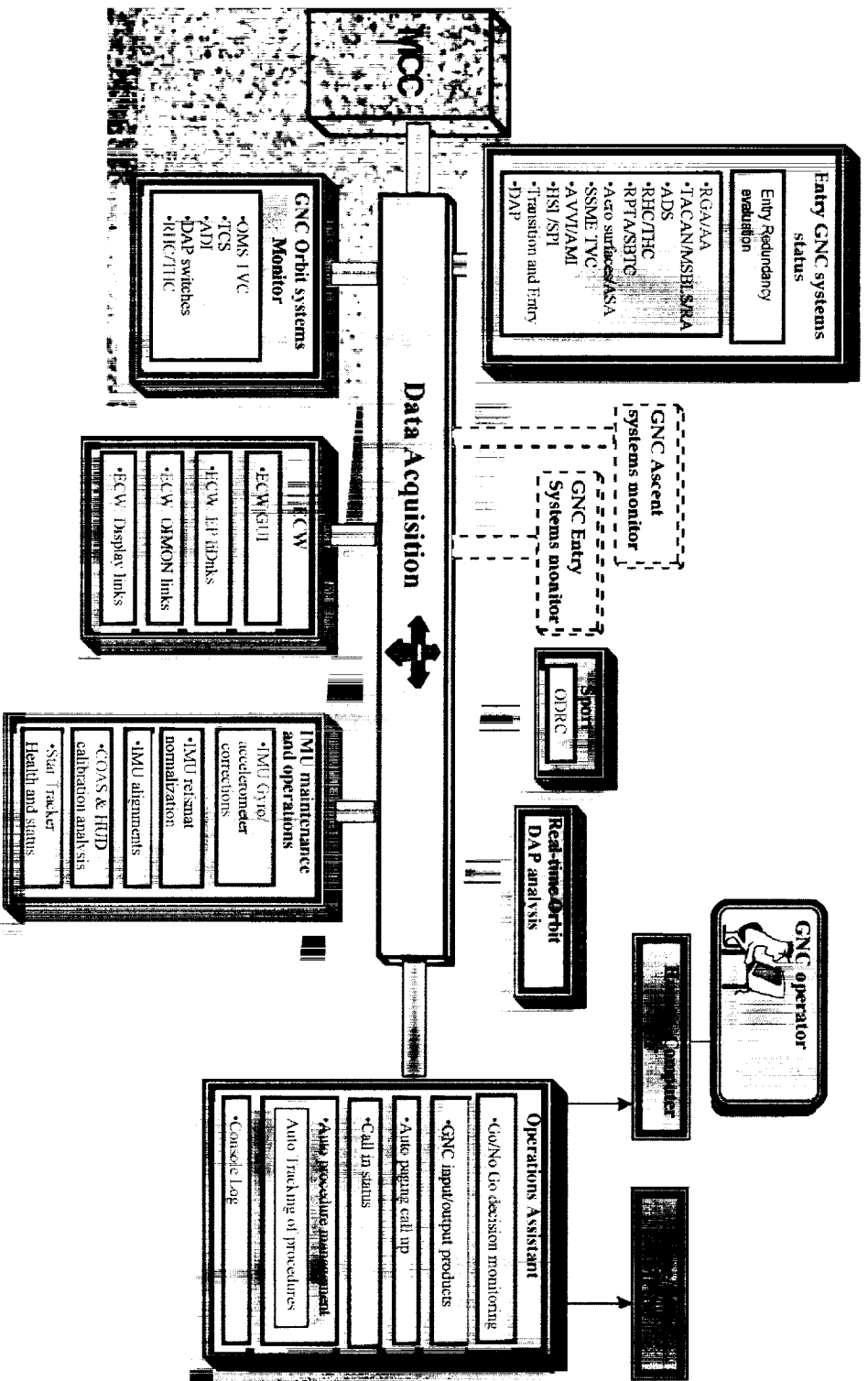

Automation of the GN&C Flight Control Task

Automated Control Center Demonstration Project (ACCDP)

Benefit

The ACCDP is demonstrating the feasibility of control center automation in support of human space flight. Automation of Mission Control Center (MCC) flight control tasks will result in decreased cost and improved employee utilization and will enable an office/home multipurpose support room (MPSR) allowing consolidation/reduction of flight control room (FCR) positions. It is anticipated that implementation of operations automation for International Space Station will result in even higher savings. The first task undertaken by the project is automation of the guidance, navigation and control (GNC) flight control task (GNC Operations Assistant).

The GNC Operations Assistant will operate as an intelligent operations assistant for the GNC flight control position. The GNC Operations Assistant will interact as a flight control team member with the goal of automating GNC tasks to the highest degree that is reasonable. The GNC Operations Assistant will manage applications and data analysis, make recommendations to on-console flight controllers, and prepare and maintain required routine documentation.

Accomplishment

Completed task analysis of selected Shuttle flight control positions, GNC selected as first position to prototype since it provides a challenge and is typical of other FCR positions. The GNC Operations Assistant is being developed for release in early calendar year 1998. Identified key technologies critical for MCC automation development and have established interfaces with key research and development institutions technology infusion support.

Background

ACCDP is a new project started in fiscal year 1997 to test new and commercial technology for infusion into the MCC, to demonstrate new smart displays and intelligent system monitoring, to provide a baseline to build a life cycle cost and schedule assessment for full-scale deployment, and to prototype new operations concepts and flight control team organizational structures. Current focus is on a GNC Operations Assistant and Office/Home MPSR.

For further technical information, contact Mitchell Macha at (281) 483-7059 or mitchell.g.macha1@jsc.nasa.gov

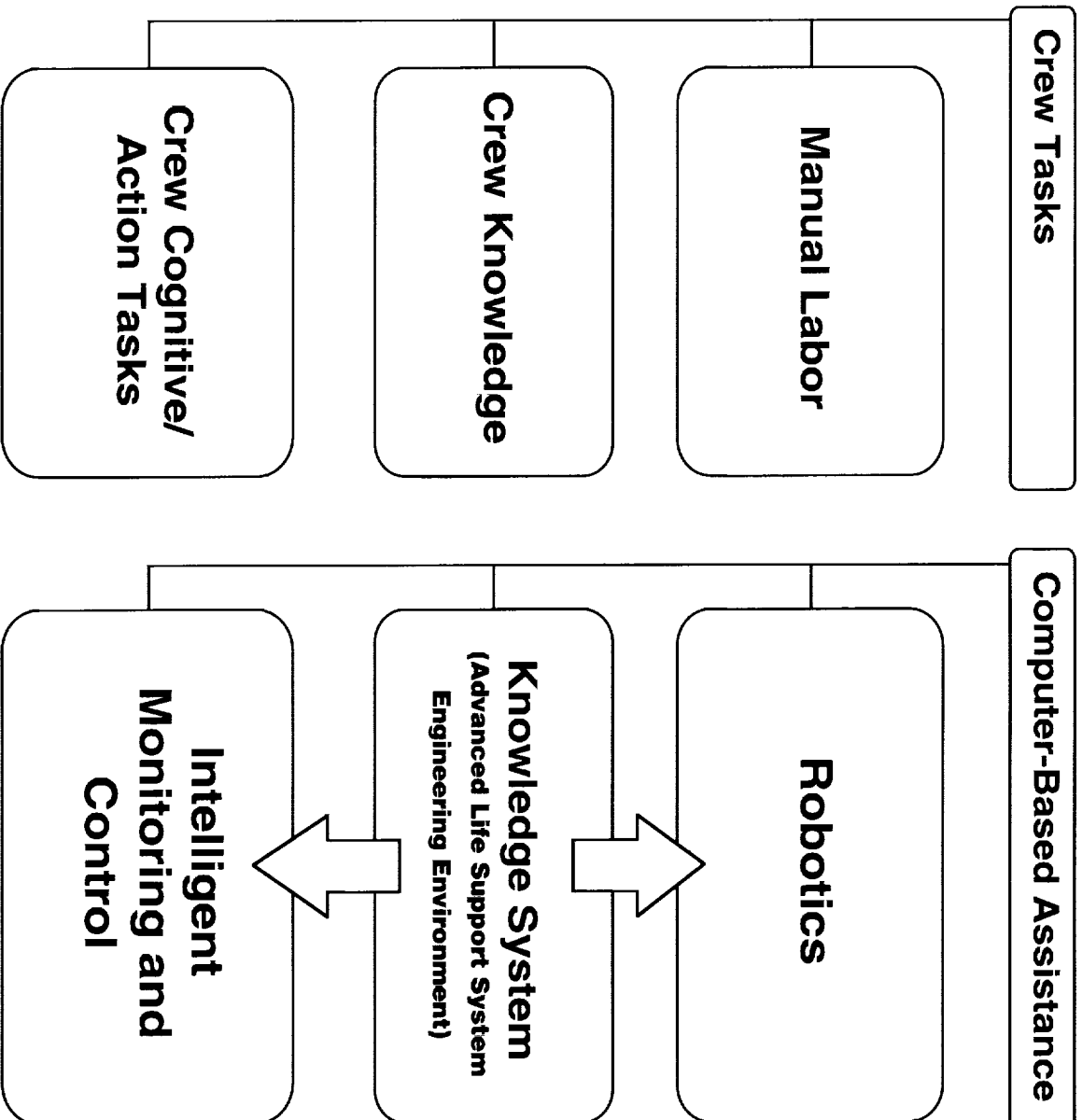

Improved Human Productivity in Advanced Life Support Systems Through Use of Sensors, Computers, and Actuators

Improved Human Productivity in Advanced Life Support

Benefit

By eliminating the need for crew and test engineer/ground personnel to monitor and control life support systems or perform manual labor during nominal operations, and by minimizing crew and test engineer/ground personnel interaction for off-nominal operations of selected subsystems/automation in response to anomalies, crew time is freed for science and engineering/technology objectives on human space exploration missions beyond Earth orbit, operations costs are greatly reduced, crew safety is improved, and human productivity is greatly increased.

Accomplishment

The Automation, Robotics, and Simulation Division performed a successful demonstration of reduction of crew time or test engineer/operator time to near zero for operations of two regenerative life support systems through implementation and test during the Lunar-Mars Life Support Test Project of crew-adjustable autonomous intelligent monitoring and control for:

- Product Gas Transfer—Transferring oxygen generated by crop growth in one test chamber to another where four human test subjects were using the oxygen in their activities and generating carbon dioxide for transfer to the crop growth chamber.
- Variable Pressure Growth Chamber Monitoring Robot—Making measurements at multiple locations in the crop growth chamber of light for photosynthesis, air temperature, humidity, air speed, leaf temperature, in addition to recording video camera views of the health of the crop.

The success of these regenerative life support systems applications of autonomous monitoring and control is a stepping stone to full-scale deployment of autonomous monitoring and control in the upcoming, high-fidelity NASA Bioregenerative Planetary Life Support Systems Test Complex (BIO-Plex), which involves human tests for periods up to 425 days.

Background

Long-duration human exploration space missions require regenerative life support systems that are nearly self-sustaining. The NASA Advanced Life Support Program addresses this need. Activities in this program include the Lunar-Mars Life Support Test Project and the BIO-Plex design and implementation. The Crew and Thermal Systems Division is the NASA Advanced Life Support Program Lead Center Program Office. JSC's three-tiered intelligent systems architecture provides a generic approach to achieving flexible autonomy of computer-controlled machines, giving humans supervision by exception through shared and traded control, supported by situation awareness information.

For further technical information, contact Cliff Farmer at (281) 483-9529.

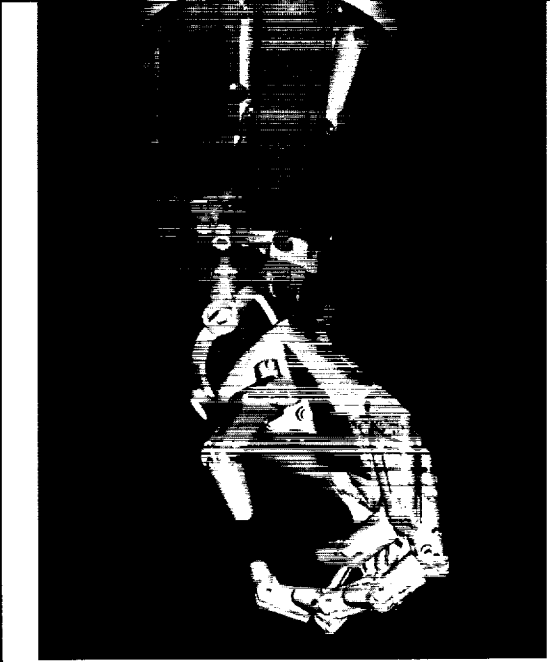
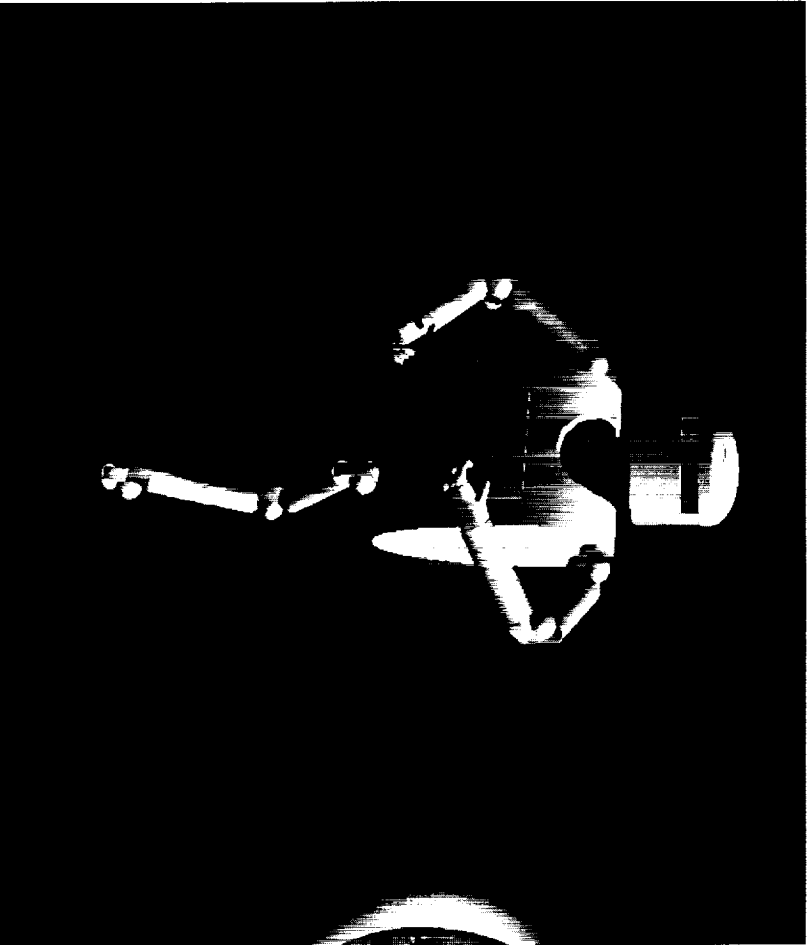

Robonautics

For further technical information, contact Karl Zimmer at (281) 483-1718 or karl.j.zimmer1@jsc.nasa.gov

Robonaut

Benefit

The technology which can replicate the human's dexterity and perception capabilities is very immature at this time. The "dexterous" robots which exist today on earth or are slated for on-orbit use in the near future (i.e., the International Space Station, or ISS) require a large amount of accommodation (special targets, special structural interfaces, etc.) from their host system and thus can only be used to replace the human at the worksite for a limited set of specially designed tasks. They are also too large to fit through tight extravehicular activity (EVA) access corridors and do not possess adequate speed and dexterity to handle small and complex items, or soft and flexible materials, or even common EVA interfaces. Furthermore, the teleoperator controls for these robots, which consist of flat panel displays and joystick-like hand controllers, are grossly inadequate for coordinating the high level of dexterity inherent in complex EVA tasks.

The Robonaut project selected a dexterous robotic hand, as the sole interface tool, over multiple limited-use tools. Robotic hand advantages over multiple changeout tools include reduced weight, volume, and—since tool changeout is not needed—reduced task timelines. Additionally, the robotic hand concept can be adapted to new and unplanned interfaces without requiring development of a new tool. The robotic arms are sized to fit through tight EVA corridors and have the strength and dexterity of an EVA astronaut. The telepresence system provides an easily learned interface that allows intuitive control of all degrees of freedom.

Accomplishment

The Robonaut Project team has developed a design concept which calls for two 7-degrees-of-freedom (DOF) arms, two 12-DOF multifingered robotic hands, and a 3+ DOF stereo camera platform. The dexterous hand module has a 12-DOF dexterous hand and 2-DOF wrist. With four fingers and a thumb in a human hand-like arrangement, it will emulate, as a minimum, a suited crew member's reach and dexterity, as according to NASA STD-3000, JSC-26626, "EVA Hardware Generic Design Requirements Document"; and SSP-4162, "U.S. On-Orbit Segment Specification." The robotic hands are designed to handle common EVA tools, such as an ORU handling tool (a.k.a. "ice cream scoop"), to grasp irregularly shaped objects, and to handle a wide spectrum of tasks requiring human-like dexterity. The first prototype of this design is nearing completion and will be tested later this year. The design of the 7-DOF arms provides the size, strength, and range of motion of an EVA astronaut. The 7-DOF arm design, a 5-DOF segment + a 2-DOF wrist, is undergoing detailed joint design, and bench testing will be completed this year. The complete arm fabrication, assembly, and testing is scheduled for next year.

The Robonaut will be initially operated using telepresence equipment, such as a head-mounted display, body-mounted position sensors, position-sensing gloves, or force-reflective arm and hand masters. Future developments call for embedding subconscious or reflexive behaviors to free up operators from the lowest levels of control. Robonaut I (FY97-98) is developing an integrated dexterous arm-hand module evaluated against a set of one-handed EVA tasks. Tasks performed will be beyond capabilities of current space-based dexterous robots and will not require the use of specialized robotic interfaces. The evaluation includes the following tasks: manipulate EVA tether hooks, install and remove portable foot restraints, pull Velcro tabs to remove multilayer insulation, mate and demate electrical connectors, and grasp and actuate ORU handling tools. The performance metric will be to complete these tasks in less than twice the time it would take an EVA-suited astronaut.

Background

ISS will rely significantly on robotics for external maintenance. The tasks have been specifically designed with interfaces compatible to existing robotic systems interface standards (RSIS Vol. II). However, there still exists a significant workload for EVA astronauts that is not compatible with the existing robotic systems on ISS. The Automation, Robotics, and Simulation Division at JSC has previously developed the laboratory-based dexterous anthropomorphic robotic test bed (DART) and the full immersion telepresence test bed (FITT). The DART/FITT system proved capable of performing operations with EVA hardware not designed for robotic interface. Further, two-handed operations with flexible materials, such as tying a knot in a rope, have been performed with increasing simplicity over time. By identifying the need for more capable robots and human interface, and combining it with previous experience with DART/FITT, the Robonaut concept has been developed.

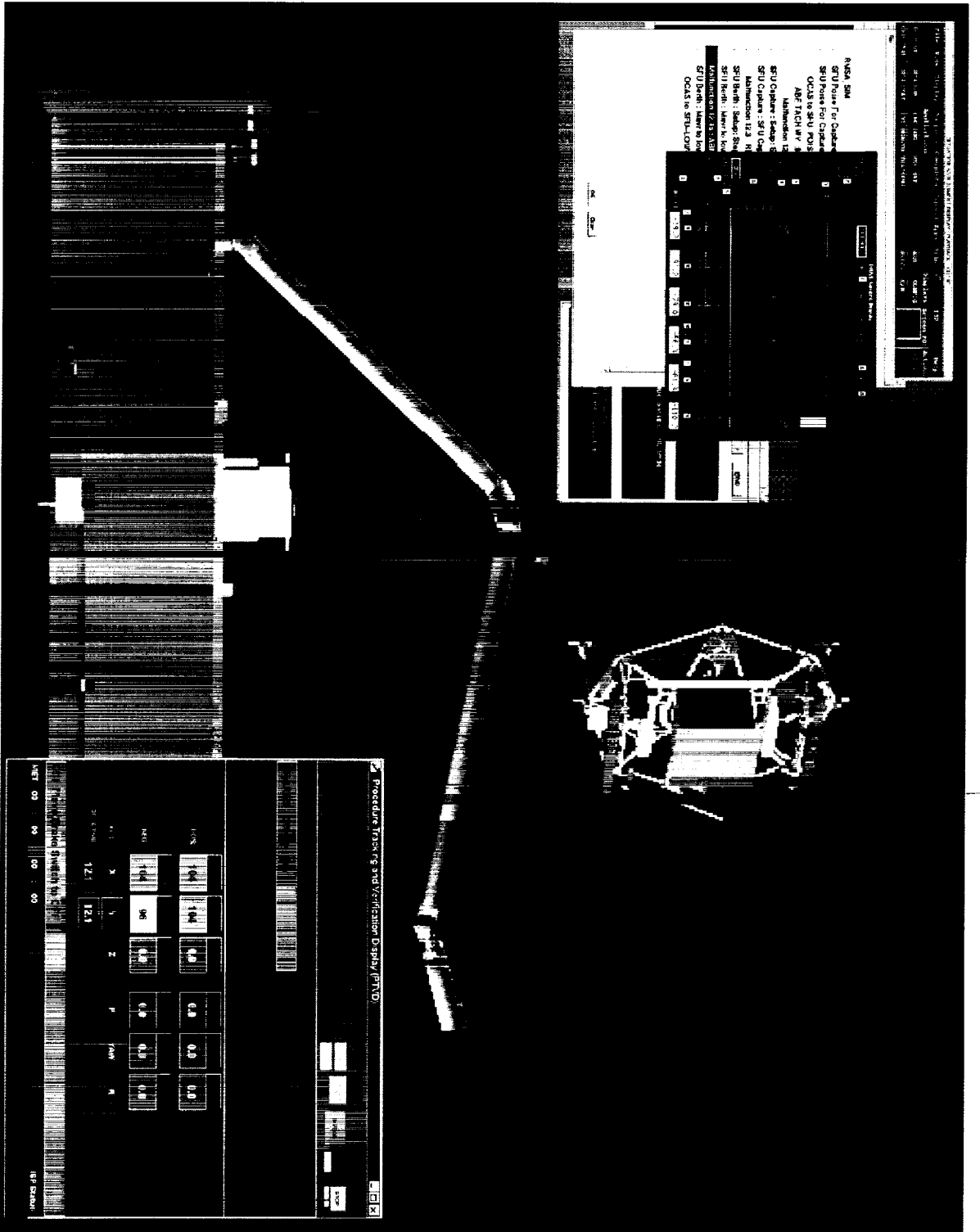

RMS Project

RMS Assistant Project

Benefit

The Remote Manipulator System (RMS) Assistant is a forerunner project to prove technical feasibility and cost-effectiveness of reducing the workload of the crew and flight controllers through automation. This project focused on the development of an intelligent software approach to monitor/advise real-time crew operations, to provide various levels of automation, and to provide automated tools for the flight controller to collect, retrieve, and analyze mission data. In addition, a reusable automation architecture was developed to support not only the RMS operations but also other Orbiter subsystems.

Accomplishment

The RMS Assistant project has successfully demonstrated three objectives: develop a reusable automation architecture, ease crew operation, and enhance flight controller tools. The system will not only improve situational awareness and assist the crew, but will also provide flight controllers with automated tools to improve flight operations efficiency. Examples of these enhanced capabilities for both the flight controllers and the crew include “smart” malfunctions, procedure tracking and verification, and automated situation assessment.

The system was designed so that the above-mentioned functions are seamlessly integrated in a distributed processing architecture. The system health monitoring module automatically detects and recommends a malfunction procedure block based on the current procedure context and assigns a priority tag and sends it to the procedure tracking and verification (PTV) module. The PTV module switches from the current procedure, and starts to monitor and verify the highest priority malfunction. In parallel, there is an intelligent situation capture module that collects and stores information relevant to the ongoing activity. The situation objects not only capture and assemble the data in a chronological matter, but also organize the data into a hierarchical relational network such that the information can easily be accessed and retrieved for near-real-time analysis. This architecture was also designed to support various degrees of automation: If computer command and control capabilities are accessible and permissible, the user will be able to select fully or partially autonomous modes of operations. Otherwise, the system operates in manual modes where the intelligent software assists (monitors/advises) the crew in performance of tasks.

Background

There is great emphasis on upgrading the Space Shuttle Orbiter to reduce costs and prolong its use beyond the year 2012. The RMS Assistant project was intended to provide a proof of concept of an automation approach not only for RMS operations but also for other Orbiter subsystem operations. This type of automated support capability would significantly improve safety by providing the crew with additional insight information and cut the costs of operating the Orbiter by reducing ground control operation involvement during routine operations.

For further technical information, contact Lui Wang at (281) 483-8074 or lui.wang1@jsc.nasa.gov

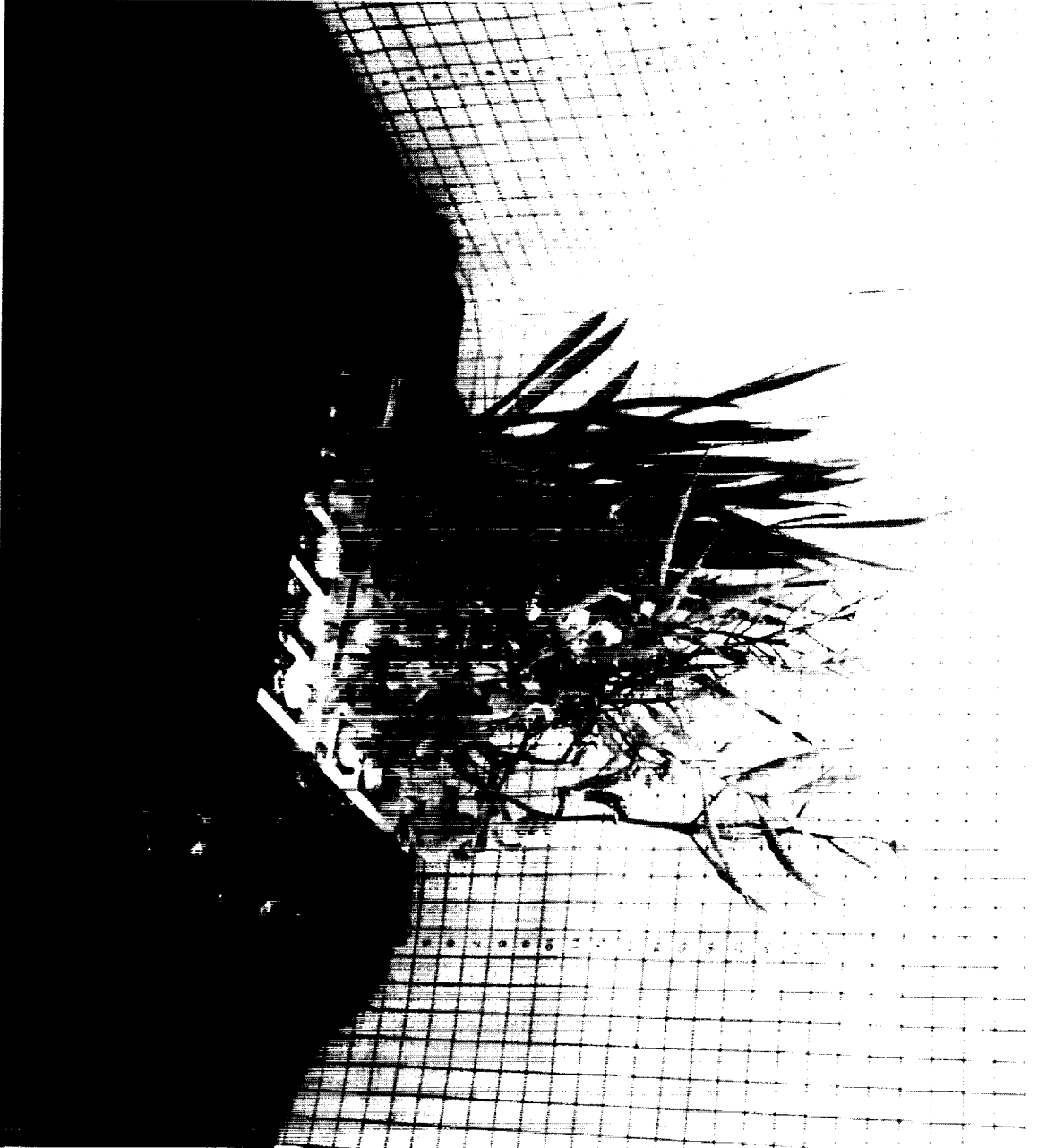

Examples of Plants Grown Through Zeoponics Research

Zeoponic Plant Growth Media Research and Development

Benefit

Long-duration space missions will require life support systems that are capable of providing air, water, and food to human crews over long periods. A large component of such systems will be plants. Plants will not only be a source of food, but will also play a major role in air revitalization and water recovery. NASA scientists are developing substrates as a highly productive, simple plant growth medium capable of growing selected food crops for use in a regenerative life support system. These substrates, called zeoponics, have demonstrated excellent potential for growing plants in space-based life support systems.

Accomplishment

Zeoponic substrates are being developed to support plant growth for advanced life support systems in ground-based test beds and for flight experiments on both the Space Shuttle and the International Space Station. Zeoponics materials have been used to grow wheat with comparable production of wheat grown in an inert matrix with nutrient solution applications. The first Space Shuttle flight (STS-60) experiments with zeoponics verified its mechanical properties for air and water movement. In a second Space Shuttle (STS-63) flight experiment, wheat and brassica plants were grown in microgravity for eight days. During the flight the wheat grew about 12 cm in height and the brassica plants, which were planted prior to launch, continued to develop flowers and set seeds.

Zeoponics media are being developed and tested for use in the International Space Station Plant Research Unit. Two patents were granted, and NASA has negotiated with two companies for co-exclusive licensing rights. Additionally, researchers at Johnson Space Center worked with the Tennessee Valley Authority's Natural Fertilizer Development Center and the International Fertilizer Development Center to develop methods to pelletize and granularize the synthetic apatite to improve its dissolution characteristics.

A laboratory-scale pilot plant was developed to increase Johnson Space Center's capability to produce zeoponics media for flight and ground-based testing and commercialization requirements. The rate of production of synthetic apatite was increased a hundredfold; the rate of production of saturated zeolite was increased tenfold.

Experiments conducted on the zeoponic substrates included verification of nutrient loads on the matrix as well as plant growth experiments to evaluate performance. Experiments were completed that evaluated plant growth in second-generation (second major reformulation) and third-generation zeoponic media using agronutrient-substituted hydroxylapatites. Additional experiments have been initiated to examine the moisture status of zeoponics media in terms of supplying water and nutrients to plants.

Background

Zeoponic substrates are made up of a combination of zeolite minerals and a synthetic calcium phosphate mineral (synthetic apatite). Zeolites are crystalline, hydrated minerals that contain loosely bound ions within their crystal structures. Synthetic apatite has several essential plant growth nutrients incorporated into its structure. Zeoponics have been designed to slowly release these plant growth nutrients into "soil" solution where they become available for plant uptake. Ion composition and pH are thus passively controlled by the chemistry of the medium. The zeoponic substrate system requires only water, which can be applied by a static watering system that uses the natural matrix suction of the medium as the driving force for water flow.

For further technical information, contact Don Henninger at (281) 483-5034 or donald.l.henninger1@jsc.nasa.gov



Crew On-Orbit Support System Being Used on *Mir*

Field Deployable Trainer

Benefit

Cost effective: In many instances, instructorless training can be cheaper than instructor-led exercises.

Better: Instructorless training can be much more effective, since it is self-paced and available 24 hours per day. Repeated return to the material for review has no additional cost. Instructorless training can ensure consistency in the presented material across the entire student population.

Training material delivery: The costs for delivery of computer-based training lessons on CD-ROMs, when mass produced, are significantly less than even a black & white training manual, as little as \$1 per article.

Accomplishment

To date, 3 customized deliveries of an integrated software package including CD-ROMs have been provided and flown on 3 separate NASA/*Mir* missions. In excess of 20 computer-based training lessons have been developed, and multiple custom software tools have been developed. Support for the remaining NASA/*Mir* missions has been initiated, and new areas of development are in work.

Background

The first prototype field deployable trainer, the Crew On-Orbit Support System (COSS), is an operational system currently in use on board the Russian Space Station *Mir* in support of the American astronaut. The COSS provides psychological support, real-time support tools, and onboard refresher & proficiency maintenance training. All integration & development of the products are done at much lower cost than previous flight software and training products. By providing *in situ* instructorless training, mission success is enhanced. Cost-effectiveness is achieved by using commercial-off-the-shelf software and hardware products for product development.

For further technical information, contact Sean Kelly at (281) 244-7484 or sean.m.kelly1@jsc.nasa.gov

CFD Predicted Number Density Contours Axisymmetric PRCs plume

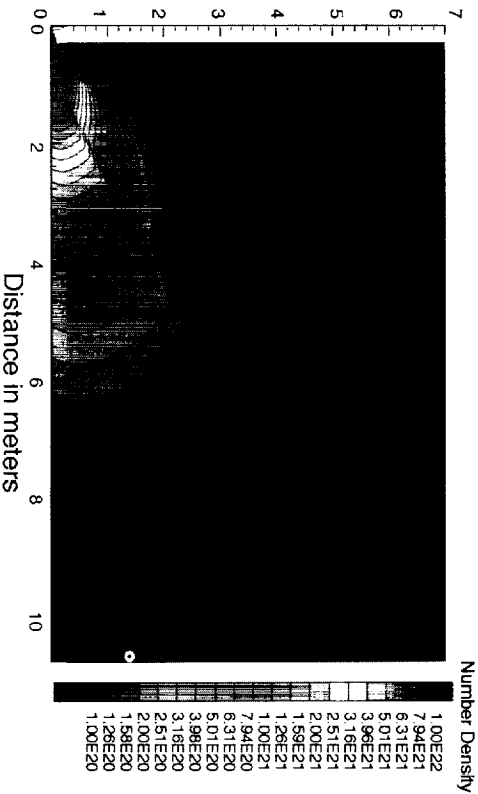

DSCM prediction of Number Density - Inner Domain

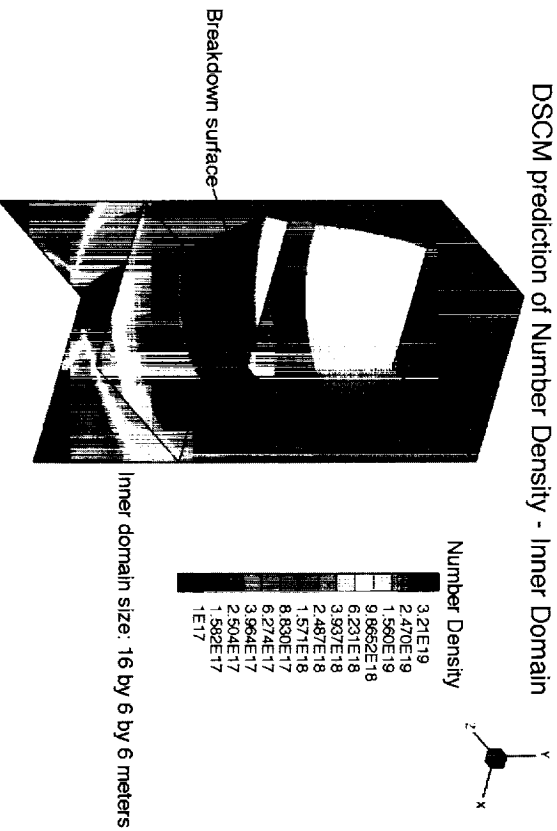

CFD-Predicted Number Density Contours for Axisymmetric PRCs Plume

DSMC-Predicted Number Density Contours for Axisymmetric PRCs Plume

A Computational Fluid Dynamics/Direct Simulation Monte Carlo Analysis

Benefit

An accurate understanding of plumes and plume impingement during Orbiter docking is critical to the success of the Shuttle/*Mir* missions and the International Space Station (ISS). The three-dimensional flow fields generated during these types of missions will be complex, spanning flow conditions from continuum to rarefied. The computational fluid dynamics/direct simulation Monte Carlo (CFD/DSMC) capability represents an important tool for engineering analysis for these missions. Ambitious application of these techniques fostered the development of an enhanced capability as well as a base of extremely intensive computations.

Accomplishment

High-fidelity numerical analyses of plume and plume impingement flow fields are performed to support the design of Shuttle Orbiter docking approaches to the *Mir* and ISS. These analyses will help to avoid placing adversely high loads on fragile ISS components such as solar panels and radiators. Another advantage of these analyses is that their complexity pushes the limits of applicability of the employed methodologies and drives the development of enhancements such as implementation on massively parallel super computers. The development of a highly accurate tool for benchmarking the pressure and heating loads on solar panels and radiators produced from Orbiter primary reaction control system engine firings is complete, and efforts are under way to adapt the tool to other applications such as human missions to Mars.

Background

While plume impingement problems are certainly not new to spacecraft operations, the Shuttle/*Mir* missions represent extremely ambitious docking maneuvers. This results from the high thrust (870 lbs) of the engines, the large masses of both the Orbiter and the *Mir*, the large surface area of *Mir*'s solar panels, the requirement for primary reaction control system firings when the two spacecraft are at close range, and the complex three-dimensional nature of the plume flow fields generated by nozzle scarring and dual jet firings. Because these dockings are inherently complex, scientists need to understand on-orbit plumes and the resulting plume impingement forces and heat loads to a degree never before required.

Because of the large changes in flow field densities, the basic physics of the problem changes from one area of the flow field to another. This fact greatly increases the difficulty of the analysis and must be accounted for in the analysis procedure. In addition, the procedure must account for the challenges presented by the complex geometries encountered as well as the inherent three-dimensional nature of the flow.

High-fidelity analysis of gas flows is generally done by numerically solving a set of governing equations subject to boundary constraints. For most analyses, referred to as computational fluid dynamics, the Navier-Stokes equations are employed as the governing equation set. However, Navier-Stokes equations are valid for continuum flows but not for rarefied gas flows where the fundamental physics differs. For these, the Monte Carlo method has proven to be the most versatile, accurate, and efficient method for high-fidelity flow analysis. This method differs from computational fluid dynamics because it simulates the behavior of gas molecules, rather than solving a governing set of partial differential equations, by using simulated molecules which move and interact with solid surfaces in a way which can be predicted by each molecule's velocity vector. Collisions among molecules, however, are treated probabilistically through the use of a Monte Carlo technique conceived by Bird which is based on fundamental concepts of kinetic theory. The accuracy and efficiency of this approach have been demonstrated and are well understood.

Virtual ISS Lab Module

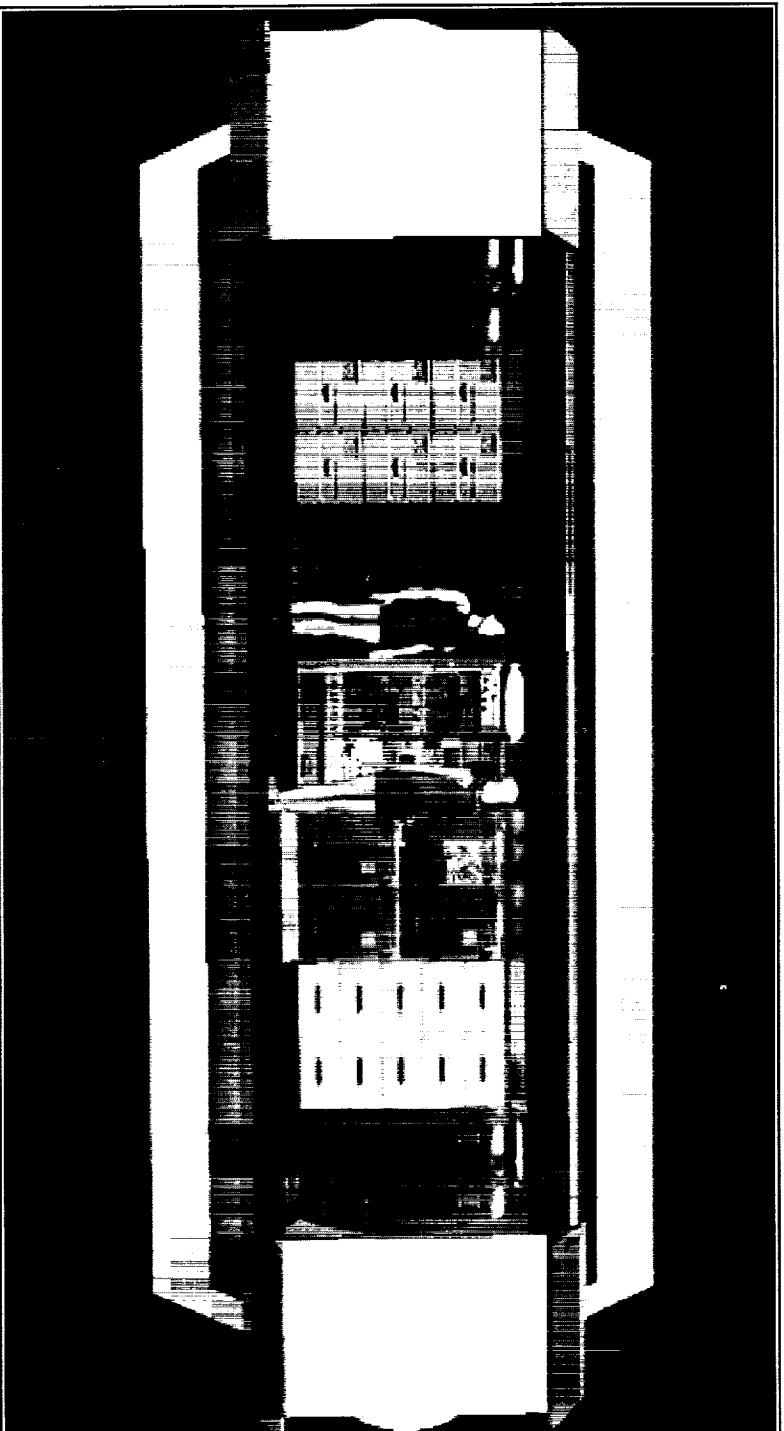

**Two Virtual Astronauts Participating in a Cooperative Task On Board the
Human Research Facility Module**

Advanced Training Technologies

Benefit

Virtual environments (also known as virtual reality) serve to enhance the effectiveness, broaden the availability, and reduce the cost of ground-based training. Further, these same technologies, delivered on-orbit, can be used to provide "just-in-time" training for both in-flight maintenance operations and the conducting of in-flight scientific experiments. The application of these technologies brings uniformity and verifiability to training, increasing safety and the probability of mission success. In addition to training, the potential of virtual environments to aid in the visualization of scientific and engineering data is tremendous.

Accomplishment

The Virtual Environment Technology Laboratory (VETL) has demonstrated success at sustaining and enhancing ongoing efforts to develop and deploy virtual environment technology for use by NASA in training and data visualization. For example, a prototype shared virtual environment for training International Space Station crews in the operation and maintenance of science experiments has been successfully demonstrated. Additionally, the Laboratory has already had extraordinary success in catalyzing the transfer of NASA-developed technology into the private sector in the areas of oil exploration, education, and medicine.

Background

In 1995, NASA and the University of Houston executed a Space Act Agreement to establish a joint VETL. The primary objectives of the VETL are to develop and deploy enabling technologies that support the building of training and data visualization applications that utilize virtual environments and intelligent computer-aided training technology.

For further technical information, contact Susan Torney at (281) 244-7486 or susan.e.torney1@jsc.nasa.gov

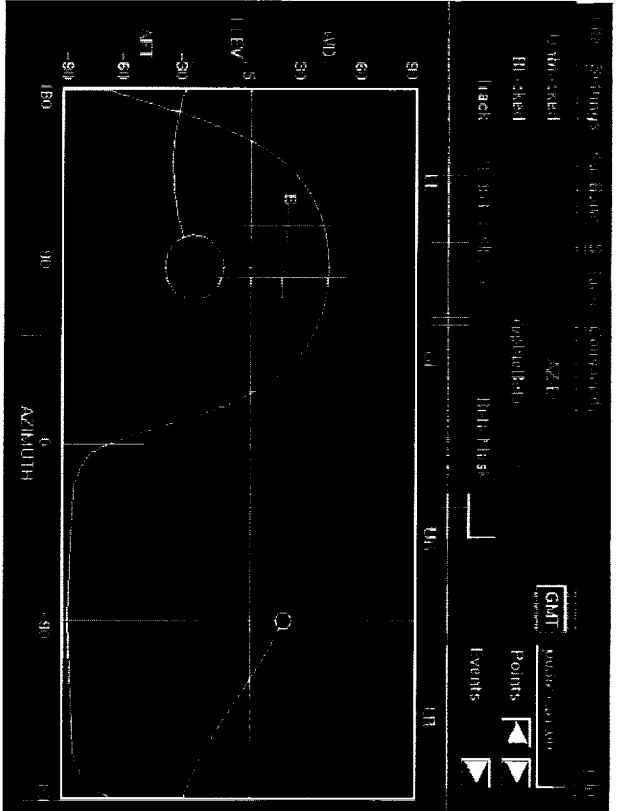

Antenna Management

Antenna ID	Type	Status	Mode	Power	Temp	Health	Notes
MACH 2A	MA	ON	Normal	100%	25.0	OK	
MACH 2B	MA	ON	Normal	100%	25.0	OK	
MACH 2C	MA	ON	Normal	100%	25.0	OK	
MACH 2D	MA	ON	Normal	100%	25.0	OK	
MACH 2E	MA	ON	Normal	100%	25.0	OK	
MACH 2F	MA	ON	Normal	100%	25.0	OK	
MACH 2G	MA	ON	Normal	100%	25.0	OK	
MACH 2H	MA	ON	Normal	100%	25.0	OK	
MACH 2I	MA	ON	Normal	100%	25.0	OK	
MACH 2J	MA	ON	Normal	100%	25.0	OK	
MACH 2K	MA	ON	Normal	100%	25.0	OK	
MACH 2L	MA	ON	Normal	100%	25.0	OK	
MACH 2M	MA	ON	Normal	100%	25.0	OK	
MACH 2N	MA	ON	Normal	100%	25.0	OK	
MACH 2O	MA	ON	Normal	100%	25.0	OK	
MACH 2P	MA	ON	Normal	100%	25.0	OK	
MACH 2Q	MA	ON	Normal	100%	25.0	OK	
MACH 2R	MA	ON	Normal	100%	25.0	OK	
MACH 2S	MA	ON	Normal	100%	25.0	OK	
MACH 2T	MA	ON	Normal	100%	25.0	OK	
MACH 2U	MA	ON	Normal	100%	25.0	OK	
MACH 2V	MA	ON	Normal	100%	25.0	OK	
MACH 2W	MA	ON	Normal	100%	25.0	OK	
MACH 2X	MA	ON	Normal	100%	25.0	OK	
MACH 2Y	MA	ON	Normal	100%	25.0	OK	
MACH 2Z	MA	ON	Normal	100%	25.0	OK	

Auto De-Orbit Landing PAD

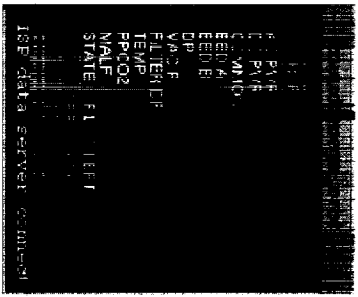

EECOM RCRRS

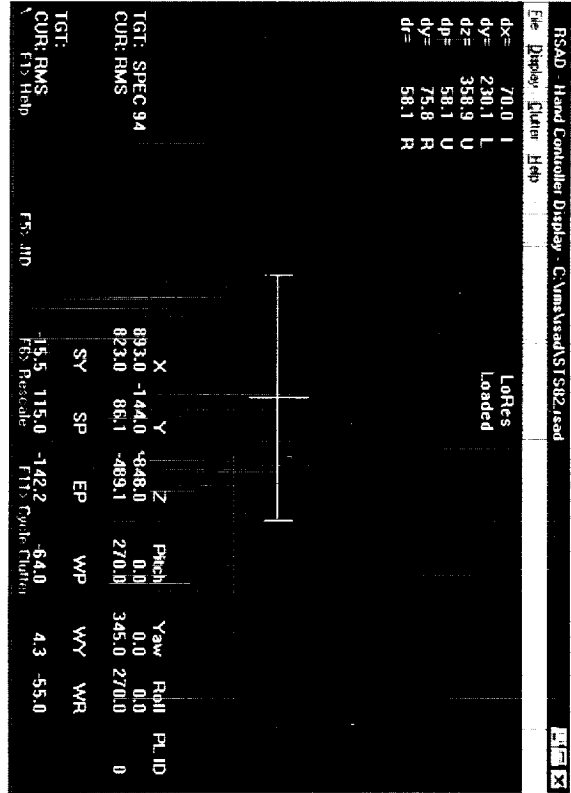

RMS Situational Awareness Display

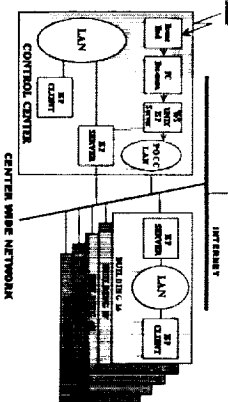

PC POCC

Examples of Copes for Flight Control

Cooperating Expert System (CoopES)

Benefit

The cost of ground support of human space operations can be significantly reduced by modernizing mission control facilities and introducing automated technologies. The CoopES project applies modern software technologies to mission support applications software. It exploits distributed computing infrastructures to (1) apply new and commercial technologies to mission operations, (2) design cooperating intelligent systems, and (3) implement certified software applications which solve specific flight support problems and reduce operational costs.

Accomplishment

Several new and enhanced capabilities were completed in fiscal year (FY) 1996 and integrated into the Johnson Space Center (JSC) Mission Control Center (MCC) for use by the flight control team during shuttle operations. The new software capabilities delivered for FY96 included the Emergency, Environmental, and Consumables Manager (EECOM) Regenerative CO₂ Reduction System (RCRS), the Flight Dynamics Officer Auto Deorbit Landing Pad, and an extravehicular mobility unit PC-based telemetry logger. The new hardware/software capabilities delivered for FY96 were the PC Payload Operation Control Center (POCC) payload decommutation server. The enhanced software capabilities delivered for FY96 included the Instrumentation and Communications Officer (INCO) Antenna Management and the INCO Operational Instrumentation Monitor which included the Data Signal Conditioner. Also, during FY96, CoopES commenced development of the Remote Manipulator Subsystem (RMS) Situational Awareness Display. The CoopES project is facilitating the consolidation of flight controller positions.

Background

The CoopES project was initiated to facilitate the infusion of technology into the MCC to enable JSC to carry out flight operations more effectively and efficiently. The project team works directly with the flight control team to identify specific flight support problems, identify technologies that most effectively provide the needed capabilities, and deliver certified software which solves the problem.

For further technical information, contact Mitchell Macha at (281) 483-7059 or mitchell.g.macha1@jsc.nasa.gov

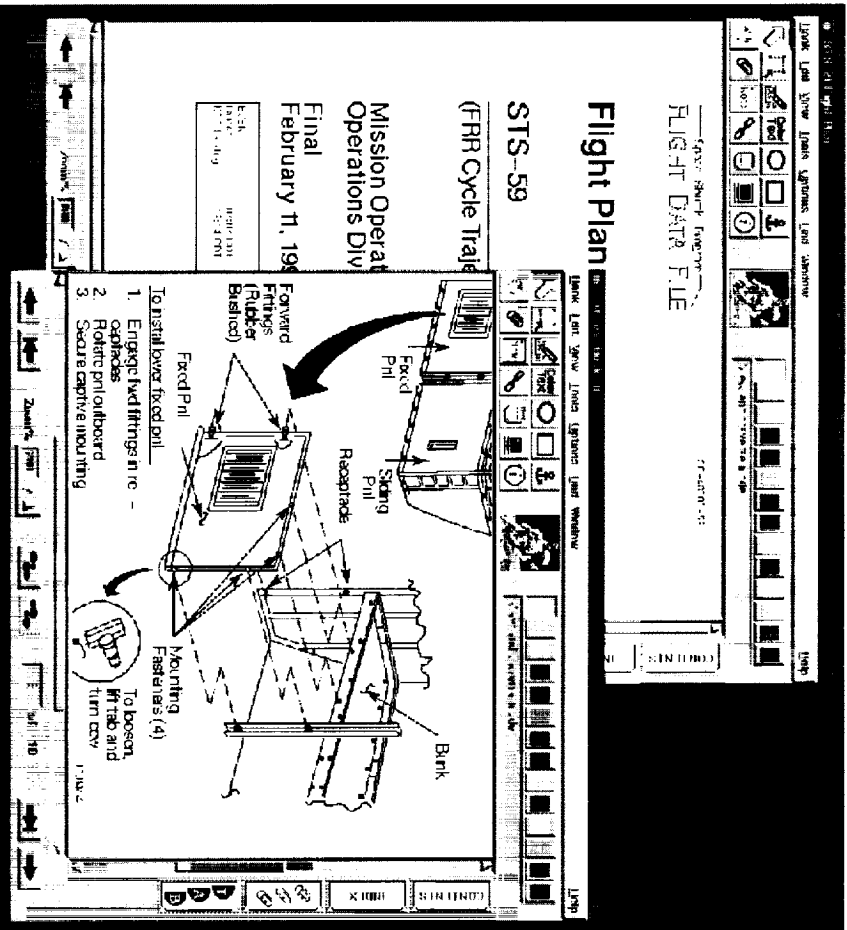

EDP Document Viewing Software

Electronic Documentation Project (EDP)

Benefit

The complex nature of space flight systems and operations demand a robust capability for construction, organization, and control of very large amounts of information. This information is created in a variety of ways and on a number of platforms, but has a common need for organization, rapid access, non-linear traversal, and a high degree of configuration control. The EDP system is designed and implemented specifically with these requirements in mind. The look and operation of the document viewer is the same across platforms. This has eased the transition into the use of electronic books, as users must only learn one application for all of the different types of books in the library, and can take that same knowledge and experience with them across platforms and environments. The user of the EDP tools, whether in the office or on console, has access to the same document and annotation files.

Accomplishment

No spaceflight operation has been conducted out of the new Johnson Space Center Mission Control Center (MCC) without full library and real-time operations use and support by EDP. The library of supported books includes the Flight Data File, Flight Rules, Space Shuttle Systems Handbook drawings, MCC operations notes, and console handbooks. To date, the operational library contains over 750 books, not including those archived from past flights. Over 2500 book translation jobs have been executed in the MCC, and normal document turnaround in the library is less than one hour, replacing turnaround of several hours at a reproduction facility or several days at a print shop.

Background

The EDP concept was to develop an innovative approach to injecting electronic book technology into the operations environments of the Johnson Space Center. The system was to provide an electronic capability to display, distribute, and control crew/ground controller procedures and documentation. The system had to broadly accept document input from a variety of sources. It had to integrate cleanly into a pre-existing infrastructure both within the MCC and the Johnson Space Center office systems. The system had to be highly secure, with protection for not only its own data and systems, but also for those to which it was connected. Yet the security had to be implemented in a manner so as not to inhibit the system utility to users. The EDP system had to support users on a variety of hardware platforms and software operating systems, yet maintain the same functional "look and feel" across these platforms so as to minimize the training and transition impacts to each of these platforms.

For further technical information, contact Tony Griffith at (281) 244-5813 or anthony.d.griffith1@jsc.nasa.gov

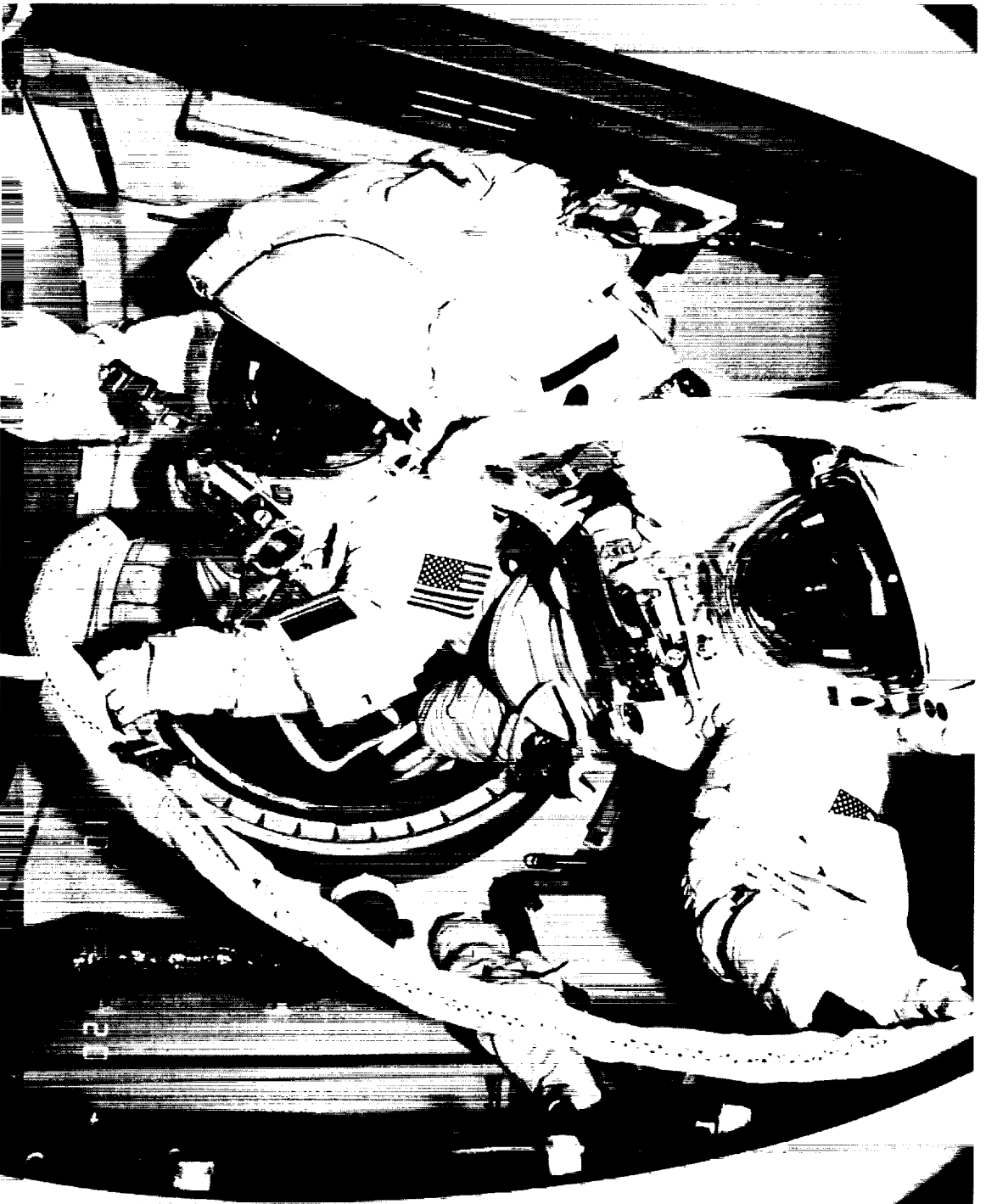

Electronic Cuff Checklist During Extravehicular Activity

Extravehicular Activity (EVA) Display Assembly

Benefit

Unlike the paper cuff checklist that is compiled months in advance of a Space Shuttle mission, the International Space Station (ISS) scenarios require the capability for real-time procedure modifications to address ongoing, changing tasks. The information stored electronically in the EVA display computer will provide the astronauts with updated procedures necessary to perform the required task during a spacewalk. In addition, the EVA display assembly will provide the astronauts with the flexibility of electronically receiving real-time procedure updates and/or video necessary to complete their tasks.

Accomplishment

The EVA display assembly is a redesign of the electronic cuff checklist, which failed to meet the requirements for future use on ISS. The EVA display assembly comprises two parts: the EVA display is a device designed to attach to the glove gauntlet of the U.S. extravehicular mobility unit (EMU), and the EVA display computer contains the processing and data storage hardware. The EVA display assembly will provide the EVA crew members with all of the text and graphical data necessary to complete their required tasks, with the additional capability of storing caution and warning data from the spacesuit or other future hardware. In addition, it is also capable of supporting video, either from video clips stored in memory or via composite video input. Updated procedures can be electronically transferred to the EVA display computer via a PCMCIA card, which is compatible with both Space Shuttle and ISS laptops. Likewise, it will also be compatible for both Shuttle and ISS locker stowage. The first fully integrated engineering unit will be completed by March 1998.

Background

EVA missions have been growing both in number and complexity. The two Hubble Space Telescope repair missions are good examples of this, both of which required five consecutive EVAs to complete all of the necessary repairs. All of these planned EVA missions required extensive training to ensure success; however, unlike Space Shuttle missions, Space Station missions will require real-time, day-to-day adjustments to procedures to achieve mission success.

Presently, astronauts rely on a paper, cuff-mounted checklist to refer to the simple text and graphics information that aids them in performing complex EVA missions. The paper cuff checklist is limited to 25 note-card-size pages (double-sided), which are printed and assembled over several months before a scheduled EVA mission. Although this method has been successful for years on Space Shuttle flights, it will not meet the logistical constraints of ISS maintenance EVAs since the crew will only receive supplies every 90 days or more.

For further technical information, contact Tony Wagner at (281) 483-3485 or anthony.wagner1@jsc.nasa.gov

File Show Plots

file: plbd.sit

SITUATION-BASED LOG: PLBD OPENING (WITH ANOMALIES)

```

--EVENT--
PLBD Start-up
release centerline latches 5 to 8
release centerline latches 9 to 12
*release centerline latches 1 to 4
release centerline latches 13 to 16
release starboard forward bulkhead latches
release starboard aft bulkhead latches
* open starboard door
release port forward bulkhead latches
release port aft bulkhead latches
* open port door - aborted
PLBD Cleanup

```

	55 sec	63 Sec
PLBD Cleanup	55 sec	63 Sec
* open port door - aborted	25 sec	30 sec
release port aft bulkhead latches	25 sec	30 sec
release port forward bulkhead latches	56 sec	63 sec
* open starboard door	25 sec	30 sec
release starboard aft bulkhead latches	25 sec	30 sec
release starboard forward bulkhead latches	17 sec	20 sec
*release centerline latches 1 to 4	34 sec	20 sec
release centerline latches 5 to 8	18 sec	20 sec
release centerline latches 9 to 12	17 sec	20 sec

```

* open port door - aborted
*status time-out during PORT PLBD opening
#H000/01:13:45 PORT door motor 1 STALL - PIRATE
#H000/01:13:45 PORT door motor 2 STALL - PIRATE
#H000/01:14:57 PLBD sequence fail ON
command to open PORT door ON
H000/01:12:50 PORT door open command 1 ON
H000/01:12:50 PORT door open command 2 ON
state PORT door opening
H000/01:12:49 Mid HCR 4 op stat 5 ON
H000/01:12:50 Mid HCR 2 op stat 1 ON
H000/01:12:50 PORT door motor 1 ON
H000/01:12:50 PORT door motor 2 ON
H000/01:12:51 PORT door close indication 1 OFF
H000/01:12:51 PORT door close indication 2 OFF
H000/01:12:51 PORT FWD ready-to-latch indication 1 OFF
H000/01:12:51 PORT FWD ready-to-latch indication 2 OFF
H000/01:12:52 PORT FWD ready-to-latch indication 3 OFF
H000/01:12:51 PORT FWD ready-to-latch indication 1 OFF
H000/01:12:51 PORT FWD ready-to-latch indication 2 OFF
H000/01:12:52 PORT FWD ready-to-latch indication 3 OFF
*state PORT door
** PORT door open indication 1
** PORT door open indication 2

```

Situation Event Review Window, With Details Selected for Aborted Operation

Human Interaction Design for Cooperating Automation and Anomaly Response Systems

Benefit

New methods and designs are being developed to improve human interaction designs for intelligent computer systems for control centers, to support and automate real-time monitoring, anomaly detection, and anomaly response. The objective is to develop low-cost user-maintainable cooperative automation software. One type of software will provide intelligent situation assessment, summarization, and presentation, to enable operators to interact with systems by exception, rather than in a mode of constant vigilance. Another type of software will support team decision-making about anomaly causes and courses of action, by providing early and rapid electronic access to developing information from multiple organizations involved in anomaly response, and searches of archived information for relevant analysis results from past anomaly cases.

Accomplishment

Human interaction designs, operational prototypes and system requirements were completed for two systems for aiding ground controllers in monitoring and reviewing events and situations. SPORT (situation playback Orbiter data reduction complex (ODRC) retrieval tool) provides real-time data playback and plots for situation review, and automates data retrieval requests. The situation data collection and review system selects data for organized logs and plots, for presentation and review. The situation review displays are designed to aid anomaly identification and comparison of expected with observed operations times and data during an event. These designs have been adapted and implemented in the Space Shuttle Remote Manipulator System Assistant Project. A related Ohio State University Technical Report has been completed, "Coordination Across Shift Boundaries in Space Shuttle Mission Control."

Scenarios and storyboards have been developed for a specification tool for the situation data collection and review system, to incrementally develop specifications for capture and viewing of the situation data.

Human interaction designs and a World Wide Web-based mockup were completed for an Internet-browser-based anomaly response tracking and integrated system. A related Ohio State University Technical Report has been completed, "A Cognitive Analysis of Functionally Distributed Anomaly Response in Space Shuttle Mission Control."

A Human Interaction Design Field Guide documents methods of iterative design used and refined by the team during the project. A Website version of this Field Guide and a Guidelines and Lessons Learned document are also products of this project.

Background

This project is interdisciplinary, involving human factors, computer science, and engineering professionals with specialization in intelligent systems technology. The approach is to design the automation software as a team player that is so informative and cooperative that it provides on-the-job training as well as timely information briefings. The focus is on gaining an understanding of operator tasks and systems, expertise, and difficulties, leading to useful and usable software designs. Further information concerning the methods and goals of this type of project is available in the just-completed book chapter, "Paradigms for Intelligent Interface Design," in the 1997 Second Edition of the Handbook of Human-Computer Interaction.

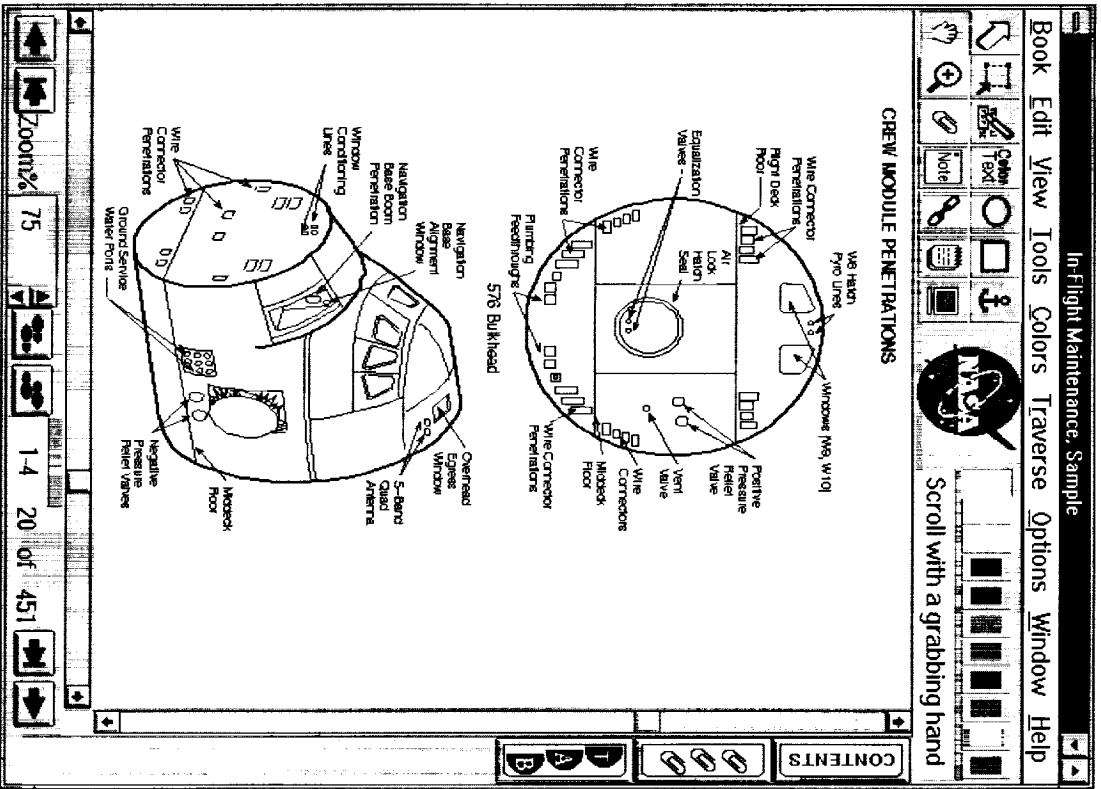

Document Viewer

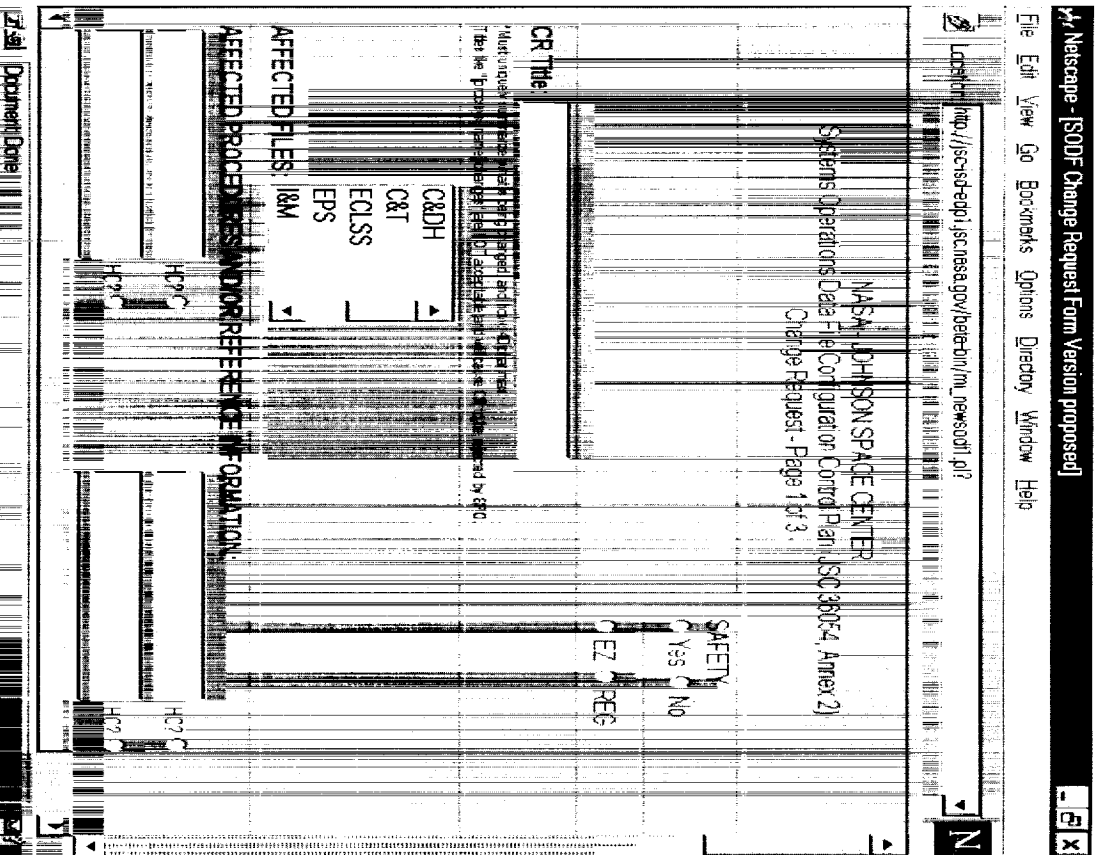

Workflow Display

High Volume Data Management (HVDM)

Benefit

Significant efficiency and cost benefit is being implemented through a vast decrease in printed documents due to the Electronic Documentation Project (EDP), and shall be further enhanced in this task. Through use of electronic, vs. paper, change processing, an approximate 40% time savings is realized. By empowering process engineers to independently build their own system flows, an estimated .5EP per new process savings can be realized. Building on the Internet experience of EDP, HVDM will allow Internet access to the document libraries for remote users and Space Station international partners. Primary savings will come from additional Web-based utilization of the EDP libraries for remote NASA users, as well as elimination of the developer involvement in process definition of workflow tasks. Both of these items will serve to radically broaden the scope and user support of the systems originally built for EDP.

Accomplishment

Currently completing the first year of the project, in cooperation with NASA's Jet Propulsion Laboratory, HVDM is finishing deployment for two workflow installations, as well as prototyping candidate solutions for the workflow auto-process engine and viewer client/server implementation. Possible future cooperative development with the Adobe Corporation is being investigated.

Background

As a follow-on to the EDP, the HVDM will develop a system to interface the EDP viewer as a client/server application (vs. an embedded database) to the Internet as a Web helper application. HVDM will also build an automated process definition engine for the EDP workflow system. This will allow process engineers to define or refine their process flows without a dependence on developer support to make these changes. A future cooperative development with the Adobe Corporation is being considered to more fully leverage from the NASA use of the PDF document format.

For further technical information, contact Tony Griffith at (281) 244-5813 or anothy.d.griffith1@jsc.nasa.gov

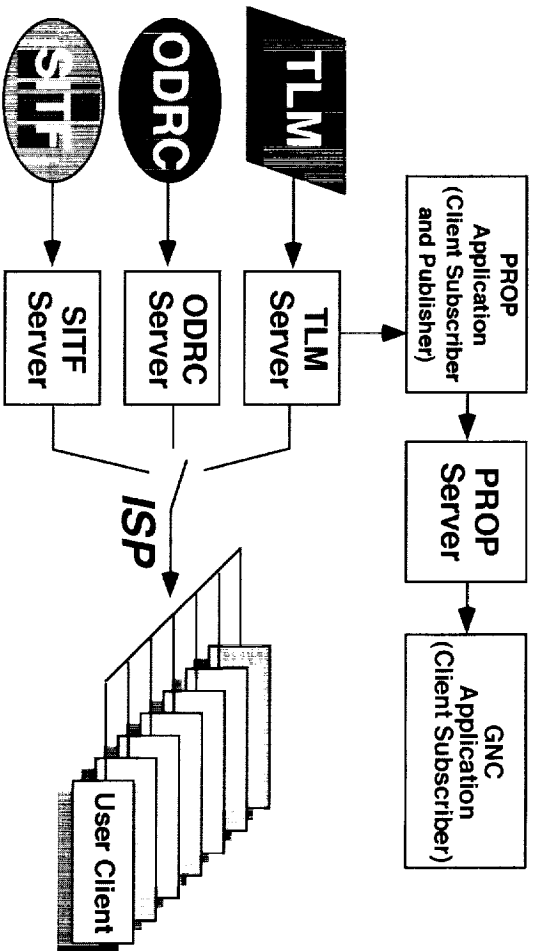

Local Area Architectural Overview of Information-Sharing Protocol

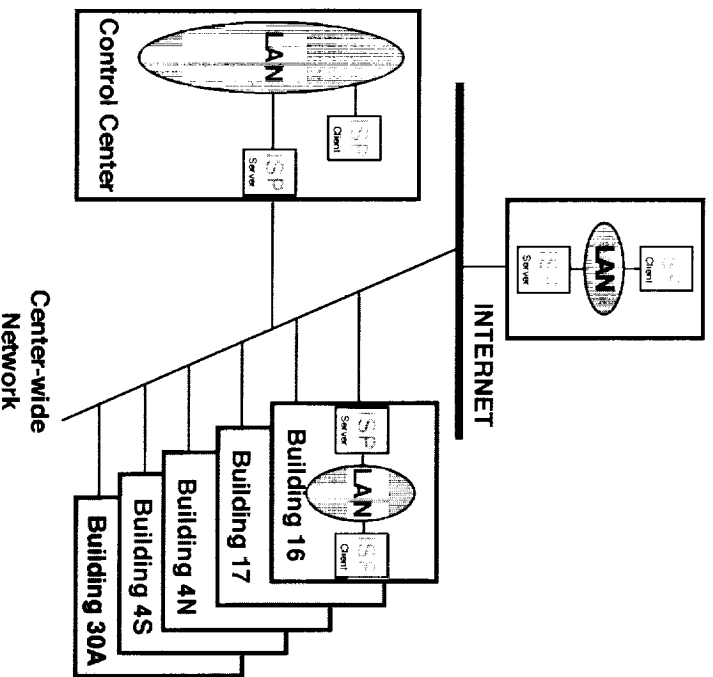

Wide Area Architectural View of Information-Sharing Protocol

Information-Sharing Protocol (ISP) Technology

Benefit

An ISP developed for use in the Johnson Space Center (JSC) Mission Control Center (MCC) provides the capability to distribute telemetry data to any location in the world. This project will help the flight support community migrate toward the use of standard off-the-shelf solutions to the challenging problems posed by manned spaceflight support. It will demonstrate this migration through concrete pilot projects. And it will explore the integration issues involved when off-the-shelf products need to be interfaced with highly specialized, custom software.

Accomplishment

During fiscal year 1996, ISP technology was applied to the MCC to distribute data between work groups and the capability was implemented to distribute information to the Shuttle Internet home page, which provides the information to the public. In addition to JSC, ISP technology has been provided to the Goddard Space Flight Center where it is used to distribute Hubble Telescope data and to Marshall Space Flight Center to receive mission and simulation data.

Background

The old mainframe-based MCC did not provide an adequate platform for the introduction of information-sharing capabilities. The upgrade of the JSC MCC to a workstation-based architecture provided the opportunity to introduce these technologies. This project integrates off-the-shelf software technologies into mission support software. Commercial and existing government software is integrated into the MCC distributed computing infrastructure to more effectively and efficiently support Shuttle and International Space Station (ISS) missions. There are three parts to our proposal: (1) integration of off-the-shelf (commercial and existing NASA-developed) software into the MCC infrastructure, (2) development of fault-tolerant systems, and (3) development of PC-based real-time data distribution and analysis capabilities for Shuttle and ISS telemetry.

For further technical information, contact Mitchell Macha at (281) 483-7059 or mitchell.g.macha1@jsc.nasa.gov



Workstation-Based Intelligent Computer-Aided Training System

Intelligent Computer-Aided Training Tool Development

Benefit

Johnson Space Center has developed workstation-based, intelligent computer-aided training systems that can deliver intensive, comprehensive training at the rate and quality needed for the space program. These workstation systems can deliver intensive training to large numbers of trainees, independent of integrated simulations, and can significantly reduce the amount of on-the-job or simulator-based training necessary to achieve acceptable levels of performance. Intelligent computer-aided tools will greatly reduce the time, expense, and expertise required for automated development of intelligent computer-aided training systems.

Accomplishment

A suite of tools is being designed and developed in coordination with the International Space Station training office for the creation of intelligent computer-aided training systems. Objectives are to refine and evaluate current approaches toward evaluating actions, building remediation models, and building scenario generation models. The tool set will reduce the need for programming expertise and enable intelligent computer-aided training systems to be maintained more easily than is possible with existing software tools. Currently, intelligent computer-aided training developers code by hand the data files used by the general architecture. This is time-consuming, tedious, and error-prone. The tools will enable the data files to be built through a graphical user interface that can be used even by nonprogrammers.

Background

Training NASA astronauts, flight controllers, and other ground-support personnel has historically required extensive on-the-job or simulator-based training for individuals to acquire the knowledge and skills necessary for acceptable performance or certification. Current flight rates and the loss of experienced personnel to retirement and transfer severely reduce the ability of traditional training approaches to produce an adequate number of trained personnel. Over the past 8 years, a general purpose intelligent computer-aided training architecture has been created which enables faster implementation of intelligent computer-aided training systems. The architecture is composed of seven modules and is designed to generate appropriate scenarios for each student, evaluate student actions, and provide remediation upon errors. Each module has a well-defined relationship with the other modules, allowing module algorithms to be upgraded without a ripple effect. In a typical intelligent computer-aided training system, the development of the simulated work environment often takes 50% or more of the total time required to build the intelligent computer-aided training system. In some cases, especially at NASA, simulations already exist which meet the requirements of the intelligent computer-aided training system. The general purpose intelligent computer-aided training architecture has already addressed the reuse of existing simulations by defining a protocol for the simulations to use. Any simulation that can be modified to address this protocol can be transformed into an intelligent computer-aided training system. To reduce duplication of existing simulations, the initial version of the intelligent computer-aided training tools will be designed specifically to work with the part task trainers currently being developed.

For further technical information, contact Bob Savelly at (281) 483-8105 or robert.t.savelly1@jsc.nasa.gov

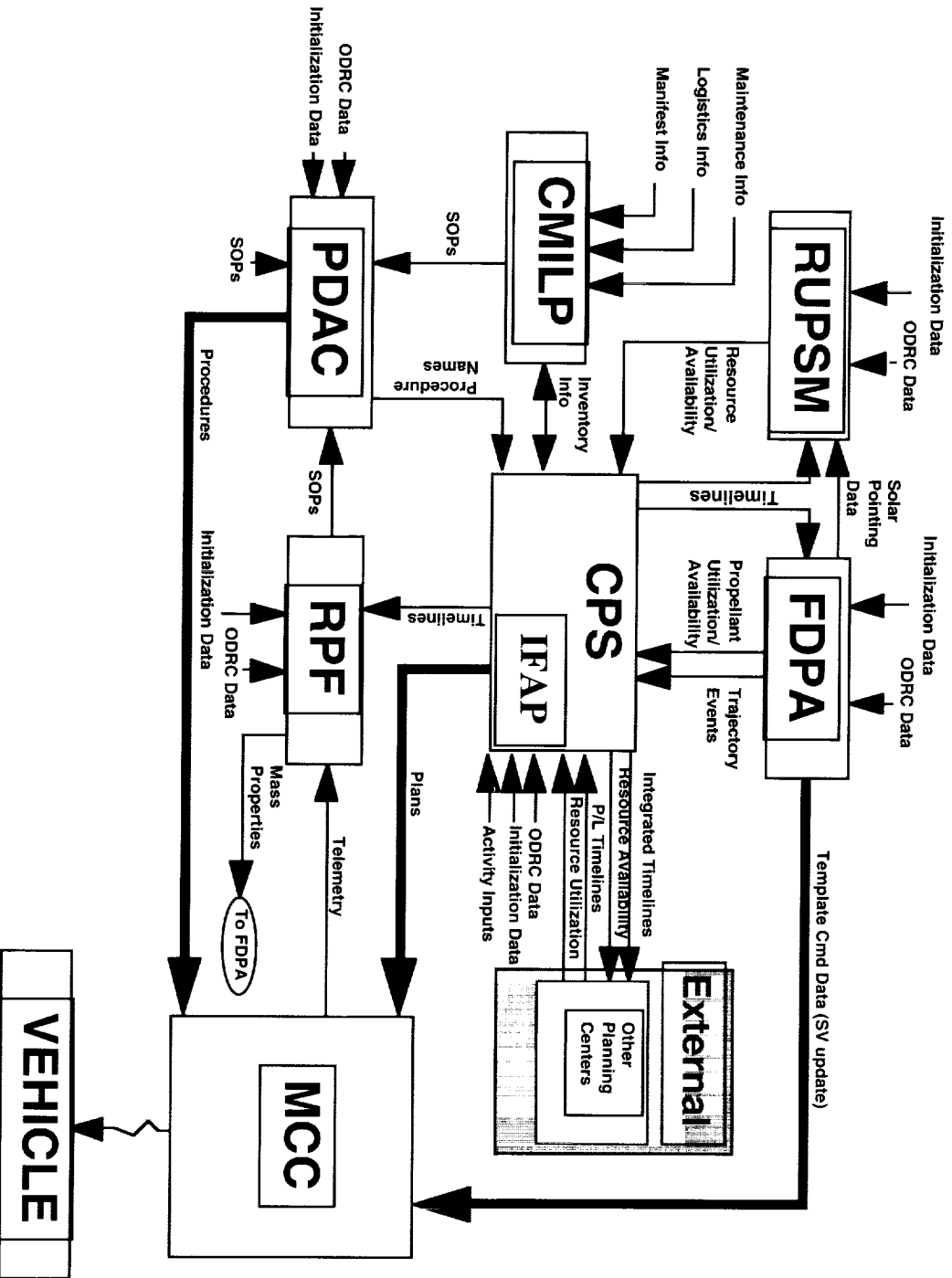

Integrated Station Planning System

Intelligent Flight Activity Planner (IFAP)

Benefit

Because of the great importance, diversity and complexity of the timelines developed by the flight planners, NASA could dramatically benefit from an automated approach to flight planning. However, no tool currently exists which is both comprehensive and flexible enough to accommodate the flight planners' needs.

Accomplishment

Phase I of the project, which has been completed, applied artificial intelligence (AI) problem solving expertise to the automation of the flight schedule development process. Phase I resulted in the design of a feasible, full-scale intelligent flight planner. One of the major objectives of Phase II will be the implementation of this tool.

IFAP is designed to capture the expertise of experienced planners and provide comprehensive, interactive planning assistance. IFAP can automatically plan flights, taking into consideration resources, conditions, constraints and planner heuristics or rules of thumb to improve the scheduling. By making use of generic sequence and activity definitions and relevant constraints, IFAP will generate a timeline from scratch or replan all or portions of an existing timeline. The result will have no resource conflicts, no broken constraints. By utilizing planner rules of thumb, IFAP can improve on this correct schedule. Because IFAP will incorporate planner expertise, even a novice planner could produce quality timelines. In addition to offering automatic planning and replanning capabilities, the human element is retained. The planner maintains control of the timeline and can interact with it, edit sequences or activities, and preserve these changes during the replanning process.

Background

IFAP was conceived to infuse artificial intelligence into the planning tools for Mission Operations, thereby improving the productivity of the planner, improving the quality of the timelines produced for the mission, and providing knowledge capture, allowing less experienced planners to produce quality timelines. The concept underlying the IFAP scheduling engine is the abstraction of scheduling ground rules from the actual timeline planning data. IFAP provides intelligent entity hierarchies to organize the data. The planner defines a hierarchy of intelligent entities to control the scheduling engine. The IFAP hierarchies include Timeline Hierarchy, Sequence Hierarchy, Activity Hierarchy, Individual Resource Hierarchy, Pooled Resource Hierarchy, External Condition Hierarchy, and Activity Condition Hierarchy.

For further technical information, contact Mark Jernigan at (281) 483-9528 or j.m.jernigan1@jsc.nasa.gov

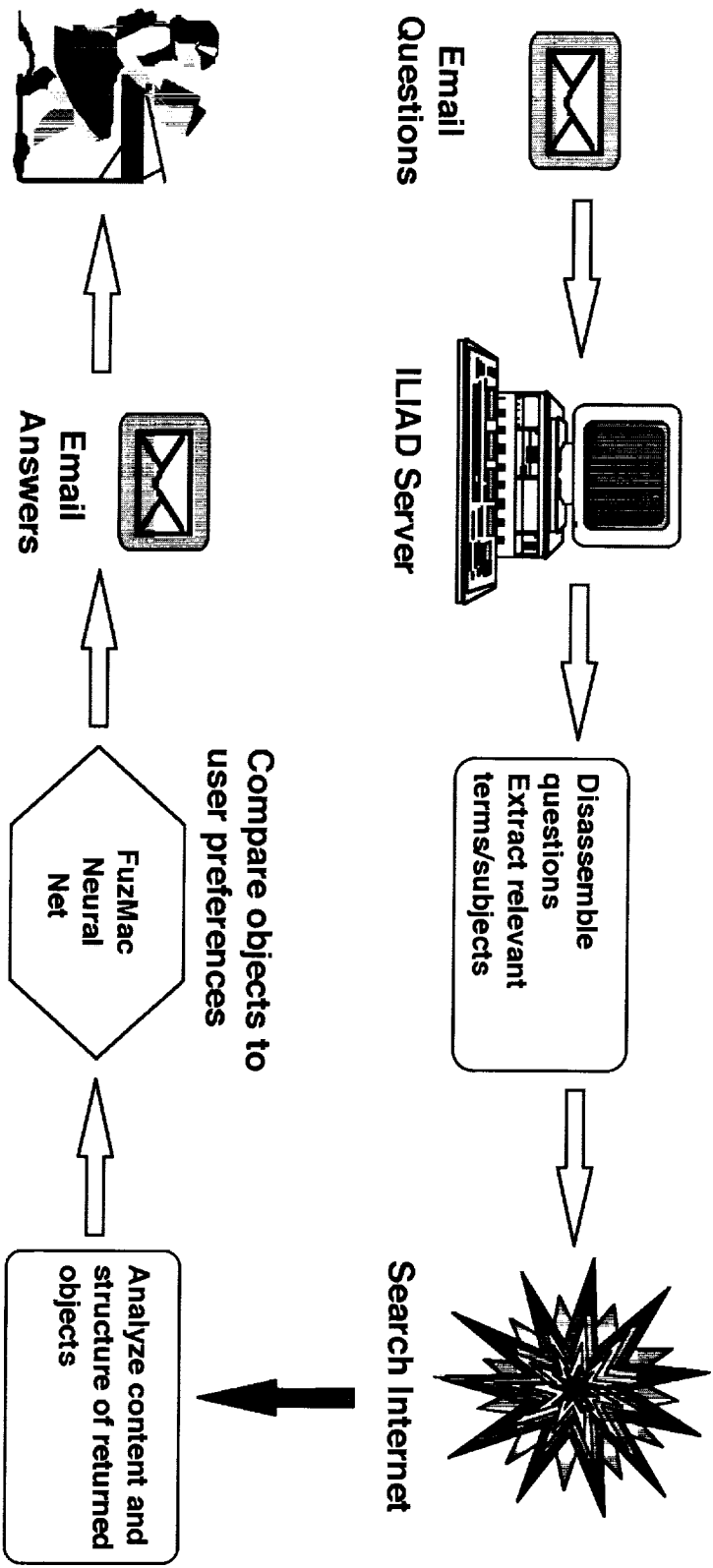

ILIAD—Internet Library Information Assembly Database

Internet Library Information Access Device

Benefit

The Internet Library Information Access Device (ILIAD) searches the web and returns documents that best match your query to you by electronic mail. ILIAD is ideal for those with low band-width connections, the vision impaired, persons having email-only service, or users wanting a fast, cheap, text-only interface to the Web. Users query ILIAD by electronic mail or through a standard web interface. ILIAD exploits meta-search technology, using multiple Internet search engines, and returns a small number of information-rich text documents to the user by return email. This mode of interaction provides efficient web access while requiring minimal hardware, software and connectivity from the user.

Accomplishment

The ILIAD application was originally fielded in July '95 at the Johnson Space Center (JSC) and has been in essentially continuous service since that time. ILIAD has been used by thousands of people over the past three years and continues to be a popular service, receiving the "Bot Spot of the Week" award in December '97. The latest version (5.0) is now running at JSC and the Texas Education Network (TENET) and has been transferred to the Research, Rehabilitation and Training Center for Blindness and Low Vision at Mississippi State University. The source code has also been licensed by a commercial interest.

Background

ILIAD was originally conceived to act as an electronic information assistant for teachers. As the Internet grew in size and complexity, it became impractical and inefficient to maintain a database for the contents of the entire Web, thus ILIAD became one of the first so-called "meta-searchers" - agents that synthesize results from multiple Internet search engines. The ILIAD email interface was initially conceived to minimize user requirements for hardware, software, and connectivity. In practice, this agent-based approach resulted in a flexible, efficient, and popular Internet search and retrieval tool.

For further technical information, contact Bob Shelton at (281) 483-5901 or robert.o.shelton1@jsc.nasa.gov

Netscap: Create A Web Lesson

To organize your documents into a Web Lesson, fill in the blanks and submit your form to the SIMON Library.

Library File Name: (ex:Hubble)
space station

Web Lesson Title: (ex: The Hubble Space Telescope)

The International Space Station

Lesson objective or instructions:

Read the following two documents and answer the questions on <a href=

↑

↓

File this lesson in up to three categories: (press Apple Key as you click to multi-select)

Physics
Psychology
Reading
Science
Zoology

Retain all documents from this session for future lesson.

Create Web Lesson

Cancel

Example of SIMON

School Internet Manager Over Networks

Benefit

The School Internet Manager Over Networks (SIMON) is a data-miner and lesson-builder developed for K-12 teachers. SIMON maximizes NASA's investments in educational Web content by exploiting agent technology to do searches off-line, providing a simple, natural interface for automatic lesson generation, and giving teachers intellectual control over electronic information sources.

Accomplishment

SIMON is a suite of Macintosh applications designed and implemented in approximately 12 months with production release 9/30/97. To afford the widest possible dissemination, the executable applications are available free to educators at <<http://www.jsc.nasa.gov/stb/simon.html>>. The source code has been licensed to two commercial interests for further development. Dissemination statistics collected following release of version 1.0 (10/97-2/98) show SIMON in use or evaluated in 146 schools by 255 teachers.

The free version also includes a lesson library consisting of 22 curriculum units gleaned from NASA educational Web resources. The development team works in conjunction with the Texas Education Network (TENET), local school districts, and the Johnson Space Center Education and Information Services Branch to provide continuing evaluation and dissemination of the product. The latest release (1/30/98) includes cross-platform viewing (the MACINTOSH-specific component is now limited to one server machine), enhanced retrieval options, and support for building lessons from interactive browsing as well as the original off-line search.

Background

As set forth in the charter establishing the space agency, NASA is committed to advance excellence in education by bringing new knowledge and technology into the classroom. To this end, the Agency supports the development of outstanding educational content which, to an increasing extent, has seen widespread dissemination over the Internet. Experience with teachers being trained to integrate these resources into classroom lessons and activities suggests the need for a technology solution to bridge the gap between Web pages and classroom-ready materials. SIMON is designed to address these needs by providing low-cost Internet connectivity, supporting time-effective off-line searches, facilitating creation of standard, reusable lessons aligned by teachers to their specific learning objectives, and providing intellectual control over electronic information used in the classroom.

For further technical information, contact Bob Shelton at (281) 483-5901 or robert.o.shelton1@jsc.nasa.gov

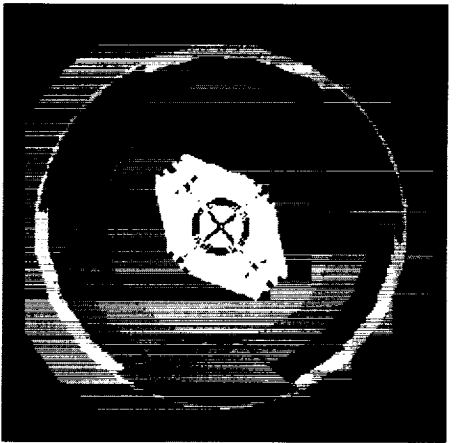

Fig 1. Docking target model with no shadow or glare.

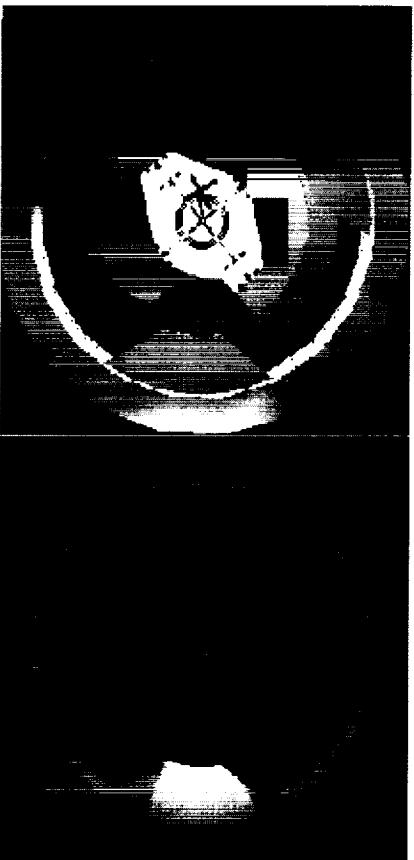

Fig. 2. Docking target model with shadows and glare.

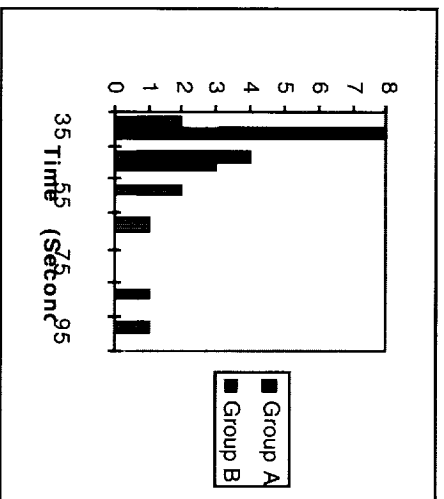

Fig. 3. A comparison of times to complete the actual task. Group A trained without lighting. Group B trained with lighting.

Effects of Lighting on Human Performance in Training

Effects of Lighting on Human Performance in Training

Benefit

When time constraints are imposed on a task, training with lighting effects improves task performance without sacrificing accuracy. In addition, subjective evidence reveals that subjects who trained with lighting effects had lower stress levels when executing the actual task. While computer technology is not yet able to generate "real-time" ray tracing images for training, lighting conditions can be modeled for specific cases using existing computer hardware lighting parameters and special case shadowing effects. The results also support the use of lighting and illumination techniques for non-computerized image creation using mockups and artificial lights.

Accomplishment

To compare task performance with respect to different types of training, a simple alignment task, similar to the alignment of the Orbiter with the *Mir* docking target, was used (figures 1 & 2). Two different experiments were conducted with two groups of subjects, those trained without lighting and those with lighting. The first experiment emphasized alignment accuracy only. Subjects were allowed any amount of time needed to obtain the required alignment. Objective results were not conclusive but subjects who trained with lighting images felt more confident 1) that their test results were accurate, 2) that their training would generalize to other tasks, and 3) that the training was reasonably realistic. The second experiment emphasized alignment accuracy and alignment response time. In this case, subjects trained with lighting (Group B) as part of the scenario had a significant advantage (average execution time 34.9 seconds) over those who did not (Group A with average execution time of 40.7 seconds). See figure 3.

Background

Many of the tasks performed by astronauts while in orbit, such as the deployment of payloads, depend on obtaining visual cues, either from a camera image or direct viewing. Direct exposure to intense sunlight and to rapidly changing sunlight direction makes crew response to high-contrast shadows and variations of incident light angles an essential part of carrying out mission operations. Training with mockups and lighting hardware has received positive response from crews prior to missions involving docking. However, much of the crew training is done with computer simulators using conventional shaded geometric models. These models do not simulate actual lighting environments which include effects such as shadows and glare. The purpose of this project was to compare the effect of different types of training images on actual task performance. Specifically, the effect of computer task training with accurate lighting images, shadows and glare, were compared to computer task training with basic shaded models with no shadows and glare effects.

For further technical information, contact James Maida at (281) 483-1113 or James.Maida@jsc.nasa.gov

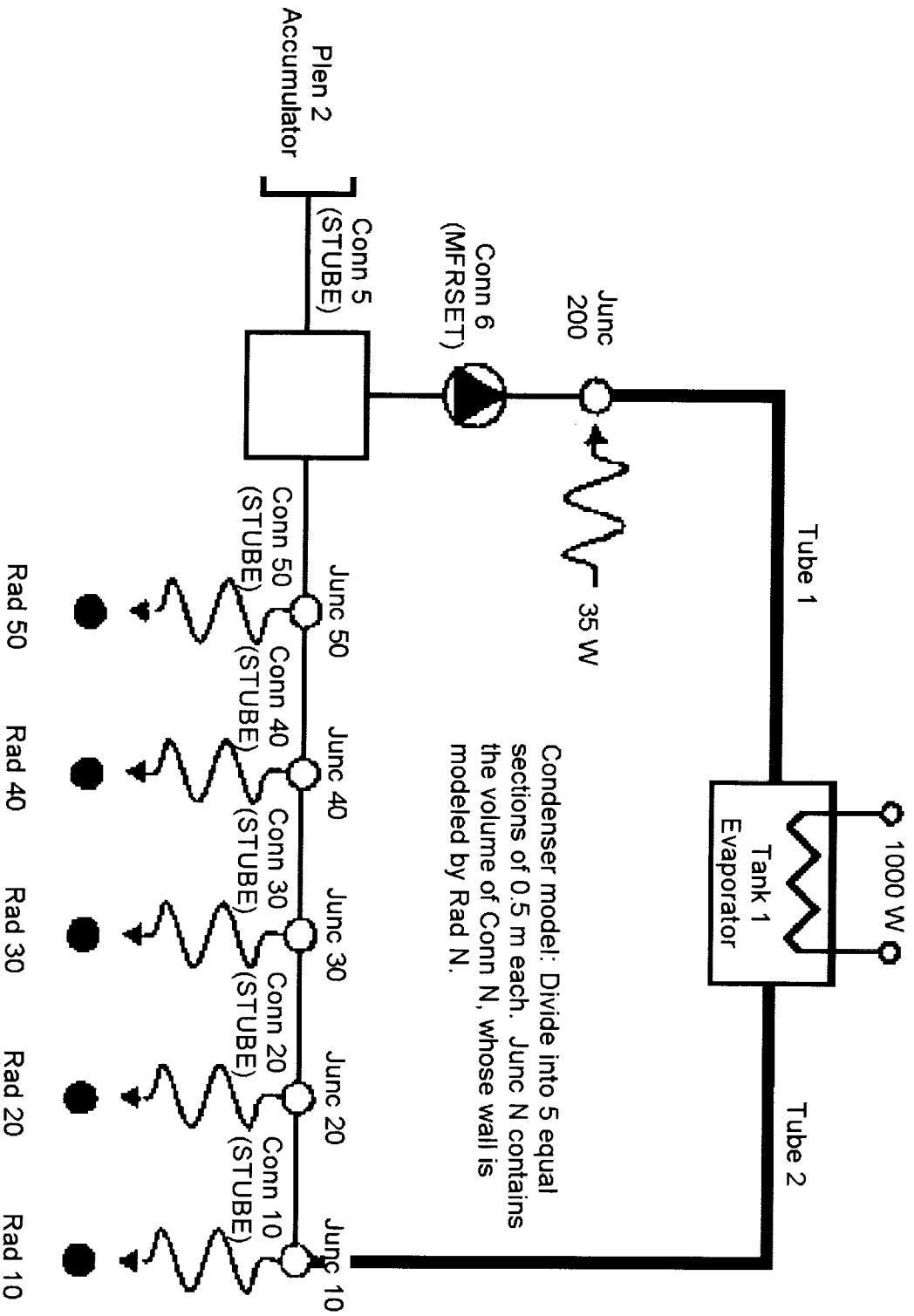

SINDA/FLUINT Version 3.2

SINDA/FLUINT Version 3.2

Benefit

The Systems Improved Numerical Differencing Analyzer/Fluid Integrator (SINDA/FLUINT) is a thermal/fluid design and analysis software that frees analysts from the constraints of geometric analysis which bog down finite element solvers. As a general purpose thermal/fluid network solver, it can model system-level designs that are too large or ill-defined for other software. Since it is completely user extensible, the execution can be customized with user-supplied logic, producing a code designed specifically for individual user needs.

Accomplishment

This program provides the following capabilities and features: 20,000 nodes, 100,000 conductors, 100 thermal submodels, and 25 fluid submodels. SINDA/FLUINT can model two-phase flow, capillary devices, fluids defined by users, gravity and acceleration body forces on a fluid, and variable volumes. It enables simulation of nonuniform heating and facilitates modeling of thin-walled heat exchangers. It also has the ability to model nonequilibrium behavior within two-phase volumes. As a thermal analyzer, SINDA can handle such interrelated phenomena as sublimation, diffuse radiation within enclosures, transport delay effects, and sensitivity analysis.

Improvements recently added to SINDA include calculator registers to achieve spreadsheet-like functionality in a manner integral to the program and the ability to model single- and two-phase mixtures of working fluids with one substance in the mixture being either a real gas (with arbitrary user-defined properties) or a condensable/volatile substance (e.g., liquid water and steam).

A graphical user interface, training, user support, and other machine versions are commercially available.

Background

SINDA is a software system for solving lumped-parameter representations of physical problems governed by diffusion-type equations. Although originally designed for analyzing thermal systems represented in electrical-analog lumped-parameter form, it can be used on other classes of physical systems that can be modeled in this form. FLUINT is an advanced one-dimensional fluid analysis program that solves equations of arbitrary fluid-flow networks. The working fluids can be single-phase vapors, single-phase liquids, or two-phase. The SINDA/FLUINT system enables the analysis of the mutual influences of thermal and fluid problems.

While the software package is often described as two packages, it is really two components of a whole and cannot be easily separated. The SINDA system, comprised of a programming language, preprocessor, and a subroutine library, has a language designed for working with lumped-parameter representations and finite-difference solution techniques. The preprocessor accepts programs written in the SINDA/FLUINT language and converts them into FORTRAN. The SINDA/FLUINT library consists of a large number of FORTRAN subroutines that perform a variety of commonly needed actions. Using these subroutines can greatly reduce the programming effort required to solve many problems.

A complete run of a SINDA/FLUINT model is a four-step process. First, the user's desired model is run through the preprocessor which writes out data files for the processor to read and translates the user's program code. Second, the translated code is compiled. The third step requires linking the user's code with the processor library. Finally, the processor is executed. SINDA/FLUINT is therefore like an extension of FORTRAN, able to accommodate user instructions and customization.

For further technical information, contact Eugene Ungar at (281) 483-9115 or eugene.k.ungar1@jsc.nasa.gov

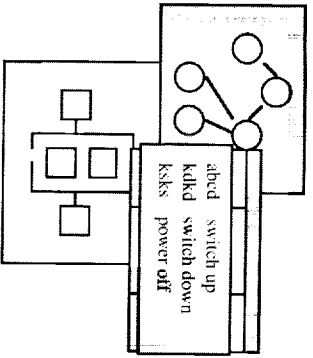

Instructor Tools

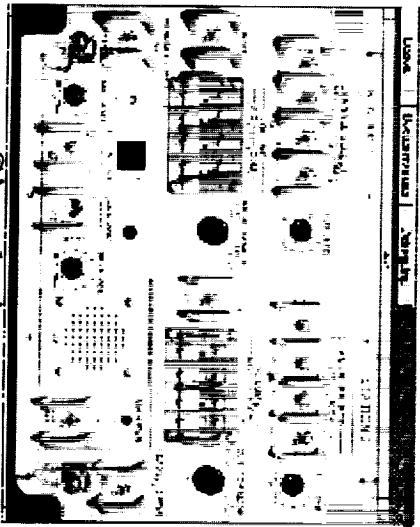

Simulation

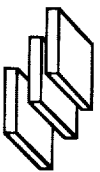

Lesson Files

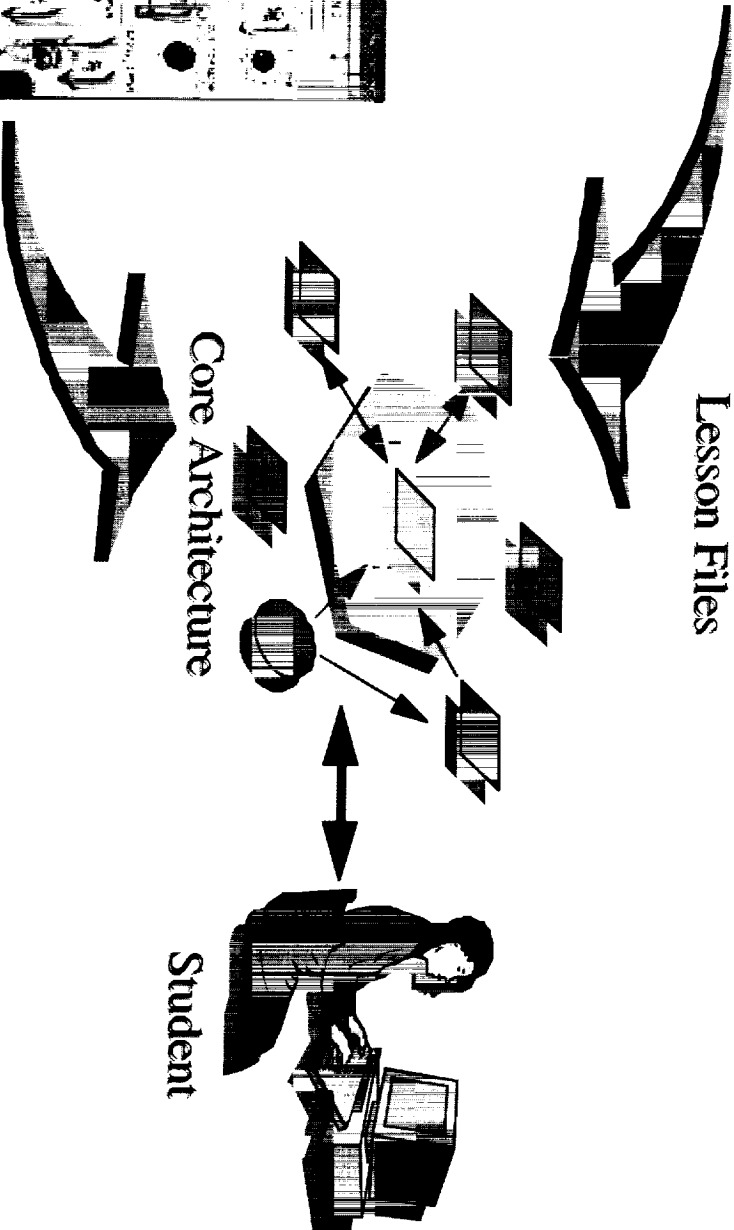

Space Operations Intelligent Computer-Aided Training

Space Operations Intelligent Computer Aided Training (ICAT)

Benefit

The Johnson Space Center (JSC) has a vision to provide intelligent instructorless simulation-based training to space flight crew members and ground flight controllers. This will reduce the cost of future space flight training in the following ways. First, intelligent instructorless lessons will reduce the number of exercises requiring instructor support, thereby slowing the trend toward greater numbers of instructors as space missions grow longer and more complex. Secondly, facility costs will decrease in some cases because intelligent instructorless training will permit greater fidelity training on the smaller, less expensive training systems, thereby reducing the number of training sessions required on the large, expensive training simulators where instructors will still be needed. An additional benefit of intelligent instructorless training is greater flexibility for scheduling training around a student's other appointments. On the other hand, intelligent instructorless systems are also more expensive to develop than today's conventional training systems. Research and development is needed to reduce the development costs of intelligent instructorless training systems and to improve the quality of correctional feedback given to the student.

Accomplishment

JSC is updating and enhancing the software that provides the basic foundation upon which ICAT systems are built. This basic foundation is called the core ICAT architecture (Fig. 1). Typically, for each new training application to be developed (e.g., an ICAT for environmental control and life support systems training), an expert instructor and a computer programmer are both needed full-time to build the required application-specific lesson files, plus the programmer must integrate the ICAT core with the simulation environment used by the students during current instructor-led training sessions. This research and development project will improve and update the technology used within the instructor tools, which will be enhanced and upgraded so that much less of the programmer's time is needed and so the expert instructor's lesson-building tasks are facilitated. Although much progress was made in earlier projects toward this end, this research and development project will significantly improve the core ICAT architecture and the instructor tools.

During fiscal year 1997, the Space Operations ICAT project redesigned the instructor tools and delivered the Beta 1 version of the new Instructor Tool Suite. A preliminary user's guide was also developed, and requirements for the appropriate test application were investigated.

Introduction and Background

During the Apollo and Space Shuttle eras, space flights have been monitored closely by large teams of flight controllers on the ground. However, space flight missions during the era of the Space Station and beyond will present significant challenges because of their length and complexity. For example, the scenario where large numbers of flight controllers monitor complex space station functions (or advanced Mars or Lunar spacecraft functions) around the clock, for months and years, is clearly a very expensive scenario. Large teams of developers and operators also make training for space flights very expensive. Ways to reduce operations and training costs significantly must be found in order to make advanced space missions economically feasible.

For further technical information, contact Susan Torney at (281) 244-7486 or susan.e.torney1@jsc.nasa.gov

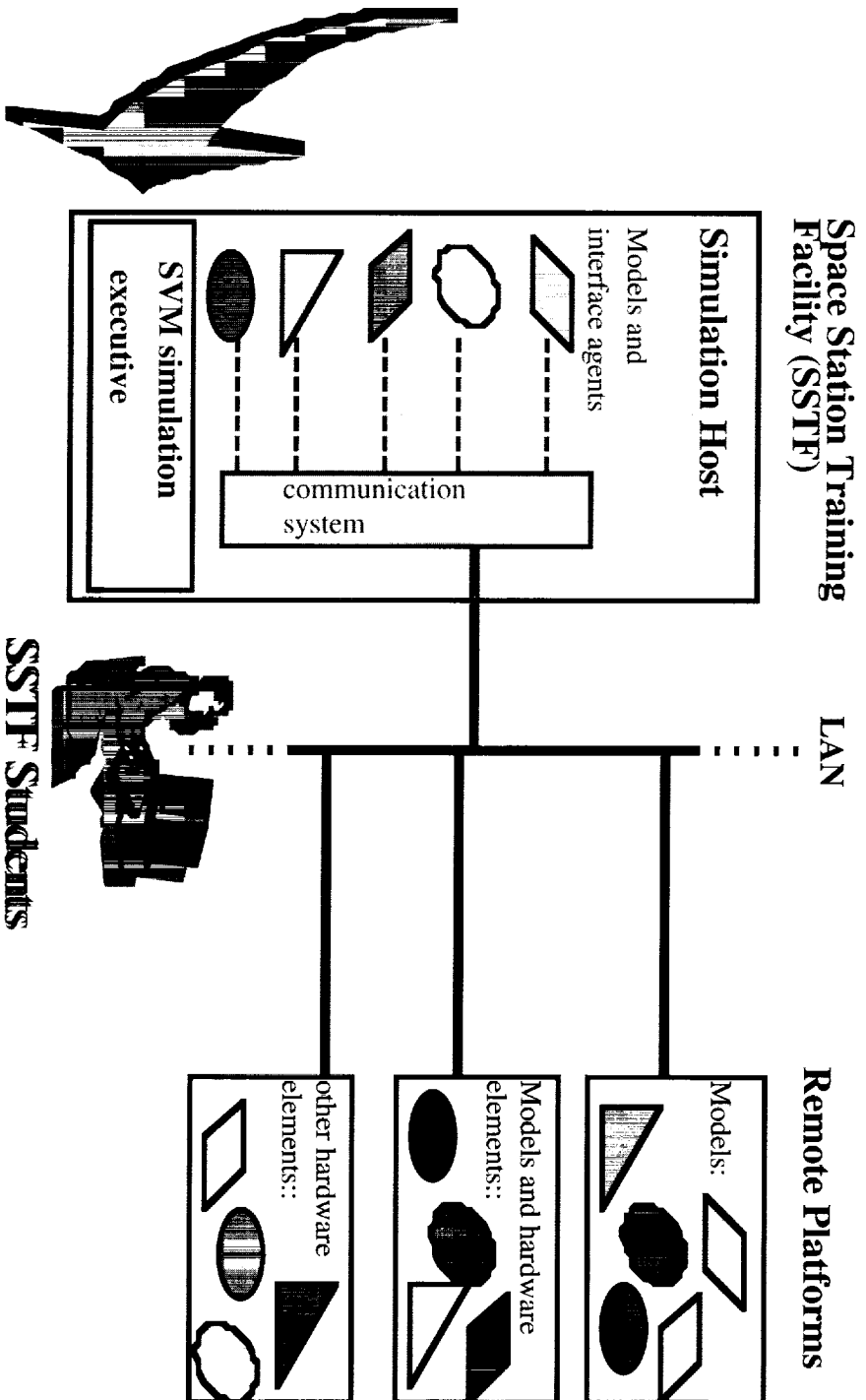

Simulation Virtual Machine

Simulation Virtual Machine (SVM)

Benefit

The SVM is a software executive that provides distributed processing, message passing, and rate monotonic scheduling for simulation models for the Space Station Training Facility (SSTF) at Johnson Space Center. SVM provides an excellent basis for distributed processing both in real-time and transaction processing software applications. It provides the commercial and military industry with a foundation that enables software processing from old mainframe architectures to distributed architectures. SVM is currently being investigated as a real-time solution for commercial space network simulations and Department of Defense wargaming applications.

Accomplishment

SVM lowers development costs and enhances code reuse by influencing structural consistency throughout a project using a documented object-oriented software architecture. SVM's executive lowers integration costs by shielding the application from the computer hardware specifics and by providing a standard interface to applications. SVM's executive is designed to support a distributed hardware environment (multi-task, -CPU, -node, -platform) and provides parallel, rate-monotonically scheduled execution threads, thread-to-thread time-consistent data-homogeneous message communication, and other executive functionality such as moding, datastore, and data term visibility. SVM is also based on standards and therefore relatively easy to rehost to different computer platforms. SVM's structural consistency and executive's flexibility lowers maintenance/upgrade costs by reducing the amount of work required to understand the software, change the software, and add new capabilities.

Background

To successfully train the crew and distributed ground systems for Space Station assembly/operations, a "virtual simulation" must occur between geographically distributed students. By adopting a common set of standards and objective-oriented techniques, problems related to the distribution of the training participants can be minimized. When implemented effectively, a virtual simulator can reuse existing assets for greater fidelity and capability at a significant cost and time savings. SVM provides the infrastructure software for implementing the virtual simulation for the SSTF.

For further technical information, contact Barbara Pearson at (281) 244-8295 or barbara.pearson1@jsc.nasa.gov

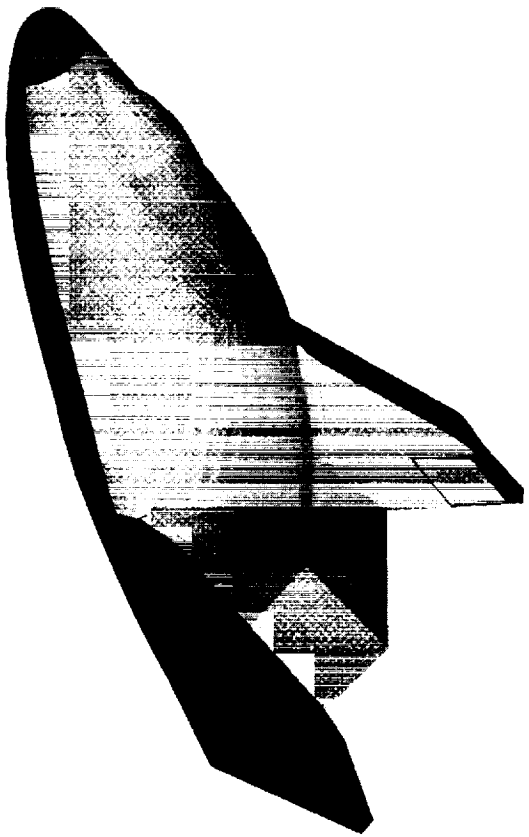

**TSS Thermal Radiation Analysis Results for the
ACRV-X Spacecraft**

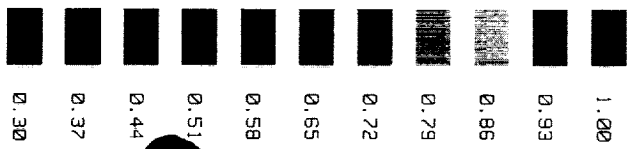
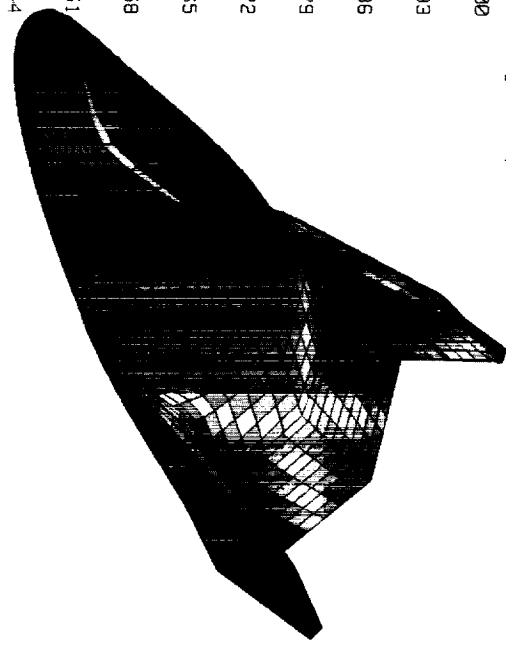

Fig 1 to space for all nodes.



**TSS Geometrical Mathematical Model of the ACRV-X
Spacecraft**

Thermal Synthesizer System, Version 6.0

Benefit

The TSS is a comprehensive set of analysis tools that will enable engineers to focus on defining analysis problems rather than programming syntax. TSS differs from existing analysis tools because it provides a friendly and flexible user interface, an interactive modeling environment with three-dimensional color graphics, and state-of-the-art analysis algorithms which support distributed processing. It combines the functionality of SINDA/FLUINT and radiation analysis with an easily understood user-interface environment. All this is coupled with powerful interactive color graphics and a geometric modeling capability.

Accomplishment

TSS is composed of many different applications: the geometry, radiation conductance, orbit, heatrate, heatsource, animation, conductance-capacitance, SINDA85, XU plot, and translator applications. Each application handles a different portion of the thermal analysis process. Since all of the modeling, analysis, and post-processing functions are integrated into a single system, users can now focus on thermal engineering instead of learning to interact with the computer system. A consistent, user-friendly interface which uses menus, icons, and command language replaces the nongraphical, batch-job-oriented, machine-specific interaction of earlier systems. Interactive visualization of models and results provides instant feedback, eliminating the need for large stacks of printouts. In this way, TSS has significantly improved engineering efficiency and allowed engineers to have greater confidence in their analysis results. An integrated method of visualizing the thermal radiation analysis results did not exist. The opposite graphic shows a TSS-produced, geometrical mathematical model of the assured crew return vehicle (ACRV)-X spacecraft and thermal radiation analysis results for the same spacecraft.

Recently, new capabilities have been added to TSS (version 6.0). A NASTRAN translator has been added so that thermal analysts can work structural analyses more easily. New methods have made radiation calculations for varying geometries faster. This would help in analyzing articulating spacecraft such as satellites with solar arrays. Trajectories can now be analyzed as well as orbits. Heat sources can now vary with time or orbit position.

Background

Before TSS was developed, engineers had to laboriously construct models with hand calculations and card image input. Once completed, the input deck was submitted to a preprocessor that checked the model for typographical errors. This same process was used to generate and display spacecraft orbits. Since the input was complicated and the method of input made errors inevitable, even more time had to be spent verifying the geometry, the articulation transformations, and the orbit. The analysis results created voluminous stacks of computer printouts.

TSS is available from COSMIC (V4.0) by license for a period of 10 years to approved licensees. Version 6.0 is available directly from NASA for all government contractors. The licensed program product includes the executable code and one copy of the supporting documentation.

For further technical information, contact Andy Hong at (281) 483-4423 or andrew.e.hong1@jsc.nasa.gov

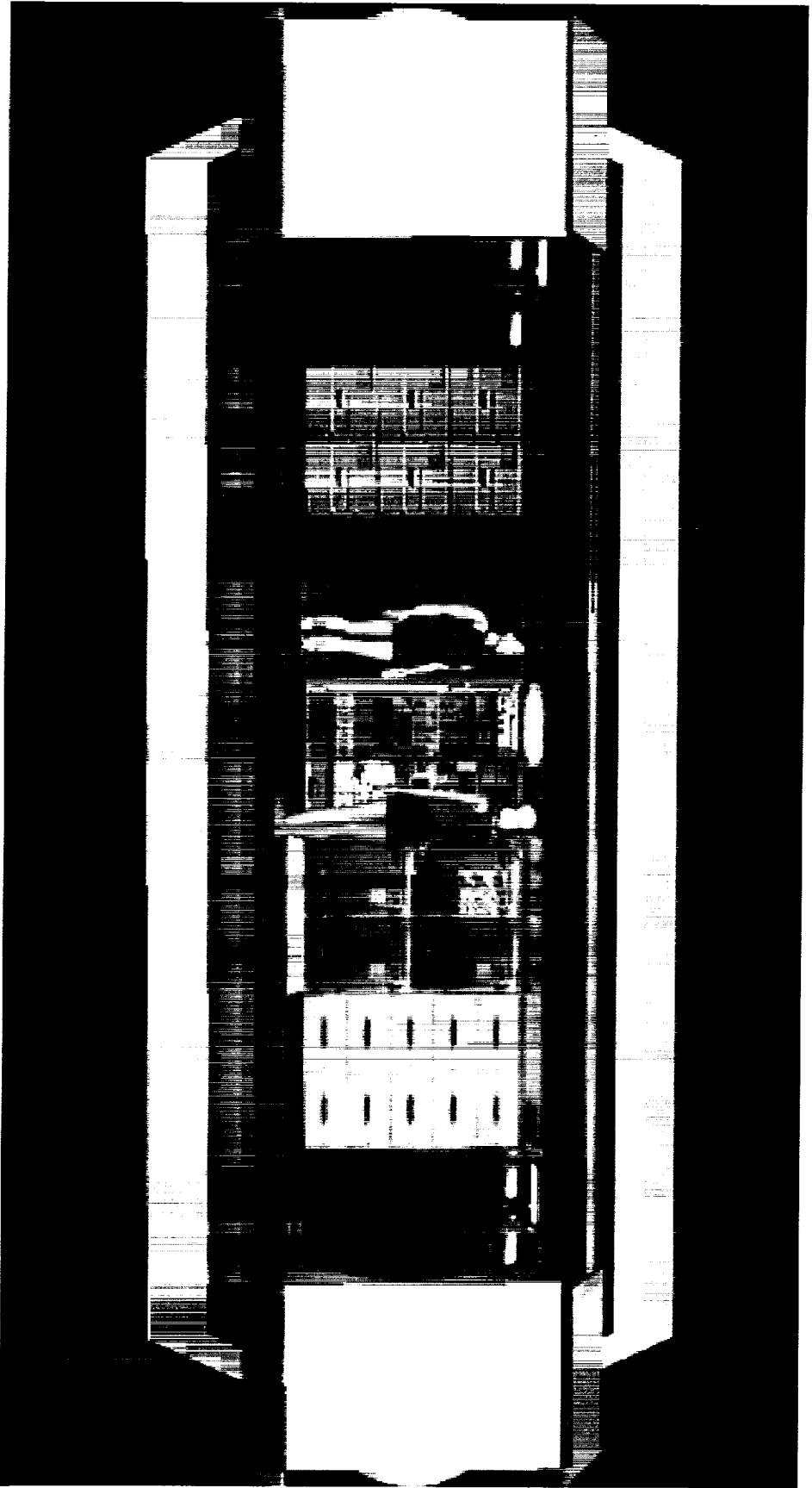

Training Within Shared Virtual Environment

Shared Virtual Environments for Team Training

Benefit

Virtual environments have the potential to significantly enhance the training of NASA astronauts and ground-based personnel for a variety of activities. At the same time, this technology offers significant cost savings and increased training throughput. Following the successful use of virtual environments in preparing the flight team of the first Hubble Space Telescope (HST) repair and maintenance mission [STS-61; see R.B. Loftin and P.J. Kenney, "Training the Hubble Space Telescope Flight Team," *IEEE Computer Graphics & Applications*, Vol. 15, No. 5, pp. 31-37 (September, 1995).], attention has been focused on the use of shared virtual environments to support the training of teams of astronauts for the International Space Station. Such shared environments can be used for both mission planning and mission training, reducing the need for extensive travel.

Accomplishment

In 1995 the first shared virtual environment between the U.S. and Europe was demonstrated. Astronaut Bernard Harris (physically located in Building 12 at the Johnson Space Center) entered a virtual environment with Astronaut Ulf Merbold (physically located at the Fraunhofer Institute for Computer Graphics in Darmstadt, Germany). Their shared environment consisted of models of the Space Shuttle payload bay and the HST. The two astronauts spent over 30 minutes performing the major activities associated with the checkout of the HST's solar array drive electronics (SADE). Their work included the real-time hand-off of the replacement SADE in exchange for the original SADE. At the conclusion of the task the two astronauts shook hands and waved good-bye. This first experiment has been followed by investigations involving additional sites, more complex procedures, and alternative communication channels. Currently, a test bed between Houston and the NASA/Marshall Space Flight Center in Huntsville, Alabama, is in routine use to develop and test training approaches for operation and maintenance of the Biotechnology Facility (now operating in the *Mir* Space Station) within the International Space Station.

Background

Historically NASA has trained teams of astronauts by bringing them to the Johnson Space Center to undergo generic training followed by mission-specific training. This latter training begins after a crew has been selected for a mission and often begins as much as two years before launch. While some Space Shuttle flights have included an astronaut from a foreign country, the International Space Station will be consistently crewed by teams comprised of astronauts from two or more of the partner nations. As the task of training crews for the Space Station comes closer to realization, the cost, in terms of both travel and physical "wear and tear," appears ever larger. The Information Systems Directorate and the University of Houston, in cooperation with the Mission Operations Directorate, have been exploring virtual environment technology as a partial answer to the problem of helping international crews prepare for their missions. These explorations have been accomplished by generating duplicate graphical environments at each site (using Silicon Graphics Onyx Infinite Reality Engine workstations) and exchanging state change data (for example, the movement of one astronaut's hand or the translation of a suited astronaut to a new site) via a variety of communication channels [from a commercial Integrated Services Digital Network (ISDN) to ATM-based OC-3 networks].

For further technical information, contact Bob Savely at (281) 483-8105 or robert.t.savely1@jsc.nasa.gov

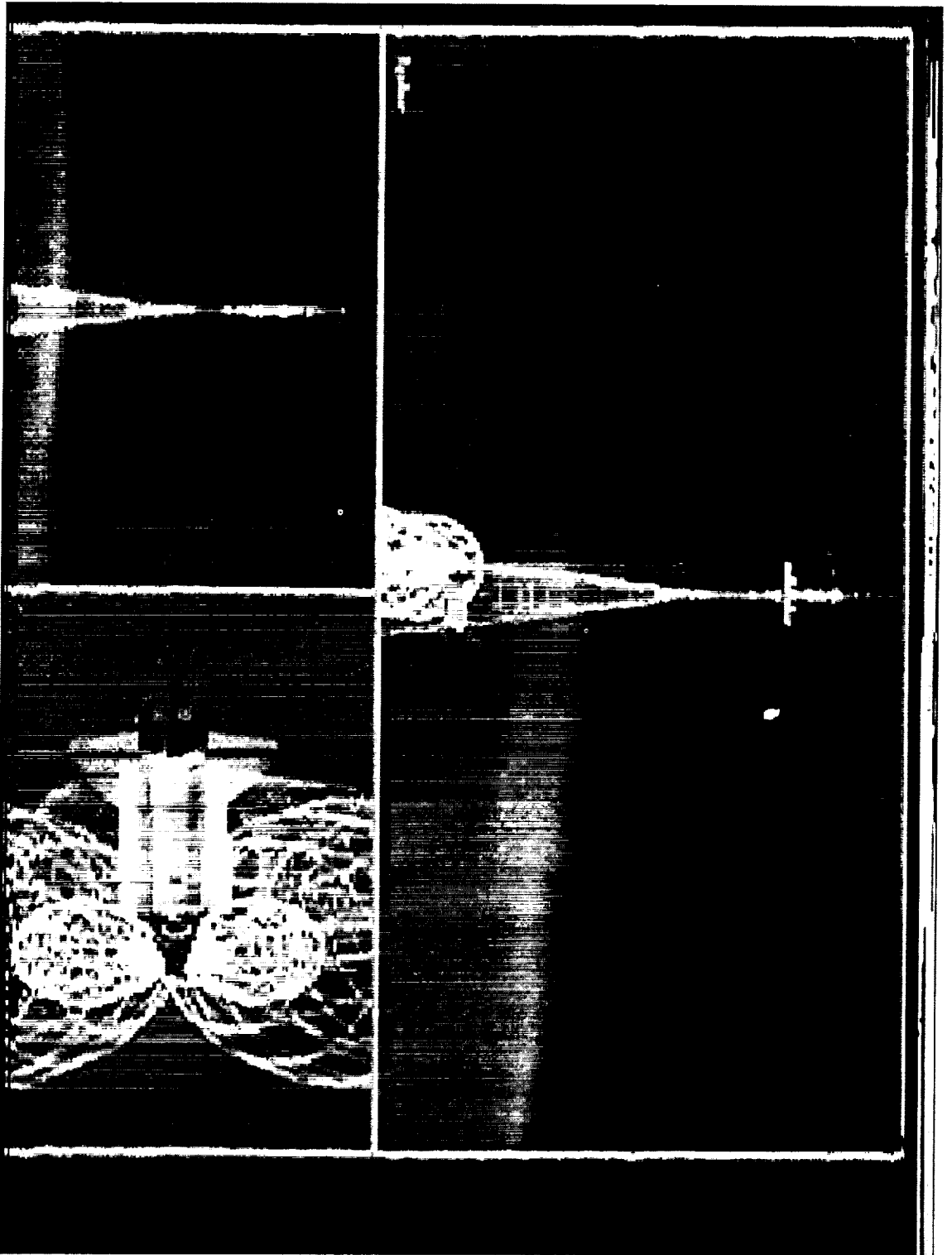

Visual Proximity Operations Processor (VPOP)

Visual Proximity Operations Processor (VPOP)

Benefit

The VPOP provides enhanced situational awareness to the Shuttle flight control team by converting downlisted telemetry into a 3D animation of Shuttle rendezvous and proximity operations activities. Hundreds of digital parameters from various sensors and effectors are combined with a high-fidelity environment model to produce a 3D reconstruction of the Shuttle motion relative to a free-flying target vehicle. This "virtual" space can be viewed from many perspectives, including crew out-the-window views, views from the target vehicle, as well as God's eye views. Trajectories based on the various available sensors can be quickly reconstructed and displayed on the large screen in the Flight Control Room for the team to see. As an added benefit, these images can also be broadcast on NASA TV as a Public Affairs tool.

Accomplishment

By utilizing existing software packages for data acquisition, data distribution, telemetry computation, and 3D scene animation, the required capability was delivered in less than one year from project inception at a cost that was less than projected. Over the last year, the tool has continued to be improved based on feedback from flight control personnel.

Background

During Shuttle proximity operations activities, the flight control team has historically relied on digital information to provide situational awareness and relative motion information. Visual information is further limited by the absence of downlink video. VPOP will enhance situational awareness with the addition of new views, better filtering of raw sensor data, and detection of Orbiter jet plume impingement. The system also provides the ability to animate relative motion based on ground tracking states and downlinked Global Positioning Satellite information.

For further technical information, contact Don Pearson at (281) 483-8052 or don.j.pearson1@jsc.nasa.gov

Test Bed to Study Electrohydrodynamic Heat Pipe Concept

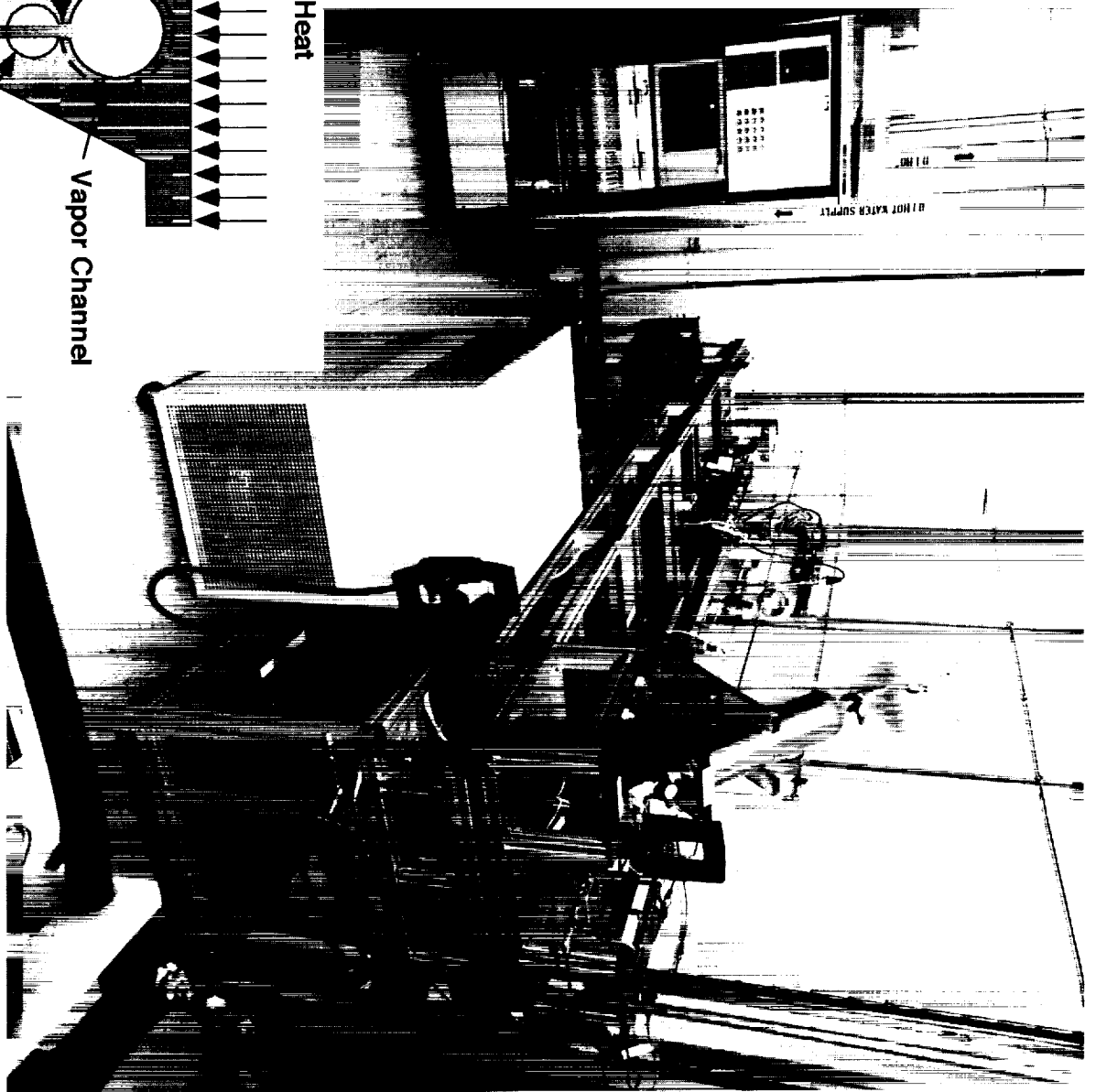
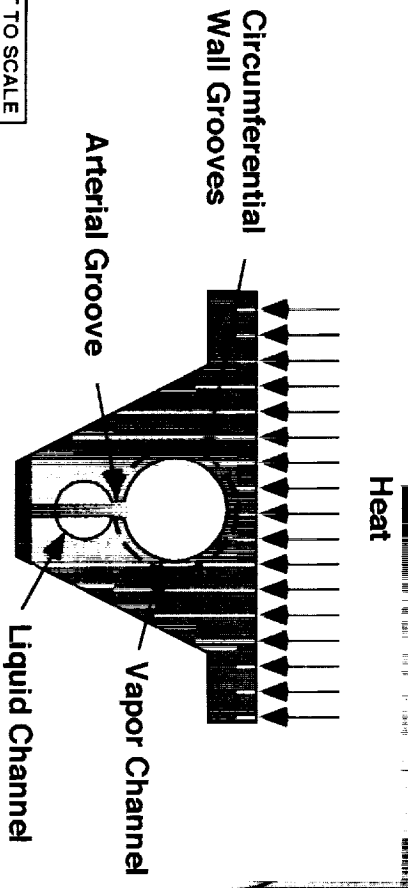

Electrohydrodynamic Heat Pipe Loop Studies

Benefit

An electrohydrodynamic heat pipe concept for use in the design of more efficient, lightweight radiators has potential applications in both aerospace and commercial systems. For spacecraft, the design can reduce the mass and power requirements of associated thermal systems. Earth applications of electrohydrodynamic technology include nonmechanical pumping systems for industries and utilities, and improved condensers for commercial cooling systems.

Accomplishment

A heat pipe has been fabricated that has vapor and liquid channels separated by a single arterial groove along the full length, as shown in the cross section at left. At the evaporator end, liquid is wicked from the liquid channel by the arterial groove and wall grooves on the circumference of the vapor channel. A thin liquid film then covers the vapor channel at the evaporator end, and the liquid vaporizes to gas when heat is applied. The pressure gradient generated in the channel forces the vapor to the cooler condenser end, where condensation forms a liquid film. The wall grooves and arterial gap at the condenser end then return liquid to the liquid channel. The heat pipe typically relies on capillary forces to return the condensate to the evaporator along the liquid channel, and then the process repeats. The electrohydrodynamic augmentation to the heat pipe includes the addition of an electrohydrodynamic pumping section between the evaporator and condenser ends to assist the condensate return to the evaporator.

A test bed was built for the heat pipe and its support equipment, which includes a power supply, instrumentation, fill system, and coolant loop for the condenser. The test bed was designed to allow the heat pipe to be tested at various inclination angles to assess the onset of dryout with increased flow resistance. Initial tests with electrohydrodynamic augmentation have produced an over 100% increase in the heat pipe transport capacity at various condenser environments. Instantaneous recovery of the heat pipe during dryout was demonstrated as well.

Background

The radiator subsystem, which rejects waste heat to space, usually makes up the largest mass of the thermal control system of human spacecraft. The Electrohydrodynamic Heat Pipe Loop Studies Program was initiated by the Johnson Space Center Crew and Thermal Systems Division to develop an efficient heat pipe radiator for space applications such as orbiting platforms and interplanetary vehicles. Electrohydrodynamic technology involves interactions of electric fields and free charges in a dielectric fluid medium to provide nonmechanical pumping. Program goals included applying electrohydrodynamic augmentation to increase the heat pipe transport capacity by at least 100%, to maintain peak performance during transients, and to reduce the overall heat pipe radiator weight by at least 30%. This radiator design also provides increased tolerance to micrometeoroids and orbital debris because heat is rejected individually by the surfaces of connected pipes, and the puncture of an individual pipe would not significantly diminish overall system performance.

For further technical information, contact Katy Hurlbert at (281) 483-4546 or kathryn.hurlbert1@jsc.nasa.gov



MECHANICAL/ELECTROCHEMICAL ASSEMBLY
ELECTROLYSIS PERFORMANCE IMPROVEMENT
CONCEPT STUDY
Life Systems, Inc.
CONTRACTOR CARD



**The Mechanical/Electrochemical
Assembly and Control/Monitor
Instrumentation**

Electrolysis Performance Improvement Concept Study (EPICS) Flight Experiment

Benefit

Onboard generation of oxygen is expected to reduce the annual resupply weight for the Space Station by approximately 5,455 kg (12,000 lbs) with an associated reduction in logistics costs. The objectives of the EPICS flight experiment are to demonstrate and validate the static feed electrolyzer operation in microgravity, and to investigate performance improvements possible in microgravity. If successful, the results of this Shuttle middeck experiment can be used to improve the static feed electrolyzer process efficiency for such activities as life support, propulsion, energy storage, and space manufacturing.

Accomplishment

Significant progress has been made on the development of the EPICS flight experiment. Developmental testing was conducted using an engineering model to verify key functional aspects of the EPICS design and provide engineering data to finalize the flight design. Based on the EPICS engineering model developmental testing, 21 changes were incorporated into the unit. The final design, fabrication, assembly, and ground testing were also completed. Then the experiment was certified for flight and flown on STS-69 in September 1995. Due to unanticipated shutdowns, however, only partial success was achieved. Changes were made before a reflight of the EPICS in 1997. Although not fully successful, the reflight did produce data for three full runs on one integrated electrolysis unit.

Background

A space environment is needed for this experiment because the static feed electrolyzer process has not been operated in microgravity, data on gas and liquid transport in microgravity are very limited, and one-g test results are compromised by buoyancy and gravity-affected fluid configuration within the electrolysis cells. A lower-cell voltage operation may result from microgravity effects on the distribution of liquid electrolyte, the gas/liquid interfaces with the cell, and the capillary forces on fluids within the pores of the electrodes and the electrolyte matrix.

The EPICS experiment will examine the effects of microgravity on electrolyte distribution in the static feed electrolyzer electrolyte retention matrix by determining performance characteristics of electrode/matrix assemblies that have different matrix thicknesses and electrode pore sizes and that operate at varying current densities.

The experimental hardware consists of a mechanical/electrochemical assembly and control/monitor instrumentation. The mechanical/electrochemical assembly is composed of three separate, self-contained, integrated electrolysis units, ancillary components, and the enclosure. Each integrated electrolysis unit is made up of an integrated electrolysis cell, a thermal control plate, and O₂ and H₂ accumulators. The integrated electrolysis cell consists of an electrolyzer cell core and a recombiner cell core (fuel cell concept) that enable the experiment to be self-contained. The control/monitor instrumentation controls the operation of the experiment via the mechanical/electrochemical assembly components and provides for monitoring and control of critical parameters and storage of experimental data.

The experiment is designed for independent operation because it requires only electrical energy and cabin air for cooling. The water supply for electrolysis will be self-contained in the experiment. The experiment is designed to be compatible with the weight, power, and heat rejection capability of two standard middeck locker spaces.

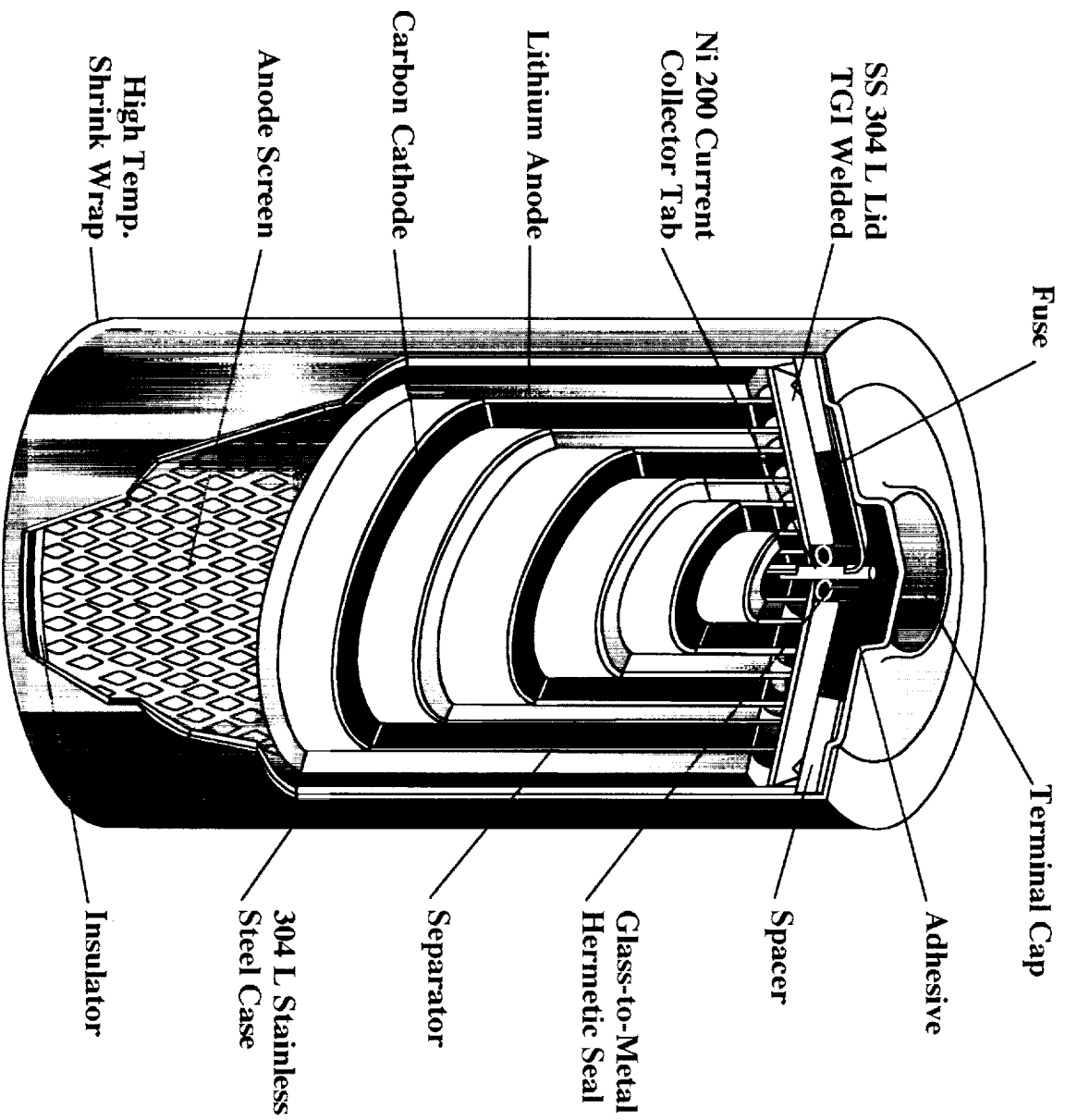

Wound Construction

from "Your Guide to Lithium Batteries,"
Electrochem Industries, New York

New Lithium-BCX D Cell Development for Flight Applications

Benefit

A new version of the lithium-BCX D cell is being developed for Space Shuttle applications. This cell will be safer for use in confined space, but will still meet current flight requirements and make possible many more onboard applications than are now allowed. A similar design approach shall also be used in the current flight lithium C cell, and in the soon-to-be-certified lithium DD cell used in the extravehicular mobility unit/personal life support system battery application.

Accomplishment

An improved electrolyte (BCX II) that uses a gallium salt in lieu of aluminum salt has been applied to Orbiter D cell batteries. This new salt, which reduces voltage delay, has already been incorporated into a flight-qualified C cell version of the universal configuration. In addition, a modification to the electrolyte in the form of lowered molarity will reduce short circuit hazard potential because it will not produce sufficient current on short circuits to raise a cell to hazardous temperature levels. Tests by the cell vendor, Wilson Greatbatch Limited, as well as at NASA in-house facilities, showed that electrolyte levels with a value of 0.4 molarity (rather than the previous value of 1.0 molar) give the optimum combination of reduced short circuit hazard potential while meeting the minimum capacity requirements of the D cell's 1-amp applications. On D cells ordered for NASA in-house tests, preliminary Wilson Greatbatch Limited tests revealed approximately 8 AH capacity (which is sufficient to meet all known applications), with the maximum temperature achieved on short circuits of ≤ 50 milliohms of less than 90°C. The basic cell design is tolerant to close to 150°C, either fresh or discharged. All this contributes to a projected tolerance to an internal cell short as well. This cell design in the D size is now certified for flight use.

Background

The current Orbiter lithium-BCX flight D cell configuration, qualified in 1988, was a modified, high-temperature-tolerant version of a hand-wound cell with an electrode area of approximately 125 cm² that was originally qualified in 1982. Since 1982, Wilson Greatbatch Limited has modified its product line to accommodate machine-wound cells of approximately twice the electrode area (thinner plates to facilitate machine winding), thus effecting a "universal" design approach for all cell sizes. The original philosophy in establishing the qualified configuration of the lithium-BCX D cell was to stay as close as possible to the vendor's commercial product in design, manufacturing processes, quality control, and use experience, thus increasing the availability of and confidence in the cell for flight use. But as the vendor's product line evolved, adhering to the original cell configuration became more difficult, and in fact confidence in and availability of the cells decreased. Thus it became necessary to requalify the cell configuration to realign the NASA flight configuration more closely with the Wilson Greatbatch Limited universal product. The problems of simply using the commercial version of the D cell are: 1) The BCX I electrolyte is more subject to passivation, or voltage delay, under conditions of long, open circuit voltage storage and at higher loads; and 2) The increased electrode plate area results in a cell with greater rate capability, which also increases inherent short circuit hazard potential.

For further technical information, contact Bobby Bragg at (281) 483-9060 or bobby.j.bragg1@jsc.nasa.gov

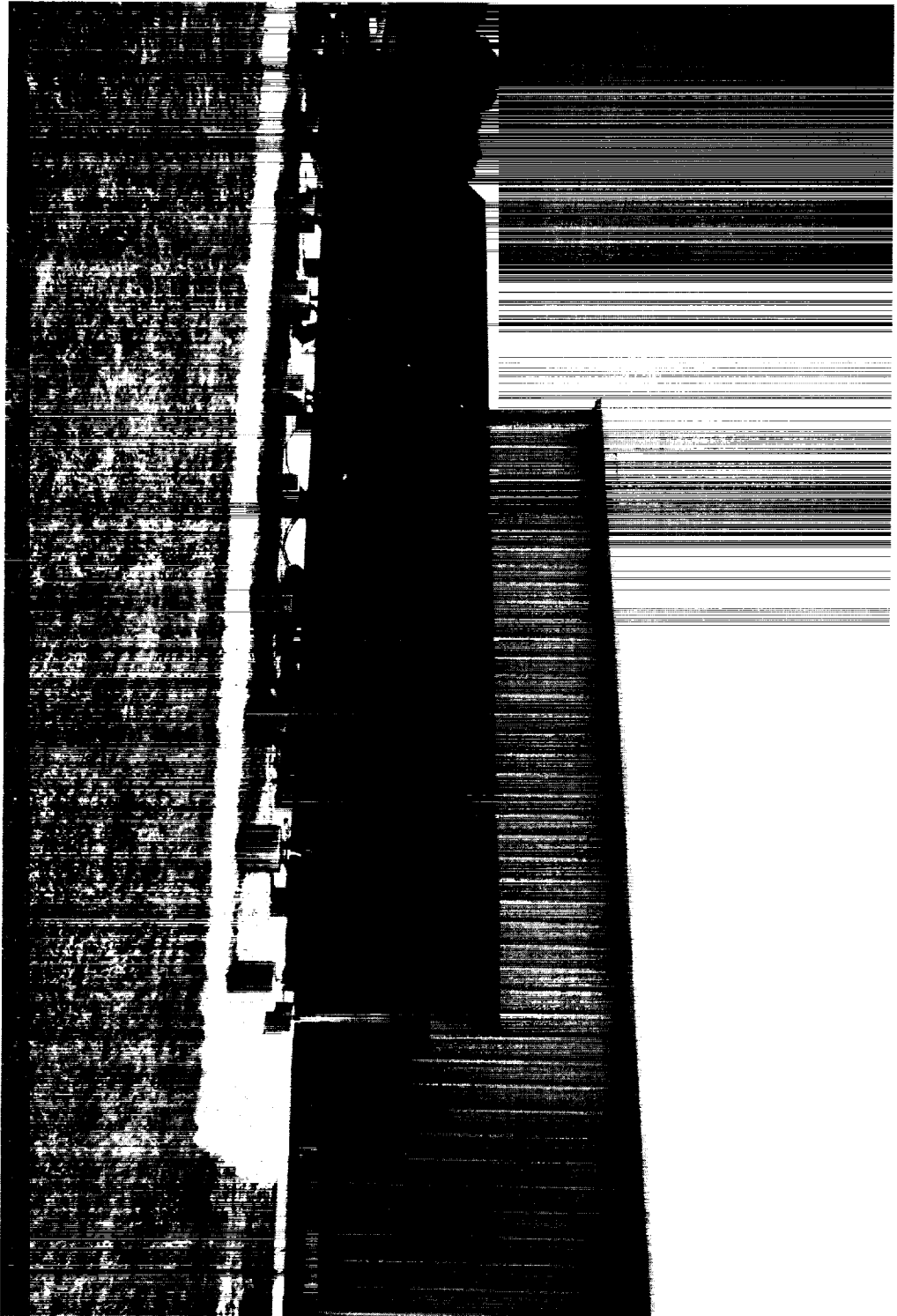

Solar Photovoltaic Array

Solar Heat Pump Development

Benefit

Solar energy technology, long recognized as environmentally benign, has practical applications in both aerospace and earth-based energy systems. Solar heat pumps can significantly reduce the mass of thermal control systems on spacecraft for future human missions such as a lunar or Mars base habitat. On Earth, solar heat pumps are promising for a variety of cooling applications such as refrigeration in remote locations.

Accomplishment

A NASA site was one of five test sites in the United States chosen as part of the recently completed Electric Power Research Institute Solar Photovoltaic Heat Pump Project. A solar photovoltaic-powered vapor compression cycle heat pump was installed in the Johnson Space Center Advanced Life Support Laboratory to provide partial cooling. The equipment consisted of a 3 kW Solarex photovoltaic (PV) array, a 5-ton-capacity Trane variable-speed heat pump, and power electronics which coupled the first two and controlled the system. The transition between PV and building-supplied backup power was smooth, even on partly cloudy days. One hundred percent solar operation of the heat pump compressor was successfully demonstrated. Of the five test sites, the NASA site had the best coincidence between the solar energy resource and the heat pump energy demand. A reduction in heat pump energy demand from Houston Lighting & Power Company during peak time periods was also demonstrated, especially when the PV heat pump was used in conjunction with a programmable set-back thermostat. The Crew and Thermal Systems Division has completed the conceptual design of a lunar base solar PV heat pump using a similar arrangement to reduce power system mass by 43% through direct coupling to the heat pump.

Testing is under way on three smaller-scale solar heat pumps in a solar PV refrigerator application. Thermoelectric, Stirling, and vapor compression heat pumps are being tested (one at a time) in the same super-insulated refrigerator cabinet. The work is being done through a Space Act Agreement between Johnson Space Center and Oceanering Space Systems. Besides the space application for the advanced refrigerators, there is a vast commercial potential for solar refrigeration in parts of the world which do not have electricity. Each of the three heat pumps will be run in a mode where they are directly connected to the solar PV panel without batteries. Instead, the refrigerators will rely on thermal energy storage to stay cold during the night and cloudy days.

Background

Thermal control systems require significant mass and volume resources. In most cases, thermal radiators, which dissipate waste heat to space, make up about half of the system's mass. In a lunar base located at a moderate latitude, radiators cannot dissipate the heat by direct radiation to space during the hottest part of the day because the lunar surface temperature is so high. On Earth, air conditioners are used to solve the same problem. On the moon, a heat pump can be used to raise the radiator temperature to a level that makes direct radiation possible. For both a lunar base and many Earth applications, solar energy is a good power source because it is most available at midday when the heat pump is required the most. Johnson Space Center and several industry partners are cooperating to develop highly efficient solar heat pumps that combine the thermal control and power control subsystems to solve various problems.

For further technical information, contact Mike Ewert at (281) 483-9134 or michael.k.ewert1@jsc.nasa.gov

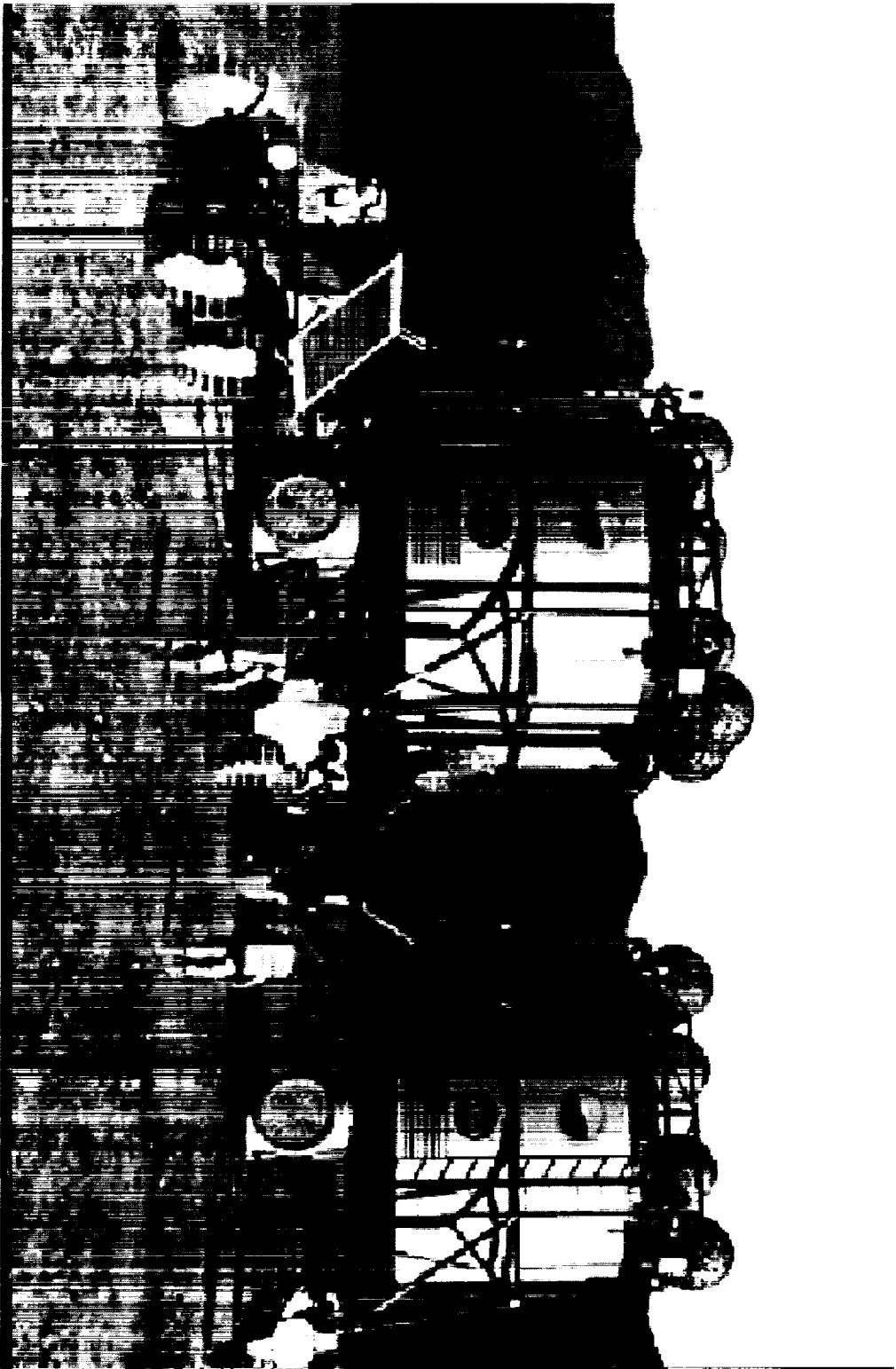

Advanced Technology Space Suit

Advanced Technology Space Suit

Benefit

As we prepare to embark upon planetary exploration, the present shuttle/station space suit will be ineffective for the forecasted conditions of the Moon or Mars. The present suit is for zero-G and is not intended for walking on rough rocky surfaces. The outer thermal protection garment will work in the vacuum of the moon, but will not work in the low-pressure atmosphere of Mars. The high dust environments of the Moon and Mars will require new hardware, methods, and techniques to keep the dust out of the bearings and attachment mechanisms. For this reason, a new outer dust-resistant covering will need to be developed.

The life support systems will also need to be changed. The sublimator cooling system will not work on Mars. For such long missions, system reliability and robustness must be increased. Also, astronaut maintenance capability must be incorporated and a modular portable life support system must be developed.

New technologies in both the pressurized garment and life support must be incorporated to lower both the initial cost and the operating cost of extravehicular activity (EVA) systems. Additionally, a decrease in the overall system weight will enhance the increase in EVAs expected for exploration activities.

Accomplishment

The overall goal of this project is to perform a human test of a new bottoms-up space suit development in a thermal vacuum environment in the year 2000. The first step is to develop laboratory table top layouts of the various support loops. Once the details of component operation and technology have been verified, a major design effort will miniaturize and package these systems for maintenance. These subsystems will be tested, optimized, and mated with the other subsystems for an integrated test with a person.

Background

As exploration begins to shift from a zero-G operation to a planetary walking focus, it will shift from an activity where EVAs are done approximately twice a year to one where they are done every other day. Maintenance on EVA will shift from a highly trained technician and engineering team on the ground, to an astronaut caring for his own space suit prior to use. Instead of every EVA being choreographed prior to execution, a rich electronic sensing and learning environment must be available to the astronaut to help him deal with any situation real-time and without ground support.

For further technical information, contact Mike Lawson at (281) 483-9124 or b.m.lawson1@jsc.nasa.gov

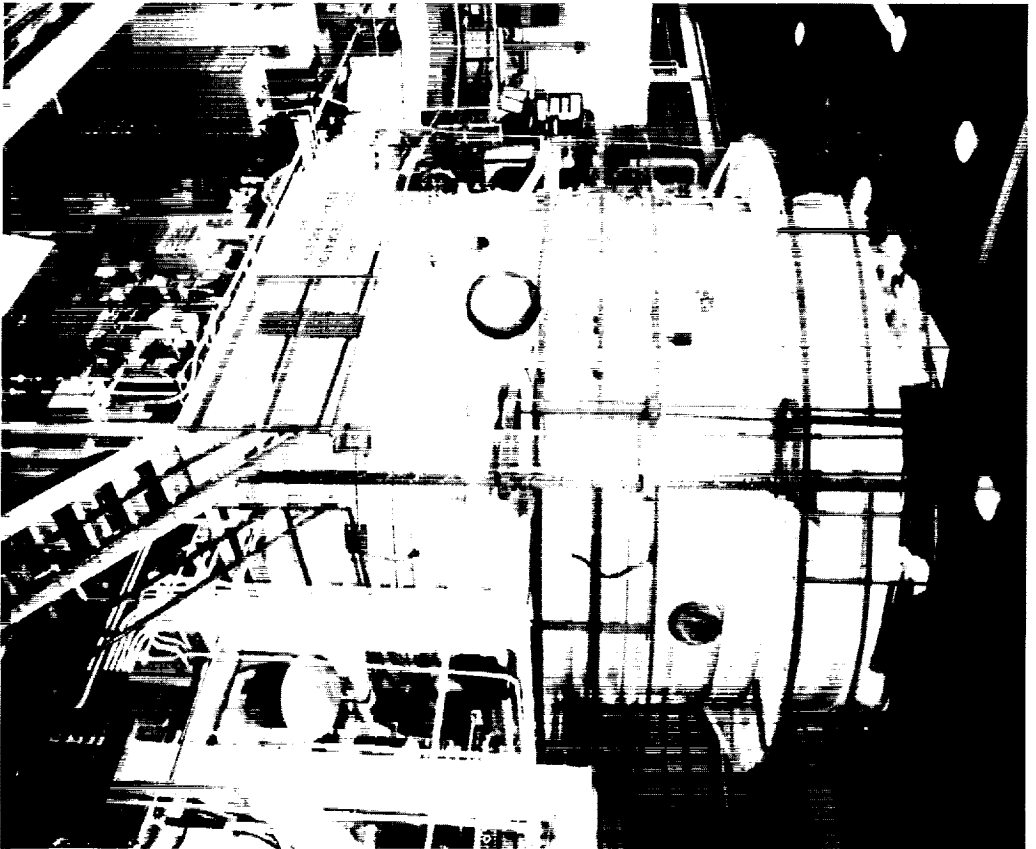

JSC Life Support Systems Integration Facility



Test Subject Tending Plants

Lunar-Mars Life Support Test Project

Benefit

In the process of developing life support self-sufficiency for human beings, researchers at Johnson Space Center (JSC) are discovering improved technologies for air revitalization, water recovery, and thermal control. Improved technologies in any of these areas of regenerative life support systems will have a wide range of applications for government and industry alike.

Accomplishment

Future long-duration crewed space missions will require life support systems which use integrated biological and physicochemical processes to provide an efficient, robust, and reliable life support capability with a minimal need for resupply. To help meet this need, JSC has implemented a coordinated plan that will perform the necessary research, technology development, integration, and verification of regenerative life support technologies to provide safe, reliable, and self-sufficient human life support systems. Researchers at JSC initiated the Early Human Testing Initiative project, renamed in 1997 the Lunar-Mars Life Support Test Project (LMLSTP), to investigate the performance characteristics of these integrated systems using human test subjects in a controlled environment ground test facility.

Background

The LMLSTP consists of a series of four advanced life support systems tests with human test subjects. Tests will be conducted using both physicochemical and biological systems and will involve crews of one to four test subjects for 15 to 90 days. These tests, scheduled through 1997, are:

- A 15-day regenerative life support systems test in JSC's Variable Pressure Growth Chamber with one human test subject. This test began July 24, 1995, and was completed on August 8, 1995. The chamber was used principally to verify performance of biological air revitalization life support systems (using higher plants) with physicochemical subsystems as backups.
- A 30-day regenerative life support systems test in JSC's Life Support Systems Integration Facility with four test subjects. The test began June 12, 1996, and was completed on July 12, 1996. This facility was used to verify performance of integrated physicochemical life support systems for air revitalization, water recovery, and thermal control.
- A 60-day regenerative live support systems test in the Life Support Systems Integration Facility with four test subjects. This test began on January 13, 1997 and was completed on March 13, 1997. The existing physicochemical life support systems were augmented with selected representative Space Station life support components to provide baseline performance information.
- A 90-day regenerative life support systems test in the Life Support Systems Integration Facility with four test subjects in combination with the Variable Pressure Growth Chamber. This test began September 19, 1997 and will be completed on December 19. The facilities will be integrated and used in tandem to verify performance of biological (i.e., higher plant) and physicochemical air revitalization functions. Incorporation of microbial bioreactor technology for water recovery and incineration technology for solid waste processing is also scheduled for this test.

Over the next two fiscal years, continued efforts with the LMLSTP will increase the technical base needed for developing integrated life support systems and testing such systems with humans.

For further technical information, contact Trish Petete at (281) 483-2834 or patricia.petete1@jsc.nasa.gov

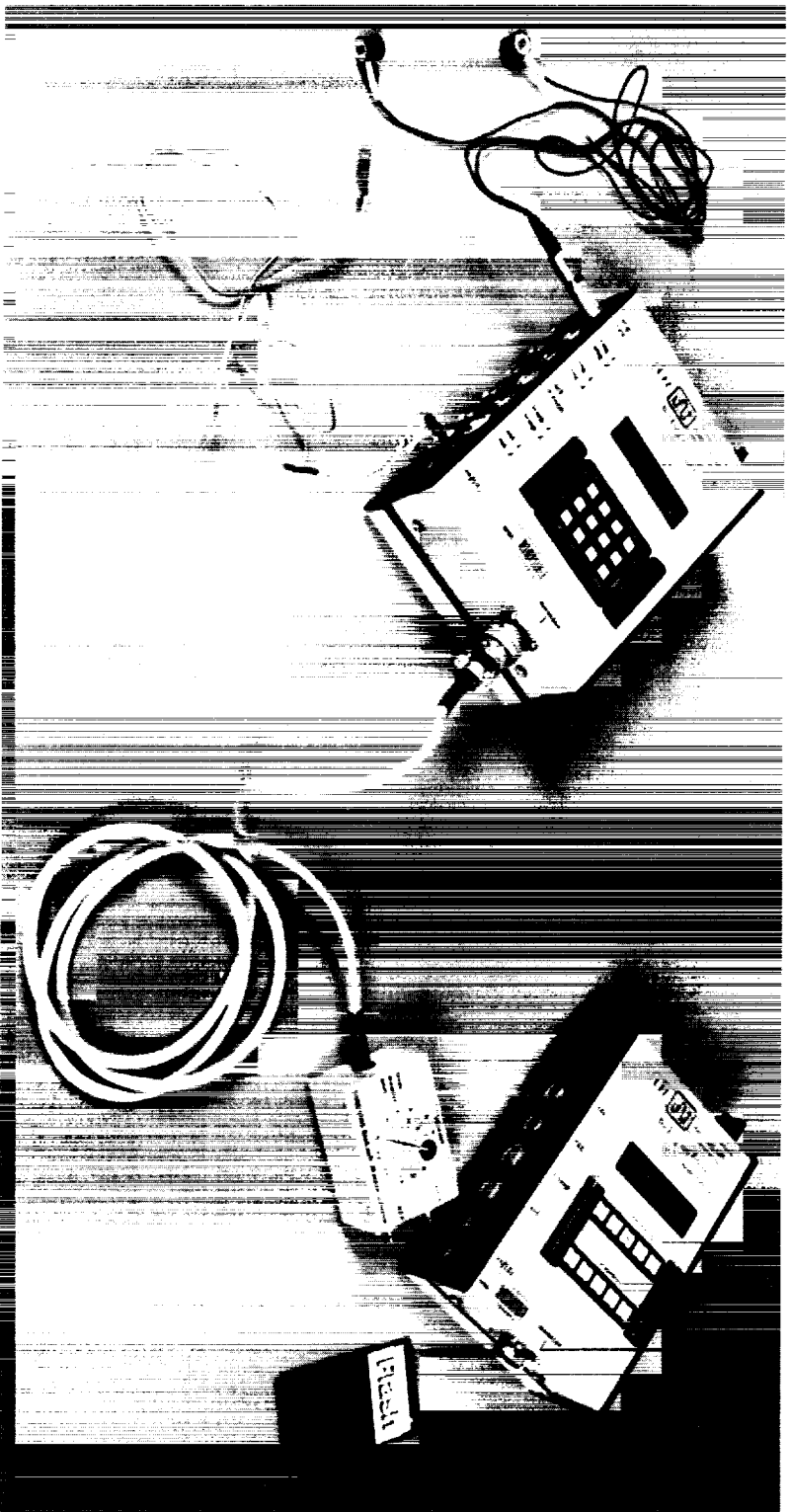

Biolog With FETRODES

For further technical information, contact Deborah Harm
at (281) 483-7222 or deborah.l.harm1@jsc.nasa.gov

BioLog With FETRODES

Benefit

For space travelers and others whose work makes them susceptible to long periods of motion sickness, understanding the physiologic mechanisms underlying motion sickness symptoms is essential for the development of effective and timely countermeasures. Time spent in space is very valuable. Decreased productivity for astronauts is a costly consequence of motion sickness. Researchers at Johnson Space Center are using physiologic measures of motion sickness as objective indicators of symptom severity and occurrence, and as clues to understanding the physiologic mechanisms involved in the development and resolution of symptoms. Electrogastrography and the frequency components of cardiac interbeat intervals are two noninvasive physiological variables which may be useful indicators of the development of motion sickness symptoms and changes in autonomic nervous system activity associated with motion sickness. Since absorption of oral drugs may be reduced under conditions of abnormal gastric activity, information on gastric activity on orbit is important to optimize the in-flight administration of oral medications. Understanding changes in nutrient absorption will be important for long-duration missions.

Accomplishment

Reduced gastric motility has long been recognized as a characteristic of acute motion sickness, and gastric stasis appears to accompany space motion sickness. In a spaceflight study, bowel sounds were found to be greatly decreased or absent in subjects experiencing motion sickness symptoms. One limitation of this study was the inability to time-lock events—such as eating, drinking, or motion sickness symptoms—to the data, so only general documentation of conditions was possible. Determining exactly where a symptom is reported in relation to the data is essential because changes in gastric frequency/amplitude have been noted prior to conscious awareness of symptoms.

Researchers needed a system which could provide continuous, quality data recording in ambulatory subjects for the first several days of flight and time-locking of symptom reports and other events to the data. NASA contracted the developers of FETRODES, snap-on converter assemblies which consist of a temperature-compensated amplifier that has an extremely high input impedance and a very low output impedance, to develop a digital data logger incorporating this same technology. They developed BioLog with FETRODES, an ambulatory physiological data recorder for assessment of autonomic and gastric function. The FETRODES circuitry is built into a tiny enclosure which snaps onto any disposable electrode. Amplification of the electrogastrographic signal at the source greatly increases the signal-to-noise ratio, making ambulatory recording of the electrogastrogram possible. The developers, UFI, customized a system to supply both electrogastrographic and electrocardiographic data in a single channel.

Background

Electrogastrography is a noninvasive technique that uses surface electrodes to record myoelectric activity of the stomach. Both the frequency and amplitude of the electrogastrogram has been shown to be affected by motion sickness symptoms. Data are stored on a static random access memory card only slightly thicker than a standard credit card. The BioLog unit uses 1- or 2-megabyte cards interchangeably. A 2-megabyte card can store 48 hours of data. A 3-V lithium coin battery maintains data on the card for up to one year even when the equipment is powered off. Data are downloaded from the card to a personal computer that is connected to the parallel port of the computer. The entire contents of a 2-megabyte random access memory card can be downloaded to a binary file in fewer than five minutes. The BioLog is small and lightweight and, using a custom-designed pocket, can be either belt-mounted or attached to a subject's clothing with Velcro. The unit is easily operated. It produced data of exceptional signal quality when flown aboard STS-60.

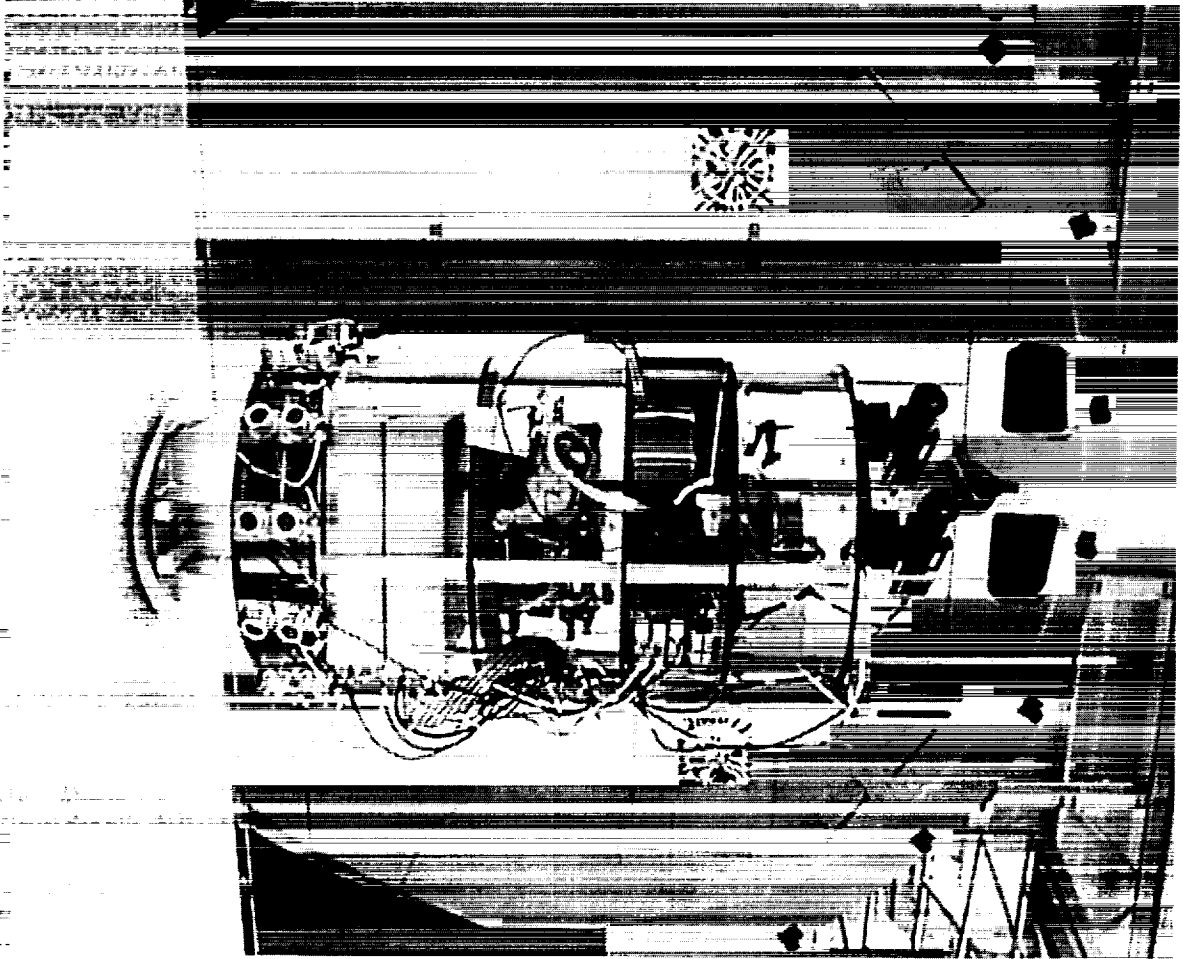

Robotic Free-Flying Camera

Autonomous Extravehicular Robotic Camera (AERCam) II Integrated Ground Demonstration

Benefit

External views of the Space Shuttle, International Space Station (ISS) and future Lunar-Mars transfer vehicles are needed to assist onboard crews and ground flight controllers in performing visual inspection associated with assembly, maintenance and servicing tasks. To Related *non-visual* inspection requirements are expected to include hydrazine sensing, vibration measurement, and ammonia leak detection. To address these needs, the JSC Automation, Robotics and Simulation Division is developing a free-flying camera and sensor platform: The AERCam is a low-volume, low-mass free-flyer that is not subject to the limitations of fixed cameras, manipulator-based cameras, or extravehicular activity (EVA) crew accommodations. AERCam will exploit its high level of system intelligence to minimize crew workload associated with inspection tasks. It will have the capability to:

- Provide EVA camera views unobtainable by any other means.
- Fly autonomously to a commanded location (such as a desired viewing position for a point of interest).
- Conduct autonomous search patterns for visual or non-visual inspections.
- Intelligently screen inspection data to determine if further human analysis is required.
- Stationkeep to an EVA astronaut to send camera views of EVA activities back to the intravehicular activity (IVA) crew and ground controllers.

Accomplishment

To achieve the final configuration, the AERCam project was divided into 3 development phases. The first two phases are ongoing:

- AERCam I, called Sprint, is teleoperated with hand controllers by an IVA crew member. Video from cameras onboard the Sprint platform will be sent to the IVA crew and ground controllers. Sprint is manifested to fly in November 1997 on STS-87 as an ISS Risk Mitigation Experiment.
- AERCam II automates the guidance, navigation, control, stationkeeping, and inspection functions, allowing the operator to issue task level commands. An Integrated Ground Demonstration (IGD) is planned for October 1997. The hardware of the IGD unit will then be redesigned and repackaged with an emphasis on miniaturization for a Shuttle flight experiment.

Background

The ISS Program has requested that the Sprint be flown as an ISS Risk Mitigation Experiment, and has developed an Experiment Integration Plan identifying the Human Exploration and Development of Space Program need for "generic functional support for enhanced viewing." AERCam II/III springboard from Sprint to meet longer-term ISS enhancement needs described in Space Station Program document SSP 50198, "Space Station Requirements for Advanced Engineering and Technology Development (AETD)." The AETD goals addressed by AERCam are: Reduce crew EVA time by 50% for maintenance tasks and visual inspection, develop and integrate autonomous inspection technologies and improve viewing capabilities, improve autonomous control algorithms to provide capability to handle planned tasks and flexibility to accomplish unplanned tasks, enhance interfaces to reduce routine task time and complexity, and develop technology that targets human involvement with the robot at a high level, with the long-term aim of developing a totally autonomous robotic system.

Sprint - Free-Flying Camera Platform

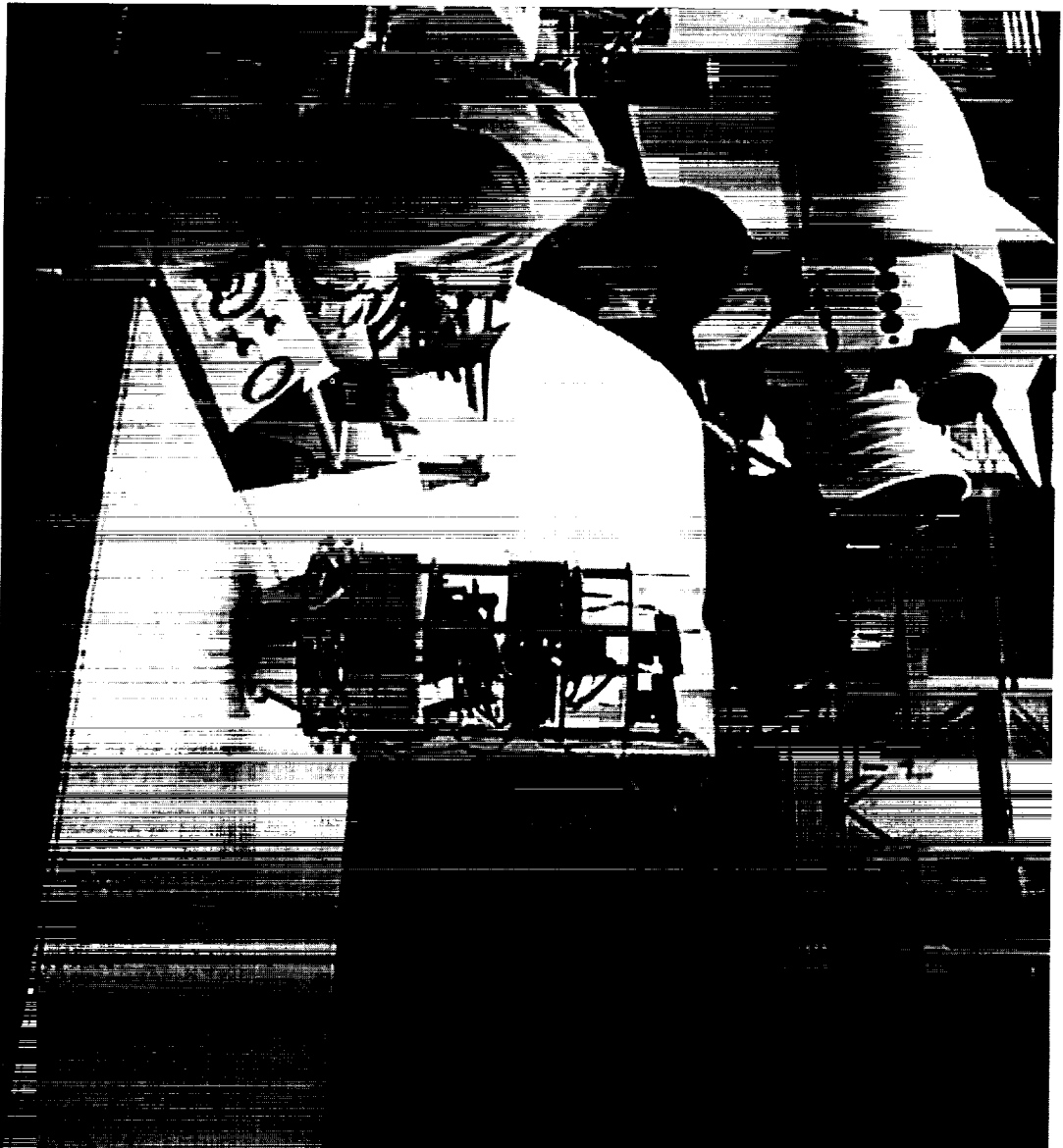

Autonomous Extravehicular Robotic Camera (AERCam) Sprint

Benefit

Adequate views that allow Orbiter intravehicular activity (IVA) crews to observe extravehicular activities (EVAs), inspect a location without an EVA, or view locations not visible by an EVA crew member or remote manipulator system camera from available cameras can be difficult if not impossible to obtain. The International Space Station (ISS) camera views are even more restricted due to the much larger structure that has to be viewed. In addition, the number of locations without camera coverage is greater. A camera that has the capability to be positioned without major impact to the actual design of the Orbiter or ISS would prove to be extremely useful to obtain these views. Such a camera has been constructed and is called Sprint.

The Sprint is the first in a series of AERCams. Sprint is intended to be only a small teleoperated camera platform, where future AERCams will be developed with more capability, range, and lifetime. The purpose of Sprint is to demonstrate that a free-flying camera platform can be designed to augment on-orbit operations. The objectives are:

- Provide the opportunity to examine the utility of a free-flying camera in close proximity to a spacecraft and EVA crew.
- Provide a basic set of required capabilities for a free-flying camera as a development version of a future operational vehicle that would be used on orbit by either the Orbiter or ISS.

This device can be used to directly support an EVA by giving IVA crew members the ability to freely move their eyepoint independent of cameras attached to the shuttle or the EVA crew. A production version of the Sprint could be used for inspection either as a precursor to an EVA, to provide support during an EVA, or in lieu of an EVA.

Accomplishment

The AERCam Sprint free-flyer:

- Is a small, safe, unobtrusive, free-flying camera platform for use outside a spacecraft.
- Has a self-contained propulsion system, giving it the capability to be propelled with six degrees of freedom.
- Has an automatic attitude hold capability.
- Is a slowly moving (~0.25 fps) spherical vehicle, covered in a soft, cushioned material to prevent damage in the event of an impact.
- Is controlled from inside the cabin by an operator using a small control station.

The operator will input motion commands from a hand controller. The commands will be sent from the control station to the free-flyer via an r.f. link. Data from the free-flyer will be sent to the control station with information regarding the free-flyer's health, consumables, etc. The video will come from either of two cameras with different lenses transmitted by radio signal. The video signal will be received via the extravehicular mobility unit TV receiver and displayed on a laptop computer with video display capability. When operating, the video can be displayed on either the Sprint video monitor or on the standard Orbiter monitors. The data and video will be sent to the ground for viewing there. All video and data will be recorded on orbit as well as on the ground.

Background

The Sprint is the first in the AERCam series of robotic EVA tools designed to aid or enhance on-orbit EVA operations. Future robotic devices in the series will become more autonomous and intelligent, with much more capability. This will allow the robot to perform tasks without constant monitoring from a crew member. ISS will realize the greatest benefit from these tools in that they will decrease the amount of mundane EVA maintenance tasks that must be performed, and aid in those that are. The Sprint was proposed in the spring of 1995 and funded by NASA Headquarters Code X (now Code M) for FY96. Sprint is manifested on STS-87, scheduled to launch in November 1997.

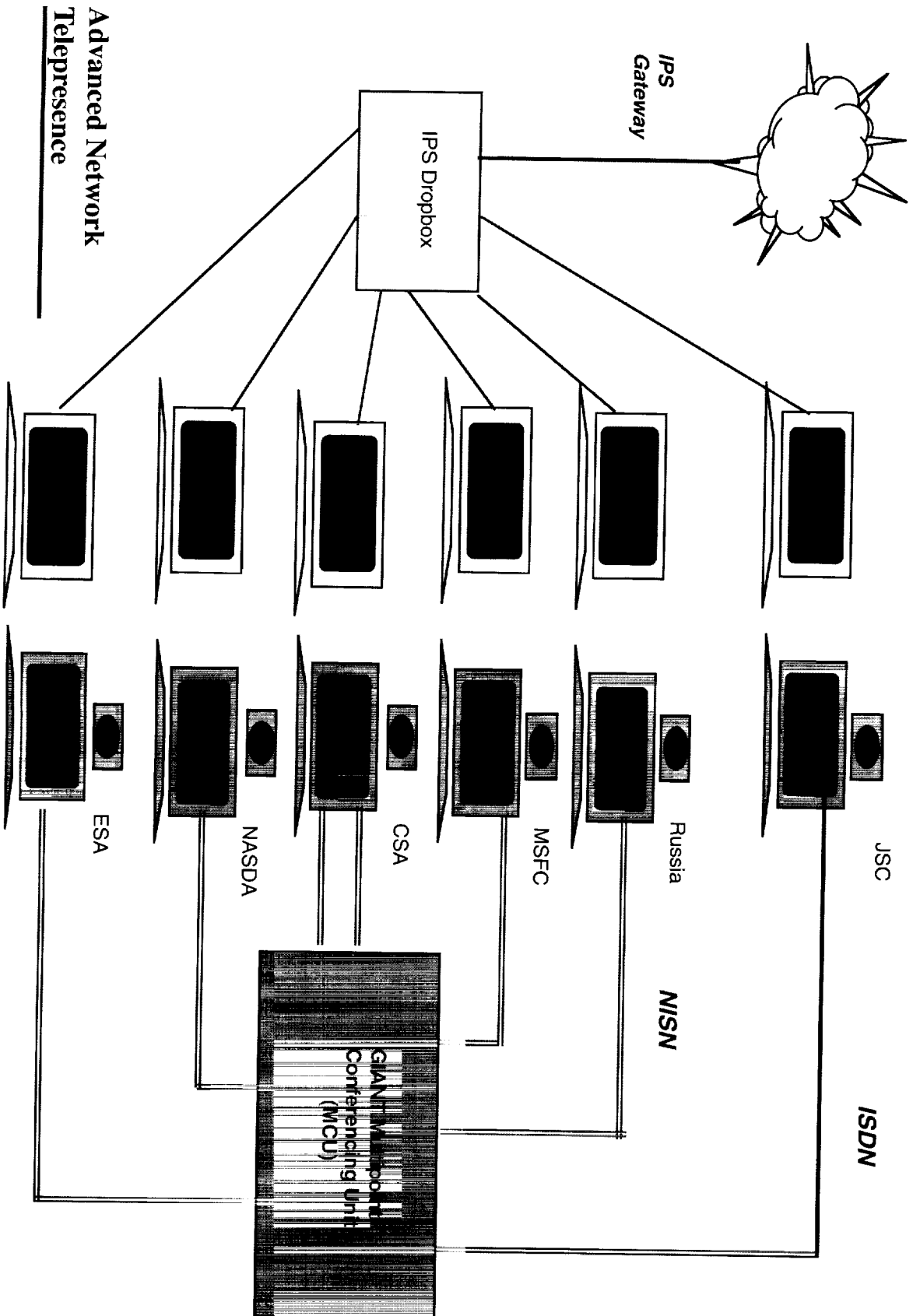

Globally Interconnected Advanced Network Telepresence (GIANT)

Benefit

The GIANT implements enabling technology for Space Station distributed planning. It will prototype telepresence—videoconferencing, electronic whiteboard, data distribution, and application sharing—in support of the globally dispersed systems and payload planners for on-orbit Space Station operations. Reduced manpower, continuous operations and extremely shortened process times for completing weekly plans demand the efficiency and productivity improvements offered by these emerging technologies. GIANT will deploy an Initial Operational Capability by the end of fiscal year 1998 both to support early Station operations and to verify concepts and hardware/software suites needed for a Full Operational Capability.

Accomplishment

A task agreement has been negotiated with Jet Propulsion Laboratory's Multimedia Lab for architecture consulting, and systems engineering/integration. Evaluation of 3 leading commercial off-the-shelf systems has been completed, and an initial buy of 4 systems will be submitted for approval by mid-August. GIANT is establishing the charter prototype capability for the newly formed Johnson Space Center Collaborative Environment User's Group.

Background

Manpower and travel cuts demand that new ways be found to accomplish the Station mission. Telepresence offers alternatives to physical meetings (too expensive) and audio-only (inadequate). Telepresence concepts are particularly cost-effective in terms of investment (\$5K for desktop tools vs. \$50K for VITS rooms) and operation (\$120/hour vs. \$1000/hour), as well as eliminating time lost while traveling. The GIANT project integrates emerging technologies to provide a mission capability.

For further technical information, contact Bruce Hilty at (281) 483-1932

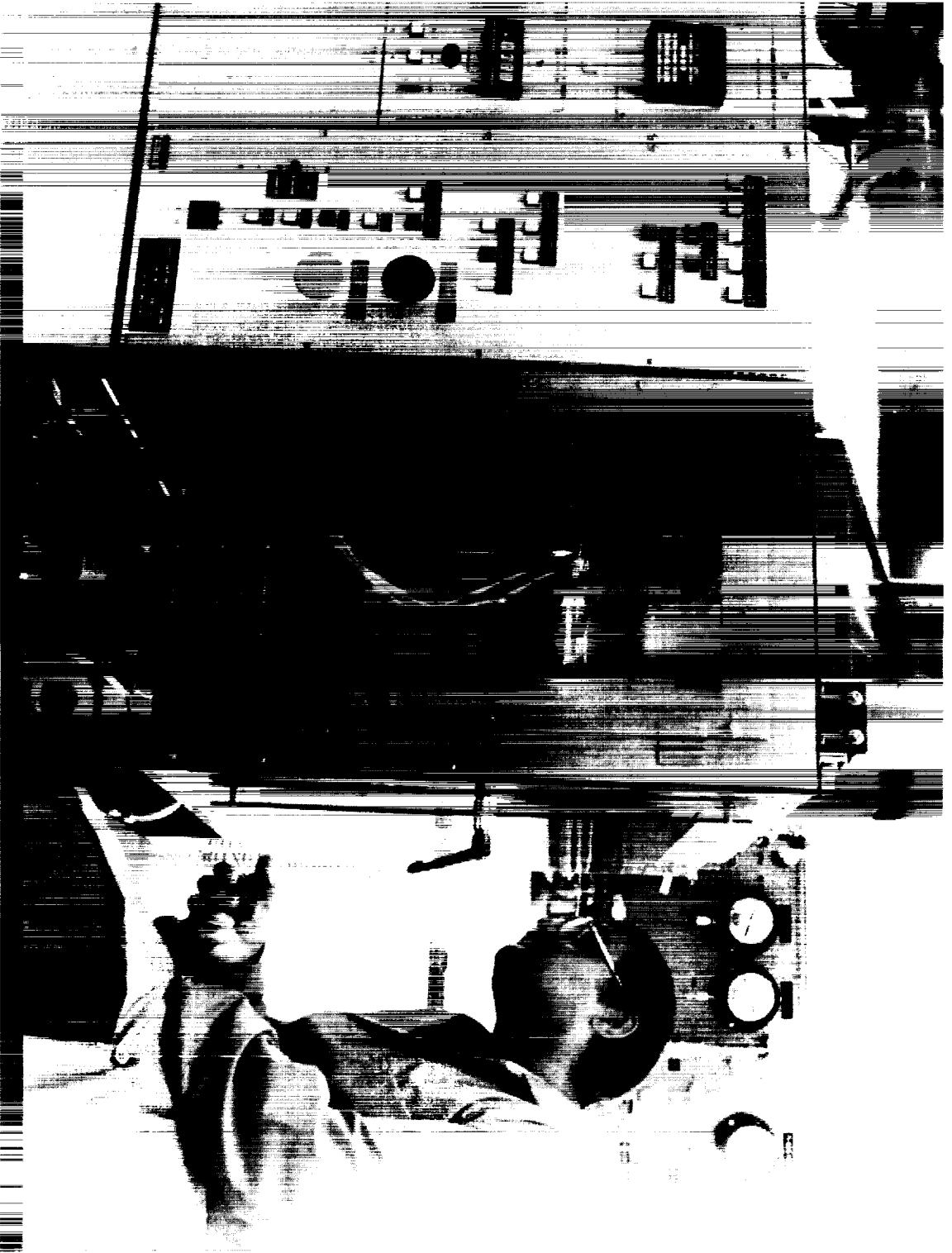

Controlled Environment Cone Calorimeter

Flammability Testing of Composites Using Cone Calorimetry

Benefit

During combustion, oxygen depletion occurs in confined spaces such as building fires. The controlled-environment cone calorimeter provides a unique capability by allowing evaluation of fire parameters under oxygen-depleted conditions of ground fires and under oxygen-enriched environments encountered in spacecraft environments. The comprehensive data acquired with this apparatus provides the majority of fire parameters used for modeling, allowing for future fire-safe designs.

Accomplishment

Fully developed fires were simulated for composites. The controlled-atmosphere cone calorimeter test showed that phenolic composites had the lowest ignitability, peak heat release rate, propensity to flashback, and smoke production rate among the composites evaluated (flame-retarded epoxy composites and phenolic composites containing fiberglass, aramid, and graphite fiber-reinforcements). Phenolic/graphite showed the highest flame resistance.

Background

A commercially available cone calorimeter was modified to allow testing in oxygen concentrations from 0% to 50%. The cone calorimeter test measures the ignitability, heat release rate, total heat released, effective heat of combustion, specific extinction area, soot yield, mass loss rate, and the evolution of CO, CO₂, and other combustion products. In the controlled-atmosphere cone calorimeter, the sample is exposed to a specific incident heat flux in a horizontal or vertical orientation and burns in a controlled oxygen environment. The inflow combustion gas is provided by mixing oxygen and nitrogen at different ratios. The heat release rate during combustion, which is generally considered to be one of the most important fire properties of materials, is measured by using the oxygen-consumption principle. The principle depends on the fact that the heat of combustion of most organic materials per unit mass of oxygen consumed is essentially constant and has an average value of 13.1 MJ/kg. The mass loss rate is measured using a load cell, and the specific extinction area is measured using a helium-neon laser. The CO and CO₂ yield during combustion is determined by a CO/CO₂ analyzer.

For further technical information, contact Harry Johnson at (505) 524-5722 or harry.p.johnson1@wsf.nasa.gov



Closed-Loop Test Configuration to Measure Velocity Rates

Fluid Flow Measurements Using Series Probes

Benefit

These probes have demonstrated an ability to measure volume fractions, fluid velocities, slug passage, slug lengths, bubble passage, and bubble size. They show promise of working effectively on the expected flow regimes in an oil well line. Potentially, the probes could have many useful applications in industries ranging from aerospace to oil and gas.

Accomplishment

There are many potential applications for probes of this type in industry and government. Possible aerospace applications include measurements of helium/hydrazine flow during rocket tests at White Sands Test Facility, liquid/gas flow in hydrogen or oxygen lines in Orbiter engines, and liquid/gaseous Freon flow in zero-g tests with the KC-135 aircraft at the Johnson Space Center. Oil industry representatives have expressed interest in the probes as a potential method of measuring the fraction and velocity of oil, water, and natural gas flowing in a pipeline, and for monitoring the oil contamination (traces) in water for environmental compliance.

This technique has other potential space applications in measuring the flow of liquid and gaseous oxygen or hydrogen under zero-g conditions within the Space Station. It also has ground-based applications in measuring gas-water-oil flow from undersea oil wells as well as other possible uses in measuring volume fractions and the velocity of multiple liquids having different dielectric constants. A patent (5675259) was issued on 10/7/97

Background

These probes were developed to help measure the volume fraction of two or more fluids flowing through a pipe or mixing in a reservoir. Each probe measures the instantaneous complex dielectric constant of the fluid in intermediate proximity. As long as separation of the complex dielectric constants of each fluid is possible, several or even many fluids can be identified and measured in the same flow stream or reservoir. By using multiple probes, the velocity of each fluid as well as the distribution of each constituent can generally be determined. Computations are made from data streams taken by each probe. The closed-loop test configuration used to measure the velocity rates of slug flow and homogeneous flow for mixtures of oil, water, and air (gas) is pictured opposite.

The catalyst for the development of a radio frequency/microwave technique for measuring two-phase flow was a need to monitor the flow of monomethyl hydrazine and helium through an inlet pipe of a reaction control system at the White Sands Test Facility. The relative amounts of helium and hydrazine flowing into the thruster jet could not be instantaneously measured. Researchers realized that, since the relative dielectric constants of helium (approximately 1) and hydrazine (approximately 19.2) were sufficiently different, the fluids could easily be identified by the different impedance seen by a capacitance probe.

Some potential applications of the AC fluid flow probe would require the use of multiple probes placed in the flow stream. For example, consider the problem of measuring the volume fraction of oil, water, natural gas, and oil/water emulsions flowing in a pipeline. The number of possible flow regimes influences where the probes are located in the flow stream. Placing probes at strategic locations within a cross-section of the pipe, the volume fractions of each constituent can be calculated statistically from the information obtained by each probe in the data stream. Also, by using at least two probes separated by a known distance, the velocity of each constituent can, in most cases, be measured.

Probes must be designed to have minimum effect on the flow while having good strength and durability characteristics. Additionally, the probes should be as self-cleaning as possible and not interfere with each other either electrically or physically. The sampling rate can be high, i.e., thousands of samples per second. Tests have successfully shown the presence and identity of minute discontinuities within a continuous flow.

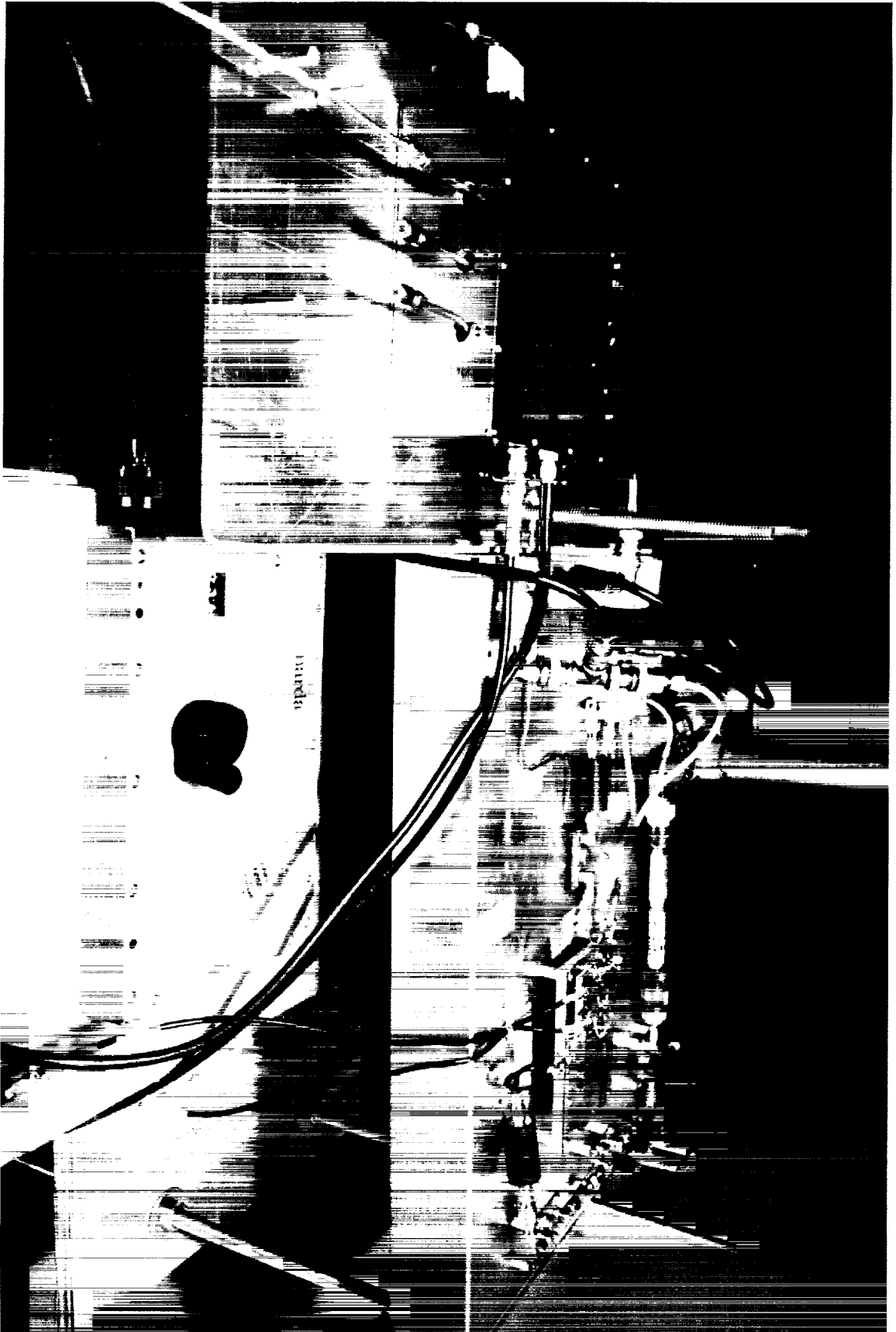

Volumetric Meter Used for Phase Detection and Volume Measurements

Fluid Flow Volume Measurements

Benefit

Researchers at Johnson Space Center (JSC) are interested in a flow meter that can accurately measure (to within $\pm 4\%$) the volume of urine voided by astronauts in a zero-g environment (approximately 200 to 900 milliliters). The current urine monitoring system does not meet the required tolerance at the low volume or high volume end. A capacitance probe has been developed to measure the flow volume of a single homogeneous fluid for slow flow rates. This probe design is a modification of another probe, also developed at JSC, to measure volume fractions, flow rates, and flow regimes of multiple fluids flowing through a pipe. The primary modification to the probe is that all flow is directed through the active region, or orifice.

Accomplishment

This capacitance probe has demonstrated the capability of measuring total fluid volume of a single fluid for slow to moderate flow rates. Some variations in flow rates can be accommodated with little impact on measurement accuracy, as long as some maximum flow rate is not exceeded for a given probe. If the flow rate profile is known and is the same for each trial run, volume measurements can be made with great accuracy.

The probe may have application for the measurement of urine volume in a low-gravity environment. At the present stage of development, the probe can provide volume measurements to within $\pm 4\%$ using tap water. Variations in urine salt content are measured by a conductance probe and a correction factor is applied to the volume measurement to account for the differences in conductance.

This technique is now being developed into a prototype system for a flight demonstration. A patent (#5,596,150) was issued on 1/21/97 for this probe technique.

Background

Analysis reveals that a narrow orifice helps avoid the nonlinearity at differing flow rates. The geometry of the probe's deflector and the air flow control also influence linearity. The key to the probe's performance is an increasing flow rate which results in more of the orifice being filled with liquid, without completely blocking air flow.

The active region of the capacitance probe is formed by the center conductor extension of a 1/8-in. coaxial cable and the outer shield of two other segments of coaxial cable. The length of the active region is approximately 1 in. now, but can be increased to accommodate larger flow rates.

The outer segment coaxial cables can also provide the necessary rigidity for most applications. The probe's active region is two-sided to double the flow volume. The coaxial cable can be made of any length desired and, provided that cable losses do not exceed 1 or 2 dB, has minimal effect on the performance.

For the most accurate volume measurements, the probe was designed to exacting characteristics. The volumetric meter pictured opposite uses radio frequency electronics to provide quadrature phase detection for both a capacitance probe and a conductance probe for volume measurements. The conductance probe is used to derive a correction factor for salt content to obtain a true volume.

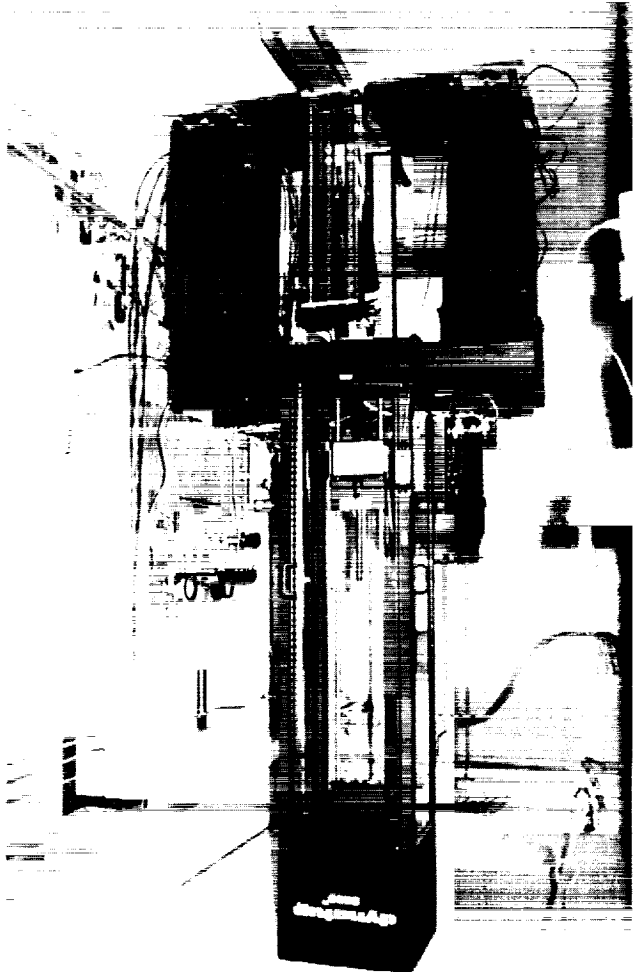

IMIT

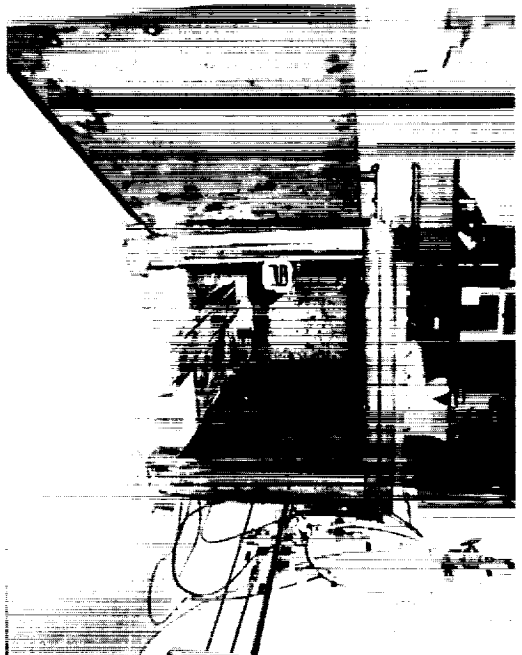

Blast Enclosure



COPY/TUP

Instrumented Mechanical Impact Test (IMIT) Facility

Benefit

New state-of-the-art high-strength, lightweight, composite overwrapped pressure vessels (COPVs) are currently in use on spacecraft for the high-pressure containment of gases and/or propellants. COPVs are highly susceptible to impact damage during all stages of spacecraft buildup, installation, and operation. A COPV rupture-in-use due to impact damage is a highly catastrophic event. The IMIT can provide the delivery of an "intelligent" impact to a COPV in either the pressurized or unpressurized condition and develop an impact damage profile. This profile comprises both impact magnitude measurement (quantitative) and damage indicators (qualitative). This work will contribute to the writing of industry standards which will then control COPV safe use.

Accomplishment

The facility consists of a remotely operated personal computer-controlled IMIT located within a high-pressure test cell. The IMIT is installed with a specially designed COPV blast enclosure which can accommodate most mid-sized high-pressure COPVs currently being manufactured for spacecraft use. The White Sands Test Facility is currently using this test facility in support of a joint U.S. Air Force/NASA program aimed at the enhanced technology of composite overwrapped pressure vessels. One of the major achievements of this program, along with impact damage threshold definition and characterization, will be a comprehensive impact damage control plan designed for COPV safe use.

Background

The facility contains a remotely operated industry-standard drop-weight-type impact tester which is equipped with semiconductor strain gages to record high-speed, real-time responses from impactor TUP/COPV impact events. Impact data (such as force vs. time, impact energy, impact velocity, rebound energy and maximum impact deflection) can be recorded in a digital format for subsequent analysis. This facility is configured to allow COPV pressurization to the required test pressure with either gaseous nitrogen or deionized water. The IMIT is installed with an integral blast enclosure designed to contain and dissipate any burst-upon-impact event that might occur during test. The blast enclosure is equipped with Lexan® view port(s) permitting high-speed filming of the impact events. Inside the blast enclosure a rigid mounting arrangement is provided which permits presentation of almost any point on the COPV surface to the impactor. This facility is designed for flexibility in use and can be reconfigured to accommodate almost any required reactive impact event involving both reactive test article(s) and/or reactive media such as liquid oxygen.

For further technical information, contact Harry Johnson at (505) 524-5722 or harry.t.johnson1@wsf.nasa.gov

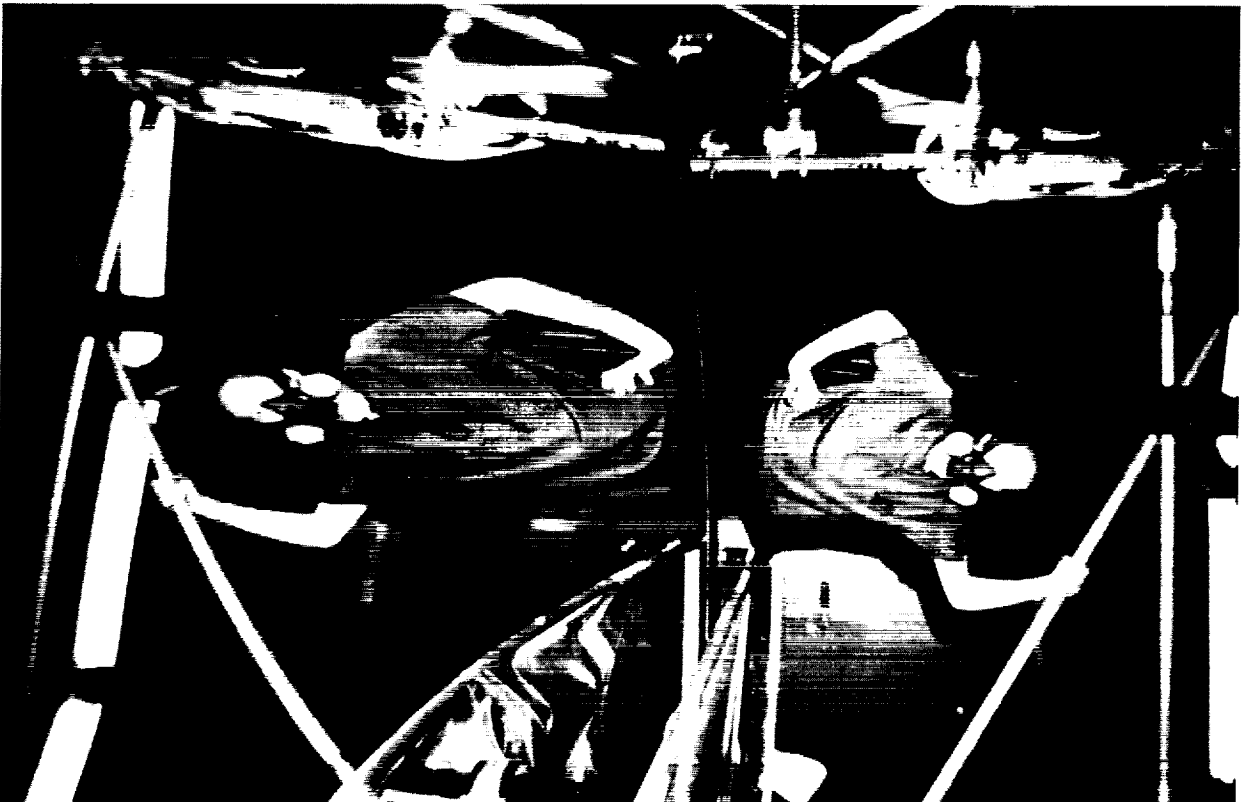

Liquid Mercury Mirror Telescope

Liquid Metal Mirror for Optical Measurements of Orbital Debris

Benefit

Scientists at the Johnson Space Center have developed and built a unique tool for observing and measuring orbital debris—a telescope that uses liquid mercury to form a thin, reflective surface. Currently, the most sensitive tool for monitoring orbital debris in low Earth orbit is the Haystack radar used by NASA. For an optical telescope to approach the sensitivity of this radar, its optical collecting aperture would need to be very large, at least 3 m in diameter. The cost of such a mirror, which would have to be fabricated from glass or quartz, is conservatively estimated at over \$5 million. Taking advantage of recent advances in mirror technology that use a rotating pool of liquid mercury, scientists worked on a low-cost alternative to the large glass mirror. They spent several years and approximately \$400,000 developing and building a telescope that employs a liquid metal mirror 3 m in diameter. With its excellent optical quality, the telescope is expected to detect debris as small as 1 to 2 cm orbiting at an altitude of 500 km. The optical quality of the telescope very nearly matches that of the Haystack radar, providing a low-cost alternative for monitoring the orbital debris environment.

Accomplishment

Haystack radar measurements of the small orbital debris population, as small as 1 cm orbiting at 500 km, have been under way for about 7 years. These statistical measurements give information about debris flux at various altitudes but lack detailed orbit information for each detected object. It has been known for some time that radar and optical techniques do not see exactly the same debris population. Some objects have high optical reflectivity but low radar reflectivity, and vice versa. This instrument can develop a statistical profile of orbital debris in low and middle Earth orbits as well as in geosynchronous orbit. Consequently, its optical measurements could be used to supplement radar measurements to get a more complete picture of the debris environment. Studies with the telescope will complement those being conducted with the Haystack radar. Comparing these two sets of data will provide a better understanding of the orbital debris environment—knowledge that is important for all orbiting spacecraft, including the planned Space Station. The telescope, which requires extremely dark skies for optimal performance, has been moved from Houston, Texas, to a location high in the mountains near Cloudcroft, New Mexico.

Background

The liquid mercury telescope functions much like the Haystack radar. It “stares” at a particular slice of space, observing those objects which pass through the selected area. Although most orbital debris studies use radar rather than telescopes, telescopes offer some distinct advantages. They are less expensive to operate and can detect objects in high orbits, such as geosynchronous orbits, with smaller collecting apertures.

The largest component of the telescope is a parabolic dish just over 3 yards in diameter. Several gallons of liquid mercury pool in the center of the dish. To use the telescope, the dish is spun up to a rate of 10 rpm. Centrifugal force and surface tension cause the liquid mercury to spread out in a thin layer over the dish, creating a reflective surface as good as any polished glass mirror’s. Because the dish must be extremely stable to produce this reflective surface, it rests on a cushion of air.

Researchers are aware of the inherent dangers of working with liquid mercury. They observe a number of safety precautions and have established procedures for spills and safety processes. Over the next year at Cloudcroft, the telescope will continue to gather data on the orbital debris environment under a contract with the National Science Foundation and the Associated Universities for Research in Astronomy. Long-range plans are to move the telescope to a location on the equator where debris in low inclinations can be observed.

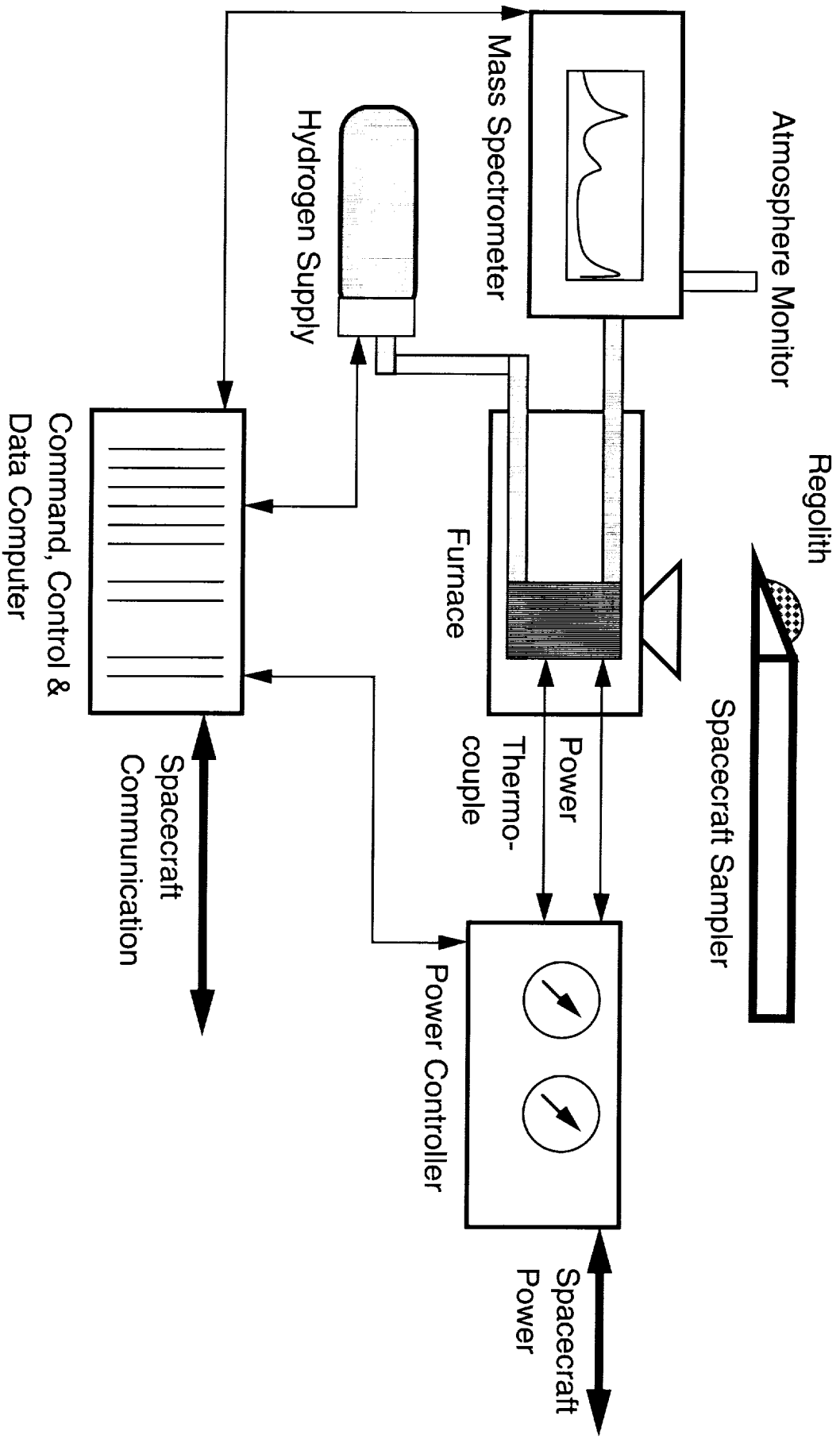

Regolith Evolved Gas Analyzer

Regolith Evolved Gas Analyzer (REGA)

Benefit

The extraction of oxygen is a key example of in situ resource utilization (ISRU) which will directly support an early human presence on the Moon. This is because one of the largest elements in any rocket is the oxidizer required to burn the fuel. Nearly 85% of the propellant mass of a liquid hydrogen-liquid oxygen rocket is oxygen. Locally produced oxygen for rocket propulsion promises by far the greatest cost and mass saving of any in situ resource for lunar applications. Human missions which employ ISRU will certainly be preceded by robotic spacecraft. Scientists and engineers at Johnson Space Center are currently developing flight instruments which will demonstrate oxygen production on the Moon. Oxygen can be extracted from the lunar soil, or regolith, by a variety of methods. One of the simplest and best studied is reduction of FeO by hydrogen gas, to produce water vapor. REGA is designed to demonstrate this process, as well as to measure volatiles and their interactions with the regolith.

Accomplishment

REGA is currently in the final year of development. The project includes design and prototyping of the furnace unit, sample load/dump system, gas plumbing, mass spectrometer, and data system, followed by integration of the various subsystems into a single functional instrument. To date we have:

- Fabricated four prototype furnaces and two heater models for full-scale testing
- Fabricated a gas delivery system
- Integrated the REGA furnace prototype with a mass spectrometer
- Demonstrated that the prototype furnace can repeatedly heat 1 g of lunar soil simulant to 900°C in hydrogen to extract oxygen
- Quantified the effects of composition, temperature, and hydrogen flow rate on oxygen yield from 19 lunar soil and glass samples

Currently we are constructing a complete initial REGA prototype. We will optimize the design in a second instrument and fabricate and program the control system. A parallel effort will complete a small dedicated mass spectrometer for integration into the REGA instrument. The final product of our three-year effort will be a fully operational breadboard instrument. All REGA subsystems are designed such that they can be upgraded for space qualification. We are producing an instrument with sufficient maturity that it can be successfully proposed for a variety of lunar and planetary missions.

Background

REGA's *Regolith Reactivity Analysis* mode will provide quantitative data on the interactions of planetary surface materials with a variety of gases. In the lunar application, regolith samples can be heated and reacted with hydrogen to liberate oxygen. The *Evolved Gas Analysis* mode will provide identification and quantitative data on volatile species evolved from the sample at various programmed temperature steps. Priority lunar targets include samples from permanently shadowed craters and the regolith of volcanic terrain containing volatiles from outgassing. REGA's *Atmospheric Composition Analysis* mode employs a mass spectrometer run in a configuration open to the atmosphere. Assuming that the spacecraft outgassing background can be overcome, this analysis will provide quantitative compositional data, including isotopic abundances. The mass spectrometer will monitor the atmosphere over time and may detect transient gas events.

For further technical information, contact Dave McKay at (281) 483-5048 or david.s.mckay1@jsc.nasa.gov

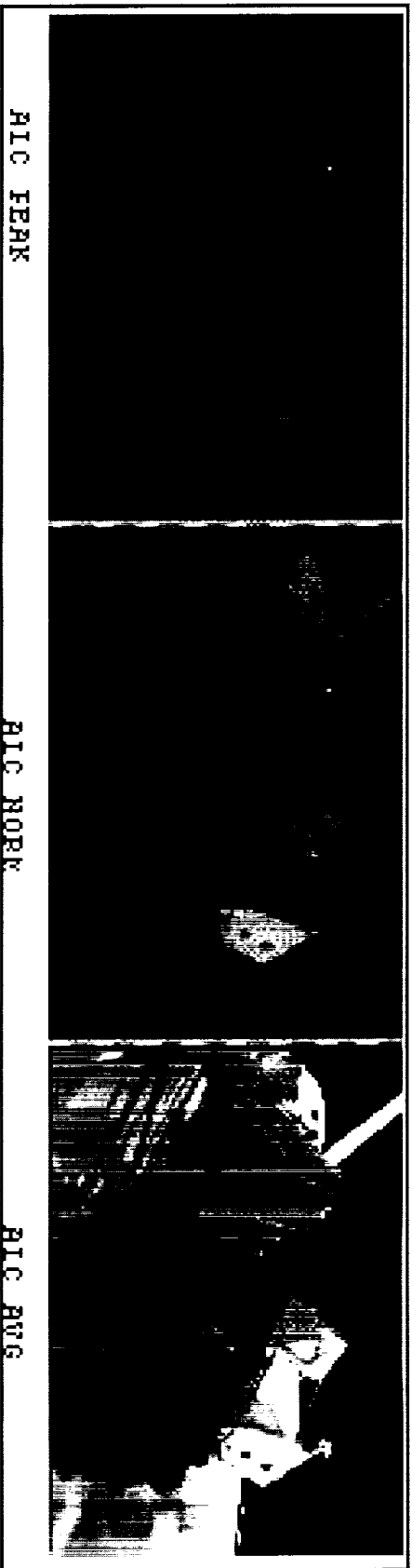
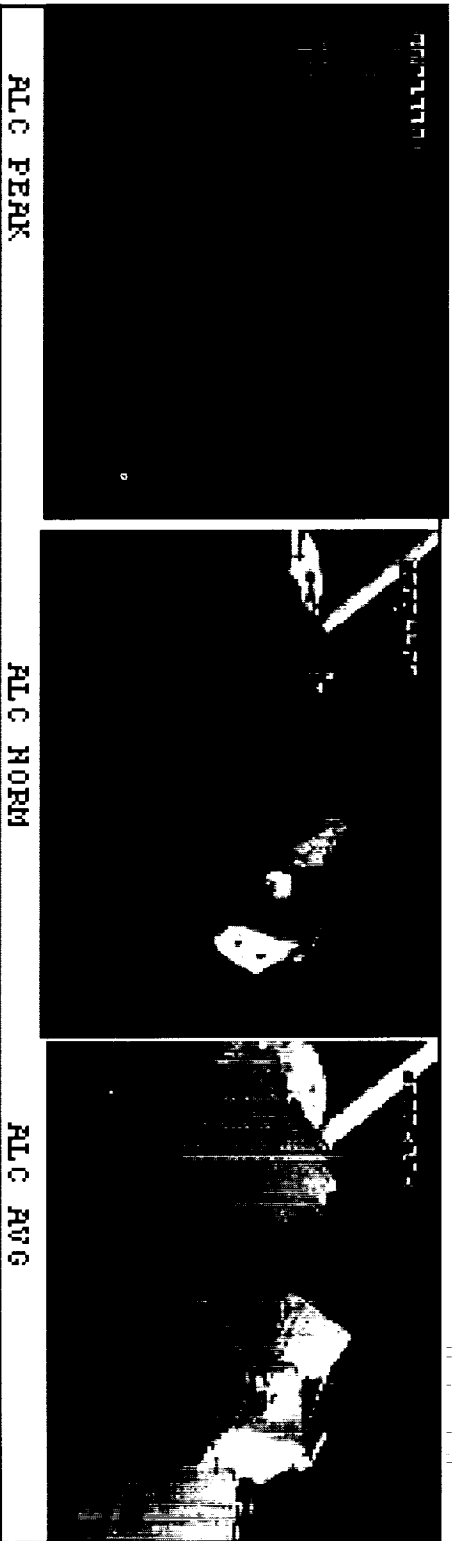

STS-74 Downlinked Video: Predicted by Model

Camera Images From Luminance Maps

Benefit

An accurate computer-based camera model will allow preflight lighting analysis to predict the best times during an orbit for camera viewing of a specific activity. Such analysis is critical to mission success for operations that depend on camera viewing. Quick assessment of lighting impacts due to flight schedule changes can also be provided with this predictive camera model. For example, the performance of the camera-based Space Vision System (SVS) during Space Station assembly will depend on good camera images during the Shuttle berthing operations for Station assembly and pre-launch camera selection and location can be optimized for examination of critical components while on orbit.

Accomplishment

Post-processing techniques of luminance maps created by a physically based lighting program were able to model the camera parameters of automatic light control (ALC) and gamma control (image transfer function) for the CTVC (Shuttle color camera). To model ALC, the luminance map is scanned for a specified region that does not vary in luminance more than a designated amount determined by the ALC settings of average (AVG), normal (NORM) or peak (PEAK). A scale factor is then calculated that will display the average luminance in this area as the average brightness in the image (128 on a color scale between 0 and 255). This scale factor is applied to the entire image (Figure 1). The light entering the camera is displayed by controlling the CTVC camera with two gamma mode settings, GAMMA BLACK STRETCH and GAMMA LINEAR. For gamma control, only the camera's influence on the transfer function was modeled. Influences on the display from monitors and printers were not considered in this project. To validate results, computer-generated images were compared to ground-based images created with CTVC and lights. Video images broadcast from the Shuttle were also used for comparison as well.

Background

The purpose of this project is to develop and validate computer models of the Shuttle TV cameras based on the scene illumination and the camera parameters such as noise, gamma, and gain. The input to the camera model is an accurate computer calculation of the scene luminance, i.e., the amount of light reflected from objects in the scene into the camera lens. Such calculations can be very accurate but are slow (~20 minutes) to generate. This computer model of a Shuttle TV camera will allow pre-flight prediction of lighting conditions for camera-based operations.

For further technical information, contact Jim Maida at (281) 483-1113 or james.c.maida1@jsc.nasa.gov

VASIMIR Concept

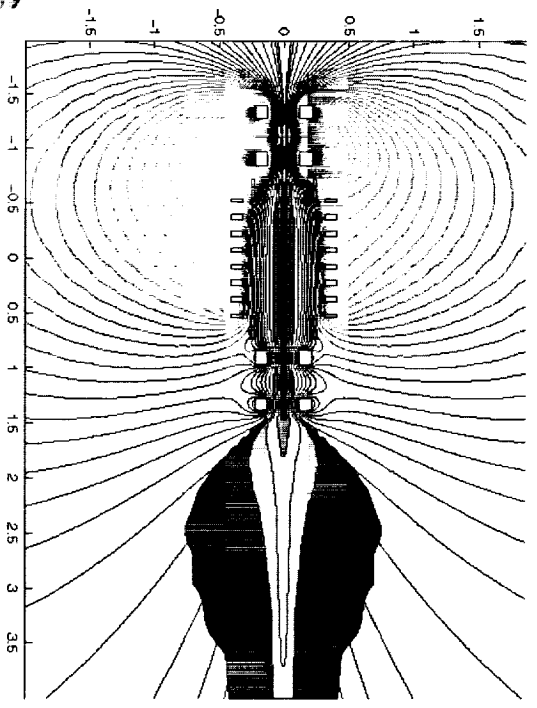
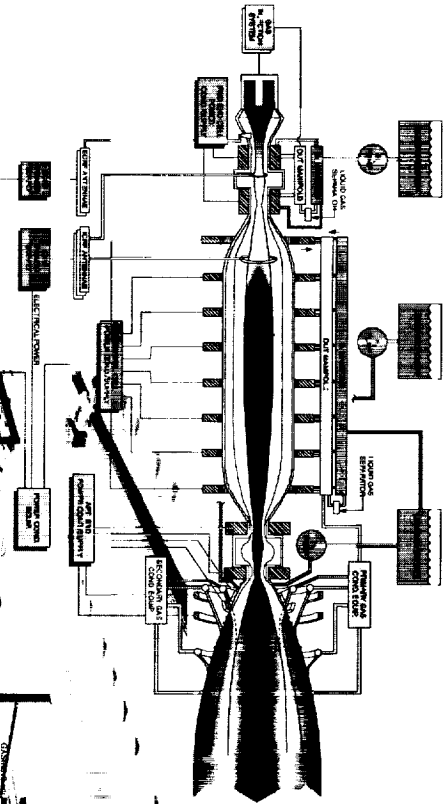

Human Fast Mission
 Departure: June 1, 2018 Arrival: August

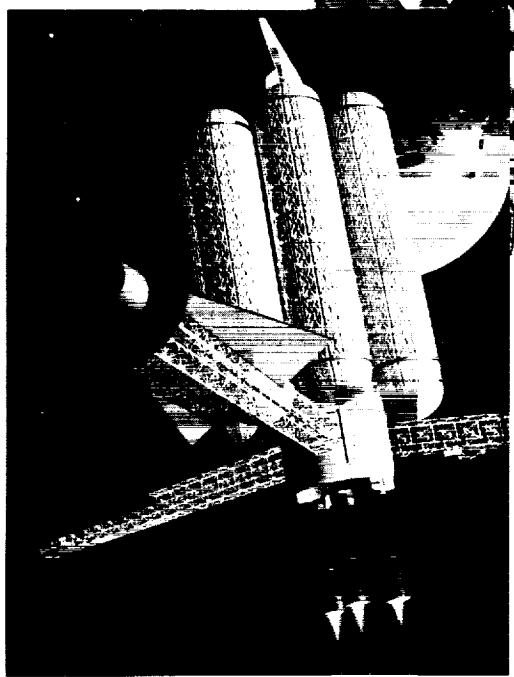
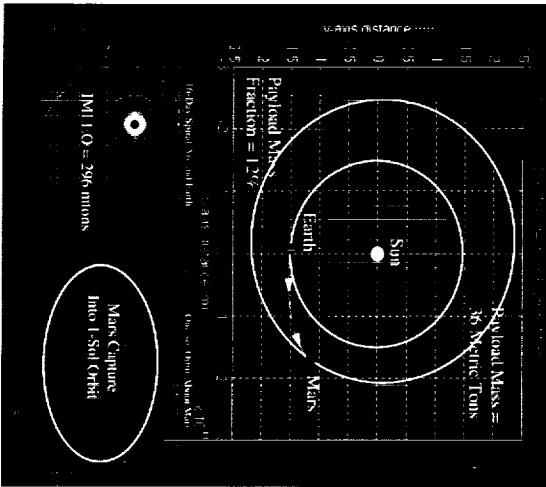

Variable Specific Impulse Magnetoplasma Propulsion

Benefit

This work is strongly geared toward a new space propulsion technology, enabling very rapid human and robotic transit to Mars (3 months one way) and beyond. In addition to their application to interplanetary travel, variable specific impulse magnetoplasma rockets (VASIMRs) will also have a profound effect on the economics of the commercial satellite market by virtue of their greatly improved payload mass fraction over conventional chemical rockets. The improvements in propulsion efficiency will enable access to and from geostationary space by orbit transfer vehicles using this technology. It will also allow the periodic maintenance and repair of large communications stations in orbit.

Other areas of technology transfer include high-voltage and solid-state power conditioning and conversion, cryogenic fluid dynamics, gauging and control, space applications of new high-temperature superconducting materials at high magnetic field (2 - 3 Tesla), and a wide array of new plasma diagnostics for rapid collection of science and system data. Magnetoplasma technology will drive important developments in solid-state power devices, materials, coatings and magnetic energy storage systems using state-of-the-art superconductors.

Accomplishment

Plasma is generated and confined in the central cell of an asymmetric magnetic mirror. The device consists of a multi-coil central solenoidal cell with two high-field end cells. Ions and/or electrons are electromagnetically plasma-heated through cyclotron resonance heating.

While the present configuration is potentially capable of steady-state operation, it is unnecessary to do so at this time. The scope of this investigation centers on achieving stability at the much shorter characteristic times associated with rapid (microseconds) plasma disruptions. Typical stable discharges can last from 1 to 10 seconds, depending on magnet heating constraints. Pure steady-state operation could be achieved in a superconducting device.

Routine low-power plasma operations in the lab were demonstrated in the summer of 1995. No plasma instabilities were encountered, thus paving the way for high-power plasma discharges. Main effort in 1997 has been to configure the lab for high-power plasma operations and system diagnostics. Low-power plasma characterization in the central cell has been accomplished with reciprocating Langmuir and Mach probes. A newly designed Lorentz Force Accelerator has been installed and successfully fired into the system as a high-density plasma injector. Other radio frequency-based plasma injection devices, such as Helicon plasma sources, have also been tested and are being considered for full implementation. A full, 2-D code, mapping the magnetic field throughout the entire machine, has been developed. A Monte Carlo simulation which follows the trajectories of plasma particles in the magnetic expansion nozzle has also been developed.

Background

Our research group is pursuing the experimental characterization of high-density magnetized plasma discharges in our high-field facility located at the Advanced Space Propulsion Laboratory (ASPL). These studies focus on identifying plasma stability criteria as functions of density, temperature, and magnetic field strength. Plasma heating is accomplished by electron cyclotron resonance at frequencies of 2.45 and 14.7 GHz, and by ion cyclotron resonance at 1-10 MHz. Plasma discharges in argon and helium are now routinely generated. Electron density and temperature are measured by a movable double Langmuir probe, and by fast Langmuir and Mach reciprocating probes. Ion exhaust velocity is measured by a retarding potential energy analyzer. System enhancements will include direct heating of hydrogen ions by these techniques, and much higher plasma densities.



X-38

X-38 Project

Benefit

The X-38 is a technology demonstration vehicle designed to meet the generic requirements for a crew return vehicle (CRV), and to be capable of evolutionary growth to satisfy requirements for other human spacecraft. The International Space Station requires a CRV to provide a means for returning Station crew members to Earth for several contingency cases: (1) an ill or injured crew member who cannot wait until the next scheduled Shuttle flight to return to Earth; (2) a Station contingency which renders it uninhabitable; (3) the inability to perform resupply for the Station. The CRV derived from the X-38 is expected to be significantly cheaper than other CRV options that have been evaluated.

Accomplishments

Vehicle configuration studies and system trade studies, and bench tests of components and subsystems, conducted during 1995 and 1996 provided definition of the vehicle concepts and an overall plan for the X-38 project. Scaled Composites fabricated airframes for two atmospheric test vehicles in 1996 and delivered them to the Johnson Space Center (JSC) for structural verification and systems installation & checkout. Flight testing of the parafoil to be used for landing illustrated the need for improvements in the parafoil deployment and flight characteristics. These modifications have been successfully addressed with an intensive analytical and sub-scale/full-scale test effort continuing through 1997. Outfitting and checkout of the first atmospheric flight test vehicle, vehicle 131, was completed in June 1997, and the vehicle was shipped to Dryden Flight Research Center (DFRC) for flight testing. At DFRC, NASA's B-52 will be used to carry the vehicle to altitude before the vehicle is released for a short period of free flight, followed by parafoil deploy and inflation, flight to the ground, and landing on the lake bed. Four B-52 captive carry flights have been accomplished to date to check out systems in the flight environment, verify procedures, and prepare for the actual release flight scheduled for February 1998. Vehicle 132, similar to 131 except for an active flight control system, is approaching completion at JSC and is planned to be shipped to DFRC in March 1998. The active flight control system of 132 will allow longer free-flight times and more detailed verification of vehicle aerodynamic characteristics and flight control system behavior.

Aerodynamic analyses and wind tunnel testing are being performed to verify the effectiveness of outer mold line changes made to the basic X-24A shape to optimize the vehicle for the CRV application. The spaceflight test vehicle for the X-38 program, vehicle 201, has tentatively been assigned a flight date of March 2001. Design reviews of V201 systems have been performed in late 1997, and construction of this vehicle has begun in building 220. The top-level performance requirements for the CRV derived from the X-38 are being baselined with the Space Station program.

Background

The Soyuz capsule will provide interim CRV function for the early Station. The Soyuz does not represent a viable long-term solution for the following reasons: (1) The crew size limitations imposed by Soyuz eliminates about 40% of the U.S. astronaut corps; (2) the crew training requirements for Soyuz represent a major impact to U.S. crew members; (3) the characteristics of the Soyuz do not make it satisfactory for transport of ill or injured crew members. Previous cost estimates for a CRV to replace the Soyuz were beyond the capability of the Station budget. In addition to its use as a Station CRV, other potential growth applications for the X-38 include an earth-to-orbit crew transport vehicle and a vehicle for other orbit-to-orbit transportation. The concept selected for the X-38 vehicle is a lifting body shape based on the USAF/Martin X-24A flown in the 1960s.

