

NASA/CR—1999-209151

ASME 99-GT-283



Heat Transfer and Flow on the First Stage Blade Tip of a Power Generation Gas Turbine Part 2: Simulation Results

A.A. Ameri
AYT Corporation, Brook Park, Ohio

R.S. Bunker
General Electric Corporation, Schenectady, New York

Prepared for the
44th Gas Turbine and Aeroengine Congress, Exposition, and Users' Symposium
sponsored by the International Gas Turbine Institute of
the American Society of Mechanical Engineers
Indianapolis, Indiana, June 7–10, 1999
Prepared under Contract NAS3–98106

National Aeronautics and
Space Administration

Glenn Research Center

April 1999

Acknowledgments

This work was sponsored by the Smart Green Engine Project managed at NASA Glenn Research Center (formerly NASA Lewis Research Center) by Mr. Kestutis Civinskas. Helpful suggestions offered to the first author by his colleagues Mr. Robert Boyle, Dr. David Rigby, and Dr. Erlendur Steinthorsson are hereby acknowledged. Some of the computations were performed on the CRAY-C90 of NAS at NASA Ames Research Center.

Available from

NASA Center for Aerospace Information
7121 Standard Drive
Hanover, MD 21076
Price Code: A03

National Technical Information Service
5285 Port Royal Road
Springfield, VA 22100
Price Code: A03

Heat Transfer and Flow on the First Stage Blade Tip of a Power Generation Gas Turbine

Part 2: Simulation Results

A. A. Ameri

AYT Corporation, Brook Park, OH, USA

R. S. Bunker

General Electric Corp. R & D Center
Schenectady, NY, USA

ABSTRACT

A combined experimental and computational study has been performed to investigate the detailed distribution of convective heat transfer coefficients on the first stage blade tip surface for a geometry typical of large power generation turbines (>100MW). This paper is concerned with the numerical prediction of the tip surface heat transfer. Good comparison with the experimental measured distribution was achieved through accurate modeling of the most important features of the blade passage and heating arrangement as well as the details of experimental rig likely to affect the tip heat transfer. A sharp edge and a radiused edge tip were considered. The results using the radiused edge tip agreed better with the experimental data. This improved agreement was attributed to the absence of edge separation on the tip of the radiused edge blade.

NOMENCLATURE

C_p	constant pressure specific heat
h	heat transfer coefficient
Pr	Prandtl number
R	gas constant
Re	Reynolds number
T	temperature/ T_0
Tu	turbulence intensity
V	magnitude of the velocity/ $(R T_0)^{1/2}$
y^+	dimensionless distance from a wall, $y^+ = y \frac{v}{\nu}$
γ	specific heat ratio
Subscripts	
t	total conditions
0	total inlet condition

INTRODUCTION

Blade tips are susceptible to burnout and oxidation due to high thermal loading associated with flow through blade tip gaps. Efficient internal or film cooling schemes are necessary to protect the blade against damage. The design of such schemes requires detailed knowledge of heating patterns on and near the tip which could be gained by predictive methods. The quality of the predictive method can only be assessed through comparison with relevant experimental data. In the absence of comprehensive data on tip heat transfer, in order to validate computations relating to tip and casing treatments and their effects on heat transfer, the available data on various aspects not directly related to the blade tip heat transfer have been relied upon. For example, for the assessment of the effect of tip recess on the tip heat transfer and efficiency, Ameri et al. (1998a) used the data of Metzger et al. (1989) for modeled tip recess to verify the applicability of the numerical scheme and especially the turbulence model. Numerical prediction of the effect of the casing recess on the blade and tip heat transfer and efficiency (Ameri et al. 1998b) was deemed reliable on the basis of the good experiences of the past with the numerical scheme and favorable comparison of the calculated efficiency as a function of tip clearance height with experimental correlations.

There are in fact some heat transfer data available on blade tips but are limited to discrete point measurements on locations mainly along the mean camber line of the tip of rotating blades (Dunn et al. 1984a, 1984b and Dunn and Kim, 1992). The data do provide a useful check on the numerical prediction of heat transfer as was done by Ameri and Steinthorsson (1995, 1996). As the variation of the rate of heat transfer on the tip can be large, the complete map of the tip heat transfer would of course be more useful and agreement with such data more reassuring.

The complete measured heat transfer map of the blade tip as presented in part 1 of this paper provides the valuable test case which can engender confidence in the numerical solutions. The

results reported in this paper constitute the first reported direct comparison between the experimental and numerical calculation of blade tip heat transfer. It is also the first time a computation on a radiused edge tip is presented.

The paper is organized as follows: In the ensuing section a brief description of the experimental setup will be provided. Following this the numerical method used in the simulations will be described. Subsequently the results of the numerical simulations will be presented and finally a summary and the conclusions of the work will be presented.

THE EXPERIMENTAL SETUP

The experimental setup and conditions will be briefly discussed in this section. A detailed description can be found in part I of this paper.

Figure 1 shows the definition of the airfoils and the shroud. The blade profiles are typical of a large power generation turbine. The cascade is linear and the span is 10.16cm. As can be seen the shroud contains a step or a recess ahead of the blades to model a similar feature found in an actual turbine shroud. The tip clearance varies from 1.27 to 2.79 mm. However in this paper we will exclusively address the nominal gap width of 2.03 mm. Figure 2 shows the design of the actual two passage blade cascade.

The experiments were conducted using two types of blade tips namely, a sharp edged tip and a radiused tip with a radius of 2.54 mm around the perimeter of the tip. The measurements were taken on the tip of the middle blade. The adjacent blades are simulated by the use of contoured walls. A splitter plate was placed ahead of the blade to help force equal mass flow rate in the two passages.

Table I lists the run conditions for the cascade and input to the numerical simulations. Our calculations were limited to the 5% turbulence intensity.

THE COMPUTATIONAL METHOD

The simulations in this study were performed using a multi-block computer code called LeRC-HT, previously known as TRAF3D.MB(Steinthorsson et al. 1993) which is based on a single block code designed by Arnone et al. (1991). This code is a general purpose flow solver designed for simulations of flows in complicated geometries. The code solves the full compressible Reynolds-averaged, Navier-Stokes equations using a multi-stage Runge-Kutta based multigrid method. It uses the finite volume method to discretize the equations. The code uses central differencing together with artificial dissipation to discretize the convective terms. The overall accuracy of the code is second order. The present version of the code (Rigby et al. 1996, 1997 and Ameri et al. 1998a) employs the $k-\omega$ turbulence model developed by Wilcox (1994a,1994b) with modifications by Menter (1993). The model integrates to the walls and no wall functions are used. For heat transfer a constant value of 0.9 turbulent Prandtl number, Pr_t , is used. A constant value for Prandtl number (Pr) equal to 0.72 is used. Viscosity is a function of temperature through a 0.7 power law (Schlichting, 1979) and C_p is taken to be a constant.

GEOMETRY MODELING AND THE GRIDS

Two types of modeling were utilized for the present problem.

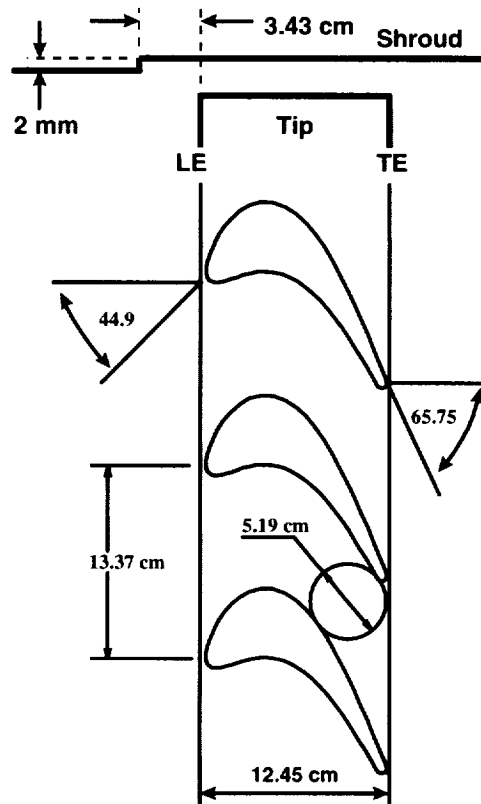

Fig. 1 Airfoil and shroud definition

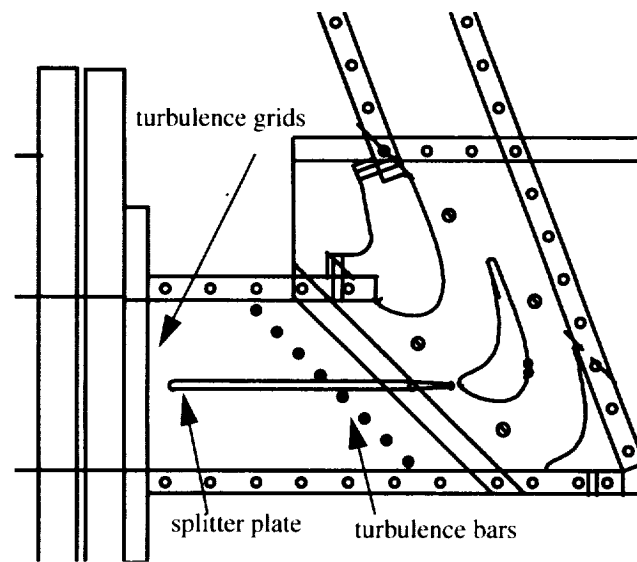

Fig. 2 The cascade

TABLE 1. Run Conditions

Pressure ratio across the blade row	0.69
Exit Reynolds number	2.57E6
Inlet Mach number	0.30
Turbulence intensity	5% and (9%)
Inlet angle	44.9 deg.

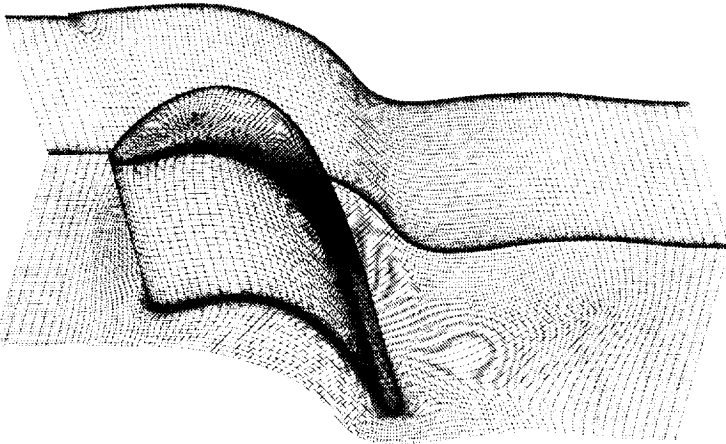

Fig. 3 Overall grid using periodic flow assumption.

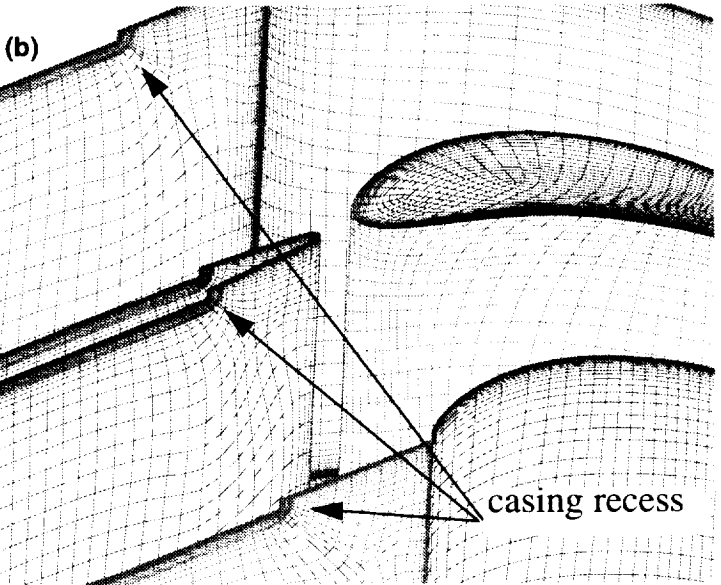
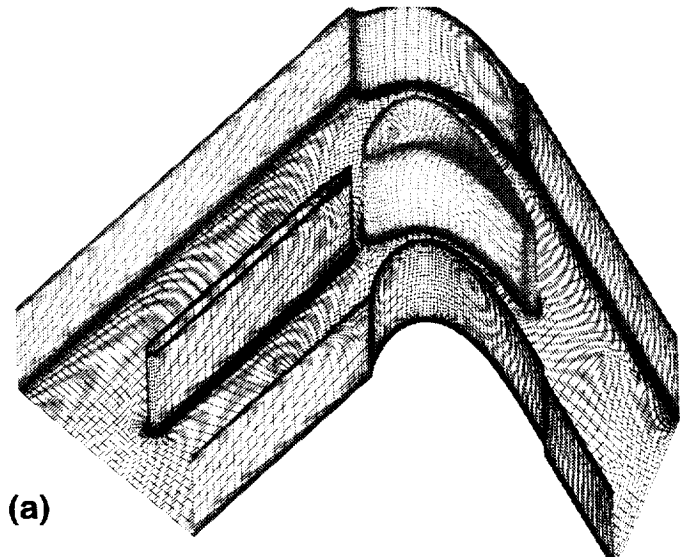

Fig. 4 Modeling the complete passage. (a) Overall geometry and grid. (b) Close up near the leading edge

(a) Modeling of the flow using a periodic blade cascade as shown in Fig. 3 and (b) modeling using the complete flow path including the splitter plate. For both of the above the casing recess is included. Details of the casing recess can be seen more closely in Fig. 4(b). The casing recess also extended over the splitter plate as was the case in the experiment. Sharp and radiused edged tips were used. Figure 5 shows a radiused edge blade. The same grid topology was used with the radiused and the sharp edge grid. The grid is generated using a commercially available computer program called GridPro™. The sharp edge case was run with the side walls modeled using slip and no slip boundary conditions. It was decided that since the heat transfer and pressure results did not differ significantly the slip boundary condition for the side walls be used for the radiused edge case in order to conserve CPU time. The model in Figure 3 consisted of 1.2 million cells. The model of Fig. 4, it consisted of 1.4 or 1.8 million cells depending on whether slip or no-slip side walls were used. The viscous grid is generated by embedding grid lines where needed, including the grid around the splitter. The stretching ratio did not exceed 1.25 for the viscous grid away from the no-slip surfaces. The distance to the first cell center adjacent to solid wall is such that the distance in wall units, (y^+) is near or below unity. To resolve the boundary layers 33-35 grid points are used. This does not include the “inviscid” blade to blade grid which is also quite fine. Within the tip 65-69 grid point are used in the spanwise direction. At the inlet patch the number of grid points is 85 in the pitchwise and 97 in the spanwise direction.

RESULTS AND DISCUSSION

General Remarks

All the cases presented herein have been converged to better than 0.002% mass flow error between the inlet and the exit of the computational domain. The residual for all the cases dropped 6 to 7 orders of magnitude. Typically 2000 fine grid iterations with two levels of multigrid were necessary for convergence. The heat transfer results have been checked for convergence by comparing solutions after consecutive runs of 300 iterations.

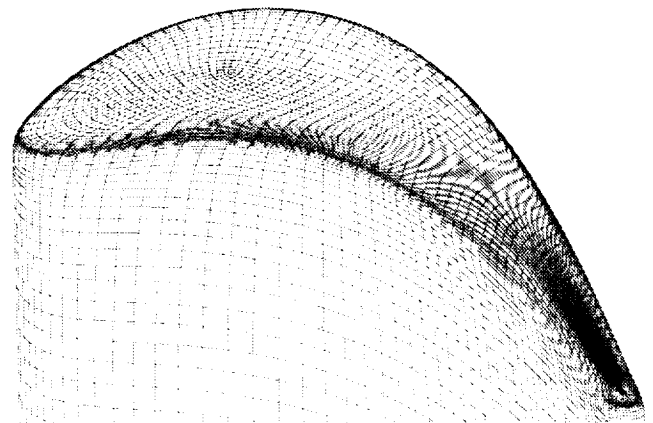

Fig. 5 Radiused edge tip and the surface grid

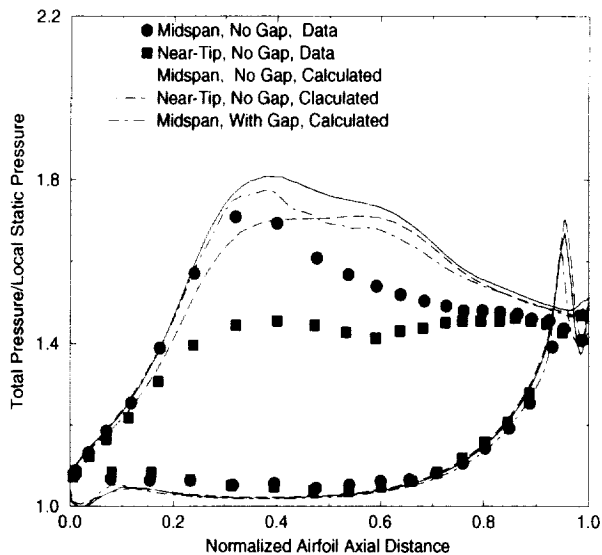

Fig. 6 Blade pressure distribution data and computed pressure distribution using periodic conditions.

A number of calculations were made to help determine the proper way of modeling the geometry. The choices were a linear cascade with periodic boundary conditions and modeling the channels as in the experimental rig. The results as relates to the pressure distribution is presented in the next section. The heat transfer results are presented in the subsequent section.

Pressure Distribution

As described in Part 1, the experimental blade passage consists of one blade with variable clearance and two shaped walls representing the adjacent blades. It might be expected that any similarity to a periodic flow in the two passages is quickly lost as one approaches the tips of the blade since the flow passes over only the center blade. Figure 6 shows the pressure distribution at the midspan and near the tip of the blade for an experimental run for which the tip gap is closed. The numerical prediction in that figure is done using a periodic setup as in Fig. 3. The calculated midspan pressure distribution matches the characteristics of the experimental measurements leading to the conclusion that the midspan flow is quite periodic. Near the tip the agreement between the experimental and the numerical results is lost. This indicates that the assumption of periodic flow is not a realistic option for calculation of quantities in the endwall region.

Figure 7 shows the calculated near tip pressure distribution for periodic and complete passage simulations. The agreement with the near tip pressure distribution appears to improve considerably by accounting for the side walls and the splitter plate. Figure 8 shows the pressure distribution on the tip of the blade. The pressure tap locations are near the edge of the blade as shown on the insets. The agreement appears to be good. As expected the agreement with the results obtained using periodic boundary conditions was quite bad and is not shown here. Good agreement with the measured data was also obtained, as shown in Fig. 9, for the blade tip pressure when a radiused tip blade is used.

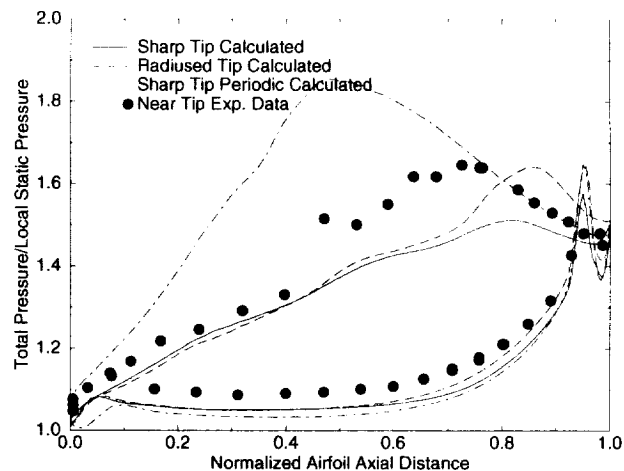

Fig. 7 Near tip pressure distribution data and computed pressure distribution using the complete passage and periodic cascade.

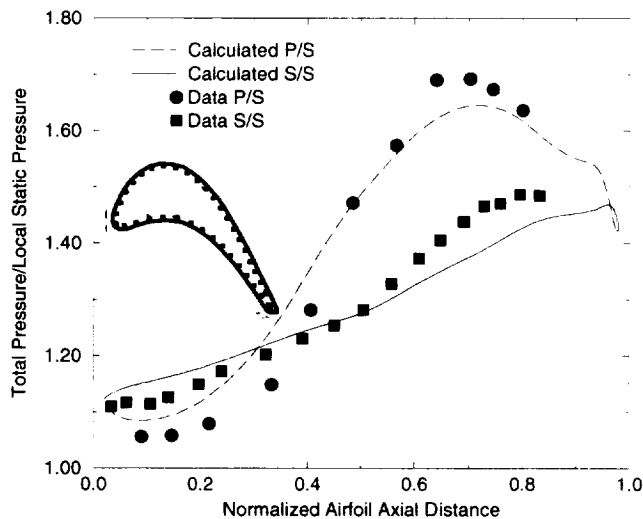

Fig. 8 Blade tip surface pressure distribution with sharp-edged tip and the baseline clearance(2.03 mm).

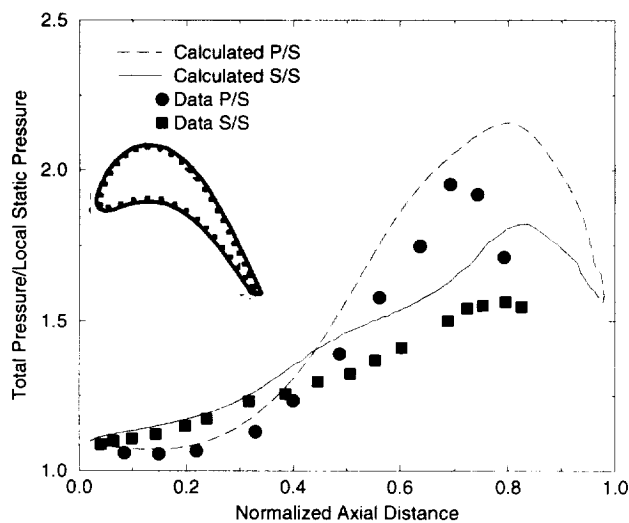

Fig. 9 Blade tip surface pressure distribution with round-edged tip and the baseline clearance(2.03 mm).

The analysis performed lead us to the conclusion that the experimental data do not lend themselves to predictions using periodic modeling of the flow and at least the side walls need to be incorporated in the computational domain. A run without the splitter plate was not attempted but it is safe to assume that the existence of the splitter is necessary as it was in the experiments to help with equalizing the flow rate between the two channels.

Heat Transfer

The present computational method has been applied to a variety of turbine heat transfer problems both using an algebraic turbulence model (Ameri and Steinthorsson 1995, 1996) and as with the present calculations using a low Reynolds number two-equation model. The present turbulence model was tested against the heat transfer data of Metzger et. al. (1989) for flow over a cavity to show suitability of the model for blade tip recess flows in Ameri et al. (1998a). Very good comparison using the current method for blade surface heat transfer with experimental data was achieved by Garg and Rigby (1998).

The rate of heat transfer is presented in terms of the heat transfer coefficient which is defined as:

$$h = \frac{Q_{wall}}{(T_{wall} - T_{inlet})} \quad (1)$$

T_{inlet} is the inlet total temperature and T_{wall} is the wall temperature. T_{wall} was determined from the experimental measurements and found to be 1.06 times the inlet total temperature. The heat transfer coefficient was calculated on the blade tip in the gridded area shown in Fig. 10a where a constant temperature boundary condition is imposed. A constant temperature boundary condition results in a much faster convergence than a constant heat flux boundary condition. Although the experiment was run using a constant heat flux boundary condition, it is expected and was found to be true that the constant heat flux and constant temperature boundary condition yield similar results in the present fully turbulent flow regime. Also the assumption of constant wall boundary condition is justifiable on the grounds that the experimental variation in the wall temperature was quite small. An effectively adiabatic boundary condition was imposed on all the other surfaces. The experimental measuring area is shown in Fig. 10b. The areas are quite equivalent with the exception of the trailing edge where the computational heated area extends further back on the blade.

The definition of heat transfer coefficient in equation (1) was chosen to be consistent with the experimental data. Use of adiabatic wall temperature instead of inlet total temperature leads to a more general definition. The present definition is more convenient computationally as it does not require the calculation of adiabatic wall temperature. In the present study the experimental variables are matched as much as possible to make the comparison and thus the conclusions valid.

Both the sharp edge and radiused edge cases with the tip gap of 2.03 mm and a 5% turbulence intensity at the inlet were studied. A very thin boundary layer thickness of 0.1% of the passage height was imposed at the inlet to the computational domain. Also a turbulence intensity of 10% with a length scale of 1% of blade chord were imposed at the inlet. This yielded a turbulence intensity of 4% at the inlet to the blade cascade.

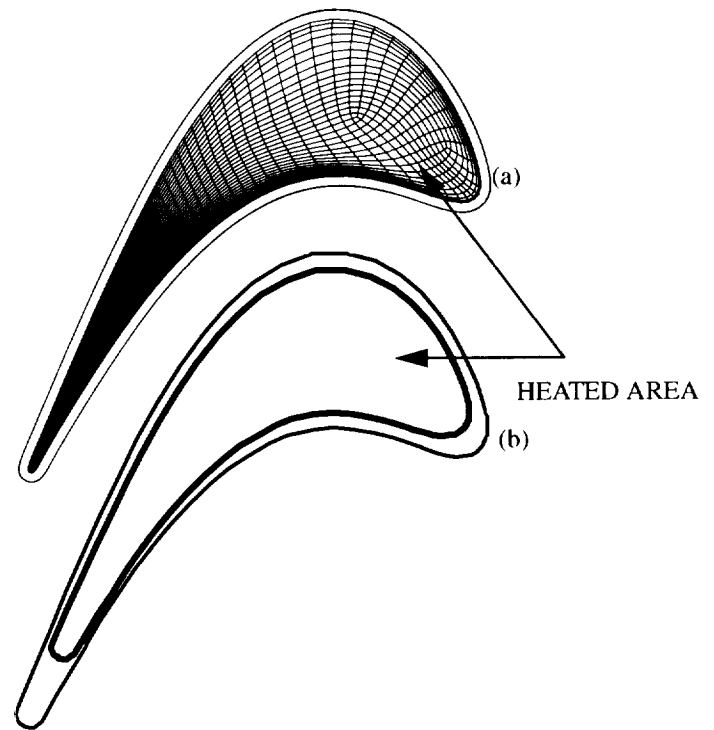

Fig. 10 Heat transfer blade tip (a) computational domain and (b) measuring area

Figures 11 and 12 show the measured and computed heat transfer coefficient for the sharp edge tip and radiused edged cases. For the sharp edge case, it might be said that the general agreement is good. The largest relative difference between the experimental and calculated values is in the area of the 'sweet spot' (see part 1) where the error reaches 30%. However the agreement is good elsewhere and is generally below 15-20% of the measured value. In addition, the region of high heat transfer rate which was marked as area (4) in the part 1 of this paper corresponding to the high entry loss region is captured. The experimental measurements show the highest heat transfer rate under the present conditions to take place in the trailing edge region. This is backed up by the numerical calculation.

Figure 12 shows experimental and calculated tip heat transfer for the radiused edge blade. The agreement in this case is much improved over the sharp edge case above, and is consistently better than 15% over the entire tip. Apparently the prediction is helped by rounding of the edges which eliminates the separation and reattachment on the blade tip. Figures 13(a) and (b) show the flow streamlines over the tip of the blade with the sharp and radiused edges. The separation vortex is present everywhere along the pressure side of the sharp edge blade tip and becomes quite large starting from the maximum loss region. On the other hand the flow over radiused edge tip is quite smooth and there is no sign of any vortical structures present on the blade tip.

The agreement between the calculations and the measured results is quite good, especially if one considers the fact that the flow over the tip is also influenced by the upstream casing recess.

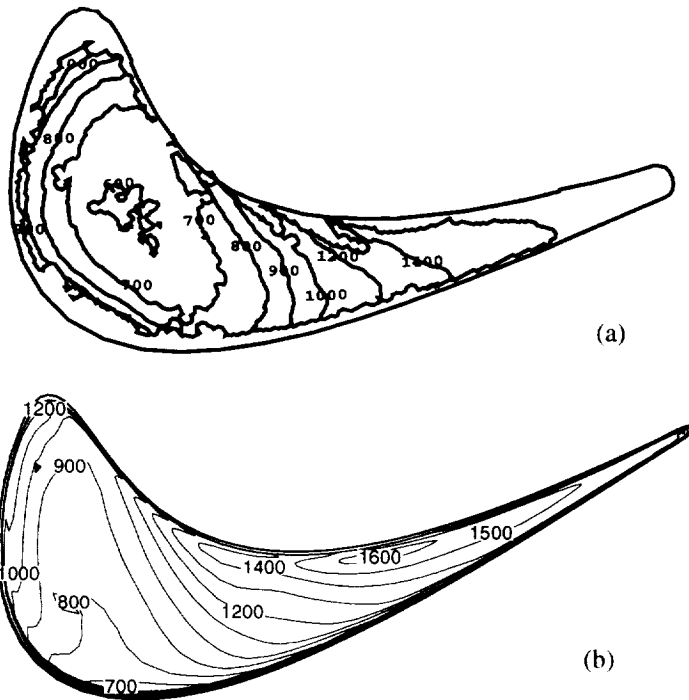

Fig. 11 Sharp edge blade tip heat transfer coefficient for 2.03 mm clearance and $Tu=5\%$. (W/m²/K), (a) Measured and (b) calculated

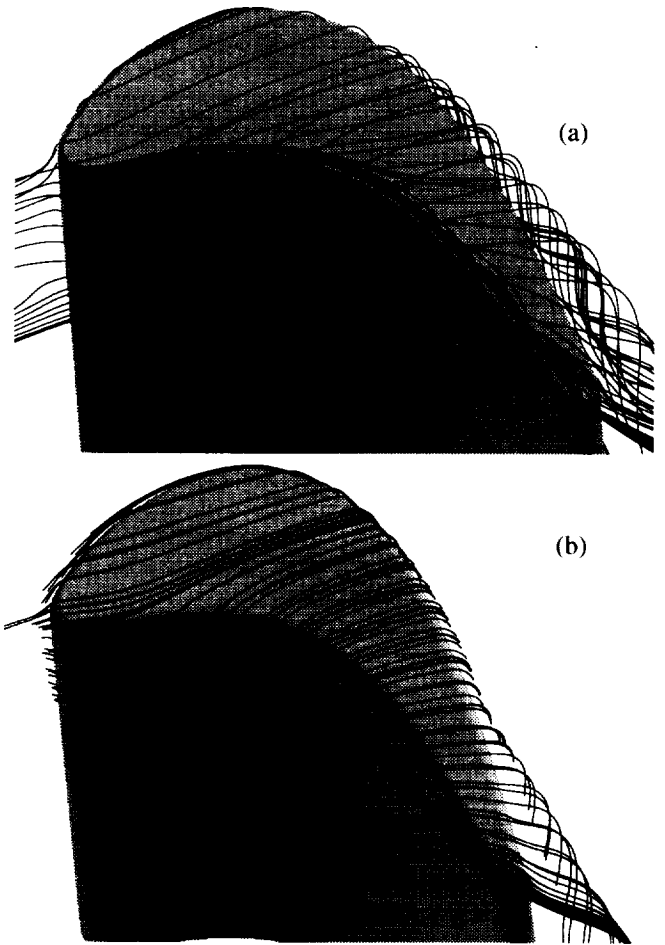

Fig. 13 Flow streamlines over the blade tip for (a) sharp edge blade and (b) radiused edge blade.

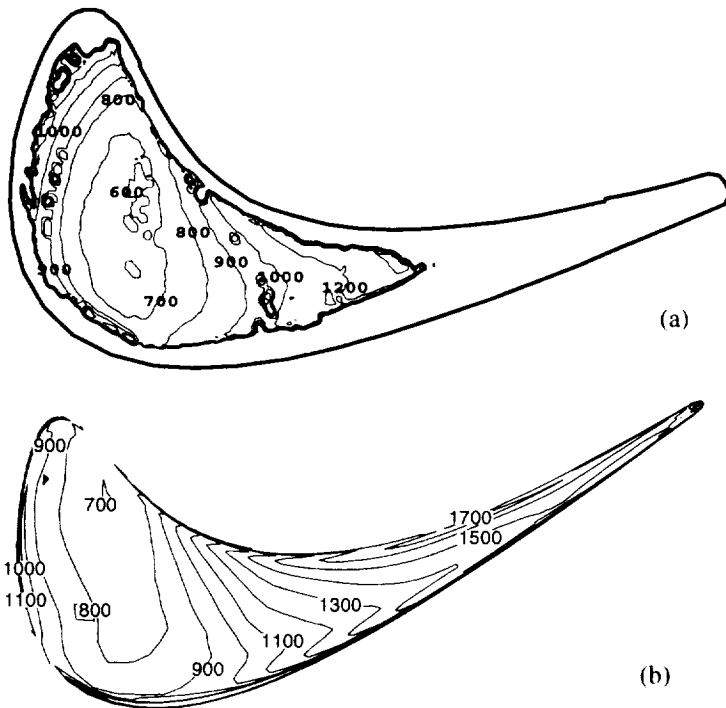

Fig. 12 Radiused edge blade tip heat transfer coefficient for 2.03 mm clearance and $Tu=5\%$. (W/m²/K), (a) Measured and (b) calculated

Figures 14(a) and 14(b) show the magnitude of the velocity over the blade tip at the mid gap location. The relative magnitude of the velocity between the two cases and the respective tip heat transfer rates are well correlated. This is especially true downstream of the mid chord. Ameri et al. (1998b) showed that the most influential factor in raising the rate of tip heat transfer is the magnitude of the velocity. This was shown by noting the change in the magnitude of the velocity as well as the turbulence intensity and the total temperature as the gap was widened.

SUMMARY AND CONCLUSIONS

In this paper the numerical prediction and comparison with the experimental data of tip heat transfer for a blade representing a first stage blade of a large power generation turbine was undertaken. The casing, upstream of the blade tip was recessed. It was found that for the calculation of blade tip heat transfer for the present experimental model of the tip, assumption of periodic flow was invalid and the entire passage had to be modeled. It was found that a good representation of the tip heat transfer can be made by our numerical method consisting of a cell centered finite volume scheme and a $k-\omega$ low Reynolds number turbulence model. The numerical results for the radiused edge blade agreed better with the experimental data. This could be due to the



REPORT DOCUMENTATION PAGEForm Approved
OMB No. 0704-0188

Public reporting burden for this collection of information is estimated to average 1 hour per response, including the time for reviewing instructions, searching existing data sources, gathering and maintaining the data needed, and completing and reviewing the collection of information. Send comments regarding this burden estimate or any other aspect of this collection of information, including suggestions for reducing this burden, to Washington Headquarters Services, Directorate for Information Operations and Reports, 1215 Jefferson Davis Highway, Suite 1204, Arlington, VA 22202-4302, and to the Office of Management and Budget, Paperwork Reduction Project (0704-0188), Washington, DC 20503.

1. AGENCY USE ONLY (Leave blank)		2. REPORT DATE April 1999	3. REPORT TYPE AND DATES COVERED Final Contractor Report	
4. TITLE AND SUBTITLE Heat Transfer and Flow on the First Stage Blade Tip of a Power Generation Gas Turbine Part 2: Simulation Results			5. FUNDING NUMBERS WU-523-26-13-00 NAS3-27571 NAS3-98106	
6. AUTHOR(S) A.A. Ameri and R.S. Bunker				
7. PERFORMING ORGANIZATION NAME(S) AND ADDRESS(ES) AYT Corporation 2001 Aerospace Parkway Brook Park, Ohio 44142			8. PERFORMING ORGANIZATION REPORT NUMBER E-11656	
9. SPONSORING/MONITORING AGENCY NAME(S) AND ADDRESS(ES) National Aeronautics and Space Administration John H. Glenn Research Center at Lewis Field Cleveland, Ohio 44135-3191			10. SPONSORING/MONITORING AGENCY REPORT NUMBER NASA CR-1999-209151 ASME 99-GT-283	
11. SUPPLEMENTARY NOTES Prepared for the 44th Gas Turbine and Aeroengine Congress, Exposition, and Users' Symposium sponsored by the International Gas Turbine Institute of the American Society of Mechanical Engineers, Indianapolis, Indiana, June 7-10, 1999. A.A. Ameri, AYT Corporation, 2001 Aerospace Parkway, Brook Park, Ohio 44142; R.S. Bunker, General Electric Corporation, R&D Center, Schenectady, New York. Project Manager, R. Gaugler, NASA Glenn Research Center, organization code 5820, (216) 433-5882.				
12a. DISTRIBUTION/AVAILABILITY STATEMENT Unclassified - Unlimited Subject Categories: 02 and 34 This publication is available from the NASA Center for AeroSpace Information, (301) 621-0390.			12b. DISTRIBUTION CODE	
13. ABSTRACT (Maximum 200 words) A combined experimental and computational study has been performed to investigate the detailed distribution of convective heat transfer coefficients on the first stage blade tip surface for a geometry typical of large power generation turbines (>100MW). This paper is concerned with the numerical prediction of the tip surface heat transfer. Good comparison with the experimental measured distribution was achieved through accurate modeling of the most important features of the blade passage and heating arrangement as well as the details of experimental rig likely to affect the tip heat transfer. A sharp edge and a radiused edge tip were considered. The results using the radiused edge tip agreed better with the experimental data. This improved agreement was attributed to the absence of edge separation on the tip of the radiused edge blade.				
14. SUBJECT TERMS Gas turbine; Blade tip; Heat transfer; Numerical simulation			15. NUMBER OF PAGES 13	
			16. PRICE CODE A03	
17. SECURITY CLASSIFICATION OF REPORT Unclassified	18. SECURITY CLASSIFICATION OF THIS PAGE Unclassified	19. SECURITY CLASSIFICATION OF ABSTRACT Unclassified	20. LIMITATION OF ABSTRACT	

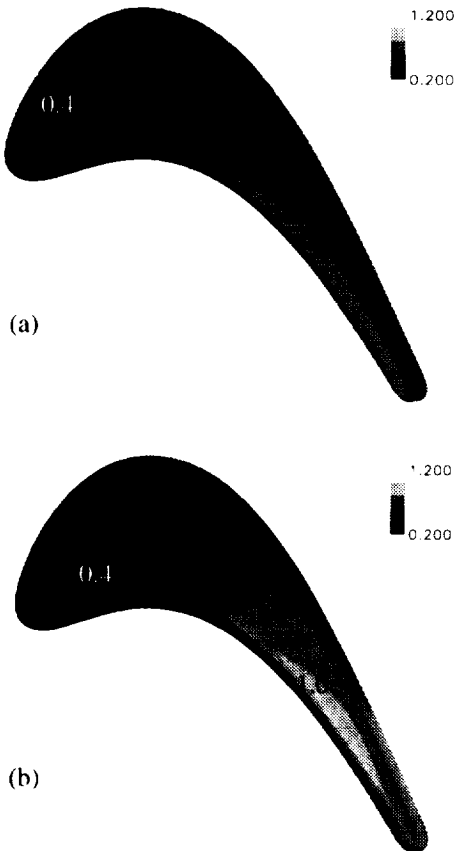

Fig.14 Magnitude of the velocity (V), at the mid gap height of the blade tip for (a) sharp edge blade and (b) for the radiused edge blade.

absence of separation on the blade tip for the radiused edge blade.

REFERENCES

- Ameri, Ali A., and Steinthorsson, E., 1995, "Prediction of Unshrouded Rotor Blade Tip Heat Transfer," ASME 95-GT-142.
- Ameri, Ali A., and Steinthorsson, E., 1996, "Analysis of Gas Turbine Rotor Blade Tip and Shroud Heat Transfer," IGTI 96-GT-189.
- Ameri, Ali A., and Steinthorsson, E., Rigby, David L., 1998a, "Effect of Squealer Tip on Rotor Heat Transfer and Efficiency," *Journal of Turbomachinery*, Vol. 120, pp 753-759.
- Ameri, A. A., Steinthorsson, E. and Rigby, D. L. 1998b, "Effects of Tip Clearance and Casing Recess on Heat Transfer

and Stage Efficiency in Axial Turbines," ASME paper 98-GT-369., to published in the *Journal of Turbomachinery*.

Arnone, A., liou, M.S., and Povinelli, L. A., 1991, "Multigrid Calculation of Three Dimensional Viscous Cascade Flows", AIAA Paper 91-3238.

Dunn, M. G., Kim, J. 1992, "Time-Averaged Heat Flux and Surface Pressure Measurements on the Vanes and Blades of the SSME Fuel Side Turbine and Comparison with Prediction for a Two Stage Turbine," *Journal of Turbomachinery*, Vol. 116, pp. 14-22

Dunn, M.G., Rae, W.J. and Holt, J.L. 1984a, "Time Measurement and Analyses of Heat Flux Data in a Turbine Stage: Part I- Description of Experimental Apparatus and Data Analysis," ASME Transactions, *Journal of Turbomachinery*, Vol. 106, No. 1, pp. 229-233.

Dunn, M.G., Rae, W.J. and Holt, J.L. 1984b, "Time Measurement and Analyses of Heat Flux Data in a Turbine Stage: Part II- Discussion of Results and Comparison with Predictions," ASME Transactions, *Journal of Turbomachinery*, Vol. 106, No. 1, pp. 234-240.

Garg, Vijay, K. and Rigby, David L., "Heat Transfer on a Film-Cooled Blade-Effect of Hole Physics", ASME 98-GT-404.

Menter, Florian R., 1993, "Zonal Two-Equation $k-\omega$ Turbulence Models for Aerodynamic Flows," AIAA-93-2906.

Metzger, D. E., Bunker, R. S. and Chyu, M. K., 1989, "Cavity Heat Transfer on a Transverse Grooved Wall in a Narrow Channel", *J. of Heat Transfer*, Vol. 111, pp. 73-79.

Rigby David, L., Ameri Ali, A. and Steinthorsson E., 1996, "Internal Passage Heat Transfer Prediction Using Multiblock Grids and $k-\omega$ Turbulence Model," IGTI paper 96-GT-188.

Rigby, D. L., Ameri A., A. and Steinthorsson E., 1997, "Numerical Prediction of Heat Transfer in a Channel with Ribs and Bleed," ASME 97-GT-431.

Schlichting, H. *Boundary Layer Theory*. McGraw-Hill, New York, seventh ed. pp. 312-313.

Steinthorsson, E., Liou, M. S., and Povinelli, L.A., 1993, "Development of an Explicit Multiblock/Multigrid Flow Solver for Viscous Flows in Complex Geometries," AIAA-93-2380.

Wilcox, D. C., 1994a, *Turbulence Modeling for CFD*, DCW industries, Inc. La Canada, CA.

Wilcox, D. C., 1994b, "Simulation of Transition with a Two-Equation Turbulence Model," AIAA Journal, Vol. 32, No.2, pp. 247-255.