

5/2 - 08

# Aeroelastic Tailoring for Stability Augmentation and Performance Enhancements of Tiltrotor Aircraft\*

Mark W. Nixon  
U.S. Army Vehicle Technology Directorate  
Langley Research Center  
Hampton, VA

David J. Piatak  
NASA Aeroelasticity Branch  
Langley Research Center  
Hampton, VA

Lawrence M. Corso  
Engineer, Rotor Dynamics  
Bell Helicopter Textron, Inc.  
Fort Worth, TX

David A. Popelka  
Group Engineer, Rotor Dynamics  
Bell Helicopter Textron, Inc.  
Fort Worth, TX

## ABSTRACT

The requirements for increased speed and productivity for tiltrotors has spawned several investigations associated with proprotor aeroelastic stability augmentation and aerodynamic performance enhancements. Included among these investigations is a focus on passive aeroelastic tailoring concepts which exploit the anisotropic capabilities of fiber composite materials. Researchers at Langley Research Center and Bell Helicopter have devoted considerable effort to assess the potential for using these materials to obtain aeroelastic responses which are beneficial to the important stability and performance considerations of tiltrotors. Both experimental and analytical studies have been completed to examine aeroelastic tailoring concepts for the tiltrotor, applied either to the wing or to the rotor blades. This paper reviews some of the results obtained in these aeroelastic tailoring investigations and discusses the relative merits associated with these approaches.

helicopters because of the limitations imposed by aerodynamic physics, there is hope that tiltrotor top-end and cruise speeds may increase further with improved engineering. Current limitations on speed for the V-22 tiltrotor are associated with control loads, control margins, and power, while the XV-15 tiltrotor is power limited. The aeroelastic stability of tiltrotor systems is also an important concern, as the stability margins associated with current tiltrotors are not far beyond the speed limitations set by loads and power today. It is anticipated that the upper velocity limit for future high-speed tiltrotors may be set by both loads and aeroelastic stability considerations. To achieve higher speeds for tiltrotors, structural tailoring of blades and wings using advanced composite materials has been considered in several past investigations.

## INTRODUCTION

Tiltrotor aircraft have advantages over conventional helicopters with respect to speed and range. While a helicopter is limited at high speeds by compressibility effects on the rotor advancing side and stall on the rotor retreating side, a tiltrotor converts from a helicopter mode to an airplane mode for high speed flight which is less restrictive in terms of adverse aerodynamic effects. For these reasons a typical tiltrotor can travel nearly twice as fast as a typical helicopter. Furthermore, while significant increases in airspeeds are unlikely to be provided for

Researchers at Langley Research Center and Bell Helicopter have devoted considerable effort to assess the potential for using composite materials to obtain aeroelastic responses which are beneficial to the important stability and performance considerations of tiltrotors. Both experimental and analytical studies have been completed which examine aeroelastic tailoring concepts for the tiltrotor, applied either to the wing or to the rotor blades. This paper reviews some of the results obtained in these aeroelastic tailoring investigations and discusses the relative merits associated with these approaches. While the material presented in this report focuses on activities at NASA Langley Research Center (LaRC) and Bell Helicopter, the research efforts of other organizations are included in the discussions when appropriate. The report is organized into four major sections: tiltrotor aeroelastic design considerations, wing aeroelastic tailoring studies, rotor blade aeroelastic tailoring studies, and a summary which includes a discussion on the relative merits of wing versus blade tailoring.

Presented at the CEAS / AIAA / ICASE / NASA LaRC International Forum on Aeroelasticity and Structural Dynamics, June 22-25, 1999. This paper is declared a work of the U.S. Government and is not subject to copyright protection in the United States.

## TILTROTOR AEROELASTIC DESIGN CONSIDERATIONS

To help explain the aeroelastic tailoring investigations to be discussed in this paper and the reasons these studies have been conducted, this section of the paper addresses the aeroelastic challenges which have driven current designs associated with tiltrotor blades, hubs, and wings.

### Rotor System Aeroelasticity Considerations

**Rotor System Type.** The significant changes in configuration, aerodynamics, and system frequencies associated with the tiltrotor flight envelope make rotor system design an even more challenging prospect for tiltrotors than for conventional helicopters. The most critical achievement for successful implementation of the tiltrotor to date has been the development of the gimbaled rotor system, used in conjunction with the constant velocity joint. This combination of hub and joint solves three fundamental problems which are associated with tiltrotor design: 1) the gimbal joint can accommodate large flapping as is required to produce adequate control power for maneuvers in helicopter mode, 2) the constant velocity joint eliminates the 2P ( $P = \text{rotor rotational frequency}$ ) drive system torsional loading due to the Hookes-joint effect, and 3) for a gimbaled hub the blade rotational velocity vector tilts when flapping occurs to remain approximately perpendicular to the blade tip path plane, greatly reducing the Coriolis forces normally encountered with blade flapping.

While the use of bearingless, hingeless, or articulated rotors may eventually prove fruitful for application to tiltrotors, there are several characteristics of these systems which have made them an undesirable option for tiltrotor application to date. The use of hingeless and bearingless rotor systems is not currently feasible because of the large flapping requirements associated with tiltrotor control in the helicopter mode. Adequate control power requires about  $8^\circ$  degrees of flapping on current systems while these types of hubs are limited to about  $4^\circ$ . A bearingless system would have the additional problems associated with addressing the large pitch changes required of the tiltrotor control system. The articulated rotor hubs tend to be larger and heavier than other types of hubs. Weight is an issue that is driving many modern hubs away from articulated design even for conventional rotorcraft, and the profile drag associated with these hubs is an even more significant problem for tiltrotors because of the high-speed airplane mode configuration. Bearingless, hingeless, and articulated rotor systems are also susceptible to several fundamental design problems associated with frequency placement, air resonance, and

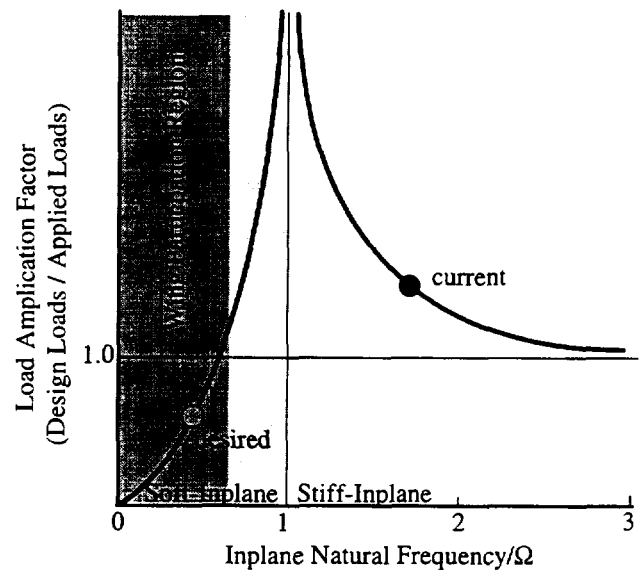

Figure 1: Load factor associated with inplane natural frequency of rotor systems.

Coriolis-based instabilities as is addressed in references 1 and 2. Lastly, and perhaps most significantly, these three rotor systems are generally soft-inplane (fundamental lag frequency below the design rotor speed  $\Omega$ ) where the issues of ground and air resonance can create significant problems with tiltrotors for which an acceptable solution has not yet been determined.

A soft-inplane rotor is desirable from a loads perspective, as is illustrated in the diagram of figure 1. This diagram indicates the approximate load amplification factor associated with current stiff-inplane tiltrotor systems and shows the loads advantage associated with developing a soft-inplane rotor, which becomes significant when the lag frequency is below about 0.7 per rev. These loads reductions can also lead to significant reductions in structural weight of the blades, hub, and pylon. The shaded region of the diagram shows the potential for ground resonance conditions which occur below 1P, and the darker shaded region indicates the approximate lag frequency range in which the elastic wing modes are likely to participate in the ground resonance. The potential involvement of elastic wing modes makes design of soft-inplane rotor systems a particularly difficult problem for tiltrotors.

Ground resonance is a mechanical instability in which the inertial coupling between the inplane blade lag mode and a fixed-system mode (which contains significant hub inplane participation) produce an increasing response as the frequencies of these coupled modes coalesce during rotor wind-up. This instability can only occur when the blade lag mode frequency is below 1P (soft-inplane)

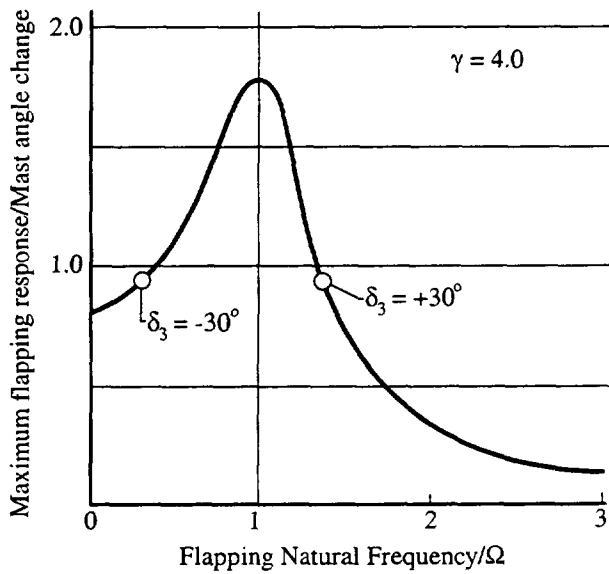

Figure 2: Effect of flapping natural frequency and  $\delta_3$  on transient flapping response.

and occurs when the coupled fixed-system frequency approaches the regressive low frequency lag mode ( $\Omega - \omega_L$ ). The conventional solution to this instability is to provide damping to both the rotor lag mode and the associated fixed system modes that contain hub inplane motion. For example, helicopters with articulated rotor systems generally have dampers in the rotor hub attached across the lead-lag hinge and either dampers or highly-damped structural components in the ground support structure. For a tiltrotor, in addition to the rigid body modes, the wing elastic modes can couple with the rotor lag motion to cause ground resonance, and because these modes are elastic the addition of damping is a more difficult prospect. Because soft-inplane rotors are subject to ground and air resonance, and to a lesser extent because these systems tend to have lower whirlflutter stability margins, the stiff-inplane rotor system has been the preferred choice to date for tiltrotors.

**Pitch-Flap Coupling.** The natural flapping mode of a gimbal rotor system in-vacuum is at the rotation frequency (1P), and the addition of gimbal hub springs does not significantly change this frequency. This resonant condition creates large flapping and high blade loads in flight, and therefore requires the use of pitch-flap coupling to create an aerodynamic spring force to move the rotor system flap frequency away from 1P, as may be approximated by the fundamental flapping equation as

$$\omega_\beta = \sqrt{1 + \frac{\gamma \tan \delta_3}{8 \cos \phi_3}} \quad (1)$$

where  $\gamma$  is the Lock number,  $\delta_3$  is the pitch-flap skew angle, and  $\phi_3$  is the inflow angle at the blade 75% station. The landmark paper of reference 3 discusses the advantages and disadvantages of using either positive or negative pitch-flap coupling to accomplish the task of moving the fundamental flap frequency away from 1P for a variety of rotor systems. This study also shows that use of the more conventional positive  $\delta_3$  (flap-up produces pitch-down blade motion) on a stiff-inplane proprotor results in a flap-lag blade instability for high inflow conditions (airplane mode). This instability occurs because positive  $\delta_3$  creates an aerodynamic-based increase in the flapping stiffness, leading to an eventual coalescence of the flapping and inplane blade frequencies as the collective is increased with airspeed. A negative  $\delta_3$  (flap-up produces pitch-up blade motion) eliminates the flap-lag instability by separating the flapping and inplane blade frequencies experienced during these conditions, and is just as effective as positive  $\delta_3$  in reducing the maximum transient flapping response associated with mast motion, as is illustrated in figure 2.

Rotor system design must also consider an important series of trade-offs between stability margin and blade loads (leading to higher structural weight) which are associated with the magnitude of pitch-flap coupling, rotor precone, and blade frequency placements. As indicated in the previous paragraph, there is a minimum magnitude of pitch-flap coupling which is acceptable to control flapping response and associated inplane blade loads. However, the addition of pitch-flap coupling is destabilizing for whirlflutter, and a compromise in the magnitude of  $\delta_3$  must be obtained. For gimballed rotor systems, the blade spacing places constraints on the range of  $\delta_3$  which can in practice be used. The  $\delta_3$  used on both the XV-15 and V-22 tiltrotors is  $-15^\circ$ .

**Pitch-Lag Coupling.** Rotor precone serves to lessen the blade root bending moments during high disk loading operations such as helicopter hover. For airplane cruise the disk loading is an order of magnitude lower, and this serves to create a large centrifugal-force induced coupling between blade pitch and lag motions, as is illustrated in figure 3. In this figure  $\beta_p$  is the precone angle,  $dL$  is the local aerodynamic lift distribution,  $dm$  is the local distributed mass of the blade,  $r$  is the spanwise position along the blade, and  $\eta$  is the lag angle deformation. The pitch-lag coupling defined by these parameters is generally very destabilizing for whirlflutter as will be shown in later sections of this paper. The invention of the coning-hinge and flexured gimbal hubs by Bell Helicopter (initial tests of this hub type are discussed in reference 4) have

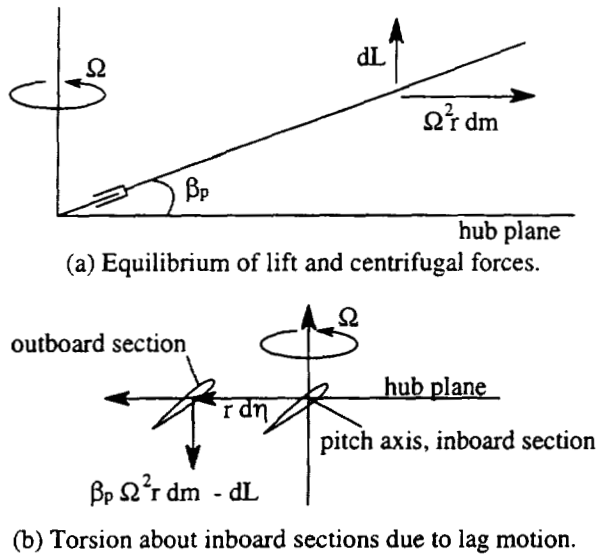

Figure 3: Effect of precone on pitch-lag coupling.

lessened the effect of precone-related pitch-lag coupling by allowing the rotor system to flatten out (lower effective precone) in low disk loading conditions. This reduces the pitch-lag coupling effects on whirlflutter stability, leading to higher stability boundaries.

**Blade Dynamics.** Blade structural design for tiltrotors presents a very significant engineering challenge. The high number of constraints placed on the design and the importance of the frequency placement over a wide range of dynamic operating conditions creates a number of structural tailoring opportunities. The aerodynamic design, which is itself a complex compromise among design conditions, defines the shell into which the structural material must fit, creating upper and lower limits on aspirations for stiffness and mass tuning. The fundamental rotor flap, lag, and torsion frequencies must have adequate separations from harmonics of the two design rotor speeds to avoid high loads and vibration. Additionally, the movement of the blade frequencies between the two main design conditions must be considered so that significant resonances and destabilizing frequency crossings will not occur.

**Blade Loads.** An important driver for blade and hub design on stiff-inplane rotor systems is the oscillatory chord bending moments produced during maneuvers that are associated with large aircraft pitch rates, such as a symmetric dive and pull-up. These loads have been a concern for both the XV-15 and the V-22 tiltrotors as discussed in references 5 and 6, respectively. High rotor pitch rates can create blade stall which intensify the blade aerodynamic loads in both the flapwise and chordwise directions (chord loads are significant due to the high blade

twist and high pitch angles associated with proprotors). While these loads are alleviated in the out-of-plane direction due to presence of the gimbal, the in-plane loads are not alleviated and can significantly influence structural design for the rotor. As the blade and hub design is strengthened to account for these inplane loads, there is generally an associated increase in overall weight. Alternative approaches to solving the rotor loads issues are to 1) develop a soft-inplane rotor system whereby the in-plane loads are alleviated through lag motion about a virtual hinge, or 2) limit the inplane loads by controlling the pitching of the rotor system. The inplane loads associated with both the XV-15 and V-22 have been reduced using the latter. The study of reference 6 discusses the development of flight control systems for the V-22 which reduce the steady and oscillatory chord bending moments on the hub yoke which were found to exceed limit loads for the 5.7g maximum aerodynamic capability of the aircraft. Structural-load-limiting has been designed into the V-22 digital fly-by-wire control system to reduce the maximum load factor of the aircraft to 4g during pull-up maneuvers and reduce the rotor chordwise loads by limiting the rotor disk angle of attack through control of the longitudinal pitch motion of the aircraft.

### Wing Aeroelasticity Considerations

There are several significant aeroelastic design considerations for a tiltrotor wing which make it more complicated than a conventional fixed-wing aircraft. One important influence on wing design is the stability margins imposed by whirlflutter. Whirlflutter is generated by the large oscillatory aerodynamic and dynamic forces of the rotor system which couple with the wing motion to modify classical wing flutter aeroelastic behavior. Whirlflutter considerations lead to much stiffer and thicker wing designs than those associated with conventional aircraft.

**Wing Dynamics.** Whirlflutter stability margins are greatly influenced by the dynamics of the wing and associated components which can affect hub motion such as stiffnesses of the transmission adapter, mast and pylon, downstop, conversion spindle, and wing root. The downstop has a particularly significant influence on aeroelastic stability because this mechanism effectively locks the pylon to the wing in airplane mode, resulting in a sharp change in wing frequencies. When the pylon is not engaged with the downstop then the stiffness of the pylon attachment to the wing is governed by stiffness of the conversion actuator. Typically, with the downstop engaged, the wing torsion and beam frequencies have much greater separation and the associated whirlflutter stability boundaries are significantly higher as is shown in figure 4.

As in classical fixed-wing design, and as suggested by

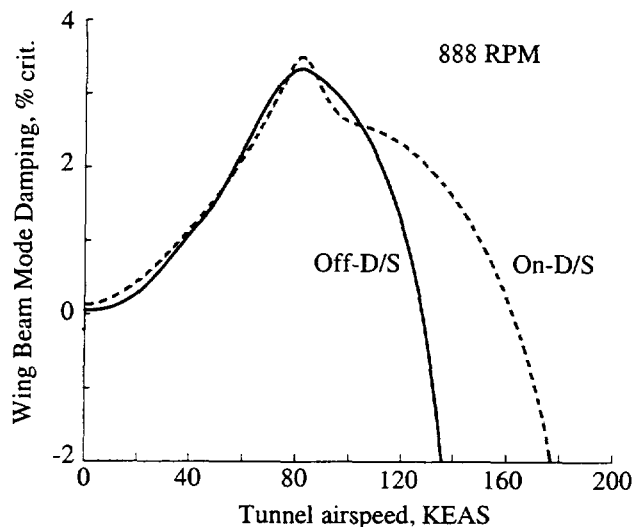

Figure 4: Comparison of predicted damping for the off-downstop and on-downstop configurations of the WRATS tiltrotor model.

the discussion in the previous paragraph, the separation of the fundamental beam and torsion frequencies plays an important role in the aeroelastic stability of a tiltrotor wing. This effect has been studied both analytically as in reference 7 and experimentally using reduced stiffness wings as discussed in reference 8. The plot of figure 5 shows how changes in wing beam stiffness influences stability boundaries associated with the fundamental wing modes. The dominant effect is a drastic lowering of the wing beam mode stability boundary with an increase in the wing beam stiffness, and this occurs because there is no corresponding increase in the wing torsion stiffness such that the beam and torsion wing frequencies move closer together. The plot of figure 6 shows that an increase in torsion stiffness is more beneficial than an increase in beam stiffness in terms of increased stability boundaries, but there are other flutter modes that can become dominant. In the example of figure 6, the stability boundary associated with the wing chord mode is only slightly higher than that associated with the wing beam mode, such that improvements to the beam-torsion aeroelasticity only raises the flutter boundaries to that associated with the wing chord mode. This is a typical problem in tiltrotor wing aeroelastic design. The chord mode instability is generally in the same vicinity as that associated with the beam mode, but it is common that improvements to one of the stability modes, either beam or chord, will have a negligible influence on the other, resulting in a smaller total improvement in stability margin than might otherwise be expected.

**Wing Thickness.** While there have been numerous

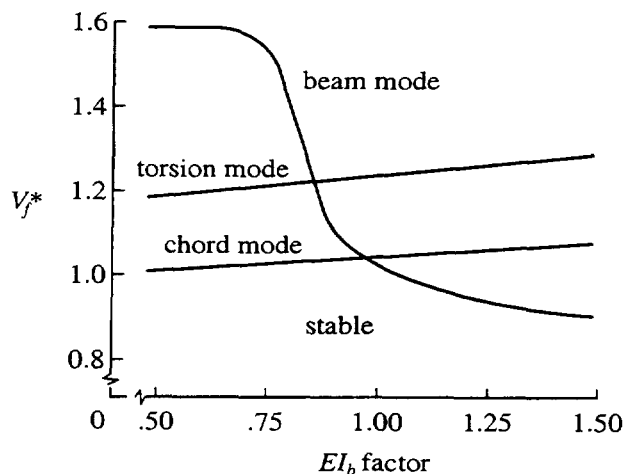

Figure 5: Effect of change in wing beam bending stiffness on tiltrotor stability.

analytical studies and model tests to expand aeroelastic stability boundaries, the current limits on tiltrotor top-end speeds are associated with control loads and power available. Many efforts to improve tiltrotor top-end speed have focused on reduction of profile drag so that higher speeds may be obtained using current power available. While a thin wing is desirable for high-speed performance, stiffness and fuel capacity considerations often require a thick wing design. Current wing thickness for tiltrotors is about 23%  $t/c$  while an 18%  $t/c$  ratio is desirable for high-speed and long-range designs as is discussed in reference 9.

**Wing Sweep.** Tiltrotor wings have a small forward sweep to increase flap clearance between the rotor blades and wing in airplane mode. While forward sweep creates divergence concerns for conventional aircraft, this concern is not influential in tiltrotor wing design due to high bending and torsion stiffness requirements for aeroelastic stability. Divergence speeds of current tiltrotor aircraft are predicted to be well above Mach 1. The wing sweep also creates separation between the blade and wing which helps reduce the NP harmonic loads created by the passage of the blades near the wing as is discussed in reference 10. The flow field near the wing is affected by lift produced by the wing, and blockage of the freestream flow by both the wing and fuselage. As each blade is subjected to this flow field for only a short period of azimuthal sweep there is a localized change in angle of attack resulting in significant 1P and higher harmonic loads on each blade. These blade loads sum to produce significant NP fixed-system loads which can be a concern for wing design as these loads are translated from the rotor into the pylon, along the wing, and into the airframe. Because of stiffness requirements for aeroelastic stability, much of the wing design is not influenced by these harmonic loads,

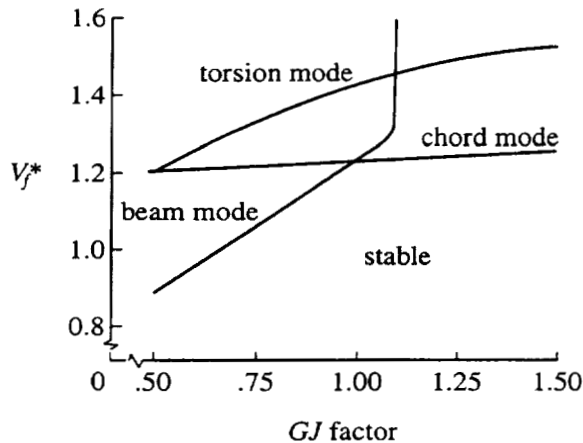

Figure 6: Effect of change in wing torsional stiffness on tiltrotor stability.

but some wing components are fatigue critical and are thus adversely affected by the NP loads. Specifically, the 3P loading on the three-bladed XV-15 and V-22 tiltrotors have created some design challenges with respect to engine loads and downstop loads.

## AEROELASTIC TAILORING OF TILTROTOR WINGS

### Tailored Wing Feasibility Study

When considering only airframe contributions, the two most important factors affecting proprotor stability are the frequencies and mode-shapes of the wing bending and torsion modes. The wing stiffnesses requirements associated with whirlflutter are typically as demanding as the wing strength requirements, as is discussed in a previous section of this paper. The whirlflutter stability is sensitive to the pitch/bending coupling (referring to the rotor hub pitch motion relative to its vertical translation) associated with the wing mode shapes, and this coupling can be controlled by several factors including: relative frequency placement of the wing modes, offset of the pylon center of gravity relative to the wing elastic axis, and structural bending/torsion coupling of the wing torque box.

To meet stability requirements, conventional tiltrotor wing designs use thick wings (23%  $t/c$ ) that efficiently provide high torsional stiffness at minimum weight. To improve tiltrotor high-speed performance and productivity, it is desirable to reduce the wing thickness ratio ( $t/c$ ) without increasing the weight. Performance analyses show that reducing the wing thickness to 18%  $t/c$

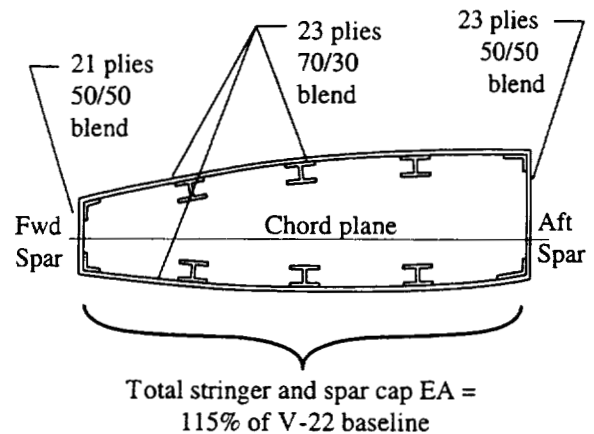

Figure 7: Final 18%  $t/c$  three-stringer design.

decreases the airframe drag by 10% and provides a substantial improvement in aircraft productivity. For a conventional tiltrotor wing design, reducing the wing thickness ratio also decreases the stability boundary due to the loss in stiffness. The stability boundary can be recovered by adding structure to increase the stiffness and restore the mode shapes and frequency placement; however, the additional weight reduces aircraft productivity. Composite tailoring provides an opportunity to increase the stability of tiltrotors with thin wings, without incurring a large weight penalty by favorably modifying the mode shapes and frequency placement of the fundamental wing modes.

The study of reference 11 considered the feasibility of a composite tailored wing for a 40-passenger civil tiltrotor. This study was conducted by Bell Helicopter under a 1993 NASA LaRC contract, and the objective was to apply composite tailoring to the design of a tiltrotor wing to achieve the aeroelastic stability requirements at reduced wing thickness for improved performance and aircraft productivity. The baseline configuration used in the study was the V-22 tiltrotor wing because the math models representative of an actual design in which the rotor, fuselage, wing, and pylon structural parameters are fully developed and accurately known provide the most realistic assessment of the benefits of composite tailoring. Design variables included wing skin and spar web laminate composition, stringer and spar cap area distribution, and wing thickness ratio. Parametric studies were conducted of each design variable to provide a basis for the design of a composite tailored 18%  $t/c$  wing which satisfied the proprotor stability goals with minimum weight.

Realistic constraints on the design were provided by using the codes used in the actual design process of the V-22. The structural model was developed using NAS-TRAN along with specialized pre and post processors for

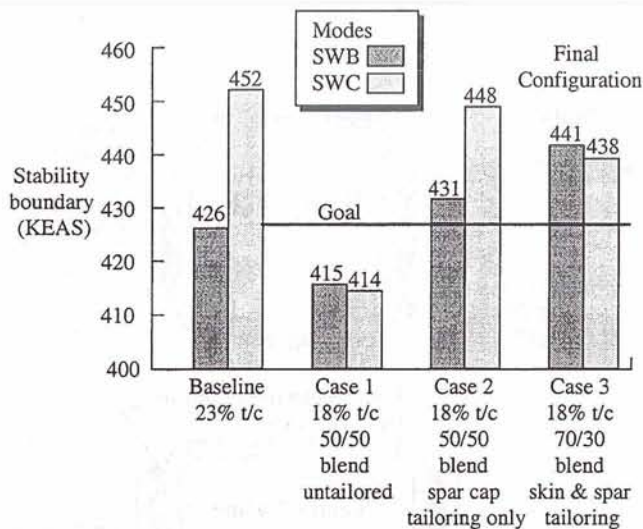

Figure 8: Tailored wing stability summary.

laminar analysis, structural loads analysis, stress analysis, and weight calculations. The natural frequencies and mode shapes associated with the NASTRAN model provided input into Bell's proprietary aeroelastic analysis code, ASAP (Aeroelastic Stability Analysis of Propellers), which also included input parameters defined by the rotor system, drive system, and flight control system.

Elastic couplings were developed in the parametric study by adjusting the ratio of +45° plies relative to the number of -45° plies while maintaining the existing number of 0° and 90° plies of the baseline laminates. A blend ratio was defined to indicate the amount of coupling in the laminate: a 50/50 blend of +45° and -45° would be balanced while a 100/0 blend would provide the maximum elastic coupling for the laminate construction considered. Results of adjusting blend ratios uniformly for all the wing components showed that stability boundaries of the wing beam bending mode (SWB) reached a peak between ratios of 70/30 and 80/20. However, stability boundaries of the wing chord mode were decreased as the blend ratio moved away from 50/50 because of a reduction in effective chord bending stiffness associated with the elastic coupling. To compensate for the loss in chordwise stiffness, the parametric studies considered moving up to 50% of the stringer cap cross-section area into the forward and rear spar caps where the blend ratios were held at 50/50 to maintain chordwise bending stiffness. The blend ratios of the upper and lower wing skins were held at 80/20 for this part of the study, and the results showed that adequate stability margins could be maintained using this approach. Strength analyses led to increasing the number of stringers in the wing from 2 to 3 so as to prevent buckling of the skin panels, and negative

margins of safety in the skin panels required addition of two additional skin plies.

The final design configuration developed based on the parametric study is defined in figure 7. It used a balanced laminate in the forward and aft spars to maintain chordwise stiffness while using a blend ratio of 70/30 in the upper and lower skins to achieve the optimum pitch/bending coupling to improve stability of the wing beam bending mode with respect to whirlflutter. Stress analysis determined that a three-stringer configuration with two additional skin plies were required to satisfy strength constraints. The resulting weight is nearly equivalent to that of the 23% t/c baseline, increasing by only 1.2%. The most significant results of the study are illustrated in figure 8 which show that the stability boundaries associated with the high-performance 18% t/c wings can actually be improved over that of the 23% t/c baseline.

### Tailored Wing Wind-Tunnel Study

Encouraged by the results of the full-scale composite tailored wing study of reference 11 as discussed above, a model-scale test program was initiated to validate the composite tailored wing concept. The model test program was a joint effort between NASA Langley Research Center (LaRC) and Bell to evaluate the stability characteristics of a tiltrotor with a composite tailored wing. During the model program, two wind tunnel tests were conducted at the NASA LaRC Transonic Dynamics Tunnel (TDT) in Hampton, Virginia. For the wind tunnel tests, the Wing and Rotor Aeroelastic Test System (WRATS) was used as the test bed. This model originated from the 1/5-size Froude-scaled aeroelastic model of the V-22, which was designed by Bell during the full-scale development and used for flutter clearance tests of the aircraft. The first test of the WRATS model occurred during August 1995 and established baseline aeroelastic stability boundaries for a tiltrotor with a conventional untailed wing design. The wind-tunnel model represented a tiltrotor with a 23% thick conventional wing, pylon, and rotor system and was configured in airplane mode so that high speed stability could be evaluated. Figure 9 shows the aeroelastic model mounted to the tunnel support structure.

For the second TDT entry, a composite tailored wing was designed and fabricated by Bell to dynamically represent a full-scale composite tailored wing with a t/c ratio of 18%. The composite tailored wing and the baseline wing are interchangeable on the model, thus maintaining the same pylon, rotor, control system, and drive system characteristics in each test. The second TDT entry occurred in December 1995 and measured the aeroelastic stability of the composite tailored wing.

The 1/5-size baseline semi-span wing was designed around a central spar which provided the stiffness requirements necessary to dynamically represent the scaled

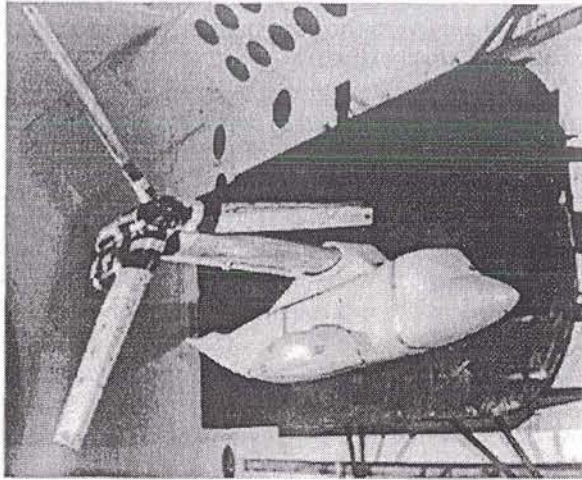

Figure 9: WRATS  $\frac{1}{5}$ -size aeroelastic wind-tunnel model mounted in the NASA LaRC TDT.

stiffness properties of the full scale V-22 with a 23%  $t/c$  ratio. The full-scale design used a five-stringer carbon epoxy wing box with balanced laminates. For the model, carbon epoxy roving was wound at  $\pm 45$  deg to form a graphite torsion box with constant rectangular cross section. Additional beamwise and chordwise stiffness was obtained by bonding unidirectional carbon epoxy stiffeners to the sides of the torque box. Aluminum T-section flanges provided support for the nonstructural wing panels and increased the chordwise stiffness to the desired target values. The general construction of the wing torque box cross section is shown in comparison to the baseline design in figure 10. The model wing and full-scale wing provide no structural bending-torsion coupling attributable to the use of balanced laminates. Greater details of the construction process, tuning of the model, and NASTRAN finite element modeling of the structure are reported in reference 9.

#### Analytical Modeling and Stability Predictions.

The Bell Aeroelastic Stability Analysis of Proprotors (ASAP) code was used to predict the wing/pylon/rotor stability speed for tiltrotor aircraft in airplane mode flight. ASAP has shown good correlation with wind tunnel tests as described in reference 12 and full-scale V-22 flight test data as described in reference 13. ASAP performs a linear eigenvalue analysis based on the dynamic coupling of the rotor, airframe, drive system, and control system. The math model representation for each element used in the ASAP analysis is briefly described in the following paragraphs.

The rotor is modeled in ASAP by using a lumped parameter rigid-blade analysis, with hinges and springs for representing the flap, lag, and coning degrees of freedom. Rotor cyclic flapping motion is modeled as a hub

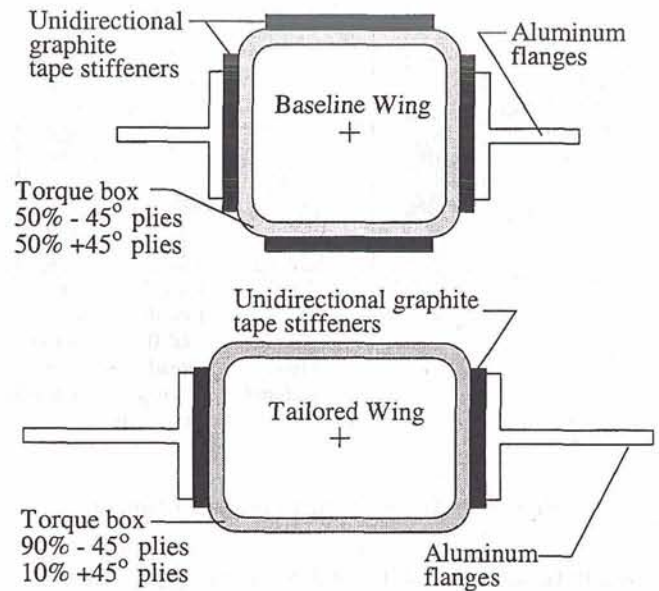

Figure 10: Comparison between baseline and tailored wing cross sections.

gimbal degree of freedom. Discrete coning and lead-lag hinges model the elastic bending of the blade to form the collective coning and cyclic inplane modes, respectively. Blade feathering motions are computed through kinematic relationships which include pitch/flap, pitch/cone, and pitch/lag coupling. These coupling parameters are calculated external to ASAP using fully coupled elastic rotor blade analyses to enhance the simple blade modeling approach used in ASAP. The rotor aerodynamics are calculated using quasi-steady strip theory aerodynamics, with constant chord and constant airfoil, and assumes uniform axial flow so that the equations have constant coefficients.

The airframe dynamics model consists of elastic modes derived from a NASTRAN finite-element-model (FEM) of the structure. For stability analysis, mode shapes at the rotor hub and control plane are required and input to ASAP. Structural and aerodynamic damping values of the airframe are measured from ground vibration tests and "rotors-off" wind tunnel tests. The drive system was disconnected during the wind tunnel tests which allowed the rotor to rotate freely in a windmill state. Previous tests as described in reference 4 have shown that an unpowered model can be used to accurately represent the powered flight condition when measuring stability boundaries in airplane mode.

The ASAP program generates plots of frequency and



damping verses airspeed which are used as pretest predictions for the wind tunnel tests. Stability speed predictions were calculated for the baseline and tailored wings at four critical design conditions, (1) pylon on the downstop at 84% RPM, (2) pylon on the downstop at 100% RPM, (3) pylon off the downstop at 84% RPM, and (4) pylon off the downstop at 100% RPM; where 84% RPM represents the airplane cruise rotor speed and 100% RPM represent the normal helicopter mode rotor speed.

**Test Results and Correlation with Analysis.** During the wind tunnel tests of the baseline and tailored wings, frequency and damping data were recorded for the fundamental wing bending modes. The frequency was determined using an on-line spectral analyzer. The wing beam, chord, or torsion mode was excited at the natural frequency using a heavy-gas pulse-jet excitation system mounted on the tip of the wing. The wing bending gage output was recorded on strip chart recorders and the TDT data system. The fixed system damping was determined from the time history decay of the bending gage output following the excitation. The damping was computed using two different methods: hand calculations were performed on the strip chart decay traces using a log decrement calculation, and analysis was performed on the digitized time history using an on-line Moving Block analysis (reference 14).

Typical correlation plots between measured and predicted frequencies and damping are shown in the plots of figure 11 for the TDT entry of the tailored wing. These plots represent the correlation for the tailored wing in the off-downstop configuration with a rotor speed of 84% RPM. Figure 11 shows the damping verses airspeed for the beam and chord modes, respectively. The damping predictions for the fundamental wing beam modes track well with increasing airspeed. An instability was recorded in the beam mode at 155 Knots Equivalent Airspeed (KEAS) which corresponds to about 347 KEAS full-scale. The ASAP analysis agrees well with the measured subcritical damping values and stability boundary.

To quantify the effects of composite tailoring on stability, the stability boundaries for the baseline and tailored wing were measured at several airspeed and rotor speed combinations. With the wind tunnel and model stabilized at a certain airspeed, the rotor speed was gradually increased in 5-10 RPM increments until a neutral damping condition was reached. This procedure was repeated until the stability boundaries were defined throughout the operating range of the rotor as shown in figure 12. A direct comparison between the baseline and tailored wing stability boundaries shows an increase of approximately 30 KEAS (58 KEAS full-scale). For a full-scale design, the 58-kt increase in stability boundary represents a significant stability improvement.

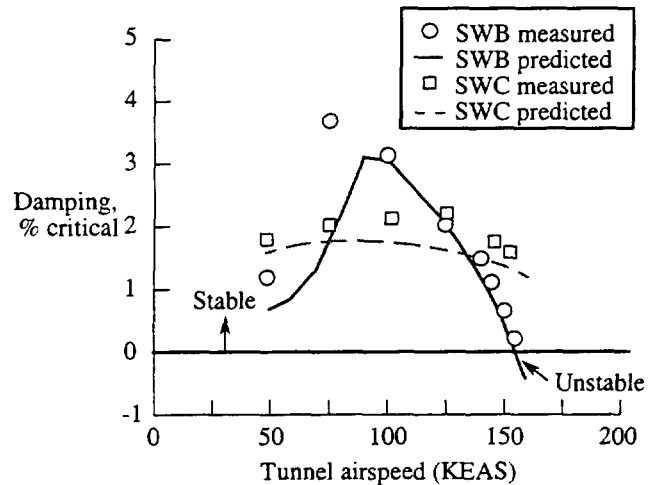

Figure 11: Comparison of analysis and test results for the off-downstop configuration.

### Tailored Wing / Soft-Inplane Rotor Study

An analytical investigation of aeroelastic tailoring for stability augmentation of soft-inplane tiltrotors is being conducted at Penn State through a NASA LaRC Graduate Student Researcher Program (GSRP) grant. Some preliminary results of this study, as reported in reference 15, show that aeroelastic tailoring of the tiltrotor wing may be used to stabilize an air resonance instability associated with the Boeing Model 222 soft-inplane hingeless tiltrotor system. This particular system was free from any ground resonance instability, as discussed in reference 2, because the low frequency cyclic lag mode did not couple with the wing chord mode until a rotor speed of 1060 RPM was reached, which is well above the design rotor speed for this model. The wind-tunnel model could, however, experience an air resonance in low-speed airplane mode when subjected to a rotor speed sweep. The resonance would occur due to coupling of the wing beam bending mode (the wing mode of interest in airplane mode since it couples with the rotor inplane motion) with the low-frequency lag mode around 500 RPM. The Penn State investigation showed that the addition of beamwise-bending-twist coupling in the wing could be either stabilizing or destabilizing to the resonance, depending on the sign of the coupling used, as shown in figure 13. The positive bending-twist-coupling (bending up pitches hub up) in the amount considered shows that the air resonance may be completely stabilized. Positive beam-bending-twist coupling is, however, destabilizing to whirlflutter. Further analyses are to be performed under this grant to determine if a suitable compromise may be

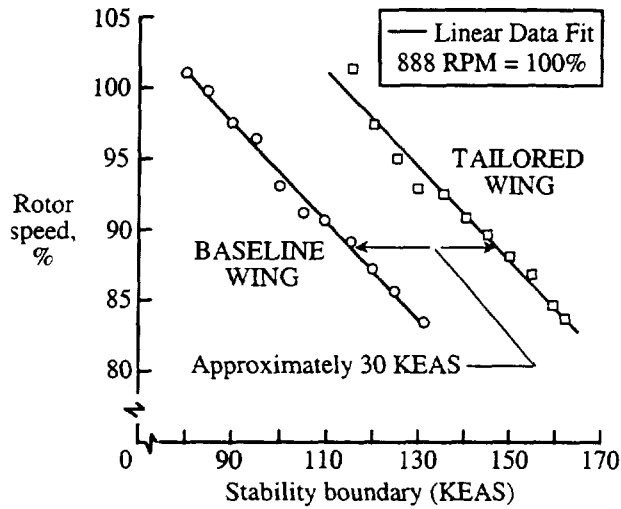

Figure 12: Comparison of measured stability boundaries for the baseline and tailored wings in the off-downstop configuration.

achieved between the stabilizing and destabilizing influences associated with wing aeroelastic tailoring.

## AEROELASTIC TAILORING OF TILTROTOR BLADES

### General Anisotropic Rotor Blade Modeling

There is a potential for improving the performance and aeroelastic stability of tiltrotor aircraft through the use of elastically-coupled composite rotor blades. An important aspect of achieving these potential improvements is the development of analyses which properly model the complex effects associated with elastic couplings. Currently, comprehensive aeroelastic rotorcraft codes, because of their complexity and size, are limited to modeling the elastic rotor blade using a one-dimensional (beam) theory. Thus, there has been an emphasis on deriving one-dimensional generally anisotropic beam theories which can capture the important characteristics of anisotropic composite rotor blades, structures that are more readily defined using two and three-dimensional theories. With improved cross-section analyses and beam theories that include effects associated with warping, shear deformation, large pretwist, and anisotropy (such as those presented in references 16-18) there are few rotor blade structures, including the flexbeam, that cannot be accurately modeled using beam theory, at least in terms of predicting the global response, dynamic characteristics, and aeroelastic stability of rotor systems.

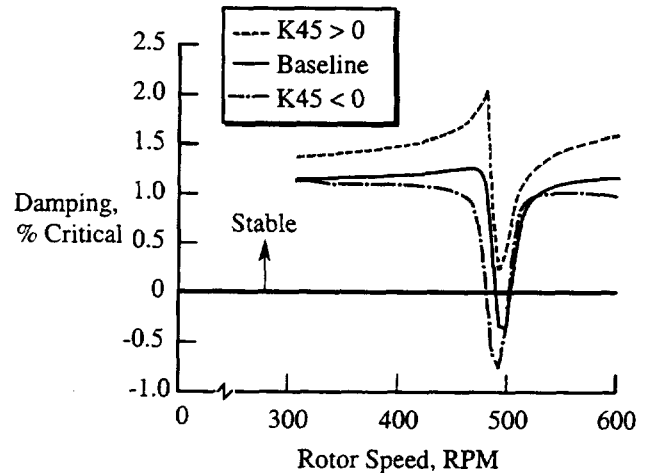

Figure 13: Influence of wing beamwise-bending-twist coupling on tiltrotor air resonance.

In developing a rotor blade design with elastic couplings it is desirable to maintain favorable elastic and dynamic characteristics of the blades, especially if a baseline system is used as a template for the elastically tailored design. The study of reference 19 provides a valuable resource for estimating the limits to which elastic couplings may be introduced into a baseline rotor blade, considering simultaneously the important constraints on changes to blade stiffness characteristics. A cross-section analysis such as that described in reference 18 can provide the coupled stiffness matrix of a general anisotropic beam as

$$\begin{bmatrix} k_{11} & k_{12} & k_{13} & k_{14} \\ k_{21} & k_{22} & k_{23} & k_{24} \\ k_{31} & k_{32} & k_{33} & k_{34} \\ k_{41} & k_{42} & k_{43} & k_{44} \end{bmatrix} \begin{Bmatrix} e \\ k_{\eta} \\ k_{\zeta} \\ \theta \end{Bmatrix} = \begin{Bmatrix} P \\ M_{\eta} \\ M_{\zeta} \\ M_z \end{Bmatrix} \quad (2)$$

where  $[k]$  is the symmetric coupled stiffness matrix;  $e$ ,  $k_{\eta}$ ,  $k_{\zeta}$ , and  $\theta$  are the displacements in the extensional, chord-bending, flap-bending, and twist directions, respectively; and  $P$ ,  $M_{\eta}$ ,  $M_{\zeta}$ , and  $M_z$  are the forces in the same respective directions. Many cross-section analyses will provide two additional degrees of freedom relating the shear strains and shear forces for the beam, but these may be statically condensed to the 4x4 representation above as is described in reference 20. For an isotropic, untwisted beam the elastic twist is independent of extension and bending ( $k_{14} = k_{24} = k_{34} = 0$ ), and the diagonal terms represent the extension stiffness ( $k_{11} = EA$ ), bending stiffnesses with shear deformation effects already included ( $k_{22} = EI_f$ ,  $k_{33} = EI_c$ ), and torsion stiffness ( $k_{44} = GJ$ ). The remaining coupled stiffness terms,  $k_{12}$ ,  $k_{13}$ , and  $k_{23}$  are used to define the centroid and principle axes of the cross section at which point they become zero.

By considering the appropriate subsets of equation 2, the study of reference 19 defines three nondimensional

coupling parameters that may be used to define the magnitude and type of coupling in a given structure as:

$$\Psi_{ET}^2 = \frac{k_{14}^2}{EAGJ} \quad (3)$$

$$\Psi_{FT}^2 = \frac{k_{24}^2}{EI_f GJ} \quad (4)$$

$$\Psi_{CT}^2 = \frac{k_{34}^2}{EI_c GJ} \quad (5)$$

where the subscripts *ET*, *FT*, and *CT* refer to extension-twist, flapwise-bending-twist, and chordwise-bending-twist, respectively; and because of the requirement that strain energy be positive the three coupling parameters are bounded between 0 and 1. These parameters are useful because they can be used to define realistic coupled stiffness terms for comprehensive aeroelastic analyses without performing a full anisotropic cross section analysis. While the coupling parameters are physically limited to values less than 1, the parametric studies of reference 19 show that in practice  $\Psi$  will be below 0.5, and the influence of the coupling on effective blade bending stiffnesses is generally small for values of  $\Psi$  below 0.2. The study also defined a set of nondimensional variables related to laminate thickness, ply angle, chord length, and spar width, and developed an associated set of plots which may be used to estimate realistic values of elastic coupling parameters for any rotor blade of typical construction based only on knowledge of the uncoupled classical stiffnesses. An example of the use of these plots is developed later in the bending-twist-coupled studies section of this paper.

### Extension-Twist-Coupled Blade Studies

**Passive Twist Control Studies.** There have been a number of investigations which have focused on improving tiltrotor performance by using elastic tailoring to passively change rotor blade twist distribution between the helicopter and airplane flight modes. The concept of changing blade twist between flight modes can be realized with the use of composite rotor blades, designed to exhibit extension-twist coupling (ETC) through an arrangement of off-axis ply angles and stacking sequences. In forward flight, the rotor speed of a tiltrotor is typically 15% less than it is in hover. Thus, there is a net change in centrifugal forces which can be used to passively improve the twist distribution for each flight mode. The aerodynamic performance efficiency associated with a range of linear blade twist distributions for a tiltrotor in hover and forward flight modes is illustrated in figure 14. This plot is developed using momentum theory and a nonuniform inflow model, but does not consider wake recirculation and other three dimensional aerodynamic effects which

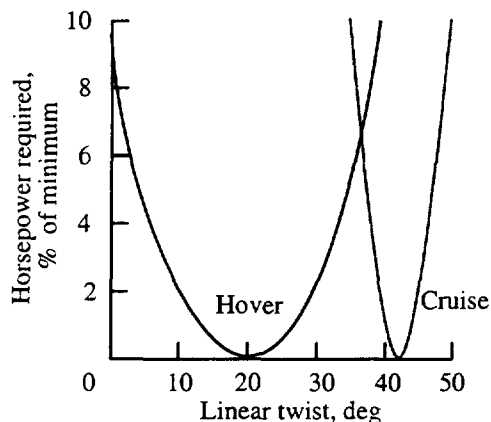

Figure 14: Power required in hover and forward flight as a function of blade linear twist.

may lessen the influence of twist on performance. While the plot suggests that about a 6% improvement to both the hover and cruise efficiencies is possible as compared to a compromised twist for both flight regimes, the extent of the improvement in aerodynamic performance depends on how closely the actual twist developed in hover and forward flight approaches the optimum twist in each of the two modes. This, in turn, depends on the magnitude of twist deformation which can be produced within the material strength limit of the blade structure. As the allowable twist deformation increases, so does the ability to obtain desirable twist distributions in both modes of flight. Although the desired twist change occurs between hover and cruise flight, it is the twist change caused by increasing rotation velocity from 0 to its maximum (hover) value which produces the maximum blade stresses. For structural substantiation of a design, the centrifugally generated stresses must be considered simultaneously with bending stresses resulting from air and inertia loads.

In reference 21, passive twist control concepts are applied to the extension-twist-coupled design of a rotor blade for the XV-15 tilt rotor assuming a 15% change in operation rotor speed between hover and cruise. This particular design was restricted to match the baseline XV-15 blade properties (mass distribution, bending and torsion stiffnesses, and c.g. locations), and with these requirements only about 0.5° of twist change was developed. A second study was performed which allowed deviations from the baseline XV-15 blade with respect to bending and torsion stiffnesses, but retained the baseline mass distribution and c.g. locations. This design resulted in a 2° twist change over the same 15% rotor speed range.

**Experimental Studies of Extension-Twist-Coupled Structures.** The experimental studies of reference 22 showed that composite tubes constructed to optimize twist deformation as a function of axial force

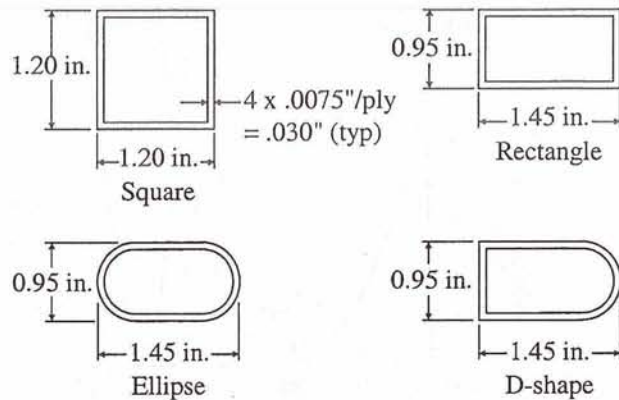

Figure 15: Four cross section shapes tested to determine effects of warping on ETC.

could produce extremely large twist rates within the material allowable stresses associated with the axial loads alone. Twist rates of nearly 0.5 deg/in were produced which translates to twist deformations on the order of 48° of twist over the tailorable span of an XV-15 rotor blade.

These experimental studies were extended in reference 23 to include cross sections of noncircular shape, as shown in figure 15, such that the effects associated with warping and shear deformation on the extension-twist behavior could be examined. This experiment, with setup illustrated in figure 16, demonstrated that the noncircular shapes were less effective at producing twist deformation for a given amount of axial load, but significant twist could still be produced within the material strength considerations. In particular, the important influence of warping restraint near a fixed boundary was shown to have an important effect on the prediction of the torsional stiffness and thus also the twist deformation produced under an axial load.

With the demonstration of large twist deformations produced by extension-twist-coupled test specimens, the analytical study of reference 24 was performed to determine the benefits of such structures to tiltrotor blade design. This study considered an extension-twist-coupled blade design subject to no restrictions on the structural blade properties other than to meet material allowable stress requirements for typical blade loadings. Unlike the study of reference 21, the study of reference 24 also considered the mass distribution as a design variable so that the centrifugal forces required to impart the elastic twist changes could be maximized. Three extension-twist-coupled rotor blade designs were developed with the most characterizing feature of each being the amount of tip weight used. Design-1 had 15 lbs. of tip weight which could be accommodated by conventional helicopter rotor

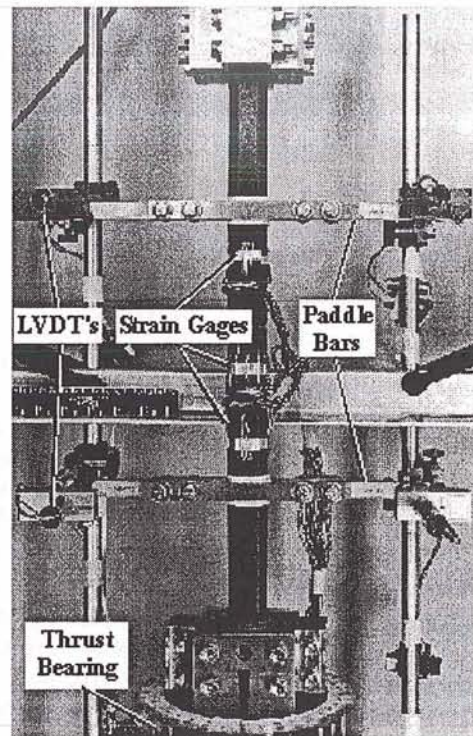

Figure 16: Experimental setup for ETC tube tests.

blades. Design 2 had 60 lbs. of tip weight which is much more than that used in conventional designs. Design-3 was not limited in tip weight which resulted in the maximum twist deformation possible under the design assumptions of the study, but the weight increase made the design impractical. All three designs were obtained by optimizing for maximum twist deformation subject to material strength constraints. The elastic twist change available for each design was used to determine its hover twist distribution based on using the optimum linear twist distribution for cruise. The plot of figure 17 shows the resulting twist distributions associated with the nonrotating, cruise, and hover conditions of Design-1. The performance in cruise mode was optimum for all the cases due to use of this twist distribution as a starting point for the designs. The hover performance associated with each design is illustrated in figure 18. This plot shows that if the optimum linear twist for cruise was used also for hover that about 8% more power would be required in the hover condition. The twist change associated with the extension-twist-coupled design is predicted to improve the power requirements in hover by 4% to 8%.

A hover study of passive extension-twist-coupled rotor blades was performed as described in reference 25 to determine if the twist deformations of ETC blades could be predicted accurately in a rotating environment, and to examine the influence on twist deformation that may

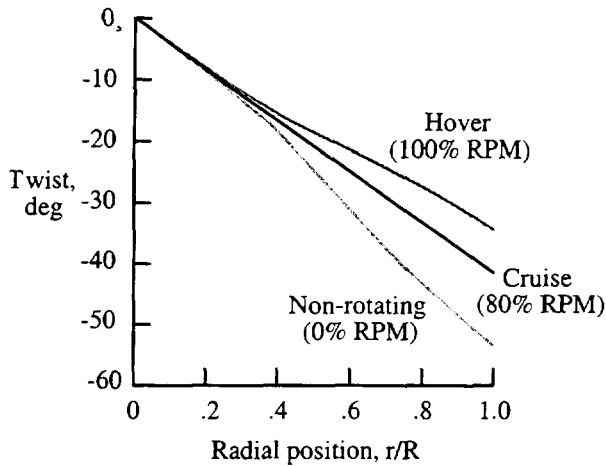

Figure 17: Twist distributions for the ETC blades in non-rotating undeformed state.

occur due to the propeller-moment and aerodynamic moment effects. For this test, a set of composite model rotor blades was manufactured from existing blade molds for a low-twist helicopter rotor blade, but the ETC design incorporated 20° off-axis plies in the Gr/E spar to obtain the desired coupling, the cross section of which is illustrated in figure 19. The figure shows that weight tubes were present, allowing additional mass to be added to the blade. Data were obtained for both a ballasted (increase in effective tip weight) and unballasted blade configuration in sea level atmospheric conditions over a large range in collective settings. The influence of collective on the twist deformation showed the influence of the propeller moment on the twist. The unique capabilities of the NASA LaRC TDT were used to repeat some of the tests in near-vacuum conditions as a means of determining the effect of aerodynamic contributions to the twist. Maximum twists of 2.54° and 5.24° were obtained at 800 RPM for the ballasted and unballasted cases, respectively. These results compared well with predictions from a NASTRAN finite element model as illustrated in figure 20. The influence of the propeller moment and aerodynamic moment were found to be minimal, with changes in twist less than 0.2° contributed from these effects.

#### Aeroelastic Stability of Extension-Twist-Coupled Rotor Blades.

Despite the extensive analytical and experimental studies of ETC structures as described in the previous paragraphs, the capability to examine the dynamic effects of ETC rotor blades were limited during the time of these studies because the comprehensive aeroelastic analyses available did not provide modeling for such generally anisotropic elastically-coupled rotor blades. Most of these analyses

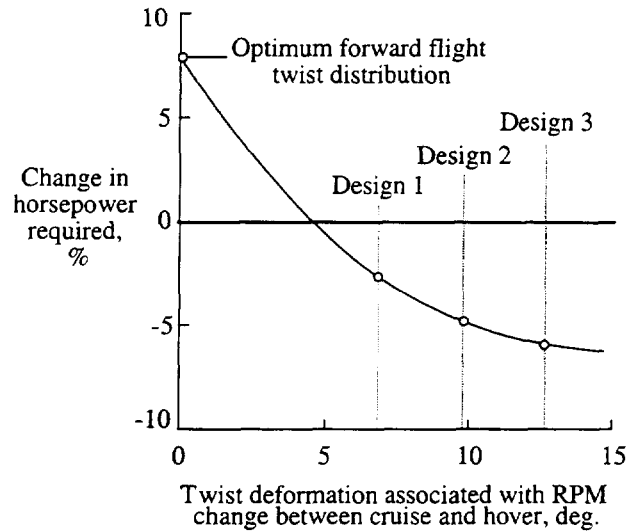

Figure 18: Power requirements in hover as a function of twist deformation produced.

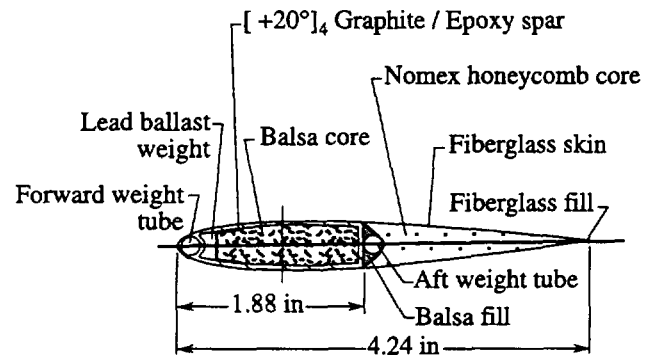

Figure 19: Cross section composition of the ETC blade hover tested in the TDT.

also did not contain an axial degree of freedom with which the analytical models could be modified for ETC coupling.

In the study of reference 26, the performance, response, and stability of a tiltrotor with elastically-coupled composite rotor blades was examined. This study included a development of the analytical tools required to perform these tasks by adding required capabilities associated with tiltrotor configuration modeling and general anisotropic beam modeling to the University of Maryland Advanced Rotor Code (UMARC). The modified analysis provided the capability to examine the influence of ETC on blade loads and aeroelastic stability in addition to the performance predictions as previously discussed. Using a similar procedure as that of reference 24, the performance of a tiltrotor in hover and cruise was predicted using ETC

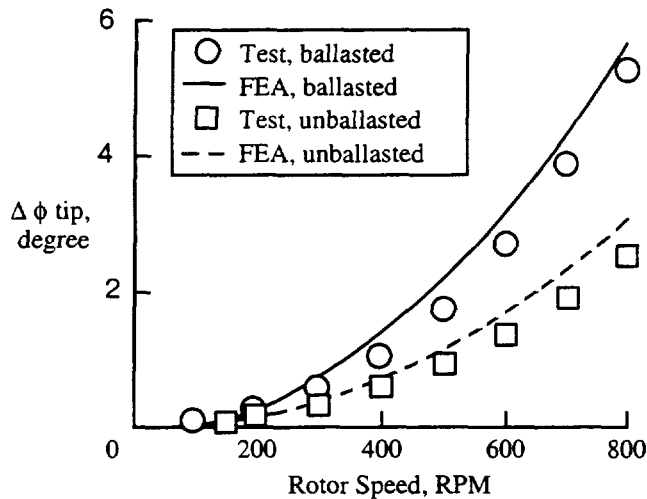

Figure 20: Twist deformations measured and predicted for the ballasted and unballasted ETC rotor blade set.

rotor blades with varying amounts of tip-weight added to develop twist distributions that were optimum for cruise and near-optimum for hover. The hover results as illustrated in figure 22 show that the ETC designs were predicted to improve the hover performance over the baseline twist distribution by as much as 7%. The performance for the cruise mode was predicted to improve by about 2% which is valid for all cases.

The study of reference 26 also examined the effect of the ETC rotor blades on aeroelastic stability. The addition of tip-weights as required to obtain the twist deformations desired to optimize performance were found to have a highly destabilizing influence on whirlflutter. The dominant effect is associated with the pitch-lag coupling in the rotor system that is created by the tip-weight in combination with precone and a reduction in the rotor thrust between hover and cruise. This effect, as is illustrated in figure 3, results in a large negative spring relating torsion moment about the pitch axis to blade lag deformation. The damping in airplane mode for a baseline XV-15 semispan wing and rotor blade model is compared with ETC blade version of the model in figure 23. These results show that the destabilizing influence of ETC blade designs can be quite significant, with flutter velocities predicted to drop by at least 50% for the designs considered.

### Bending-Twist-Coupled Blade Studies

**Whirlflutter Stability Augmentation.** The study of reference 26 considered the use of bending-twist-coupling in rotor blades for augmenting tiltrotor whirlflutter stability. This coupling may be used to counteract the inherent negative pitch-lag coupling which is signifi-

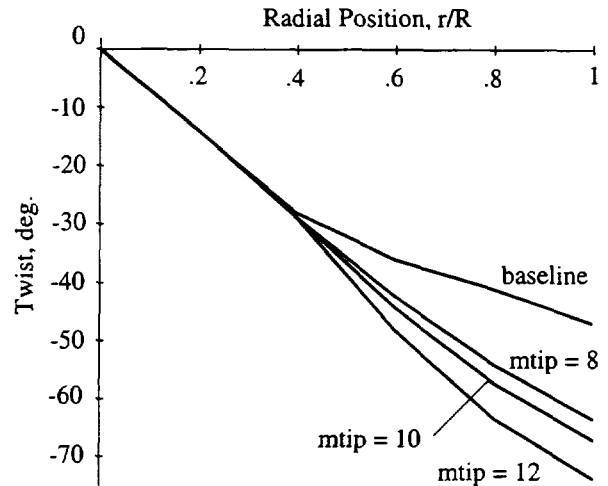

Figure 21: Undeformed (nonrotating) twist distributions of the ETC blade designs.

cant in the airplane mode of tiltrotors and is destabilizing to whirlflutter, as is discussed in previous sections of this paper. A more thorough explanation of the factors influencing rotor pitch-lag coupling is presented in references 26 and 27, and some of this discussion is offered in the following paragraph to help explain how the elastic coupling is beneficial.

Consider the rotor system in hover. Here the rotor disc loading is high, so to offset large blade bending moments, rotor precone is introduced. As shown in figure 6, the precone gives a component of centrifugal force which opposes the lift force. With ideal precone these forces balance, and there is no net bending moment imposed on the rotor blade (at least for some desired spanwise location on the blade). Now, consider the rotor system in airplane cruise. The disc loading decreases by an order of magnitude compared to the hover value because lift is generated by the wing and the thrust now only is required to overcome drag. The centrifugal force component perpendicular to the blade also decreases because of the lowered rotor speed, but not nearly as much as the reduction in blade lift forces. Thus, in cruise there is a significant imbalance of centrifugal force tending to bend the rotor blade back (flap down). This imbalance creates a torsion moment about the blade inboard sections proportional to the lag bending deflection as illustrated in figure 6. Now consider a simplified static torsion balance of the rotor blade where only the lag deflection, torsion deflection and flapping moment are included. The net flap moment due to aerodynamic and centrifugal forces has a torsional component proportional to lag which must be balanced by the blade torsional stiffness:

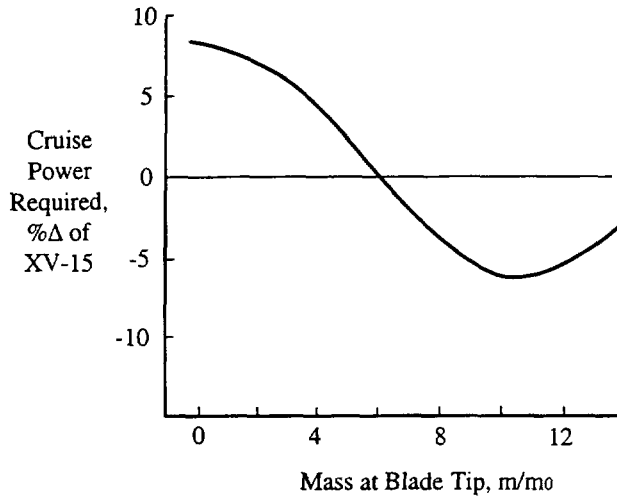

Figure 22: Hover performance for ETC blades as a function of tip-weight.

$$M_{\beta}\eta + I_{\theta}\omega_{\theta}^2\theta = 0 \quad (6)$$

where  $M_{\beta}$  is the net bending moment,  $\eta$  is the lag deflection,  $I_{\theta}$  is the torsional inertia,  $\omega_{\theta}$  is the torsional frequency, and  $\theta$  is the local torsional deflection. If the blade is considered to be semi-rigid such that the lag and torsional deflections occur at the root of the blade, then an effective kinematic pitch-lag coupling term can be defined as

$$K_{P_{\eta}} = -\frac{\theta}{\eta} = \frac{M_{\beta}}{I_{\theta}\omega_{\theta}^2} \quad (7)$$

where  $K_{P_{\eta}} > 0$  gives lag-back/pitch-down coupling. The flap moment at the blade root is given by

$$M_{\beta} = \gamma \int \frac{L}{ac} r dr - \beta_p - \beta_{trim} \quad (8)$$

where  $L$  is the blade lift at a given spanwise position,  $\beta_p$  is the precone angle, and  $\beta_{trim}$  is the elastic coning angle. In hover, the precone is selected to balance the lift so  $M_{\beta}$  is small and  $K_{P_{\eta}}$  is small. In cruise, the precone term dominates so the kinematic pitch-lag coupling can be estimated by:

$$K_{P_{\eta}} = \frac{\beta_p}{I_{\theta}\omega_{\theta}^2} \quad (9)$$

Therefore, the precone and torsional stiffness determine the pitch-lag coupling, and this coupling happens to have a significant effect on tiltrotor stability in high-speed

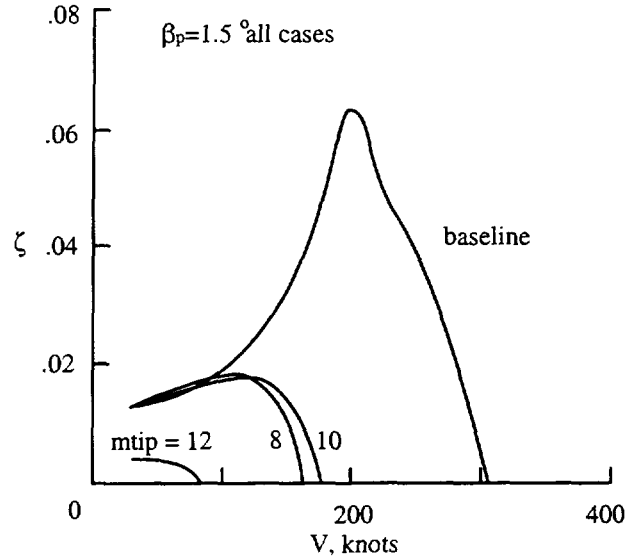

Figure 23: Destabilizing influence of extension-twist-coupling on tiltrotor stability.

flight. The effective kinematic coupling of an XV-15 model is estimated in reference 27 to be -0.3 which is considered a high value.

From the discussion of the previous section, it appears that if positive pitch-lag coupling were introduced into the rotor system to offset the negative pitch-lag coupling introduced by rotor precone, then the stability characteristics should improve. There are two methods which may readily be used to introduce positive pitch-lag coupling (lag-back/pitch-down): kinematic coupling in the control system and elastic bending-twist coupling in the rotor blade. There are several reasons why the use of kinematic coupling to develop positive pitch-lag coupling may present difficulties, as are discussed in reference 26. The current paper focuses on explaining the potential for using elastic tailoring to produce the desired coupling effects.

A basic concept for a bending-twist-coupled rotor blade used in tiltrotor cruise mode is illustrated in figure 24. An untwisted blade is used in the diagram to clarify the deformation directions. The collective in tiltrotor cruise mode is on the order of  $40^{\circ}$  to  $50^{\circ}$  at the 75% spanwise station. As tiltrotor blades are also highly twisted, the inboard portion of the blade is at pitch angles on the order of  $60^{\circ}$  to  $70^{\circ}$ , which places the flapwise-bending direction of the local blade cross section more in line with the in-plane direction (defined by the plane of rotation) than the chordwise-bending direction. For a stiff-inplane system, where the virtual lag hinge is going to be outboard of the blade pitch axis, the rotor system pitch-lag coupling is influenced most effectively by flapwise-bending-twist cou-

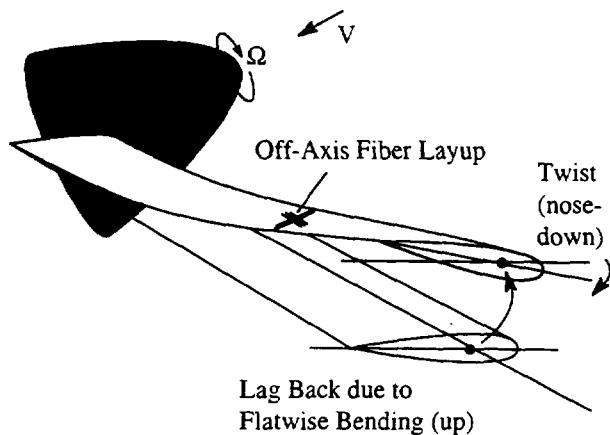

Figure 24: A Bending-Twist-Coupled Blade in Cruise Mode.

pling in the rotor blade.

Using the elastic coupling parameters definitions defined in reference 19, the aeroelastic analysis of reference 26 was used to determine the aeroelastic stability of a semi-span tiltrotor model with wing and rotor system characteristics similar to that of the XV-15, but with increasing amounts of flapwise-bending-twist coupling in the rotor blades. The influence on whirlflutter stability associated with the addition of elastic coupling is illustrated in figure 25 for three values of the flapwise-bending-twist elastic coupling parameter,  $\Psi_{FT}$ . The baseline case ( $\Psi_{FT} = 0$ ) is predicted to become unstable at about 280 knots. The velocity at which the system becomes unstable is shown to increase with the magnitude of flapwise-bending-twist coupling,  $\Psi_{FT}$ , to near 400 knots with the maximum amount of  $\Psi_{FT}$  considered. Using the charts of reference 19, example of which are illustrated in figures 26 and 27, the elastic coupling used in this study may be achieved by rotating the principle axis of the laminate by less than  $5^\circ$ , and the corresponding reduction of the effective flapwise-bending stiffness is shown in figure 27 to be less than 2%. Similarly, the plots in reference 19 may be used to determine that the torsional stiffness would increase by about 2% and the chordwise stiffness would decrease by about 5% for  $\Psi_{FT} = 0.1$ . These results indicate that the use of flapwise-bending-twist-coupled blades may provide a very favorable influence on stability without creating adverse effects on performance, blade loads, or rotor system dynamics.

## SUMMARY

The studies reported in this paper focus on four unique aeroelastic tailoring concepts: 1) bending-twist (pitch-bending) coupling in the wing to augment aeroelastic

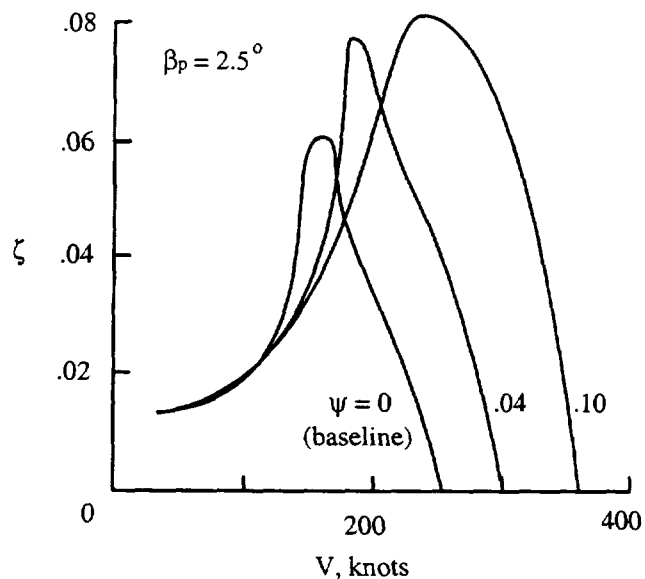

Figure 25: Effect of flapwise-bending-twist coupling on whirlflutter stability.

stability associated with whirlflutter in high-speed airplane mode, 2) bending-twist coupling in the wing to augment aeromechanical stability of soft-inplane rotor systems subject to ground and air resonance, 3) bending-twist coupling in the rotor blades to reduce rotor pitch-lag coupling and thereby augment aeroelastic stability associated with whirlflutter in high-speed airplane mode, and 4) extension-twist coupling in the rotor blades to optimize blade twist distribution between hover and cruise and thereby gain an aerodynamic performance improvement. The studies associated with augmenting whirlflutter stability show that both wing and blade tailoring are effective, with increases in stability boundaries of at least 50 knots predicted based on existing systems. The wing-tailoring study for soft-inplane rotor systems shows that bending-twist coupling in the wing can be used to avoid ground and air resonance, but these results are preliminary, and further analysis must be conducted to determine feasibility of the beneficial couplings on tiltrotor in other flight modes. Finally, the several studies devoted to extension-twist coupling indicate that, while there is a performance payoff for optimizing blade twist, the required stiffness and mass changes are shown to be extremely destabilizing to tiltrotors in whirlflutter, indicating that the passive twist control concept may not be feasible for the current tiltrotors systems.

## Relative Merits of Blade and Wing Tailoring

The aeroelastic studies presented in this paper show that either wing or blade tailoring may be used to significantly increase the aeroelastic stability boundaries for



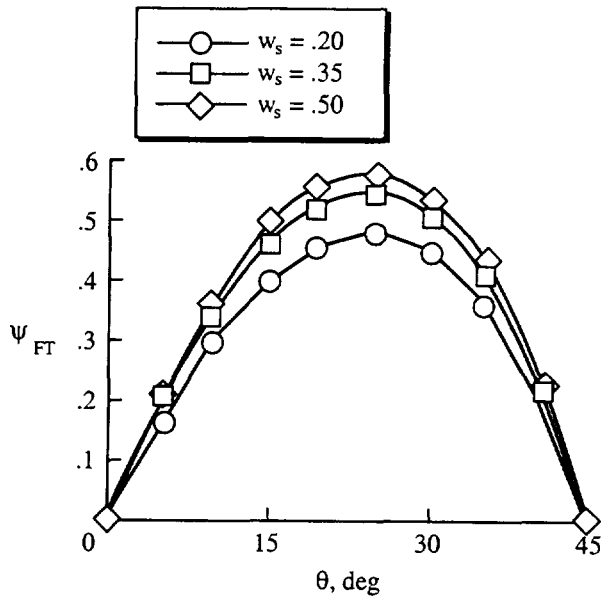

Figure 26: Flapwise-bending-twist coupling parameter as a function of ply angle.

tiltrotors in high-speed flight. Considering the complexities and greater risks associated with modifying structures designed for the rotating environment, it is generally accepted that fixed system modifications are preferred. This favors wing tailoring over blade tailoring and explains why the investigations associated with composite tailored wings have already been tested in the wind tunnel and considered in full-scale design studies. One drawback of wing tailoring, however, is that the stability augmentation of the wing may be limited by instabilities associated with the wing chord mode which is not necessarily improved by the elastic couplings used to augment aeroelastic stability of the wing beam mode. To obtain the stability margins necessary for even greater cruise speeds, such as the anticipated 400-knot class of tiltrotors predicted for future designs, the blade and wing tailoring concepts presented may need to be considered together.

#### REFERENCES

1. Alexander, H.R. and Leone, P.F., "VSTOL Dynamics and Aeroelastic Rotor-Airframe Technology," Volume I, AFFDL-TR-72-40, January 1973..
2. Alexander, H.R., Hengen, L.H., and Weiberg, J.A., "Aeroelastic-Stability Characteristics of a V/STOL Tilt-Rotor Aircraft with Hingeless Blades: Correlation of Analysis and Test," 30th Annual Forum of the American Helicopter Society, May 1974.
3. Gaffey, T. M., "The Effect of Positive Pitch-flap Coupling (Negative  $\delta_3$ ) on Rotor Blade Motion Stabil-

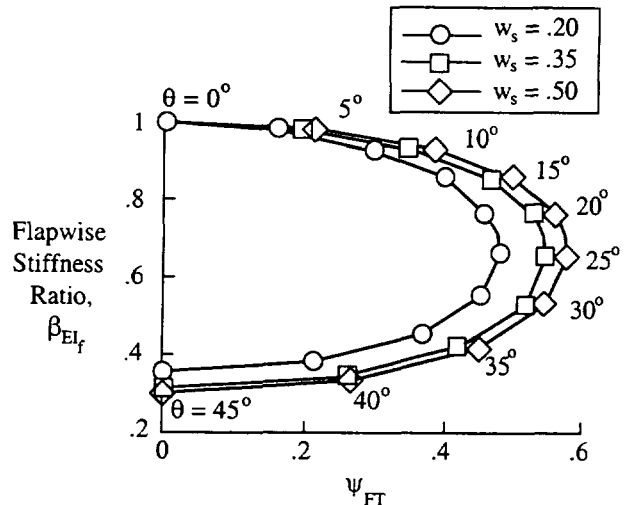

Figure 27: Flapwise-bending stiffness ratio as a function of the flapwise-bending-twist coupling parameter.

ity and Flapping," *J. American Helicopter Society*, April 1969..

4. Settle, T.B. and Kidd, D.L., "Evolution and Test History of the V-22 0.2-Scale Aeroelastic Model," American Helicopter Society National Specialists' Meeting on Rotorcraft Dynamics, Arlington, TX, Nov 1989.
5. Schillings, J. J., Roberts, B. J., Wood, T. L. and Wernicke, K. G., "Manuever Performance of Tiltrotor Aircraft," 43rd Annual Forum of the American Helicopter Society, St. Louis, MO, May 1987.
6. Agnihotri, A., Schuessler, W., and Marr, R., "V-22 Aerodynamic Loads Analysis and Development of Loads Alleviation Flight Control System," 45th Annual Forum of the American Helicopter Society, Boston, Massachusetts, May 1989.
7. Nixon, M. W., "Parametric Studies for Tiltrotor Aeroelastic Stability in Highspeed Flight", *J. American Helicopter Society*, October 1993
8. Johnson, W., "Dynamics of Tilting Proprotor Aircraft in Cruise Flight," NASA TN D-7677, May 1974.
9. Corso, L. M. and Nixon, M. W., "Design, Analysis, and Test of a Composite Tailored Wing," American Helicopter society 53rd Annual forum, Virginia Beach, VA, April 1997.
10. Schillings, J. J. and Reinesch, R., "The Effect of Airframe Aerodynamics on V-22 Rotor Loads," American Helicopter Society National Specialists' Meeting

- on Aerodynamics and Aeroacoustics, Arlington, Tx, February 1987.
11. Popelka, D., Lindsay, D., Parham, T., Berry, V., and Baker, D., "Results of an Aeroelastic Tailoring Study for a Composite Tiltrotor Wing," American Helicopter Society 51st Annual forum, Fort Worth, Texas, May 1995.
  12. Popelka, D., Sheffler, M., and Bilger, J., "Correlation of Test and Analysis for the 1/5th Scale V-22 Aeroelastic Model, *J. American Helicopter Society*, Vol. 32, (2), April 1987.
  13. Idol, R., and Parham, T., "V-22 Aeroelastic Stability Analysis and Correlation with Test Data," American Helicopter Society 51st Annual forum, Fort Worth, Texas, May 1995.
  14. Hammond, C.E. and Doggett, R.V., "Determination of Subcritical Damping by Moving Block/Randomdec Applications," NASA Symposium on Flutter Testing Techniques, NASA SP-415, October 1975, pp. 59-76.
  15. Howard, A. K.T., "Aeroelastic Tailoring in Soft-Inplane Hingeless Tiltrotors," Presented at the AHS Lichten Competition Northeast Region, Philadelphia, PA, Jan 1999.
  16. Bauchau, O.A., "A Beam Theory for Anisotropic Materials," *J. Applied Mechanics*, Vol. 52, June 1985, pp. 416-422.
  17. Hodges, D.H., Atilgan, A.R., Cesnik, C.E.S., and Fulton, M.V., "On a Simplified Strain Energy Function for Geometrically Nonlinear Behaviour of Anisotropic Beams," *Composite Engineering*, Vol. 2, Nos 5-7, pp. 513-526, 1992.
  18. Kosmatka, J. B., "On the Behavior of Pretwisted Beams With Irregular Cross-Sections," *J. Applied Mechanics*, vol. 114, March 1992, pp. 146-152.
  19. Piatak, D. J., Nixon, M. W., and Kosmatka, J. B., "Stiffness Characteristics of Composite Rotor Blades With Elastic Couplings," NASA TP 3641, ARL TR 1279, April 1997.
  20. Nixon, M. W., and Hinnant, H.E.: Dynamic Analysis of Pretwisted Elastically-Coupled Rotor Blades. Presented at the 1992 ASME Winter Annual Meeting, Anaheim, CA, November 8-13, 1992 (Also available as NASA TM 109070 Jan 1994).
  21. Bauchau, O.A., Loewy, R.G., and Bryan, P.S.: An Approach to Ideal Twist Distributuion in Tilt Rotor VSTOL Blade Designs. AHS 39th Annual Forum, May 1983.
  22. Nixon, M.W., "Extension-Twist Coupling of Circular Tubes with Application to Tilt rotor Blade Design," AIAA Paper 87-0772, 28th Structures, Structural Dynamics and Materials Conference, Monterey, CA, April 1987.
  23. Nixon, M.W., "Analytical and Experimental Investigations of Extension-Twist-Coupled Structures," Master's Thesis, The George Washington University, NASA Langley Research Center, Hampton, VA, May 1989.
  24. Nixon, M.W., "Improvements to Tilt Rotor Performance Through Passive Blade Twist Control," NASA TM 100583, AVSCOM 88-B-010, April 1988.
  25. Lake, R.C., Nixon, M.W., Wilbur, M.L., Singleton, J.D., Mirick, P.H., "Demonstration of an Elastically Coupled Twist Control Concept for Tilt Rotor Blade Application," *AIAA Journal*, Vol. 32, No. 7, pp. 1549-1551, July 1994.
  26. Nixon, M. W., "Aeroelastic Response and Stability of Tiltrotors With Elastically-Coupled Composite Rotor Blades," Ph.D. Diss., University of Maryland, 1993.
  27. Johnson, W., "Dynamics of Tilting Proprotor Aircraft in Cruise Flight," NASA TN D-7677, May 1974.