

MAPPING OF TECHNOLOGICAL OPPORTUNITIES—LABYRINTH SEAL EXAMPLE

Dana W. Clarke, Sr.
Applied Innovation Alliance, LLC
West Bloomfield, Michigan



All technological systems evolve based on evolutionary sequences that have repeated throughout history and can be abstracted from the history of technology and patents. These evolutionary sequences represent objective patterns and provide considerable insights that can be used to proactively model future seal concepts. This presentation provides an overview of how to map seal technology into the future using a labyrinth seal example.

The mapping process delivers functional descriptions of sequential changes in market/consumer demand, from today's current paradigm to the next major paradigm shift. The future paradigm is developed according to a simple formula: the future paradigm is free of all flaws associated with the current paradigm; it is as far into the future as we can see.

Although revolutionary, the vision of the future paradigm is typically not immediately or completely realizable nor is it normally seen as practical. There are several reasons that prevent immediate and complete practical application, such as:

- Some of the required technological or business resources and knowledge not being available;
- Availability of other technological or business resources are limited; and/or
- Some necessary knowledge has not been completely developed.

These factors tend to drive the Total Cost of Ownership or Utilization out of an acceptable range and revealing the reasons for the high Total Cost of Ownership or Utilization which provides a clear understanding of research opportunities essential for future developments and defines the current limits of the immediately achievable improvements.

The typical roots of high Total Cost of Ownership or Utilization lie in the limited availability or even the absence of essential resources and knowledge necessary for its realization. In order to overcome this obstacle, step-by-step modification of the current paradigm is pursued to evolve from the current situation toward the ideal future, i.e., evolution rather than revolution. A key point is that evolutionary stages are mapped to show step-by-step evolution from the current paradigm to the next major paradigm.

Systems Evolution

Systems do not evolve randomly;
they evolve based on objective patterns.

This knowledge allows for the
comprehensive identification of
design options, reduced trial and error and
improved decision making.

Systems evolution (patterns)

- System evolution based on s-curve
- Utilization of resources
- Uneven development between system elements
- Transition from unstructured to structured
- Increased system dynamics
- Increased system controllability
- Increased complexity followed by simplification
- Matching and mismatching of system elements
- Transition to the micro-level and increased use of inventive fields
- Transition toward reduced human involvement

These evolutionary patterns are based on research of the history of technology and patents that was conducted in the Soviet Union by Genrich Altshuller between 1946 and 1985. All evolving systems transition through these patterns of evolution.

Labyrinth Seal - Steam Turbine Application U.S. Patent 5,106,104

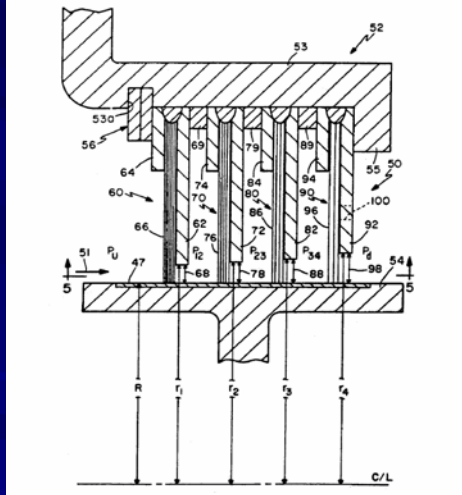

Abstract

A multiple stage brush seal having a controlled distribution of pressure drops across each stage of the seal is provided. The pressure drop across each stage is controlled by one or a combination of the following structural arrangements: increased clearance gaps, reduced bristle packing, and venting holes in the seal stage backing plate.

This US patent was selected as the result of researching highly cited labyrinth seal patents. It was chosen as one of several possible baselines for analysis of the evolution of labyrinth seals.

Underlying Process for Dynamic Seals

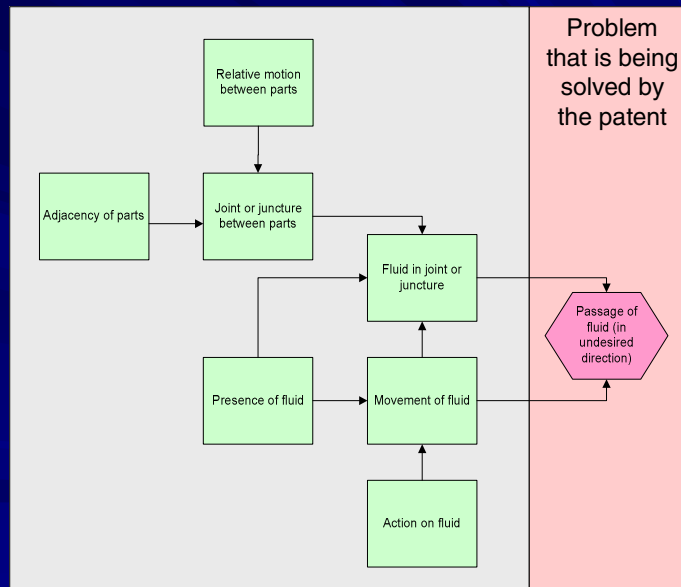

Since a labyrinth seal is a dynamic seal we need to look at dynamic seals in general. The underlying process provides a generic model for all dynamic seals. This model is a combination of functions, events and conditions that allow the objective of counteracting the passage of fluid in an undesired direction.

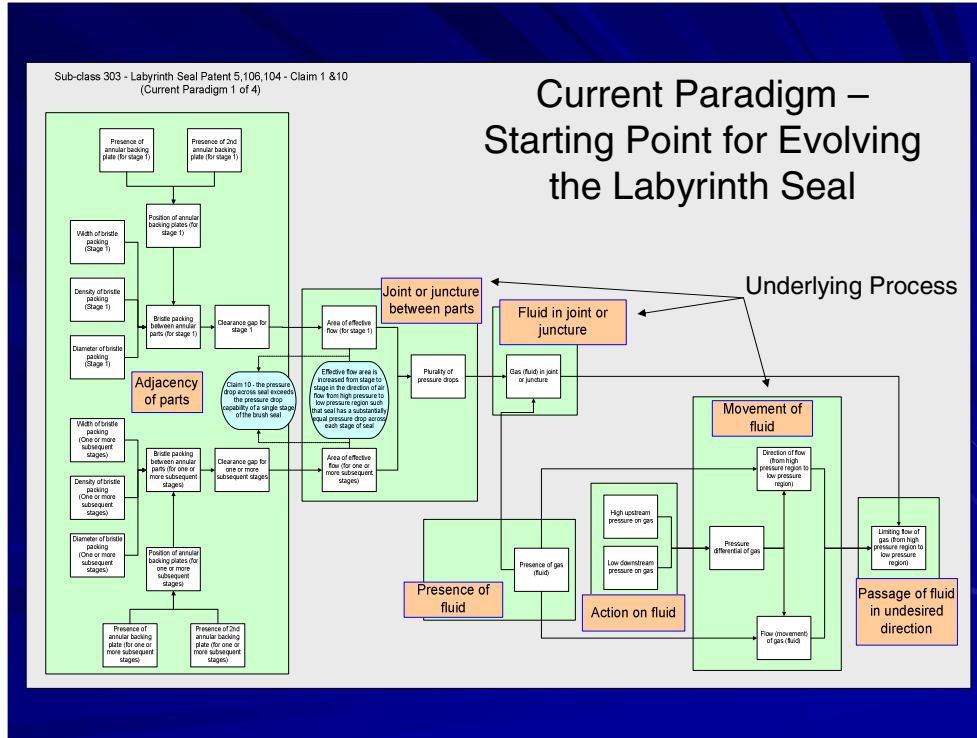

Analysis of US patent 5,106,104 claims provides details and a foundation for understanding how the patent relates to the underlying process of dynamic seals.

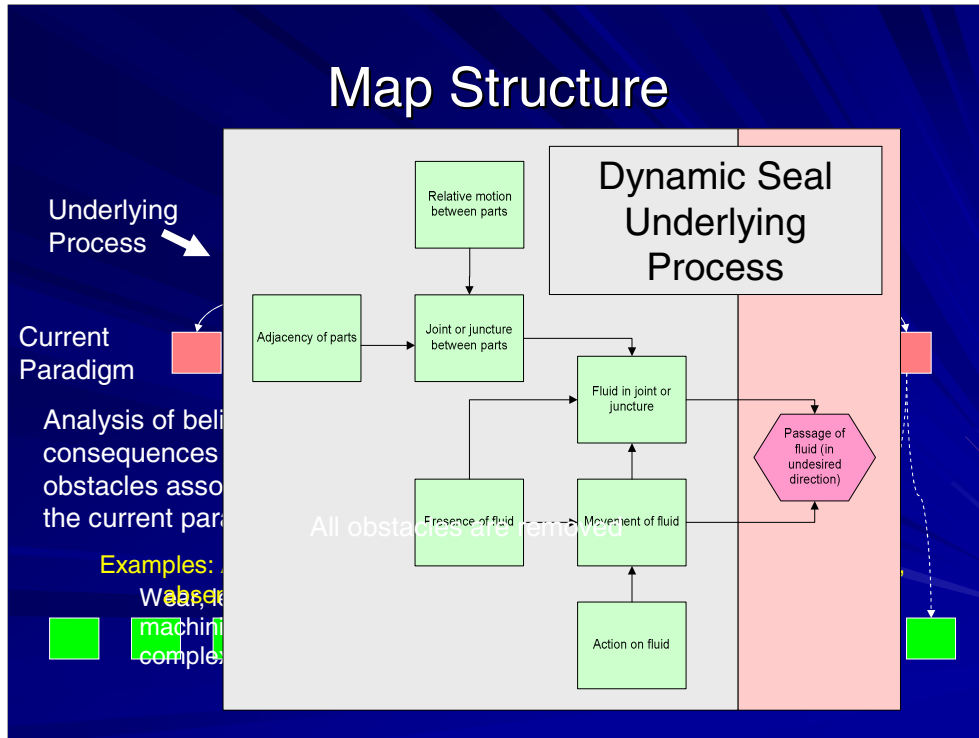

Once the underlying process and the current paradigm have been defined, the current paradigm is analyzed to identify the beliefs associated with the current paradigm. Each belief has potential consequences and there are some barriers (obstacles) to overcoming the consequences. In all probability, someone, somewhere is or will try to remove the obstacles. The theoretical removal of the obstacles results in the identification of long-range trends. The long-range trends, also known as “lighthouses on the horizon”, are as far as we can see into the future based on the evolution of the current paradigm. This defines the direction of work for working on evolving the labyrinth seal. The gap created between the current paradigm and the long-range trends is filled by comprehensively mapping the possibilities.

Divergence & Convergence

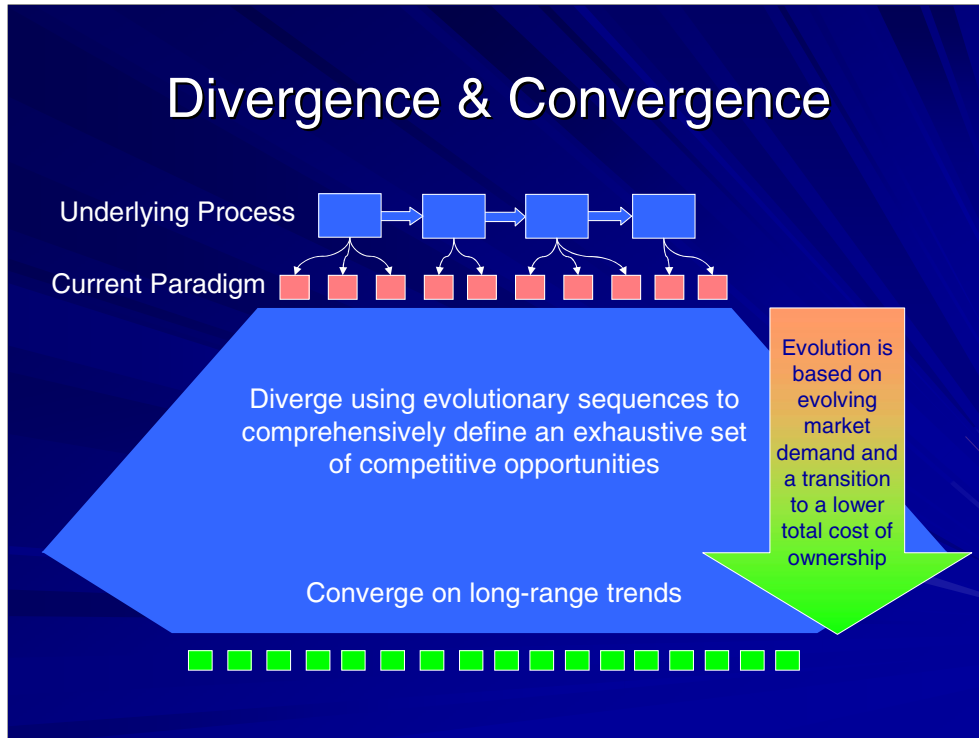

Mapping is a process of divergence, defining all of the possibilities, and convergence, focusing on achieving the long-range trends. Beginning with a bounded starting point, underlying process, and a bounded end-point, based on the elimination of obstacles.

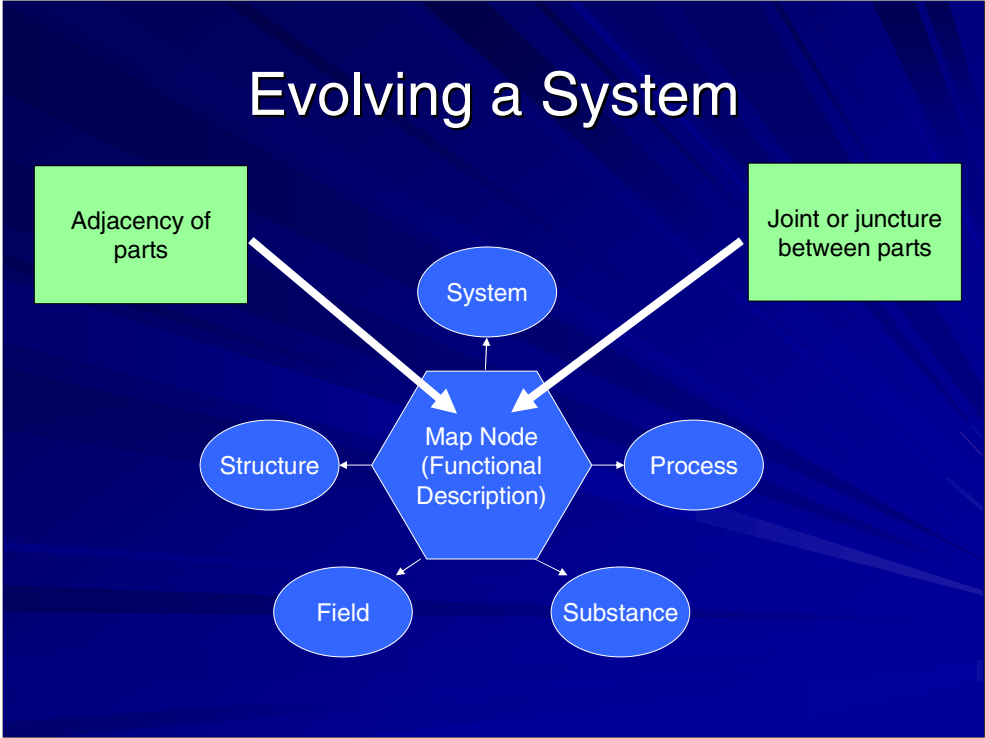

Evolving the functions, events and conditions associated labyrinth seal starts by looking at the functions, events and conditions associated with the underlying process and the labyrinth seal design. Systems are evolved based on five key areas – system, structure, field, substance and/or process.

Evolution based on increasing the control of flow

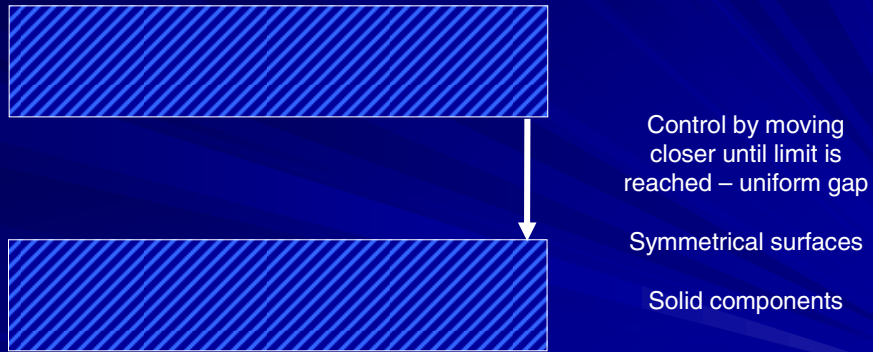

Looking at the history of seals and the evolution to labyrinth seal design we find that the process started with parallel surfaces and control was improved by moving the two surfaces toward each other. This process is limited by the ability to control the manufacture of the two surfaces. The closer the surfaces the better the control of flow through the seal.

Evolution based on increasing the control of flow

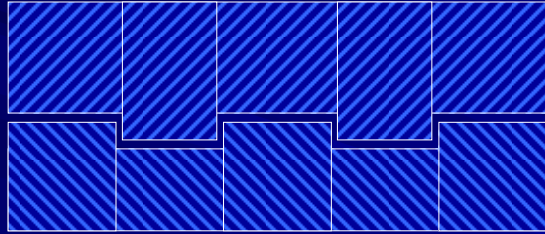

Control by changing
shape to make more
tortuous path – uniform
gap

Symmetrical surfaces

Solid structure

Over time seal designers realized that a more tortuous path would help restrict the flow. In the first designs the gap thickness was still uniform but performance was improved.

Evolution based on increasing the control of flow

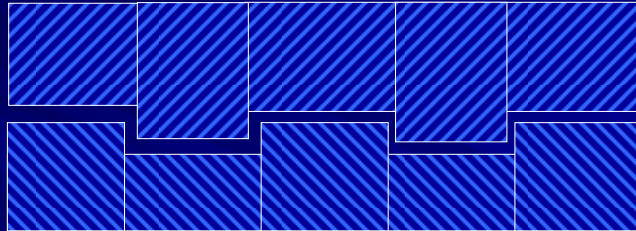

Control by making the gap non-uniform
from stage-to-stage

Asymmetrical, programmed gap

Solid structure

Next, designers realized that they could change the gap thickness and manage the pressure drop between the stages of the labyrinth seal. At this point, the design based on the use of solid, machined materials has reached a point of diminishing returns but there is a need to continue to refine the functionality of the seal.

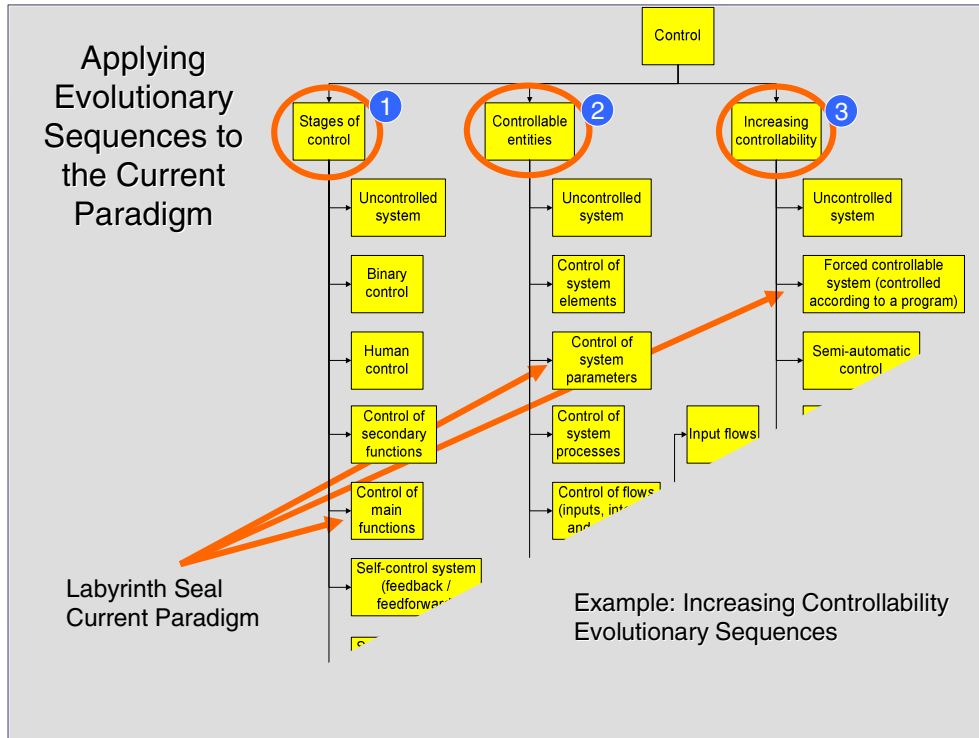

The last three slides are an example of how the labyrinth seal design has evolved based on the control of a process. Research of patents has revealed evolutionary sequences that provide details on how systems have evolved throughout history. These sequences can be used to reduce the amount of trial and error performed in evolving technology to the next generation.

Evolution based on increasing the control of flow

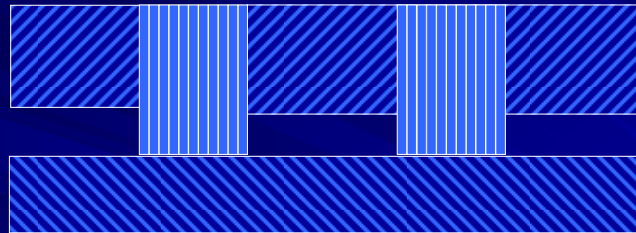

Control by making the gap uniform from stage-to-stage

Symmetrical structure

Non-solid, bristle structure

There are several evolutionary paths that systems take. Evolution can also take the path of transitioning from a solid system to the micro-level (use of energy fields). This diagram shows the transition from a solid to poly-system built from elements of simple geometric shapes.

Evolution based on increasing the control of flow

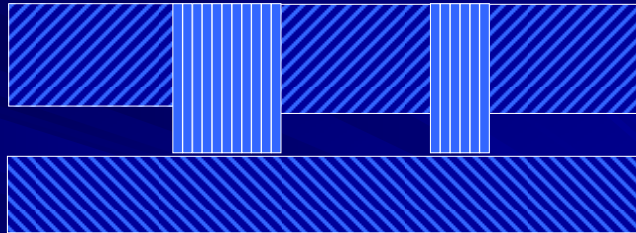

Control by making the gap uniform from stage-to-stage

Asymmetrical structure

Bristle structure – thickness, density, diameters

Again, designers realized that they can control the flow from stage to stage by changing the bristle configuration – thickness of the bristle package, density of the bristles and diameters of the bristles.

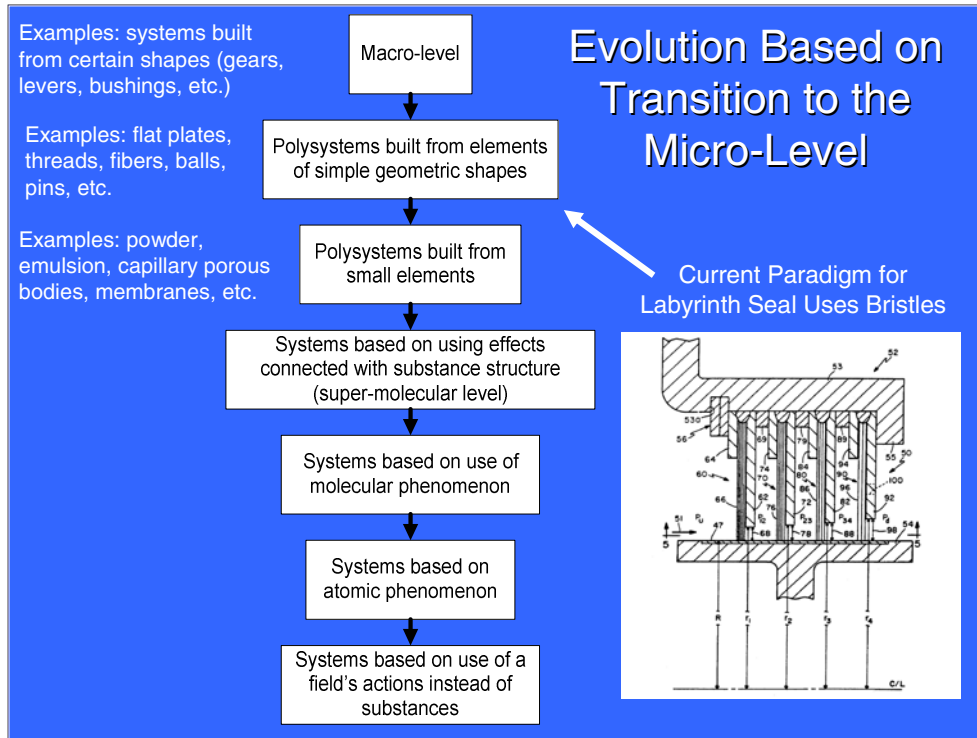

Additional research reveals that the selected labyrinth seal has only evolved to the second of seven possible levels of evolution.

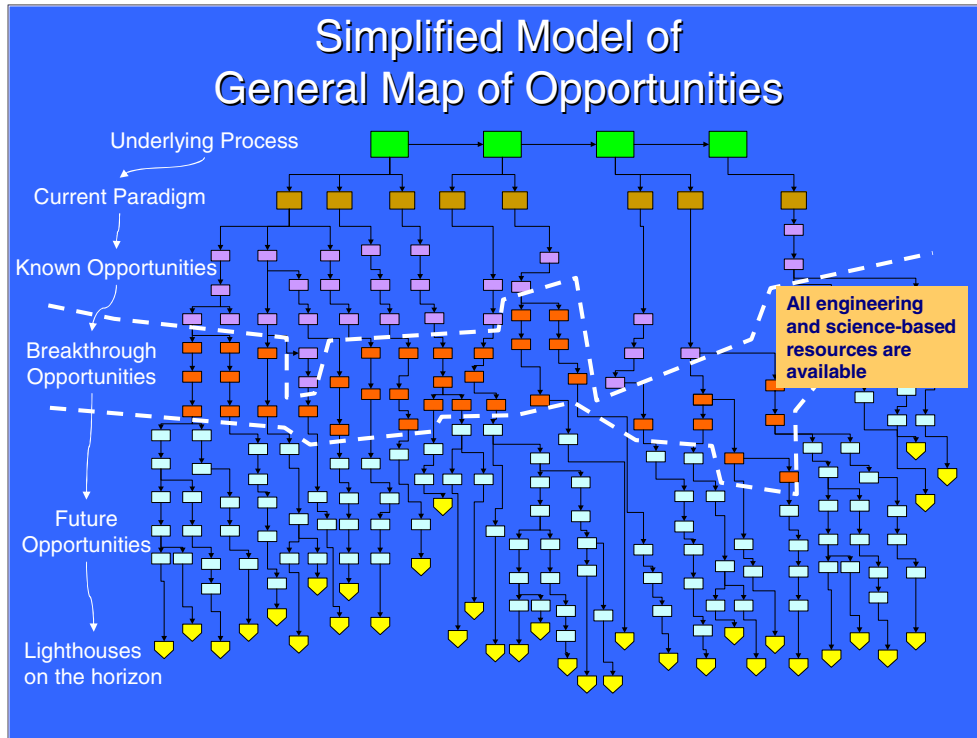

Step-by-step identification and resolution of problems coupled with the structured use of evolutionary sequences provides a means of identifying a comprehensive set of possible scenarios for the evolution of any technological system. The map development reveals known opportunities, breakthrough opportunities and future opportunities and can be used to leverage capital investments, focus the energy of scientists and engineering and continuously evolve systems from generation-to-generation.

Benefits of Mapping Technological Opportunities

■ Research Benefits

- Advance understanding of specific technologies
- Discover new technological opportunities
- Focus creative energy based on natural system evolution
- Improve definition of research path(s)
- Provide logic behind research initiatives

■ Business Benefits

- Enhance product value
- Develop a continuous flow of new high value products
- Develop continuous differentiation of products
- Maximize technology reuse to speed product development
- Maximize capital investment utilization

Accelerates the processes
associated with innovation