

737/CFM56-7 AIRCRAFT ENGINE SYSTEMS

Steve Wright and Justin Shiosaki
The Boeing Company
Seattle, Washington

ABSTRACT

The configuration of the propulsion system engine externals must meet many airplane requirements such as cost, thrust, weight, range and systems power extraction. On the 737-700 several program requirements also played a major role in the development of the engine externals. These program goals were increased range, same cost as a 1994 737-300, 15% reduction in maintenance costs from the 737-300, and a propulsion package that appeared as if it was designed by one company.. This presentation will show how these requirements shaped the design of the engine externals for the 737-700/CFM56-7B.

Engine Installation



Boeing



Boeing Designed Systems

- Pneumatics - ducting, valves, controllers, precooler
- Starting - ducting, valve
- Integrated Drive Generator (IDG) - power feeder cables, cooling
- Cowl Thermal Anti-Ice (CTAI) - ducting, valve, controller
- Fire Protection - fire detectors, drains, extinguishing
- Fuel Line
- Hydraulics - hoses, tubes, case drain filter

CFMI and Boeing

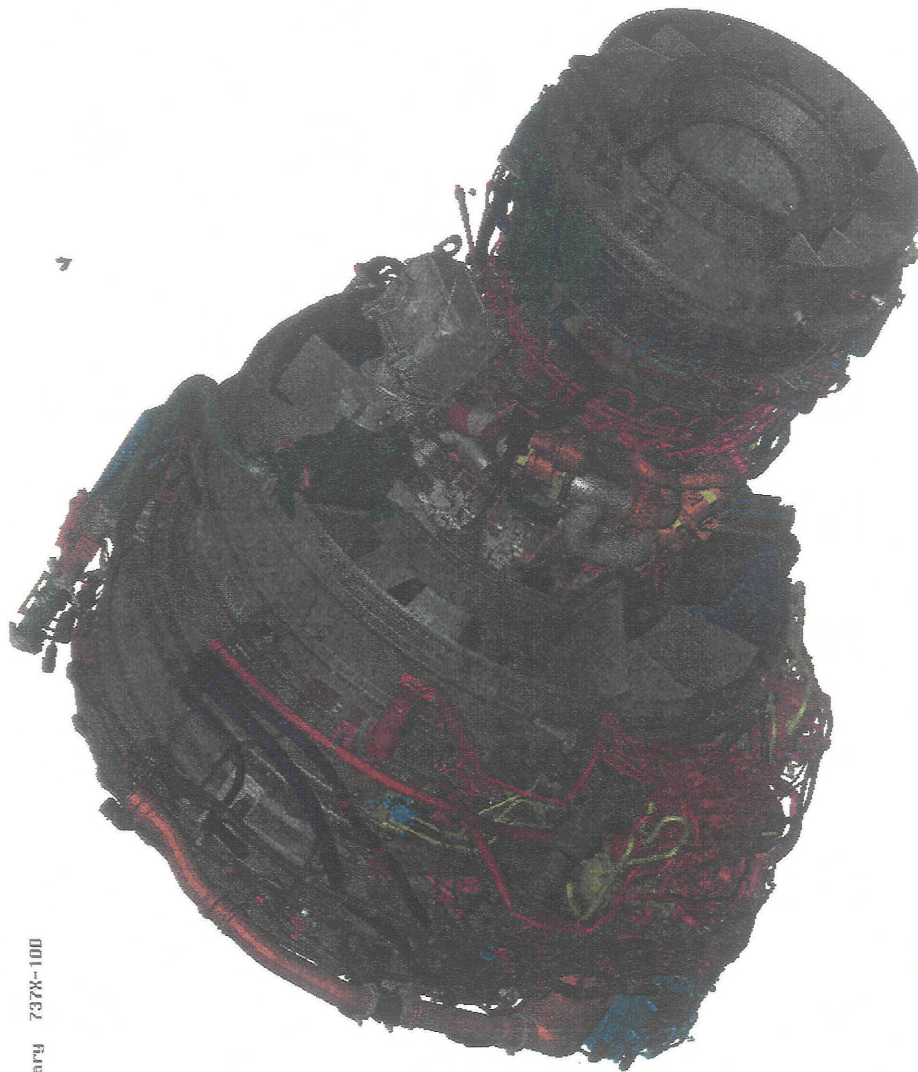

air 737X-100

Engine Without Cowls

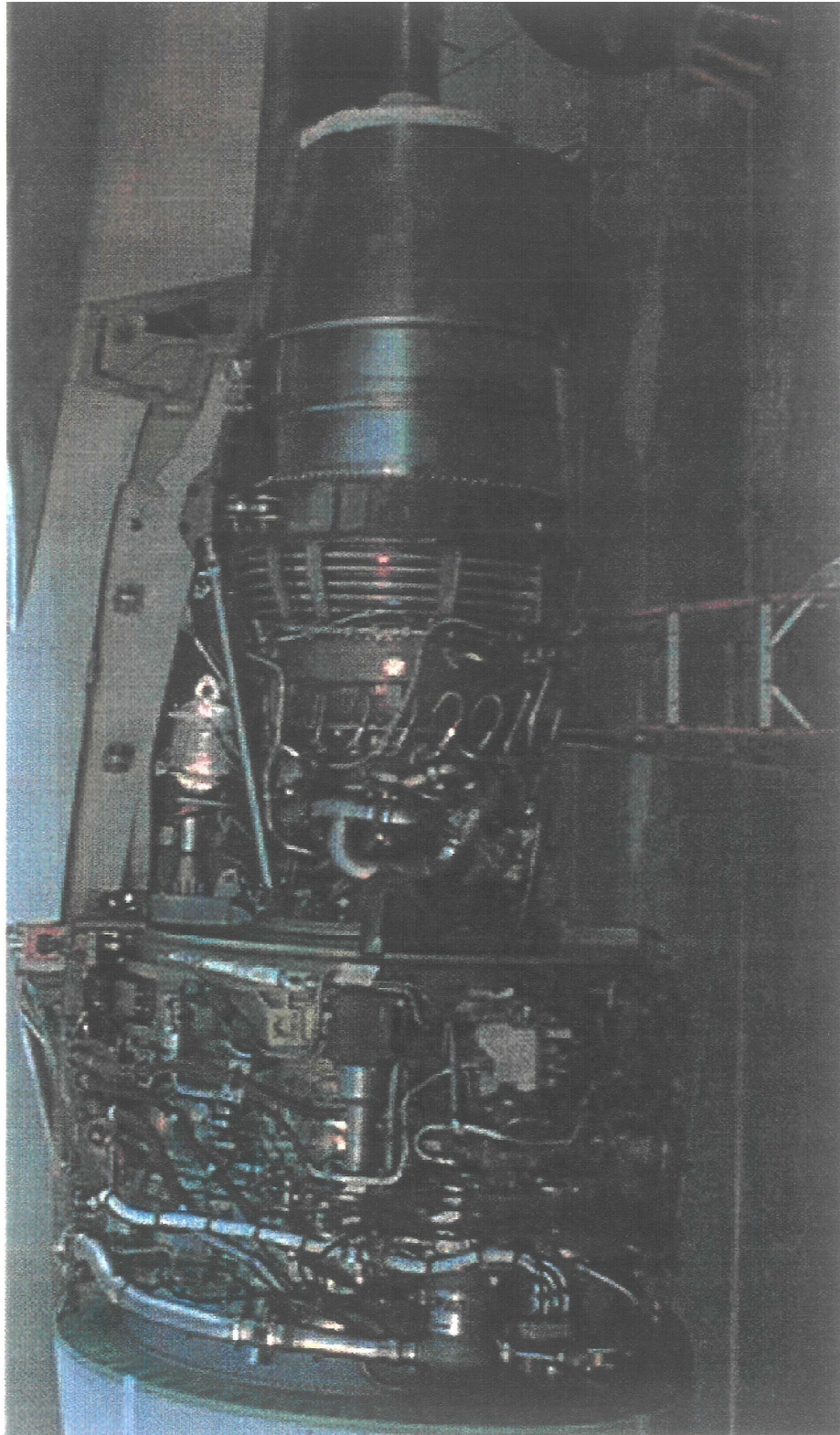

How We Ended Up With This Configuration

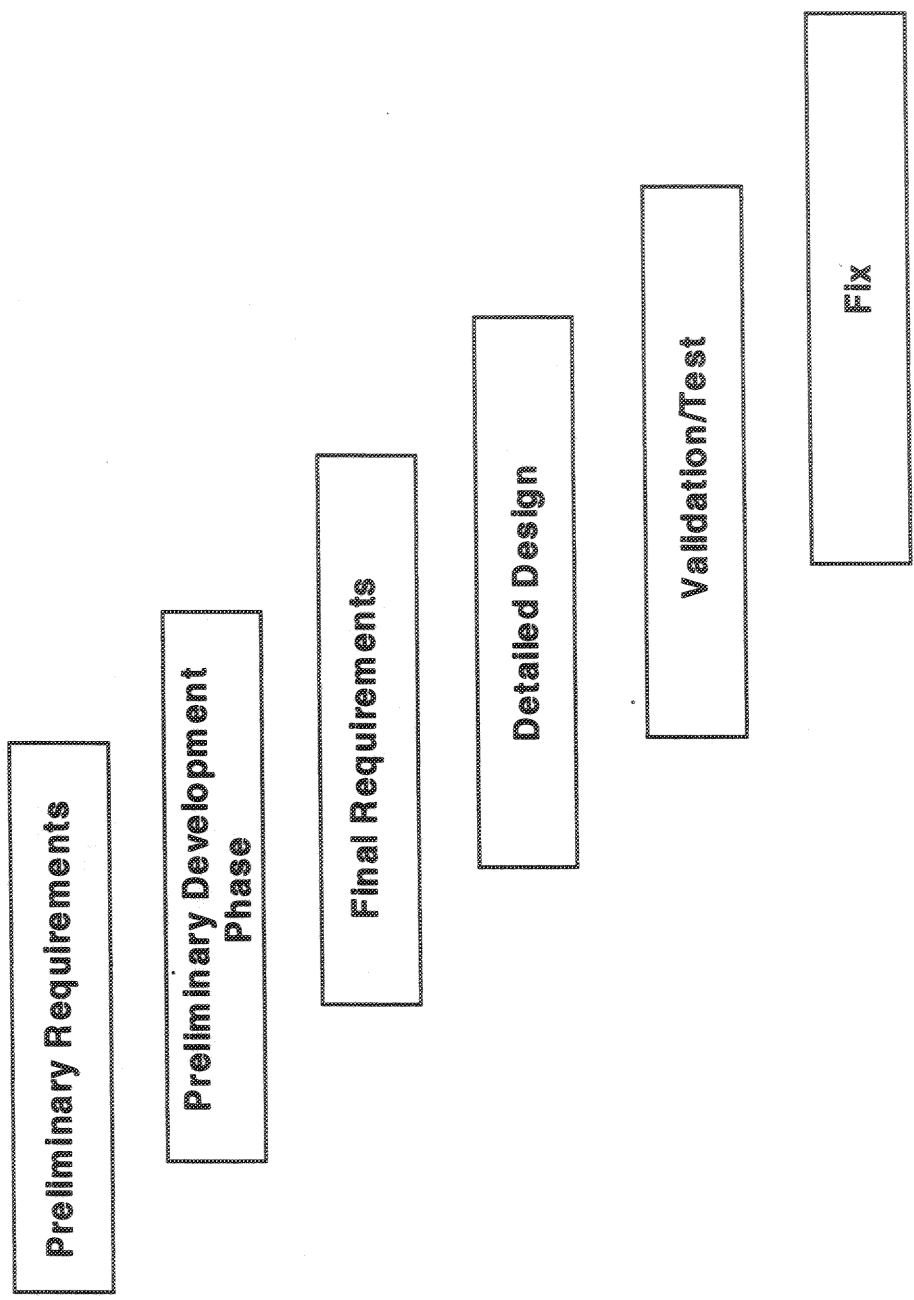

737NG AIRPLANE FOCUS

- **Past**
 - **Fly It**
 - **Higher**
 - **Farther**
 - **Faster than competition**
 - **Boeing's Economics**
- **Present**
 - **Emphasize Airline's Economics**
 - **And Fly It**
 - **Farther**
 - **Faster**
 - **Higher than current 737**

737NG ENGINE FOCUS

- **Decrease**
 - **Noise - Stage 3 minus 4 db**
 - **Fuel Burn - 7.7% lower SFC than CFM56-3C-1**
 - **Maintenance - 15% less maintenance cost than CFM56-3C-1**
 - **Cost - same price as today's 737**
- **Increase**
 - **Thrust - up to 26,400 lbs**
 - **Reliability/Time on Wing**

737NG EBU FOCUS

- **Decrease**
 - **Maintenance**
 - **Fuel Burn (indirectly)**
 - Minimize weight, cooling air**
 - **Cost**
 - Recurring and Non-Recurring**
- **Increase**
 - **Reliability/Time on Wing**

*** RELIABILITY AND MAINTAINABILITY WERE KEY
DESIGN INFLUENCES**

Reduced Maintenance

- **15% Reduction in Total Direct Maintenance Cost from 737-300**
- **Get Customer Input Early**
 - **Ease of component removal was a primary focus**
 - Digital verification for all LRU's by design engineers
 - Physical validation by airline mechanics

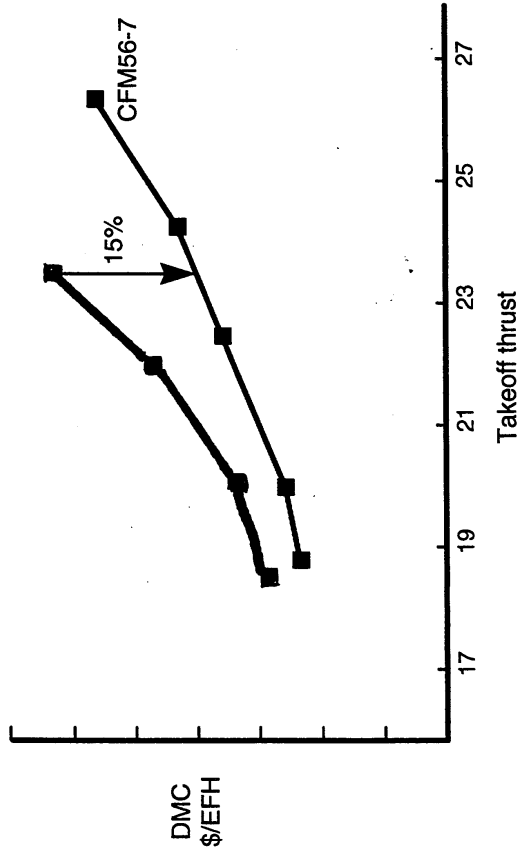

Improved Reliability

- **Use Existing Components if Reliable**
 - **Bleed Air Valves and Regulators**
- **Lessons Learned Incorporated From Other Programs**
 - **CTAI Valve, Starter, IDG, Fire Detectors**
- **New Technologies Must Be Proven Out**
 - **Precooler Control Valve**
- **Extensive Testing to Validate Designs**
 - **Complete EBU package on all engine tests (goal)**

INTERNAL EQUIPMENT BASIC REQUIREMENTS

- **PERFORM INTENDED FUNCTION**
- **CAN BE INSTALLED ON THE AIRPLANE**
- **BUILDABLE**
- **WITHSTAND INSTALLATION ENVIRONMENT**
 - **Vibration**
 - **Fatigue - Last the Life of the Airplane**
 - **Temperature**
 - **Fluid Resistance**
- **MEETS FAR'S**

Engine Without Cowls

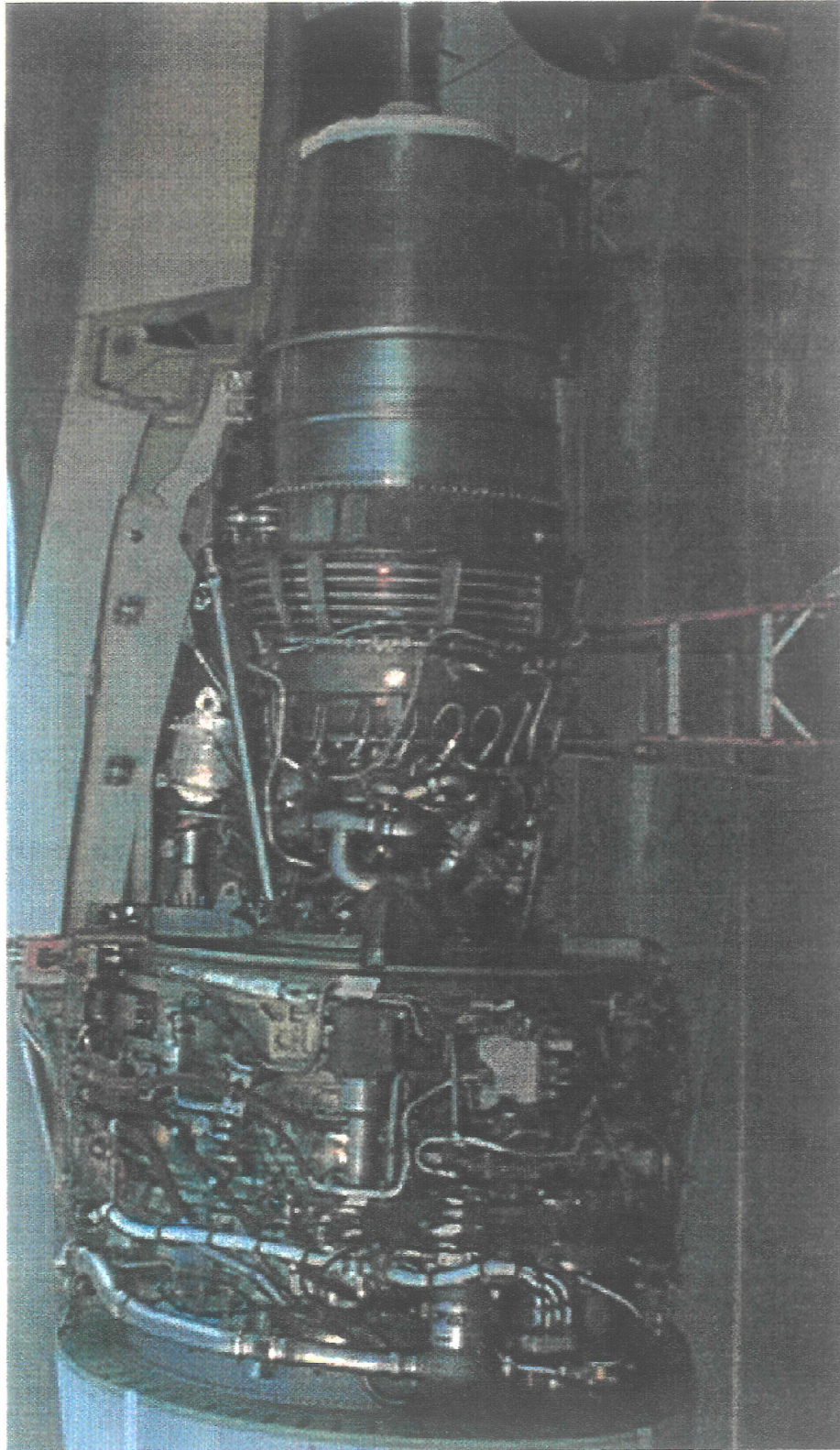

SPAGHETTI

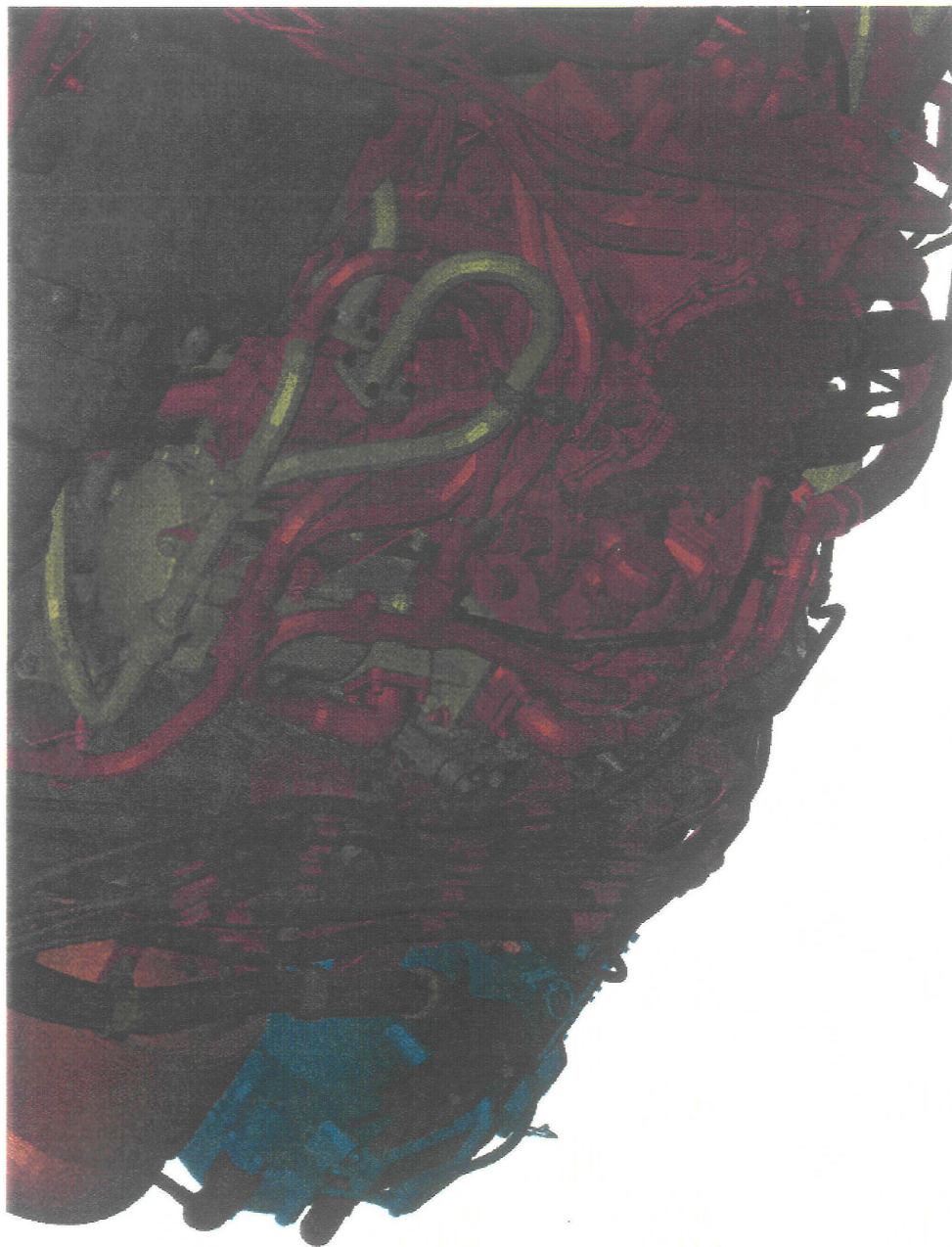

SPAGHETTI

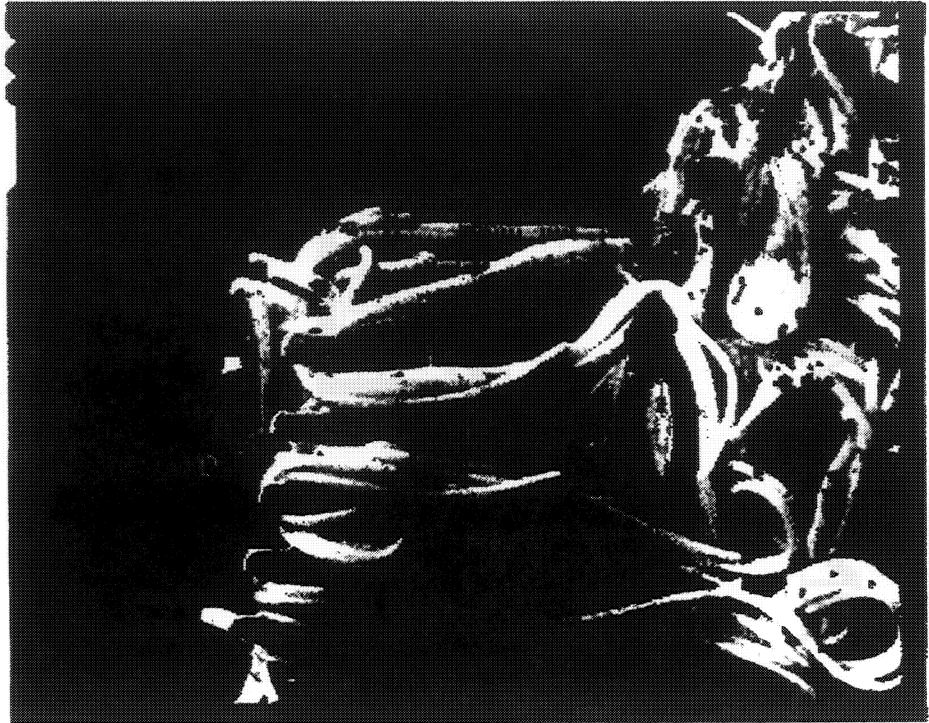

PNEUMATICS

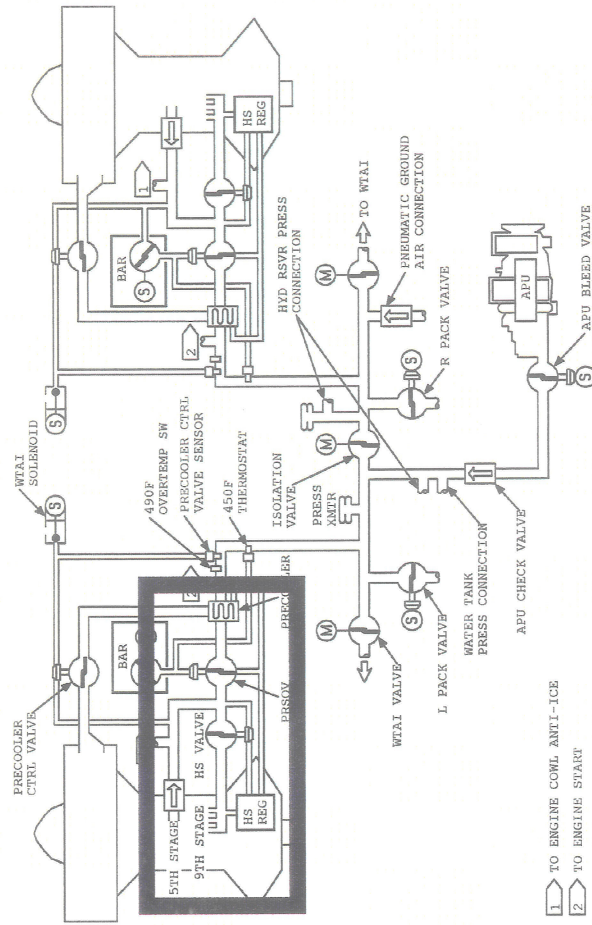
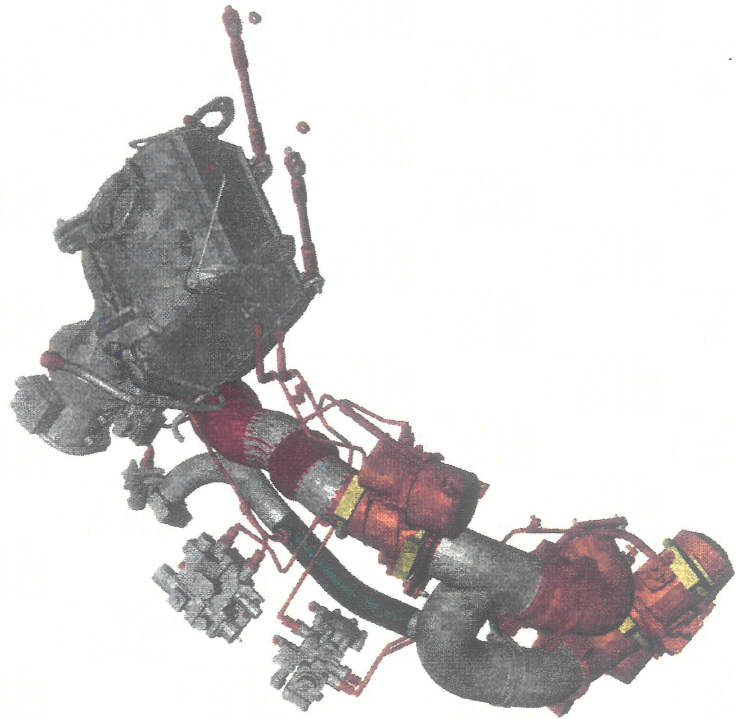

DISTRIBUTION - INTRODUCTION

PNEUMATICS

- Responsibilities
 - Ducting
 - Flex Joints
 - Flanges
 - Valve Installation
 - Controller Installation
 - Precooler Installation
- Requirements
 - Pressurize the Airplane
 - Temperature Control
 - Pressure Relief
 - Nacelle Cooling / Engine Case Distortion
 - Equipment Removals
 - Pressure Loss
 - MTBUR

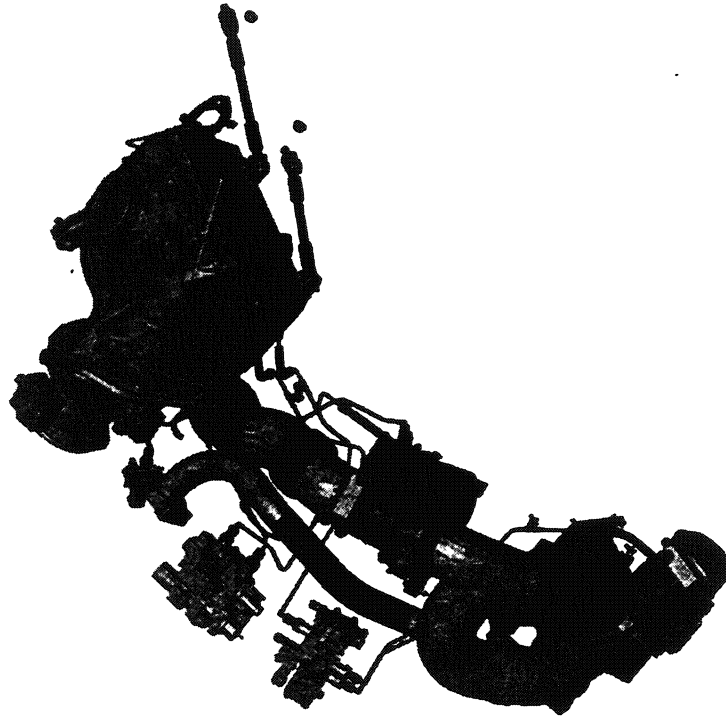

CTAI

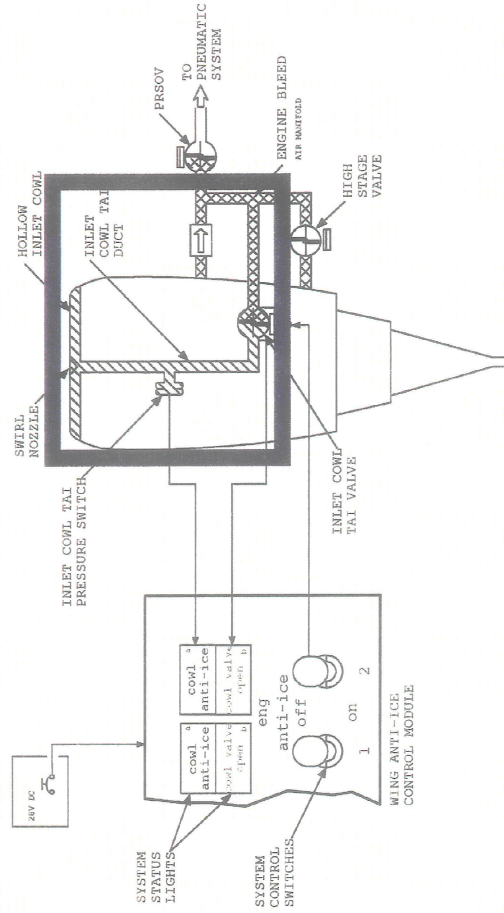

INLET COWL ANTI-ICING SYSTEM - INTRODUCTION

CTAI

- Responsibilities
 - Ducting
 - Flanges
 - Valve
 - Pressure Sensor Installation
- Requirements
 - Anti-Ice Engine Inlet
 - Pressure Drop
 - Heat Rejection into Fan Compartment
 - Valve Removal
 - MTBUR



PNEUMATICS MAINTENANCE

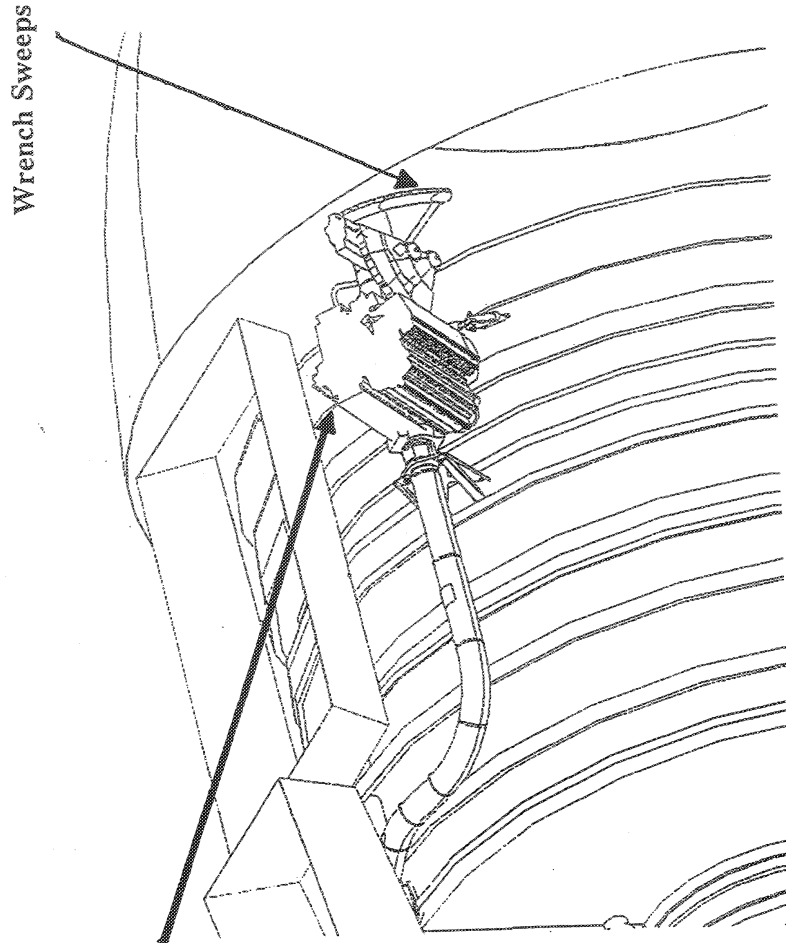

Wrench Sweeps

Modeling Removal Path
Swept Volume Stored in CATIA

PNEUMATICS MAINTENANCE

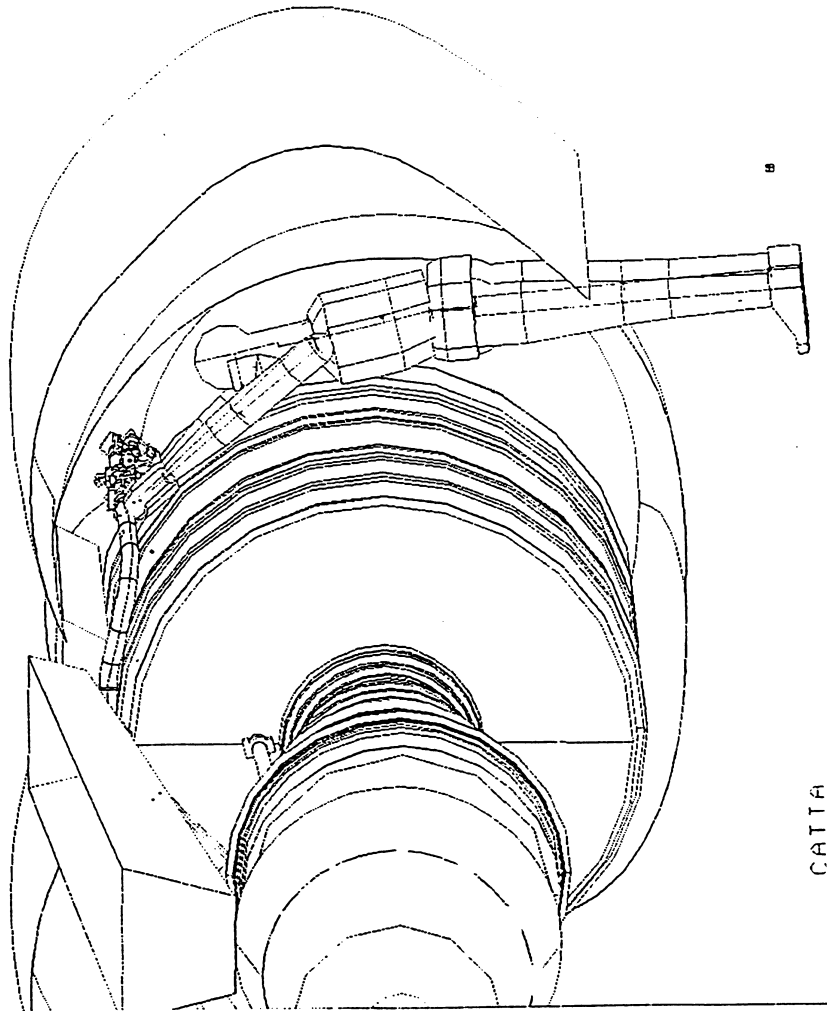

CAT 1A

STARTER

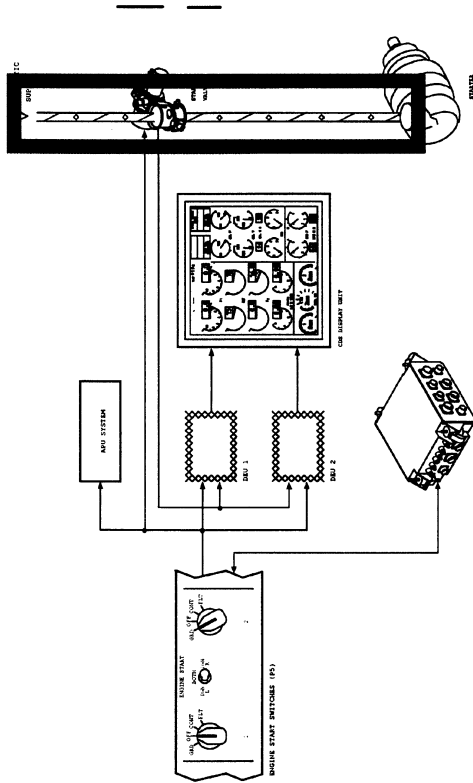
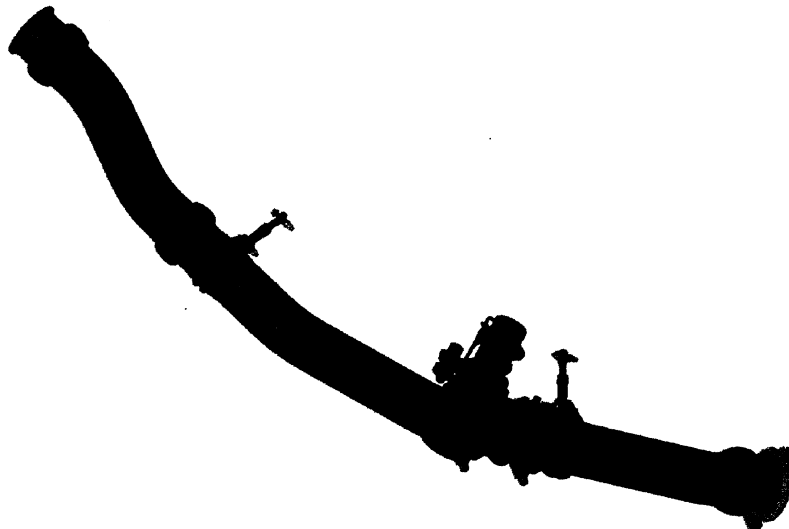

ENGINE STARTING - GENERAL DESCRIPTION

Change identifier in View - Header and Footer

STARTER

- Responsibilities
 - Ducting
 - Flex Joints
 - Flanges
 - Valve Installation
- Requirements
 - Supply Air to the Starter
 - MTBUR
 - Valve Removal

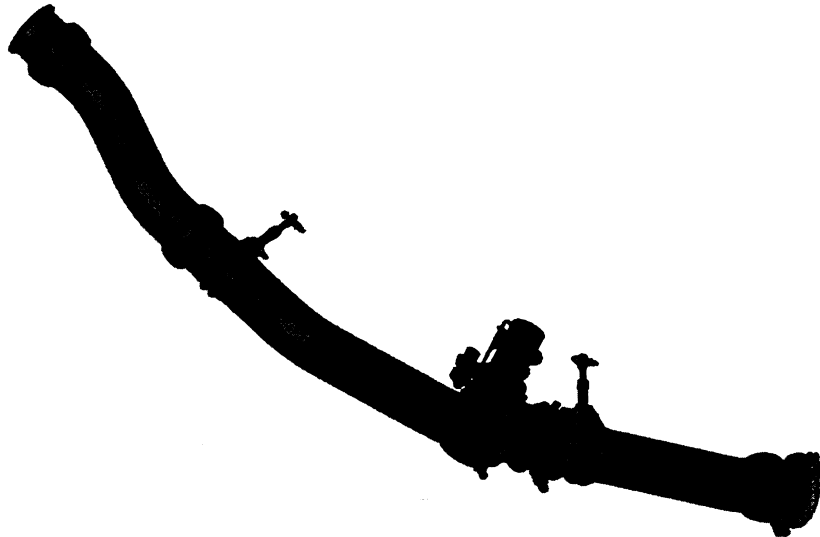

IDG

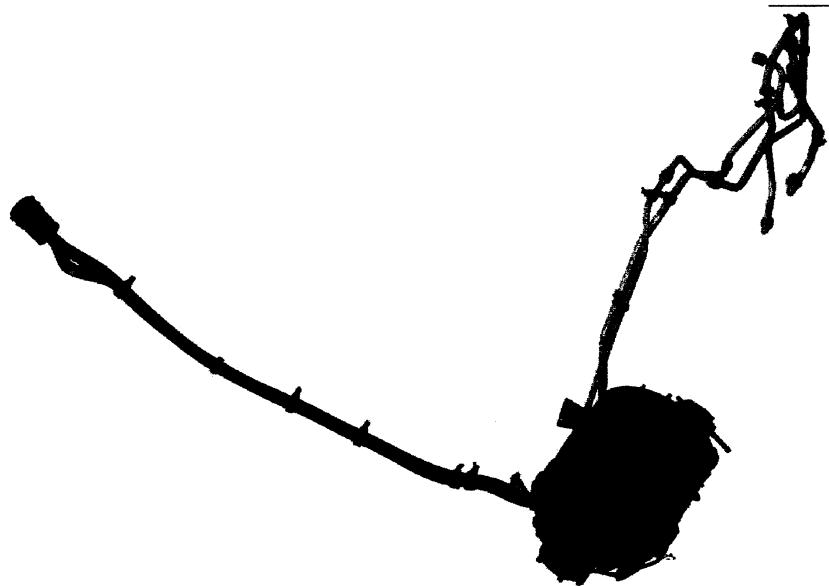
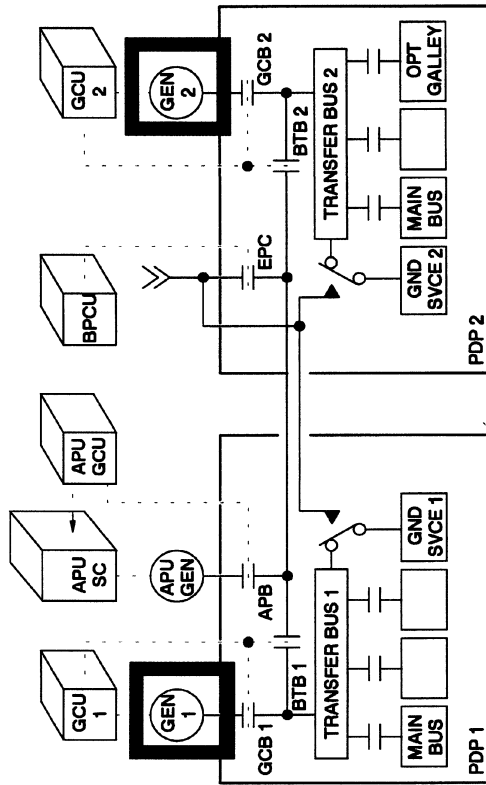

IDG

- Responsibilities
 - Power Feeder
 - Oil Cooling Lines
 - Air/Oil Cooler
 - IDG Installation
- Requirements
 - Engine/Gearbox Deflections
 - Pressure Drop
 - IDG Retention for Blade Out
 - IDG Removal
 - MTBUR
 - Fire Safety



FIRE PROTECTION

- Responsibilities
 - Fire Detectors
 - Fan Case Drains
 - Firex Tubes
- Requirements
 - Down Hill Drains
 - Overheat Detection
 - Fire Detection
 - Fire Detector Removal
 - MTBUR

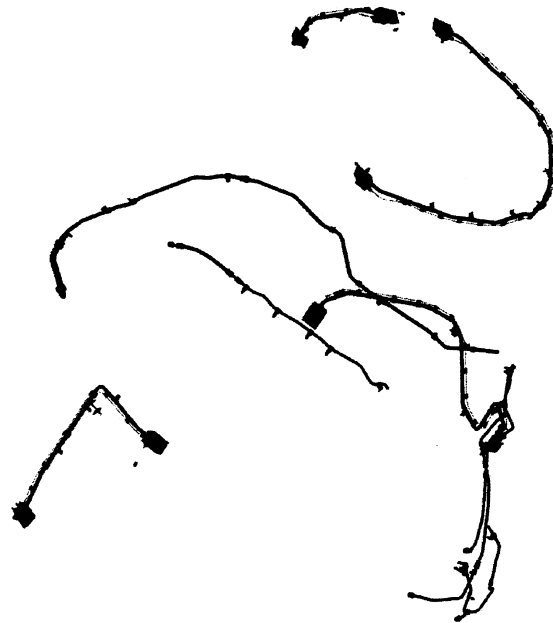

FIRE PROTECTION

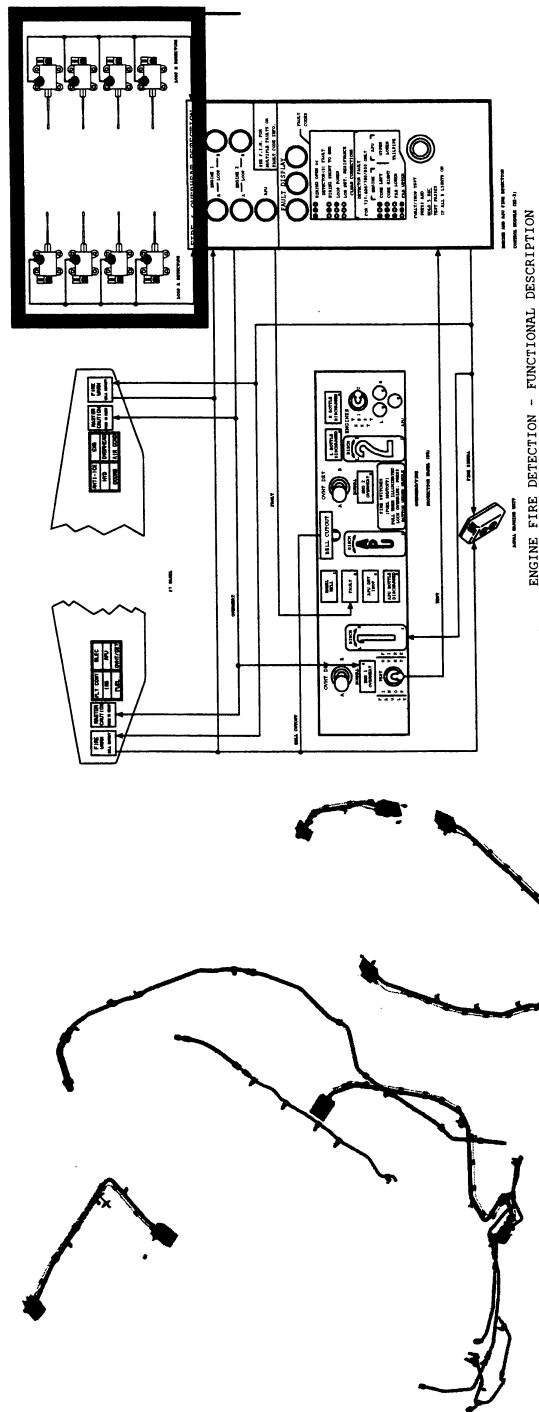

FUEL

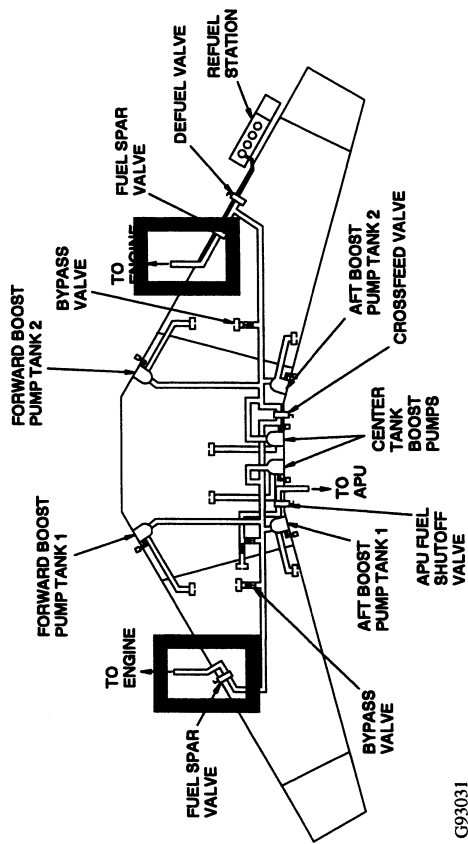

G93031

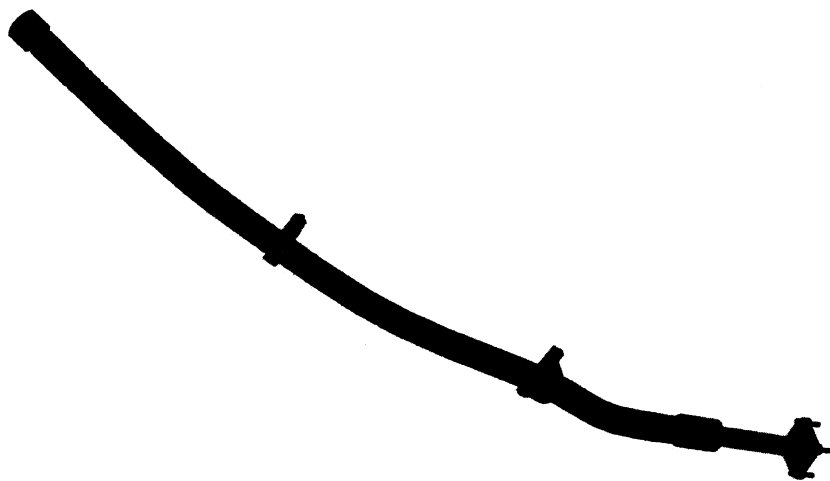

FUEL

- Responsibilities
 - Fuel Hose
- Requirements
 - Strut/Engine Deflections
 - Pressure Drop
 - Fire Safety

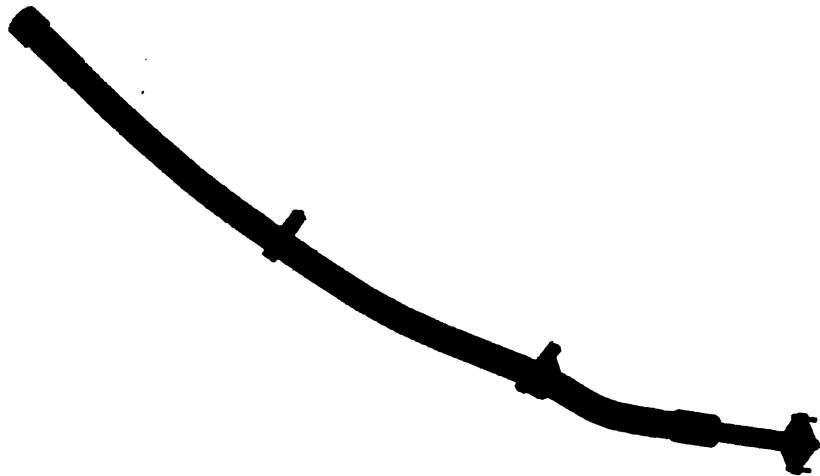

Hydraulics

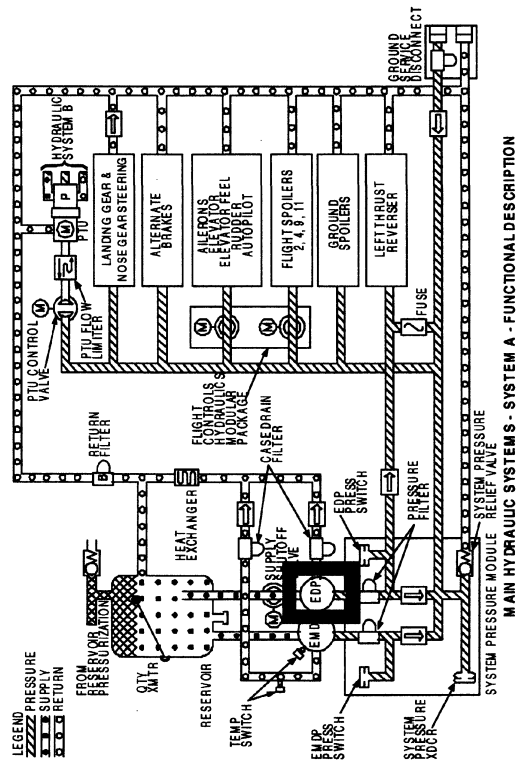
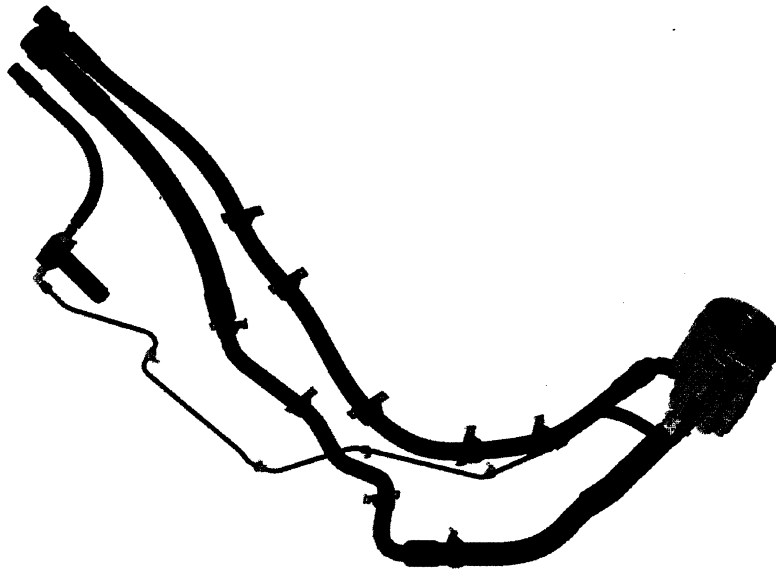

HYDRAULICS

- Responsibilities
 - Hoses
 - Tubes
 - Case Drain Filter Installation
 - Pump Installation
- Requirements
 - Pressure Drop
 - Fire Safety
 - Strut/Engine Deflection
 - Engine/Gearbox Deflection
 - Pump Removal
 - MTBUR

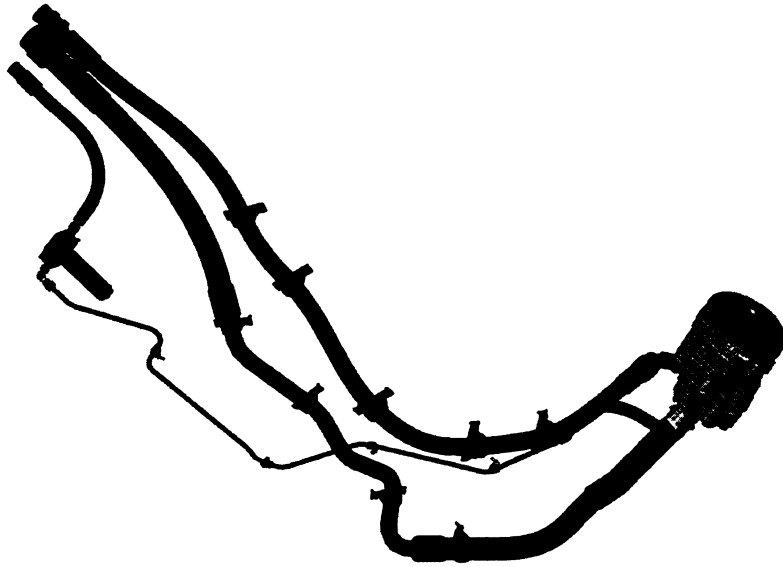

BRACKETS



BRACKETS

- Responsibilities
 - Brackets
- Requirements
 - Retain Systems and Components



Dependability

AIPLANE DEPENDABILITY COST ELEMENTS

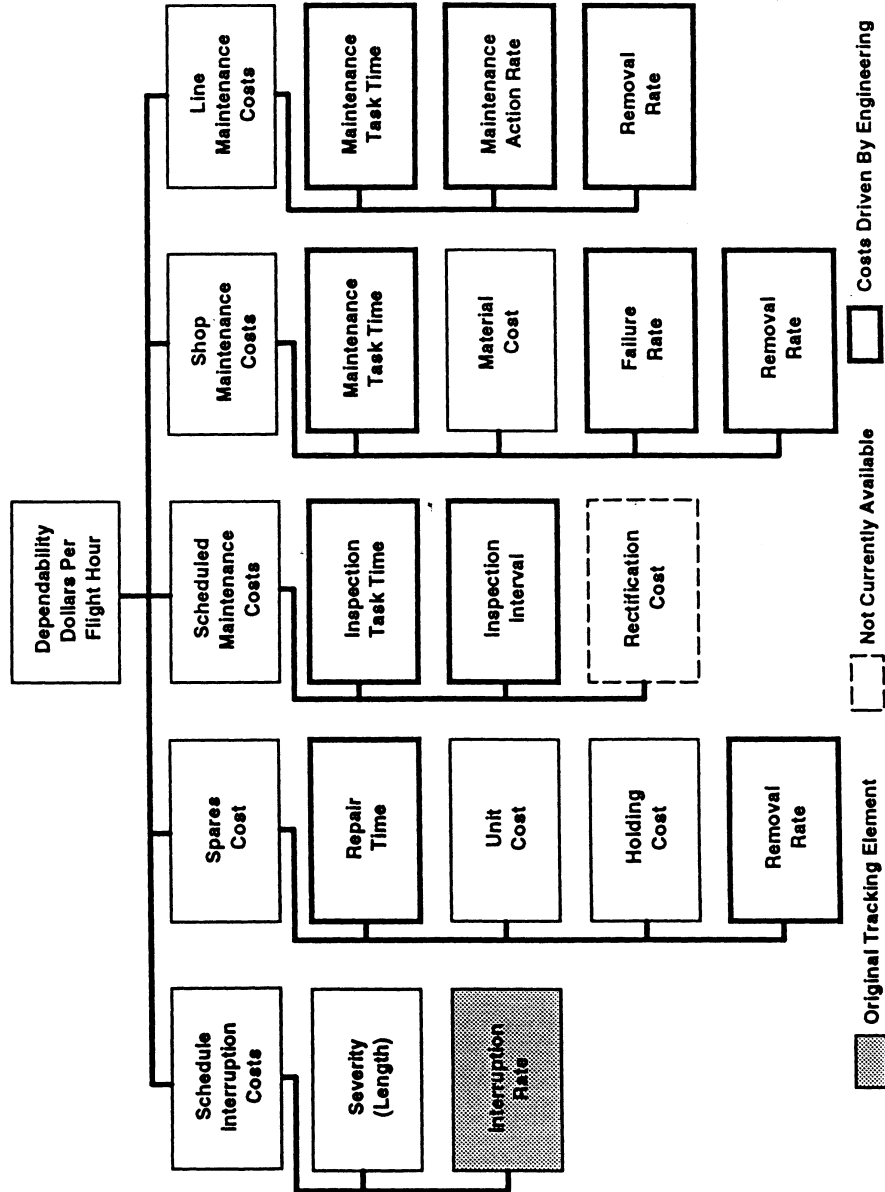

Conclusion

- **EBU Systems are the Power Source for the Airplane.**
- **Five Basic Requirements Are the Major Focus.**
 - **Function**
 - **Installation**
 - **Production**
 - **Environment**
 - **FAR's**
- **EBU System is a Small Portion of the Airplane Systems.**
- **One System can Effect Numerous Systems.**
- **Each System has Unique Requirements.**