

## Mars Science Laboratory Drill

Avi B. Okon\*

### Abstract

The Drill for the Mars Science Laboratory mission is a rotary-percussive sample acquisition device with an emphasis on toughness and robustness to handle the harsh environment on Mars. The unique challenges associated with autonomous drilling from a mobile robot are addressed. A highly compressed development schedule dictated a modular design architecture that satisfies the functional and load requirements while allowing independent development and testing of the Drill subassemblies. The Drill consists of four actuated mechanisms: a spindle that rotates the bit, a chuck that releases and engages bits, a novel voice-coil-based percussion mechanism that hammers the bit, and a linear translation mechanism. The Drill has three passive mechanisms: a replaceable bit assembly that acquires and collects sample, a contact sensor / stabilizer mechanism, and, lastly a flex harness service loop. This paper describes the various mechanisms that makeup the Drill and discusses the solutions to their unique design and development challenges.

### Introduction

The Mars Science Laboratory (MSL), scheduled to launch in the fall of 2011, is part of a long-term effort of robotic exploration of Mars that will assess whether Mars ever was, or is still today, an environment able to support microbial life. The MSL rover features the most advanced robotic Sample Acquisition, Sample Processing and Handling [1] (SA/SPaH) subsystem ever sent to another planet (see Figures 1a and 1b). The major elements of the SA/SPaH subsystem are a Robotic Arm (RA) with a tool and instrument laden turret. The tools are: a sample acquisition Drill, scooping, sieving and portioning device called CHIMRA [2], and the Dust Removal Tool (DRT). The instruments are the APXS and MAHLI.

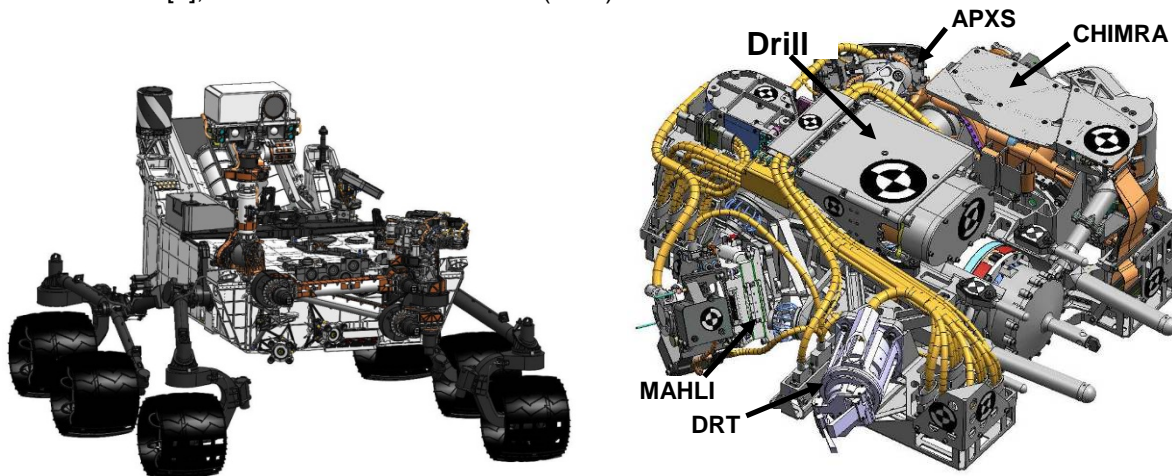


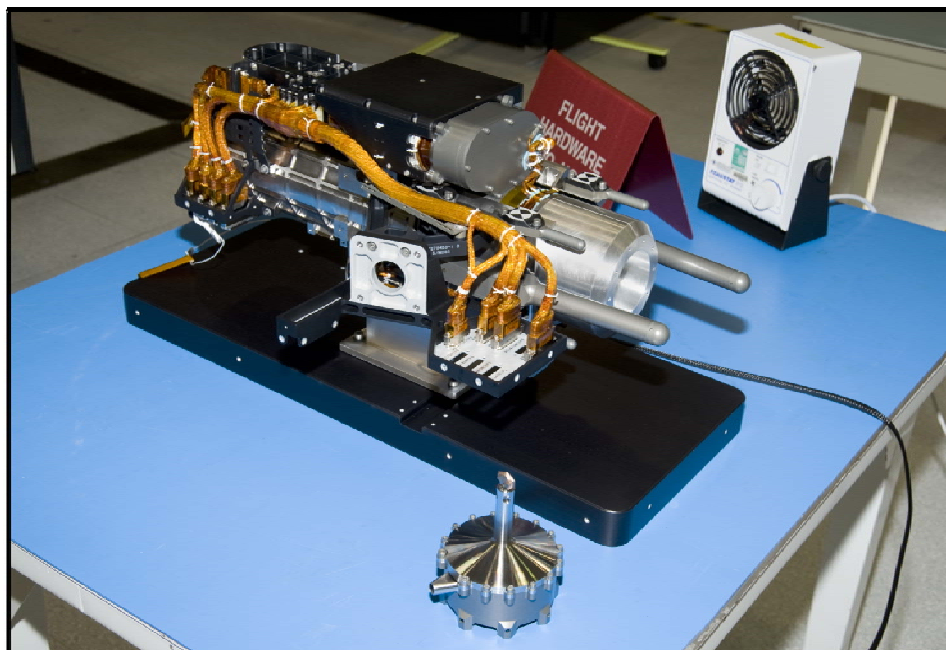
Figure 1. (a) MSL Rover (b) SA/SPaH Turret

The primary sample acquisition element of SA/SPaH is the Drill (see Figure 2) which collects powdered samples from various rock types (from clays to massive basalts) at depths up to 50 mm below the surface. The Drill then transfers the powdered sample to a processing device, the CHIMRA, which subsequently delivers sieved and apportioned samples to the science instruments housed in the belly of

---

\* Jet Propulsion Laboratory, California Institute of Technology, Pasadena, CA

the rover. A typical sample acquisition operation with the Drill is described as follows. The Drill is placed in contact with the target rock by the SA/SPaH RA. A telemetry switch indicates contact has been made. The Drill is then preloaded onto the target by the RA for increased stability, reducing the likelihood of shifting during the operation. The Drill acquires the sample by rotating and hammering while maintaining a desired weight on the bit. Upon the completion of sample acquisition, the Drill retracts from the hole to a stow configuration and is disengaged from the rock by the RA. Lastly, through a combination of gravity manipulations by the RA and vibration environment generated by the Drill percussion mechanism, the sample is transferred from the Drill to the CHIMRA for further preparation.



**Figure 2. Engineering Model MSL Drill, Bit Assembly in Foreground (some of the turret brackets are attached to the housing and a ground adapter is chucked)**

### Drill System Development

Though the primary design objective of the Drill is the reliable acquisition of samples from rocks of various strength and composition, many aspects of the design (especially its mass and volume) were driven not by its primary function, but from the dreadful things that could happen while on the surface of Mars. What follows are some of the device's more pertinent design drivers.

#### Live long and drill – that's a requirement!

The Drill is designed to provide 81 samples for the science payload on MSL. To meet the strict cross contamination requirement across the sampling system, the Drill must also provide samples for dilution cleaning: the acquisition of a pre-sample for the sole purpose of flushing the residual of the previous sample from the entire sample path. This, in effect, doubles the drilling depth requirement. Since drilling on Mars is inherently a dry process, a rotary percussive drill was implemented after development testing showed that it produced significantly less bit wear than a rotary drag bit type (especially on rock with high compressive strength). Even still, in order to show margin to the life requirement, the Drill has the ability to replace a worn bit with a fresh one during the mission. Additionally, since sample flows solely within the bit, the ability to jettison a clogged bit adds another level of robustness.

Two spare bit assemblies, housed in their own bit box assemblies, are mounted to the front panel of the rover. A clever bit exchange method, which uses three active elements of the Drill (translation, rotation

and the chuck), enables the bit boxes to be passive devices while minimizing the impact to the Drill's volume and mass. The success of this execution is evident by the presence of only two additional features on the Drill for the sole purpose of bit exchange: the retaining features on the bit and the alignment posts on the contact sensor assembly for docking the Drill to the bit box.

#### It's a dirty and dangerous job...

The collection of extraterrestrial samples from a mobile robot on rough terrain poses the unique challenge of ensuring reliability and robustness in a highly indeterminate environment. One example is the sustained and maintenance-free operation in a dirty environment. Wherever possible, the moving components were placed internally within the sealed Drill housing, otherwise they were designed to be tolerant of dirt. The specific implementation of the latter will be discussed in the subsequent sections.

Since many highly valued science targets on Mars such as outcroppings are located on rough and steep terrain, the MSL rover has been designed to acquire samples from sloped surface up to 20 degrees. The compressed development schedule required the generation of a load case that could be defined and articulated relatively quickly. Without any ensured friction between the rover wheels and the surface of Mars, a worst-case load scenario was generated: a complete loss of friction at the rover wheels on a 20-degree slope while the tip of the bit was locked to the surface. One component of the Drill could not be designed to show positive margin for this load case: the bit. To meet this requirement the bit diameter would have to grow considerably, increasing the volume of sample collected. Larger cavities would be needed to process the additional sample causing the turret to exceed its volume allocation. Since the failure of one mechanical component cannot be counted on to protect the others downstream, all the non-replaceable elements of the Drill have been designed and will be qualified to the worst-case loads. Throughout the remainder of the paper, it will be shown how this single requirement drove the overall volume, structural design and required capability of many of the mechanisms of the Drill.

#### Live long (reemphasis) – even if you can't drill

Penetrating the surface from a *mobile* robot requires that a single mechanism fault in the Drill cannot result in the anchoring of the entire rover to the Martian surface; and the bit being “stuck” in a rock is not a mechanism fault – it is part of the process. This requirement flowed into two capabilities: (1) generate a large force to extract a stuck bit and (2) release the bit subjected to the worst-case load scenario. These functions are entirely independent throughout the system (including being powered by separate electronic drivers) such that a loss of one function will not preclude the operation of the other. Defining a “stuck” bit is somewhat of a slippery slope – pun intended. Lacking a more accurate definition of stuck, it was the intent of the Drill design to provide a sufficient retraction force to dead-pull the bit without percussion from a rock while under the worst-case load scenario. However, development testing showed that the force to extract a bit while subjected to 40% of the worst-case load scenario was higher than the maximum capability of the Drill. Mass and volume constraints of the turret precluded additional capability. However, a promising result observed in the force time history plots showed a stick-slip phenomenon which implies that the load required may be significantly reduced by hammering the end of the bit – a capability that the Drill has. This conservative test case was based on the assumption that the flight system would do nothing to alleviate the loads on the bit. It is emphasized that the flight system must carefully assess risk when sampling on steep and uncertain terrain.

#### Divide and conquer

Through a series of unfortunate events, the brunt of the design and implementation of the Drill started mid-summer of 2007 when the completion of the conceptual design kicked-off an intense effort to meet a launch date of fall 2009 (prior to the slip to 2011). As a result, a large emphasis of the Drill design architecture was placed on modularity allowing various mechanisms of the Drill to reach design maturity relatively independently. This approach demanded heavy coordination of interfaces; however, by keeping the interfaces simple and avoiding an overly intertwined design, the process was streamlined by only requiring the consensus of two mechanism engineers with the cognizant engineer providing review, arbitration and concurrence.

The modular approach was not exclusive to the design phase. A team of supporting engineers, working closely with the flight hardware engineers, designed, built and executed twelve Drill Development Tests (DDT) across several test platforms starting in September 2007 and completing in June 2008 (see Table 1). DDT-3 through 6 were performed using a prototype drill, mounted to a robot arm, that was functionally equivalent to the flight Drill featuring: a flight-like bit assembly, chuck (passive), spindle, voice coil actuated percussion mechanism, representative stabilizer kinematics and a weigh-on-bit force sensor. Drilling tests (DDT-3) in various rock types with natural surfaces generated the design requirements for: spindle torque and speed, impact energy, and weight-on-bit. This test activity also yielded algorithms for autonomous drilling that will be implemented in flight system software. Other test platforms utilized duplicate prototype Drill subassemblies so that those tests could be performed in parallel.

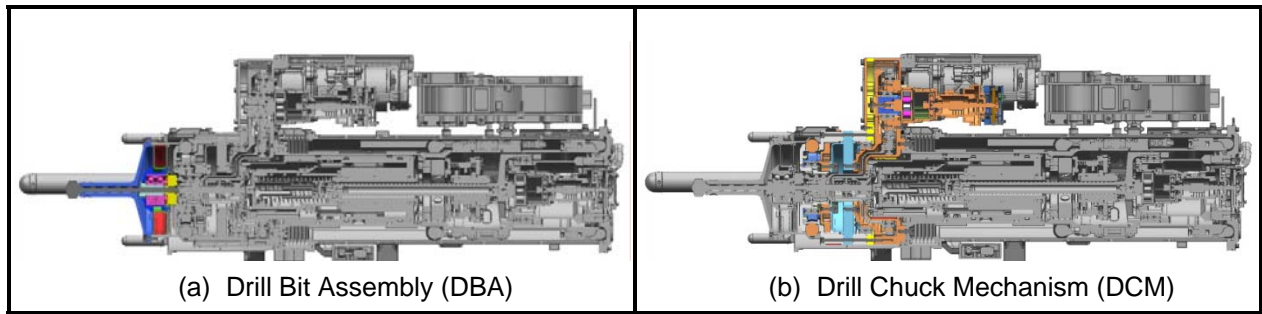
**Table 1. A list of completed Drill Development Tests indicating the usage of flight-like prototype mechanisms: bit assembly (B), spindle (S), chuck (C), percussion (P)**  
*Italicized text indicates tests performed using an arm-mounted prototype Drill*

<b>DDT-1</b> Cold Spindle / Bit Drag (B,S)	<b>DDT-2</b> Bit Exchange (pickup only) (B,S,C)
<i><b>DDT-3</b> Drilling Parameters (B,S,C,P)</i>	<i><b>DDT-4</b> Drilling from a Compliant Arm (B,S,C,P)</i>
<i><b>DDT-5</b> Dynamic Environment due to Drilling (B,S,C,P)</i>	<i><b>DDT-6</b> Bit Life (B,S,C,P)</i>
<b>DDT-7</b> Sample Flow in Low Pressure (B,C,P)	<b>DDT-8</b> Bit Release Under Load (B,C)
<b>DDT-9</b> Sampling at Low Pressure (B,S,P)	<b>DDT-10</b> Bit Retraction Force (B – tube and bit only)
<b>DDT-11</b> Force Sensor PQV	<b>DDT-12</b> Percussion Cable Cycle Life

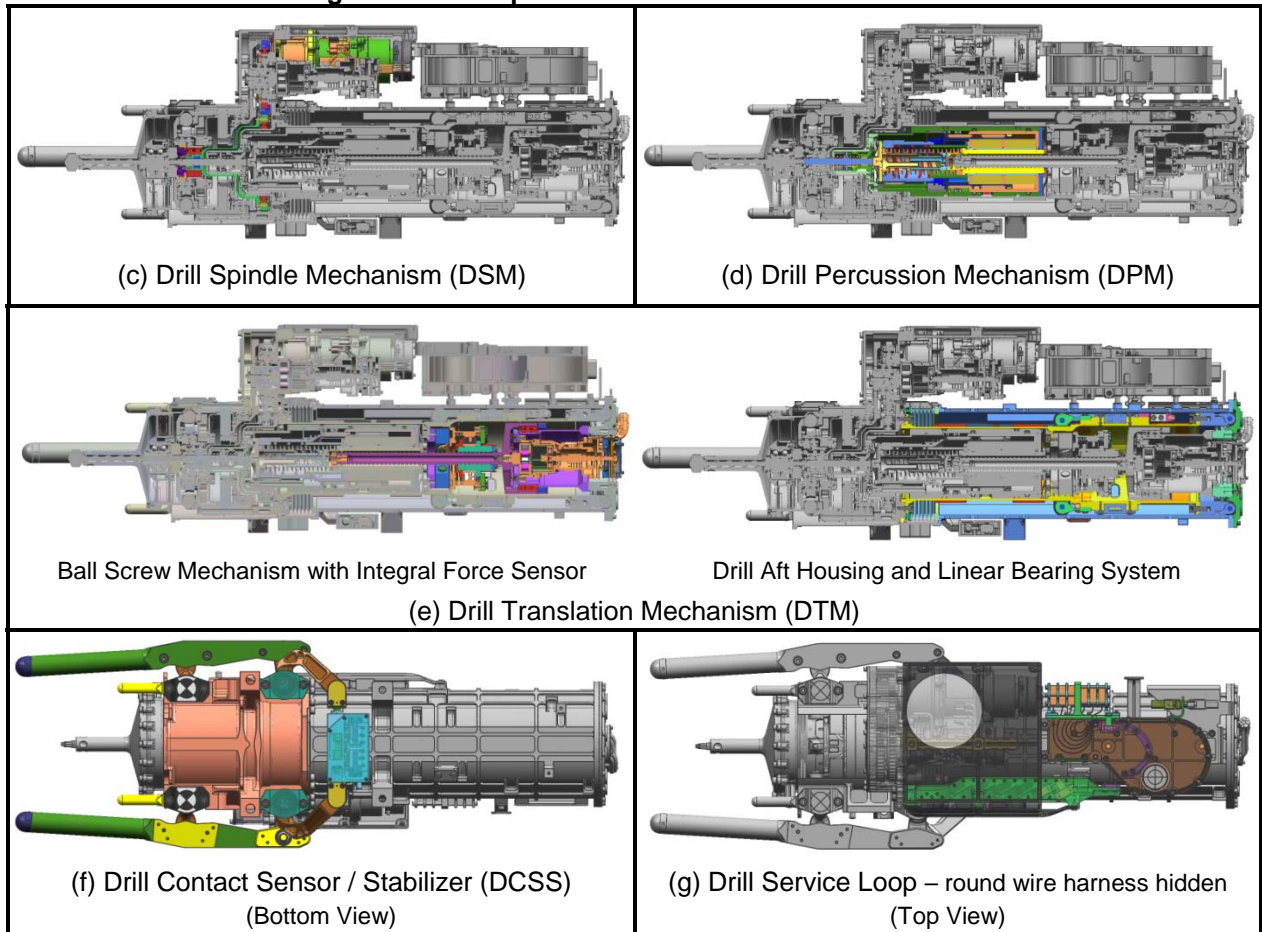
Lastly, the modular design extends into flight Drill integration and testing. All the mechanisms in the Drill are fully assembled and qualification tested prior to being integrated into the Drill top level assembly. Thus, some of the lessons learned during the assembly and test of one Drill sub-mechanism was preemptively applied to others. Some of these discoveries included: manufacturing defects, cabling process errors, chamber frost mitigation and electronic ground support equipment operation.

### Drill Design Description

Autonomous sample acquisition is a complex process that requires a device with high functional density. The Drill is comprised of 7 sub-elements depicted in Figure 3. Starting at the business end of the Drill, there is a bit assembly that cuts the rock and collects the sample (Figure 3a). Supporting the bit is a subassembly comprised of a chuck mechanism (Figure 3b) to engage and release the new and worn bits, respectively, and a spindle mechanism (Figure 3c) to rotate the bit. Just aft of that, is a percussion mechanism (Figure 3d) which generates hammer blows to break the rock and create the dynamic environment used to fluidize the powdered sample. The aforementioned components are mounted to a translation mechanism (Figure 3e) which provides linear motion and senses weight-on-bit with a force sensor. There is a passive contact sensor / stabilizer mechanism (Figure 3f) that secures the Drill's position on the rock surface, and flex harness management hardware (Figure 3g) to provide the power and signals to the translating components. The remainder of this paper describes the Drill mechanisms, highlights how their design features enable the execution of reliable extraterrestrial drilling, and expands on various design challenges.



**Figure 3 a-b. Depictions of the Drill Sub-Assemblies**



**Figure 3 c-g. Depictions of the Drill Sub-Assemblies (cont.)**

### Development and Design of the Drill Mechanisms

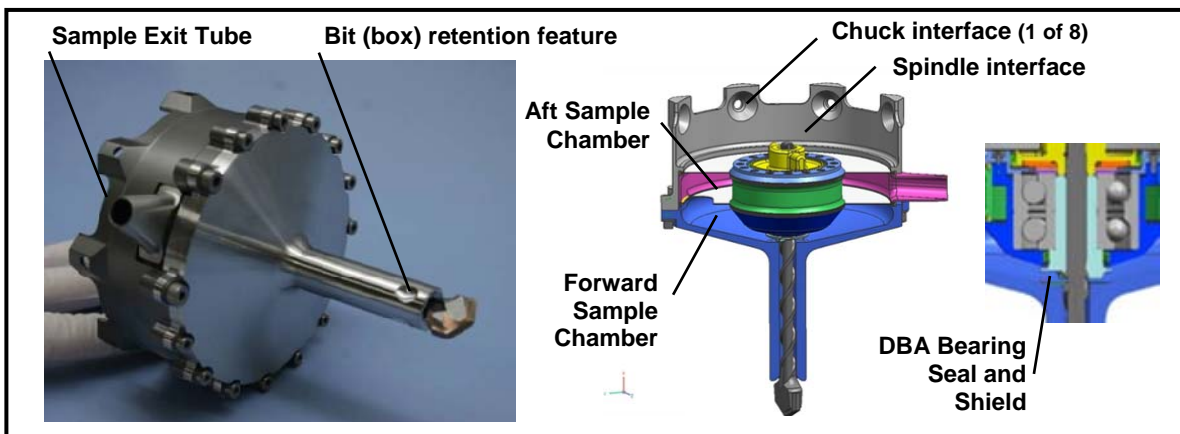
#### Drill Bit Assembly

The Drill Bit Assembly (DBA) is a passive device which is rotated and hammered in order to cut rock (i.e. science targets) and collect the cuttings (powder) in a sample chamber until ready for transfer to the CHIMRA. The DBA (Figure 4a) consists of a 5/8-in (~16-mm) commercial hammer drill bit whose shank has been turned down and machined with deep flutes designed for aggressive cutting removal. Surrounding the shank of the bit is a thick walled maraging steel collection tube allowing the powdered

sample to be augured up the hole into the sample chamber. For robustness purposes, the wall thickness of the DBA was maximized while still ensuring effective sample collection. There are four recesses in the bit tube that are used to retain the fresh bits in their bit box (Figure 4a).

The rotating bit is supported by a back-to-back duplex bearing pair within a housing that is connected to the outer DBA housing by two titanium diaphragms. These bearings, the only ones on the Drill in the sample flow, are protected by a spring energized seal and an integrated shield that diverts the ingested powdered sample from the moving interface (Figure 4b).

The DBA diaphragms provide radial constraint of the rotating bit and form the sample chambers. The axial compliance of the diaphragms (combined with anvil springs in the Drill Percussion Mechanism) reacts the weight on bit generated by the Drill Translation Mechanism. Between the diaphragms there is a sample exit tube from which the sample is transferred to the CHIMRA. To ensure that all sample is retained no matter the orientation of the Drill with respect to gravity during sampling, the pass-through from the forward to the aft chamber resides opposite to the exit tube (Figure 4b).



**Figure 4. (a) EM Drill Bit Assembly (b) Sample paths and interfaces of the DBA**

The DBA interfaces to the rest of the Drill via eight circumferential, conical recesses in its housing and a torque coupling affixed to the end of the bit shank. There are through holes at the bottom of each recess so that any Martian dust accumulated on spare bits stored on the rover can be pushed outward when a fresh bit is acquired. The DBA interface to the Drill has a small prescribed amount of free play. This both allows the DBA to find its natural path into the rock and decouples most of the cyclic radial load due to the bit-rock interaction from being transmitted to the rest of the Drill.

Lesson learned:

Mechanism components that operate in a dirty environment require some or all of the following features: dedicated pathways for the flow of particles, cavities that can receive debris, and compliant elements to accommodate the presence of junk. In addition to the DBA, these features were implemented in the Drill Chuck Mechanism and the switch assembly of the Drill Contact Sensor / Stabilizer.

Drill Spindle Mechanism

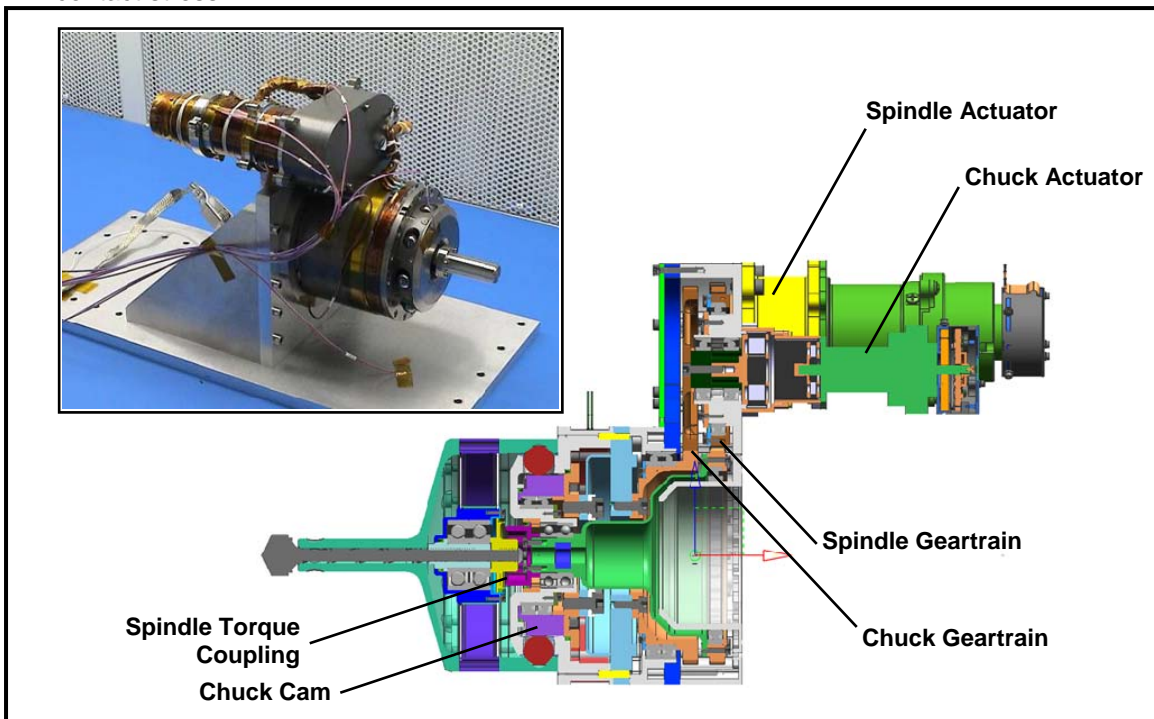
The Drill Spindle Mechanism (DSM), nested within the Chuck / Spindle Sub-assembly (Figure 5) provides the torque to rotate the bit for drilling and unlocking the fresh bit assemblies from the bit box. The mechanism is actuated by an electrically-commutated gearmotor that drives the spindle shaft via a spur geartrain. The output shaft is support by a bearing pair at the nose (near the torque coupling to the bit) and a single deep groove bearing at the rear (under the spindle gear). The maximum mean contact stress in the bearings is kept low to prevent lube degradation. Mounted to the shaft is a dirt-tolerant torque coupling that transmits torque to the bit. The coupling accommodates axial, radial and angular motion

between the bit and spindle shaft to permit the following functions: the transmission of the hammer blow directly onto the bit, the mating of a fresh bit, and release of the bit both in free space and under load.

#### Drill Chuck Mechanism

The Drill Chuck Mechanism (DCM), also residing within the Chuck / Spindle Sub-assembly (Figure 5), enables the Drill to release worn bits and take hold of fresh ones stored on the rover front panel. The design driver not only included the requirement to survive the worst-case load scenario but also to release the bit while subjected to it. The DCM is a dirt tolerant ball lock device that consists of eight stainless steel balls that are pushed out radially by a rotary cam. The cam is actuated via a drivetrain consisting of an electrically-commutated gearmotor with a power-off brake, a single spur gear stage and a harmonic drive. This mechanism underwent substantial high fidelity development testing with a prototype 12-ball chuck mechanism (DDT-8). The objectives were to:

1. Verify cam mechanism tolerance to airborne dust particles and self-generated rock particles, and demonstrate the effectiveness of its seals.
2. Measure the torque requirement to release under the worst-case load scenario with and without the presence of various types of rock particulate.
3. Estimate the coefficient of friction at the ball interfaces to more accurately evaluate the peak contact stress.



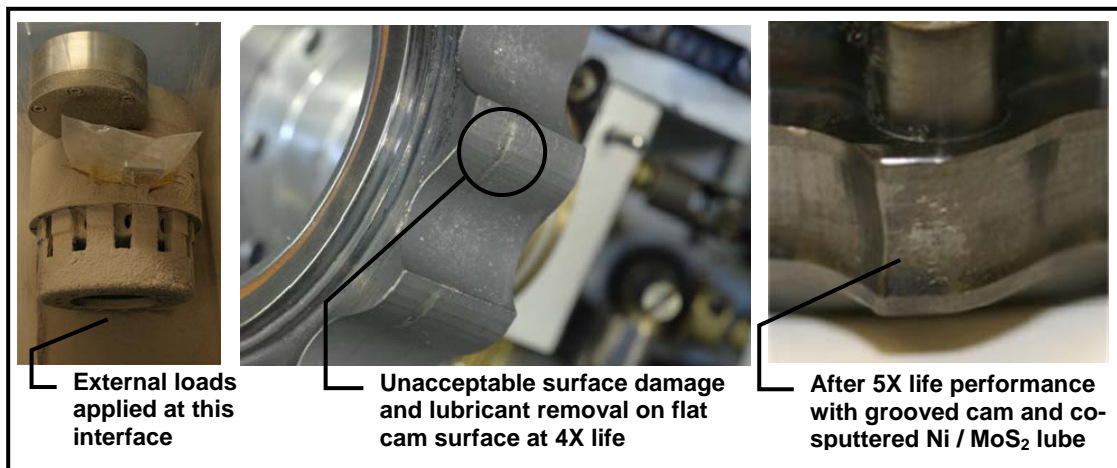
**Figure 5. Chuck / Spindle Subassembly with Bit Assembly  
(inset: EM Unit Ready for Spindle Thermal Dyno Test)**

The mechanism demonstrated 4X life operation, fully loaded, with the ball cavities filled with both fine and coarse Martian regolith simulant with sufficient torque margin (Figure 6a). Even corundum particles introduced were crushed easily. However, the coefficient of friction estimated from the test results showed that the contact stresses on the cam was above the material allowable. This was verified upon disassembly and inspection of the cam where local surface deformation was found. Additionally, there were tracks where the Lub-Lock 4306 dry lubricant was worn away (Figure 6b). The analysis also showed that the highest stress was on the sloped portion of the cam profile. To lower the contact stress the cam surface curvature was reduced by decreasing the number of balls from twelve to eight. However, the analysis still showed that this was insufficient, so a conforming curvature shape was also implemented on

the cam to reduce the contact stress. The new cam design with an improved dry lubricant process was tested again to 5X life (Figure 6c) with the same dirt tolerance conclusion and no detriment to the cam surface.

Lesson learned:

High-fidelity development test hardware is worth its weight in unobtainium. Although the initial development test results show that there was sufficient torque margin at end of life, it was deemed inappropriate to implement a design that would degrade under expected operational conditions especially with the likely unknown unknowns associated with planetary exploration.



**Figure 6. (a) Development Test DCM Dirty Testing (b) Post Test Flat Cam Surface (c) Post Test Grooved Cam Surface**

Drill Percussion Mechanism

The Drill Percussion Mechanism (DPM) generates the impact needed to break the rock and the dynamic (vibration) environment required to move powdered sample through the DBA (Figure 7). The DPM is a functionally simple device consisting primarily of a hammer assembly, a spring, and a housing assembly. The DPM is actuated by a long-stroke voice coil developed by BEI Kimko Magnetics. It is wound with bifilar magnet wire providing graceful degradation in the case of an open winding.

The 0.4-kg hammer assembly strikes the end of a spring-suspended anvil rod that remains stationary and in contact with the end of the bit. The anvil spring rate is one half of the axial spring rate of the DBA such that it supports one third of the weight on bit. The percussion action is a transfer of momentum from the moving hammer, through the anvil in the form of a stress wave, then through the bit and ultimately to the rock. The DPM operates at 1800 blows-per-minute with variable impact energies from 0.05 to 0.8 Joules.

There are three integral linear bearing rails with polished hard anodized surfaces in the aluminum housing of the DPM. Spring elements are used across most of the interfaces within and external to the mechanism to accommodate the various coefficients of thermal expansion. The percussion housing features grooves that contain internal and external radial expansion spring pairs to accommodate relative radial dimensional variations to the steel voice coil magnet field assembly mounted within it and the titanium tube it is mounted within, respectively. In the axial direction, dedicated wave springs ensure that preloads are maintained and thermally induced stresses are minimized between the following: the percussion housing and the rest of the Drill, the voice coil field assembly and field cable guide, and the percussion housing and the voice coil field assembly. The last spring also functions as the retraction hardstop absorbing the residual kinetic energy if the hammer exceeds its nominal range of motion.

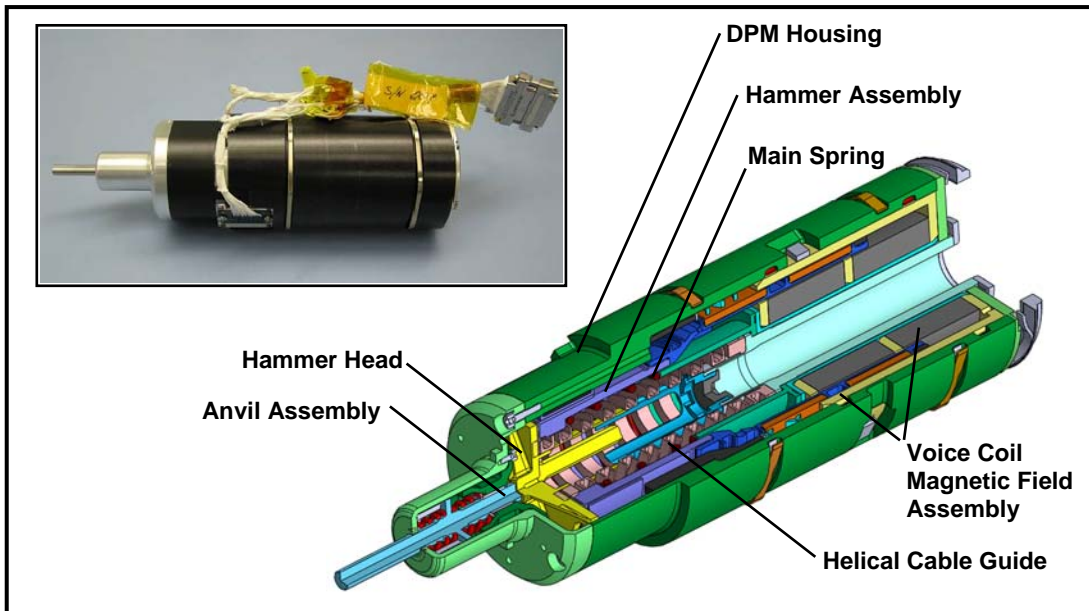
The hammer assembly is comprised of a maraging steel hammer head fastened to an aluminum flexure body which is adjoined to the voice coil bobbin (windings) via a threaded joint and structural adhesive.



The hammer head has three tabs that engage the retraction hardstop. The flexure body has these features: a splice cavity where the harness is connected to the voice coil magnetic wire, a permanent magnet assembly which activates a bank of reed switch sensors, and three flexure suspended DU bearing segments. An inverted DU bearing is bonded to the end of the voice coil bobbin providing an aft support bearing surface which rides along the inner surface of the voice coil magnetic field outer pole piece. The aft bearing ensures that only dedicated wear components are in contact. DU bearings were selected for their high wear life and low service temperature; the latter reduces the required heater power for the cold operation of this mechanism. Beryllium Copper was selected for the bobbin material.

Within the hammer assembly there is the main spring of the mechanism which provides two functions: (1) it stores the work done by the voice coil on the upstroke for delivery on the downstroke and (2) it captures the rebound energy from previous impact for use on the next impact. The voice coil actuator simply needs to recoup the energy lost during the impact (causing rock fracturing) and internal mechanism losses. One technical challenge discovered on the prototype percussion mechanism was spring surge of the main spring. The original springs were failing prematurely due to the proximity of the spring's natural frequency with the operating frequency. This was solved by changing the spring material to one with a lower shear modulus, lower density and high fatigue strength. The new spring allowed a large amount of stored energy while maintaining an appropriately large separation between the operating frequency and its natural frequency.

Inside the main spring, the voice coil harness is routed within a unique helical cable guide assembly whose helix direction is opposite of the main spring. Inspired by a telephone handset cord, the design controls the location of the harness, provides significant stroke while minimizing wire strain, and has a very low spring rate. To avoid contact with the main spring, the inner diameter of the cable guide helix is control by a split, fingered mandrel integrated into the moving hammer head and stationary side of the cable guide assembly. The outer diameter of the main spring is controlled by the inner surface of the flexure housing. During assembly of the mechanism, the clearances were verified to ensure there will always be a gap between the two components.



**Figure 7. Drill Percussion Mechanism**

Another challenge were eddy currents due to the electrically conductive voice coil bobbin material moving quickly through a magnetic field. This manifested itself as a velocity dependent loss force (i.e., viscous damping) that had to be eliminated for efficient operation. The solution implemented was to cut axial slots in the bobbin in the area that was exposed to the magnetic field. The slots were then filled with non-

conductive structural adhesive. This increased the effective electrical resistance of the bobbin in the appropriate direction without compromising the thermal conductive properties of the bobbin. When implemented on the prototype mechanism, there was no measurable performance difference between the slotted Be-Cu bobbin and a polymeric one.

The voice coil drive method is quite different to the electrically commutated motors that power the rest of actuators in the Drill. Due to its late development in the MSL project life cycle, the voice coil actuator needed to be compatible with the existing motor drive electronic hardware. Additionally, the tight packaging constraints and the severe percussive (shock) environment precluded the implementation of a sensor for closed loop feedback control of the DPM. The challenge remained to develop a drive method that did not require sensory feedback.

The DPM is driven by an open loop voltage waveform. Near the impact, the voltage waveform is set to zero so the hammer will coast just prior to and after the impact. This zero voltage zone, called the coast period, provides a tolerance to perturbations in the hammer motion cycle. This prevents the voice coil from fighting the motion of the hammer. Otherwise, the voice coil could be quite inefficient using energy and generating heat to slow down the hammer. The voltage values are defined such that the voice coil generates a prescribed force to retract (upstroke force) and extend the hammer (downstroke force). The forces are defined during a tuning procedure to create a desired percussion output: kinetic energy level just prior to the impact. A position sensor was used to determine the kinetic energy; it was removed before the installation of the DPM into the Drill top-level assembly. During tuning, the two forces are also modulated to adjust the timing of impacts such that they occur in the middle of the coast period.

For a desired impact hammer velocity and assumed rebound velocity, the motion profile of the hammer (i.e. position and velocity time history) is estimated *a priori* (Figure 8). Using a discretized motion profile, the desired actuator force,  $F_{desired}$ , the voice coil force constant,  $K_F$ , (back-emf,  $K_V$ , constant equivalently) as a function of hammer position,  $x$ , and the total roundtrip resistance of winding circuit,  $R_{total}$ , the voltage waveform is defined as follows:

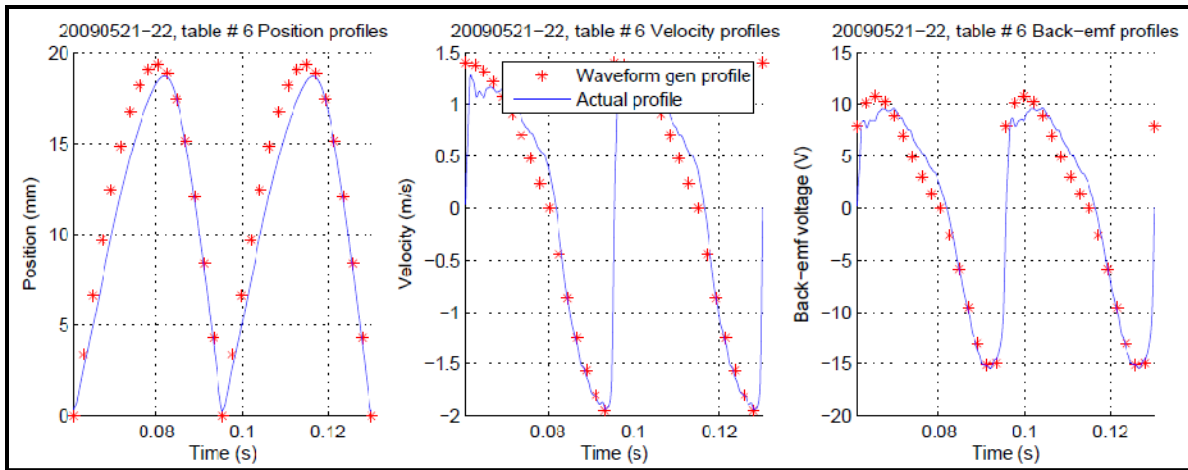
$$V = I_{desired} \times R_{total} + V_{emf}$$

$$V_k = F_{desired}/K_F(x_k) \times R_{total} + \dot{x}_k \times K_V(x_k)$$

where  $k$  is the index of the voltage table

The voice coil winding temperature, and thus resistance, will increase due to self heating during operation. The temperature of the windings is modeled onboard by the flight system software to prevent overheating and to estimate the resistance parameter for the voltage waveform. The DPM tuning process yields two tables: desired current draw and the feed-forward back-emf voltage compensation.

A project schedule constraint mandated the use of a voltage driver for the voice coil to minimize the impact to the rover avionics development. Fortunately, the voltage drive method features inherent speed regulation and a reduced sensitivity to variations of the voice coil force constant. If the velocity of the hammer is lower than expected, the voice coil will draw more current and thus output more force. This is equivalent to having a built in proportional feedback controller on hammer velocity. One source of velocity error is the variation of impact coefficient of restitution due to rock strength. In a current driver, a drop in the force constant ( $K_F$ ) would directly result in a voice coil output force. In an open loop current driver system, the known sources of  $K_F$  variation would require compensation complicating the software implementation. With the voltage drive, a decrease in  $K_F$  (and thus force generation of the actuator) is counteracted by a lowering of the back-emf voltage generated by the windings. Since the unreduced back-emf is compensated for in the voltage waveform, this “found” voltage is converted into additional current to generate more force. Some sources of  $K_F$  variation are the presence of the steel ball screw within the bore of the voice coil field assembly (which varies with Drill feed position) and voice coil magnet temperature.

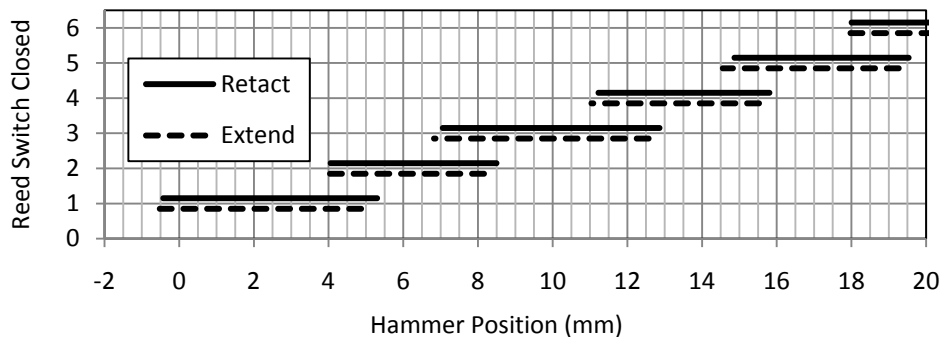


**Figure 8. Actual versus predicted hammer position, velocity and back-emf voltage**

A misunderstanding occurred during the specification of the voice coil driver when the term “tri-state” was used to describe the desired function during the coast period. This resulted in back-emf voltage induced current during the coast period which effectively dynamically braked the voice coil – dissipating kinetic energy (bad) in the form of joule heat (worse). By the time the problem was discovered, the firmware on the driver could not be changed without a major cost and schedule impact. Fortunately, a work-around was discovered: by commanding a low voltage to retract the hammer (instead of zero), the desired effect could be achieved.

Lessons learned: (1) What can appear to be clear communication across disciplines can often be quite nebulous. For example: one expression or word can have different meanings depending on the individual's interpretation. Exhaustive interaction (and often repetition – especially in high stress situations) with diagrams and simplistic explanations are the surest bet for success. (2) Sometime external project constraints can yield serendipitous outcomes as was the case with the voltage-drive method.

Lastly, mounted to the DPM housing is a series of six normally open reed switch sensors which provide coarse hammer position telemetry. The small reed switches are robust to large dynamic environments and were easily integrated into the existing rover avionics. The switches are activated by a magnet mounted to the hammer assembly. The activation regions of the adjacent switches overlap providing up to 12 position states. Figure 9 shows reed switch performance across the mechanism range of motion. These sensors provide the only direct telemetry of the hammer motion and thus are useful for operational diagnostics. These sensors are not used for feedback control. Additionally, drilling various rock types during the development test program has shown a correlation between max hammer motion and rock strength. If this carries over to the flight Drill, these sensors may also provide interesting science data about the composition of the Martian rock.



**Figure 9. Reed switch data across the DPM stroke**

### Drill Translation Mechanism

The Drill Translation Mechanism (DTM) provides the linear motion of the bit, spindle, chuck and percussion Drill subassemblies for the following functions: maintaining 120-N weight-on-bit (WOB) during sample acquisition, generating a large retraction force to extract the bit from the hole, and mating to a fresh bit in the bit box. The DTM is comprised of:

1. Aft housing assembly that forms the linear bearing rails (Figure 10).
2. A translation tube that is populated with various bearing elements (Figure 10).
3. A ball screw mechanism with an integrated force sensor (Figure 11).

The Percussion and Chuck / Spindle Sub-assemblies are installed into and integrated onto the end of the translation tube, respectively. A welded metal bellows mounted between the translation tube and the aft housing seals the internal components to protect them from Martian dirt.

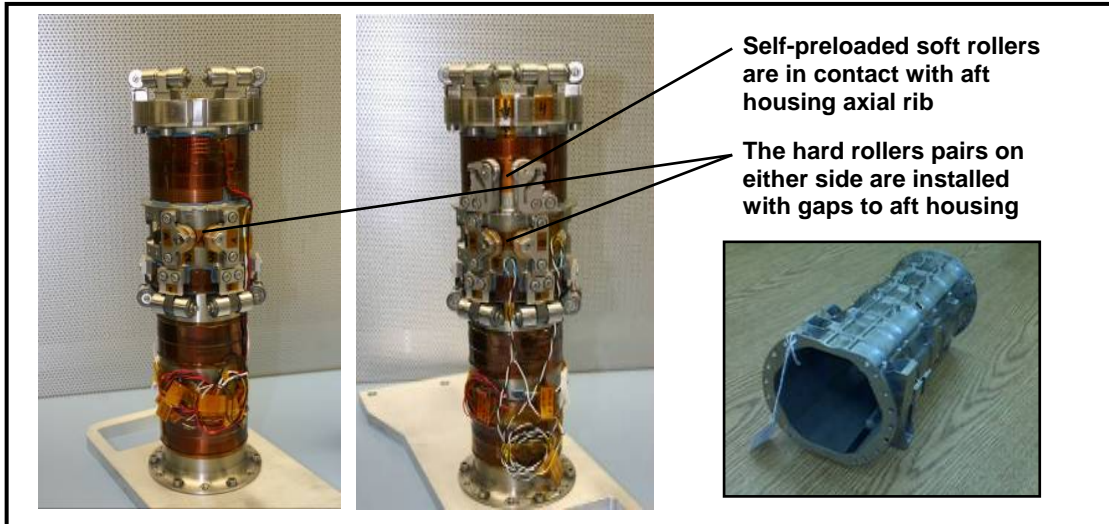
To support side and cross-moment loads, the linear bearing system uses two sets of 6 pairs of needle roller bearings mounted to the translation tube that ride on the flat internal surfaces of the aft housing. The arrangement of these bearing sets, which drives length and diameter of the Drill, was dictated by the worst-case load scenario. Torsion loads are supported by a two-stage bearing system: one set provides low axial drag and the other supports high loads. Testing across the qualification operation temperature of  $\pm 70^{\circ}\text{C}$  resulted in axial drag force less than 5 N for sample acquisition operation, thus yielding a low disturbance to the WOB measurement.

The dual bridge force sensor provides redundant measurement of the low weight-on-bit since the nominal axial load is too low to be observed in the actuator current telemetry. The inner diameter of force sensor is axially clamped to the ball nut. The force sensor outer diameter is axially constrained between two preloaded wave springs. These springs serve a few functions:

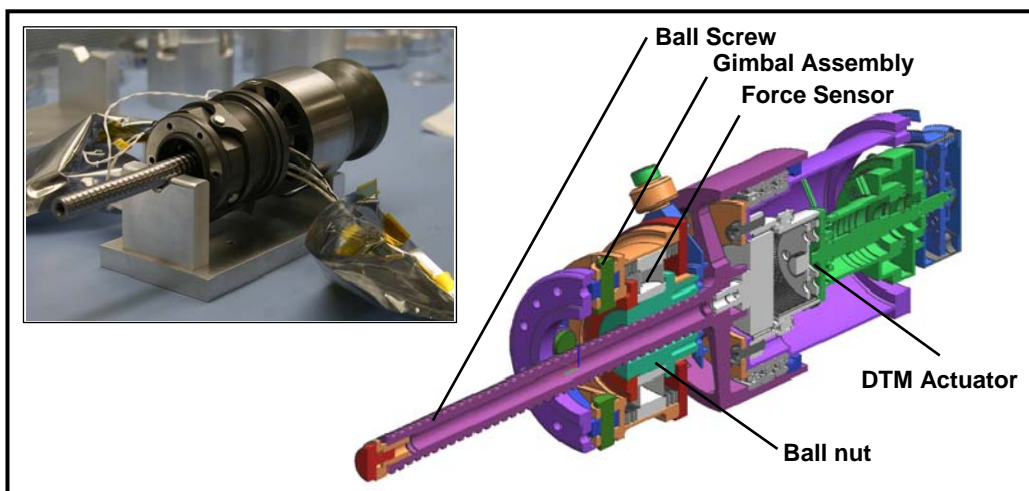
1. Provide additional compliance to lower the WOB feedback control bandwidth requirement
2. Allow the high retraction load to be shunted around the sensor.
3. Isolate the science instruments mounted to the Drill aft housing from the dynamic environment generated by the Drill.

The force sensor and wave springs are housed in a gimbal assembly which couples the translation mechanism to the translation tube. The gimbal isolates the ball screw and force sensor from radial and bending loads.

The ball screw mechanism consists of a custom ball screw supported by a high axial capacity bearing set at one end. It is actuated by an equivalent electrically-commutated gearmotor with a power-off brake as the DCM. To reduce the overall length of the Drill, the ball screw bearings also support the output of the gearmotor. This not only reduced the volume by removing a set of redundant bearings (in the actuator gearbox), but also eliminated the need for a coupling component between the gearbox and the ball screw. The ball nut torque is reacted by a flange mounted anti-rotation roller assembly. The range of the motion of the DTM in the aft direction is limited by the contact of rotation hardstop features on the nut and the screw.

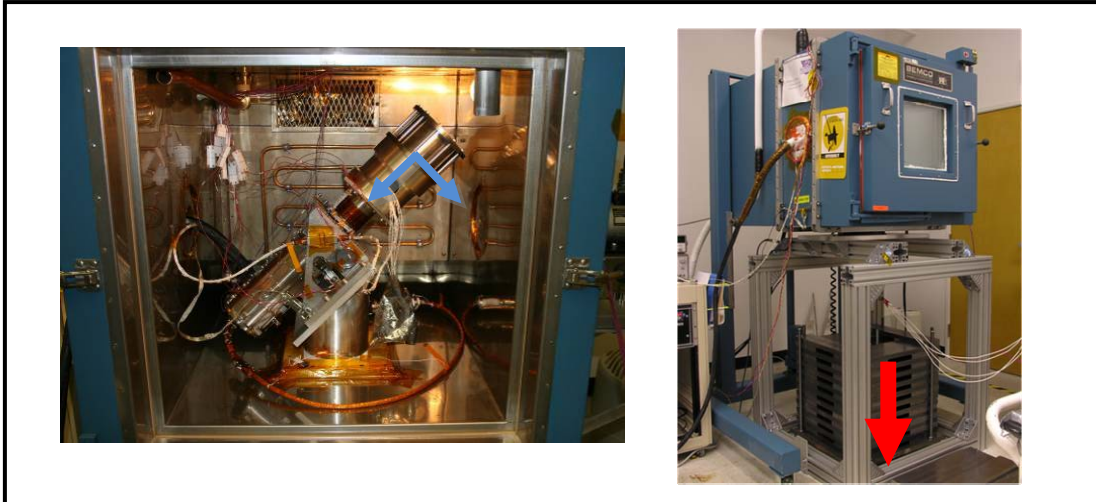


**Figure 10. Translation Tube with Rollers and Thermal Hardware  
(inset: an aft housing ready for dimensional inspection)**



**Figure 11. Ball Screw Mechanism with Integral Force Sensor**

Figure 12 shows the DTM undergoing two of its qualification tests. One test demonstrates margin against the maximum axial and side loads expected during sample acquisition. The other is a characterization of the retraction force generation capability of the DTM; the device is shown lifting 10,012 N at -70°C.



**Figure 12. Two of the DTM Qualification Tests: (left) Margin under Drilling Loads and (right) Retraction Force Capability Characterization (Lifting 10,000 N at -70°C)**

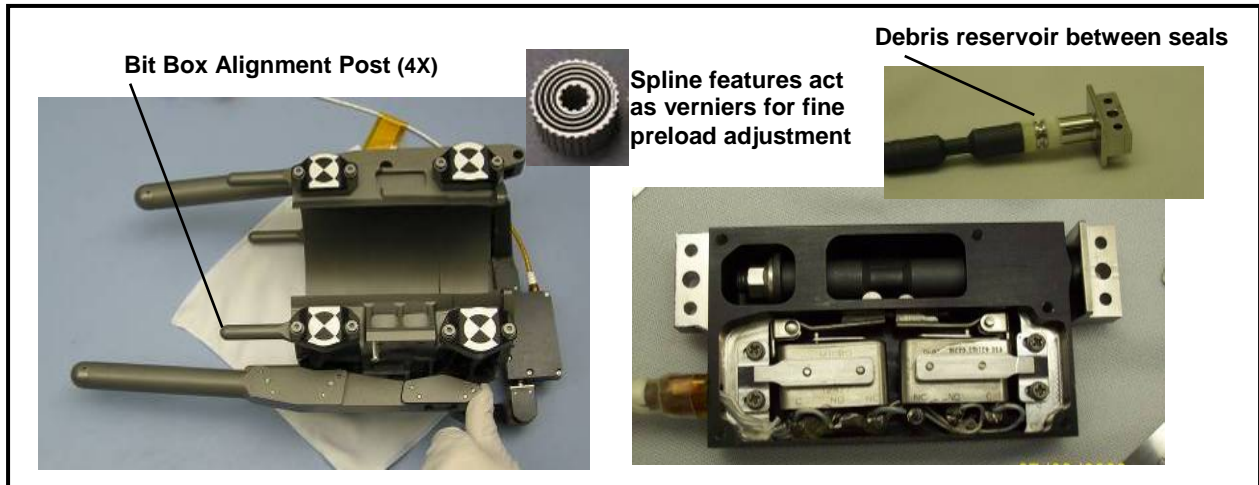
#### Drill Contact Sensor / Stabilizer

The Drill Contact Sensor / Stabilizer (DCSS) is a passive mechanism that indicates the placement of the Drill on a target rock (Figure 13). The articulating two point-contact design of the DCSS accommodates a combination of target surface height variations between the contact points and Drill axis misalignment to the surface normal. The DCSS will indicate contact if and only if both prong tips are in contact with the target. Once preloaded to the target by the Robotic Arm, the DCSS stabilizes the Drill by locking out 4 degrees-of-freedom (3 translational DOFs and a rotational DOF about the bit axis) between the Drill and the target. This device is conceptually similar to the contact sensor implemented on the Mars Exploration Rover for the Rock Abrasion Tool [3]. The DCSS consists of two counter articulating spring-loaded 4-bar linkages interconnected by a coupler assembly. The coupler assembly consists of a piston with cam surfaces that actuate two micro switches. The two prongs of the DCSS and the Drill forward housing structure make up the coupler links and ground link, respectively. The total linkage is centered by counter-acting clock springs mounted in the aft links' lower joint assembly. These springs also reset the coupler piston thus eliminating the need for a return spring within the coupler sub-assembly. The springs are machined (rather than hand wound) to ensure there is no coil rubbing which would add undesired friction. They also have spline features on the inner and outer diameter that allow fine adjustment of the spring preload.

A low and consistent switch trigger force will yield more reliable preloading by the robotic arm. This presents a conflicting requirement for the DCSS: the return spring force should be high enough to ensure the release of the switches but not so large as to drive the trigger force above 40 N. The solution was to seal the moving elements: including all rotary joints and the piston of the coupler with felt seals. This would ensure that the Martian dirt would not foul up the device and keep its performance consistent. The return springs were then preloaded to ensure sufficient margin to un-trigger the contact switches against the total measured friction in the assembly.

Another design challenge for DCSS was structural capacity. One of the drivers was, once again, the worst-case load scenario: the rover can hang off one prong on a 20 degrees Martian zero-friction slope. However, the biggest driver was the Translation Mechanism retraction force which is reacted back to the rock by the DCSS. The loads in the links of the four-bar can get quite severe especially when the DCSS is in its fully articulated configuration. This is compounded with the tight packaging constraints of the turret (Figure 1b); the DCSS is the closest neighbor to the DRT and CHIMRA. Through the use of high strength materials, spherical bearings at each joint, and clever link geometry the device meets the load

requirement with positive margin. Lastly, integrated onto the housings of the DCSS forward joints are four alignment posts that enable the Drill to dock with the bit box.



**Figure 13. (a) Drill Contact Sensor / Stabilizer Assembly at full articulation (inset: Return Spring) (b) Compressed DCSS Coupler w/o Cover (inset: Coupler Piston with Seals)**

### Conclusion

At the time of writing this paper the Qualification Model and Flight Model Drill mechanism subassemblies are being tested across the qualification operating temperature range (-70°C to +70°C for most components, colder for the DPM, DCSS and DBA). The Engineering Model (EM) Drill assembly has been functionally tested at ambient conditions and integrated at the next higher level of assembly – onto the Robotic Arm as part of the Turret. There it was subjected to a sub-system level test to characterize the self-generated dynamic environment used for sample flow within the Drill and CHIMRA. Over the next few months, the EM Drill will be mounted to another manipulator to undergo abbreviated drilling and sample transfer testing at low pressure.

### Acknowledgements

The work described in this paper was performed by the Jet Propulsion Laboratory, California Institute of Technology, under contract with the National Aeronautics and Space Administration.

Developing the Drill and producing it for flight is an enormous undertaking that relies on personal dedication and sacrifice. This author has been blessed with a fantastic team of hardware engineers who have worked tirelessly for years to reach this point: Kyle Brown (Chuck, Spindle and Bit), Ian Cady (Percussion), Matt Haberland (Contact Sensor / Stabilizer), Kerry Klein (Translation Mechanism), Kristo Kriechbaum (Percussion), Justin Lin (Chuck, Spindle and Bit) and Paul McGrath (Translation Mechanism). Jack Aldrich, Mark Balzer, Richard Barela, John Bousman, Kevin Burke, Louise Jandura, Mike Johnson, Brett Kennedy, David Levine, Joe Melko, Suparna Mukherjee, Matt Orzewalla, Frank Ramirez, Dave Putnam, Don Sevilla, Lori Shiraishi, Jeff Umland, Robert Uyeda, Max Von Der Heydt and Chris Voorhees have also contributed to the Drill development.

## References

1. Jandura, Louise. "Mars Science Laboratory Sample Acquisition, Sample Processing and Handling: Subsystem Design and Test Challenges." *Proceedings of the 40<sup>th</sup> Aerospace Mechanisms Symposium*, (May 2010).
2. Sunshine, Dan. "Mars Science Laboratory CHIMRA: A Device for Processing Powdered Martian Samples." *Proceedings of the 40th Aerospace Mechanisms Symposium*, (May 2010).
3. Myrick, Thomas, Davis, Kiel and Wilson, Jack "Rock Abrasion Tool." *Proceedings of the 37<sup>th</sup> Aerospace Mechanisms Symposium*, (May 2004).