

NASA/TM—2013-217872



Validation of Helicopter Gear Condition Indicators Using Seeded Fault Tests

Paula Dempsey
Glenn Research Center, Cleveland, Ohio

E. Bruce Brandon
U.S. Army, Redstone Arsenal, Huntsville, Alabama

NASA STI Program . . . in Profile

Since its founding, NASA has been dedicated to the advancement of aeronautics and space science. The NASA Scientific and Technical Information (STI) program plays a key part in helping NASA maintain this important role.

The NASA STI Program operates under the auspices of the Agency Chief Information Officer. It collects, organizes, provides for archiving, and disseminates NASA's STI. The NASA STI program provides access to the NASA Aeronautics and Space Database and its public interface, the NASA Technical Reports Server, thus providing one of the largest collections of aeronautical and space science STI in the world. Results are published in both non-NASA channels and by NASA in the NASA STI Report Series, which includes the following report types:

- **TECHNICAL PUBLICATION.** Reports of completed research or a major significant phase of research that present the results of NASA programs and include extensive data or theoretical analysis. Includes compilations of significant scientific and technical data and information deemed to be of continuing reference value. NASA counterpart of peer-reviewed formal professional papers but has less stringent limitations on manuscript length and extent of graphic presentations.
- **TECHNICAL MEMORANDUM.** Scientific and technical findings that are preliminary or of specialized interest, e.g., quick release reports, working papers, and bibliographies that contain minimal annotation. Does not contain extensive analysis.
- **CONTRACTOR REPORT.** Scientific and technical findings by NASA-sponsored contractors and grantees.

- **CONFERENCE PUBLICATION.** Collected papers from scientific and technical conferences, symposia, seminars, or other meetings sponsored or cosponsored by NASA.
- **SPECIAL PUBLICATION.** Scientific, technical, or historical information from NASA programs, projects, and missions, often concerned with subjects having substantial public interest.
- **TECHNICAL TRANSLATION.** English-language translations of foreign scientific and technical material pertinent to NASA's mission.

Specialized services also include creating custom thesauri, building customized databases, organizing and publishing research results.

For more information about the NASA STI program, see the following:

- Access the NASA STI program home page at <http://www.sti.nasa.gov>
- E-mail your question to help@sti.nasa.gov
- Fax your question to the NASA STI Information Desk at 443-757-5803
- Phone the NASA STI Information Desk at 443-757-5802
- Write to:
STI Information Desk
NASA Center for AeroSpace Information
7115 Standard Drive
Hanover, MD 21076-1320



Validation of Helicopter Gear Condition Indicators Using Seeded Fault Tests

Paula Dempsey
Glenn Research Center, Cleveland, Ohio

E. Bruce Brandon
U.S. Army, Redstone Arsenal, Huntsville, Alabama

Prepared for the
Joint Machinery Failure Prevention Technology (MFPT) 2013 and 59th International
Instrumentation Symposium (IIS)
sponsored by the Society for Machinery Failure Prevention Technology and the International
Society of Automation
Cleveland, Ohio, May 13–17, 2013

National Aeronautics and
Space Administration

Glenn Research Center
Cleveland, Ohio 44135

Acknowledgments

The authors would like to thank the NASA Rotary Wing Project, the U.S. Army Apache PM and AMCOM G-3 CBM office located at Redstone Arsenal, and Traci Stadtmueller of the FAA Technical Center for their assistance and support of this work.

Level of Review: This material has been technically reviewed by technical management.

Available from

NASA Center for Aerospace Information
7115 Standard Drive
Hanover, MD 21076-1320

National Technical Information Service
5301 Shawnee Road
Alexandria, VA 22312

Available electronically at <http://www.sti.nasa.gov>

Validation of Helicopter Gear Condition Indicators Using Seeded Fault Tests

Paula Dempsey
National Aeronautics and Space Administration
Glenn Research Center
Cleveland, Ohio 44135

E. Bruce Brandon
U.S. Army
Redstone Arsenal, Alabama 35898

Abstract

A “seeded fault test,” in support of a rotorcraft condition based maintenance program (CBM), is an experiment in which a component is tested with a known fault while health monitoring data is collected. These tests are performed at operating conditions comparable to operating conditions the component would be exposed to while installed on the aircraft. Performance of seeded fault tests is one method used to provide evidence that a Health Usage Monitoring System (HUMS) can replace current maintenance practices required for aircraft airworthiness. Actual in-service experience of the HUMS detecting a component fault is another validation method. This paper will discuss a hybrid validation approach that combines in service-data with seeded fault tests. For this approach, existing in-service HUMS flight data from a naturally occurring component fault will be used to define a component seeded fault test. An example, using spiral bevel gears as the targeted component, will be presented. Since the U.S. Army has begun to develop standards for using seeded fault tests for HUMS validation, the hybrid approach will be mapped to the steps defined within their Aeronautical Design Standard Handbook for CBM. This paper will step through their defined processes, and identify additional steps that may be required when using component test rig fault tests to demonstrate helicopter CI performance. The discussion within this paper will provide the reader with a better appreciation for the challenges faced when defining a seeded fault test for HUMS validation.

Acronyms

AC	Advisory Circular
ADS	Aeronautical Design Standard
AGMA	American Gear Manufacturers Association
CAP	Civil Aviation Authority
CBM	Condition Based Maintenance (CBM)
CI	Condition Indicator
CR	Combat Readiness
DAQ	Data Acquisition System
FAA	Federal Aviation Administration
FMECA	Failure Mode Effects and Criticality Analysis
FRF	Frequency Response Function

HDBK	Handbook
HUMS	Health Usage Monitoring Systems
MDSS	Mechanisms Diagnostic System Software
MSPU	Modern Signal Processing Unit
NGB	Nose Gear Box
OEM	Original Equipment Manufacturer
SC	Safety Center
SI	Condition Indicator: Sideband Index
UK	United Kingdom
TDA	Tear-Down Analysis
VHM	Vibration Health Monitoring

Background

Helicopter transmission integrity is important to helicopter safety because helicopters depend on the power train for transmission of torque required for lift and flight maneuvering. Health Usage Monitoring Systems (HUMS) capable of predicting impending transmission component failure for “on-condition” maintenance have the potential to decrease operating and maintenance costs and increase safety and aircraft availability. HUMS can also be utilized to augment or reduce aircraft maintenance through the use of automated monitoring to extend the time between maintenance intervals. This is often employed even when the transmission contains life limited components. Within the context of this paper, on-condition means to replace time-based maintenance intervals with planned maintenance when HUMS “condition indicators” (CI) indicate decreased performance. These HUMS condition indicators are typically vibration signatures or trends that develop when a fault occurs on a component that affects the operation of the transmission or overall life of the components therein. A CI must be correlated to a known failure mode that could lead to a failure mode within the transmission to reliably reflect the health of the system.

Civilian rotorcraft manufacturers are requesting “maintenance credits” from the Federal Aviation Administration (FAA) for installation of HUMS on their aircraft. Maintenance credits are modified inspection and removal criteria of components based on HUMS measured condition and actual usage. FAA published Advisory Circular (AC) 29-2C, Section MG-15, Airworthiness Approval of Rotorcraft (HUMS), to provide guidance for achieving airworthiness approval for credit validation for a full range of HUMS applications (Ref. 1). Credit validation includes evidence of effectiveness for the developed algorithms that includes acceptance limits, trend setting data, tests and the demonstration methods employed, knowledge of the failure mode and damage progression rate. These methods can include using data from naturally occurring aircraft faults, components with seeded faults on an operational helicopter, and component seeded fault testing on a test stand (Ref. 2). Due to time, cost and safety concerns, direct evidence via actual service on aircraft is typically replaced with rig tests where a measurable and known component fault is checked against the CI and its thresholds. Component faults can also be allowed to progress to ascertain the level of damage and the damage progression rate.

The Civil Aviation Authority (CAA) published another document, CAP 753, to provide guidance for U.K. operators using vibration health monitoring (VHM), defined as “data generated by processing vibration signals to detect incipient failures or degradation of mechanical integrity,” for helicopter rotor and drive systems (Ref. 3). Within this document, seeded fault testing is also mentioned as a validation method to demonstrate damage detection effectiveness for specific faults.

CIs can perform differently when taken from a component test stand or even a full-scale transmission test stand and implemented on an aircraft. One study evaluated CI data collected from faulted oil cooler bearings of two UH-60 Black Hawk helicopters. The faulted data was compared to CI data from ten helicopters with no bearing faults removed from fielded helicopters and installed in a test stand (Ref. 4). Results indicated the bearing CI measured on the helicopter and in the test stand responded differently to the damaged bearings. If data collected from a test rig is to be used to validate CI performance it must be shown that its performance can be maintained when installed on the aircraft. A methodology must be defined that verifies CI test stand performance can be maintained at a comparable level when monitored on the aircraft. Due to differences in both systems and their operational environments, response of a CI to a fault in a test stand may not be representative of a CI response in a helicopter. For these situations, CI performance limitations must be defined to understand the risks in using a test rig validated CI on a helicopter.

Objectives and Approach

The objective of this paper is to present a CI performance validation method that combines in-service data from helicopters with faulted spiral bevel gears from the field with seeded fault tests on spiral bevel gears. For this approach, existing in-service HUMS flight data from naturally occurring faults will be used to define the requirements for spiral bevel gear seeded fault tests. Spiral bevel gear sets were the components targeted for this analysis based on the availability of fleet flight data, tear down analyses, operational data and maintenance records. Gear CI data from AH64 nose gearboxes, on wing, when damaged occurred on the spiral bevel gears will be used to define seeded fault tests in a spiral bevel gear fatigue rig that enables comparison of CI performance in both datasets (Ref. 6). The tested gears were designed with comparable material, heat treatments and tooth contact loads as the helicopter gears.

Using spiral bevel gears as an example, the hybrid approach will be mapped to standards for using seeded fault tests for HUMS validation presented in the U.S. Army Aeronautical Design Standard (ADS) Handbook (HDBK) for CBM (Ref. 5). This paper will step through processes defined within the handbook and identify additional steps that will be required when using component test rig fault tests to demonstrate helicopter CI performance. This hybrid approach will be used to better understand at what level does the system need to be designed to validate CI performance and in the future answer questions such as (1) What can we scale? (2) What can we simulate? (3) What can we quantify? and (4) How simple or complex do seeded faults need to be for CI validation?

U.S. Army Seeded Fault Testing

The U.S. Army uses test rig component tests for verification, CI maturation, and validation of CIs prior to their use on helicopters. This is due to the time and expense required obtaining statistically significant sets of failure progression data in a full-scale helicopter gearbox and the limited aircraft data available on damaged components. Appendix J, titled Seeded Fault Testing, of ADS-79 HDBK outlines the Army's process for defining seeded fault testing to verify, mature, and validate condition indicators (CIs) (Ref. 5). Seeded fault, within the handbook, refers to initiating a known fault into a component to accelerate damage while monitoring its progression. Test operational conditions can also be used to initiate and accelerate naturally occurring faults.

Within Appendix J, the Army provides a flowchart that outlines their process for seeded fault testing to transition to the aircraft, as shown in Figure 1. The process starts with a request from the appropriate Program Management (PM) Office concerning a component or assembly that is affecting either aircraft maintenance cost or availability. The component maintenance data and accident data is queried and reviewed as well as current CI performance. If limited naturally occurring field failures with supporting CI data and teardown analysis are available, a logical path to mature the CI is developed using seeded fault testing. This data in turn can later be used for CI validation after the maturation process has been completed.

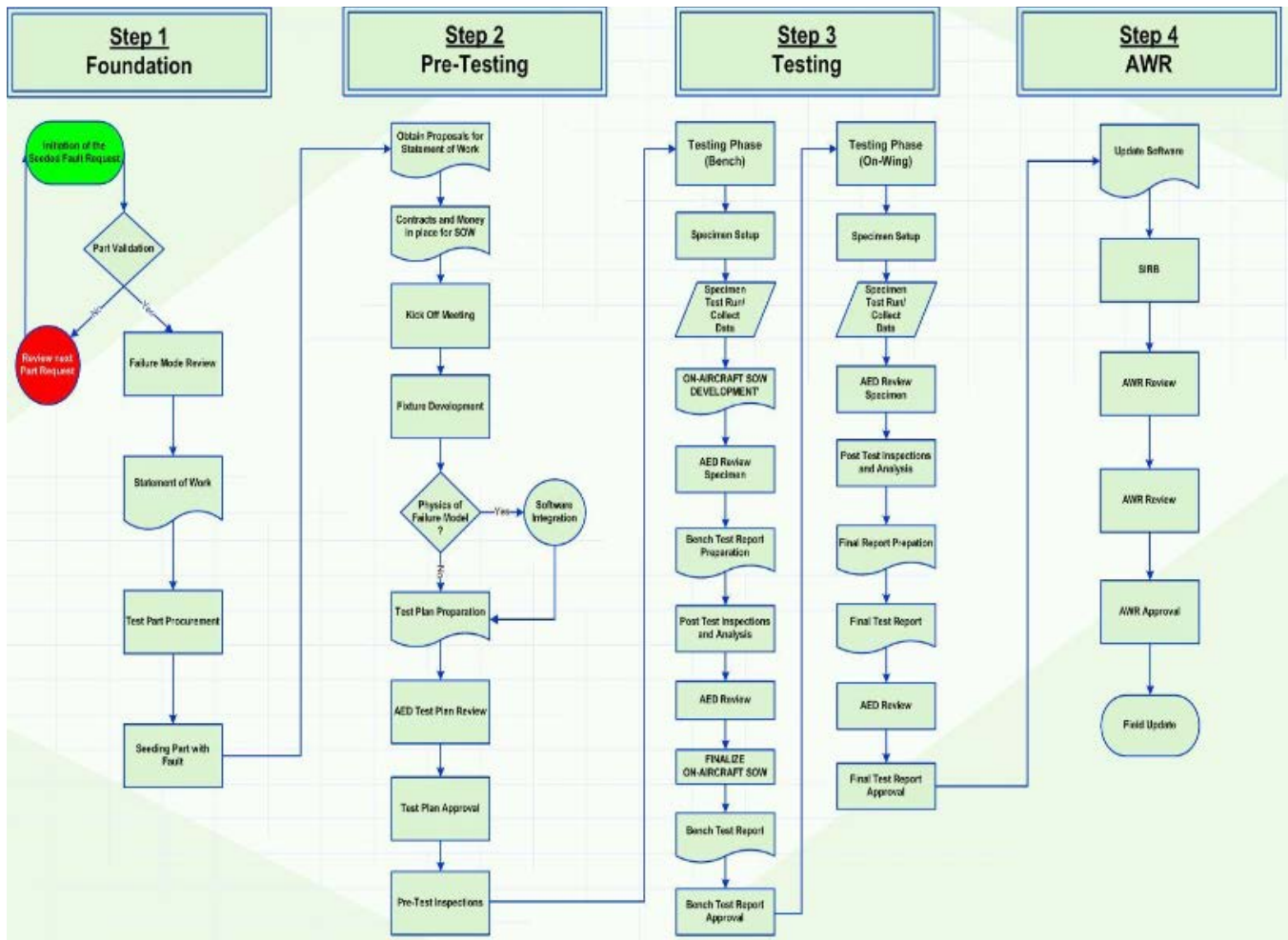

Figure 1.—Seeded fault testing flowchart (Ref. 5).

Measurements from a component in a test rig with a known faulted condition can be used to improve CI and CI threshold values for achieving an acceptable tradeoff between the probabilities of false positives/false alarms and false negatives/missed detections indications in the field units. The ADS for CBM contains the Army’s acceptable probability of detection and their acceptable false alarm rates. It is important to consider these percentage levels for each aircraft systems or subsystem with respect to the criticality of the system and its impact to airworthiness. The test rig results may confirm specific failure modes and fault conditions are detectable by currently measured indicators. Rig testing data can be compared to aircraft data and be used to determine if component fault signatures and the detection by CIs are sensitive to operating environments.

Equally important is the tailoring of the approach to meet the specific testing goals. For CI verification, testing should answer the following: Does the infant condition indicator react in the manner it is intended? This is typically done using short duration tests with minimal test articles. Once the CI is verified it can be transitioned to the field to monitor and gain additional field finds. After the CI has shown promise in returning an alert to an acceptable level of confidence, the CI will then be transitioned to a maturation process that will further refine the alert threshold. This takes the thresholding from statistically set thresholds to thresholds that directly correlate to a level of component degradation, normally the longest and most tedious step in advancing the CI. The CI and applicable thresholds will then be transitioned to the aircraft to gain additional field data.

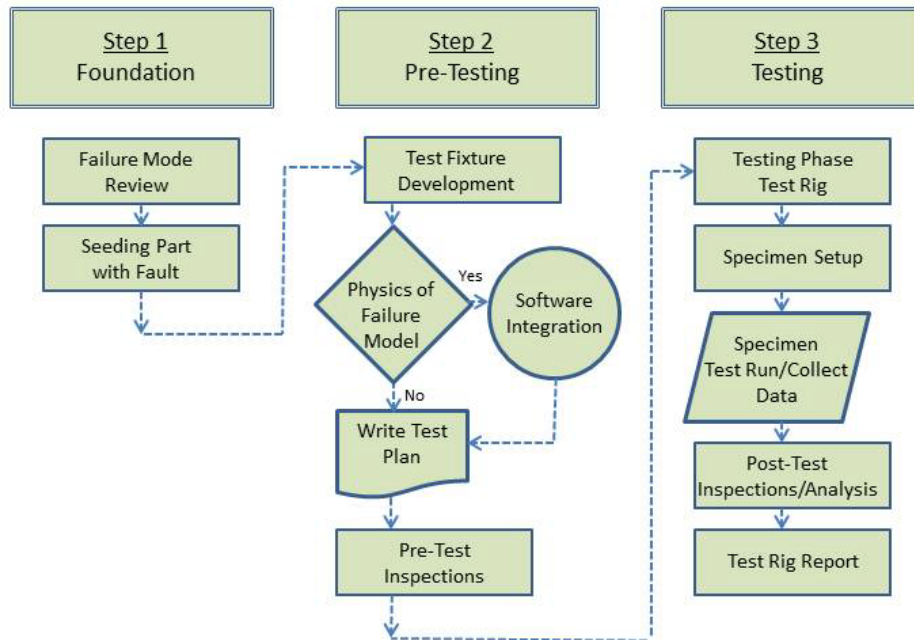

Figure 2.—Seeded fault testing technical requirements flowchart.

When an exceedance is detected it is critical to capture the component or sub-assembly for a Tear Down Analysis (TDA) to confirm or further correlate a CI value to a component condition. The TDA is used to provide the ground-truth data that is used to support the refinement of thresholds. After the CI determines the health with high confidence, the case will then be made to either utilize the data to pursue a time extension (modified maintenance) or to pursue on-condition status (replacement of maintenance).

For our hybrid approach, the process for using historical field data as the foundation to validate future CIs with seeded fault tests will be outlined in the following sections of this paper. For this approach, the field data and TDAs will be used to design the experiment. The process will focus on steps 1 through 3 and the corresponding technical requirements in Figure 1. Management oversight will not be discussed. A summarized flowchart of the steps to be discussed is illustrated in Figure 2.

Step 1: Foundation

The first step when defining a seeded fault test for CI performance evaluation is to define the objectives and goals of the tests. For these tests, the main objective is to re-create field failure modes by accelerating failure mechanisms in a test rig to evaluate the performance of the CI. Refer to Figure 3 as an example for the Foundation step discussion.

For the test, a singular CI will be targeted based on the analysis of its performance in the field. Should adequate field performance data from a singular CI not be present, multiple CIs can be targeted for evaluation in test. Clear expectations will be set for the criteria to down select these CIs based on their sensitivity and detection of this one failure mode. Appendix D of the ADS-79 HDBK details the Army's criteria to evaluate CIs for use. A CI will be selected based on its accuracy, detectability, identifiability, and separability (Ref. 5). The characteristics of these attributes as presented in Reference 5 are:

- Accuracy.—The proportion of all healthy and faulted components which were diagnosed correctly. Accuracy represents the most fundamental metric of an algorithm's performance.
- Detectability.—The extent to which a diagnostic measure is sensitive to the presence of a particular fault. Detectability should relate the smallest fault signature that can be identified at the prescribed false positive rate.

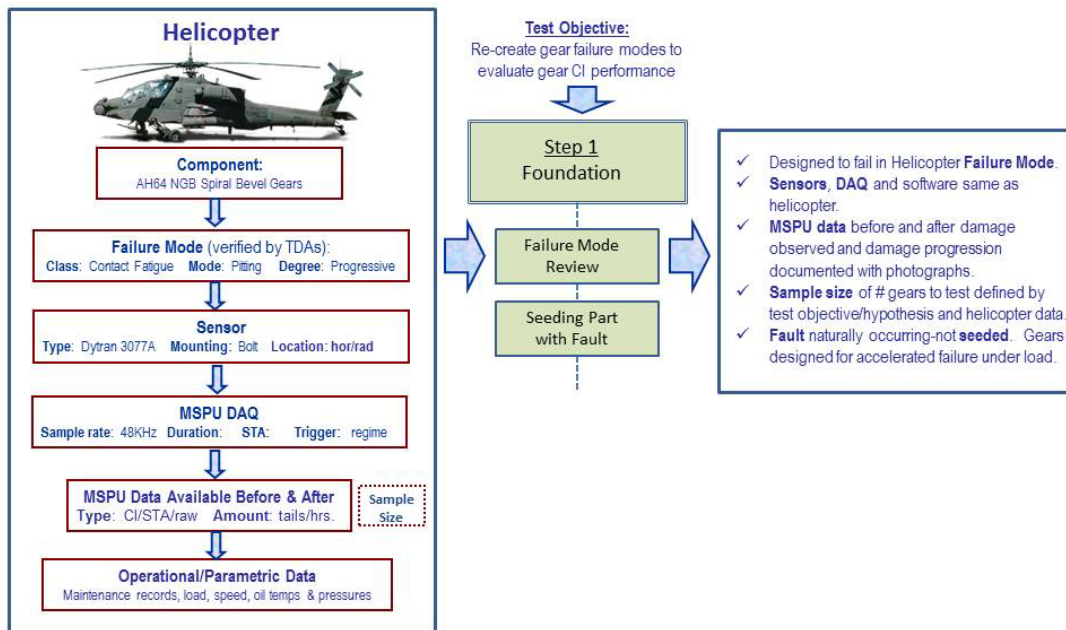

Figure 3.—Step 1: Foundation.



Figure 4.—Spiral bevel gears.

- **Identifiability.**—The extent to which a diagnostic measure distinguishes one fault from another that may have similar properties.
- **Separability.**—The extent to which a diagnostic measure discriminates between faulted and healthy populations.

The component under investigation is the spiral bevel gear set in the nose gearbox of the Apache helicopter. A photograph of a spiral bevel gear set is shown in Figure 4. The failure mode was verified by the tear down analysis (TDA) documentation of the gear and pinion teeth damage. American Gear Manufacturers Association (AGMA) standards that document gear wear terminology will be used as a reference (Ref. 7). Correlating these types of failures and terminology to the TDAs is another step that will be added within the process. Using common descriptive terms to define damage will aid in the standardization process. This was done for this component by taking a closer look at the TDAs and relating them to gear damage and is documented in Reference 8. The failure mode for this study was separated into class (contact fatigue), general mode (macro pitting) and degree (progressive). An example of this type of failure mode on spiral bevel gears is shown in Figure 5. In addition to the photographs, a scaling factor for class and mode (4.3, macropitting) for the damage is also shown.

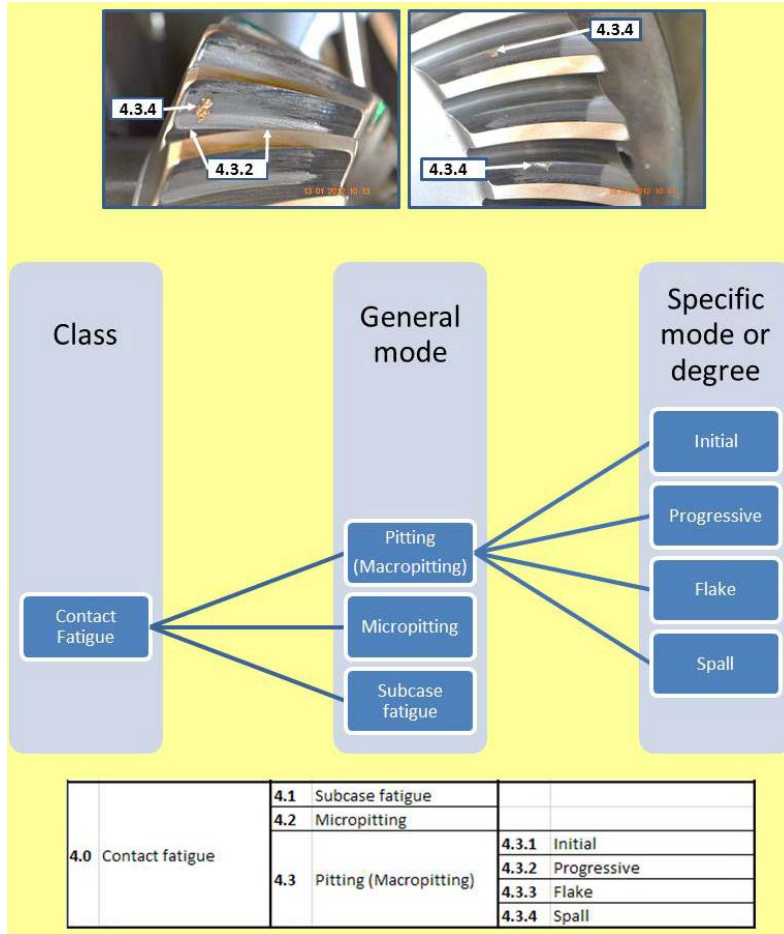

Figure 5.—Example of progressive pitting.

Once a component is targeted, the specific failure mode will be selected and reviewed. Review of the failure mode will include analysis of information pertaining to the component's known or anticipated fault mechanisms leading to failure modes. For the Army, this information includes the OEM's Failure Mode Effects and Criticality Analysis (FMECA), maintenance records of reported failures (DA Form 2410), Combat Readiness/Safety Center accident results (CR/SC), tear down analyses (TDAs) and visual inspection of removed components.

Since the objective of this seeded fault test is to evaluate gear CI performance, available helicopter CI data and the sensor, data acquisition system (DAQ), and the amount and type of operational conditions in which it was collected are also important to the analysis. Use of a similarly configured system in the test rig will reduce these variables when comparing the data generated by the rig tests. While it is always best to utilize the same system as the aircraft employs, properly configured DAQ's can provide a lower cost and higher fidelity in the information gathering. Additionally, modern DAQ's allow for additional file formats for further data analysis.

For these tests, a flaw or fault will not be directly seeded into the gear set but the gear set will be subjected to increased loading as to ensure an expected failure. The gear set will be tested in a manner that will accelerate fatigue failure within a reasonable test timeframe per the gear design and rig operating conditions.

Defining the sample size for both the validation of CI field performance and determining the number of samples to test is an important step in the process. A method to determine the number of faulted components for this application required for validation and to define an acceptable level of components with true positives (detections) versus false positives (false alarms) is detailed in Reference 11. The

approach for this example applies statistical analyses to a focused problem statement: “Does the gear CI, sideband index, respond to the failure mode, pitting on pinion and gear teeth?” The hypothesis to determine if the CI values for the “damaged” component are significantly different than the CI values of an “undamaged” component was tested by applying a test statistic to the field data. It was determined that the CI values for the damage and no damage data sets differ significantly. Once the performance of the CI selected was verified, the minimum sample size to test was determined by setting the test statistic equal to the critical test statistic values. A minimum sample size using the data from the helicopters was calculated to be nine (see Ref. 11) to establish whether or not the requisite confidence level was achieved. Once nine tests are completed in the test rig, the data will be used to verify the CIs generated also show significant differences between damaged and undamaged components.

Operational conditions on the helicopter for the spiral bevel gears such as torque, speed and temperatures for the helicopters is also important to verify comparable conditions will be maintained in the test rig. Typically, within an aircraft, the HUMS data are acquired, stored, tracked, trended and monitored separately from the operational data (Ref. 5). For this analysis, key operational parameters such as torque, speed, oil temperatures and pressures, on the helicopters were provided.

Step 2: Pre-Testing

The pre-testing step describes the development of a test rig, physics of failure model, test plan and pre-test inspections for seeded fault testing of the component. Refer to Figure 6 for the Pre-Testing step discussion.

For these tests, an existing spiral bevel test rig, the Spiral Bevel Gear Test Rig at NASA Glenn Research Center, will be used. The test rig is illustrated in Figure 7. Two sets of spiral bevel gears are installed in the test rig and tested simultaneously. A detailed analysis of this test facility and its capabilities can be found in References 9 and 10.

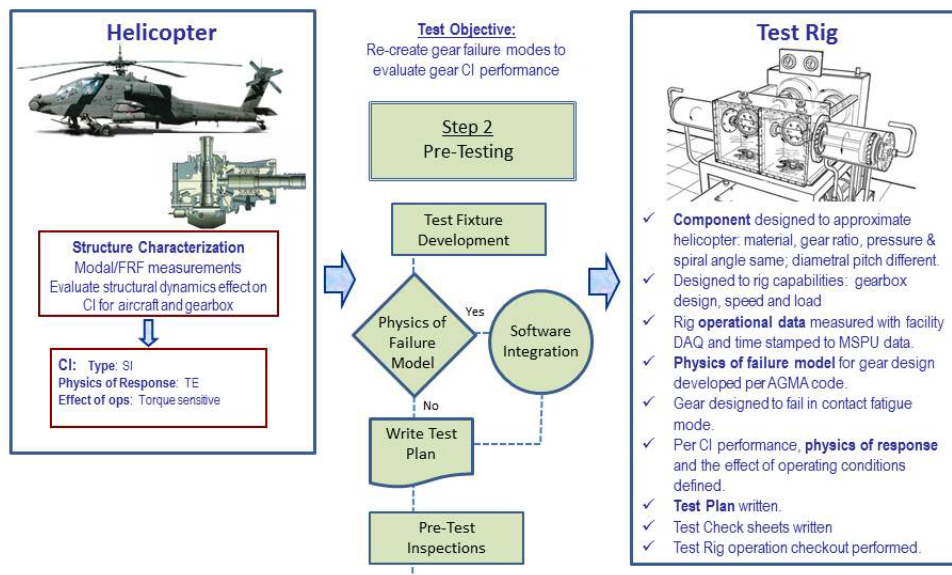

Figure 6.—Step 2: Pre-testing.

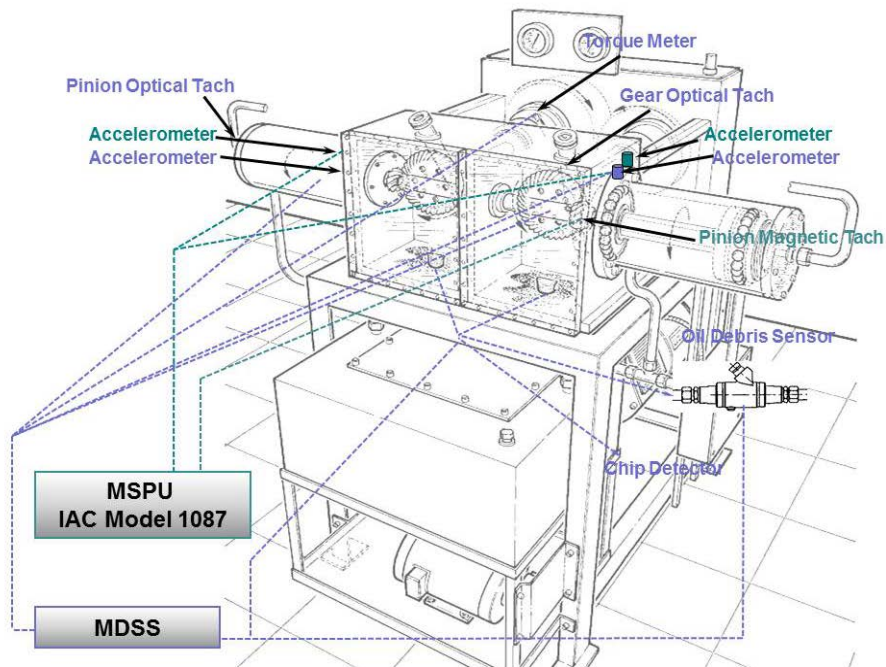

Figure 7.—Spiral bevel gear fatigue rig.

A total of 46 gear sets (pinion/gear) will be tested in the rig at four test conditions. The sample size to test was determined from a hypothesis and test statistic based on the helicopter data set per the discussion in the preceding section (Ref. 11). A method to determine the number of samples to test should also be added as a step in the process. Gear vibration and speed data will be recorded and processed with an AH64 Modern Signal Processing Unit (MSPU) HUMS with the same software, sensors, and DAQ used to collect helicopter CI data. Gear vibration, oil debris, torque and speed data will also be recorded and processed with the NASA Glenn research data acquisition system, Mechanisms Diagnostic System Software (MDSS). In addition, a facility data acquisition system will be used to monitor the operational conditions of the test rig such as torque, speed, oil temperatures and pressures. This system enables safe, automated, unattended operation required to obtain enough cycles to failure of the gears in a reasonable amount of time.

The production AH64 gear design could not be directly adapted into the test rig due to the size of the gear set, the speed in which it runs and the test stand loading capacity. In some cases, a rig is built around the actual helicopter component to test. The cost of a new rig, 46 AH64 gear sets and time required to initiate fatigue failures in the gear sets made this approach unfeasible. For this reason, the helicopter OEM was tasked to evaluate a gear set design that could be used in the test rig with close approximation/simulation to the helicopter gear set. The following requirements needed to be met in the design of the gears:

- (1) The gear set design was constrained to the space available in the spiral bevel gear fatigue rig gearboxes within its speed and load limitations.
- (2) The gear sets were designed to fail in a manner comparable to the failure modes observed on the helicopters. This required review of the tear down analysis (TDAs) available from the field units and on-site inspection of several of the gearboxes.
- (3) The gear sets were designed to insure fatigue failures to limit overall test time.

A model was developed using AGMA software (Ref. 12) that identified the physics of failure based on the gear design and operating conditions. The program uses design information that includes speeds, torques, gear materials, heat treatments, lubricants, operating temperatures and reliability to determine contact stress indices and margins of safety. The final design was selected with the highest probability of failure in a pitting mode within 100 hr of operation at test rig speed and load conditions, while avoiding bending fatigue failures. For the final test rig gear set design, the helicopter gear design material, gear ratio, pressure and spiral angle and contact stress were maintained while the diametral pitch was different.

Once the failure mode is defined and deemed achievable in the test rig through modeling, the extent of failure to test the gears must be clearly defined. A component failure level (see Ref. 5) is defined as: (1) when a component cannot perform its intended function (2) cannot operate safely in the test rig, or (3) the level of damage has reached a detectable level. For these tests, a failure is defined as progressive macro pitting (Fig. 5, 4.3.2), occurring on a minimum of 2 gear or pinion teeth. In addition, the test rig will be shut down at periodic intervals throughout the test and photographs of the gear and pinion teeth will be taken to document damage progression. Figure 8 provides an example of the damage progression photos on five pinion teeth. This testing will focus on the damage tolerant approach to component lifing as opposed to the safe life approach. Damage tolerant structures (see Ref. 13) include components with slow damage progression where the damage is detectable within a certain size and can perform its intended function with the level of detectable damage. Per the definitions listed in Table 1 the component failure will be limited to the yellow level in the test rig.

A test plan was generated that documents test objectives, rig capabilities, test gear design, sample size selection, MDSS DAQ set-up and instrumentation, MSPU DAQ setup and instrumentation, test facility DAQ set-up and instrumentation and test procedures specific for gear test conditions. The test plan includes procedures for pre-test, gear run-in, inspection intervals, post-test and research test conditions.

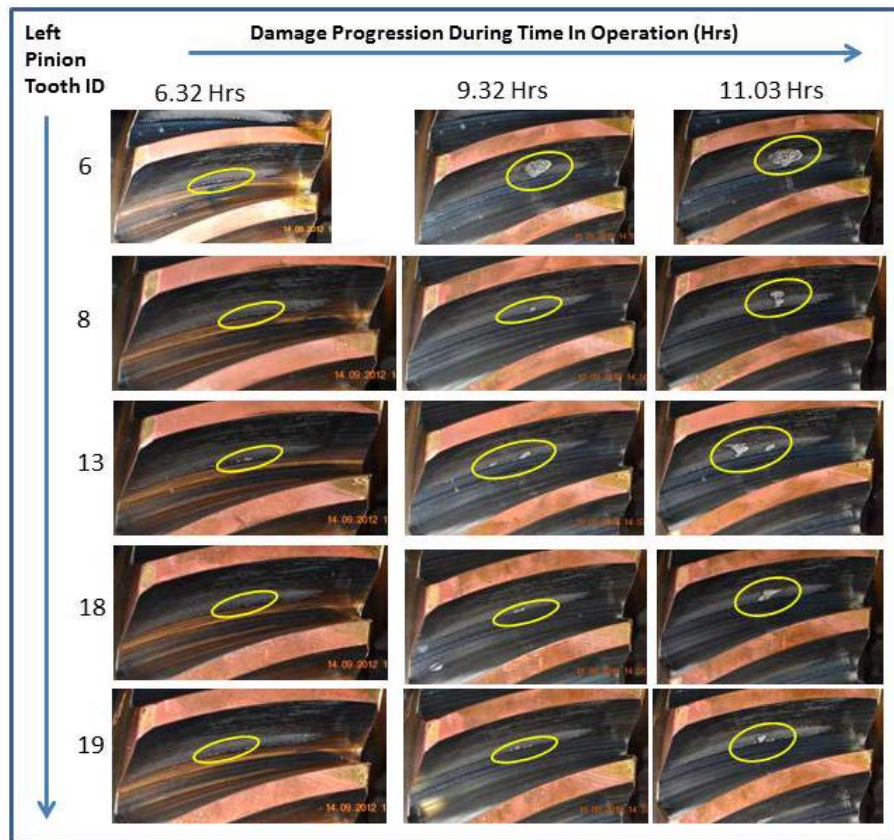

Figure 8.—Damage progression photos on five pinion teeth.

TABLE 1.—COLOR CODES FOR DAMAGE LEVELS (REFS. 5 AND 14)

Color Code	Operational Capability	Maintenance Action Required	Time Horizon for Maintenance	Impact to Components	Color Determination
	Fully Functional	No Maintenance Required	Form 2410 Remaining Life	No Perceptible Impact to Components/Mating Parts	Green
	Functional with Degraded Performance	Monitor Frequently	> 100 Hrs	Eventual Component/Mating Part Degradation from Light Metal Contamination/Wear/Vibration Translation	Green
	Reduced Functionality	Maintain as soon as Practical	10 Hrs < X < 100 Hrs	Moderate Metal Contamination resulting in accelerated component/mating part degradation	Yellow
	Non Critical <u>and</u> Non-Mission Aborting Failure Mode: Lack of Functionality Results in Red Diagonal*	Non Urgent Maintenance	0 < X < 10 Hrs	Immediate component/mating part degradation	Orange
	Critical <u>or</u> Mission Aborting Failure Mode: Lack of Functionality Results in a RED X*	Maintain Immediately	None	Heavy Metal contamination resulting in Catastrophic Potential	Red

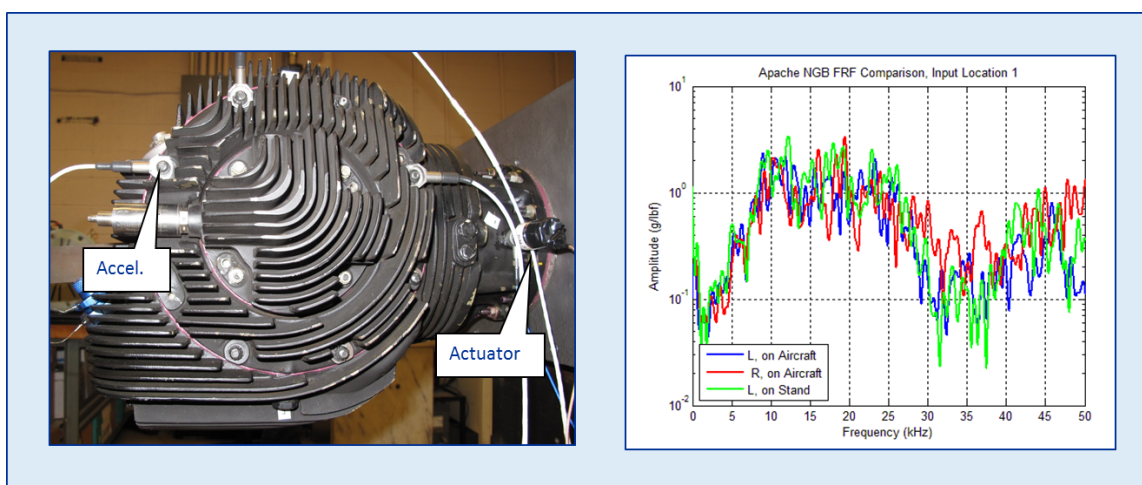

Figure 9.—Modal analysis on NGB.

One step that was not identified in Reference 5 for Pre-Testing was structural characterization of the helicopter. CI performance in the helicopter is affected by the gear dynamics when a fault occurs on the gear tooth and the transfer path of this vibration signature through the structure (i.e., gearbox housing). CIs depend on the structural vibration characteristics of the components to transmit signatures associated with faults. The U.S. Army completed a project characterizing the true transfer pathways from bearings in the gearbox to the Health Usage Monitoring Systems (HUMS) accelerometers for six airframes to determine frequency bands with maximum response amplitudes. The focus was not on gears, and was not taken under varying load conditions (Ref. 15). The project used a pulse generator aligned with reactant bearing load zone to transmit a frequency range for the standard and proposed accelerometer locations on the aircraft. The U.S. Army provided NASA Glenn with an AH64 nose gearbox for additional evaluation of the frequency response under varying load conditions. A test fixture that enables torque to be applied to the input side of the NGB simulating the engine torque was developed. The engine nose gearbox drives the main transmission through an input drive shaft. The measurements taken on a nose gearbox (NGB) when it was installed in an AH64 helicopter were repeated in the fixture. Figure 9 illustrates one measurement taken on the NGB by applying a force with an actuator and measuring its response with an

accelerometer on the housing. Comparison of the data collected on the NGB rig and the helicopter and the effects of the varying test conditions to CI performance were made in a preliminary report (Ref. 16). This preliminary analysis found “the measurements taken on the test stand gearbox at NASA were shown to be consistent with those taken on the same gearbox mounted in an actual Apache helicopter” (Ref. 16).

Step 3: Testing

The Testing step describes specimen set-up, performing tests, and generating a report on the results of the testing. Refer to Figure 10 for the Testing step discussion.

Pre-test procedures/gear setup for the gear test include measuring surface roughness, weighing and cleaning the gears, measuring gear set tooth contact patterns and backlash after installed into test rig gearbox, and taking baseline inspection photos of gear teeth (Fig. 11). The chip detector in the lubrication system will also be cleaned of any residual metal debris and the inductance type oil debris sensor is zeroed prior to the start of a new test.

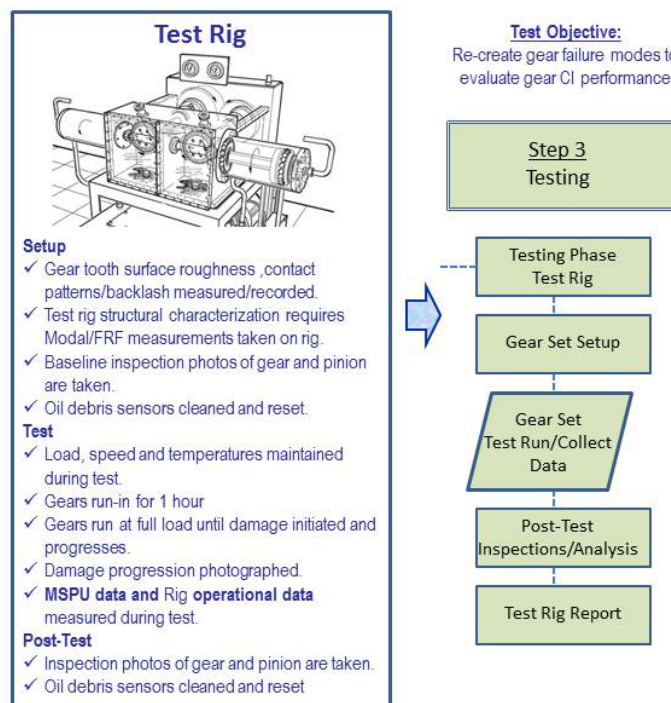

Figure 10.—Step 3: Testing.

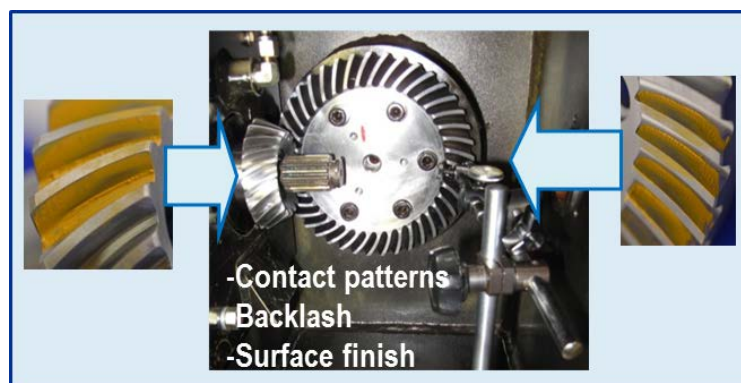

Figure 11.—Gear set setup procedures.

One step that was not identified in Reference 2 was a structural characterization of the test rig. CI performance in the test rig is affected by the gear dynamics when a fault occurs on the gear tooth and the transfer path of this vibration signature through the structure. This information requires understanding why CIs perform differently when installed on the aircraft. These measurements will also identify dynamics unique to the test rig, such as structural resonances, that can affect the CI performance. Transfer path measurements, referred to as frequency response functions (FRF), will be made on the test rig for comparison to the measurements taken on the NGB fixture discussed in the preceding section at different loads under static conditions (Ref. 16).

Speed sweeps will also be performed on the test rig while the rig is rotating to check for resonances in the test rig. Speed sweeps are required to identify test rig resonances that may lie in the frequency range used for a gear CI. Since an aircraft drive system and airframe are specifically designed to avoid operating in a natural frequency, the test stand may have to be operated to avoid these resonant frequencies.

Prior to testing the gears at different test conditions, a run-in will be performed each time a gear set is replaced in the test rig. The run-in period will last 1 hr. Run-in will be performed at the speeds, oil temperatures and pressures maintained for testing, but at 50 percent of full load.

Actual testing will be performed at the speeds, oil temperatures and pressures maintained for the Apache. During testing, operational and research data will be recorded from the research, MSPU and test rig DAQs. Visual inspection will be performed and photographs taken on the gear teeth periodically throughout the test. Inspections will also be performed when the mass measured by the oil debris sensor changes significantly or the gap on the chip detector is closed. Both conditions automatically shut down the test rig. Figure 12 provides an example of CI data collected from one rig test during pinion tooth damage progression. The figure also shows damage progression photos of one pinion tooth with the damage labeled.

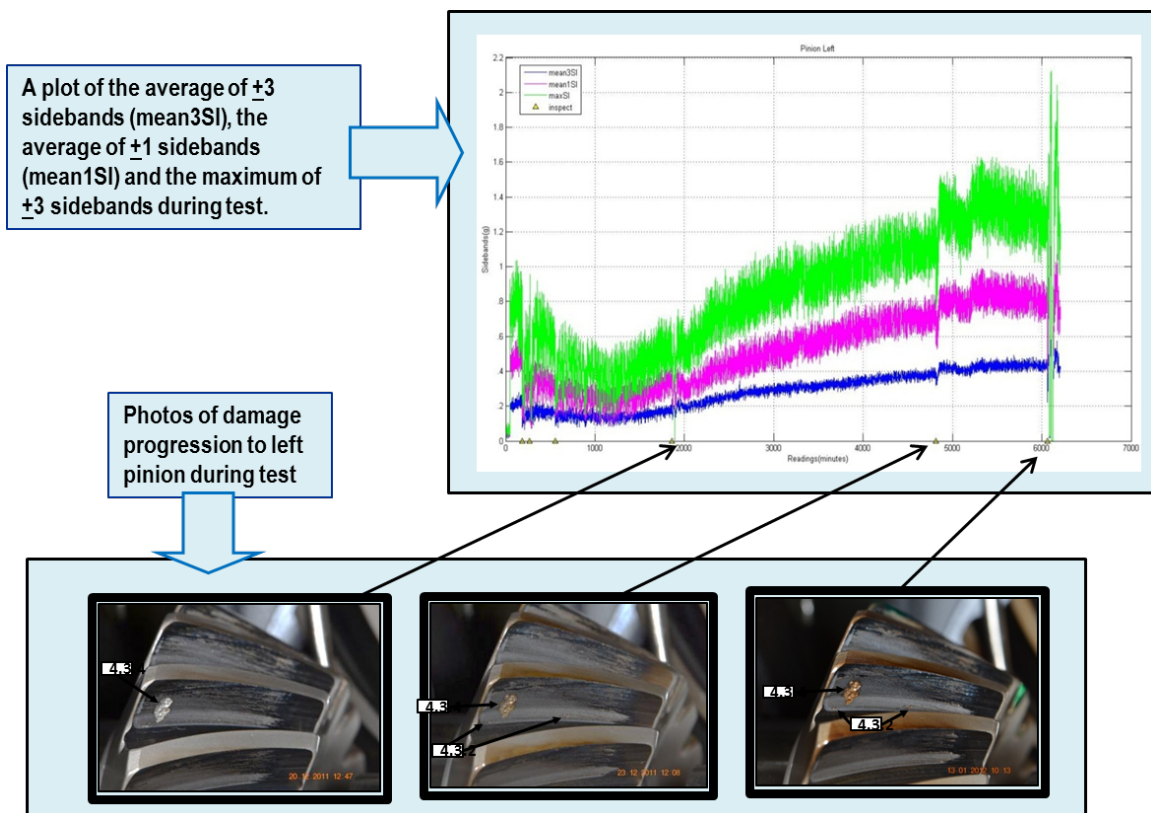

Figure 12.—CI data from rig test.

Once testing of the gear sets is complete, a final report will be published documenting the test conditions, gear tooth damage progression and CI performance for each gear set tested. It will include data collected from the research, MSPU and test rig DAQs. The report will include the detectability of the CI to detect a specific fault, as well as the condition and health indicator's ability to detect damage progression within a specified timeframe. The CI performance will be compared to its performance in the helicopter.

Summary

This paper presented a CI performance validation method that combines in-service data collected from several helicopters when a fault occurred on spiral bevel gears with “seeded fault tests” of spiral bevel gears. Existing in-service HUMS flight data from faulted spiral bevel gears were used to define the requirements for spiral bevel gear seeded fault tests. This approach was mapped to standards for using seeded fault tests for HUMS validation presented in the U.S. Army Aeronautical Design Standard (ADS) Handbook for CBM. An analysis between this paper and Reference 5 discovered several steps should be added to Reference 5 when using existing in-service field data as the foundation of the seeded fault tests. These steps include:

1. Verify the same HUMS configuration used to collect data on the helicopter is used in the test rig.
2. Verify comparable operational conditions when fault data was collected on the helicopter are used in the test rig during fault initiation and progression.
3. Use standard descriptive terms to define damage.
4. Define a method to determine the number of samples to test.
5. If it is cost prohibitive to use existing helicopter components, defining a method to evaluate the component design and failure mechanism are in close approximation/simulation to the helicopter component.
6. Develop method to characterize the structural dynamics of the test rig and tie it back to the helicopter.

Further work is planned to include these steps within the seeded fault process.

References

1. Federal Aviation Administration Advisory Circular (AC) 29–2C, Section MG–15, Airworthiness Approval of RC (HUMS) per Code of Federal Regulations, Title 14-Aeronautics and Space, Chapter I-Federal Aviation Administration, Department of Transportation, Part 29-Airworthiness Standards: Transport Category Rotorcraft.
2. Antolick, L., Wade, D.R., and Brower, N.G.: Application of Advanced Vibration Techniques for Enhancing Bearing Diagnostics on a HUMS-Equipped Fleet. Presented at the American Helicopter Society CBM Specialists Conference, Huntsville, AL, 11-13 February, 2013.
3. Civil Aviation Authority: CAP 753, “Helicopter Vibration Health Monitoring (VHM) Guidance Material for Operators Utilizing VHM in Rotor and Rotor Drive Systems of Helicopters,” First Edition June 2006. First Edition incorporating amendment 2012/01, August 2012.
4. Dempsey, P.J., Branning, J.S., Wade, D.R., and Bolander, N.: Comparison of Test Stand and Helicopter Oil Cooler Bearing Condition Indicators. Proceedings of the American Helicopter Society 66th Annual Forum, Phoenix, Arizona, May 11-13, 2010.
5. U.S. Army Aeronautical Design Standard for Condition Based Maintenance, ADS79 Handbook. August 2012.

6. Antolick, L., Branning, J., Dempsey, P., and Wade, D.: Evaluation of Gear Condition Indicator Performance on Rotorcraft Fleet, 66th American Helicopter Society International Annual Forum 2010, Phoenix, AZ. 11-13 May 2010.
7. ANSI/AGMA 1010-E95. Appearance of Gear Teeth—Terminology of Wear and Failure.
8. Delgado, I., Dempsey, P., Antolick, L., and Wade, D.: Continued Evaluation of Gear Condition Indicator Performance on Rotorcraft Fleet. Airworthiness, CBM, and HUMS Specialists' Meeting, February 11-13, 2013, Huntsville, Alabama.
9. Handschuh, R.F.: Thermal Behavior of Spiral Bevel Gears. NASA/TM-106518, 1995.
10. Handschuh, R.F.: Testing of Face-Milled Spiral Bevel Gears at High-Speed and Load, NASA/TM-2001-210743, 2001.
11. Rickmeyer, T. and Dempsey, P.J.: Processes and Considerations in Extension to Time Between Overhauls and Paths to On-Condition for U.S. Army Rotorcraft Propulsion Systems. American Helicopter Society 67th Annual Forum and Technology Display, Virginia Beach, Virginia, May 2-5, 2011.
12. Bevel Gear Rating Suite by AGMA, American Gear Manufacturers Association, Version 1.0.12, 2007.
13. JSSG-2006, Department of Defense Joint Service Specification Guide, Aircraft Structure, October 30, 1998.
14. Department of the Army Pamphlet (DA PAM) 738-751 "Functional User's Manual for the Army Maintenance Management System—Aviation.
15. Wade, D. and Larsen, C.: Final Report of Bearing Condition Indicator Refinement Project, Technical Report Rdmr Ae-06-01, June 2011.
16. Feldman, J. and Larsen, C.: Apache Left Nose Gearbox Transfer Path Measurements. Etegent Technologies Contract Report prepared for NASA Glenn Research Center, May 2012.

REPORT DOCUMENTATION PAGE			Form Approved OMB No. 0704-0188		
<p>The public reporting burden for this collection of information is estimated to average 1 hour per response, including the time for reviewing instructions, searching existing data sources, gathering and maintaining the data needed, and completing and reviewing the collection of information. Send comments regarding this burden estimate or any other aspect of this collection of information, including suggestions for reducing this burden, to Department of Defense, Washington Headquarters Services, Directorate for Information Operations and Reports (0704-0188), 1215 Jefferson Davis Highway, Suite 1204, Arlington, VA 22202-4302. Respondents should be aware that notwithstanding any other provision of law, no person shall be subject to any penalty for failing to comply with a collection of information if it does not display a currently valid OMB control number.</p> <p>PLEASE DO NOT RETURN YOUR FORM TO THE ABOVE ADDRESS.</p>					
1. REPORT DATE (DD-MM-YYYY) 01-04-2013		2. REPORT TYPE Technical Memorandum		3. DATES COVERED (From - To)	
4. TITLE AND SUBTITLE Validation of Helicopter Gear Condition Indicators Using Seeded Fault Tests			5a. CONTRACT NUMBER		
			5b. GRANT NUMBER		
			5c. PROGRAM ELEMENT NUMBER		
6. AUTHOR(S) Dempsey, Paula; Brandon, E., Bruce			5d. PROJECT NUMBER		
			5e. TASK NUMBER		
			5f. WORK UNIT NUMBER WBS 380046.02.03.02.02.03		
7. PERFORMING ORGANIZATION NAME(S) AND ADDRESS(ES) National Aeronautics and Space Administration John H. Glenn Research Center at Lewis Field Cleveland, Ohio 44135-3191			8. PERFORMING ORGANIZATION REPORT NUMBER E-18669		
9. SPONSORING/MONITORING AGENCY NAME(S) AND ADDRESS(ES) National Aeronautics and Space Administration Washington, DC 20546-0001			10. SPONSORING/MONITOR'S ACRONYM(S) NASA		
			11. SPONSORING/MONITORING REPORT NUMBER NASA/TM-2013-217872; AMRDEC PAO Control Number FN 6258		
12. DISTRIBUTION/AVAILABILITY STATEMENT Unclassified-Unlimited Subject Category: 07 Available electronically at http://www.sti.nasa.gov This publication is available from the NASA Center for AeroSpace Information, 443-757-5802					
13. SUPPLEMENTARY NOTES					
14. ABSTRACT A "seeded fault test," in support of a rotorcraft condition based maintenance program (CBM), is an experiment in which a component is tested with a known fault while health monitoring data is collected. These tests are performed at operating conditions comparable to operating conditions the component would be exposed to while installed on the aircraft. Performance of seeded fault tests is one method used to provide evidence that a Health Usage Monitoring System (HUMS) can replace current maintenance practices required for aircraft airworthiness. Actual in-service experience of the HUMS detecting a component fault is another validation method. This paper will discuss a hybrid validation approach that combines in service-data with seeded fault tests. For this approach, existing in-service HUMS flight data from a naturally occurring component fault will be used to define a component seeded fault test. An example, using spiral bevel gears as the targeted component, will be presented. Since the U.S. Army has begun to develop standards for using seeded fault tests for HUMS validation, the hybrid approach will be mapped to the steps defined within their Aeronautical Design Standard Handbook for CBM. This paper will step through their defined processes, and identify additional steps that may be required when using component test rig fault tests to demonstrate helicopter CI performance. The discussion within this paper will provide the reader with a better appreciation for the challenges faced when defining a seeded fault test for HUMS validation.					
15. SUBJECT TERMS Health monitoring; Gears; Usage					
16. SECURITY CLASSIFICATION OF:			17. LIMITATION OF ABSTRACT	18. NUMBER OF PAGES 22	19a. NAME OF RESPONSIBLE PERSON STI Help Desk (email: help@sti.nasa.gov)
a. REPORT U	b. ABSTRACT U	c. THIS PAGE U			19b. TELEPHONE NUMBER (include area code) 443-757-5802

