



National Aeronautics and
Space Administration

JSC-66638

RELEASE DATE: November 2013

Active Matrix Organic Light Emitting Diode (AMOLED) Environmental Test Report

ENGINEERING DIRECTORATE

AVIONICS SYSTEMS DIVISION

November 2013

National Aeronautics and Space Administration
Lyndon B. Johnson Space Center
Houston, TX 77058

**Active Matrix Organic Light Emitting Diode (AMOLED)
Environmental Test Report**
November 2013

Prepared by

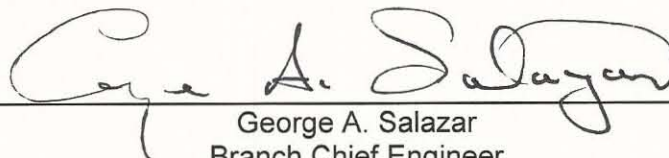

George A. Salazar
Branch Chief Engineer
Human Interface Branch/EV3
281-483-1062

Reviewed by:



Glen F. Steele
Electronics Engineer
Human Interface Branch/EV3
281-483-0191

Approved by:

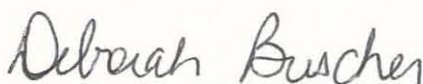

Deborah Buscher
Branch Chief
Human Interface Branch/EV3
281-483-4422

Table of Contents

1.0	AMOLED Environmental Test Summary	1
2.0	References.....	2
3.0	Introduction	3
4.0	Test Article	4
5.0	Environmental Testing	7
5.1	Electromagnetic Interference (EMI) Test	7
5.1.1	Test Description	7
5.1.2	Results.....	9
5.2	Thermal Vacuum	10
5.2.1	Test Description	10
5.2.2	Thermal Vacuum Test Results.....	18
5.3	Radiation	21
5.3.1	Test Description	21
5.3.2	Radiation Test Results	24
6.0	Conclusion.....	26
	Appendix A. Acronyms and Abbreviations	27

Table of Figures

FIGURE 1 AMOLED ASSEMBLY AND THE VIDEO DECODER BOARD	4
FIGURE 2 AMOLED ASSEMBLY INSTALLED INTO ENCLOSURE'S UPPER LID	5
FIGURE 3 COMPLETED ENCLOSURE WITH AMOLED DISPLAY BRACKET	5
FIGURE 4 AMOLED DISPLAY DRIVER LOCATIONS	6
FIGURE 5 EMI TEST CONFIGURATION	8
FIGURE 6 AMOLED #1 MOUNTED TO THE EMI TEST TABLE	8
FIGURE 7 MOVING X EMI TEST PATTERN	8
FIGURE 8 AMOLED #1 RE102 TEST	9
FIGURE 9 AMOLED #2 RE102 TEST	10
FIGURE 10 THERMAL VACUUM CHAMBER N	11
FIGURE 11 THERMAL VAC TEST CONFIGURATION	12
FIGURE 12 HABITAT PRESSURE TEST PROFILE	13
FIGURE 13 TEMPERATURE CYCLE PROFILE	13
FIGURE 14 VDB THERMAL HOT SPOTS AND ASSIGNED TC CHANNELS	14
FIGURE 15 VDB WITH COPPER TAPE MODIFICATIONS AND THERMAL COUPLES	15
FIGURE 16 CHAMBER N COLD PLATE AND DATA ACQUISITION CONNECTIVITY	15
FIGURE 17 AMOLED DEPRESSURIZATION RATES	16
FIGURE 18 CHAMBER N CANOPY	17
FIGURE 19 LIGHT SENSOR BRACKET	17
FIGURE 20 COLORIMETER AND HD CAMERA SETUP INSIDE CANOPY	17
FIGURE 21 TEMPERATURE, CURRENT, AND LUMINANCE VS. TIME PLOT	19
FIGURE 22 COLOR TEMPERATURE AND CURRENT VS. TIME PLOT	19
FIGURE 23 IMAGING COLORIMETER DATA --LUMINANCE	20
FIGURE 24 SPECTRAL IRRADIANCE VS. TIME PLOT	20
FIGURE 25 AMOLED RADIATION TEST SETUP	22
FIGURE 26 AMOLED RADIATION SETUP IN THE CHAMBER	22
FIGURE 27 AMOLED WITH RADIATION SHIELDING	23
FIGURE 28 SHIELDED PAN/TILT CAMERA	23
FIGURE 29 AMOLED SCREEN 24 HOURS LATER	24

List of Tables

TABLE 1 CHARACTERIZATION PRIOR TO AND AFTER THE EMI TEST	9
TABLE 2 CHARACTERIZATION PRIOR TO AND AFTER THE THERMAL VAC TEST	18
TABLE 3 CHARACTERIZATION BEFORE AND AFTER RADIATION TEST	24

1.0 AMOLED Environmental Test Summary

The Active Matrix Organic Light Emitting Diode (AMOLED) display, model numbers AZAMOLED043A (non-touch) and AZAMOLED043A-T (touch) by AZ Display Inc. was subjected to three types of environmental testing: EMI, Thermal Vacuum (vac), and radiation. The AMOLED was characterized by taking spectral and luminance readings before and after each test to ascertain any permanent degradation in optical performance as a result of being subjected to the induced environment. During each test, the display was monitored for performance degradation due to the induced environmental changes.

For the EMI test, both the touch and non-touch displays were each subjected to radiated emissions (RE) testing in accordance with Military Standard (Mil-Std) 461F--specification RE102-- to determine compliance/non-compliance. Both units RE levels were well within the 461F standard for RE102 compliance. For radiated susceptibility (RS), only the non-touch display was subjected to the International Space Station (ISS) RS03 specification for radiated immunity--first at 20, then 50, and 75 volts per meter (V/M) electric field intensity (EFI). In all three EFI, the AMOLED did not experience issues or anomalies. Post-EMI optical characterization showed no degradation of the display.

For thermal vacuum (vac), only the non-touch display was tested. Three tests were conducted: habitability pressures, thermal vac cycling, and rapid depressurization. For all the tests, AMOLED current draw, key circuit component temperatures, spectral irradiance, colorimeter, and luminance measurement data were captured. The habitability test occurred at room temperature for ten, eight, and four pound per square inch ambient (psia). Throughout all the habitability pressures the display experienced no issues/anomalies. Next, one thermal cycle from -20 °F to +120 °F at each of the habitability pressures (8, 10 and 4 psia) was performed. During these tests, it was noted that the display intensity decreased along with current draw as the chamber temperatures dropped in temperature--this occurred at all the habitable pressures. Also, the display color temperature shifted as the chamber temperature changed on both the cold and hot cycles. The rapid depressurization checked on workmanship of the display. The chamber was taken down from 14.7 to 0 psia at 1 psi/minute and then 2 psi/minute. In both cases, the display did not experience any electrical or mechanical issues. Post-thermal optical characterization showed no degradation of the display.

Radiation testing occurred at the Indiana University Cyclotron Facility (IUCF). The non-touch AMOLED display was radiation tested to 600 rads (ten year total dose inside the ISS) and then to 6000 rads (ten year total dose outside the ISS). The AMOLED functioned without issue up to 600 rads giving an expected mean time between failures (MTBF) of better than 10 years. However, testing out to 6000 rads (SI) showed that there was some permanent display degradation noted in terms of reduction in current draw and darkening of the display as it reached 6000 rads.

Though the display was designed for commercial/industrial applications, it performed well in EMI testing. For thermal testing, the display is sensitive to temperature. Therefore, keeping the display at a constant operating temperature or compensating the display for ambient temperature is important to ensure luminance and color shifts are minimized. Radiation testing showed that the display is suitable for use inside a spacecraft where the total dose does not exceed 600 rads (SI). However, if used externally, the display will begin to darken as the total dose exceeds 600 rads (SI).

2.0 References

NASA/JSC Documents

Document Number	Document Title
EV5-EMCEO-13-007	OLED Display Final Test Report
JSC 66459	Evaluation of Samsung Galaxy Note's OLED Display
JSC 66615	Evaluation of the Organic Light Emitting Diode Display
SSP 30512, Rev C (1994)	Space Station Ionizing Radiation Design Environment

Other Documents

Clark, T.A (September, 2013) - Thermal Test of Organic LED Display Final Report Presentation (Note: Much of the analysis in the thermal section of this report comes from this presentation.)
Maida, J.C. and Clark, T.A. (October 2013)—OLED Test Summary Presentation
Honeywell RTF-FF-08-003, Revision A, 1/22/2009 - Radiation Test Report for Proton Testing of the Chi Mei EL Corporation Model P043WQIC-T 4.3 Inch AMOLED Display

3.0 Introduction

This report focuses on the limited environmental testing of the AMOLED display performed as an engineering evaluation by The NASA Johnson Space Center (JSC)—specifically, EMI, Thermal Vac, and radiation tests. The AMOLED display is an active-matrix Organic Light Emitting Diode (OLED) technology. The testing provided an initial understanding of the technology and its suitability for space applications. Relative to light emitting diode (LED) displays or liquid crystal displays (LCDs), AMOLED displays provide a superior viewing experience even though they are much lighter and smaller, produce higher contrast ratio and richer colors, and require less power to operate than LCDs. However, AMOLED technology has not been demonstrated in a space environment. Therefore, some risks with the technology must be addressed before they can be seriously considered for human spaceflight. The environmental tests provided preliminary performance data on the ability of the display technology to handle some of the simulated induced space/spacecraft environments that an AMOLED display will see during a spacecraft certification test program.

This engineering evaluation is part of a Space Act Agreement (SAA) between The NASA/JSC and Honeywell International (HI) as a collaborative effort to evaluate the potential use of AMOLED technology for future human spaceflight missions—both government-led and commercial. Under this SAA, HI is responsible for doing optical performance evaluation, as well as temperature and touch screen studies. The NASA/JSC is responsible for performing environmental testing comprised of EMI, Thermal Vac, and radiation tests. Additionally, as part of the testing, limited optical data was acquired to assess performance as the display was subjected to the induced environments.

The NASA will benefit from this engineering evaluation by understanding AMOLED suitability for future use in space as well as becoming a smarter buyer (or developer) of the technology. HI benefits from the environmental testing results by understanding its performance limitations/shortcomings to improve subsequent generations of AMOLED technology. Note that the AMOLED used in this test was not designed for the space environment but rather for commercial/industrial terrestrial applications.

4.0 Test Article

The test article is a commercial/Industrial product comprised of two assemblies: the AMOLED display assembly and the enclosure to house the AMOLED display assembly circuit components. The AMOLED display assembly is produced by AZ Displays Inc., part number AZAMOLED043A (AZAMOLED043A-T for touch screen). The key assembly components are: the 4.3 inch AMOLED display supplied by Chi Mei EL Corporation Model P0430WQLC-T that can be configured for touch or non-touch applications; the video decoder board (VDB) that serves as the power conditioning for the VDB and AMOLED as well as performing signal processing between external video inputs and the AMOLED display; a keyboard input into the VDB for menu selection and setting display parameters; Video/Power input board; and a Video Graphics Array (VGA) input connector into the VDB. Figure 1 shows the AMOLED assembly received from HI along with the VDB located behind the AMOLED display.

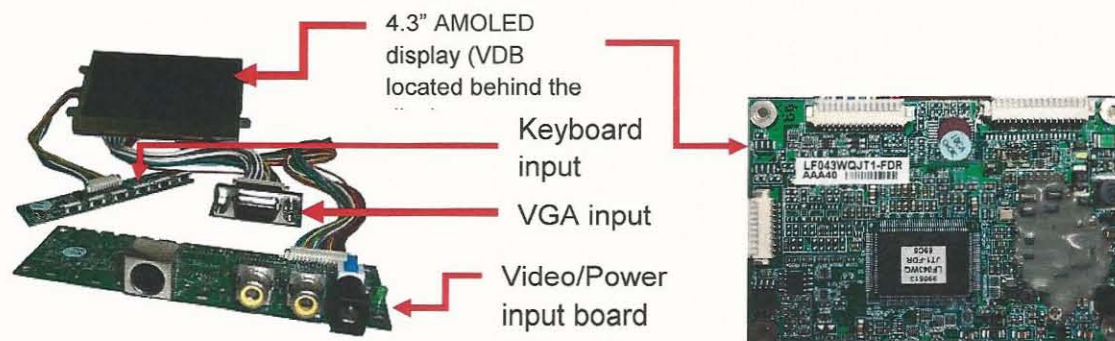

Figure 1 AMOLED Assembly and the Video Decoder Board

As Figure 1 indicates, the hardware assembly was not suitable for performing environmental testing easily. Hence, a commercial enclosure was purchased and modified to house the AMOLED hardware assembly. Figures 2 and 3 show the enclosure developed for housing the AMOLED assembly. Figure 2 shows the AMOLED assembly installed in the enclosure upper lid. Figure 3 shows the finished enclosure including the installed AMOLED display and a display bracket to hold the display 90 degrees upright (the VDB is located underneath the display). Note that a base plate was added for later thermal vac testing to support conduction-cooling of the VDB components.

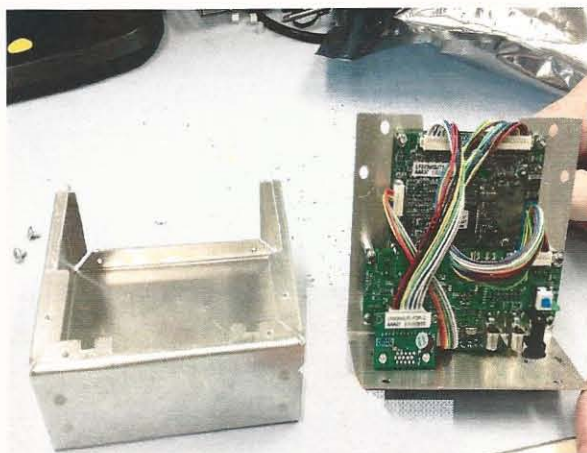

Figure 2 AMOLED Assembly Installed into Enclosure's Upper Lid

Two units were built up— AMOLED Display Unit #1 and #2. Display Unit #1 (non-touch) was used throughout the three tests and configured as a non-touch display. Display Unit #2 was configured as a touch display for EMI testing and then returned to non-touch configuration to serve as a backup in case AMOLED display #1 failed. For both units, the display parameters were set at:

- Brightness=27
- Contrast= 25
- Color= Normal
- Horizontal=0
- Vertical= -1

These parameters were maintained throughout the environmental tests.

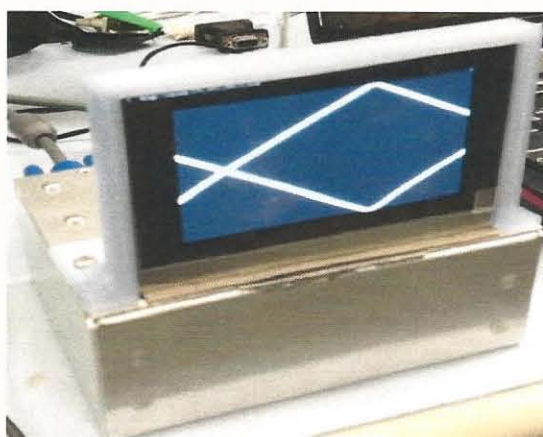

Figure 3 Completed Enclosure with AMOLED Display Bracket

The Chi Mei EL display consists of a 4.3 inch diagonal glass panel. The active display area of the AMOLED is 3.7 inches horizontal by 2.1 inches vertical with a display element array of 480 horizontal by 272 vertical. The glass panel display pixel active elements are Amorphous Silicon Thin Film Transistors (TFT). Each red/green/blue (RGB) pixel consists of two TFTs for enabling

and activating a red, green, or blue OLED. In addition to the TFTs, the display contains drivers located outside the active display area. Located on the display below the active display area is a column driver integrated circuit that was protected during radiation testing. An integrated row driver is located to the left of the display—outside the active area. Figure 4 shows the location of the active components on the board.

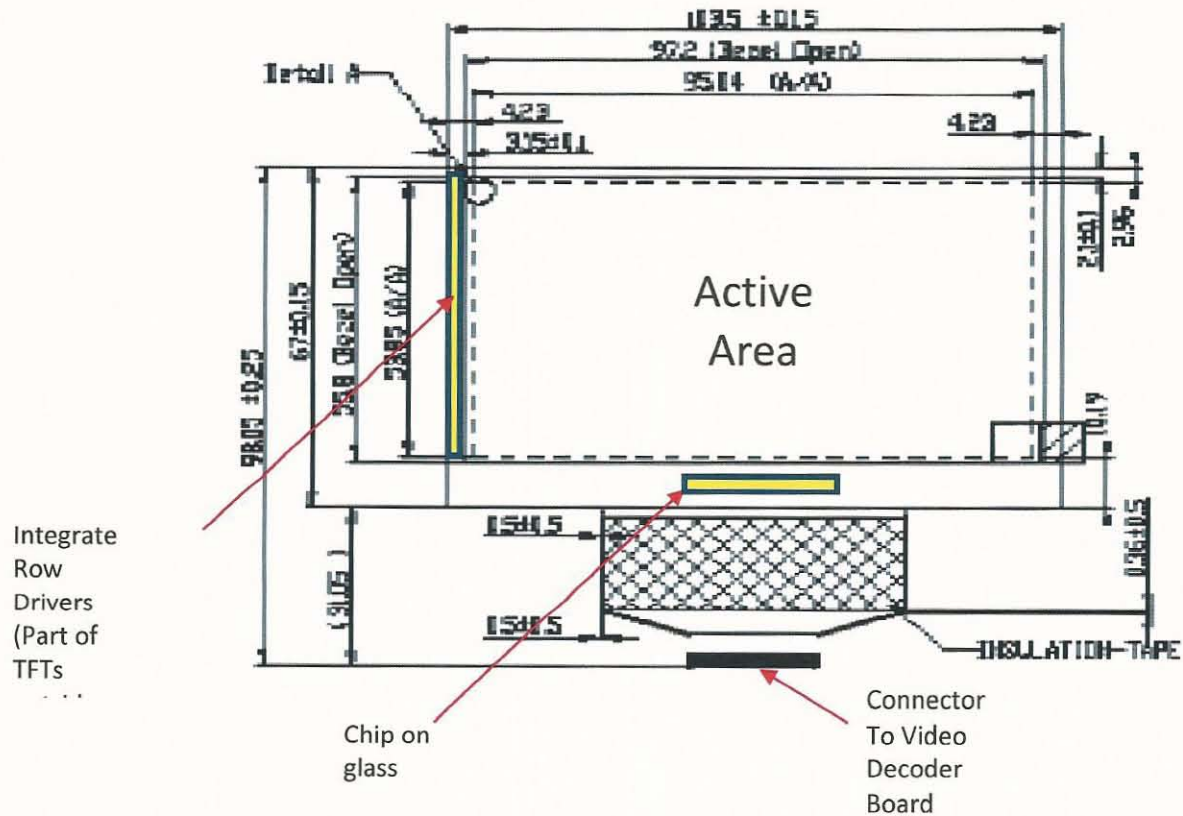

Figure 4 AMOLED Display Driver locations

5.0 Environmental Testing

5.1 Electromagnetic Interference (EMI) Test

5.1.1 Test Description

Given the time and resources available for the environmental testing of AMOLED, only two EMI tests were identified to test the AMOLED--radiated emissions and radiated susceptibility. These tests would provide preliminary data on the display's radiated emissions and susceptibility of the display to spacecraft radio frequency and select EFI levels.

For Radiated Emission 102 (RE102) testing, both units were tested. For Radiated Susceptibility 03 (RS03) testing, only AMOLED #1 was tested. AMOLED #2 served as a backup in case RS03 testing damaged the first unit. The tests were performed in accordance with MIL-STD 461F for the radiated emissions test RE102, with modifications based on ISS known transmitter frequencies (2MHz-18 GHz) and corresponding EMI limits for the radiated susceptibility tests RS03 (30 MHz-18 GHz). For RS03 testing, electric field strengths of 20, 50, and 75 volts per meter (V/M) were used at each of the said frequency ranges. JSC document EV5-EMCEO-13-007 provides the details of the tests.

The test setup for RE102 and RS03 is shown in figure 5. An EMI-hardened camera with a fiber optics communications cable was used to view the display on the monitor in the control room. Camera controls were available to zoom and focus the AMOLED display image on the control room monitor. In case a display anomaly occurred the video was not only viewed but also recorded for later playback. Power to the AMOLED was supplied by 12 volts DC through a line impedance stabilization network (LISN). The AMOLED enclosure seams were sealed with copper tape to ensure that only the display and not the display driver circuitry would be affected by the test frequencies/EFI. Figure 6 shows the AMOLED #1 mounted on the EMI test chamber table.

A moving X pattern containing a static white background with a black moving X was used as the test pattern. The original test pattern contained a stationary black background with a moving white X. Upon discussions with JSC lighting personnel, it was determined that the opposite would serve as a better test pattern given that more OLEDs would be active since it takes all three colors (red, green, blue) to make a white background. Figure 7 shows the test pattern used in both EMI tests.

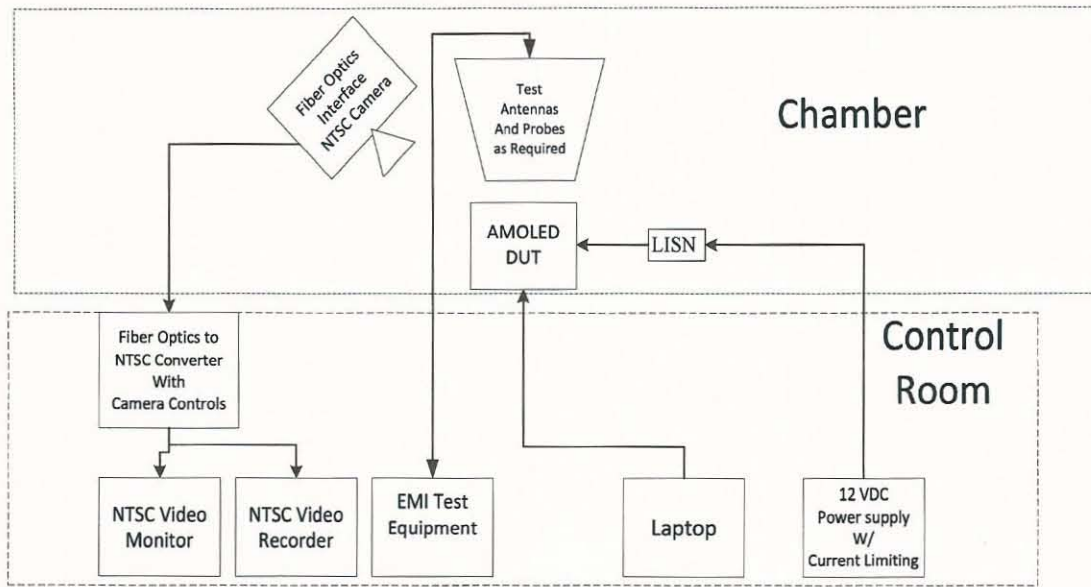

Figure 5 EMI Test Configuration



Figure 6 AMOLED #1 Mounted to the EMI Test Table

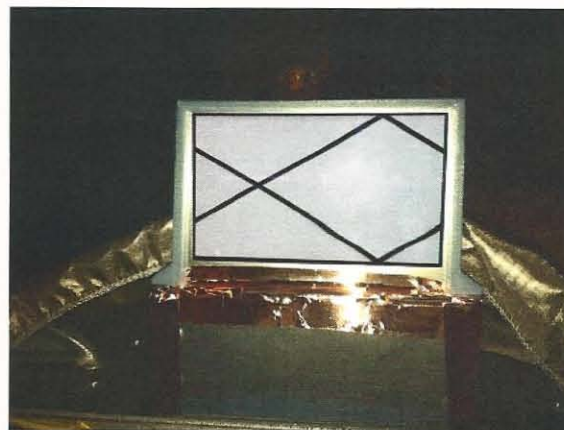

Figure 7 Moving X EMI Test Pattern

For the RE102 test, the video was monitored for anomalies but not recorded. No anomalies were expected during the RE102 test since the EMI test equipment was configured for “sniffing” the AMOLED to determine what radiated frequencies and EFI were being emitted from the display. Hence, no video recording was necessary.

For RS03, the display was subject to EFI of 20, 50, and 75 V/M and therefore possible anomalies could be expected. Test observers in the control room watched for spots appearing in the white or black regions, blurred or distorted moving X, or current draw changes.

To determine if the RS testing degraded the display, optical characterization of the AMOLED was taken prior and after the EMI tests. Table 1 shows the results of the characterization.

Table 1 Characterization Prior to and After the EMI Test

EMI Testing	Before	After
Average Luminance cd/m²	141	140
CCT (K)	8929	8764
Chromaticity (x,y)	0.273	0.272
	0.330	0.339
CRI	80	80

5.1.2 Results

Figures 8 and 9 show the test results for the radiated emissions test against the Mil-Std 461F radiated emissions limit for AMOLEDs #1(non-touch) and #2 (touch), respectively. Both units successfully passed the test with both units emitting approximately the same emissions spectrum.

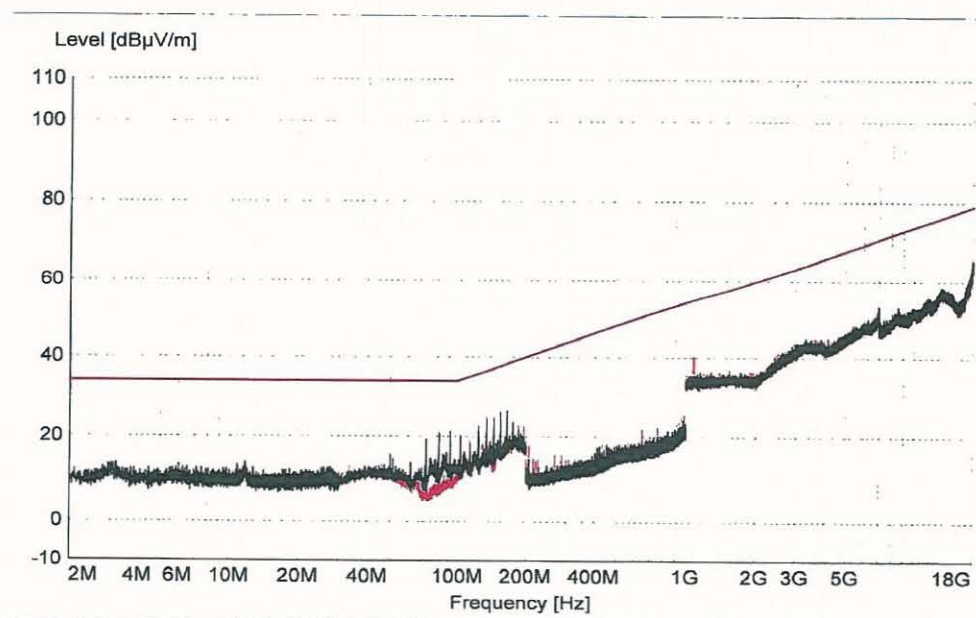

Figure 8 AMOLED #1 RE102 Test

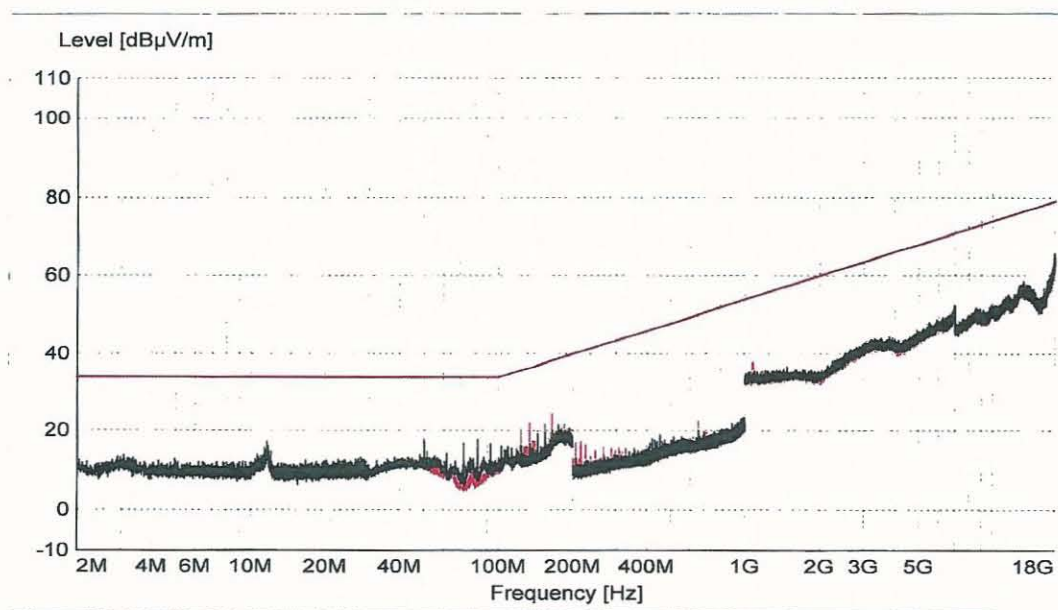

Figure 9 AMOLED #2 RE102 Test

Only AMOLED #1(non-touch) display was RS tested. There were no non-compliances to the RS03 standards. Testing at 20, 50, and 75 V/M all had the same following results:

30-200 MHz (HP/VP)	-- Pass/Pass
200-1000 MHz (HP/VP)	-- Pass/Pass
1-2.5 GHz (HP/VP)	-- Pass/Pass
2.5-7.5 GHz (HP/VP)	-- Pass/Pass
7.5-18 GHz (HP/VP)	-- Pass/Pass

Details of the tests are located in the JSC document EV5-EMCEO-13-007

“OLED Display Final Test Report.” Pre and post characterization showed no permanent degradation of the display. Luminance, CCT, Chromaticity, and CRI all showed virtually no change pre and post testing. Hence, RS testing at the frequencies and EFI selected should not be a concern.

5.2 Thermal Vacuum

5.2.1 Test Description

A series of Thermal Vac tests were performed on AMOLED #1 to assess how well the technology stood up to pressure and temperature changes. Three Thermal Vac tests were performed on the AMOLED: Habitation operating pressures (ambient temperature), thermal cycling at habitation pressures, and rapid depressurization (ambient temperature). All tests were performed in Crew and Thermal Systems Division (CTSD) thermal vacuum chamber N (Figure 10). The chamber N window permitted placing optical instruments to view the display and gather data as the chamber pressure and temperature was changed.



Figure 10 Thermal Vacuum Chamber N

Figure 11 shows the test configuration for the thermal vacuum testing. The display driving laptop provided the "Moving X" pattern to the AMOLED display via the VGA cable. A +12 VDC power supply with current limiting and current display capability provided power to the display. Several thermal couples (TC) from the video decoder board, back of the display, and the top of the display enclosure provided thermal status as the display was subjected to the induced changing temperature and pressures. These TC measurements were acquired by the facility Data Acquisition and Recording Control System (DARCS). The Spectral Irradiance Meter captured and recorded AMOLED emitted spectrum data at regular intervals. The video camera captured and recorded motion imagery of the AMOLED displaying the "moving X" pattern as it was subjected to changing temperature and pressures. Both the Colorimeter and the Luminance Meter captured luminance and color coordinated data and emitted light flux, respectively, as time permitted.

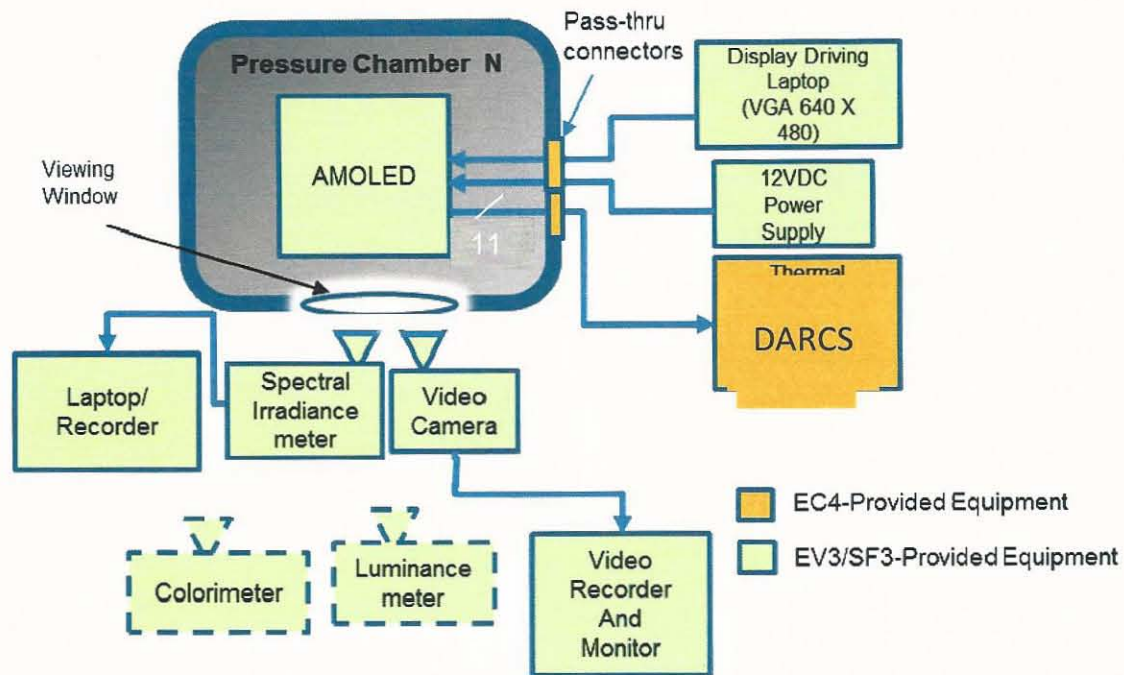

Figure 11 Thermal Vac Test Configuration

Habitation Pressures

Habitation operating pressures commensurate with space application were chosen to test the display against operating pressures. Pressures of 10, 8, and 4 pounds per square inch absolute (psia) were selected based on known spacecraft/spacesuit operating pressures. For these tests, the temperature was held at ambient temperature (approx. 77 °F). Figure 12 shows the profile and approximate duration of each habitat pressure. Each habitat pressure was maintained for approximately 15 minutes before proceeding to the next habitat pressure at approximately 1 psia/minute.

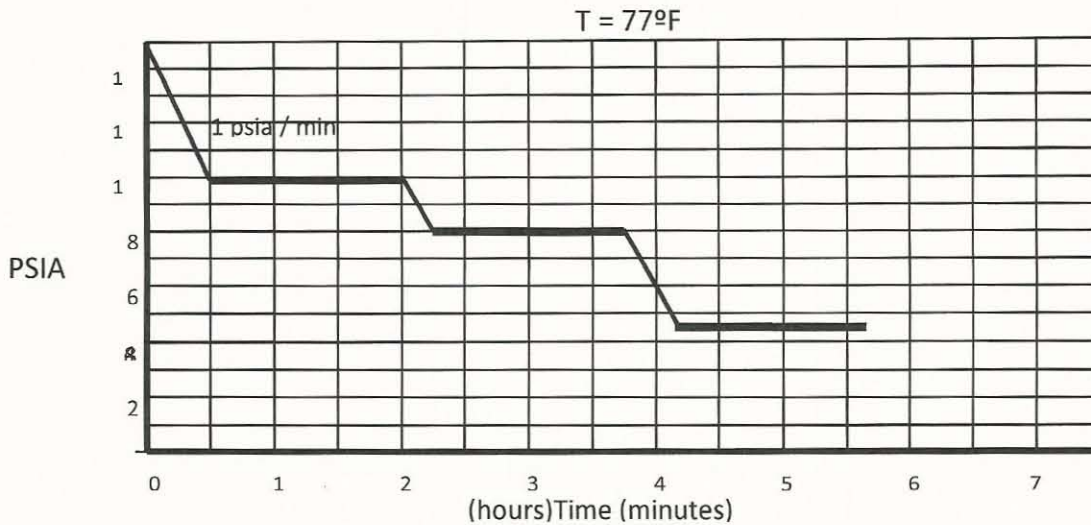

Figure 12 Habitat Pressure Test Profile

Thermal Cycling

Thermal cycling served to test the display at habitat pressures while performing 1 thermal cycle to see how well the technology stood up to induced pressure and temperature changes. One thermal cycle was considered sufficient to see how the display technology held up to both changing environments. The temperature extremes were selected at -20 °F for cold and +120 °F for the hot. The temperatures were selected based on vendor reliability data backed off by 20 degrees on both extremes to provide margin given that the reliability data was based on testing at ambient pressure. For the cold extreme temperature, duration of 30 minutes was selected. For the hot extreme temperature, duration of ten minutes was selected. Figure 13 shows the overall thermal cycling profile for each habitat pressures.



Figure 13 Temperature Cycle Profile

Video Decoder Board Conduction-Cooled Mechanism

With concerns of operating at lower pressures, particularly on the hot cycle, a pseudo conduction-cooled component mechanism was devised to cool identified hot spots on the video decoder board (VDB). Temperature measurements were taken of the board and the top eleven hot spots were identified that needed a conduction cool path to the enclosure. Figure 14 shows the VDB and the hotspots temperature readings taken at ambient conditions. The measurements, with thermal couple (TC) Channel in parenthesis, were connected to the thermal chamber DARCS to monitor the temperatures in real-time.

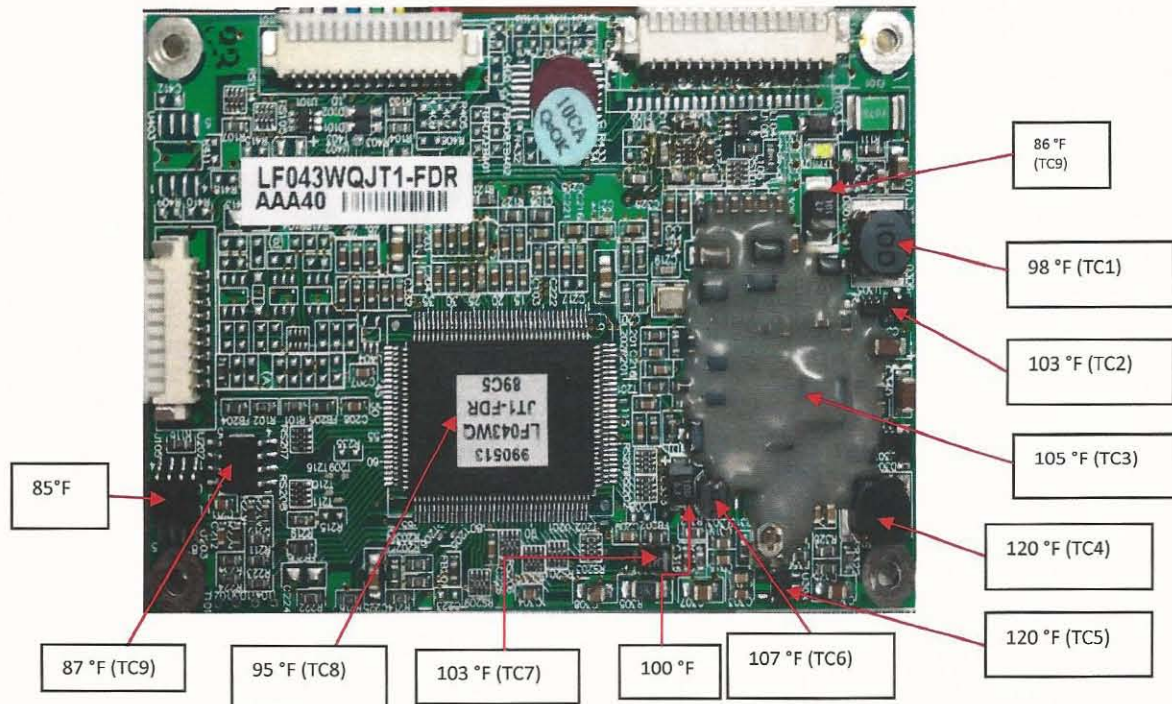

Figure 14 VDB Thermal Hot Spots and Assigned TC Channels

The two other measurements shown on the board did not have thermal couples attached to them. The glob on the VDB measured by TC3 appears to be some kind of epoxy used to cover electronics to prevent identification of part(s). Figure 15 shows the VDB along with the copper tape attachments to the hot spots and the TCs. Note that all the copper tape connections terminate underneath the top of the AMOLED enclosure. The theory was that the base plate that mounted to the chamber N cold plate would cool the chassis up to the top of the enclosure. Then, the copper tape attached to the top enclosure (underneath) would conduct the cold plate heat to the components.

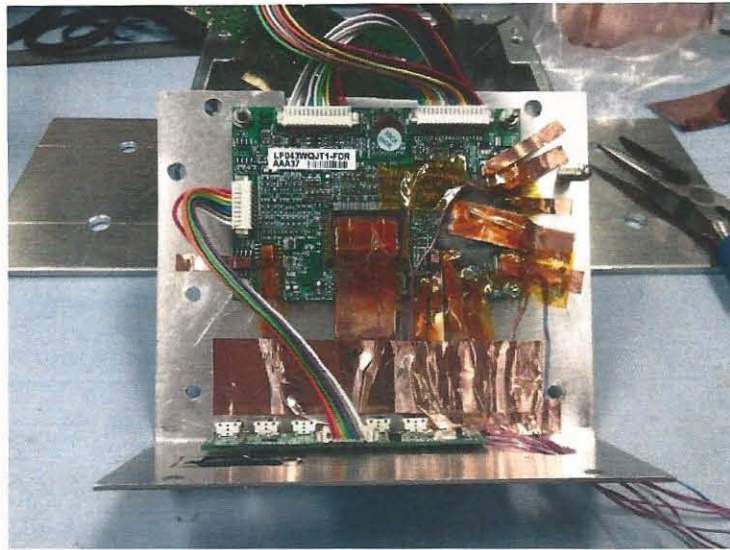

Figure 15 VDB with Copper Tape Modifications and Thermal Couples

In addition to the nine TC channels, two additional TC channels were added to the AMOLED—the back of the AMOLED display (TC 10) and the top of the enclosure (TC 11) — giving a total of 11 channels that would connect to the thermal chamber DARCS (figure 16). Note that TC10 was compared to the cold plate temperature and to TCs 1-9 to assess the performance of the pseudo conduction-cooled component mechanism. TC10 would drive the chamber N temperature as shown in figure 13.

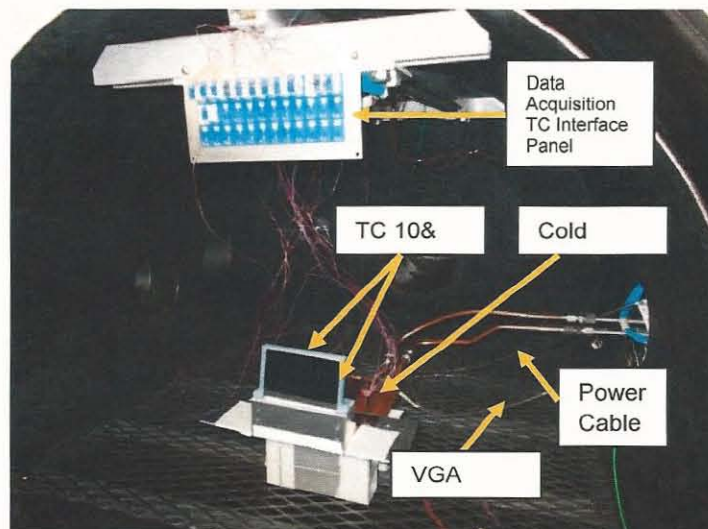

Figure 16 Chamber N Cold Plate and Data Acquisition Connectivity

Depressurization Test

The depressurization test served to verify the workmanship of the display. Two depressurization rates were selected to test the display against—1 and 2 psia per minute. Figure 17 shows the two profiles. Both tests exposed the display to vacuum. The chamber temperature was maintained at ambient throughout both depressurization tests. As seen in the figure, the depressurization test was short compared to the other thermal tests but provided confidence that the display could handle the rapid depressurization rates.

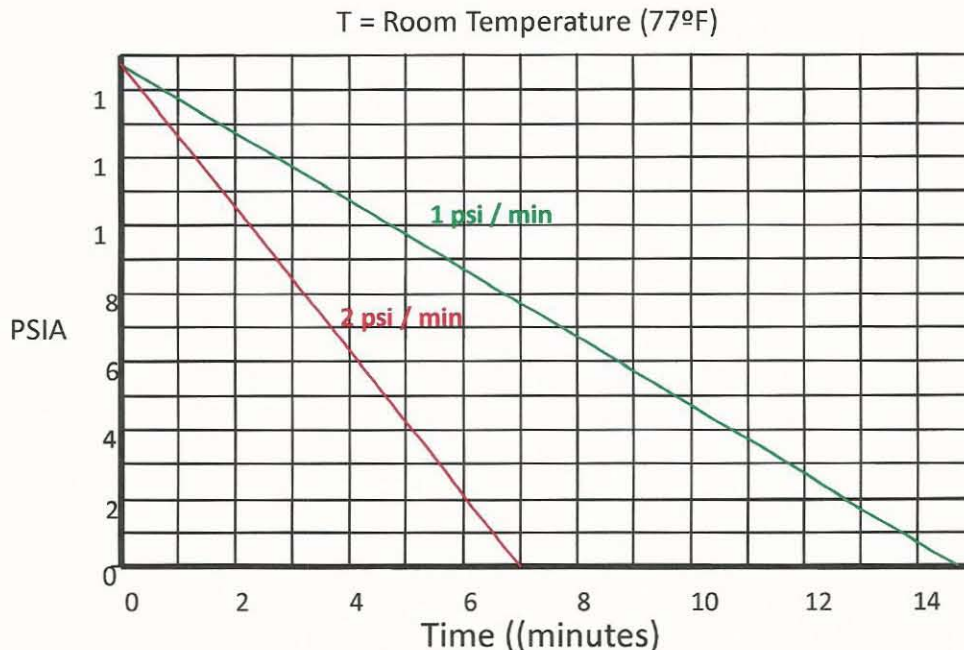

Figure 17 AMOLED Depressurization Rates

Electrical, Thermal, and Optical Data Capture

Throughout thermal vac testing, AMOLED electrical, thermal, and optical performance data was captured. Three optical measurement devices were used to acquire display optical data: Spectral Irradiance meter, Imaging Colorimeter, and the Luminance Meter. A high definition (HD) camera captured and recorded video of the display (through the chamber window) for recording display anomalies for later analysis. A power supply with current draw indicator was used to power the display and monitor the current draw as the environments were changing. Temperature measurements of the eleven thermocouples attached to the display video decoder board (total of nine), the back of the display, and the top of the display enclosure were acquired by the facility's data acquisition system. In addition, the chamber cold plate and air temperature were monitored. To ensure the display was subjected to the temperature range as noted in Figure 13, the back of the display thermocouple that measured display temperature drove the chamber N temperature—chamber temperature controlled and compared against back of the display temperature.

Due to the light sensitivity of these optical instruments, a dark canopy was devised to minimize outside/facility light when taking optical measurements of the display through the chamber N window. Figure 18 shows the canopy that was setup in front of the chamber. Figure 19 shows the chamber N door closed with the Spectra Irradiance Meter light intensity sensor bracket

installed on the canopy framing structure. Figure 20 shows the Colorimeter and HD camera inside the canopy mounted on tri-pods aiming at the AMOLED through the chamber N window. Colorimeter measurements required manually selecting the capture command on the laptop software associated with the Colorimeter instrument. The laptop was located inside the canopy.

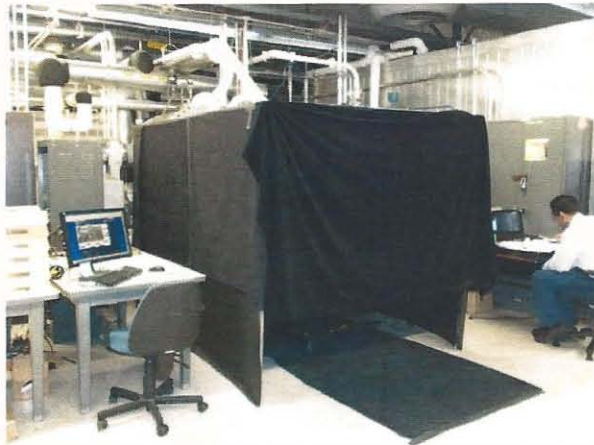

Figure 18 Chamber N Canopy

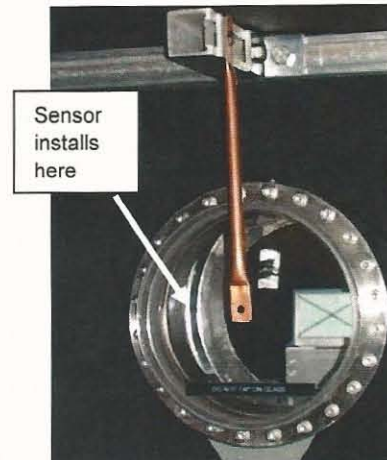

Figure 19 Light Sensor Bracket

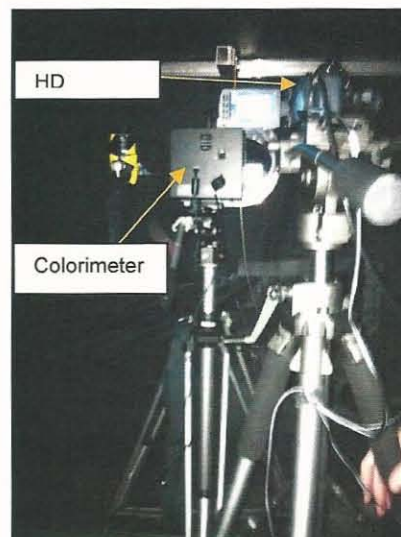

Figure 20 Colorimeter and HD Camera Setup inside Canopy

The Luminance Meter did not require a tri-pod. Rather, it is a hand-held unit that required going inside the canopy, putting it up close to the chamber window, focusing on the AMOLED image, and taking readings at the four corners and middle of the display

A total of 60 luminance readings were taken throughout all three thermal vacuum tests with most readings occurring during the thermal cycling. A total of 144 Colorimeter meter files were generated from taking samples—mostly during the thermal cycling test. A total of 455 irradiance files were acquired throughout the testing with data acquisition rates starting at a sample every 6 minutes and then increasing to every two minutes during the thermal cycle

testing. Throughout all the tests, thermal couple measurements were taken every minute. A total of 60 power supply current measurements were taken.

Similar to the EMI test, optical characterization of the AMOLED was taken prior to and after the Thermal Vac tests to determine if the tests degraded the display. Table 2 shows the results of the characterization.

Table 2 Characterization Prior to and After the Thermal Vac Test

Thermal Testing	Before	After
Average Luminance cd/m²	144	150
CCT (K)	8148	8464
Chromaticity (x,y)	0.280	0.277
	0.345	0.339
CRI	82	80

5.2.2 Thermal Vacuum Test Results

Habitat pressure testing at constant chamber temperature showed that luminance and power supply current draw remained constant at around 140 candelas per square meter (cd/m²) and 0.29 amps, respectively. Because of the pseudo conduction cooled component mechanism, the video decoding board devices temperature closely followed the chamber cold plate temperature. The pressure change did not affect the operation of the device in terms of optical performance.

Thermal cycle testing clearly showed that the AMOLED display is sensitive to temperature changes. The current draw was directly proportional to the temperature of the display. This suggests that the display TFTs were affected by the changing temperature resulting in either higher current draw when the display got warmer or lower current draw as the display got colder. Figure 21 show a normalized plot of the temperature (chamber), current draw, and luminance at the different pressures as a function of time to show how luminance and current were directly related to temperature. Note that the display current draw lagged the temperature change. This may be attributed to the thermal characteristics of the conduction path from the display material to the TFTs as well as the TFT thermal characteristics.

Data taken from the Spectral Irradiance Meter also demonstrates AMOLED technology's temperature sensitivity. The color temperature of the display changed as the current draw changed due to the temperature change. Figure 22 shows a plot of the color temperature and current as a function of time. The AMOLED experienced a correlated color temperature (CCT) cycle from approximately 7000K during the coldest thermal cycle to about 9000K during the hottest thermal cycle.

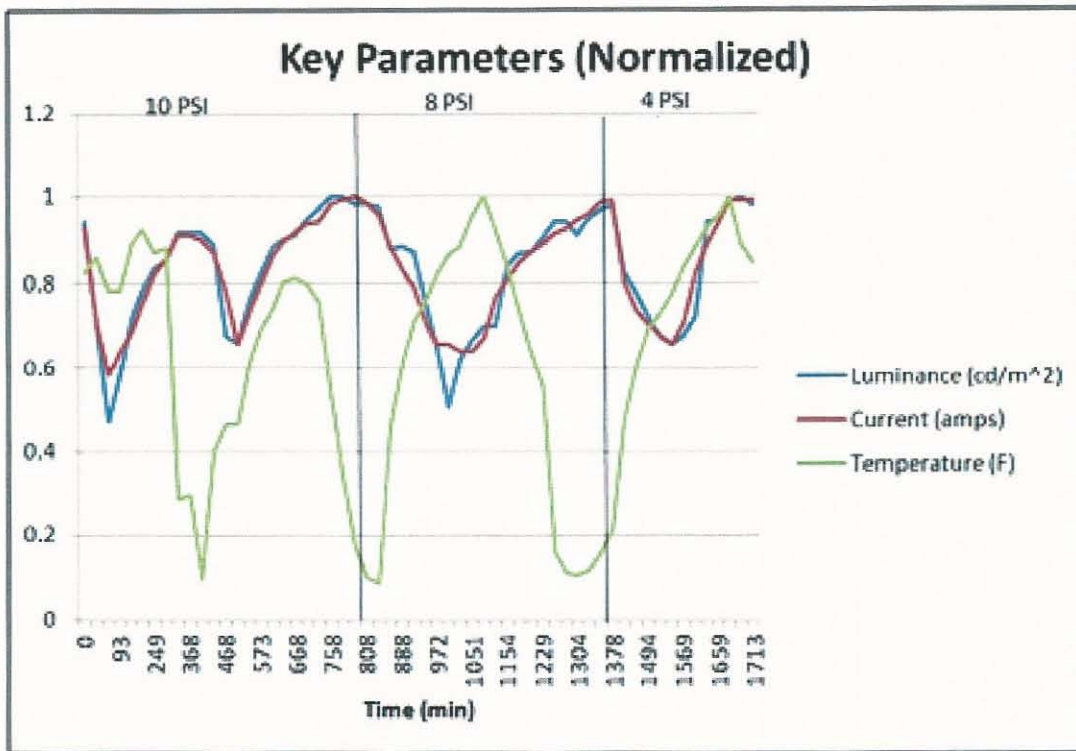

Figure 21 Temperature, Current, and Luminance vs. Time Plot

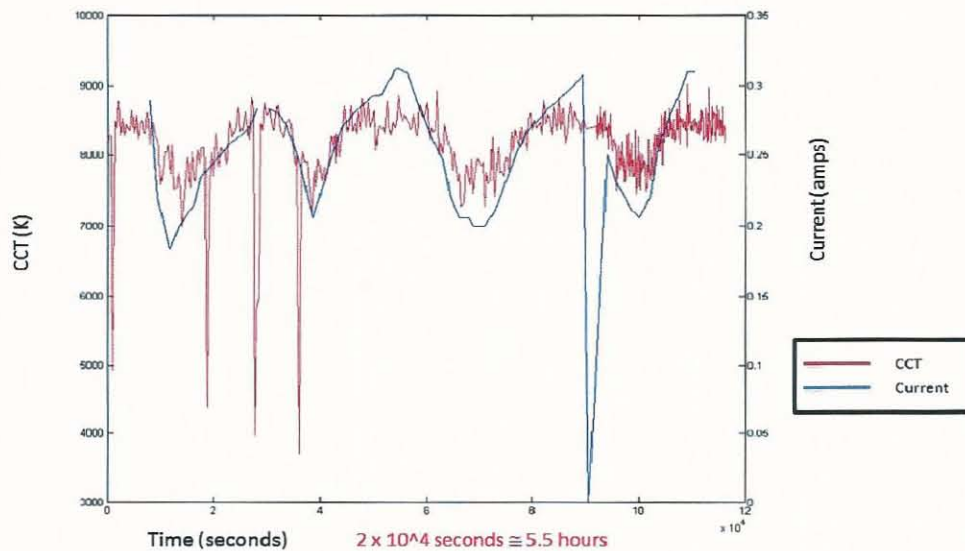

Figure 22 Color Temperature and Current vs. Time Plot

Figure 23 shows Imaging Colorimeter data captured by the Colorimeter Meter during the thermal cycling. The luminance of the display varied approximately from 155 cd/m² during the hot cycle to 80 cd/m² during the cold cycle—an approximate 50% reduction in luminance. For the most part, the AMOLED maintained uniformity though the center. The right side had a slightly higher luminance than the left.

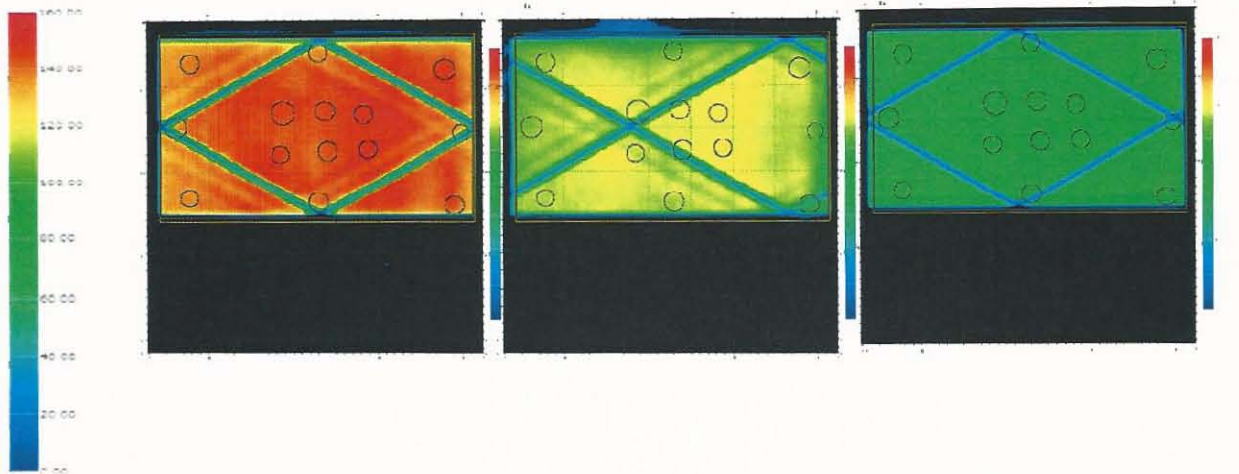

Figure 23 Imaging Colorimeter Data --Luminance

Figure 24 shows the Spectral Irradiance vs. time plot. Note the blue and green spectrum of the display intensity is more impacted by temperature change than the red. This may have contributed to the shift in color temperature between 7000K and 9000K.

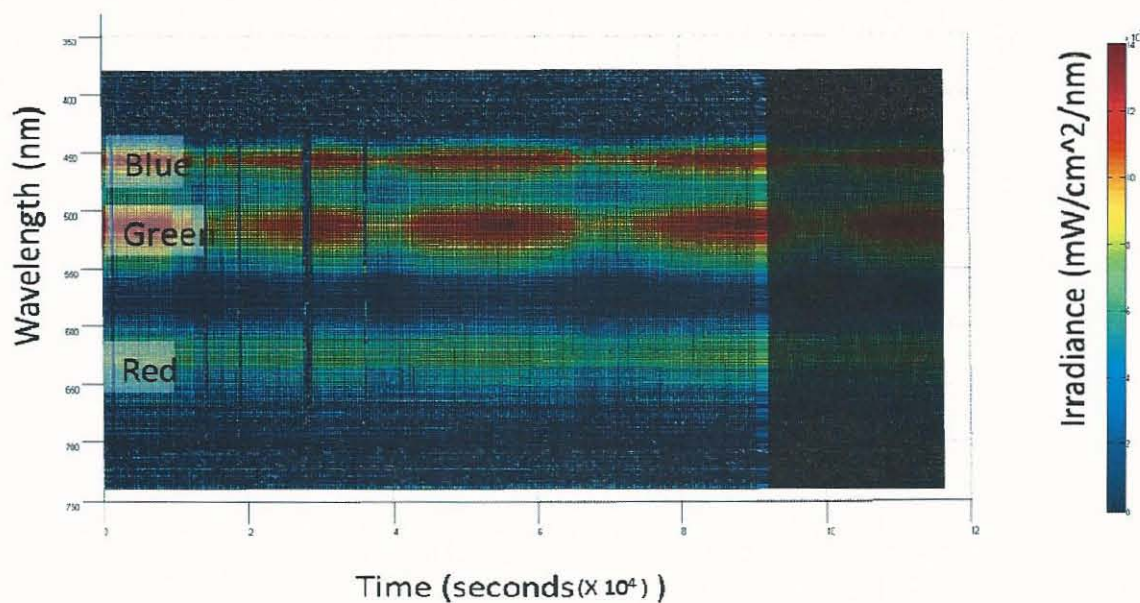

Figure 24 Spectral Irradiance vs. time Plot

The depressurization test did not affect the performance of the display. By taking it down to vacuum, the test results suggest that the AMOLED could be suitable for external habitat operations such as extra vehicle activities (EVA) provided that the temperature of the display is maintained to keep the display luminance constant.

Pre and post characterization showed no permanent degradation of the display. Luminance, CCT, Chromaticity, and CRI all showed virtually no change pre and post testing. However, during the thermal cycle testing, these parameters were affected, particularly the luminance and the CCT.

In summary, the AMOLED display survived all the thermal testing. Pressure changes did not seem to affect the performance of the display. However, the device is sensitive to the thermal environment. The extreme cold and hot cycles affect the current draw of the display. In turn, the current draw affected the optical characteristics of the display. Shifts in the CCT were noted. Luminance and irradiance properties of the display were directly proportional to the current draw. The primary white background display with the moving black X pattern exercised a large number of the pixels. Spectral Irradiance data indicated that blue and green pixels were more impacted by the temperature change, and thus the current, than the red pixels.

5.3 Radiation

5.3.1 Test Description

Overview

The AMOLED radiation test was performed at the Indiana University Cyclotron Facility (IUCF). The radiation test assessed the susceptibility of the AMOLED technology to the effects of the ionizing radiation environment equivalent to that found in low earth orbit (LEO). Figure 25 shows the test setup for the AMOLED radiation testing. The distance from the chamber room where the beam was located to the control room was approximately seventy feet. Hence, all cabling connecting the equipment between both rooms was purchased or built to one hundred feet length.

The AMOLED and Ethernet-controlled pan/tilt camera was located in the chamber. The purpose of the pan/tilt camera in the chamber room was to remotely view the AMOLED display in the control room via a display monitor for anomalies as it was subjected to the radiation beam. In the control room, the power supply provided power to the AMOLED unit.

The power supply had both current limiting and voltage sensing capability. It ensured +12 VDC was supplied to the AMOLED and the maximum display current in the event of a latch up during the test was limited. The laptop in the control room sent the "moving X" pattern to the AMOLED via the 100 foot VGA cable. In addition, the laptop controlled the pan/tilt camera via an Ethernet connection. An HD camera was used to record the AMOLED display image sent back to the control room from the pan/tilt camera.

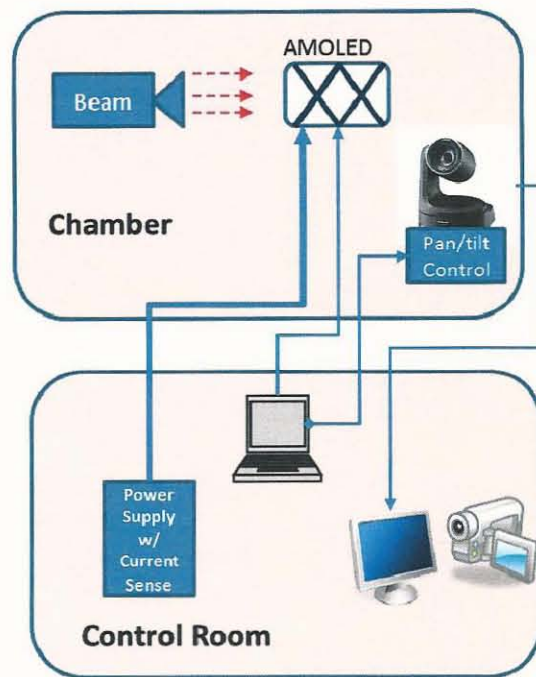

Figure 25 AMOLED Radiation Test Setup

Since the display and its associated driver electronics were designed for commercial applications and not for space, every effort was made to expose the display (the intended target) and to protect the electronics from the radiation beam. Figure 26 shows the AMOLED in the chamber prior to start of the testing. The AMOLED was placed on a two-axis motorized table to permit adjusting the position of the device relative to the beam. Figure 27 shows a close-up of the AMOLED and the radiation protection of the VDB and column drivers using the lead brick. After initial radiation issues with the pan/tilt camera, the unit was also protected from the radiation beam using boron-impregnated plastic boards as shown in figure 28. The integrated row drivers were not protected (see figure 4 for location of the row drivers.)

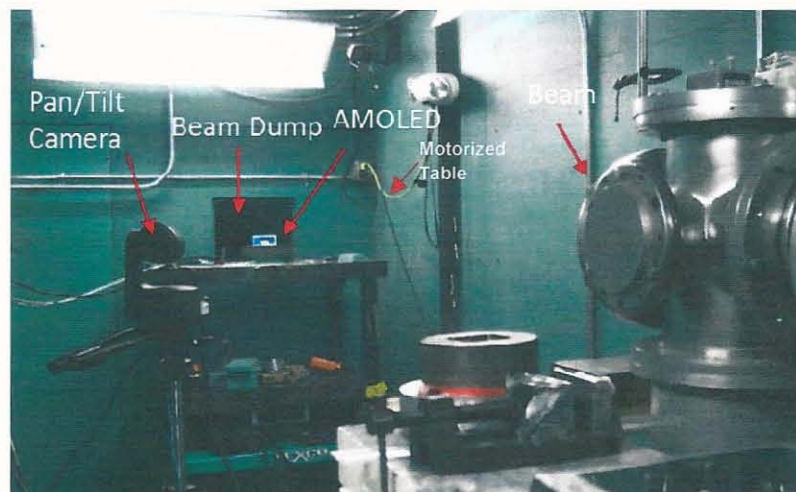

Figure 26 AMOLED Radiation Setup in the Chamber

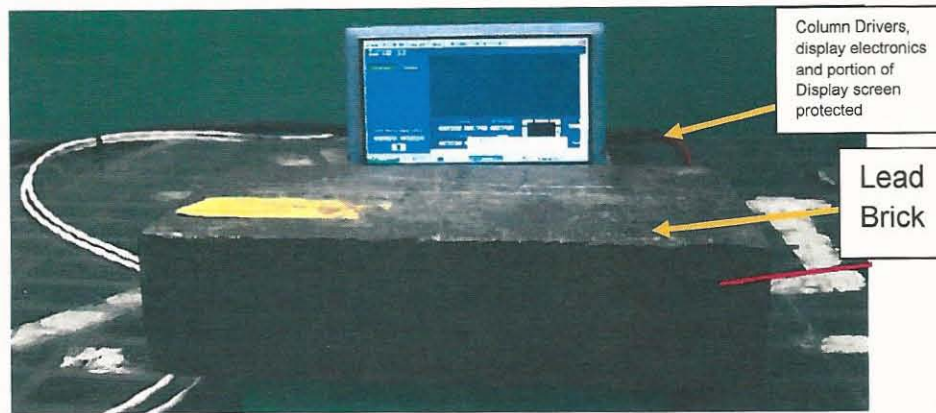

Figure 27 AMOLED with Radiation Shielding

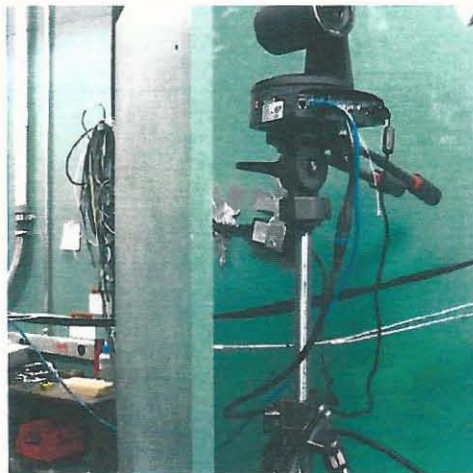

Figure 28 Shielded Pan/Tilt Camera

Radiation Test Approach

The radiation test determined the AMOLED display's susceptibility to the radiation environment for a typical spacecraft such as the International Space Station (ISS) orbiting at 51.6-57 degree inclination at 270 nautical miles with a 0.1 inch thick spherical aluminum shielding for quiet conditions and no earth shadow assumed.

The testing was done on one unit (AMOLED-non touch) using the IUCF proton beam energy of approximately 200 mega-electron-volts (MeV). The beam diameter along with the various copper vignettes and AMOLED location in the chamber ensured that the whole exposed display was radiated uniformly. Also, only one beam position was required for this test.

The AMOLED was exposed to a minimum fluence of $1.0 \text{ E}+10$ protons/cm² which equates to 600 rads (SI)—standard radiation exposure for hardware destined for inside the ISS pressurized module. While the beam was on, the AMOLED was operating and running the “moving X” program. The beam would be stopped when either an anomaly was detected via the control room display, power supply current limiting engaged, or when the fluence reached $1\text{E}+10$ protons/cm² which takes about 3-4 minutes from start of the beam. If 600 rads (SI) is reached without issues, then, the test proceeds to a total dose of 6 Krad (SI) which is associated with EVA environment for ten years.

Optical characterization of the AMOLED was taken prior to and after the radiation test. Table 3 shows the results of the characterization.

Table 3 Characterization Before and After Radiation Test

Radiation Testing	Before	After
Average Luminance cd/m²	149	65
CCT (K)	8674	10164
Chromaticity (x,y)	0.273	0.263
	0.340	0.316
CRI	81	78

5.3.2 Radiation Test Results

The AMOLED started the test drawing 0.25 amps of current. It easily withstood 600 rads (SI) without any detected anomalies. At 1.1 Krads, the current had dropped to 0.23 amps but still no noted issues were detected on the display. At 4.6 Krads, the display current had dropped to 0.178 amps. The beam was stopped when it reached 6 Krads. However, at 6 Krads, the current had dropped to 0.16 amps. Though there were no observable errors on the display, there was a visible change in the AMOLED screen brightness. The following day of the test, a measure of the current was again taken and the current had dropped even further to 0.15 amps.

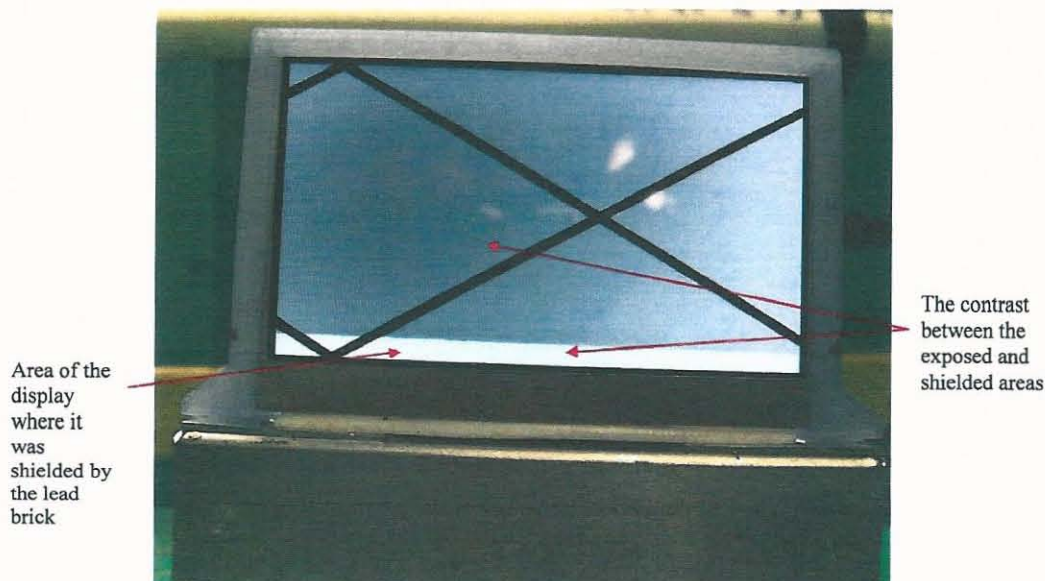

Figure 29 AMOLED Screen 24 Hours Later

The portion of the screen that was covered by the brick to protect the column drivers was not damaged and remained as bright as before the test. Figure 29 shows the display the next day after the test. The unit was returned to JSC about a month later with the same results. A point of interest is that the row drivers located on the left of the display screen were not protected from radiation. The decrease in current and the darker screen suggest that there was damage to the TFTs on the display. Note that the darkening of the glass also occurred when another unit

similar to this display and from the same manufacturer was tested in 2009 (RTR-FF-08-003, Revision A, January 22, 2009) by Honeywell International. However, the report did indicate that the dark areas disappeared over time. Still, in another radiation test performed on an OLED display (JSC 66459, Samsung Galaxy), beyond 600 rad(SI) the display colors began to change—no report of a darken screen. A power cycle was able to return the display to the correct colors.

Another anomaly that occurred during the testing impacted the pan/tilt camera located in the chamber. When the beam turned on, immediately the video from the camera showed speckles before shutting down. Each time, power to the camera had to be recycled to regain control of the camera. This occurred twice before it was decided to shield the pan/tilt camera behind boron impregnated plastic. Afterwards, there were no more issues with the camera.

Optical characterization of the display before and after clearly shows the permanent degradation of the display—particularly in the luminance as well as the CCT parameters.

6.0 Conclusion

The AMOLED display performed well in EMI testing with the display meeting RE102 limits as well as not experiencing any issues when subjected to the modified ISS RS03 testing at 25, 50, and 75 V/M. It should be noted that for ISS, the display would be suitable, from an EMI standpoint, for use inside the pressurized area. However, for other spacecrafts with different EMI requirements, it is recommended that the AMOLED display be tested to those environments.

For the thermal vacuum testing, the optical performance data suggests that there was temporary degradation in the optical display performance during environment temperature changes but not any permanent damage. Its performance is not affected by pressure changes. However, the testing did show its sensitivity to thermal changes for both the cold and hot cycle. As the temperature drops, the current draw of the display drops resulting in a decrease in luminance output by as much as 50%. This can be problematic for EVA applications unless display heaters are used. Similarly, as the temperature increased, current increased resulting in the luminance output increasing. A shift in the CCT from 7000K to 9000K was noted through Colorimeter Meter data that was captured. This may have been attributed to the green and blue pixels having a direct response to the change in current. The red pixels seemed unaffected. This can be problematic for display applications that use color in the screen for situational awareness alerts. Compensating the display drive voltages for the ambient temperature for the red, green and blue pixels independently can solve the temperature sensitivity issue (without the need for controlling the display temperature).

The radiation test showed that the AMOLED performed well up to the radiation total dose for inside the ISS in LEO of 600 rads (SI). Beyond the 600 rads (SI), the screen began to experience total dose permanent damage noted by the drop in current and the darkened screen possibly attributed to damaged pixels and/or damaged TFTs. Therefore, for inside a spacecraft that does not expect to see a total dose of more than 600 rads (SI) for the life of the mission, an AMOLED such as the one tested would be suitable. If an AMOLED display is to be used for external applications such as EVAs, additional AMOLED displays (as replacements) may be required if the total dose begins to exceed 600 rads (SI). It is recommended to test candidate AMOLED displays for total dose for the intended space application and assess how much total dose begins to affect the display. Finally, given that other OLED displays experienced different display issues beyond 600 rad (SI) than this AMOLED, it is highly recommended to understand what was different in the manufacturing of those displays compared to the one tested for this report.

Appendix A - Acronyms and Abbreviations

Acronym	Definition
AMOLED	Active Matrix Organic Light Emitting Diode
CCT	Correlated Color Temperature
DARCS	Data Acquisition and Recording Control system
EFI	Electric Field Intensity
EMI	Electromagnetic Interference
HI	Honeywell International
ISS	International Space Station
IUCF	Indiana University Cyclotron Facility
LCD	Liquid Crystal Display
LED	Light Emitting Diode
LEO	Low Earth Orbit
LISN	Line Impedance Stabilization Network
MTBF	Meantime Between Failure
MeV	Mega-electron-Volts
Mil STD	Military Standard
OLED	Organic Light Emitting Diode
PSIA	Pounds per Square Inch Absolute
RS	Radiated Susceptibility
SI	Silicon
TC	Thermal Couple
TFT	Thin Film Transistor
Vac	Vacuum
VDB	Video Decoder Board
V/M	Volts per Meter
VGA	Video Graphics Array