



The Road to Realizing In-space Manufacturing

Characterize → Certify → Institutionalize → Design for AM

**Presented to National Research Council
Committee on Space-Based Manufacturing of Space Hardware**

February 6, 2014

R. G. Clinton, Jr.
Deputy Director
Science and Technology Office
NASA Marshall Space Flight Center

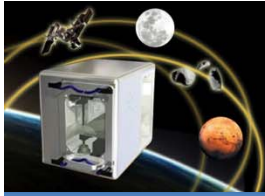

Agenda



1.

NASA Vision: Setting the Stage

- Dr. Mason Peck – The Vision
- Dr. Michael Gazarik – Advanced Manufacturing Criticality to NASA
- Dr. LaNetra Tate – Space Technology IN-Space Manufacturing

2.

Roadmap

3.

We Are Here

4.

The Road Ahead

- Characterize
- Certify
- Institutionalize
- Design for AM

5.

What Could Be

- Stronger types of extrusion materials for multiple uses including metals & various plastics
- Recycler Demo: recycle plastic
- Printable Electronics Tech Demo
- Smallsat Build & Deploy

- Provision some feedstock
- Evolve to utilizing in situ materials (natural resources, synthetic biology)
- Product: Ability to produce multiple spares, parts, tools, etc. "living off the land"
- Autonomous final milling to specification

3D Print Tech Demo
2014

Design for AM

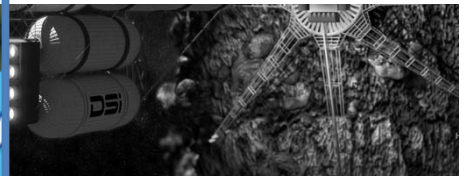

Bridging Technology Development to Full Implementation of this is the right one for taking the very first step toward manufacturing.



Massless Exploration



- Enable new Mission Architectures
- Encourage advanced design methods
- Modernize fabrication instruction development
- Local Resource Mining / Space Mining / Resource Acquisition/ Prospecting
- In-Situ materials processing/refining
- Advanced, Autonomous Fabrication & Construction
- Applications/ Utilization/ Infusion

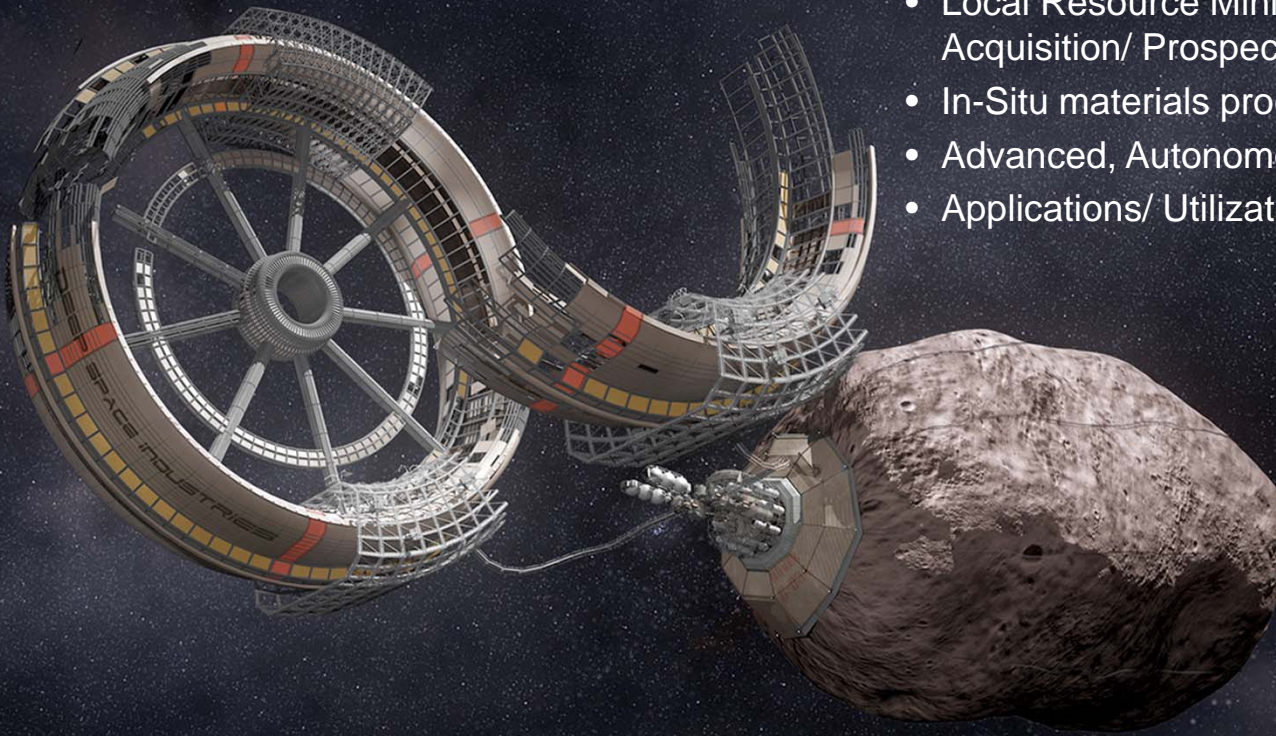

DSITM
DEEP SPACE INDUSTRIES
SETTLEMENT CONCEPT
BRYAN VERSTEEG
DEEPSPACEINDUSTRIES.COM



NASA Advanced Manufacturing Technology



Large Scale Composite Fiber Placement Machine – Composite Cryotanks



NASA and General Motors – Robot Development



Composite Crew Module Pressure Vessel



In-Space Additive Manufacturing

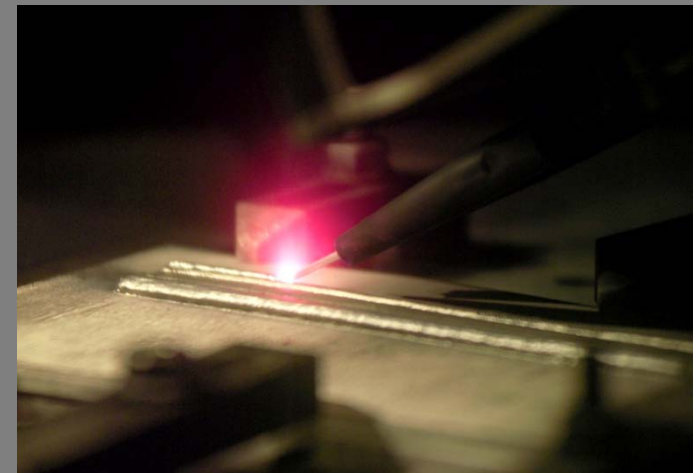

Electron Beam Freeform Fabrication

Advanced Manufacturing is Critical to All Mission Areas



NASA Advanced Manufacturing Technology



- ISS Platform**
- In-space Fab & Repair Plastics Demonstration via 3D Printing in Zero-G
 - Qualification/Inspection of On-orbit Parts using Optical Scanner
 - Printable SmallSat Technologies
 - On-orbit Plastic Feedstock Recycling Demonstration
 - In-space Metals Manufacturing Process Demonstration



ISS-based



Planetary Surfaces

- Planetary Surfaces Platform**
- In-situ Feedstock Test Beds and Reduced Gravity Flights Which Directly Support Technology Advancements for Asteroid Manufacturing as well as Future Deep Space Missions.
- Additive Construction
 - Regolith Materials Development & Test
 - Synthetic Biology: Engineer and Characterize Bio-Feedstock Materials & Processes

- Earth-based Platform**
- Certification & Inspection of Parts Produced In-space
 - In-space Metals Fabrication Independent Assessment & NASA Systems Trade Study



Earth-based

- Earth-based Platform (cont.)**
- Printable Electronics & Spacecraft
 - Self-Replicating/Repairing Machines
 - In-situ Feedstock Development & Test: See Asteroid Platform

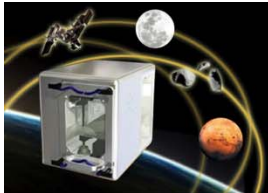

NASA In-space Manufacturing Technology Development Vision



WE ARE HERE!

3D Print Tech Demo



<i>Metal Printing</i>	<i>Printable Electronics</i>	<i>Add Mfctr. Facility</i>
<i>Optical Scanner</i>	<i>SmallSats</i>	<i>Self-repair/replicate</i>
	<i>Recycler</i>	

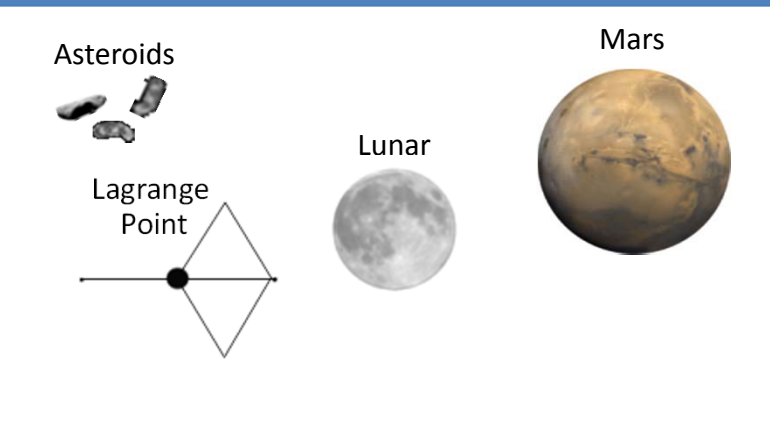

Pre-2012

2014

2015 2016 2017 2018

2020-25

2025

2030 - 40

- Ground & Parabolic centric:*
- Multiple FDM Zero-G parabolic flights
 - Trade/System Studies for Metals
 - Ground-based Printable Electronics/Spacecraft
 - Verification & Certification Processes under development
 - Materials Database
 - Cubesat Design & Development

- **POC 3D Print: First Plastic Printer on ISS Tech Demo**
- **NIAC Contour Crafting**
- **NIAC Printable Spacecraft**
- **Small Sat in a Day**
- **NRC Study**
- **Center In-house work in additive, synbio, ISRU, robotics**

- Next Generation 3DPrint
 - SmallSat in a Day ISS Demo
 - Recycler Demo: recycle plastic
- ISS: Utilization/Facility Focus**
- Integrated Facility Systems for stronger types of extrusion materials for multiple uses including metals & various plastics
 - Printable Electronics Tech Demo
 - SmallSat Build & Deploy

- Lunar, Lagrange FabLabs*
- Initial Robotic/Remote Missions
 - Provision some feedstock
 - Evolve to utilizing in situ materials (natural resources, synthetic biology)
 - Product: Ability to produce multiple spares, parts, tools, etc. "living off the land"
 - Autonomous final milling to

- Planetary Surfaces Points Fab*
- Transport vehicle and sites would need Fab capability
 - Additive Construction

- Mars Multi-Material Fab Lab*
- Utilize in situ resources for feedstock
 - Build various items from multiple types of materials (metal, plastic, composite, ceramic, etc.)
 - Product: Fab Lab providing self-sustainment at remote destination

ISS Technology Demonstrations are Key in 'Bridging' Technology Development to Full Implementation of this Critical Exploration Technology. We believe this design is the right one for taking the very first step toward manufacturing in space!

All dates and plans beyond 2014 are notional and do not imply planned investments



We Are Here – ISS Tech Demo



Microgravity Research



3D Print Ground Testing

The 3D Print project will deliver the first 3D printer on the ISS and will investigate the effects of consistent microgravity on melt deposition additive manufacturing by printing parts in space.

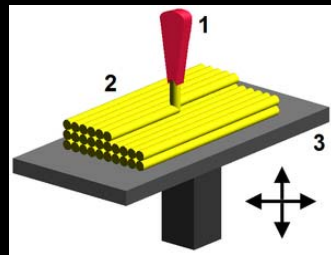

- Melt deposition modeling:
- 1) nozzle ejecting molten plastic,
 - 2) deposited material (modeled part),
 - 3) controlled movable table

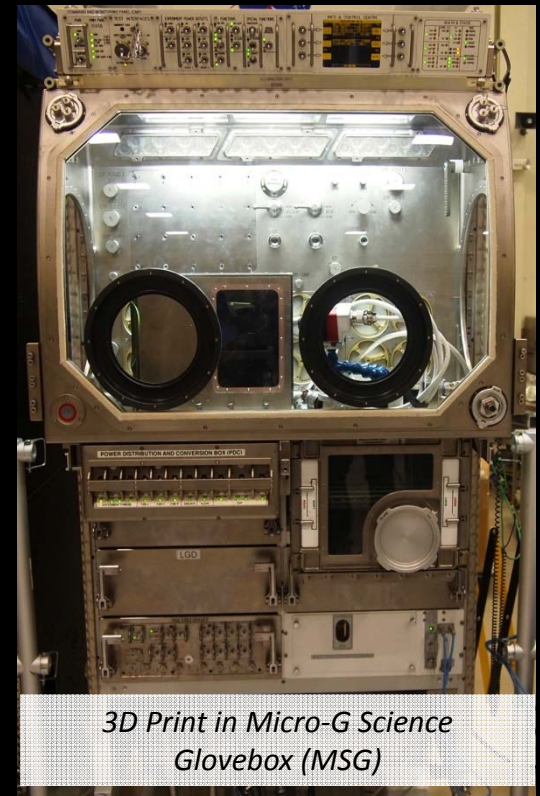

3D Print in Micro-G Science Glovebox (MSG)

Potential Mission Accessories



3D Print Specifications	
Dimensions	33 cm x 30 cm x 36 cm
Print Volume	6 cm x 12 cm x 6 cm
Mass	20 kg (w/out packing material or spares)
Est. Accuracy	95 %
Resolution	.35 mm
Maximum Power	176W (draw from MSG)
Software	MIS SliceR
Traverse	Linear Guide Rail
Feedstock	ABS Plastic



**THE FIRST
3D PRINTER
IN SPACE**



Potential Parts for ISS 3D Print Technology Demonstration



Crew Tools/Parts

- Crowfoot, 3/8" drive, 19mm (IVA)
- Hex head socket, 3/4" (IVA)
- Wrench, combination, metric, 6pt, 14mm (Uplink)
- Sample container
- Wrench, combination, metric, 12pt, 10mm
- Socket drive, 3/8" drive
- Feeler gauge set (26 gauges)
- Hex driver, 3/8" drive, 5/32" hex
- Bolt, 9/16", hex (SDG52102486-001)



Mechanical Property Test Articles

- Flexure test article
- Compression test article
- Tensile test article
- Torque test article

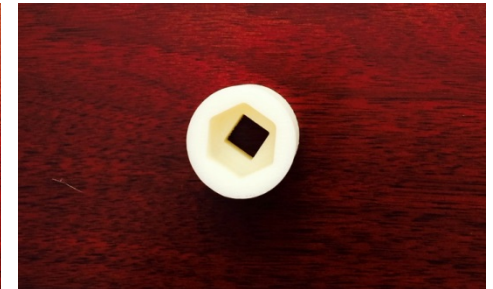

Geometric/Performance Verification

- Range coupon
- Vertical column

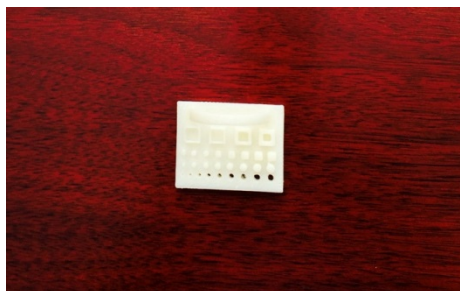



Astronaut Office Printer Demo 1/29/14



- **Crew Members:**

- Dan Burbank – MS Aeronautical Science, Embry-Riddle Aeronautical University, Crew EVA Robotics Branch Chief, STS-106, STS-115, Expedition 29/30
- Tracy Caldwell Dyson – PhD in Chemistry, UC Davis, STS-118, Expedition 23/24 crew
- Cady Coleman – PhD in Polymer Science and Engineering, U of MA, STS-73, STS-93, Expedition 26/27 crew.
- Jeanette Epps – PhD Aerospace Eng. U of Maryland, Selected in 2009 and has completed AsCan Training
- Drew Feustal – PhD Geological Sciences, Queen’s University, Kingston, Ontario, Canada, SYS-125 (Hubble Repair Mission), STS-134
- Jeremy Hansen – CSA Astronaut, Major, Canadian Royal Air Force, MS Physics, Royal Military College, Kingston, Ontario, Canada, Crew support for Expedition 34/35
- Shane Kimbrough – Col. US Army, MS Operations Research, Georgia Tech, STS-126, Verification/Integration at KSC
- Don Pettit – PhD in Chemistry, U of AZ, Expedition 6 crew, STS-126, Expedition 30/31 crew.
- Peggy Whitson – PhD Biochemistry, Rice, Expedition 5, Expedition 16
- Stephanie Wilson – MS Aerospace Engineering, Texas, STS-121, STS-120, and STS-131
- Joe Acaba – M.S. Geology, U of AZ, STS-119, Expedition 31/32 crew (Unable to attend) Interested in supporting Science Technology Engineering Math (STEM) opportunities

- **Other Participants:**

- Terrence Williams, Office of Space Operations (OSO) & Crew Systems
- Ethan Reid, NASA Systems Manager for Flight Crew Systems
- Bert Young, Flight Controller/Crew Trainer/OSO
- Kyle Brewer, OSO
- Mike Rapley, NASA Exercise Physiologist
- Mark Bowman, JSC Soyuz Integration Lead





Structured Light Scanning



Close-up of simulated MMOD Damage to External ISS Panel

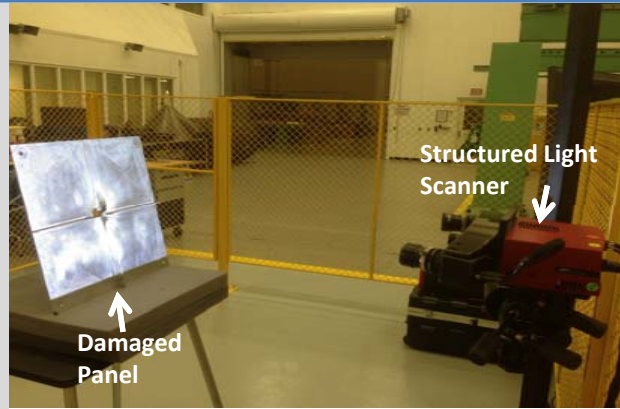

Scanning the Damaged Panel

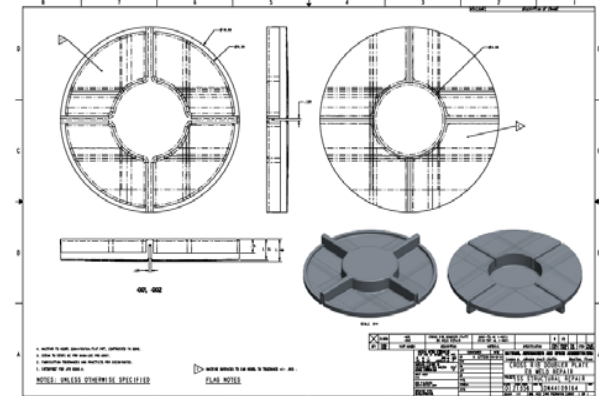

CAD for custom doubler 'patch' for damaged area

- A verification and certification process for parts additively manufactured on-orbit is needed.
- First step in establishing such a process:
 - Flight certify a CoTS Structured Light Scanner, an optical measuring technique frequently used for the characterization of the surface geometry of parts (MIS/MSFC)
 - Demonstrate scanning and geometric verification/validation on ISS for 3D Printer Technology Demonstration parts
 - Compare parts printed in space to CAD nominal and ground-based parts using quantifiable data on the accuracy of the build process and parameters
 - Verify that parts printed in space meet design specification
- Additional uses:
 - Create duplicate parts - scan original parts, create build instructions, print
 - 'Reverse Engineering' and repair of broken parts on ISS
 - Physiological measurements for crew health/human research projects
 - Any payload or experiment requiring data on geometrical changes (coatings, micro-meteoroid impacts to external experiments or components).



Recycle



Build



Original Part Printed

Recycle



Recycle printed part back into Feedstock Filament

Sustainable Reuse



Use Recycled Filament to Print new parts

- Recycling and reclaiming the feedstock is required to develop a self-sustaining, closed-loop in-space manufacturing capability
 - Less mass to launch
 - Increase “on demand” capability in space
- 2014 Phase I SBIR call entitled, “Recycling/Reclamation of 3-D Printer Plastic for Reuse” closed on 1/29/14.
- Potential transition from SBIR to ISS Technology Demonstration in conjunction with 3D Printer activities

What Could Be:

- Expand recycle/reclamation capability to include other build materials, e.g. metals
- Convert packaging (packaging material selection compatibility with manufacturing technology) and potentially trash to build materials



The Road Ahead

In-Space Additive Manufacturing

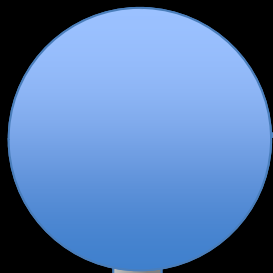

Characterize



SLM manufactured injector, mechanical property and microstructure test articles

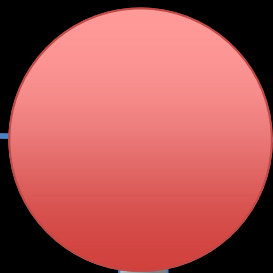

Certify

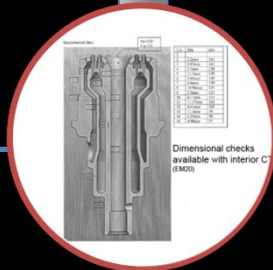

CT Scan Nondestructive Inspection and Dimensional Verification

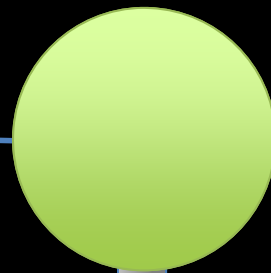

Institutionalize



Process Standards documentation for qualification/certification process

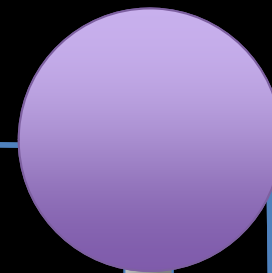

Design for AM

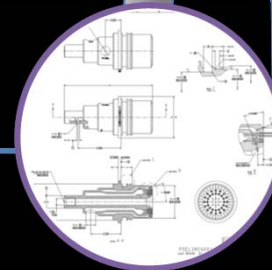

Design for Additive Manufacturing Process

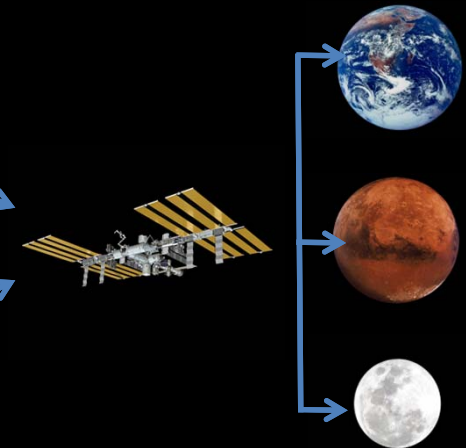

Ground-Based Additive Manufacturing of Propulsion Components

Parallel paths toward Certification of Space System Designs



Characterize



- **Materials – constituents, feedstock, components (microstructure, surface finish, etc.)**
- **Properties – full/tailored suite of physical, mechanical, thermal properties as would be required for any space qualified component**
- **Process**
 - Ground-based
 - Microgravity-based
- **Inspection processes as applied to additively manufactured parts**
- **Reuse/Recycling**
 - Contamination
 - Properties vs. Original/Virgin Feedstock
 - Qualify Verification against Feedstock Specifications

Characterization element benefits significantly from ground-based Additive Manufacturing development



Certify



- **Technical capability to print parts on-orbit must go hand-in-hand with qualification/certification process to ultimately enable production of usable parts, structures, and systems in space.**
- **Typical certification process involves one or a combination of:**
 - Test
 - Analysis
 - Similarity
- **Certify the Process - Generate process repeatability & reliability data at statistically significant levels**
 - Geometric verification/validation of parts
 - Material properties
 - Process monitoring for real time “certification” of build
 - Database of every part needed for configuration management
- **Certify the part**
 - Inspect Components
 - Test on ground and/or on orbit?
- **Certify by process similarity – how to validate process/print was performed as designed (visual monitoring, other sensors)**

Test what you fly. Fly what you test.



Institutionalize



- **Mature from lab curiosity to in-line capability**
 - Culture – awareness and acceptance of additive manufacturing technologies
 - Building block approach for development of more complex systems
 - Standardize
 - Feedstock, materials, processes, inspections, acceptance procedures
 - Configuration control
 - Life cycle management
 - Demonstrate reliability – trust the process and the part
 - Innovation – expand the application space
 - Involve astronauts, crew systems, space systems developers
 - First line implementers
- **Create standard parts catalog for ISS**
- **Go external**
 - Large and more complex systems and structures will require capabilities that operate autonomously in space
 - Development efforts can build on foundation established by Earth-based and ISS-based (pressurized volume) capabilities and characterization efforts



Design for AM





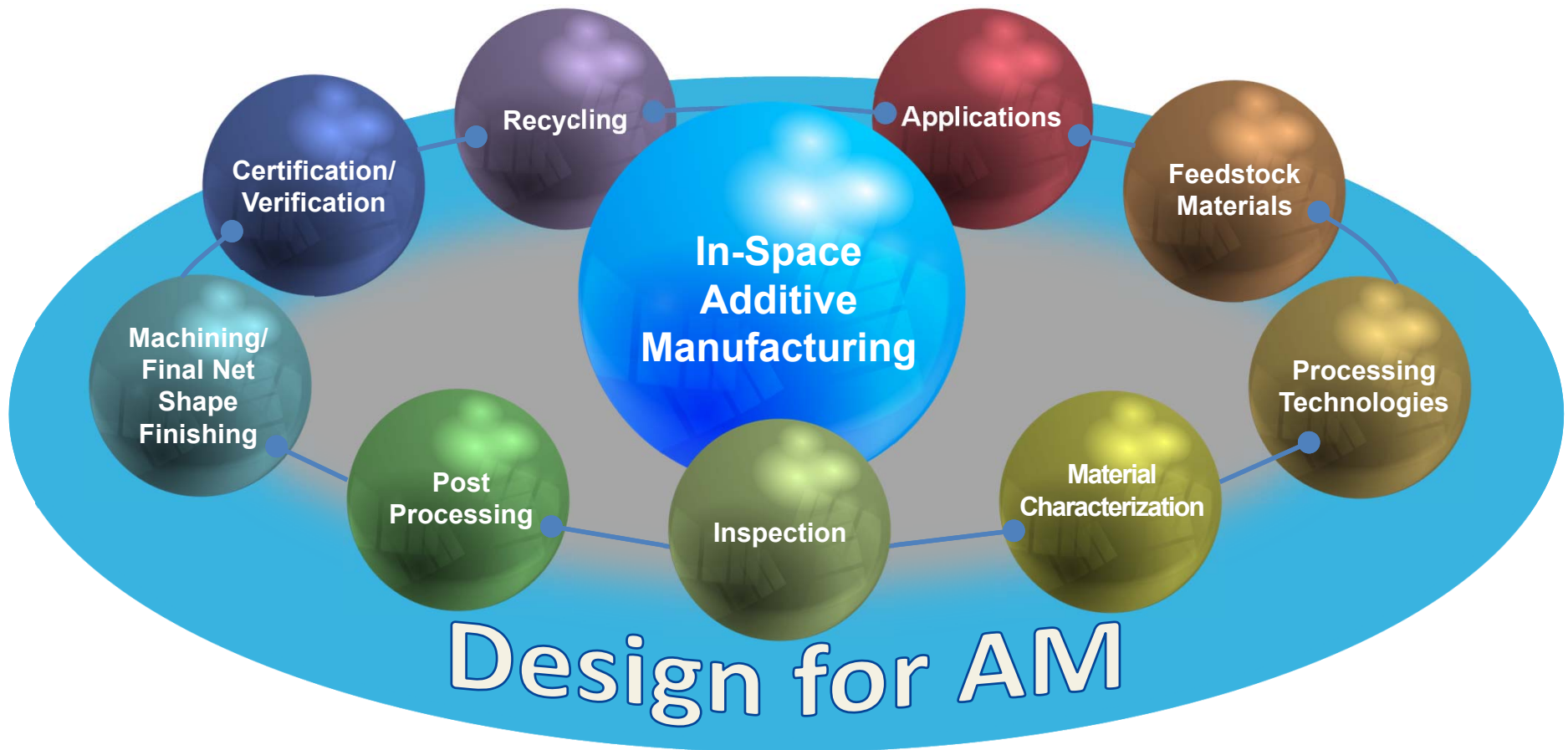

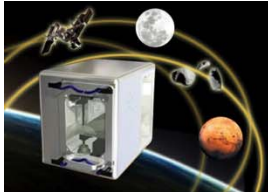
- To achieve maximum benefit and integration to the fullest extent. Additive Manufacturing (AM) must be incorporated at the Design Level - Design for AM, On-Orbit Repair and Replacement.



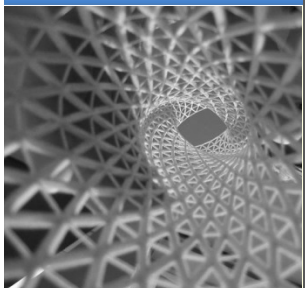
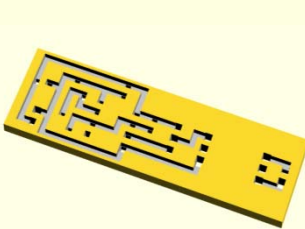
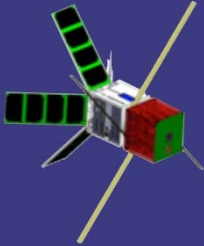

What Could Be



NON-METALS	PRINTED ELECTRONICS	PRINT-A-SAT	METALS	REPAIRS	CONTOUR CRAFTING
					
<p>Additive manufacturing using nonmetallics is the simplest solution to many on-orbit needs. An expanding suite of feedstock materials coupled with manufacturing in vacuum creates new architecture and design possibilities.</p>	<p>Leverage ground-based developments to enable in-space manufacturing of functional electronic components, sensors, and circuits. Image: <i>Courtesy of Dr. Jessica Koehne (NASA/ARC)</i></p>	<p>The combination of 3D Print coupled with Printable Electronics enables on-orbit capability to produce "on demand" satellites.</p>	<p>Additively manufacturing metallic parts in space is a desirable capability for large structures, high strength requirement components (greater than nonmetallics or composites can offer), and repairs. NASA is evaluating various technologies for such applications. Image: <i>Manufacturing Establishment website</i></p>	<p>Astronauts will perform repairs on tools, components, and structures in space using structured light scanning to create digital model of damage and AM technologies such as 3D Print and metallic manufacturing technologies (e.g. E-beam welding, ultrasonic welding, EBF3) to perform the repair. Image: NASA</p>	<p>Contour Crafting Simulation Plan for Lunar Settlement Infrastructure Build-Up B. Khoshnevis, USC</p>  <p>Illustration of a lunar habitat, constructed using the Moon's soil and a 3D printer. Credit: Foster+Partners</p>

Characterize → Certify → Institutionalize → Design for AM

Non-Metals



- **ABS plastic will be used for initial Additive Manufactured demonstration articles on ISS**
- **Other nonmetallic materials, currently being utilized/developed for ground-based printers are candidates for ISS evaluation/applications**
 - Ultem 9085 high strength thermoplastic
 - Carbon fiber reinforced WINDFORM XT
 - Other polymer matrix composites, e.g. UTEP developments
- **Conductive Polymers**
 - Build circuits into structure
 - Build sensors, antennas, customized heat exchangers
- **Cubesat structures**
- **Go external**
 - ISS Technology Demonstration for automated external additive manufacturing
 - Free-flying platforms for autonomous manufacturing of on-demand cubesats



Above: Tools • Below: Spares/Standard Hardware

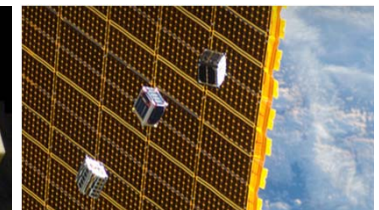
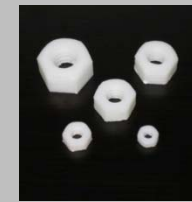

Left: Printed Cubesat structural elements
Right: Cubesats deployed from ISS

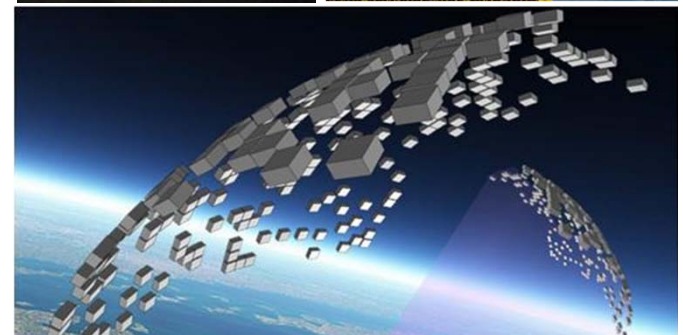

Cubesat swarm from Autonomous Manufacturing Platform

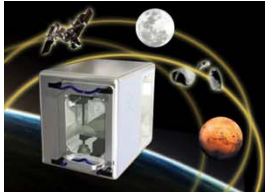

Printable Electronics

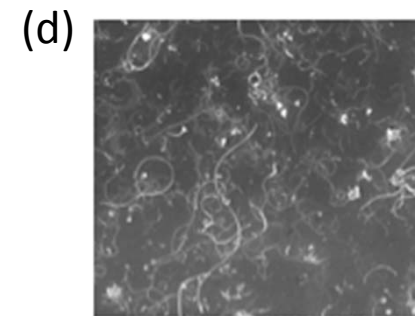
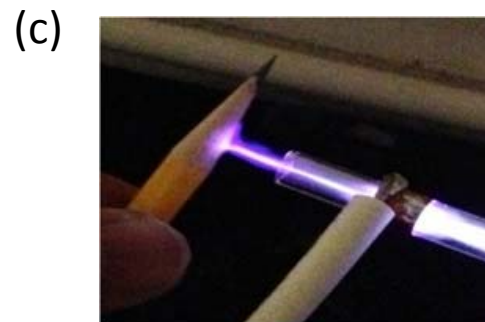
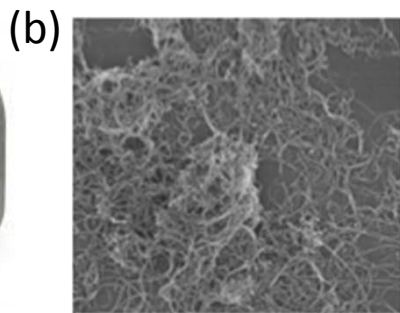
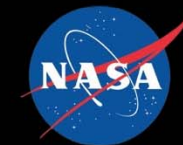

(a) **Dimatix piezoelectric inkjet printer** (b) CNT ink spot by drop casting showing CNT aggregation (c) **Single jet plasma system** (d) spot of CNT ink by plasma jet showing even, conformal deposition and no aggregation

- **Develop in-space manufacturing capabilities to produce functional electronic and photonic components on demand.**
- **Printable inexpensive functional electrical devices is a rapidly evolving field**
 - substrates include plastic, glass, silicon wafer, transparent or stretchable polymer, and cellulose paper, textiles
 - Various inks with surfactants for stability are emerging (carbon nanotubes, silver, gold, titanium dioxide, silicon dioxide)
- **Take the first step towards printing electronics on-demand in space – building block approach**
 - Select, develop and characterize inks for electronics printing
 - Development and fabrication of electronic printer
 - Demonstrate circuit blocks
- **Fly a Technology Demonstration on ISS to build some functional electronic/ photonic circuits, sensors, electrodes, displays, etc.**
- Mature on-orbit capability to print-on-demand. Parts are printed from computer aided design (CAD) models which can be pre-loaded or uplinked from Earth

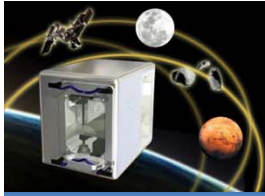

Print A Sat Project

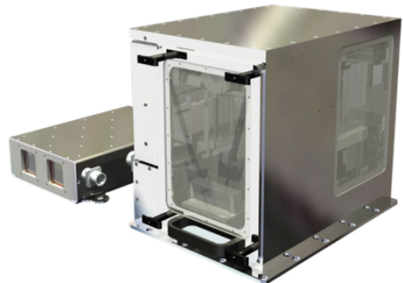

Print ChipSat Structure
On ISS using 3D Print

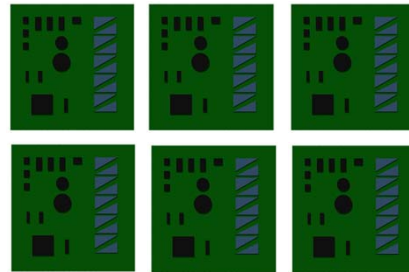

Launch Six Unique ChipSats Printed
on the Ground by ARC & JPL



First 100% Printed Cubesat to
be Printed in space using
printable electronics

- **Develop the capability to additively manufacture a Cubesat in space which incorporates proof-of-concept for printable electronics**
- **Interest across NASA, DoD, DARPA, Commercial, and Academia**
- **First step:**
 - Print Cubesat's structural supports using 3D Print ISS Tech Demo On-orbit
 - Print ChipSats on ground and launch to ISS
 - Deploy from ISS to demonstrate Printable Spacecraft proof-of-concept
- **Next steps**
 - Develop capability to print electronics on ISS
 - Enable "science on demand" or "observations on demand"
 - Establish pathfinder for commercial model of in-space Cubesat production on ISS

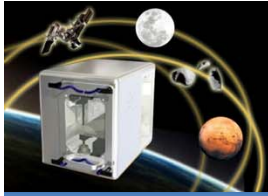

Metals



- **NASA/MSFC contracted with Wohlers Associates to perform independent assessment of mainstream and novel metals AM technologies for in space applications**
 - Ten (10) Selection Criteria identified including: microgravity; working in a vacuum; post-processing requirements; material form, use, recyclability, and disposal.
 - Nine (9) AM technologies for evaluation identified
 - Crowd sourcing with social media
 - Interviews with AM experts
 - Discussions with Aerospace leaders such as Made In Space, Langley Research Center; and ESA
 - Approach to evaluation identified
- **Final Report due June 30, 2014**
- **NASA Space Technology Mission Directorate tasked LaRC to conduct systems analyses of Metals AM technologies to support 2015 selection for ISS tech demonstration**

**Electron beam
freeform fabrication**

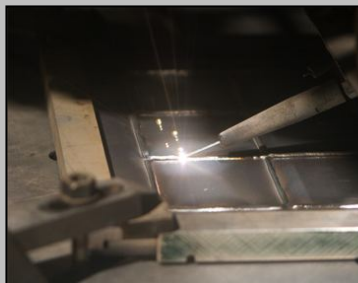

Courtesy of NASA

**Laser-engineered
net shaping**

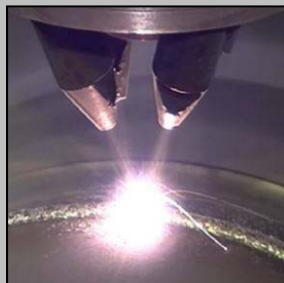

Courtesy of Optomec

**Electron beam
melting**

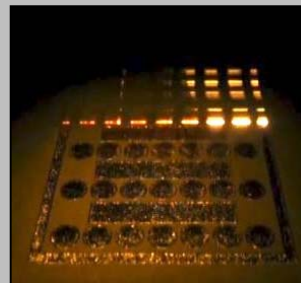

Courtesy of Sirris

**Microgravity
Casting Process**



Courtesy of Made In Space

Status
Courtesy
of





Repairs

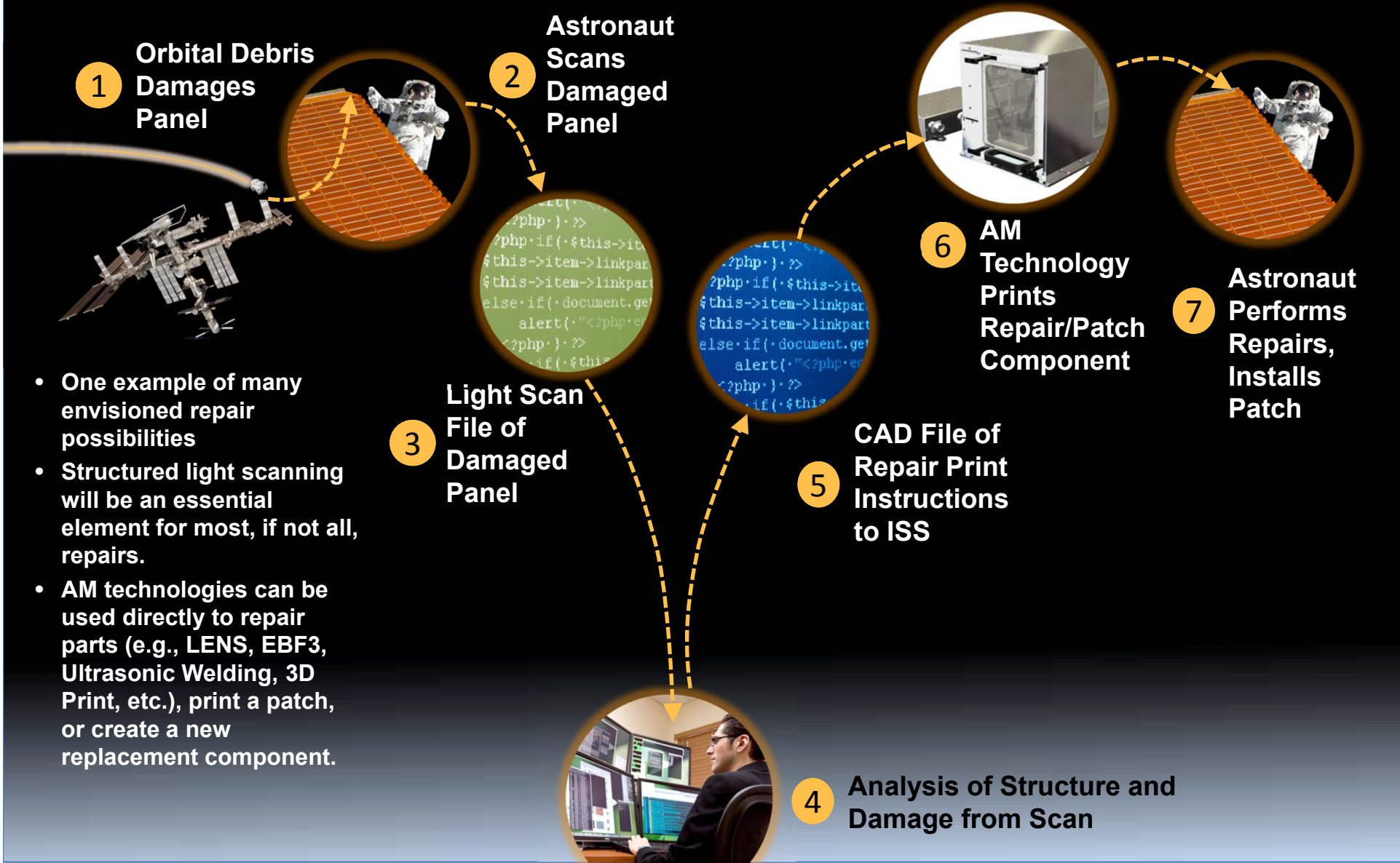



Contour Crafting



- An expanded technology (developed at the University of Southern California) for robotic and autonomous construction; allows for versatile design options & construction materials
- Current capabilities (at USC and MSFC) are for small structures only
- Current R&T efforts to improve TRL and space and terrestrial applicability (NIAC)
- Large-scale demonstration of the new technology will be proposed in conjunction with US Army's Corps of Engineers in FY15
- Terrestrial applications for forward operating bases construction capability for military; for rapid, disaster relief efforts (FEMA); and low cost housing for developing countries
- Space applications focusing on remote lunar base construction, MMOD and radiation protection solutions

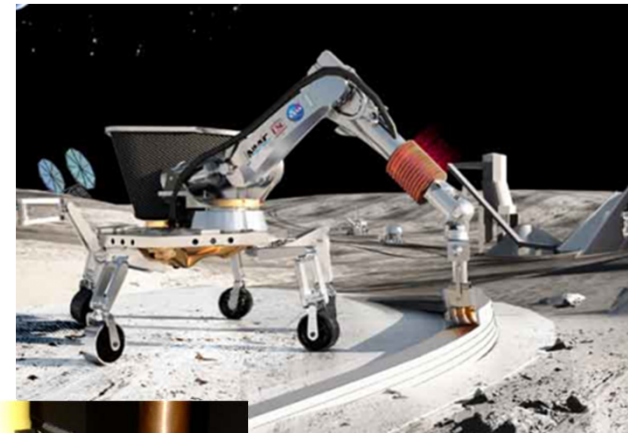

Lunar base construction

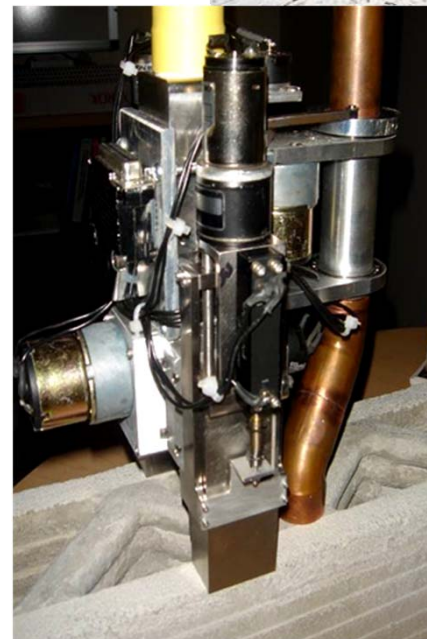

CC nozzle with corrugated wall



MSFC Demonstration



Summary



- **Additive Manufacturing in space offers tremendous potential for dramatic paradigm shift in the development and manufacturing of space architectures**
- **Additive Manufacturing in space offers the potential for mission safety risk reduction for low Earth orbit and deep space exploration; new paradigms for maintenance, repair, and logistics.**
- **Leverage ground-based technology developments, process characterization, and material properties databases**
- **Investments are required primarily in the microgravity environment.**
- **We must do the foundational work. It's not sexy, but it is required.**
 - **Characterize**
 - **Certify**
 - **Institutionalize**
 - **Design for AM**
- **What Could Be – is limited only by the imagination (and funding)**
- **“What will we build? We will build EVERYTHING” – Astronaut Don Pettit**



For more information please contact:

R. G. Clinton, Jr.
raymond.g.clinton@nasa.gov

