

# FURTHER INVESTIGATION INTO THE USE OF LASER SURFACE PREPARATION OF Ti-6Al-4V ALLOY FOR ADHESIVE BONDING

Frank L. Palmieri<sup>\*</sup>, Allison Crow<sup>†</sup>, Anna Zetterberg<sup>†</sup>, John Hopkins<sup>\*</sup>, Christopher J. Wohl<sup>\*</sup>, John W. Connell<sup>\*</sup>, Marcus A. (Tony) Belcher<sup>‡</sup>, and Kay Y. Blohowiak<sup>‡</sup>

<sup>\*</sup>NASA Langley Research Center, Hampton, VA 2368-2199

<sup>†</sup>NASA Langley Aerospace Research Summer Scholars, Hampton, VA 2368-2199

<sup>‡</sup>The Boeing Company, Seattle, WA 98124-2207

## ABSTRACT

Adhesive bonding offers many advantages over mechanical fastening, but requires robust materials and processing methodologies before it can be incorporated in primary structures for aerospace applications. Surface preparation is widely recognized as one of the key steps to producing robust and predictable bonds. This report documents an ongoing investigation of a surface preparation technique based on Nd:YAG laser ablation as a replacement for the chemical etch and/or abrasive processes currently applied to Ti-6Al-4V alloys. Laser ablation imparts both topographical and chemical changes to a surface that can lead to increased bond durability. A laser based process provides an alternative to chemical-immersion, manual abrasion, and grit blast process steps which are expensive, hazardous, environmentally unfriendly, and less precise. In addition, laser ablation is amenable to process automation, which can improve reproducibility to meet quality standards for surface preparation. An update on work involving adhesive property testing, surface characterization, surface stability, and the effect of laser surface treatment on fatigue behavior is presented. Based on the tests conducted, laser surface treatment is a viable replacement for the immersion chemical surface treatment processes. Testing also showed that the fatigue behavior of the Ti-6Al-4V alloy is comparable for surfaces treated with either laser ablation or chemical surface treatment.

## 1. INTRODUCTION

Aircraft manufacturers rely on adhesive bonds to simplify airframe design and improve aircraft performance. Adhesively bonded joints are an aerodynamic, inexpensive, lightweight alternative to their mechanically fastened counterparts, but a lack of sufficient process reliability and a means of assessing bond strength limit widespread application.<sup>1,2</sup> Deviations in bondline performance can often be attributed to variability in surface preparation using manual techniques.<sup>3,4</sup> New surface preparation methods, which promise to improve repeatability, minimize waste, and reduce costs, are under evaluation by aircraft manufacturers. Laser ablation is a high fidelity, automated technique amenable for surface preparation. Preliminary studies comparing state-of-the-art (SoA) techniques with laser ablation have encouraged further research on the topic. Thorough investigation and practical demonstrations of the laser method are needed to foster industry recognition of this or other out-of-tankline (OOT) processing as an alternative to SoA approaches.

## **1.1 State-of-the-Art Surface Preparation**

The surface preparation of metals for bonding employs multiple steps to provide a chemically activated surface. Metal surfaces are typically either anodized or treated with a sol-gel based chemical conversion coating to achieve a bond with long-term environmental durability.<sup>5,6</sup> Here, immersion tanks containing strong acids and bases are used to strip away tenacious oxide layers, impurities and environs on the metal surface to create an appropriate surface for subsequent processing steps. Both acid and base etching processes create fresh, stable oxide surface layers and surface roughness to promote bonding which affect fatigue properties of the resulting structure. The process is expensive to operate and maintain because of the need for chemical tanklines containing hazardous materials.

## **1.2 Laser Surface Preparation**

Laser ablation is a subtractive process which relies upon highly focused laser irradiation to remove and redistribute material on a surface.<sup>7-10</sup> The ablation process has been demonstrated to generate high precision surface topography while simultaneously removing surface contaminants and modifying surface chemistry.<sup>11,12</sup> The effect of surface roughness on the fatigue life of ablated alloys, the stability of the prepared surface, available working time between ablation processing, and subsequent coating and bonding processes warrant further investigation towards minimizing degradation in bond performance.

## **1.3 Previously Reported Findings**

In previous reports, the utility of laser ablation to prepare the surface of titanium adherends for adhesive bonding was demonstrated with PETI-5 adhesive.<sup>13,14</sup> Contact angle goniometry, surface roughness and x-ray photoelectron spectroscopy were used to identify the physical and chemical components of the laser surface treated Ti alloy. The SoA surface preparation techniques were replaced with laser ablation processing to prepare bonded specimens for wedge crack extension (ASTM D3762) and single-lap shear testing (ASTM D1002) after hot, humid environmental aging. Based on property retention and failure mode analyses, laser ablation appeared to be a viable alternative to chemical-immersion and physical abrasion processes.

## **1.4 Contents of this Report**

This report presents further development of a laser ablation technique as an OOT process for the preparation of Ti-6Al-4V alloy faying surfaces. A 121 °C (250 °F) curing, toughened-epoxy system was used to bond wedge test specimens according to a test matrix where the SoA surface preparation process steps were systematically replaced with laser ablation. The failure mode (based on near-quantitative fluorescence inspection) and crack extension results after hygrothermal aging are reported. A series of cylindrical fatigue specimens were tested to address the retention of fatigue lifetime after laser ablative surface preparation. The allowable out-time between laser ablation and subsequent manufacturing steps were estimated by monitoring the surface energy on a down-selected set of laser ablated panels.

## 2. EXPERIMENTATION

### 2.1 Materials

Titanium alloy (Ti-6Al-4V, an alloy consisting of 90% titanium, 6% aluminum and 4% vanadium, 3.18 mm [0.125"] thick) for wedge tests and out-time studies was purchased from California Metal & Supply, Inc. and supplied in a configuration specified by ASTM D3762-03. Titanium alloy (Ti-6Al-4V, AMS 4911, 2.5×152×18.9 cm, 152 cm in the transverse direction) used for fatigue specimen fabrication was obtained from TIMET in Wentzville, MO. The longitudinal and transverse yield stresses were reported as 0.88 GPa (128 ksi) and 1.01 GPa (146 ksi), respectively. Adhesive used for bonding wedge test specimens was Hysol EA9696 from Henkel Corporation with an aerial weight of 0.39 kg/m<sup>2</sup> (0.08 PSF) on a polyester fiber carrier mat. A subset of the wedge test specimens received bonding pre-treatments with sol-gel, 3M AC130-2, prior to delivery to The Boeing Co. for application of bond primer as described in Section 2.3.

### 2.2 Wedge Test Methods

#### 2.2.1 Test Specimen Bonding Parameters

Two 15 × 20 cm Ti alloy plates were aligned in a jig with a 15 cm by 17.5 cm adhesive film and a 15 cm by 2.5 cm precrack film held between them. Vacuum bag compaction was performed in two, ten-minute steps. The first step was without the top adherend in place, and the second step compressed the full lay-up with upper adherend and caul plate in place. The layup was removed from the vacuum bag after compaction and placed in a Carver press (model 12-15H #3856) for 1 h at 121° C at 0.34-0.68 MPa (50-100 psi). Full load was maintained in the press while the layup was above 50° C. Shims were not used to control the bondline thickness of the resulting wedge test specimens.

#### 2.2.2 Wedge Testing

The wedge test samples were machined into five, 25.4 × 200 mm specimens using an abrasive water jet saw to avoid heating. Five specimens were tested for each set of experimental conditions. Bondline thickness was measured optically by viewing the cross-section of each specimen on both sides with an Olympus BH2 optical microscope equipped with Boeckeler Instruments Microcode II linear encoders to measure stage travel with a 1 micron resolution. Wedge testing was initiated by forcing an aluminum wedge into the precrack end of each specimen according to ASTM D3762. The specimens were aged at 60° C (140° F) and >98% relative humidity for 4 weeks. The humid environment was generated in a sealed chamber (ADTM D5032) with a rack to support test specimens above the liquid water reservoir. The humidity chamber was preconditioned in an oven at 60° C (140° F) for 24 h before introducing specimens. The temperature of the oven was monitored using a Lascar data logger to ensure the environment was maintained throughout the aging process. Crack extension was measured at 1 h, 8 h, 24 h, 48 h, 1 week, 2 weeks and 4 weeks.

#### 2.2.3 Failure Mode Inspection

The failure mode of each specimen was inspected using a fluorescence visualization technique described in detail in a previous publication.<sup>14</sup> Gray scale, digital images of each adherend were collected using illumination with a narrow band UV light source. Fluorescent light coming from

the residual adhesive on the failed bond surfaces images as bright pixels, whereas bare metal surfaces appear black. Images of the failure surface are analyzed by applying a contrast threshold to compare the relative numbers of black (adhesive failure) and white (cohesive failure) pixels.

### **2.3 Chemical Surface Preparation**

The chemical surface preparation processes were carried out in facilities at The Boeing Company, Seattle, WA. After precleaning, critical prebond preparation steps were: deoxidation, hot alkaline conditioning (HAC), Boegel-EPII conversion coating, and bond primer coating, respectively. The deoxidation process involved immersion of the desired specimen area in a nitric/hydrofluoric acid immersion tank to remove surface contamination and mill-scale. Deoxidation was followed by HAC which used a hot caustic immersion to activate the surface for sol-gel treatment. Boegel-EPII is an aqueous sol-gel system that provided an interface between the metal substrate and the bond primer.<sup>6</sup> Cytec BR-6747-1 bond primer was spray coated according to the manufacturer's recommendations. Further details about the deoxidation, HAC and Boegel-EPII processes have been previously published.<sup>5</sup>

### 2.3.1 Test Matrix

Table 1 shows the test matrix used to assess the relative performance of laser surface preparation against SoA chemical treatments. To reduce variability in titanium panel purchased stock, all specimens were precleaned using an emulsion cleaner and alkaline cleaner followed by a nitric acid/ hydrofluoric acid etch process. Five different laser processes, designated A-E, (detailed in Table 2) were tested. SoA chemical processes were incrementally removed to determine which one(s) could be replaced using the laser process. Bond primer was applied to all samples immediately after surface preparation. A subset of the samples (5-8) were thermally treated by baking in air at 260 °C (500 °F) for 5 h to simulate an aged metal surface.

Table 1: Wedge test matrix showing tested surface preparation combinations

Test Number	Nitric/HF preclean	Thermal Age	Laser Process	State-of-the-Art Processes			Bond Primer
				Nitric/HF	TiBoe	Sol-Gel	
1a	X		A	X	X	X	X
2a	X		A		X	X	X
3a	X		A			X	X
4a	X		A				X
1b	X		B	X	X	X	X
2b	X		B		X	X	X
3b	X		B			X	X
4b	X		B				X
3c	X		C			X	X
4c	X		C				X
3d	X		D			X	X
4d	X		D				X
3e	X		E			X	X
4e	X		E				X
5	X	X	A	X	X	X	X
6	X	X	A		X	X	X
7	X	X	A			X	X
8	X	X	A				X
Control 1	X			X	X	X	X
Control 2	X	X		X	X	X	X

“X” in the table indicates a process that was applied for the indicated test.

### 2.4 Laser Ablation

Laser ablation of Ti-6Al-4V coupons was performed on a PhotoMachining, Inc. laser ablation system with a Coherent, Avia frequency tripled Nd:YAG laser (7 W nominal pulsed output at 355 nm). Wedge test specimens were ablated with patterns, according to Table 2, on the faying surface using a direct write process. The linear patterns were oriented longitudinally on the specimens such that the ablation pattern was parallel to crack extension during testing. The write

speed, 25.4 cm/s (10 in/s), and pulse frequency, 80 kHz, were held constant for all experiments. The average laser power (1.5 W) was monitored after the final lens element using a thermopile sensor (model 3A-SH) and Nova II power meter from Ophir Spirocon LLC. The pitch of the parallel and crosshatch lines can be adjusted to affect changes in the pattern density, which is quantified in terms of duty cycle. Duty cycle is the percentage of the surface area that received laser ablation. The duty cycle (d) can be calculated from the ablation line width ( $A_w$ , 25 micron) of a single line and the line pitch (p). For linear patterns,  $d = A_w / p \times 100\%$  while for crosshatch patterns  $d = 2 \times A_w / p - A_w^2 / p^2 \times 100\%$ . Some samples received ablation over the entire surface twice and are designated with a 200% duty cycle for the purpose of differentiation. Throughput of the laser system was not optimized in this study, but the experimental processing rate ranged from about 32 to 1.3 cm<sup>2</sup>/min depending on duty cycle.

Table 2: Laser ablation patterns used in wedge test matrix and out-time study

Experiment Designation	Pitch, in microns (mil)	Line Pattern	Duty Cycle (%)
A	102 (4)	Crosshatch	44
B	406 (16)	Crosshatch	12
C	51 (2)	Parallel	50
D	25 (1)	Parallel	100
E	25 (1)	Crosshatch	200
F	12.5 (0.5)	Parallel	200

## 2.5 Optical Inspection

Optical micrographs were collected using a Leica DM8000 microscope with dark field illumination. Roughness was measured using a New View 6000 optical surface profiler from the Zygo Corporation equipped with a 2.5× and 20× objectives and a 1× zoom tube. Failure surfaces on fatigue test specimens were inspected using a Zeiss Discovery V12 stereoscope.

## 2.6 Fatigue Testing

Fatigue testing was conducted according to the method described in ASTM E466-07. The single titanium plate acquired for fatigue testing was machined into 57 titanium bars each 17.8 × 2.5 × 2.5 cm in size using a water jet saw. The bars were further machined by Westmoreland Mechanical Testing and Research (WMT&R) into cylindrical dog bone specimens according to the drawing in Figure 1. The stress concentration factor ( $K_T$ ) was zero (notchless). The gage section of each specimen was polished to 203 nm average roughness (8 micro inch finish) as confirmed by optical surface profilometry. One third of the specimens, designated as the parent material, were left pristine. Another group of specimens (designated SoA) received chemical

surface treatment conducted by The Boeing Company (see Section 2.3) excluding the bond primer step. The remaining 19 specimens received laser treatment on the gage section by ablation of lines in the axial direction. Specimens were mounted to a rotational stage and rotated incrementally to ablate 780 uniformly distributed, parallel lines on the gage section with a pitch of approximately 25.4 microns (1 mil). The rotational stage stepper motor had an angular resolution of  $0.02^\circ$ . Average roughness was measured on the gage section for a subset of each specimen group.

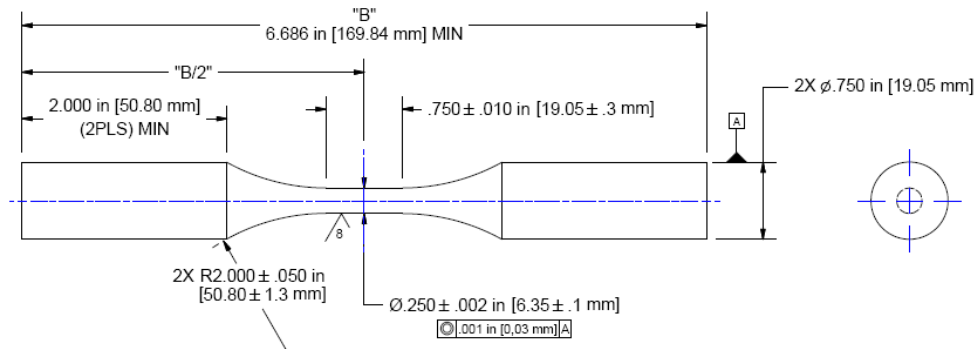

Figure 1: Dimensioned drawing of cylindrical fatigue test specimen with tangentially blended fillets. “R” is used to denote the radius of curvature of the fillet.

The 57 specimens were returned to WMT&R for fatigue testing. All specimens were tested on a single frame with current alignment and load cell calibration certifications. Tests were conducted at room temperature under load control on a servo-hydraulic actuated frame producing a sinusoidal waveform at 30 Hz with an R-ratio of 0.06. Run out was defined as 20 million cycles, and any tests reaching run-out were discontinued. Stress levels were selected to cause failures at each order of magnitude from 10,000 cycles up to run-out with a maximum allowable stress being the yield stress of the specimen in the direction being placed in tension, 0.88 GPa (128 ksi).

## 2.7 Out-time Study

Titanium panels identical to the wedge test substrates were machined into 100 mm x 150 mm coupons using a water jet saw. The coupons were ablated with 12.5 mm (0.5 in) squares separated from one another to prevent interference between individual measurements. Each measurement was made on an isolated square to prevent interference from previous measurements. Two laser ablation patterns, A and F (see Table 2), were tested for out-time stability. Specimens were wrapped in paper and placed in a dessicator with a relative humidity between 20% and 40%. A Brighton Technologies Group Surface Analyst was used to measure water contact angle using a ballistic drop impact method. A First Ten Ångströms FTA200 contact angle goniometer was used to collect sessile drop contact angles for water, ethylene glycol and methylene iodide. The Kaelble plot method was used to calculate the surface energy from the three liquids.<sup>15</sup> Contact angles (room temperature) were measured at 0 h, 2 h, 24 h, 72 h, 1 week, 10 days, 2 weeks, 3 weeks, 4 weeks, 6 weeks, 8 weeks, and 10 weeks.

### 3. RESULTS

#### 3.1 Wedge Test Results

Wedge tests provide information on the environmental durability of adhesive bonds through evaluation of the crack growth and assessment of failure mode after aging 24h and 4 weeks. The failure mode provides an excellent metric for surface preparation durability. The crack growth indicates the overall quality of the bond and is related to the mode I strain energy release rate during crack propagation,  $G_{IP}$ . Factors such as bondline thickness, porosity, and adhesive properties determine the crack propagation rate. The 20 samples described in the test matrix (see Section 2.3.1) vary in SoA treatment and laser processing. Figure 2 compares results from tests 1a-4a and control 1 from Table 1, which each received identical laser ablation treatment and incrementally reduced SoA process steps. For brevity, results are only shown for ablation pattern A from Table 2. The data indicate that laser processing can replace the deoxidation etching step and the HAC treatment step, but requires the Boegel-EPII conversion coating step and bond primer coating. Without the Boegel-EPII coating, adhesion failure occurs in all laser treated specimens; although a trend towards higher cohesive failure modes is observed with higher duty cycle ablation (not shown). With the Boegel-EPII step, the specimens with laser pretreatment showed 100% cohesive failure modes. This suggests that chemical etching and oxidation processes can be replaced with laser ablation to form durable adhesive bonds.

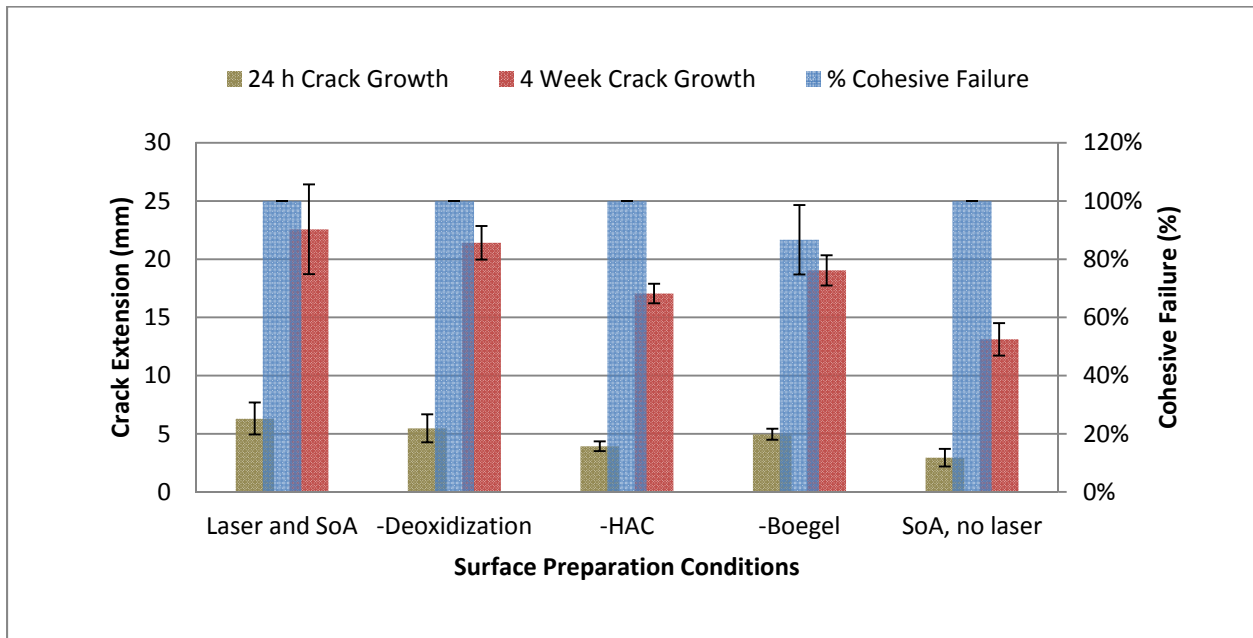

Figure 2. Summary of wedge test results for specimens that received laser processing with a 44% duty cycle to replace chemical processing steps in the bond preparation process. From left to right, the specimens received (in addition to laser ablation) the full SoA treatment, the SoA treatment with deoxidation removed, the SoA treatment with deoxidation and HAC removed, the SoA treatment with deoxidation, HAC, and Boegel-EPII removed, and the full SoA treatment without laser ablation.



Because all of the titanium stock received an initial cleaning which was similar to the deoxidation process, a sub-set of specimens were aged to simulate the untreated surface conditions expected from the titanium manufacturer. Figure 3 shows the effect of aging the titanium stock in a convection oven at 260 °C (500 °F) for 5 h before beginning surface preparation processes. The data shown in Figure 3 comes from tests 5-8 of the test matrix shown in Table 1. No loss in cohesive failure and insignificant changes in crack length were observed after removing the deoxidation and HAC chemical treatments. Cohesive failure is reduced and crack extension increases for specimens without the Boegel-EPII process (-Boegel in Figure 3). A comparison of specimens “-Boegel” from Figure 2 and 3 indicates the effect of thermal aging. The aged specimens showed a reduction in cohesive failure.

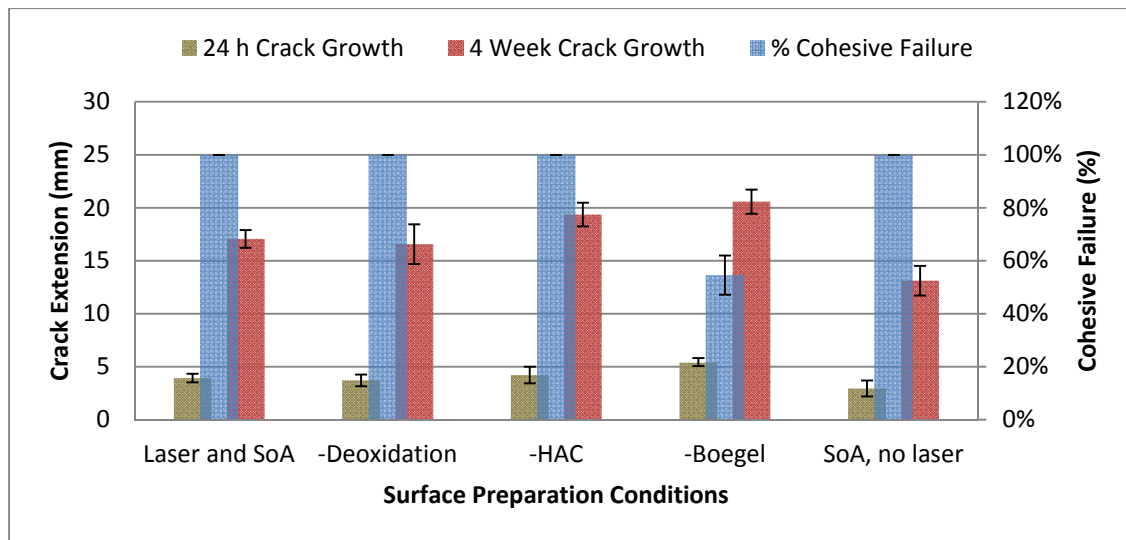

Figure 3: Wedge test results for specimens which were baked at 260 °C (500 °F) for 5 h before beginning surface preparation. From left to right, the specimens received (in addition to laser ablation) the full SoA treatment, the SoA treatment with deoxidation removed, the SoA treatment with deoxidation and HAC removed, the SoA treatment with deoxidation, HAC, and Boegel-EPII removed, and the full SoA treatment without laser ablation.

### 3.2 Fatigue Test Results

To test whether the varying surface roughness parameters from the laser ablation process affected the fatigue life of the titanium, the laser pattern with greatest surface roughness (previously reported) was selected for fatigue testing.<sup>14</sup> Test specimens were ablated with parallel lines (25 microns wide) in the test direction with a 25 micron (1 mil) pitch.

Before the maximum load level could be tested, the transverse and longitudinal directions in the grain of the raw material were determined by metallographic cross section. The three perpendicular planes from the raw titanium stock are shown in Figure 4. It was determined that the tensile direction of the test specimens was parallel to the longitudinal direction of the titanium stock. The yield stress in the longitudinal direction given by the manufacturer was used as an upper limit for the load level. Two specimens that were tested above the yield stress resulted in outliers from the data set as shown in Figure 5.

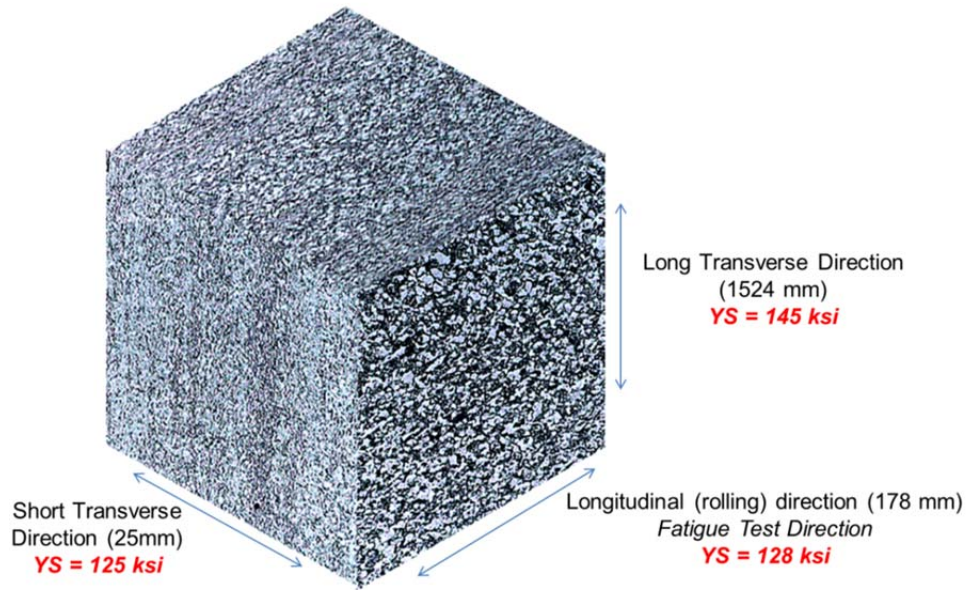

Figure 4: SEM cross-section inspection of titanium alloy used to make fatigue test specimens.

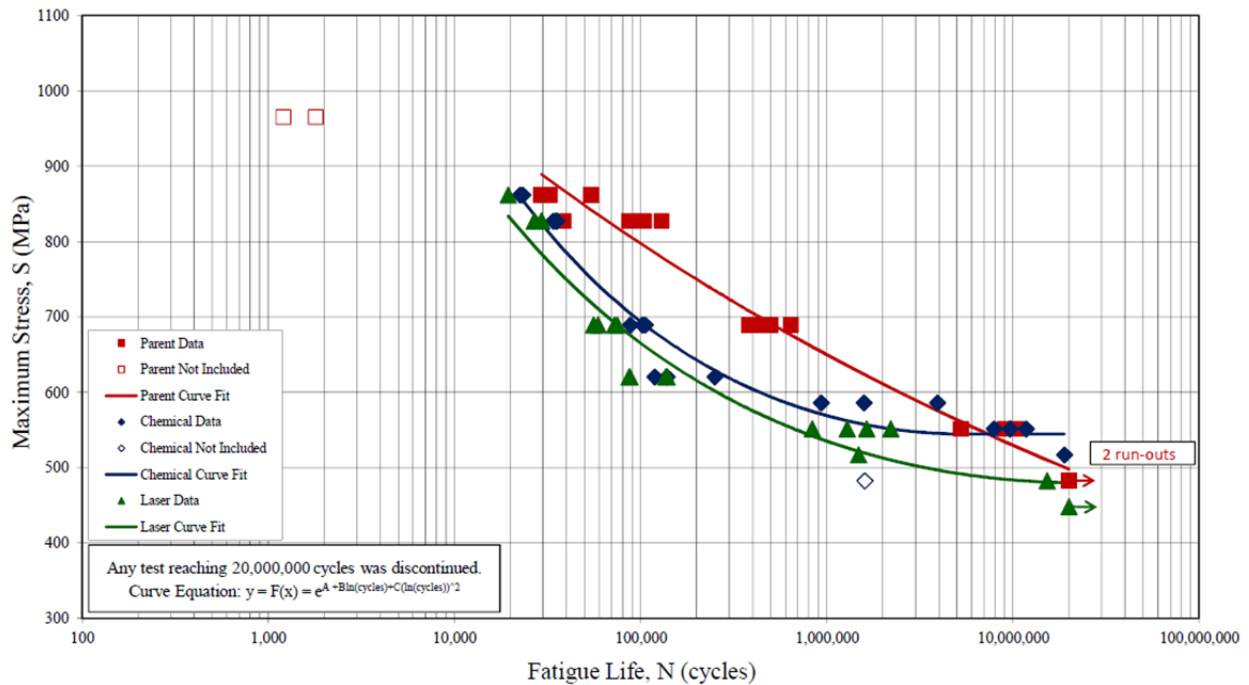

Figure 5: Fatigue life curves for three groups of specimens.

Figure 5 is a plot of load levels as a function of the number of loading cycles to failure. The fatigue behavior of the parent material is shown in red, whereas the SoA chemical pretreatment is shown in blue and the laser ablation in green. The surface roughness on the gage section of the prepared surfaces was  $655 \pm 26 \mu\text{m}$  for the SoA chemical pretreatment and  $2059 \pm 203 \mu\text{m}$  for

the laser ablated surfaces compared to  $172 \pm 47 \mu\text{m}$  for the parent material specimens. Each specimen initiated failure at the surface in the gage section rather than in the bulk of the metal, indicating a valid test.

All three specimen types have similar fatigue life at high and low loading levels. This indicates the effect of surface roughness is minimized for very short or very long fatigue lifetimes. At high loading levels, just below the yield stress, slip and fine crack growth fatigue mechanisms are compressed to a much shorter fatigue life. Initial crack growth occurs over a relatively small number of cycles; therefore, the parent polished and roughened surfaces do not appear significantly different. At low load levels, the stress is not high enough to drive crack propagation even in the presence of visible surface cracks, which again leads to similar stress levels at maximum fatigue life.

### 3.3 Out Time Study Results

Figure 6 shows dark-field optical micrographs of the Ti alloy surface prepared by laser ablation. The ablated and non-ablated areas of the crosshatch pattern (left) are clearly discernible, while the linear ablation pattern (right) completely covers the surface.

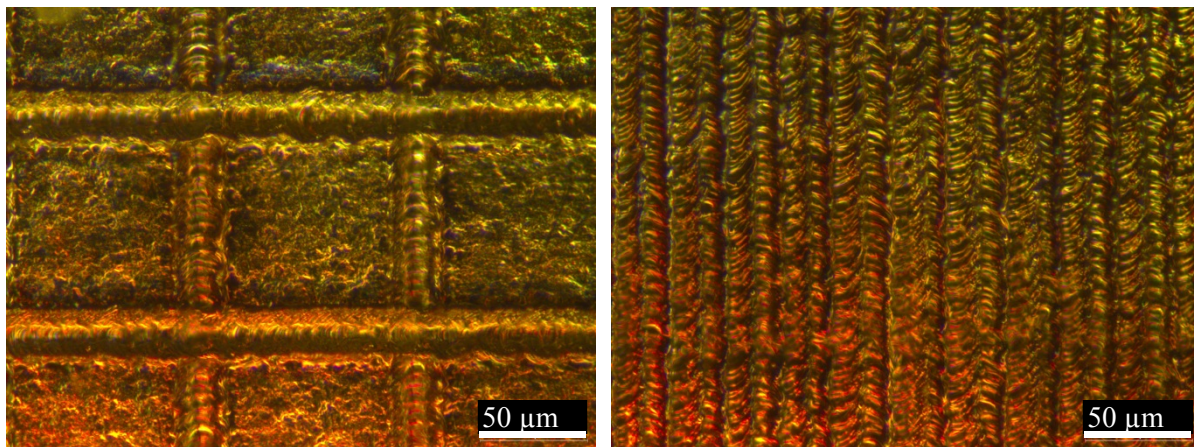

Figure 6: Dark-field optical micrographs of a crosshatch ablated surface with a 102 micron (duty cycle of 44%) pitch (left) and a linear ablated surface with a 13 micron pitch (duty cycle of 200%).

The trends for water contact angle and surface energy are presented for both experimental ablation patterns in Figures 7 and 8. Increasing contact angle and decreasing surface energy are presumably caused by oxidation and passivation of the laser activated surface and also by the accumulation of surface contamination. Both figures indicate an induction period exists immediately after laser surface preparation before the water contact angle begins to increase. For the crosshatch pattern with a low duty cycle (44%) the surface experiences induction for about 72 h while the linear pattern (200% duty cycle) shows about 336 h of induction. In addition, the crosshatch patterned specimens show a steeper increase in water contact angle and steeper decrease in surface energy with time.

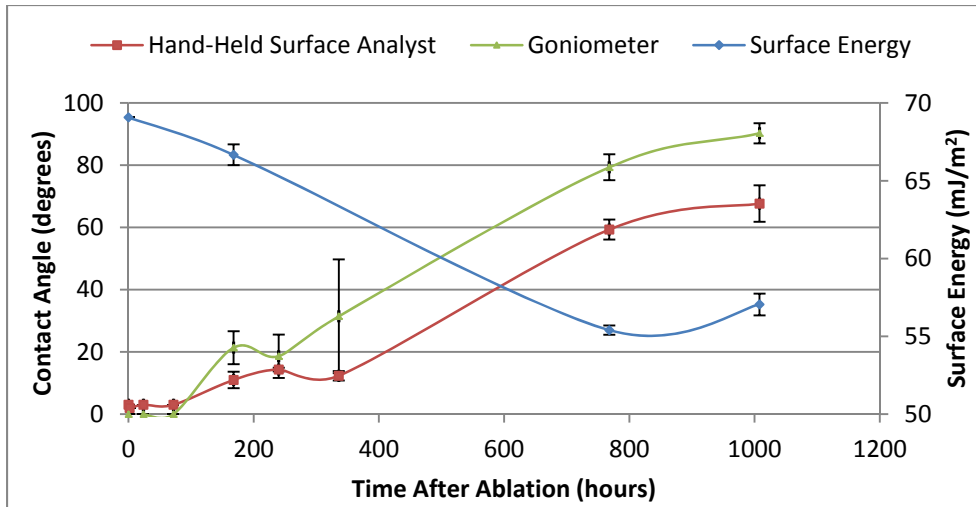

Figure 7: Change in water contact angle and surface energy over 10 weeks for titanium panels ablated with a crosshatch pattern on a 102 µm pitch (duty cycle = 44%).

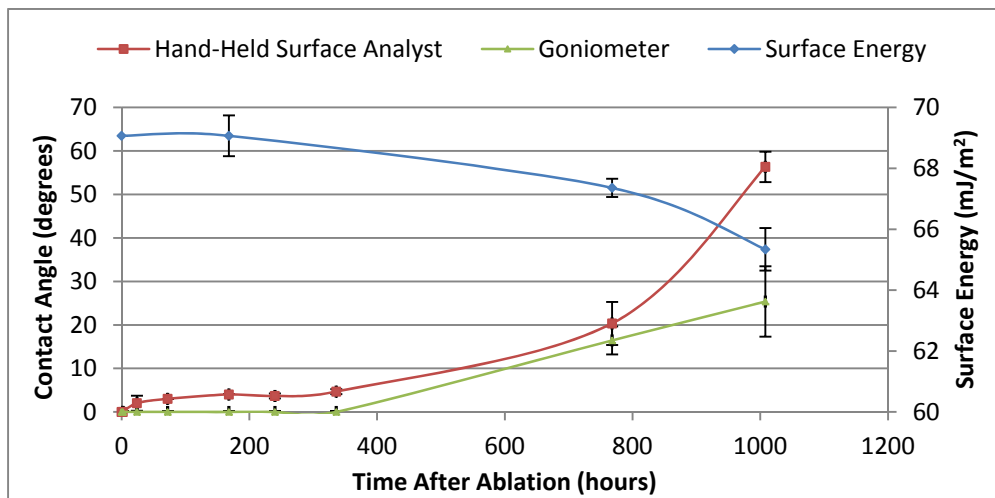

Figure 8: Change in water contact angle and surface energy over 10 weeks for titanium panels ablated with a linear pattern on a 13 µm pitch (duty cycle = 200%).

## 4. CONCLUSIONS

### 4.1 Adhesion

The durability of laser pretreatment on Ti-6Al-4V bonded with a 121 °C curing structural epoxy film adhesive was examined using the wedge test. Results indicated that laser ablation could replace both the chemical deoxidation process using nitric and hydrofluoric acids and the hot alkaline conditioner pretreatment steps with no loss in adhesion performance. Laser ablated faying surfaces were shown to be compatible with industry standard surface preparation coatings (i.e., Boegel-EPII and Cytec BR-6747). The use of the Boegel-EPII conversion coating and Cytec BR-6747-1 primer were necessary to maintain consistent environmental durability

performance. Replacement of two chemical immersion processes with laser ablation would allow OOT processing, improve process automation, and enable superior quality control.

## 4.2 Fatigue

The fatigue properties of laser ablated Ti-6Al-4V cylindrical test specimens were compared with pristine specimens and with specimens that received SoA chemical surface preparation. Although the most aggressive laser ablation pattern was used for comparison, the fatigue properties of all three materials were similar. Both the chemical and laser ablation processes diminished fatigue lifetime at intermediate load levels between 586 and 758 MPa (85 and 110 ksi), while all specimens exhibited similar lifetimes at high (120 MPa) and low (60 MPa) load levels. At all load levels, the fatigue properties of the laser ablated mechanical specimens were similar to SoA (chemically processed) specimens. These results indicated that laser ablation did not significantly reduce fatigue lifetime of Ti-6Al-4V substrates.

## 4.3 Out-Time

An increase in water contact angle with out-time after laser ablation was observed. With low-duty-cycle ablation, the effect was apparent in as little as 72 h. A surface created with a duty cycle of 200% remained stable for over 300 hours. Based on these findings, laser ablation patterning can provide sufficiently stable surfaces for use with current manufacturing practices.

# 5. ACKNOWLEDGEMENTS

The authors thank Will Johnston, Jim Bauman, and Keith Bird from NASA Langley Research Center for discussions about metal fatigue testing and for metallographic inspection. Thanks are due also to Hoa Luong for tool fabrication and to Mike Oliver for specimen machining, both from NASA LaRC. The authors appreciate discussions about fatigue test materials and practices with James Pehoushek-Stangeland of The Boeing Company.

# 6. REFERENCES

1. Bossi, R. & Piehl, M. "Bonding primary aircraft structures: the issues" *Manuf. Eng.* 59(2011): 101-109.
2. Perton, M., Blouin, A., & Monchalain, J., "Adhesive bond testing of carbon-epoxy composites by laser shockwave" *J. Phys. D.: Appl. Phys.* 44(2011): 12-22.
3. Davis, G. "Contamination of surfaces: Origin, detection and effect on adhesion" *Surf. Interface Anal.* 20(1993): 368-372.
4. Davis, M. & Bond D. "Principles and practices of adhesive bonded structural joints and repairs" *Int. J. Adhes. Adhes.* 19(1999): 91-105.
5. Kay Y Blohowiak, Joseph H Osborne, Kenneth A Krienke: Sol-gel coated metal. The Boeing Company August 1999: US 5939197
6. Grob, J.W. et al. "Qualification of sol-gel surface treatments for adhesive bonding of titanium alloys." *SAMPE 2004 Technical Conference Proceedings: Materials and Processing Technology – 60 Years of SAMPE Progress*, Long Beach, CA, May 16-20, 2004. Society for the Advancement of Material and Process Engineering, CD-ROM 6pp.

7. Baburaj, E.G. et al. "Enhancement of adhesive joint strength by laser surface modification" *Int. J. Adhes. Adhes.* 27(2007): 268-276.
8. Rotel, M. et al. "Pre-bonding technology based on excimer laser surface treatment" *Appl. Surf. Sci.* 154-155(2000): 610-616.
9. Benard, Q. et al. "Laser treatment of carbon/epoxy and glass epoxy composites with an excimer laser beam" *Int. J. Adhes. Adhes.* 26(2006): 543-549.
10. Benard, Q. et al. "Influence of the Polymer Surface Layer on the Adhesion of Polymer Matrix Composites" *J. Thermop. Compos. Mater.* 22(2009): 51-61.
11. Belcher, M.A. et al. "Laser Surface Preparation and Bonding of Aerospace Structural Composites" *55th International SAMPE Symposium and Exhibition* (2010) Seattle, WA.
12. Belcher, M.A., Wohl C.J. and Connell, J.W. "Surface preparation and bonding of composite aircraft" *32nd Annual Meeting of the Adhesion Society* (2009) Savannah, GA.
13. Palmieri, F.L. et al. "Laser ablation surface preparation of Ti-6Al-4V for adhesive bonding," *SAMPE 2012 Technical Conference Proceedings: Connecting the Advanced Materials Community*, Baltimore, MD, May 21-24, 2012. Society for the Advancement of Material and Process Engineering, CD-ROM 14pp.
14. Palmieri, F.L. et al. "Laser ablative surface treatment for enhanced bonding of Ti-6Al-4V alloy," *Appl. Mat. Int.* 5(2013): 1254-1261.
15. Kaelble, D.H.. "Dispersion-Polar Surface Tension Properties of Organic Solids." *J. Adhes.* 2(1970): 66-81.

Filename: lf99-18257\_final-SAMPE\_2014\_-\_NASA\_Paper  
Directory: C:\Users\wbaize\AppData\Local\Temp\1  
Template: C:\Users\wbaize\AppData\Roaming\Microsoft\Templates\Normal.  
dotm  
Title: TITLE  
Subject:  
Author: u61550  
Keywords:  
Comments:  
Creation Date: 2/3/2014 5:11:00 PM  
Change Number: 2  
Last Saved On: 2/3/2014 5:11:00 PM  
Last Saved By:  
Total Editing Time: 3 Minutes  
Last Printed On: 6/24/2014 12:35:00 PM  
As of Last Complete Printing  
Number of Pages: 14  
Number of Words: 4,419 (approx.)  
Number of Characters: 25,191 (approx.)