

Current Content of the Microgravity Materials Program

Effect of Convection on the Columnar-to-Equiaxed Transition in Alloy Solidification

Investigation Name, PI: Prof. Christoph Beckermann (Univ. Iowa)

Project Scientist: Ellen Rabenberg (NASA-MSFC)

Project Manager: Dr. James P. Downey (NASA-MSFC)

Engineering Team: TBD

Objective: To study columnar-to-equiaxed grain structure transition and effect of convection in alloys by using directional solidification with and without grain refiner, multi-scale and phase-field computer simulations.

Relevance/Impact: Grain structure is important for all metal castings and affects defect formation and properties. Gravity has a large effect on grain structure. NASA funding allows for meaningful continuation of ESA CETSOL experiments on ISS.

Development Approach: Study grain structure transition and dendrite fragmentation in the absence of gravity driven convection and sedimentation effects.

Instrumentation & Experiment Summary:

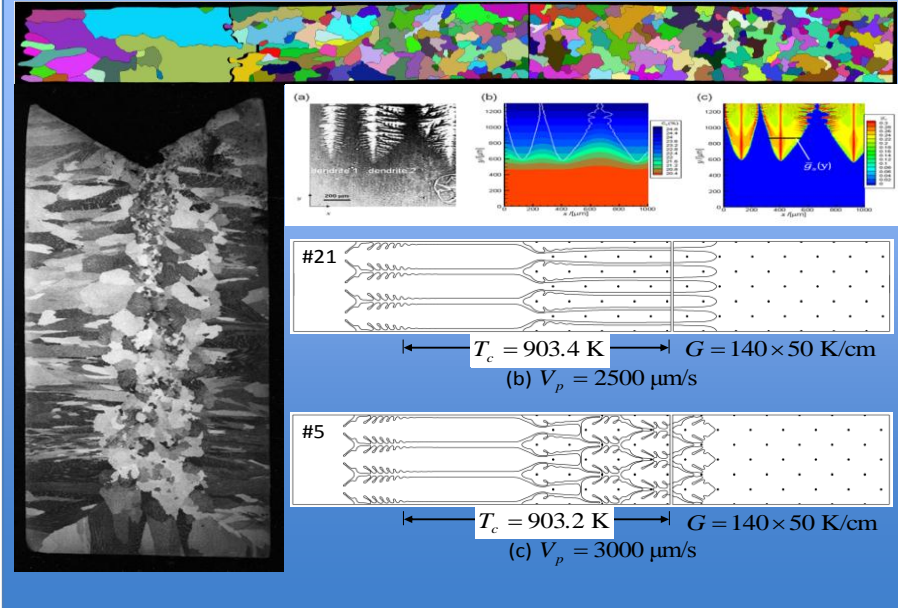

Instrumentation & Experiment Summary:

- Ground based work: Will be performed at MSFC under direction of Dr. Beckermann
- Flight experiments: On International Space Station (2020).
- ISS requirements: Low-gradient furnace (LGF) on Materials Science Research Rack (MSRR).

ISS Resource Requirements

Accommodation (carrier)	
Upmass (kg) (w/o packing factor)	5kg each
Volume (m³) (w/o packing factor)	690 x 185 x 185mm each
Power (kw) (peak)	2.54 kW (for 0.5 hrs), total power max 1.82 kW
Crew Time (hrs)	1.5 hrs
Autonomous Ops (hrs)	
Launch/Increment	SpaceX-12 launch/ Inc 50

Modeling Peritectic Microstructure Formation during Directional Solidification in Space and on Earth

METCOMP, PI: Jon Dantzig, University of Illinois
ESA Team Leader: Michel Rappaz, EPFL, Switzerland
PS: Dr. Frank Zimmerman, NASA, MSFC
PM: Dr. J. Patton Downey, NASA, MSFC

Objective:

- ◆ Provide computational modeling support for ESA-sponsored METCOMP project, which studies microstructure formation in peritectic alloys
- ◆ Examine the role of buoyancy-driven fluid flow in microstructure formation in Cu-Sn alloys
- ◆ Provide modeling support to determine terrestrial conditions where buoyancy can be suppressed

Relevance/Impact:

- ◆ Cu-Sn alloys with aligned microstructures have potential as novel materials
- ◆ Sn rejected during solidification produces buoyant convection in terrestrial environment
- ◆ Solidification in thin capillaries may enable convection-free solidification in terrestrial laboratories

Development Approach:

- ◆ Use macroscopic modeling methods to examine the role of experimental design to suppress buoyancy on earth
 - Determine whether convection can be suppressed on earth by appropriate experimental design
 - Support space experiment design and interpretation
- ◆ Use microscopic phase-field modeling to examine microstructure formation in peritectic alloys:
 - Revise existing adaptive phase-field code for multi-component alloys
 - Examine the role of fluid flow on microstructure formation

Ground-based Research

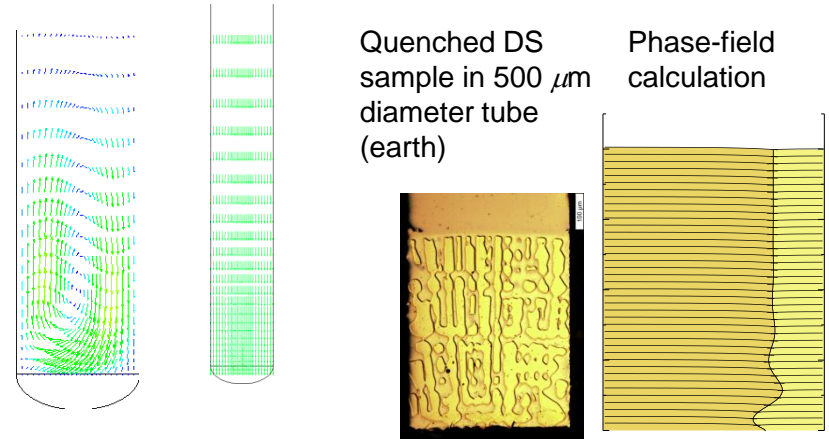

Convection suppressed on earth by reducing sample diameter to 500 microns

Coupled growth in Cu-Sn hypo-peritectic alloy

Modeling of Particle Transport in the Melt and its Interaction with the Solid-Liquid Interface

ESA Investigation Name: *Gravitational Effects on Heat and Mass Transport Phenomena in Directional Solidification of Upgraded Metallurgical Silicon for Photovoltaic Applications (SiSSi)*

PI: Dr. Jeffrey Derby, University of Minnesota

ESA Science Team Coordinator: Prof. Thierry Duffar, Grenoble Institute for Technology

PS: TBD

PM: Dr. James Patton Downey

Engineering Team: Astrium

WBS: 825080.04.06.30.18.04

Instrumentation & Experiment Summary

LGF and FMF furnace inserts are to be used by the ESA team. The principle investigator is only responsible for calculations.

Objective: *Develop a model for the dynamics of particle transport in Si melts and the pushing or engulfment of these particles at a moving solid/liquid interface*

Relevance/Impact: *Use of metallurgical grade Si in photovoltaic materials would greatly reduce costs but the ability to control defect distributions and in particular the distribution of particles of SiC and SiN is required*

Development Approach: *A model for critical velocities that describe whether or not particles are engulfed by a solidification front will be developed as a function of temperature gradient, particle size, shear flow at the interface, and grain boundary conditions at the interface. Results will be validated using literature and experiments by team members.*

ISS Resource Requirements

Accommodation (carrier)	NA
Upmass (kg) (w/o packing factor)	NA
Volume (m³) (w/o packing factor)	NA
Power (kw) (peak)	NA
Crew Time (hrs)	NA
Autonomous Ops (hrs)	NA
Launch/Increment	NA

Multi-Scale Modeling and Experimentation on Liquid Phase Sintering in Gravity and Microgravity Environments

Investigation Name, PI: Randall M. German, San Diego State University; **Co-I:** Eugene A. Olevsky, San Diego State University.

PS: Biliyar N. Bhat, Marshall Space Flight Center

PM: James P. Downey, Marshall Space Flight Center

Engineering Team: development contractor – Teledyne Brown Engineering.

Objective: The proposed fundamental research is aimed at the achievement of two critical goals: (i) the in-depth analysis of the liquid phase sintering-induced pore-grain structure evolution by the de-convolution of the impact of gravity and (ii) exploring sintering under microgravity conditions as a promising technique for in-space fabrication and repair.

Relevance/Impact: The anticipated research outcomes will be relevant to current and future space exploration needs for habitat creation, extraterrestrial exploration, and vehicle *repair* activities during various NASA missions. Future NASA missions will require development of processes that permit fabrication and repair of critical components under reduced gravity conditions. This capability is needed to reduce resource requirements and the spare parts inventory while enhancing mission security.

Development Approach:

The research project involves:

- ❖ The development of the multi-scale computer code combining microscopic models (atomistic, Monte Carlo, or morphological energy minimization), mesoscale multiple grain models, such as Monte-Carlo-based simulations, and macroscopic finite-element-based continuum models of sintering. These will be combined to deliver verified predictions of macroscopic shape distortion during liquid phase sintering of heavy alloys.
- ❖ Experimental verification of the developed multi-scale modeling framework in Earth and microgravity environments.
- ❖ Integration into backward solutions to enable green body shaping in anticipation of the distortion to enable net-shaping to desired final sizes and shapes based on simulated evolution during sintering.

Instrumentation & Experiment Summary

Critical microgravity sintering experiments will be performed in the Low Gradient Furnace utilizing specially designed cartridges with multiple walled design. Experiment samples will be contained in alumina crucibles stacked a quartz ampoule which is evacuated and sealed (see figure below) and then inserted into the cartridge. Parallel experimental runs will be conducted under identical conditions, except for the presence of gravity. After the completion of the sintering experiments and the return of the ampoules or sample cartridges, the samples will be inspected, subjected to micro-tomography to image pores, and subjected to profile measurement (distortion), density (densification), and microscopy. Cross-sectioned profiles will be imaged, subjected to quantitative microscopy for grain size distribution, pore size distribution, porosity location, and other features such as contiguity and connectivity. These experimental results will be compared to model predictions in terms of grain size, pore size, the spatial location of each, while being linked to the model and macroscopic shape distortion.

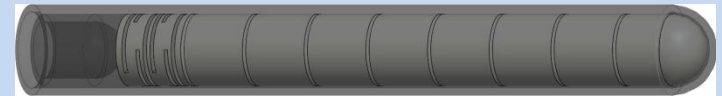

ISS Resource Requirements

Accommodation (carrier)	
Upmass (kg) (w/o packing factor)	
Volume (m³) (w/o packing factor)	
Power (kw) (peak)	
Crew Time (hrs)	
Autonomous Ops (hrs.)	
Launch/Increment	TBD

Fabrication of Amorphous Metals in Space (FAMIS)

Investigation Name: Fabrication of Amorphous Metals in Space (FAMIS)

PI: Dr. Douglas C. Hofmann (Jet Propulsion Laboratory)

Co-I: Dr. Andrew A. Shapiro (Jet Propulsion Laboratory)

Co-I: Prof. William L. Johnson (California Institute of Technology)

Co-I: Dr. Marios D. Demetriou (California Institute of Technology)

Co-I: Dr. Won-Kyu Rhim (California Institute of Technology)

Consultant: Prof. Konrad Samwer (University of Goettingen)

PS: Jonathan A. Lee (NASA-MSFC)

PM: Dr. James Patton Downey (NASA-MSFC)

Engineering Team: NASA-MSFC

WBS: ?

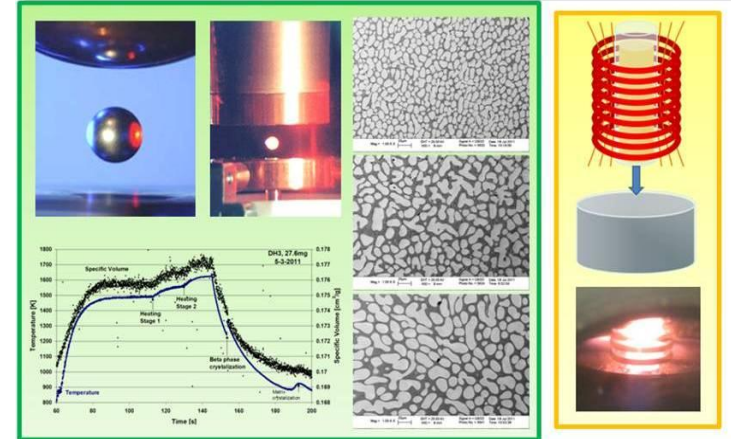

Instrumentation & Experiment Summary:

The Low Gradient Furnace will be used to directionally solidify BMGMCs with and without an isothermal coarsening period. The Solidification and Quenching Furnace will be used to directionally solidify BMGMC samples under high temperature gradients and to rapidly vitrify the samples.



Objective: Relate the properties of two phase Bulk Metallic Glass Metal Composites (BMGMC) with the dendritic microstructure.

Relevance/Impact: Metallic glasses have many desirable properties but can be brittle and undergo fracture. BMGMCs contain a crystalline second phase, which may provide improved properties relative to BMGs depending on the alignment, size, and distribution of the crystalline phase.

Development Approach: Produce BMGMCs by directional solidification and electrostatic levitation; characterize the morphology of the BMGMCs by diffraction and scanning electron microscopy, characterize mechanical properties of BMGMCs by tension, bending, and Charpy impact tests, and relate to results to the morphology. Perform microgravity experiments in which the absence of buoyancy driven convection simplifies the understanding of processing conditions.

ISS Resource Requirements

Accommodation (carrier)	MSRR/MSL
Upmass (kg) (w/o packing factor)	20
Volume (m³) (w/o packing factor)	0.023
Power (kw) (peak)	2.54
Crew Time (hrs)	1.5
Autonomous Ops (hrs)	72
Launch/Increment	April 2018

Integrated Computational & Experimental Studies of Complex Dendritic Microstructure Development During Directional Solidification of Metallic Alloys

Investigation Name: Columnar to Equiaxed Transition in Solidification Processing (CETSOL)
PI: Dr. Alain Karma (Northeastern University)
ESA Science Team Coordinator: Dr. Charles-Andre Gandin (Ecole de Mines de Paris)
PS: Jonathan A. Lee (NASA-MSFC)
PM: Dr. James Patton Downey (NASA-MSFC)
Engineering Team: Astrium (ESA)
WBS: 825080.04.06.30.19.01

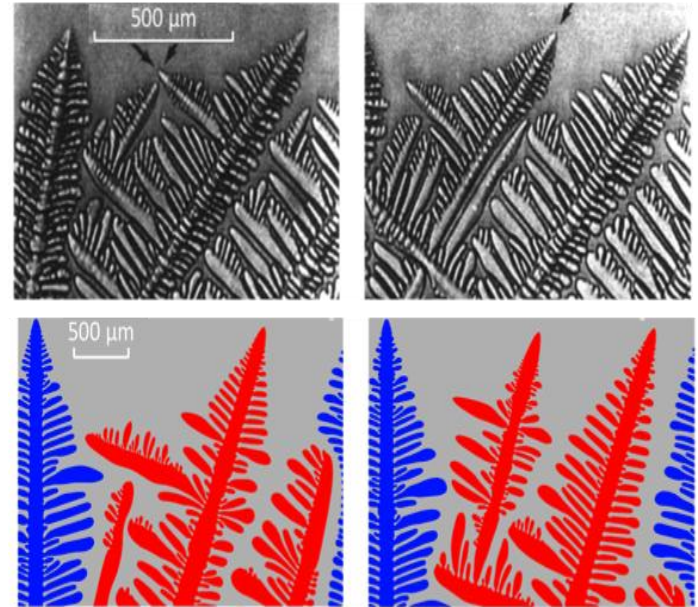

Instrumentation & Experiment Summary:

This project supports the CETSOL team, which utilizes the Solidification with Quench Furnace, the Low Gradient Furnace, and the Microgravity Science Glovebox (MSG) Directional Solidification (DIRSOL) facility. The PI is responsible for calculations only. No ISS resource requirements.

Objective: Develop a coarse-grained Dendritic Needle Network (DNN) approach to simulate microstructure development on a scale relevant for predicting the dynamical selection of primary spacing.

Relevance/Impact: Mechanical properties are determined by the spacing of dendrites in many metallic alloys.

Development Approach: DNN model 2D predictions of microstructure evolution will be validated against analytical and phase field predictions. CETSOL flight experiment data will validate the DNN model in 3D. Validation is greatly simplified by the absence of buoyancy driven convection.

ISS Resource Requirements

Accommodation (carrier)	NA
Upmass (kg) (w/o packing factor)	NA
Volume (m ³) (w/o packing factor)	NA
Power (kw) (peak)	NA
Crew Time (hrs)	NA
Autonomous Ops (hrs)	NA
Launch/Increment	NA

Solidification Along an Eutectic Path in Ternary Alloys (SETA)

WBS: 825080.04.06.30.17

U.S. PI: Dr. Ralph Napolitano, Iowa State University
DLR Team Coordinator: Dr. Stephan Rex, ACCESS

NASA Objectives and Contributions:

- Quantify three-phase ternary invariant eutectic solidification structures with respect to phase topology, periodicity, and relevant scaling lengths.
- Identify dominant growth modes and related transitions with respect to solidification velocity and thermal gradient.
- Correlate selected growth modes to selection of locked-grain orientations or other special relationships between the phases.
- Compare with relevant growth models and establish basis for new analytical descriptions.

Relevance/Impact:

- The specification of appropriate microstructural descriptors and quantification of natural and forced selection dynamics will provide the means necessary to prescribe and control composite microstructures in multi-component multiphase metallic systems.
- Other potential applications include multiphase growth in nonmetallic systems where aligned composite structures may give rise to specific physical properties or device functionality (e.g. special optical behavior).

Development Approach:

- The principal solidification technique will be gradient-zone directional growth, equipped with off-axis gradient bias and rotation capabilities. The principal measurements will include microstructural (SEM) and orientation (EBSD) imaging with computer-aided stereological measurements.
- Growth experiments are sensitive to thermal fluctuations, and gradient measurements will be made with an accuracy of 0.25 K/mm.
- Microstructural measurements will be made with spatial resolution of approximately 50 nm (will vary).

Marshall Space Flight Center
Ground-based Research: Eutectic Ternary Alloys

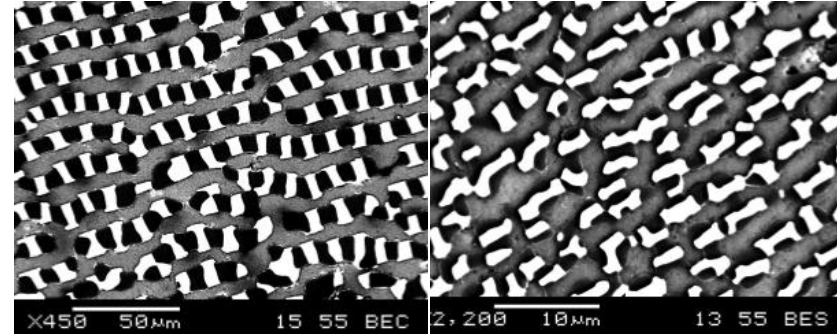

Directional solidification structures, showing a transition in growth morphology associate with an increase in velocity from 0.002 mm/s to 0.008 mm/s in nominal gradient of 5 K/mm. (Transvers cross-sections taken within 2 mm of the quenched growth front.)

ISS Resource Requirements

Accommodation (carrier)	Materials Science Research Rack/Materials Science Lab
Upmass (kg) (w/o packing factor)	5 kg each for SCAs
Volume (m³) (w/o packing factor)	690x185x185mm each
Power (kw) (peak)	2540 W (for 0.5 hrs), Total power maximum is 1820 W
Crew Time (hrs) (installation/operations)	1.5 hrs
Autonomous Operation	Except for SCA changeout
Launch/Increment	SpX-12, Inc 51/52/53

Effect of Varying Convection on Dendrite Morphology



ESA Investigation Name: *Effect of Varying Convection on Dendrite Morphology and Macro-segregation*

PI: Dr. David Poirier, University of Arizona

ESA Science Team Coordinator: Prof. Lorentz Ratke, DLR

Co-I: Surendra Tewari, Cleveland State University

Co-I: Dr. Robert Erdmann, University of Arizona

PS: Dr. Richard N. Grugel / NASA/MSFC

PM: Dr. James Patton Downey

Engineering Team: NASA MSFC/Teledyne Brown Engineering

WBS: 904211.04.06.30.19.06

Instrumentation & Experiment Summary

The experiments will be performed in MSRR, likely in the Solidification and Quench Furnace. The number of flight samples is 4, as is the number of Ground Truth samples.

Objective: *Determine the effects of a cross-sectional change during directional solidification on dendrite array morphology, distribution, crystallographic orientation, and macro-segregation.*

Relevance/Impact: Single-crystal dendritic gas turbine blades containing complex internal cooling channels are cast via directional solidification, which progresses through many cross-sectional area changes. The convective flows associated with such cross-section changes can be responsible for casting-defects, which lead to component rejections. This study will elucidate the role of gravity in the formation of these defects and by including changes in cross-sectional area, expands and enhances the knowledge to be gained in the other Poirier project (variation of translation/processing velocity). This investigation will also serve to enhance existing simulation models of directional solidification.

Development Approach: Al-7% Si and Al-15%Cu alloy samples will be directionally solidified through approximately 4:1 cross-sectional area change at a thermal gradient of approximately 40 K/cm. Microstructural defects associated with such solidification will be examined for a range of processing conditions in order to identify the optimal processing conditions for low gravity experiments on space station.

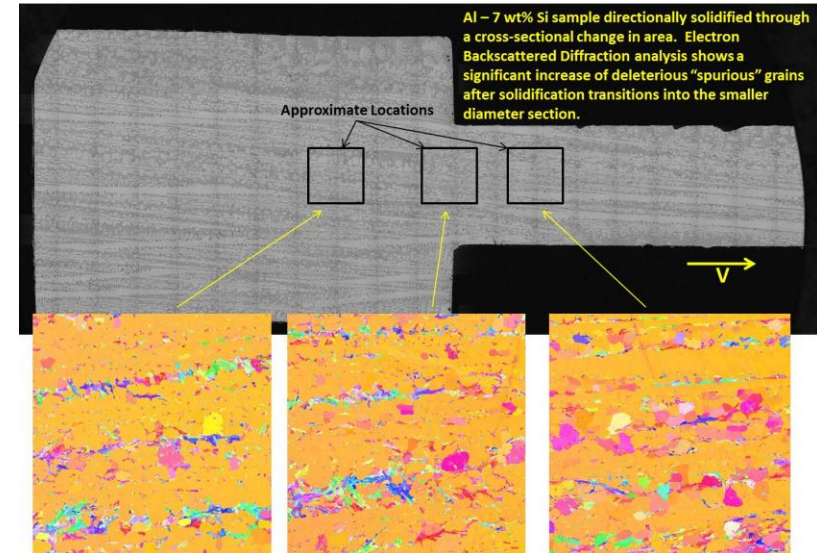

ISS Resource Requirements

Accommodation (carrier)	MSRR/MSL
Upmass (kg) (w/o packing factor)	12
Volume (m³) (w/o packing factor)	0.006
Power (kw) (peak)	2.54
Crew Time (hrs)	6
Autonomous Ops (hrs)	56*
Launch/Increment	SpX-12

Dr. Poirier processed ≈12 hours on MICAST-6 and 14 hours on MICAST-7 (one sample). An average process time of 14 hours/sample has been assumed (14 X 4 = 56). This includes an ample amount of time for heat-up, soak, and cool-down, in addition to processing at his required translation rates.

Systematic Investigation of Organized Elongated Pore Formation in Invariant Liquid to Solid Metal Plus Gas Transformations

Investigation Name: Systematic Investigation of Organized Elongated Pore Formation in Invariant Liquid to Solid Metal Plus Gas Transformations

PI: Dr. Douglas Swenson, Michigan Technological University

Co-I: Dr. Paul Sanders, Michigan Technological University

PS: Arthur L. Brown

PM: Dr. James Patton Downey

Engineering Team: TBD

WBS: 825080.04.06.30.19.04

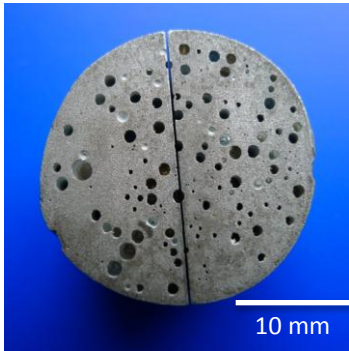

Aluminum gasarite casting with 20% porosity, cut in cross section to the resulting cylindrical pore structure. Pores average 1 mm in diameter and are greater than 2 cm in length.

Instrumentation & Experiment Summary

- Flight experiments will be performed in the Solidification Quench Furnace.
- Ampoules will require a transducer to measure gas pressure during solidification.
- Ampoules and cartridges should be constructed of materials with low diffusivities of hydrogen.
- A small amount of dissolved hydrogen ($\ll 1g$) in the samples is a safety concern.

Objective: To investigate the combined effects of solidification rate and gas pressure on the microstructures of gasarite materials (defined below)

Relevance/Impact: Gasarites (porous solids formed from melts containing dissolved gas) have pore alignment and uniformity that are often superior to other metal foams, resulting in unique properties. However, a lack of understanding of this solidification process hampers gasarite development. When present, gravitational effects, especially gas pore buoyancy and convection, are expected to impact significantly gasarite microstructure.

Development Approach: Ground-based experiments will provide data relating gasarite porosity, pore diameter, and pore alignment to solidification rate and gas pressure in Cu and Al gasarites. Existing solidification models will be tested and refined using these data. Flight experiments will provide further test data unperturbed by buoyancy and convection effects, allowing confirmation of these effects in the refined solidification models. The PI requests 9 flight samples, to provide a 3x3 matrix of data that varies both solidification rate and gas pressure.

ISS Resource Requirements

Accommodation (carrier)	SQF
Upmass (kg) (w/o packing factor)	27
Volume (m ³) (w/o packing factor)	0.135
Power (kw) (peak)	2.54
Crew Time (hrs)	9
Autonomous Ops (hrs)	108
Launch/Increment	Early 2018

Crystal Growth of Ternary Compound Semiconductors by Vapor Transport



PI: Dr. Ching-Hua Su, NASA MSFC; PM: Dr. James Patton Downey

ESA Team Coordinator: Dr. Michael Fiederle, Albert-Ludwigs Universitat Freiburg

Objectives:

- To establish the relative contributions of gravity-driven fluid flows to the formation mechanism of (1) the non-uniform incorporation of point defects, such as dopant, impurity, and vacancy and (2) the extended defects, such as twinning, observed in the grown crystals as the results of buoyancy-driven convection and irregular fluid-flows.
- To evaluate the additional effects of gravity on the PVT growth processes by examining (1) the growth kinetics on various seed orientations (2) dopant distribution in the Cr doped ZnSe and (3) the compositional segregation and distribution in the ternary compounds grown by PVT.
- To assess self-induced strain effects developed during processing at elevated temperatures and retained on cooling caused by the weight of the crystals

Relevance/Impact:

- Crystal quality greatly influences the important electronic and optic properties in semiconductors.
- Studies in microgravity will be compared with three-dimensional numerical simulation including both mass transport and heat transfer to establish a fundamental understanding of the crystal growth process which will be used to optimize the crystal processing on Earth.

Flight Experiments:

- The experiments will be processed in the Low Gradient Furnace (LGF) in the Materials Science Research Rack (MSRR), International Space Station (ISS).
- ISS resource requirements:

Ground-based Research:

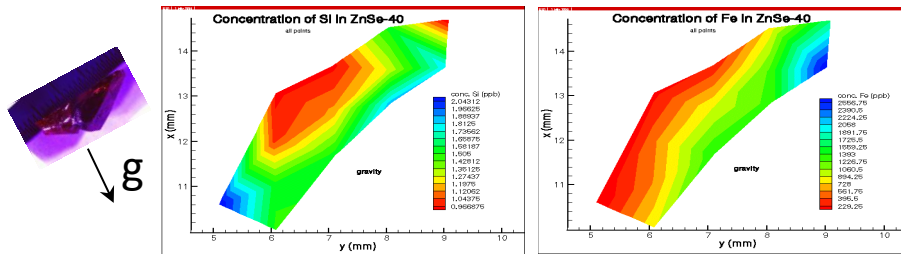

A horizontally grown crystal showed the segregation in the Si and Fe concentrations relative to the gravity vector.

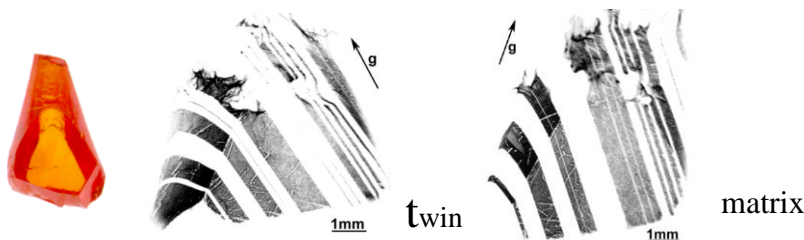

The synchrotron topography delineated the detrimental defect of twinning.

Accommodation (carrier)	LGF within MSRR
Upmass (kg) (w/o packing factor)	5 per SCA
Volume (m ³) (w/o packing factor)	0.0236
Power (kw) (peak)	2.54
Crew Time (hrs) (installation/operations)	1.5
Autonomous Operation	8 to 14 days (for each run)
Number of runs	9
Launch/Increment	47/48/49

Influence of Containment on the Growth of Silicon-Germanium (ICESAGE)



U.S. PI: Dr. Martin P. Volz, NASA/MSFC

ESA Team Coordinator: Prof. Dr. Arne Cröll, University of Freiburg, Germany

PS: Frank Zimmerman, NASA, MSFC

PM: Dr. J. Patton Downey, NASA, MSFC

WBS: 904211.04.06.30.03

NASA Objectives and Contributions:

- Partially detached crystals can be grown on Earth
- Test the theory that solidification free of wall contact reduces defect density.
- Evaluate competing theories for the production of critical materials by testing different growth configurations and using the space environment

Relevance/Impact:

- Defects in semiconductors propagate into the final electronic devices thereby reducing their performance
- Ideal is a breakthrough in understanding and control of detached terrestrial growth in many materials of technological and commercial interest.

Development Approach:

- Flight experiments utilizing the Bridgeman growth technique will be performed to study the crystallization of semiconductors in conditions which are ideally suited to providing detached growth of the crystal, i.e. the liquid-solid interface does not contact the ampoule wall.
- German team members will make use of free flyers (FOTON) and concentrate on experiments using the float zone crystal growth technique.

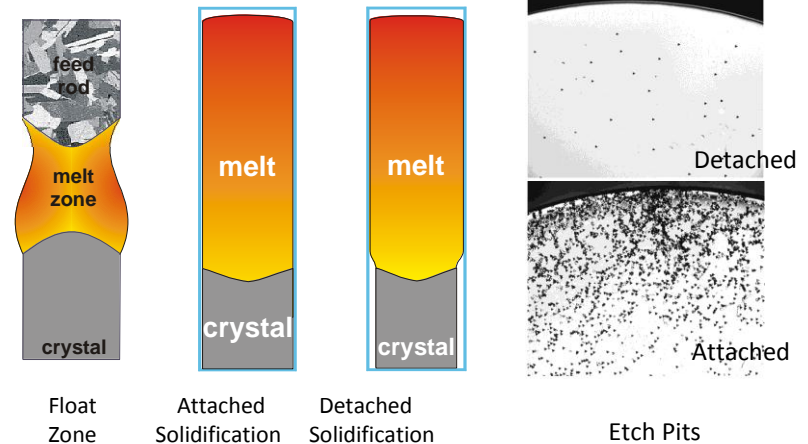

ISS Resource Requirements

Accommodation (carrier)	LGF within MSRR
Upmass (kg) (w/o packing factor)	5
Volume (m³) (w/o packing factor)	0.15
Power (kw) (peak)	2.54
Crew Time (hrs) (installation/operations)	1.5
Autonomous Operation (hrs)	816
Launch/Increment	45/46

Unified Support for THERMOLAB-ISS, ICOPROSOL, and PARSEC



WBS: 904211.04.06.30.18.01

U.S. PI: Dr. Robert Hyers, University of Massachusetts
DLR Team Coordinator: Dr. Thomas Volkman, Germany

NASA Objectives and Contributions:

- Provide magnetohydrodynamic (MHD) modeling support of macroconvection in various materials for three ESA sponsored projects:
 - Supports Peritectic Alloy Rapid Solidification with Electromagnetic Convection (PARSEC).
 - Supports Thermophysical Properties of Liquid Metallic Alloys – Modeling of Industrial Solidification Processes and Development of Advanced Products (THERMOLAB – ISS).
 - Supports Thermophysical properties and solidification behavior of undercooled Ti-Zr-Ni liquids showing an icosahedral short-range order (ICOPROSOL).

Relevance/Impact:

- PARSEC: Investigating the effect of fluid flow on the solidification path of certain alloys. Control of the solidification path would enable tailoring of the microstructure and properties of metal parts for specific applications.
- THERMOLAB – ISS: Investigating the thermophysical properties of high-temperature materials. Many of these materials are used commercially. A better understanding of the physical properties will allow more efficient and more reliable production of metallic parts using these alloys.
- ICOPROSOL: Investigating the nucleation and growth of quasicrystals, and the effect of atomic-scale order on the macroscopic properties of these alloys. This fundamental investigation may improve our ability to tailor the microstructure of metals for commercial applications. Quantitative control of internal convection is essential to achieving overall objectives.

Development Approach

- Thermophysical property measurements in MSFC ESL and on ISS.
- Quantitative magnetohydrodynamic (MHD) simulations enable the use of flow as an experimental variable to be controlled.
- Results from thermophysical property evaluation will be combined with the MHD convection models to quantify the flow in each flight sample at each phase of the experiment.

NASA Marshall Space Flight Center

- ◆ Provides project scientist support.
- ◆ Ground based electrostatic levitator (ESL) support.
- ◆ Provides PI support
- ◆ Provides support to ESA

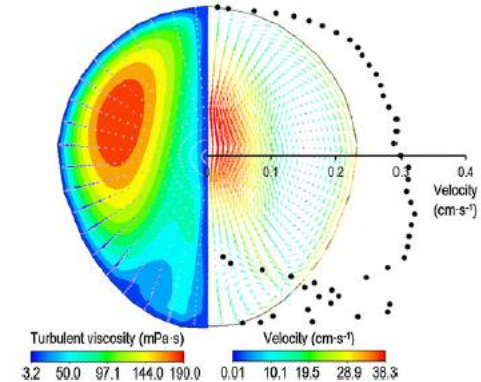

Quantitative validation of MHD modeling in CoCu sample processing in the DLR EML¹

ISS Resource Requirements

Accommodation (carrier)	Electromagnetic Levitator (EML) in Columbus Orbiting Facility
Launch/Increment	Batch 1: ATV-5 / Increment 41/42
Start of EML Ops	May-Nov 2014

1. Lee, et. al., Met. and Matls. Trans. B, 2013



Quasi-Crystalline Undercooled Alloys for Space Investigation (QUASI)

WBS: 904211.04.06.30.18.02

U.S. PI: Dr. Kenneth Kelton, Washington University
DLR Team Coordinator: Dr. D. Holland-Moritz, IFR, Germany

NASA Objectives and Contributions:

- Determine the influence of solid short-range order in the liquid on the crystal nucleation barrier.
- Determine the compositional dependence of the nucleation rate and evaluate a new coupled flux model for nucleation developed by the U.S. PI.
- Correlate the evolution of short-range order in the liquid with containerless measurements of thermophysical properties.
- Determine changes in the growth rate of the solid as a function of the complexity of the solid phase.
- Investigate a possible liquid/liquid phase transition

Relevance/Impact:

- ISS Studies will provide thermophysical property data needed for advanced computer-based modeling approaches to alloy development.
- ISS studies will provide new insight into diffusion-influenced nucleation processes needed for improved microstructural control in materials development.
- Complimentary Beamline ESL studies will allow unprecedented measurements of high-temperature materials phase diagrams and structural properties of high temperature liquids.
- The quasicrystals studied have unique structures holding promise for new alloys, with potential applications as IR detectors, hydrogen batteries and hard, high temperature, corrosion resistant coatings.

Development Approach

- Thermophysical properties of quasi- and polyhedral- phase forming alloys will be measured in the undercooled state, and their transformation to crystalline solids observed.
- Sensitivity to impurities from containers will be avoided by the use of levitators – in ground-based studies with an electrostatic levitator and on ISS with a German electromagnetic levitator.
- Many thermophysical properties can be measured in a levitator on Earth, but with convective contamination. This contamination plays a significant role in the formation of the intermediate phases. In particular nucleation and viscosity measurements demand quiescent conditions.

NASA Marshall Space Flight Center

- ◆ Provides project scientist support.
- ◆ Provides PI support.
- ◆ Provides support to ESA.

Ground-based Research – Electrostatic Levitator

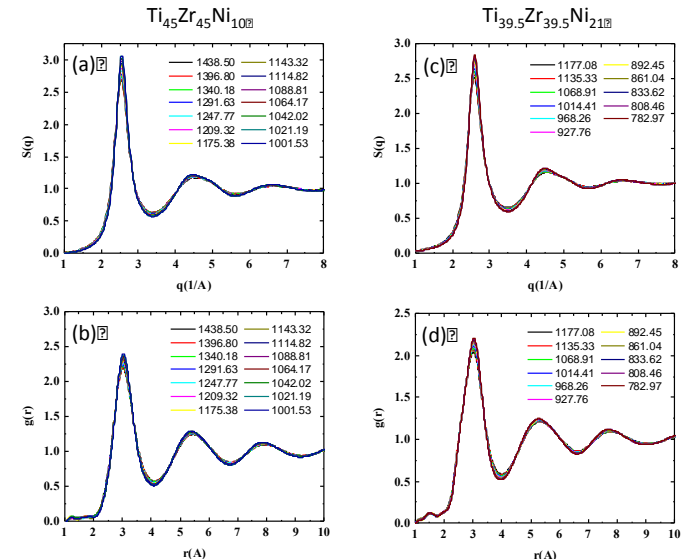

(a) Structure factor, $S(q)$, and (b) pair correlation function, $g(r)$, as a function of temperature for a $Ti_{45}Zr_{45}Ni_{10}$ liquid; (c) $S(q)$ and (d) $g(r)$ as a function of temperature for a $Ti_{39.5}Zr_{39.5}Ni_{21}$ liquid. The shoulder on the low- q side of $S(q)$ for $Ti_{39.5}Zr_{39.5}Ni_{21}$ is a signal of icosahedral short-range order in the liquid. Data obtained at the Advanced Photon Source using the Washington University ESL.

ISS Resource Requirements

Accommodation (carrier)	Electromagnetic Levitator (EML) in Columbus Orbiting Facility
Launch/Increment	Batch 1: ATV-5 / Increment 41/42
Start of EML Ops	May-Nov 2014

Electromagnetic Levitation Flight Support for Transient Observation of Nucleation Events



WBS: 904211.04.06.30.18.03

U.S. PI: Dr. Douglas Matson, Tufts University

ESA Coordinators: Dr. Thomas Volkman, DLR, Germany

Prof. Hans Fect, University-Ulm, Germany

NASA Objectives and Contributions:

- Peritectic Alloy Rapid Solidification with Electromagnetic Convection (PARSEC).
 - This program investigates the effect of fluid flow on the solidification path of peritectic structural alloys.
 - Materials which nucleate to a metastable phase followed by transition to a stable phase can exhibit properties very dependent on the convection associated with processing conditions.
 - Control of the solidification path would enable tailoring of the microstructure and properties of metal parts for specific applications.
- Thermophysical Properties of Liquid Metallic Alloys – Modeling of Industrial Solidification Processes and Development of Advanced Products (THERMOLAB – ISS).
 - Thermophysical properties of high temperature melts.
 - Research the influence of convection on the formation of different microstructure in alloys.
 - Studies the incubation time between formation of metastable phases and subsequent transformation to the stable phase for Fe-based and titanium aluminide alloys.

Relevance/Impact:

- Industrial welding, spray forming and casting operations for a class of soft magnetic materials, which have commercial and aerospace applications.
- In addition, this research addresses fundamental issues relating to rapid solidification behavior, metastable phase selection and analysis of the processes governing microstructural evolution.

Development Approach

- Results from thermophysical property evaluation will be combined with the MHD convection definition.
- Recalescences studies from the undercooled melt will be done in the MSL-EML.
- These results will be compared results from ground-based EML and ESL.
- Many thermophysical properties can be measured in a levitator on Earth, but with convective contamination. This contamination plays a significant role in the formation of the intermediate phases. In particular nucleation and viscosity measurements demand quiescent conditions.

NASA Marshall Space Flight Center

- ◆ Provides project scientist support.
- ◆ Ground based electrostatic levitator (ESL) support.
- ◆ Provides PI support.
- ◆ Provides support to ESA.

Ground-based Research – Electrostatic Levitator

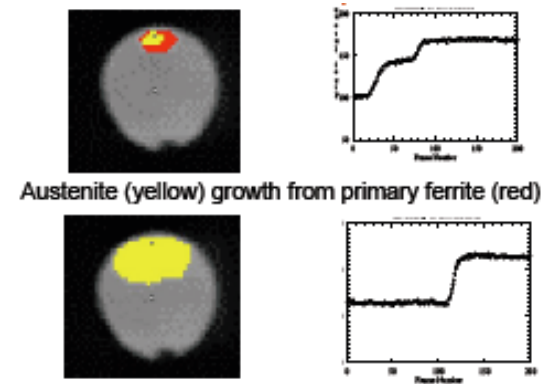

ISS Resource Requirements

Accommodation (carrier)	Electromagnetic Levitator (EML) in Columbus Orbiting Facility
Launch/Increment	Batch 1: ATV-5 / Increment 41/42
Start of EML Ops	May-Nov 2014

SPAtiotemporal evolution of three-dimensional Dendritic array Structures (SPADES)



WBS: 904211.04.06.30.06

Marshall Space Flight Center

U.S. Team: Prof. Rohit Trivedi, Iowa State University,
 Prof. Alain Karma, Northeastern University
 ESA Team: Prof. Bernard Billia and Dr. Nathalie Bergeon,
 Université Paul Cézanne, Marseille, France

DECLIC - Dispositif pour l'Etude de la Croissance et des Liquide Critiques.
 Accommodation will be CNES's DECLIC equipment housed within an EXPRESS rack
 DSI, Directional Solidification Insert will be used.

Objective:

- Quantitatively establish the fundamental physics controlling the spatiotemporal organization of the secondary sidebranch structure and its interaction with the array structure of primary branches under directional solidification conditions.
- SPADES focuses on the origin of sidebranches that occur when columnar solidification patterns transform from cellular to dendritic as a function of thermal gradient and solidification velocity and studies the potential for the formation of an intermediate multiplet pattern.

Relevance/Impact:

- The sidebranch instability under investigation is crucial for dendritic growth and for determining the solute segregation pattern in the "mushy" zone that largely governs the properties of cast alloys.
- Development of rigorous dynamic models of microstructure formation provides insight enabling the development of advanced materials of commercial importance.
- This investigation also provides an opportunity to gain an insight into the general problem of pattern formation, as solidification patterns are recognized to be similar to those forming in many other branches of science.

Development Approach:

- DSI experiments (SCN-0.24 wt% camphor) at high velocities suggested a possible coherent sidebranching mechanism
- DSI-R/SPADES composition (SCN-0.5 wt% camphor) will exhibit dendritic arrays at lower velocities, limiting front curvature while increasing tip radius, facilitating both interferometry and microscopy in this regime
- Sample will be observed by microscopy, interferometry with a resolution of 5 microns with a sampling rate – up to 25Hz
- Samples can be re-run at various solidification rates and with various temperature gradients. US PI will select his own experimental conditions.

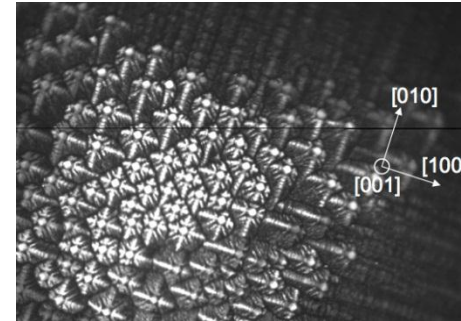

Coherent sidebranching observed in DSI with SCN-0.24 wt% camphor alloy

V = 30 μm/s and G = 12 °K/cm

ISS Resource Requirements

Accommodation (carrier)	DECLIC
Upmass (kg) (w/o packing factor)	20.53 kg (DSI-R)
Volume (m³) (w/o packing factor)	0.0210m ³
Power (kw) (peak)	0.46 kWh
Crew Time (hrs) (installation/operations)	1.5 (insert swap and RHDD swap)
Autonomous Operation	All autonomous except for initial installation of insert and then RHDD swap out as needed
Launch/Increment	Inc 41/42 SpaceX-6

Project Life Cycle Schedule

Milestones	SCR	RDR	PDR	CDR	VRR	Safety	FHA	Launch	Ops	Return	Final Report
Actual/ Baseline	11/03							12/14 SX-6			

The Effect of Macromolecular Transport on Microgravity Protein Crystallization

Investigation Name: The Effect of Macromolecular Transport on Microgravity Protein Crystallization

PI: Dr. Larry DeLucas (University of Alabama at Birmingham)

Co-Principal Investigator: Prof. Christian Betzel (University of Hamburg)

Co-I Dr. Dmitry V. Martyshekin (University of Alabama at Birmingham) Prof. Karsten Dierks (University of Hamburg)

Prof. Annette Eckhardt (University of Hamburg)

Consultants: Dr. Sergey Mirov (University of Alabama at Birmingham)

Dr. William W. Wilson, Prof. Emeritus

(Mississippi State Univ.)

PS: Laurel J. Karr (NASA-MSFC)

PM: Dr. James Patton Downey (NASA-MSFC)

Engineering Team: NASA-GRC

WBS: 914211.04.06.30.20.02

Instrumentation & Experiment Summary:

The Light Microscopy Module will be used to visualize and measure crystal growth rates of protein and virus crystals grown in replicate within optically clear cells of a sample module. Using the planned confocal laser-scanning fluorescent microscope, the percentage incorporation of different molecular aggregates into the crystalline lattice of growing crystals will be measured.

Objective: Validate the hypothesis that the improved quality of microgravity-grown biological crystals is the result of two macromolecular characteristics that exist in a buoyancy-free, diffusion-dominated solution: 1) Slower crystal growth rates, due to slower protein transport to the growing crystal surface and 2) Predilection of growing crystals to incorporate protein monomers versus higher protein aggregates due to differences in transport rates.

Relevance/Impact: A structural understanding of biological macromolecules helps to discern their mechanisms; once that is understood, the mechanism can be aided or, more commonly, impeded through pharmaceutical design. Determining structure is dependent upon X-ray crystallography of well ordered crystals. Growth in microgravity sometimes improves the quality of crystals, and this experiment will help determine the reasons behind this improvement.

Development Approach: Compare crystal growth rates and incorporation of protein aggregates of crystals grown on the ground versus those in microgravity. Compare the defect density and crystal quality via fluorescent-based atomic force microscopy and x-ray diffraction quality of crystals grown at different rates in a 1-g environment, using "Xtal Controller" to precisely control nucleation and growth rates of crystals.

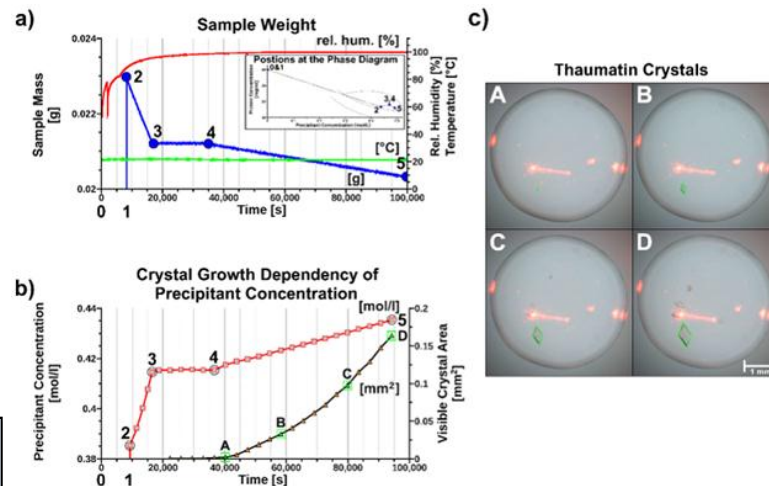

ISS Resource Requirements

Accommodation (carrier)	FIR/LMM
Upmass (kg) (w/o packing factor)	TBD
Volume (m³) (w/o packing factor)	TBD
Power (kw) (peak)	TBD
Crew Time (hrs)	TBD
Autonomous Ops (hrs)	TBD
Launch/Increment	February 2016

Amyloid fibril formation in microgravity: Distinguishing interfacial and flow effects

Investigation Name, PI: Prof. Amir Hirsu (Rensselaer Polytechnic Institute)

Co-I: Prof. Juan Lopez (Arizona State Univ.)

Project Scientist: Dr. Sridhar Gorti (NASA-MSFC)

Project Manager: Dr. James P. Downey (NASA-MSFC)

Engineering Team: TBD

Objective: To study protein amyloid fibril formation upon perturbing the native structure of a protein by hydrodynamic shear forces, using a containerless bioprocessor via optical imaging techniques.

Relevance/Impact: Formation of amyloid fibrils is widely studied because of its association with numerous neurodegenerative diseases, including Alzheimer's and Parkinson's disease. Amyloid fibril formation is a process by which destabilized protein molecules in solution form nuclei and aggregate into fibrils. Understanding the basic factors that promote protein destabilization and subsequent fibrillization is significant towards deciphering degenerative disease.

Development Approach: Design experimental apparatus and procedures to constrain protein solution to study fibrillization under various shear rates in the absence of solid walls, where containment is achieved via surface tension. Containerless protein solution droplets between 1 to 4 cm can also serve as bioreactors.

Instrumentation & Experiment Summary:

- Ground based Work: performed at Rensselaer Polytechnic Institute with flight experiments on ISS.
- Flight experiments: on International Space Station (2020).
- ISS requirements: TBD multi-user facility.

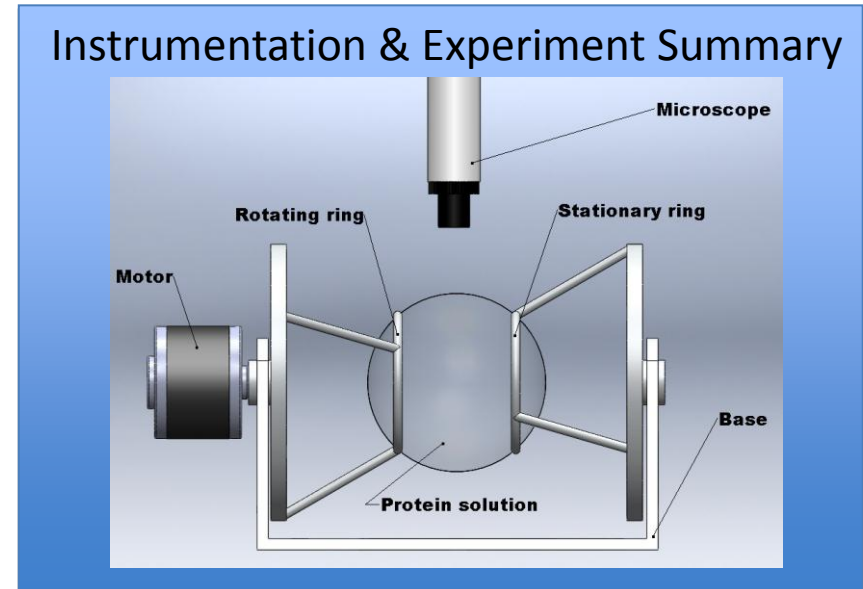

ISS Resource Requirements

Accommodation (carrier)	
Upmass (kg) (w/o packing factor)	
Volume (m ³) (w/o packing factor)	
Power (kw) (peak)	
Crew Time (hrs)	
Autonomous Ops (hrs)	
Launch/Increment	TBD

Project Life Cycle Schedule

Milestones	SCR	RDR	PDR	CDR	VRR	Safety	FHA	Launch	Ops	Return	Final Report
Actual/ Baseline	3/16	12/16	12/17	12/03	12/17	Phase III 11/18	1/19	2019	Inc 57-61	2020	2021

Growth Rate Dispersion as a Predictive Indicator for Biological Crystal Samples Where Quality can be Improved with Microgravity Growth

Investigation Name: Growth Rate Dispersion as a Predictive Indicator for Biological Crystal Samples Where Quality can be Improved with Microgravity Growth

PI: Dr. Edward H. Snell (Hauptman Woodward Med. Research Institute)

Co-I: Dr. Joseph Luft (Hauptman Woodward Med. Research Institute)

PS: Laurel J. Karr (NASA-MSFC)

PM: Dr. James Patton Downey (NASA-MSFC)

Engineering Team: NASA-GRC

WBS: 914211.04.06.30.20.04

Instrumentation & Experiment Summary:

The Light Microscopy Module will be used to visualize and measure growth rate dispersion of protein crystals grown in replicate within optically clear cells of a sample module.

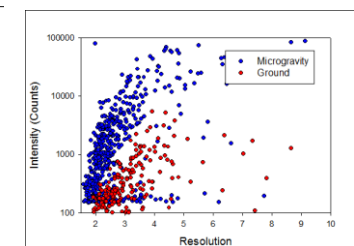
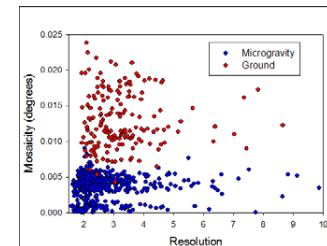
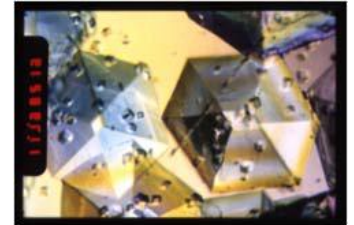
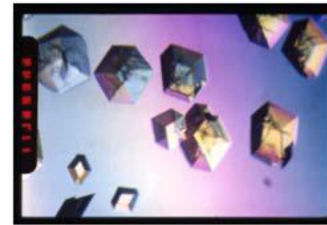

Objective: Validate the hypothesis that growth rate dispersion could be an indicator of crystals whose quality could be improved in microgravity. Growth rate dispersion is a phenomenon encountered in crystallization where seemingly identical crystals, produced from the same conditions, grow at different rates. It is contended that large growth rate dispersion on the ground is indicative of a sample that should be improved by microgravity growth.

Relevance/Impact: A structural understanding of biological macromolecules helps to discern their mechanisms; once that is understood, the mechanism can be aided or, more commonly, impeded through pharmaceutical design. Determining structure is dependent upon X-ray crystallography of well ordered crystals. Growth in microgravity sometimes improves the quality of crystals, and this experiment will help in determining which crystals can be improved by microgravity growth.

Development Approach: Use molecular biology techniques to shift the growth rate dispersion properties of a single protein from low to high. Monitor growth rate dispersion of crystals grown on the ground and in microgravity to determine if there is a correlation between the physical qualities of the resulting crystals with those measurements.

ISS Resource Requirements

Accommodation (carrier)	FIR/LMM
Upmass (kg) (w/o packing factor)	TBD
Volume (m³) (w/o packing factor)	TBD
Power (kw) (peak)	TBD
Crew Time (hrs)	TBD
Autonomous Ops (hrs)	TBD
Launch/Increment	February 2016

Solution convection and the nucleation precursors in protein crystallization

Investigation Name, PI: Prof. Peter Vekilov (Univ. Houston)
Co-I: Dr. Jacinta Conrad (Univ. Houston)
Co-I/Co-PI: Dr. Dominique Maes (Brussels, Belgium)

Project Scientist: Dr. Sridhar Gorti (NASA-MSFC)
Project Manager: Dr. James P. Downey (NASA-MSFC)
Engineering Team: TBD

Objective: To test if the absence of shear flow affects the concentration and properties of the nucleation precursors and establish the mechanisms of these effects.

Relevance/Impact: The existence of nucleation precursors and the correlation between their properties and the nucleation rate can be used to control protein crystal nucleation. Enhancement or suppression of nucleation can be used to achieve higher perfection of the grown crystals. Protein crystallization and improved crystal quality will aid in protein structure determinations and subsequently accelerate drug design.

Development Approach: Study the effects of solution flow on the cluster properties and nucleation. Test if the perfection of protein crystals can be improved by controlling nucleation via solution flow. In the absence of gravity driven convection and sedimentation effects on ISS, study the formation of clusters and nucleation processes at zero shear.

Instrumentation & Experiment Summary:

- Ground based Work: performed at University of Houston with flight experiments on ISS.
- Flight experiments: on International Space Station (2016).
ISS requirements: Microscope-EXPRESS rack (TBD).

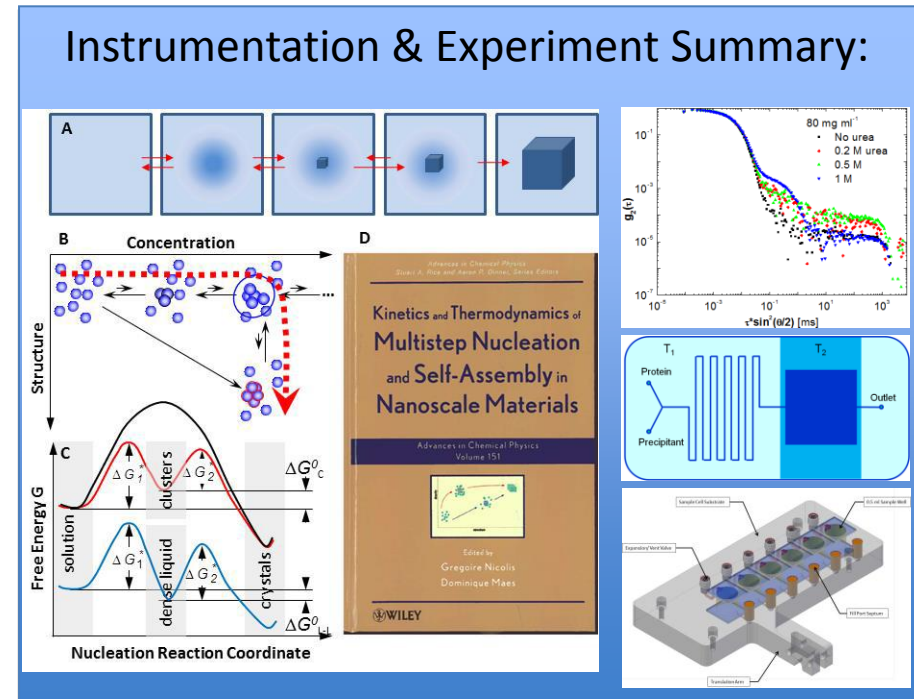

ISS Resource Requirements

Accommodation (carrier)	
Upmass (kg) (w/o packing factor)	
Volume (m ³) (w/o packing factor)	
Power (kw) (peak)	
Crew Time (hrs)	
Autonomous Ops (hrs)	
Launch/Increment	TBD

Root Mean Square Acceleration vs. Frequency

sams2, 121104 at LAB1O2, ER1, Lower Z Panel[148.54 - 40.54 135.25]
500.0000 aa/sec (200.00 Hz)
 $\Delta f = 0.006$ Hz, Nfft = 65536
Mode: 100aac

SAMS2, 121104, LAB1O2, ER1, Lower Z Panel, 200.0 Hz (500.0 s/sec)

Increment: 25, Right: UFS
Sum
Hanning, k = 415
Span = 14400.00 sec

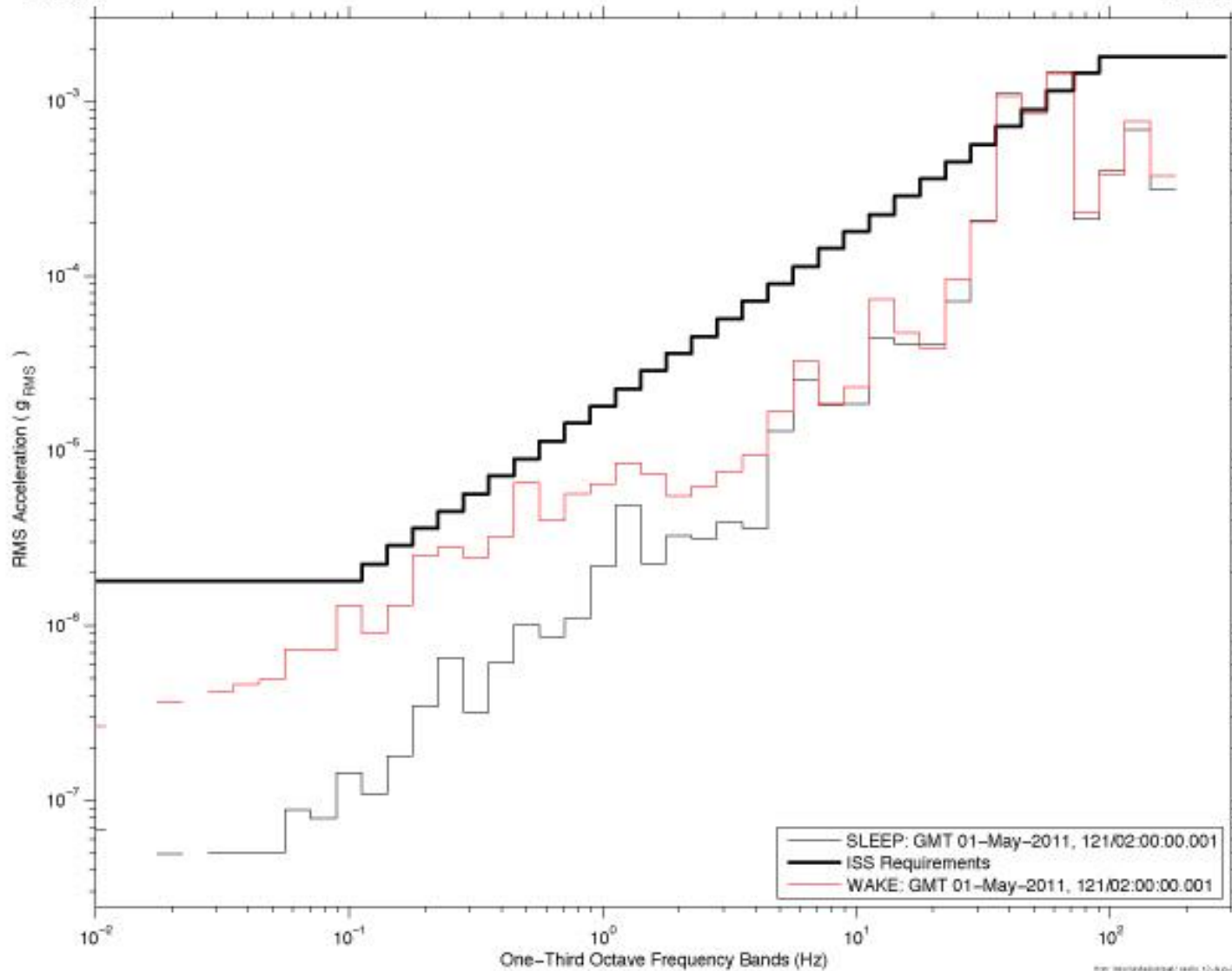

Plot: 121104LAB1O2.ER1.12-AUG-2011.10:59:23.00

Power Spectral Density/Time/Frequency Example

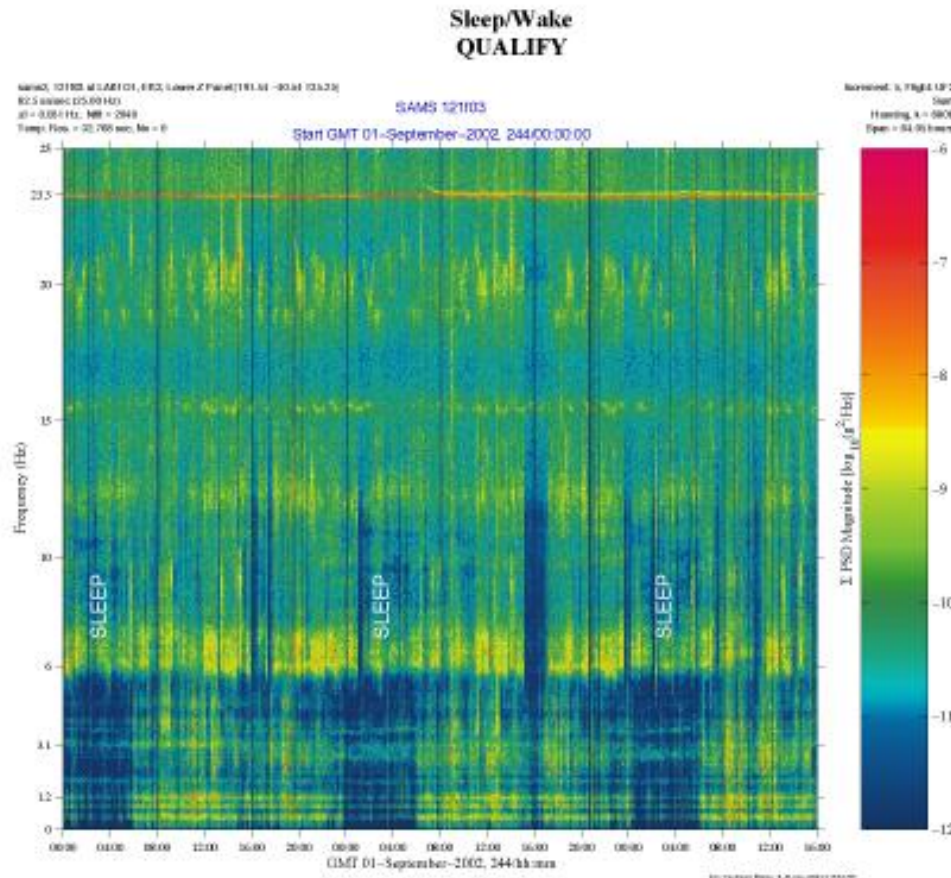

Data Description	
Sensor	121103 62.5 sq/sec (25.00 Hz)
Location	LAB101, ER2, Lower Z Panel
Inc/Flight	Increment: 5, Flight: UF2
Plot Type	spectrogram

Notes:
 This figure shows 3 sleep periods over a 64-hour span. The impact of crew wake periods relative to sleep is primarily below about 6 Hz. This is seen as a shift toward the blue end of the PSD magnitude color scale below about 6 Hz during the 3 sleep periods. The transition from sleep to wake is typically a sudden event owing to a wake alarm, while the transition from wake to sleep is gradual as might be expected. Signatures for both Russian air conditioners (SKV-1 and SKV-2) are also seen here toward the top of this figure at about 23.3 Hz. The slightly lower frequency and more intense SKV is on for this entire 64-hour duration, while the other one starts just after the end of the 2nd sleep period.

Regime:	Vibratory
Category:	Crew
Source:	Sleep/Wake



Microgravity Science Division



Glenn Research Center

PIMS ISS Acceleration Handbook
 Date last modified 12/31/02

Acceleration vs. Time Example

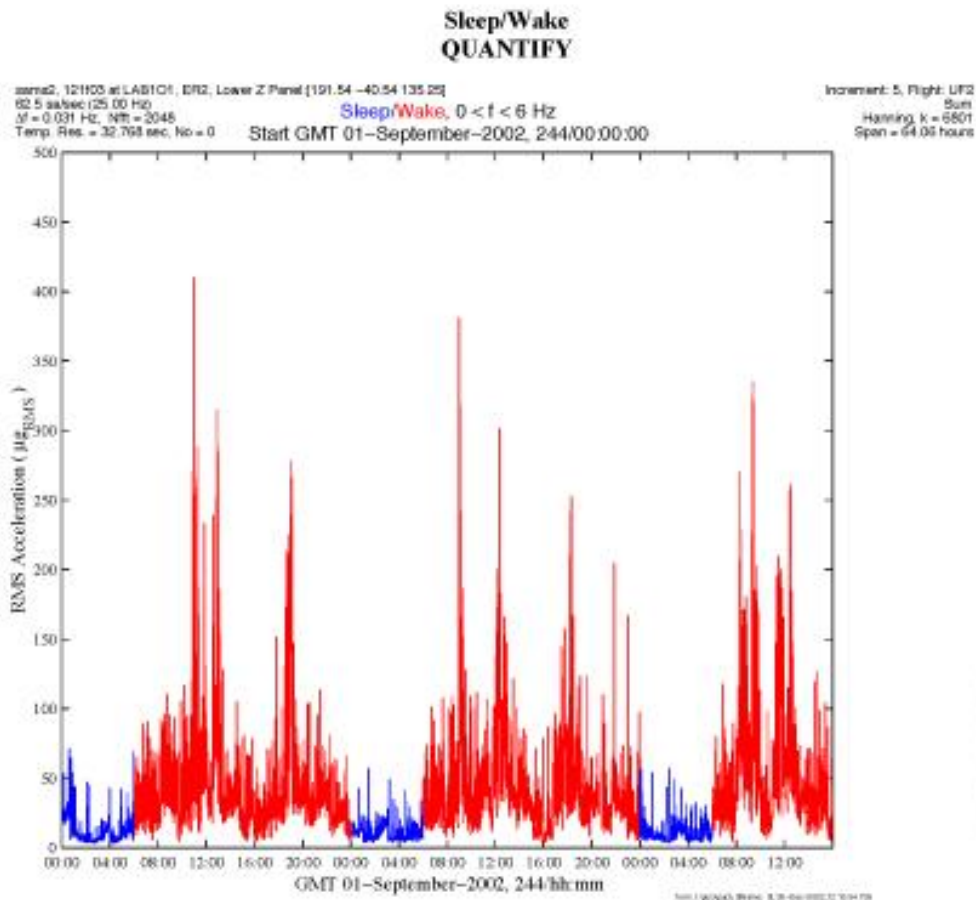

Data Description	
Sensor	121H03 62.5 sa/sec (25.00 Hz)
Location	LAB101, ER2, Lower Z Panel
Inc/Flight	Increment: 5, Flight: UF2
Plot Type	interval RMS

Notes:

The plot shows interval RMS values during a 64-hour period for the frequency band below 6 Hz. This is the portion of the acceleration spectrum that shows contrast between crew sleep and wake periods. Statistics gathered for this time frame show:

SLEEP

95th percentile: 25.8 µgRMS
median: 8.4 µgRMS
 mean: 11.2 µgRMS

WAKE

95th percentile: 123.6 µgRMS
median: 34.9 µgRMS
 mean: 46.0 µgRMS



Microgravity Science Division



Glenn Research Center

PIMS ISS Acceleration Handbook
 Date last modified 12/31/02

Regime:	Vibratory
Category:	Crew
Source:	Sleep/Wake

Power Spectral Density vs. Frequency Example

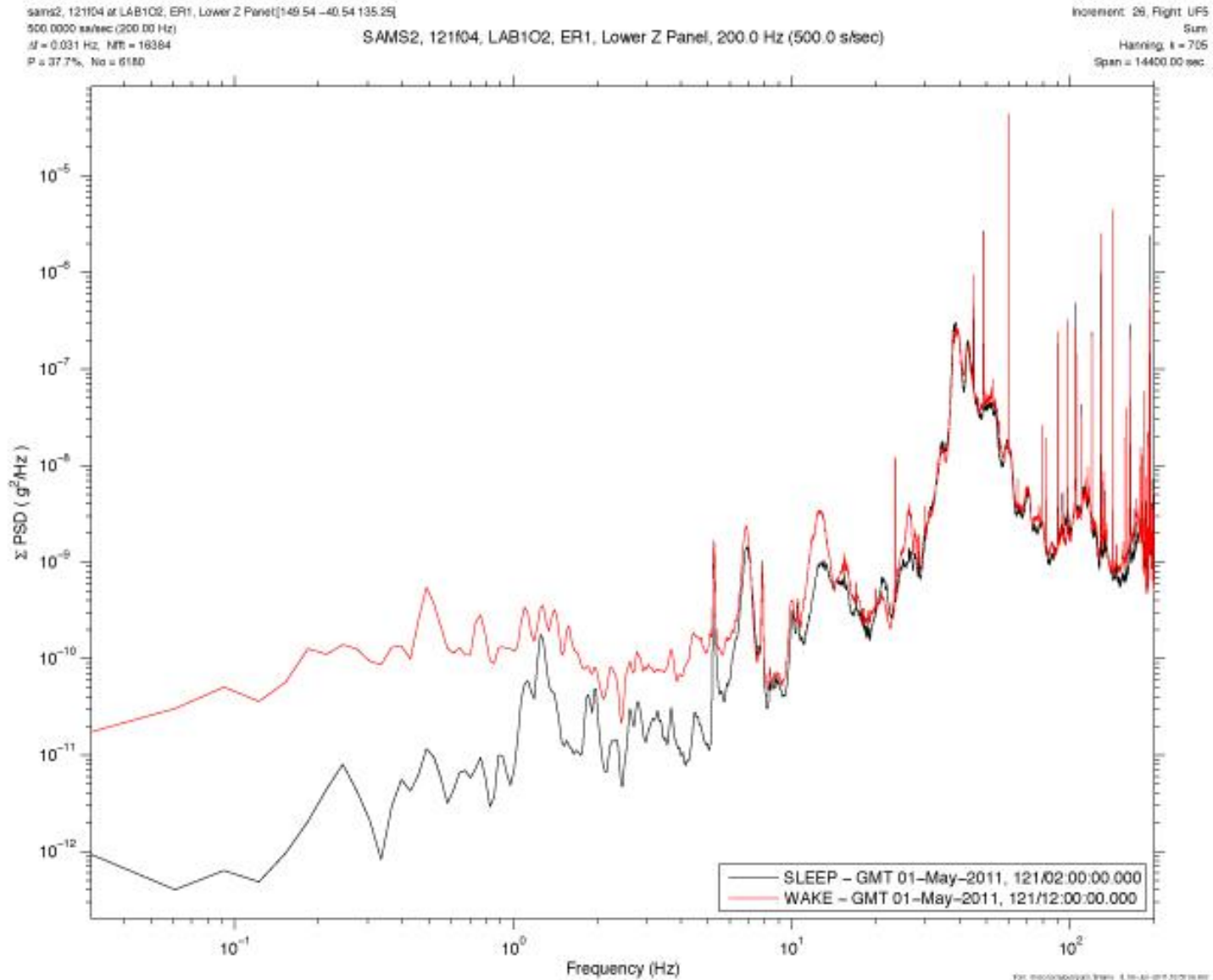

Worst-Case RMS from SSP

57006

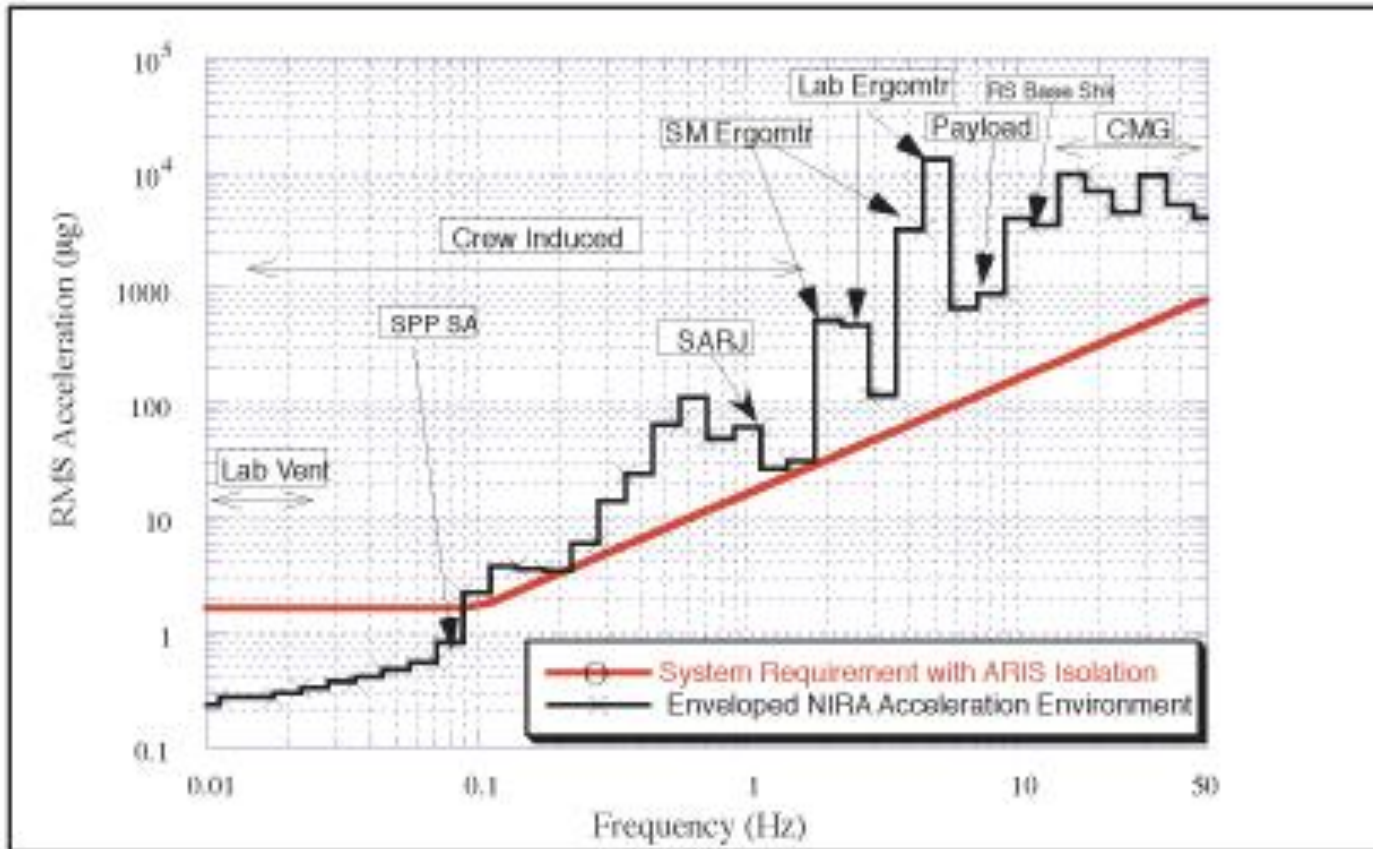
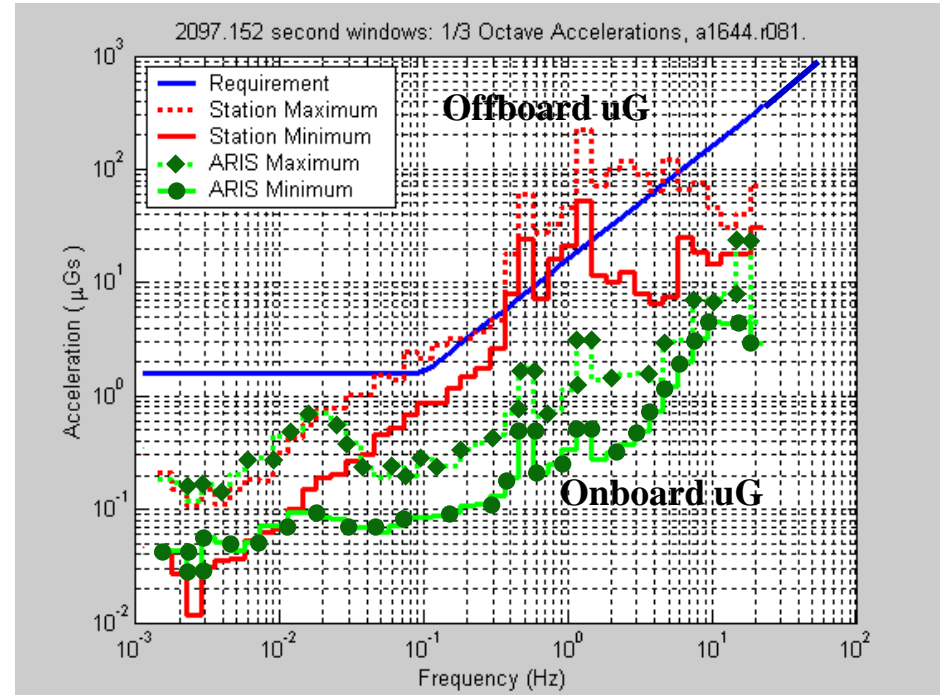
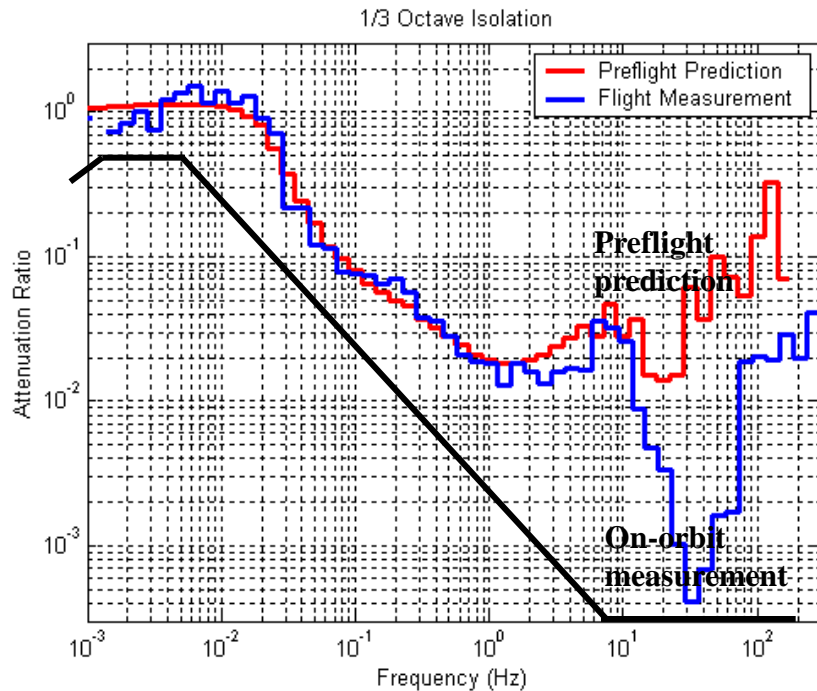

FIGURE 3.2-1 MICROGRAVITY RESPONSE PREDICTION (OVERALL ENVELOPE)

ARIS Measured Isolation and Onboard Acceleration Performance



- Note ARIS imparts an occasional 5 microg acceleration to recent the rack that is not shown on these plots.
- Onboard acceleration levels measured (right) during ARIS-ICE (6A- UF2) were well below the ISS requirement, with ARIS performing to the isolation level shown (left).
- Large onboard acceleration margin bodes well for Assembly Complete Microgravity.
- Preliminary assessments of Assembly Complete microgravity levels, based on measured isolation performance (left) are below the ISS requirement.

Overview of Activities by ISS Science Project Office in JAXA

M. Takayanagi
ISS Science Project Office, ISAS/JAXA



Japanese Experiment Module, "Kibo"

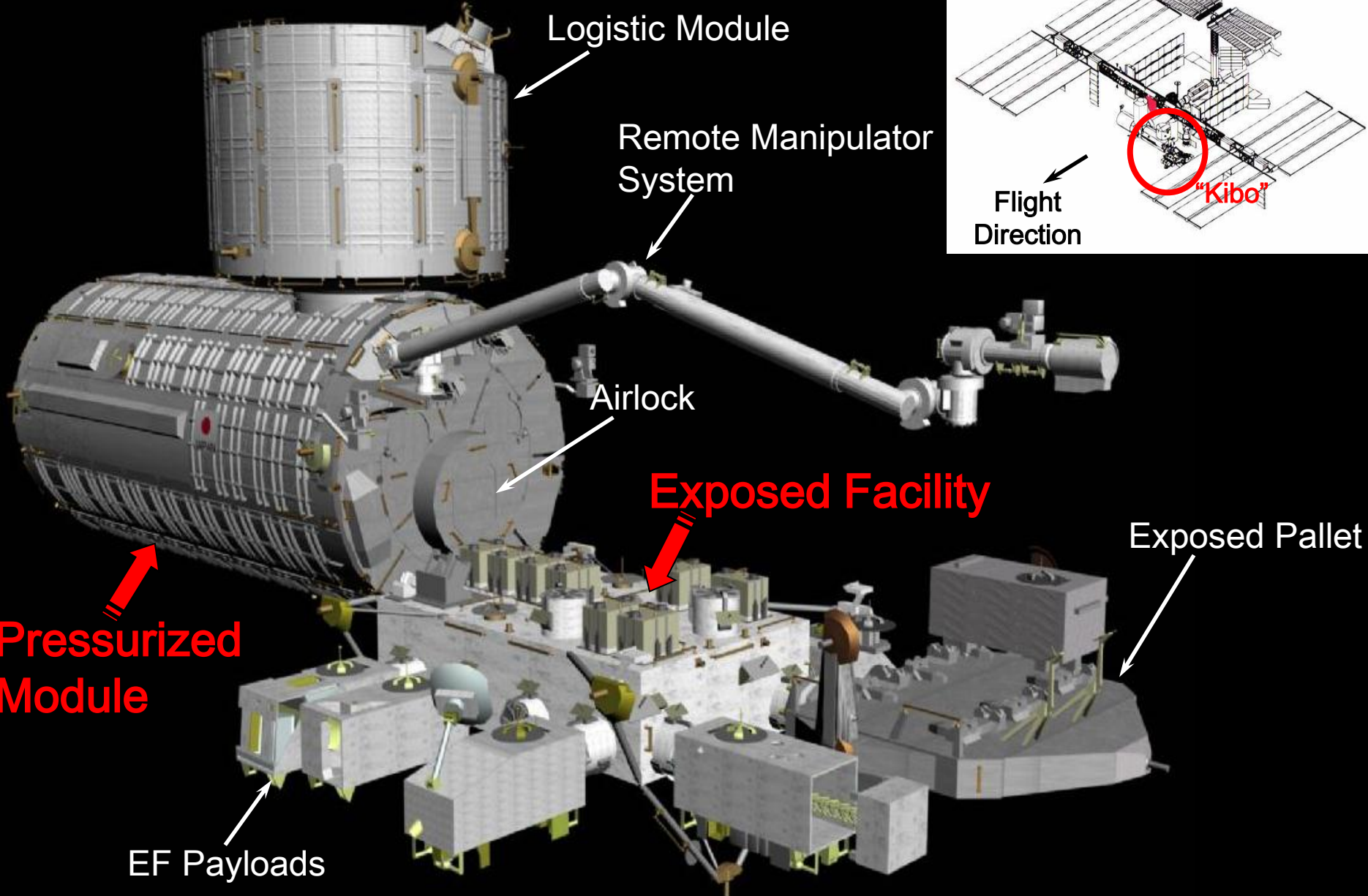

Ryutai Rack

流体(Ryutai); Fluid

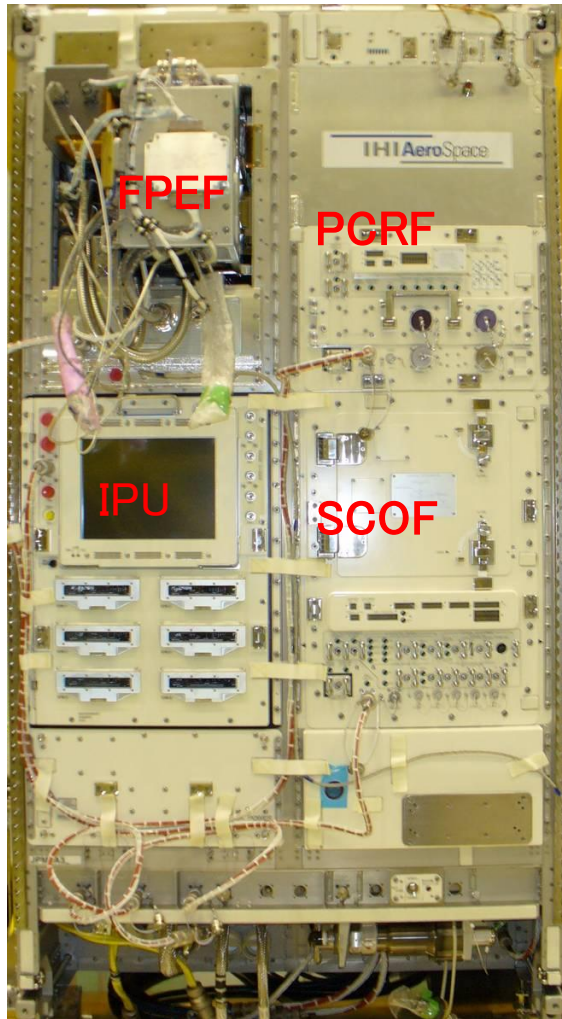

Ryutai Rack contains four facilities

- Marangoni Experiment series is performing in the **FPEF**
- FACET and Ice Crystal experiment have done in the **SCOF**
- High Quality Protein Crystal is under performing in the **PCRF**
- Image Processing Unit (**IPU**) support all experiment

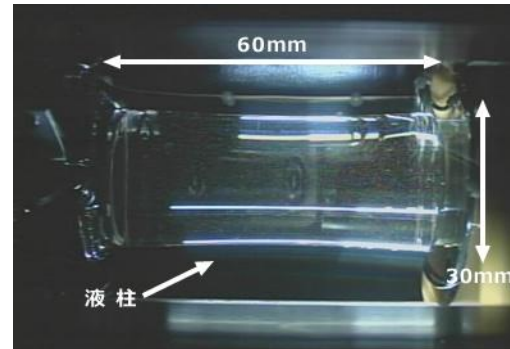

Liquid bridge to observe Marangoni convection



High Quality Protein Crystal Growth

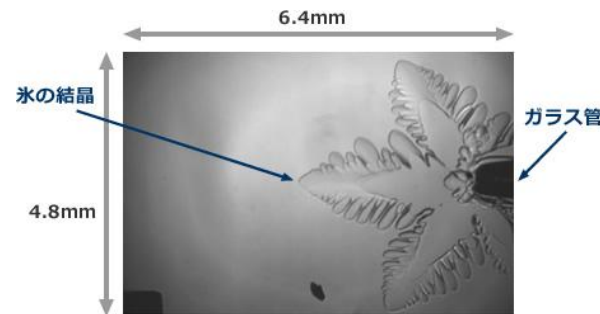

Space Ice Crystal (©JAXA / Hokkaido Univ.)

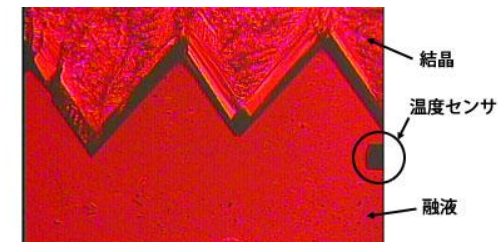

FACET Crystal growth (©JAXA)

Saibo Rack

細胞 (Saibo); Cell

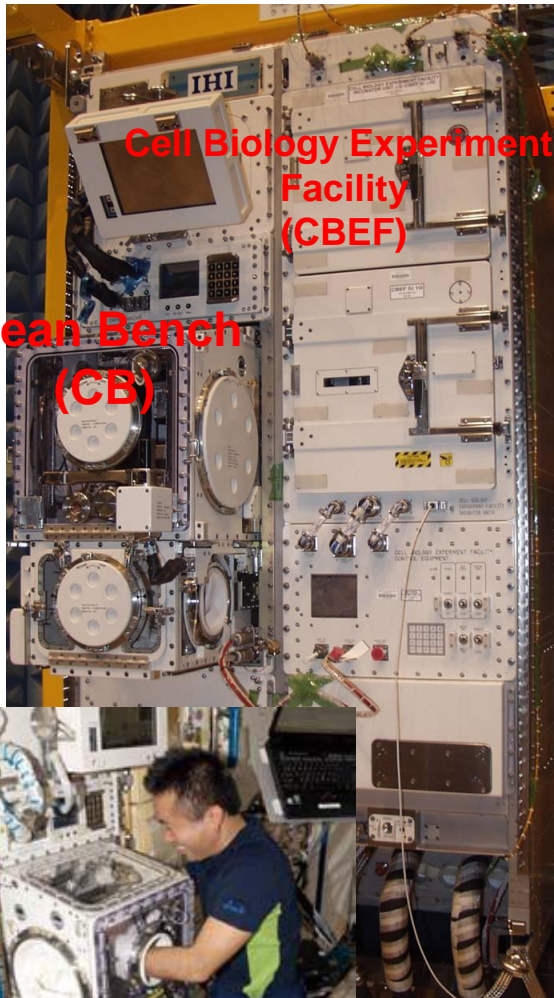

Cell Biology Experiment Facility (CBEF)

Clean Bench (CB)



Special culture bag designed for space experiment. **Rad Gene** and **LOH**:

Those experiments are investigate space radiation effect to cultured cell though gene expression



↑ radiation effect on ground



Rad Silk is biodosimetry experiment using silk worm eggs. eggs are in refrigerator in JEM to expose space environment until return.



Space Seed (©JAXA/Toyama Univ.)

Investigate seed to seed plant culture

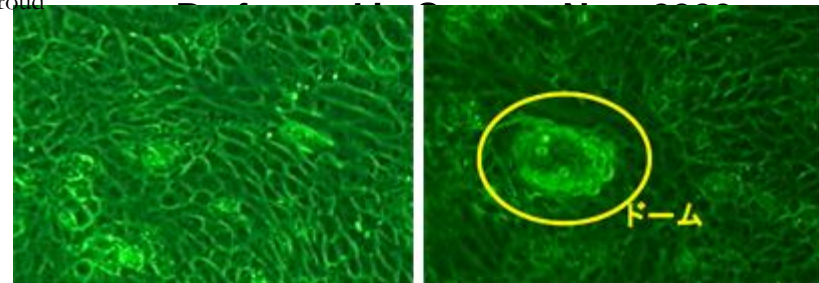

Dome Gene (©JAXA/Tokyo Univ.)

Special gene expression under microgravity using amphibian cell. Performed in March 2009

Kobairo Rack

勾配炉(Kobairo); Gradient Furnace



- ✓ Kobairo Rack contains a single facility, Gradient Heating Furnace (GHF).
- ✓ GHF; High-temperature electrical furnace with automatic sample exchange mechanism.
- ✓ Three Heater-Units generate temperature gradient of high precision for synthesis large scale crystals and alloys.

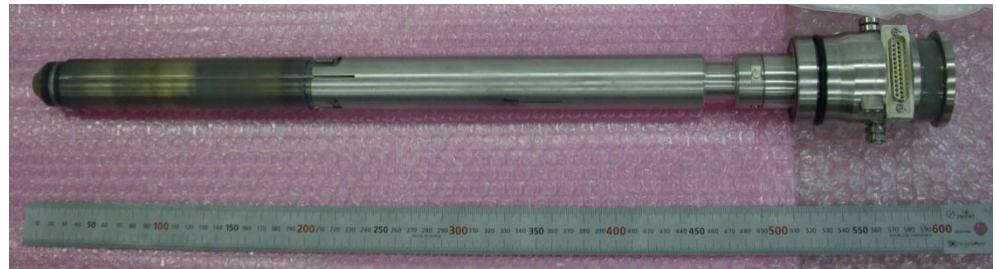

The 1st cartridge of “Hicari” experiment returned from orbit in March, 2013.

Multi-Purpose Small payload Rack (MPSR)

- Purpose
 - Provide experiment space, working table and resources such as electric power and communications for small experiment equipment.
 - The development cost of the user equipment should be low and the development schedule should be short.
- Overview & Specification
 - Free work space
 - Work bench
 - User friendly interface
 - Power: 28, 16, 12VDC
 - Communication: Ethernet, USB
 - Video: Standard and High Definition N
 - Cooling: cold plate, avionics air cooling
 - Vacuum bent / Gas supply
 - Experiment control by laptop PC
 - Safety
 - Temperature anomaly detection and power shutdown
 - Fire detection
 - Over-current protection

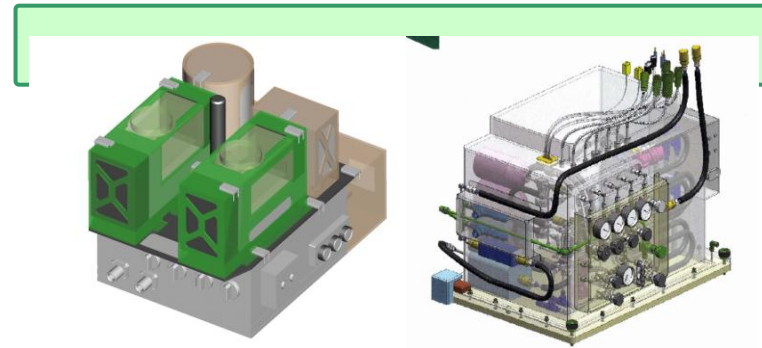

Aquatic Habitat

Group Combustion Equipment in the combustion chamber



3D photonic crystal

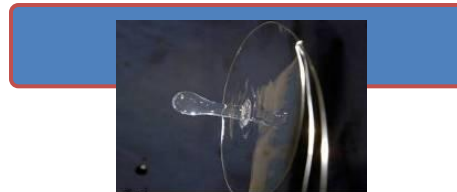

Educational experiment

Work Volume

Small experiment area

Work Bench

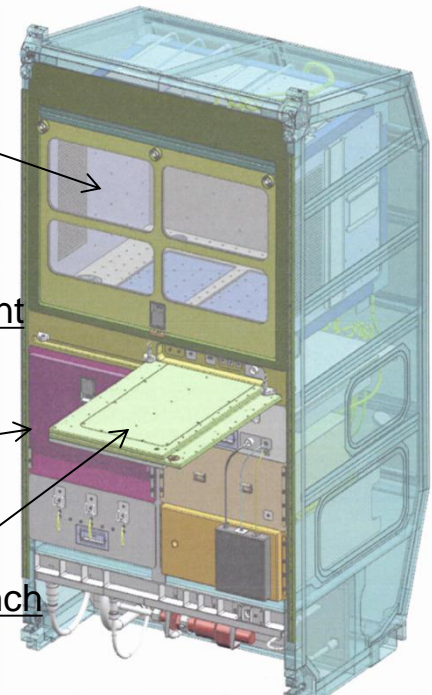

Conceptual Image

Electrostatic Levitation Furnace (ELF)

- Measure the thermo-physical properties concerning the high-temperature melt and the super cooled liquid
- Establish a theory concerning metastable material processing from super cooled condition
- Levitate metal and ceramic materials by an electro-static force and melt samples without container
- Now on FM development targeting to launch and installation in “Kibo”-PM in the middle of 2015

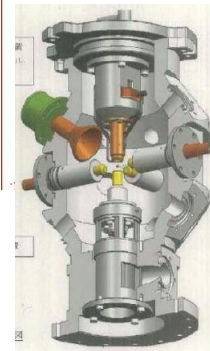
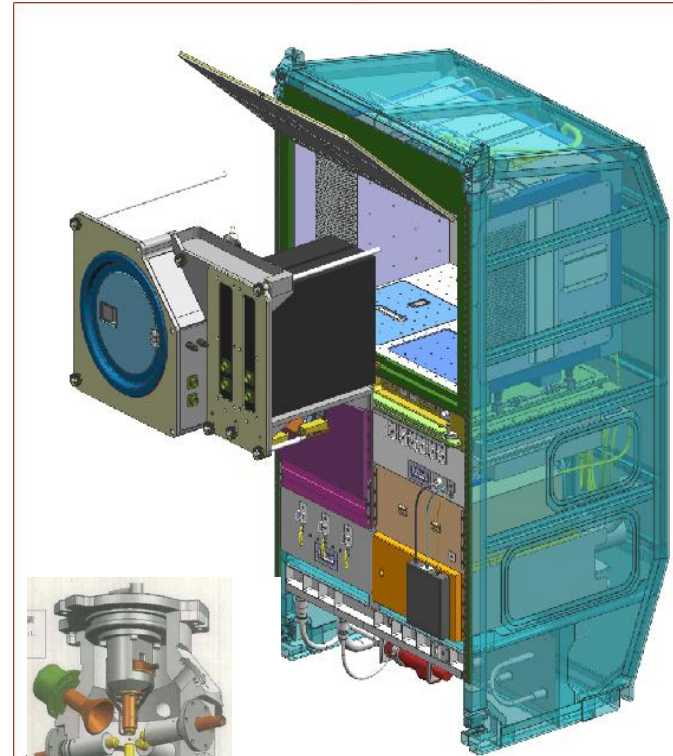

DECLIC OVERVIEW

- ❑ DECLIC : DEvice for the study of Critical Liquids and Crystallization
- ❑ Dedicated to Transparent Media
- ❑ First operations : October 2009
- ❑ Operated from CNES/CADMOS (France)
- ❑ Tele Science

Main Capabilities

- ❑ Inserts concept : numerous kinds of experiments.
- ❑ Storage capability : 320 GB onboard + 80 GB on Removable Hard Disks.
- ❑ Thermal control of scientific sample (see next slides)
- ❑ High and low temperature thermoelectric coolers and resistance heaters control.
- ❑ Stimuli (heat pulse) and measurement (pressure, temperature) inside cells.
- ❑ 3 cameras : 2 HR (1 Mpix/11.5 fps) and 1 HS (1 Mpix/923 fps)
- ❑ 1 μm optical resolution

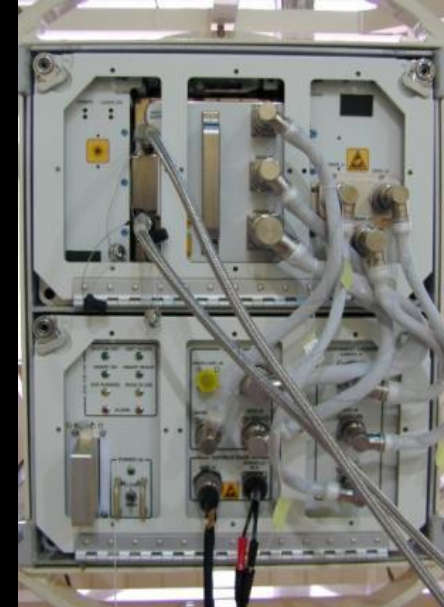

ALI (ALICE LIKE Insert)

Characteristics

- ❑ 2 cells filled with SF6 near its critical density
- ❑ Cells sizes :
 - ❑ $\phi 10.7$ mm, length 4.12 mm (direct)
 - ❑ $\phi 10.7$ mm, length 6.9 mm (interferometry)

Main Performances

- ❑ Range : up to 48°C (software)
- ❑ Accuracy: 10 mK with calibration
- ❑ Stability: better than ± 50 μ K/h
- ❑ Quenches: ± 0.1 to ± 100 mK
- ❑ Resolution: ± 1 μ K
- ❑ Gradient over fluid cell < 100 μ K/cm

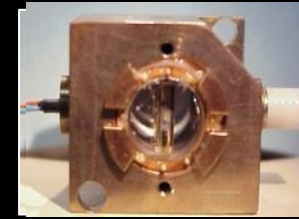

Interferometry Cell



Direct Observation Cell



Sample Cell Holder



Insert

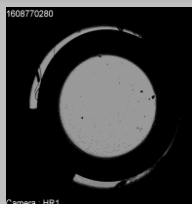

1608770280
Camera - HR1

Wide Field

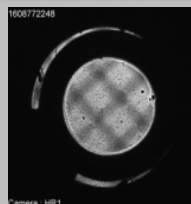

1608772248
Camera - HR1

Wide Field + grid



1608774536
Camera - HR1

Small Field

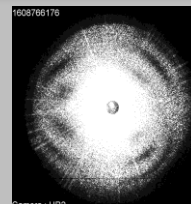

1608786176
Camera - HR2

Scattering

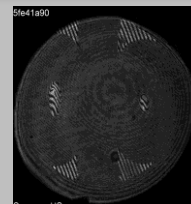

16e41e90
Camera - HS

Interferometry

HTI (High Temperature Insert)

Characteristics

- ❑ One cell filled with H₂O near its critical density (0.322 g/cm³)
- ❑ Fluid Volume : $\phi 9$ mm (0.3543 in) , length 5 mm (0.1969 in)

Main Performances

- ❑ Temperature Regulation (set point) : up to 395.5°C (software)
- ❑ Max rate: heating 10 mK/s, cooling 5 mK/s
- ❑ Accuracy: 40 mK with calibration
- ❑ Reproducibility: ± 10 mK
- ❑ Stability: better than ± 1 mK/h
- ❑ Quench: ± 1 to ± 300 mK
- ❑ Gradient over fluid cell < 1 mK/cm.



FM Cell (Transmission View)
(500 bars/600°C)



Sample Cell Holder



Insert



Wide Field



Wide Field + grid

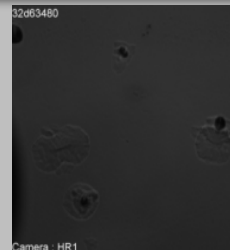

Small Field



Scattering

DSI (Directional Solidification Insert)

Characteristics

- ❑ Sample material (Succinonitrile) encapsulated in a cartridge.
- ❑ Silica cartridge: 10 mm inner diameter, 100 mm length
- ❑ Cartridge is moved by a driving mechanism at a controlled speed
- ❑ Temperature-gradient zone imposed by a heating zone and a cooling zone separated by an intermediate adiabatic zone.

Performances

- ❑ Cartridge speed : 0.1 to 30 $\mu\text{m/s}$ with 1% stability over 100 mm
- ❑ Furnace/heat-sink capabilities
 - ❑ Heat up to 160°C (stability 0.2 mK/h)
 - ❑ Freeze down to -30°C (stability 2 mK/h).
- ❑ Gradient over adiabatic zone : up to 70°C/cm
- ❑ Booster Heater in the adiabatic zone (7 W)

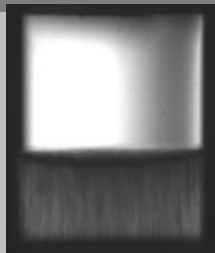
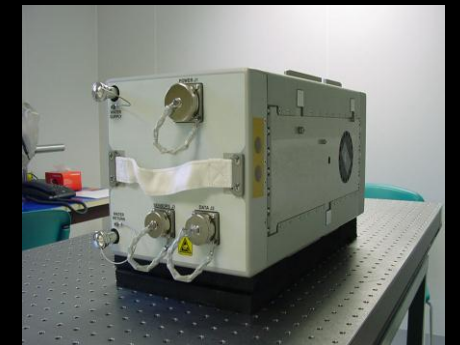
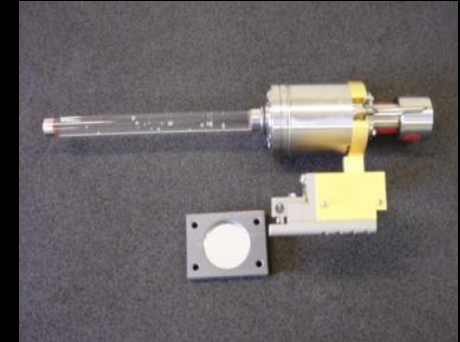

Transverse

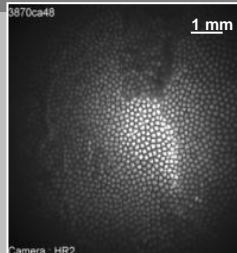

Axial Wide Field

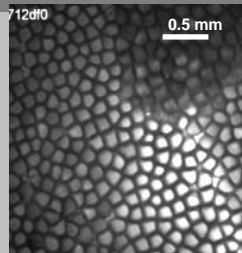

Axial Small Field



Interf, Wide Field

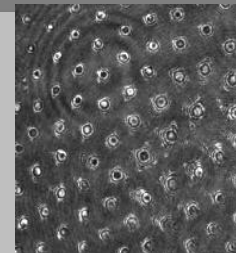

Interf, Small Field