

Chandra Contaminant Migration Model

Goals:

- (1) Determine if the observed change in Optical Blocking Filter (OBF) accumulation rate and spatial distribution can be explained by the known change in thermal environment caused by the ACIS housing (AH) heater being turned off in 2008 April.
- (2) Constrain the material properties of the contaminant(s)

Methods:

- (1) Simulate migration (vaporization/deposition) of potential organic contaminant(s) through evaporation (or sublimation) with thermal & geometric model constraints.
- (2) Compare time evolution of material mass column density by to observations at select locations on OBF filters to identify st candidate contaminant(s).

Study is extension of bake-out studies (2004, see O'Dell et al. SPIE 5898,313 (2005)). Details of new work, O'Dell et al. SPIE 859,0 (2013); especially, improved geometric/thermal model by Neil Tice.

View metadata, citation and similar papers at go.re.ac.uk

provided by NASA Technical Reports Server

brought to you by CORE

Chandra Contaminant Migration Model

Observational Constraints:

(1) OBF center accumulation history as determined by Alexey Vikhlinin (AV) from ECS and A1795 observations, expressed in terms of optical depth τ at Mn-L (~ 640 eV); [AV memo Dec. 2012]

(2) OBF edge-to-center evolution, edge at \sim row 64 center at row 512 [op.cit.]

(3) OBF near-edge (row 167) accumulation history as determined by Herman Marshall (HM) from grating observations, expressed in terms of optical depths at C and O absorption edges. Plus a few measurements nearer and farther from row 167.

Contamination Migration Model reports contaminant mass column density. Optical depth unity at Mn-L is *roughly* equivalent to a $100 \mu\text{g}/\text{cm}^2$ column

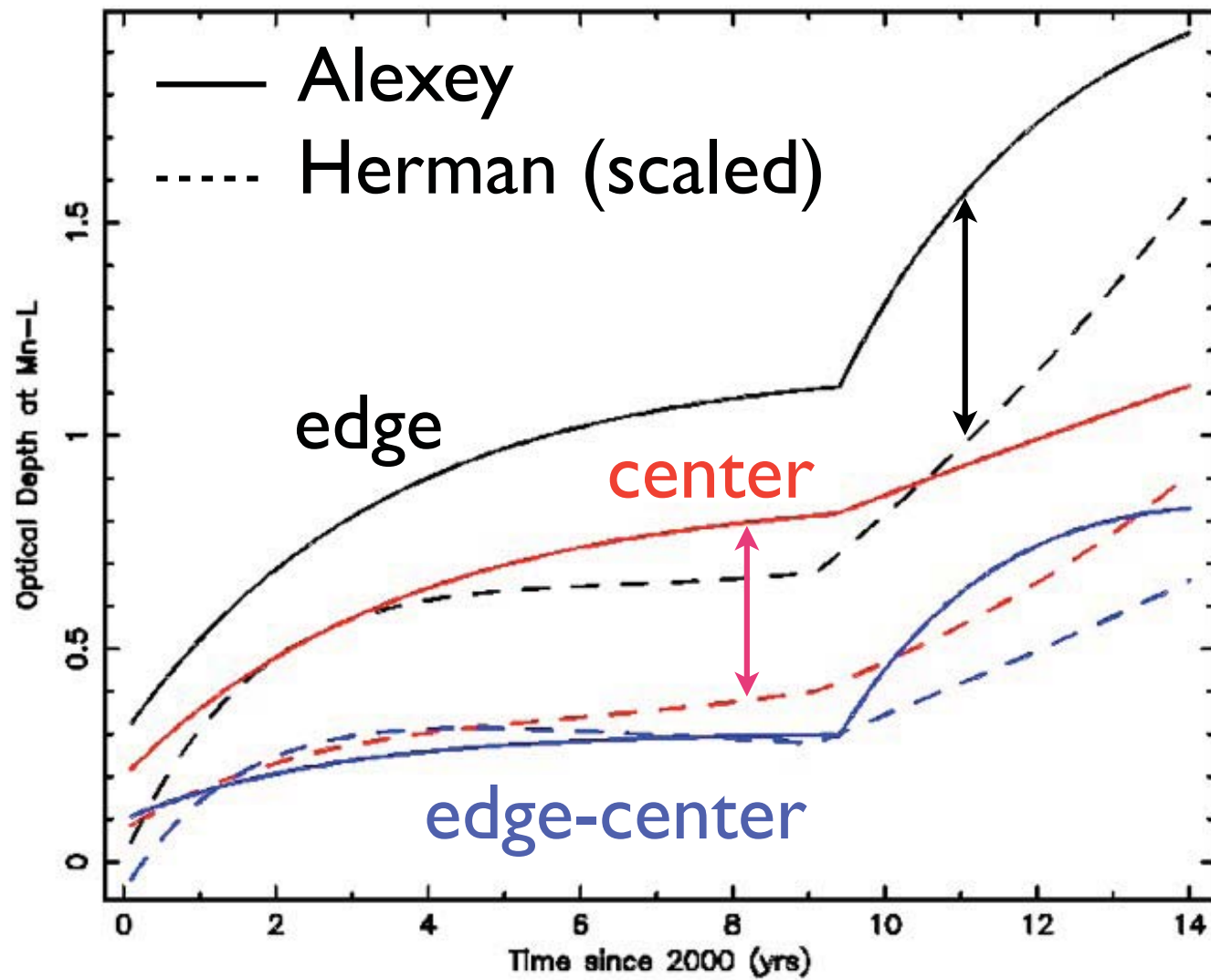

Chandra Contaminant Migration Model

The basic algorithm:

- ◆ Temperature dependence of vaporization rate follows Clausius-Clapeyron relation

- ◆ $\rho(T) = \rho(T_0) \exp(-\Delta H(T_0 - T)/RTT_0)$

where $\rho(T)$ is the mass vaporization rate at temperature T , ΔH is the vaporization enthalpy, and R the universal gas constant

- ◆ Solves for the evolution/migration of the mass column of contaminant on all surfaces using an explicit (forward) difference scheme to solve the initial value problem:

- ◆ $d\mu_i/dt = -\rho(T_i) + \sum_j \rho(T_j) (A_j/A_i) S_{ji}$

where the A_i are areas of surfaces and the view factors S_{ji} are the fraction of the opening angle of surface j subtended by surface i .

Chandra Contaminant Migration Model

All simulations assume:

- ◆ A source rate of the form $S(t)=A+B\exp(-t/3.7)$ for all times, t , where time-dependence adjusted to follow AV's center τ evolution and normalization to match HM's corresponding mass surface density estimates for $t < 9$ yr.
- ◆ Time-averaged surface temperatures with AH heaters ON until ~ 2008.5 ($t=9$ yr) then AH heaters OFF as determined by Neil Tice (NT) from flight data & his geometric/thermal model
- ◆ An organic material w/ mass vaporization rate $\sim 10^{-7} \mu\text{g}/\text{cm}^2/\text{s}$ at temperatures ~ -50 °C
- ◆ Emissivity $\varepsilon = 0.05$ to 0.40 ; determines OBF temperatures (other surfaces are conductively coupled and insensitive to ε)
- ◆ A fixed fraction, $f_v = A_{\text{vent}}/(A_{\text{vent}}+A_{\text{TC}})$, of contaminant striking the telescope closeout (TC) at the top of the geometric model vents to space, where $A = \text{area}$

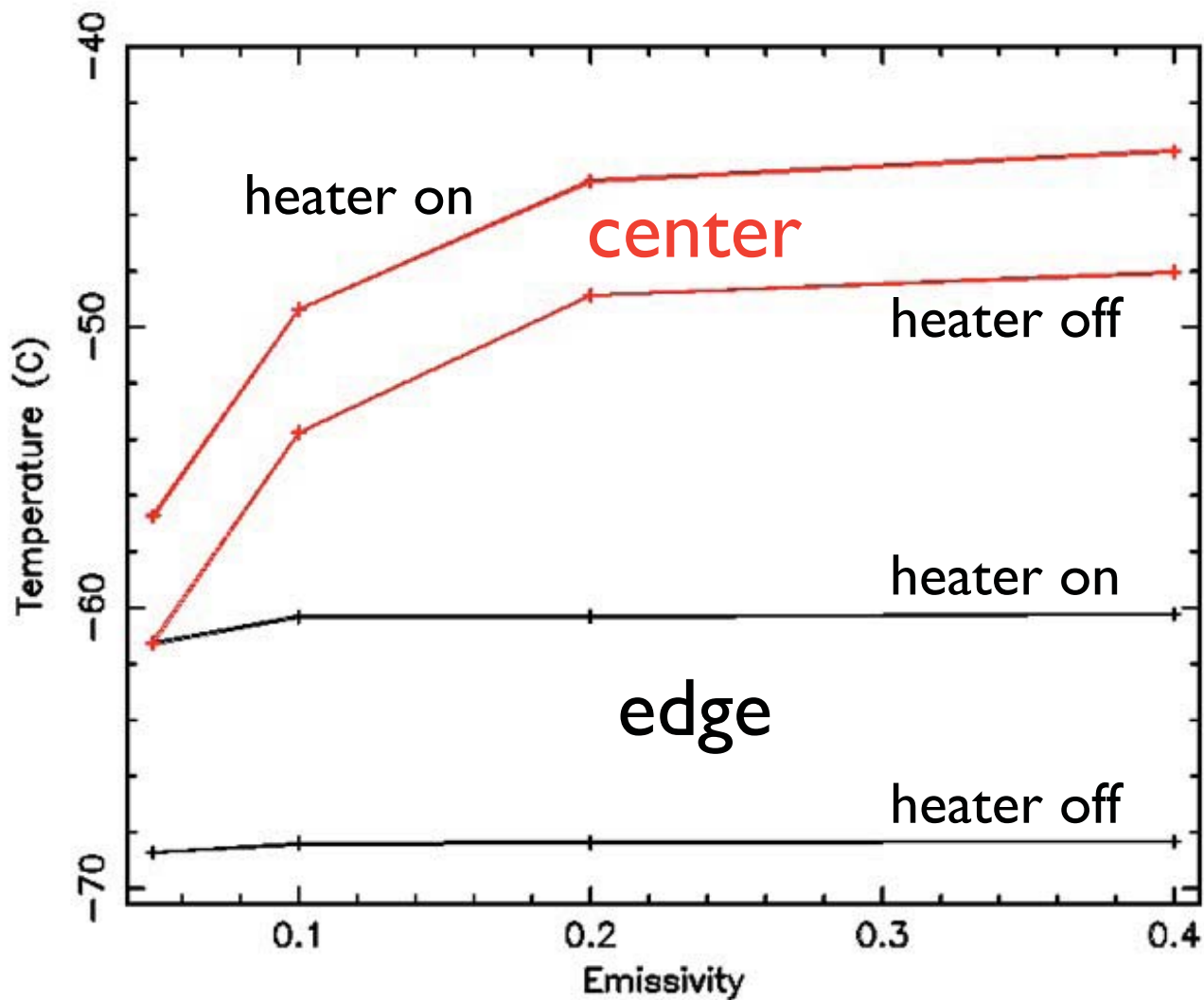

only OBF
centers are
 sensitive to ϵ

~8°C difference
 AH on/off

Summary of vaporization or sublimation

Name	tetra-decane ^a	penta-decane ^a	hexa-decane ^b	hepta-decane ^b	octa-decane	nona-decane ^c	ei-cosane	heni-cosane	do-cosane	tri-cosane ^c	tetra-cosane	penta-cosane	tetra-cosane	DOP	Unit
Formula	C ₁₄ H ₃₀	C ₁₅ H ₃₂	C ₁₆ H ₃₄	C ₁₇ H ₃₆	C ₁₈ H ₃₈	C ₁₉ H ₄₀	C ₂₀ H ₄₂	C ₂₁ H ₄₄	C ₂₂ H ₄₆	C ₂₃ H ₄₈	C ₂₄ H ₅₀	C ₂₅ H ₅₂	C ₂₆ H ₅₄	C ₂₄ H ₃₈ O ₄	
Mol Wt	198	212	226	240	254	268	282	296	310	324	338	352	366	390	amu
Δ _{l-g} H	72	77	82	86	91	96	102	107	112	117	122	127	132	110	kJ mol ⁻¹
Δ _{s-g} H	118	109	135	126	153	143	170	170	189	192	208	211	224	150	kJ mol ⁻¹
Δ _{s-l} H	46	32	53	40	62	47	68	63	77	75	86	84	92	40	kJ mol ⁻¹
ln(P _v (T _r))	0.46	-0.54	-1.66	-2.77	-3.91	-5.04	-6.17	-7.31	-8.45	-9.55	-10.65	-11.72	-12.78	-11.50	ln[Pa]
P _v (T _r) l-g	1.6E+00	5.8E-01	1.9E-01	6.3E-02	2.0E-02	6.5E-03	2.1E-03	6.7E-04	2.1E-04	7.1E-05	2.4E-05	8.1E-06	2.8E-06	1.0E-05	Pa
T _r	298	298	298	298	298	298	298	298	298	298	298	298	298	293	K
T _b	527	544	560	575	589	603	617	630	642	653	664	675	664	660	K
T _m	279	283	291	295	301	304	309	314	316	321	324	327	330	223	K

Vaporization or sublimation at +20 C relative to that at -60 C

D _{il} μ _v (293K)	3.5E+02	1.3E+02	4.2E+01	1.2E+01	2.2E+00	7.0E-01	1.0E-01	2.5E-02	4.5E-03	1.0E-03	1.6E-04	4.5E-05	8.0E-06	5.1E-03	μg cm ⁻² s ⁻¹
D _{il} μ _v (213K)	1.3E-05	1.2E-05	5.2E-08	5.3E-08	1.5E-10	2.2E-10	5.1E-13	1.2E-13	1.2E-15	1.6E-16	2.3E-18	3.9E-19	9.5E-21	9.4E-11	μg cm ⁻² s ⁻¹
D _{il} μ _v ratio	2.6E+07	1.1E+07	8.0E+08	2.3E+08	1.5E+10	3.2E+09	2.1E+11	2.1E+11	3.9E+12	6.1E+12	7.2E+13	1.1E+14	8.5E+14	5.4E+07	
P _v (293K)	9.6E-01	3.4E-01	1.1E-01	3.1E-02	5.4E-03	1.7E-03	2.4E-04	5.7E-05	9.9E-06	2.2E-06	3.5E-07	9.4E-08	1.6E-08	1.0E-05	Pa
P _v (213K)	3.1E-08	2.7E-08	1.1E-10	1.1E-10	3.1E-13	4.4E-13	1.0E-15	2.4E-16	2.2E-18	3.0E-19	4.1E-21	7.0E-22	1.7E-23	1.6E-13	Pa
P _v ratio	3.1E+07	1.2E+07	9.4E+08	2.7E+08	1.8E+10	3.8E+09	2.4E+11	2.4E+11	4.5E+12	7.2E+12	8.5E+13	1.3E+14	1.0E+15	6.4E+07	
ln(P _v) delta	17.24	16.34	20.66	19.43	23.59	22.05	26.21	26.21	29.14	29.60	32.07	32.53	34.53	17.97	
Δ _{c-g} H eff.	112	106	134	126	153	143	170	170	189	192	208	211	224	117	kJ mol ⁻¹

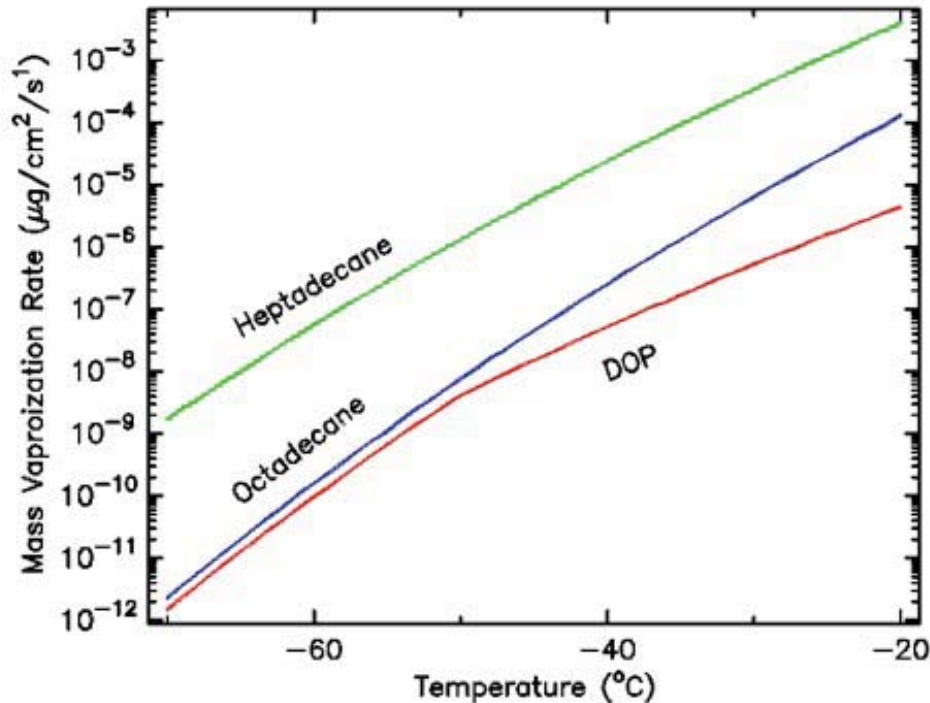

Simulations assume the known temperature dependence of one of several organic materials; $\rho(T_0)$ (normalization) is a free parameter

Optical Bench Closeout

Collimator

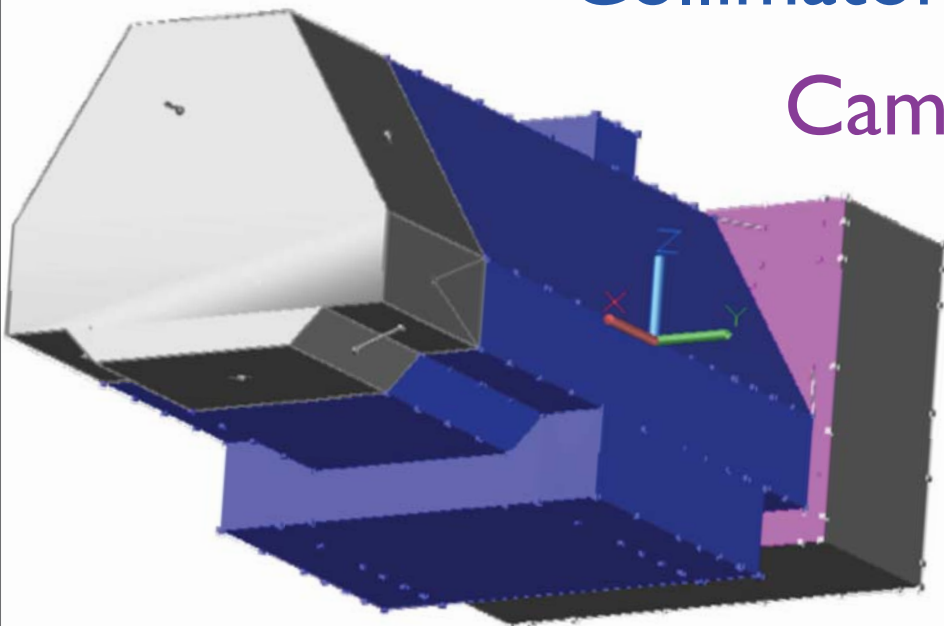

Camera Body
(ACIS Housing)

Geometry Model

OBF-I & S

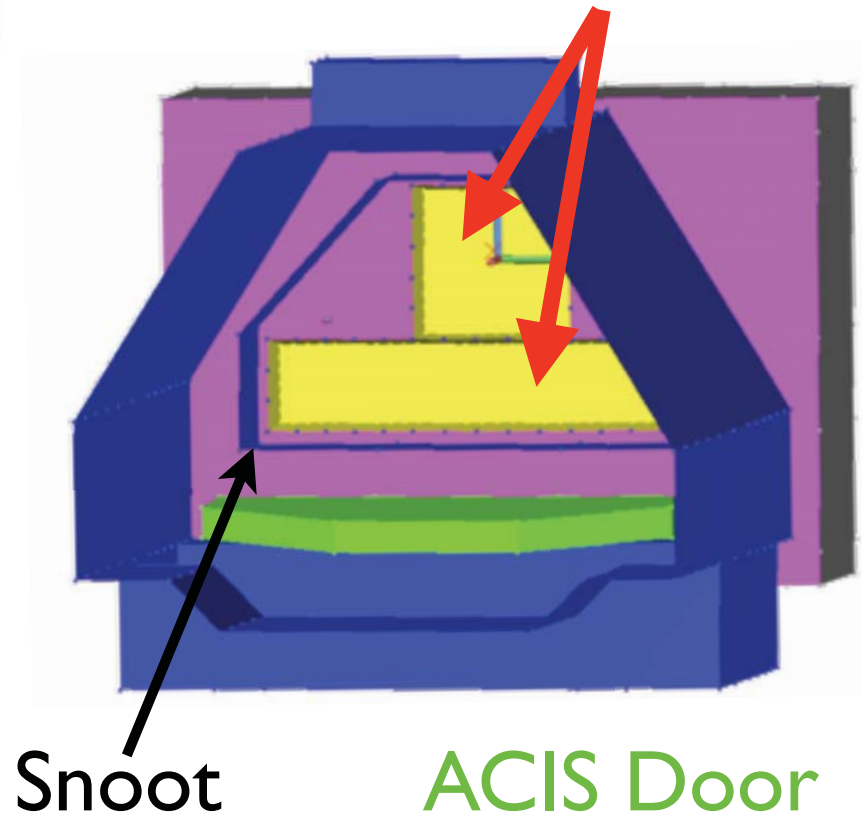

Snoot

ACIS Door

From Neil Tice/LMC

Thermal Desktop:

RADCAD to calculate geometric
view factors

SINDA FLUINT to calculate
temperatures

738 nodes, 121 OBF-I, 203 OBF-S

Thermal Model

$T \sim -62 \text{ } ^\circ\text{C}$

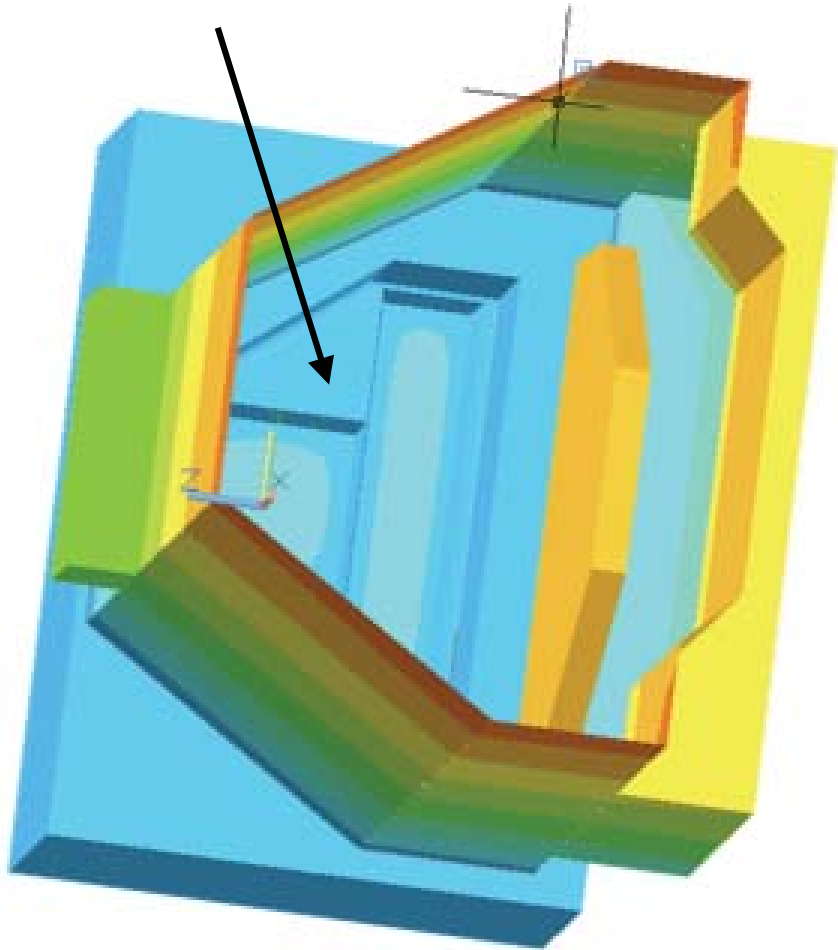

AH heaters ON ($t < 9$ yrs)

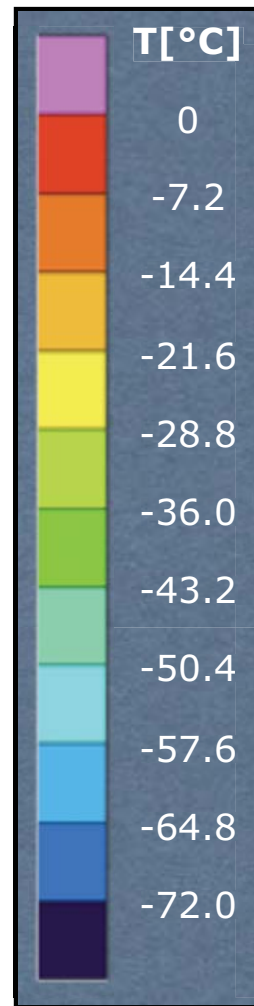

$T \sim -69 \text{ } ^\circ\text{C}$

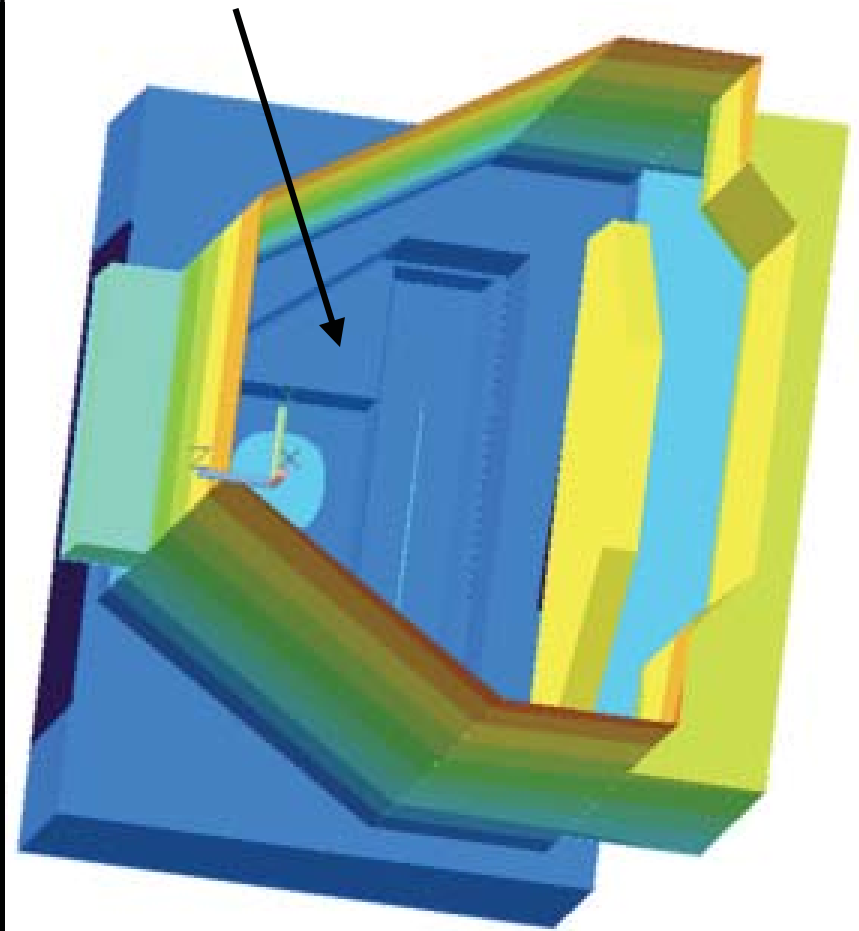

AH heaters OFF ($t > 9$ yrs)

Thermal Model

AH heaters ON

AH heaters OFF

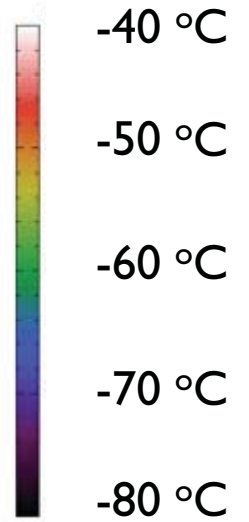
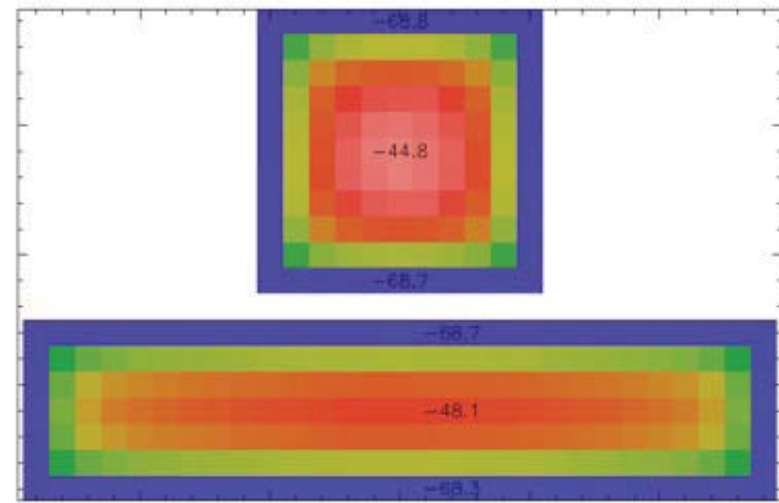
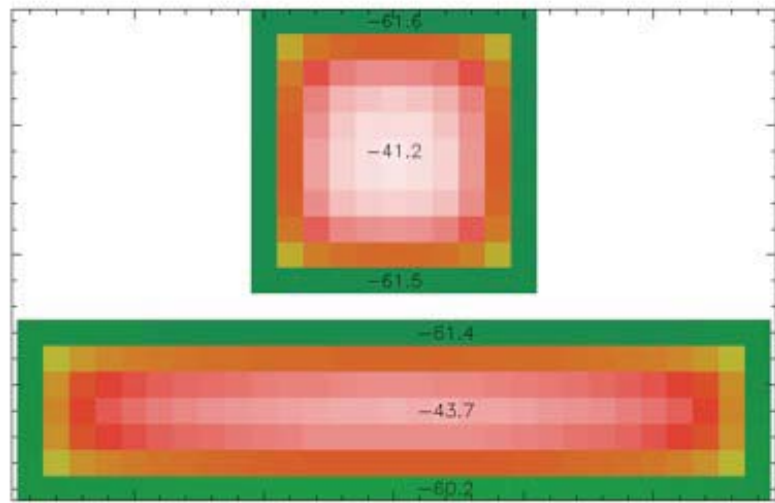

$\epsilon = 0.40$

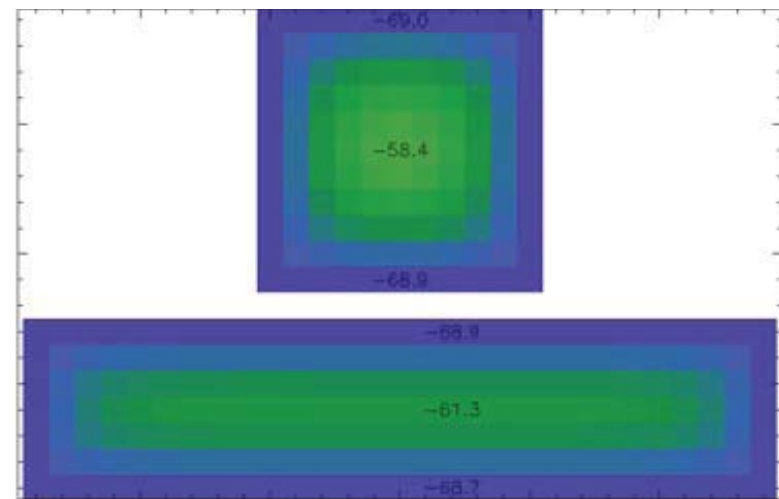
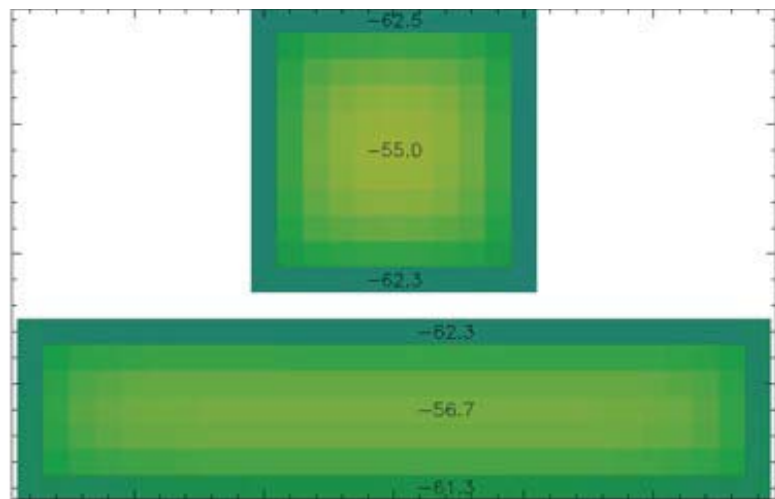

$\epsilon = 0.05$

Chandra Contaminant Migration Model Results

Mass Column of Octadecane ($C_{18}H_{38}$) at $t=9$ years

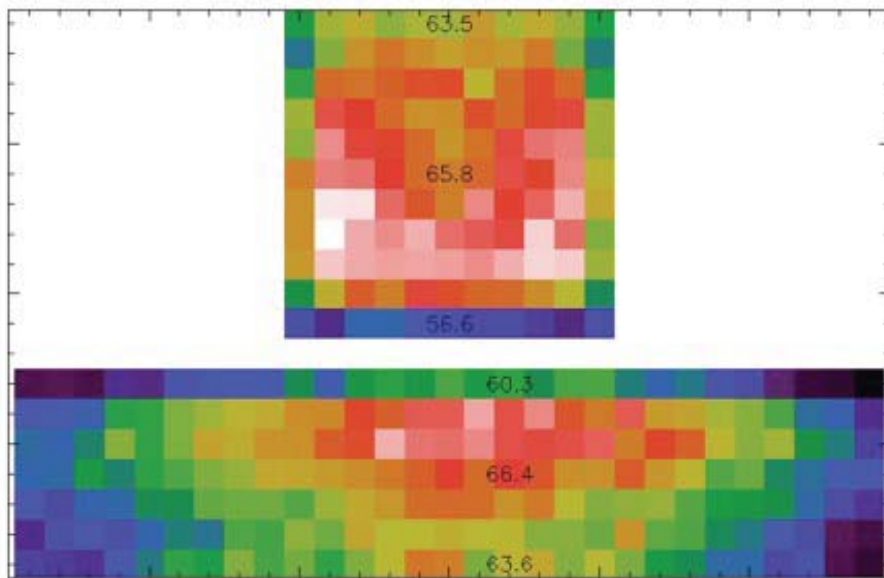

low volatility (0.10)

“view-factor” dominated: central regions have highest accumulation because center views more nearby cold surfaces, pattern is asymmetric

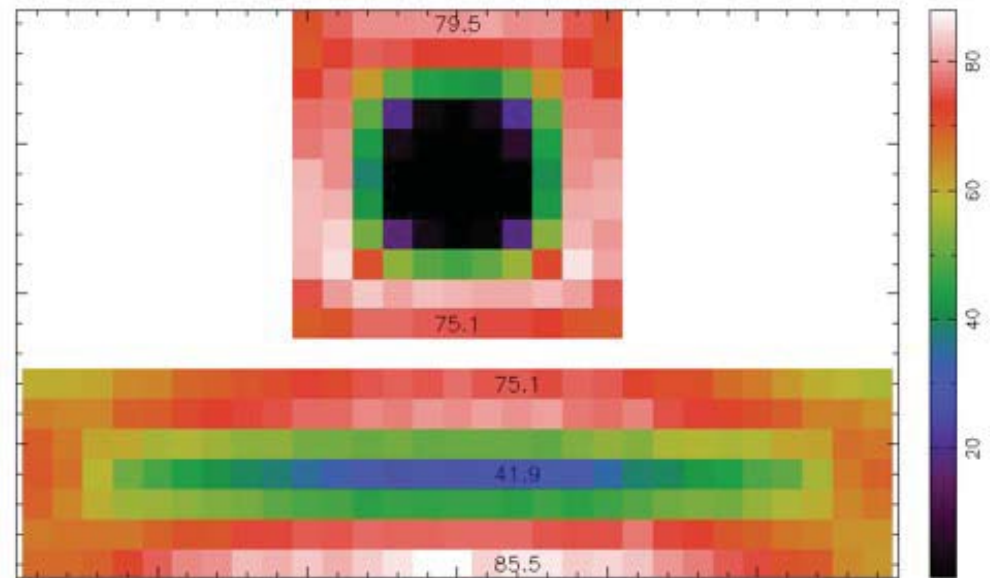

high volatility (2.50)

“thermal” dominated: warm central regions begin to clean, pattern follows local temperature distribution with more material near cold edges

Chandra Contaminant Migration Model Results

Mass Column of Octadecane ($C_{18}H_{38}$) at $t=9$ years

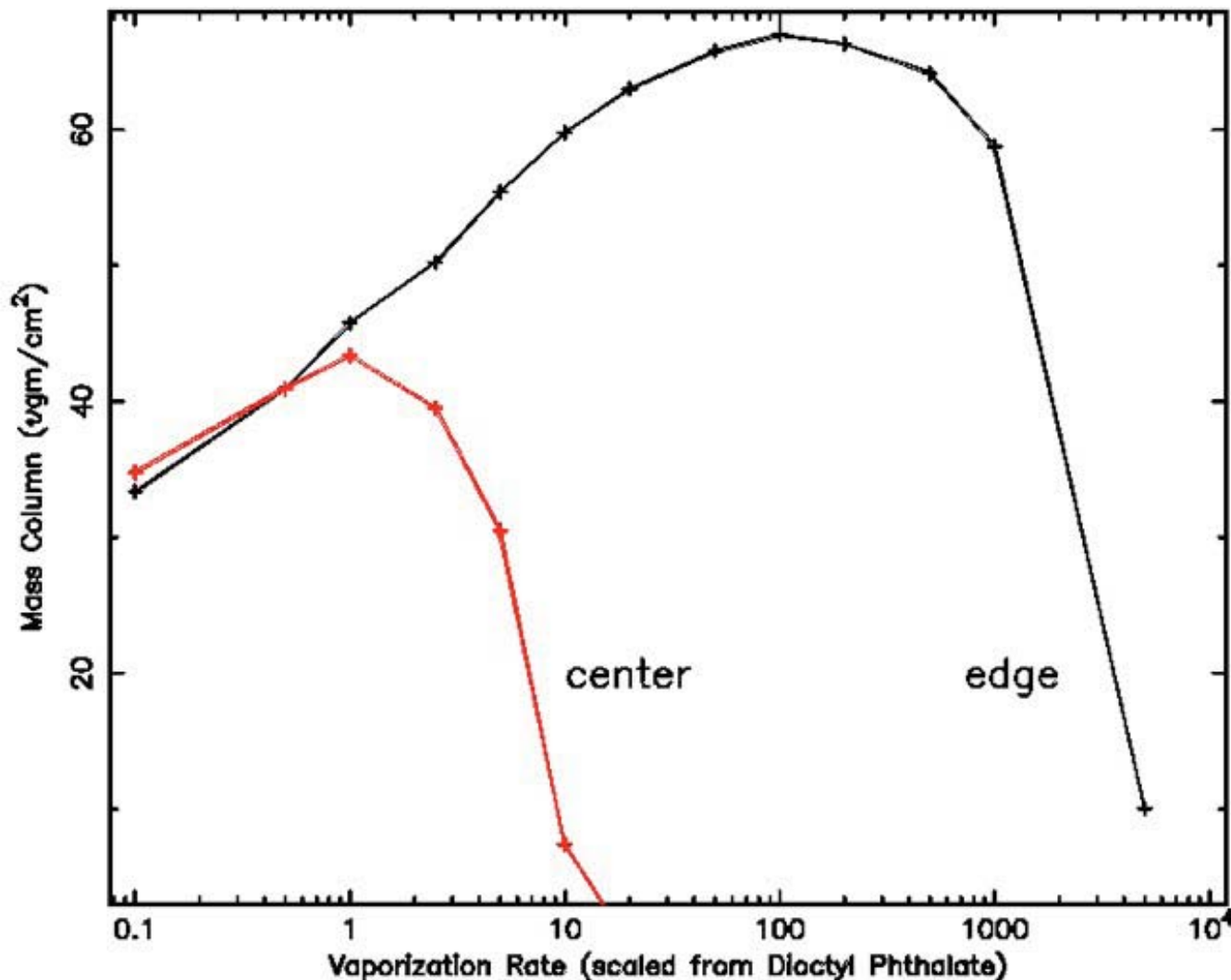

As volatility (mass vaporization rate) increases, center begins to clean. At very high rates, even accumulation at edges is low.

Observed edge/center differences reproduced only for a small range of volatilities (here, 1 to 3 times $C_{18}H_{38}$)

Chandra Contaminant Migration Model Results

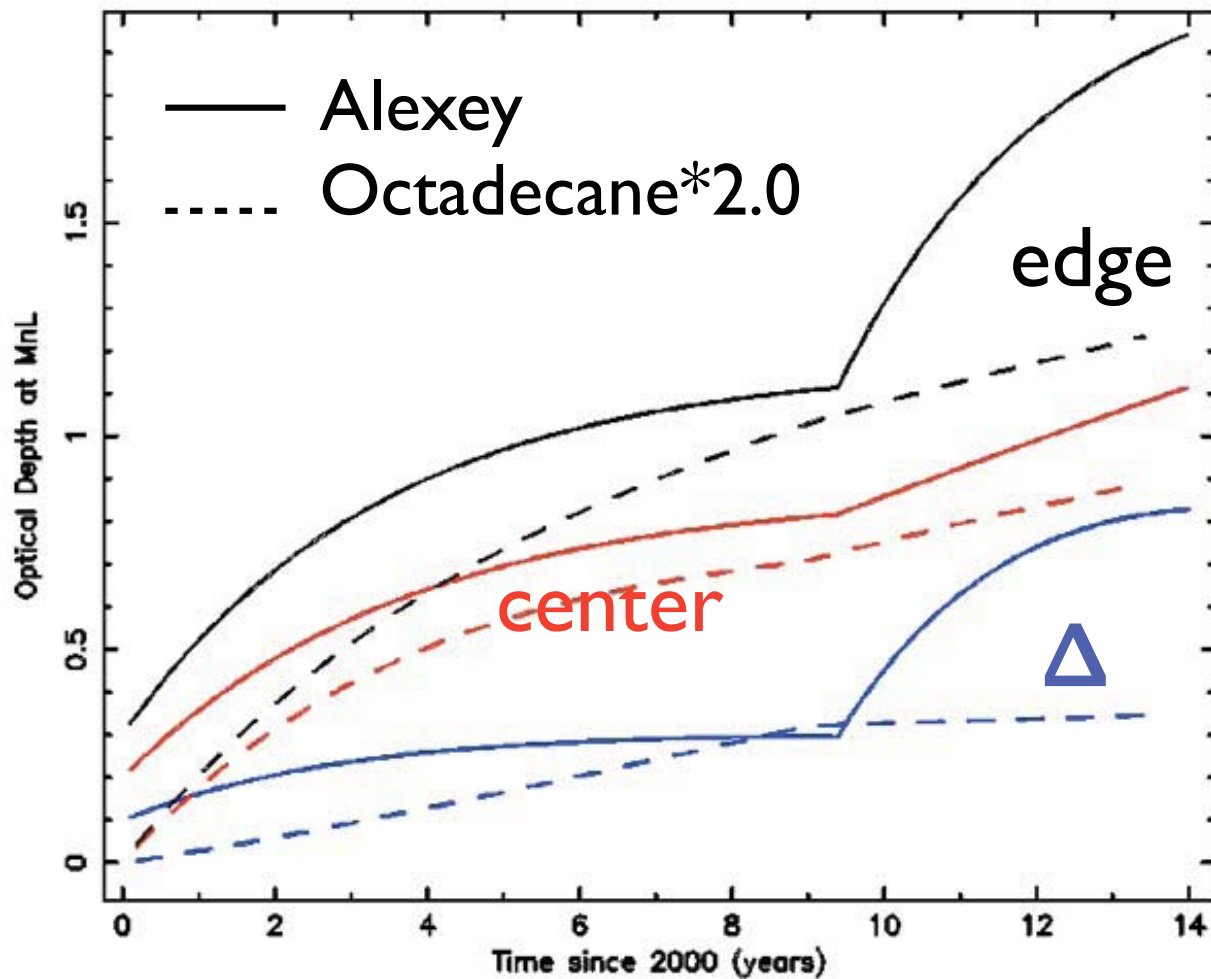

Source rate and material properties chosen to reproduce AV's center accumulation up to AH heaters OFF ($t < 9$ yr)

Model fails to reproduce observed edge (and hence Δ) particularly after heaters turned off

Need a *second contaminant*
* higher volatility
* accumulates mainly during colder heaters-off times

Chandra Contaminant Migration Model Results

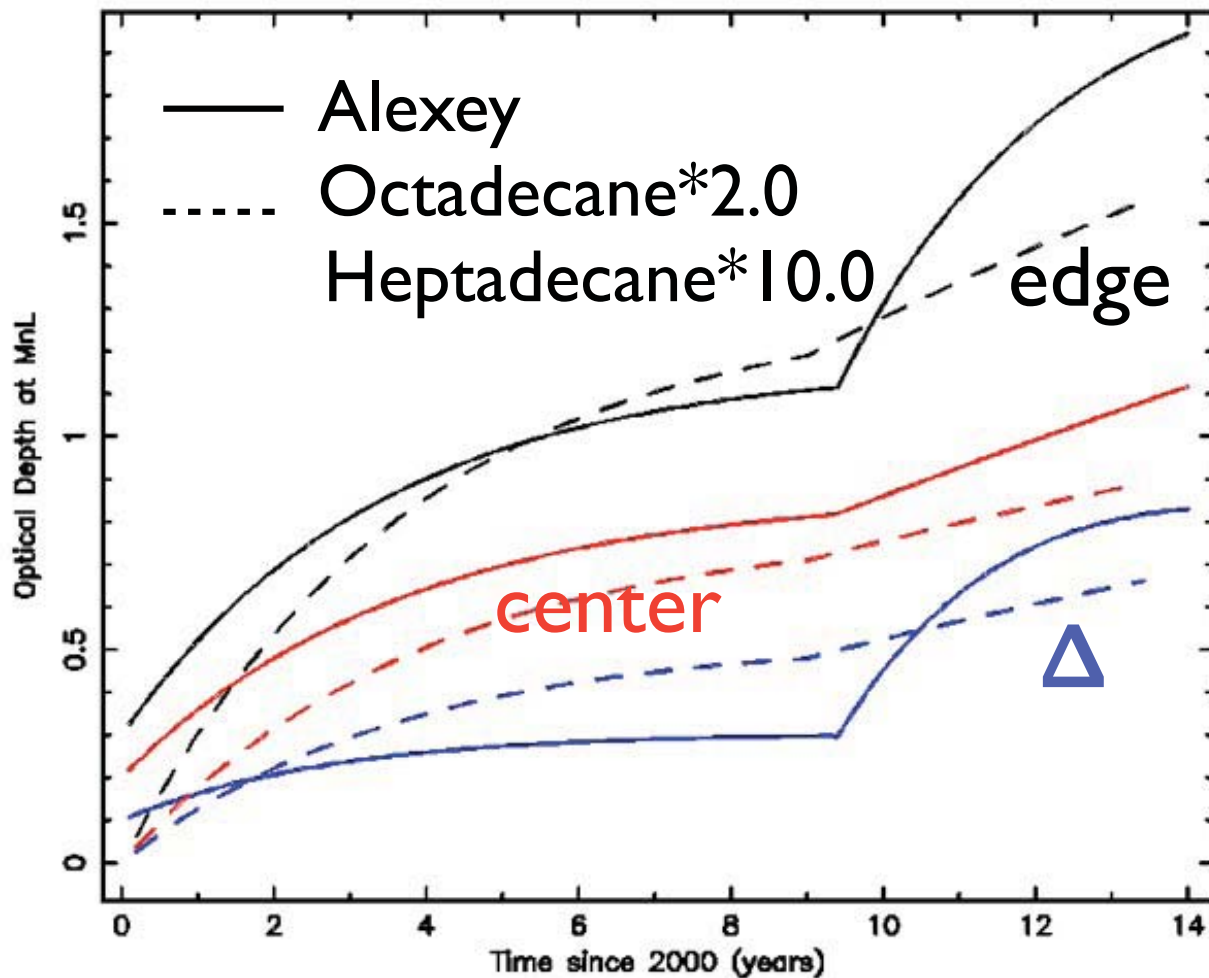

A second contaminant can be found that accumulates mainly on the edges. However, time evolution does not follow observations well and post AH-heaters-OFF still problematic

- * low ϵ at early times?
- * different source rate time dependence for 2nd material?

Chandra Contaminant Migration Model

SUMMARY

- ◆ High volatility cleans OBFs and low volatility produces a high build-up at OBF centers; only a narrow (factor of 2 or less) volatility range produces the observed spatial pattern
- ◆ Simulations predict less accumulation above outer S-array CCDs; this may explain, in part, gratings/imaging C/MnL discrepancies
- ◆ Simulations produce a change in center accumulation due solely to DH heater ON/OFF temperature change; but a 2nd contaminant and perhaps a change in source rate is also required
- ◆ Emissivity ϵ may depend on thickness; another model parameter
- ◆ Additional physics, e.g., surface migration, is not warranted at this time
- ◆ At $t \sim 14$ yrs, model produced 0.22 grams of contaminant, 0.085 grams remaining within ACIS cavity; 7% (6mg) on OBFs.