

Asteroid Redirect Crewed Mission Space Suit and EVA System Architecture Trade Study

Jonathan T. Bowie¹, Raul A. Blanco², Richard D. Watson³, Cody Kelly⁴, Jesse Buffington⁵, Stephanie A. Sipila⁶
NASA Johnson Space Center, Houston, TX 77058

This paper discusses the Asteroid Redirect Crewed Mission (ARCM) space suit and Extravehicular Activity (EVA) architecture trade study and the current state of the work to mature the requirements and products to the mission concept review level. The mission requirements and the resulting concept of operations will be discussed. A historical context will be presented as to present the similarities and differences from previous NASA missions. That will set the stage for the trade study where all options for both pressure garment and life support were considered. The rationale for the architecture decisions will then be presented. Since the trade study did identify risks, the subsequent tests and analyses that mitigated the risks will be discussed. Lastly, the current state of the effort will be provided.

Nomenclature

<i>ACES</i>	=	Advanced Crew Escape Suit
<i>ACFM</i>	=	Actual cubic feet per minute
<i>AEMU</i>	=	Advanced Extravehicular Mobility Unit
<i>AES</i>	=	Advanced Exploration Systems
<i>ARCM</i>	=	Asteroid Redirect Crewed Mission
<i>ARGOS</i>	=	Active Response Gravity Offload System
<i>BRT</i>	=	Body Restraint Tether
<i>DCCI</i>	=	David Clark Company Inc.
<i>DRM</i>	=	Design Reference Mission
<i>EMU</i>	=	Extravehicular Mobility Unit
<i>EOS</i>	=	Emergency Oxygen System
<i>EVA</i>	=	Extravehicular Activity
<i>FSA</i>	=	Feedwater Supply Assembly
<i>ISS</i>	=	International Space Station
<i>LCG</i>	=	Liquid Cooling Garment
<i>LEA</i>	=	Launch / Entry / Abort
<i>LES</i>	=	Launch / Entry Suit
<i>LPU</i>	=	Life Preserver Unit
<i>MLI</i>	=	multilayer insulation
<i>MSPV</i>	=	Multi-position Suit Purge Valve
<i>NBL</i>	=	Neutral Buoyancy Lab
<i>NEA</i>	=	Near Earth Asteroid

¹ AEMU SE&I Lead Engineer, Space Suit and Crew Survival Systems Branch, 2101 NASA Parkway/EC5, Houston, TX 77058, nonmember

² Chief, Space Suit and Crew Survival Systems Branch, 2101 NASA Parkway/EC5, Houston, TX 77058, nonmember

³ Orion Spacesuit Subsystem Manager, Space Suit and Crew Survival Systems Branch, 2101 NASA Parkway/EC5, Houston, TX 77058, nonmember

⁴ Spacesuit & Life Support Systems Engineer, Space Suit and Crew Survival Systems Branch, 2101 NASA Parkway/EC5, Houston, TX 77058, nonmember

⁵ EVA Tools Project Manager, Tools, Equipment & Habitability Systems Branch, 2101 NASA Parkway/EC7, Houston, TX 77058, nonmember

⁶ EVA Exploration Architecture Lead, EVA Management Office, 2101 NASA Parkway/FX, Houston, TX 77058, nonmember.

<i>POR</i>	=	Primary Oxygen Regulator
<i>PPA</i>	=	Parachute Pack Assembly
<i>PPRV</i>	=	Positive Pressure Relief Valve
<i>RCA</i>	=	Rapid Cycle Amine
<i>SCCM</i>	=	standard cubic centimeters per minute
<i>SOR</i>	=	Secondary Oxygen Regulator
<i>STS</i>	=	Space Transportation System
<i>SWME</i>	=	Suit Water Membrane Evaporator
<i>TCC</i>	=	Trace Contaminant Control
<i>TCU</i>	=	Thermal Comfort Unit
<i>TMG</i>	=	Thermal Micrometeoroid protection Garment

I. Introduction

THE Asteroid Redirect Crewed Mission (ARCM) requires a Launch/Entry/Abort (LEA) suit capability and short duration Extravehicular Activity (EVA) capability for Orion. The EVAs will involve a two-person crew for approximately four hours. Currently, two EVAs are planned with one contingency EVA in reserve. Providing this EVA capability is very challenging due to system level constraints and a new and unknown environment. The goal of the EVA architecture for ARCM is one that builds upon previously developed technologies and lessons learned, and that accomplishes the ARCM mission while providing a stepping stone to future missions and destinations. The primary system level constraints are to 1) minimize system mass and volume, and 2) minimize the interfacing impacts to the baseline Orion design. In order to minimize the interfacing impacts and to not perturb the baseline Orion schedule, the concept of adding “kits” to the baseline system is proposed. These kits consist of: an EVA kit (converts LEA suit to EVA suit), EVA Servicing and Recharge Kit (provides suit consumables), the EVA Tools, Translation Aids & Sample Container Kit (the tools and mobility aids to complete the tasks), the EVA Communications Kit (the interface between the EVA radio and the MPCV), and the Cabin Repress Kit (represses the MPCV between EVAs). This paper will focus on the trade space, analysis, and testing regarding the space suit system (pressure garment and life support system). Historical approaches and lessons learned from all past EVA operations were researched. Previous and current successfully operated EVA hardware and high technology readiness level (TRL) hardware were evaluated, and a trade study was conducted for all possible pressure garment and life support options. Testing and analysis was conducted and a recommended EVA system architecture was proposed. Pressure garment options that were considered for this mission include the currently in-use ISS EVA Mobility Unit (EMU), all variations of the Advanced Crew Escape Suit (ACES), and the Exploration Z-suit. For this mission, the pressure garment that was selected is the Modified ACES (MACES) with EVA enhancements. Life support options that were considered included short closed-loop umbilicals, long open-loop umbilicals, the currently in-use ISS EMU Portable Life Support System (PLSS), and the currently in development Exploration PLSS. For this mission, the life support option that was selected is the Exploration PLSS. The greatest risk in the proposed architecture is viewed to be the comfort and mobility of the baseline MACES and the delicate balance between adding more mobility features while not compromising landing safety. Feasibility testing was accomplished in low fidelity analogs and in the JSC Neutral Buoyancy Laboratory (NBL) to validate the concept before a final recommendation on the architecture was made. The proposed architecture was found to meet the mission constraints, but much more work is required to determine the details of the required suit upgrades, the integration with the PLSS, and the rest of the tools and equipment required to accomplish the mission. This work and further definition of the remaining kits will be conducted in government fiscal year 2014.

II. Mission Requirements

The Asteroid Redirect Mission has very few EVA requirements. The robotic spacecraft shall enable physical access to the asteroid for the EVA crew, worksite stability sufficient for sampling, carry the EVA tools necessary to extract an asteroid sample, and provide EVA inhibits and safety features. The Orion spacecraft shall provide the capability for the crew to perform extravehicular activities to access the asteroid, stow additional EVA tools necessary to obtain asteroid samples, and return the asteroid samples to Earth.

Most criteria that are important to this study are derived from those few requirements. The ARV and Orion are the only two vehicles involved so they must provide all of the equipment necessary to conduct EVA. Orion does not have the capability to provide all of the needs for EVA such as consumables and EVA radio so those services must be provided via “kits”. Orion has the capability to carry four crew for 21 days, but in order to reach the desired orbit where the asteroid will be delivered and to assure the necessary volume available for EVA equipment, the number of

crew for this mission is reduced to two. The implementation of these requirements must not add much mass because Orion is overmass already. The length of the EVA, four hours, was chosen as a compromise between different criteria. Four hours were viewed as the minimum amount of time to accomplish the sampling tasks and the maximum amount of time it is reasonable for the MACES to work with the PLSS as designed.

These few simple requirements drive most of the trade study below. If one of these requirements changes, for instance if another module or vehicle becomes available to provide additional capability, the results of this study would change.

III. Concept of Operations

A. Orion Configuration

The Orion configuration for the ARCM feasibility study is based on the Beyond Earth Orbit Orion for the Exploration Mission-2 (EM-2) Lunar Orbit mission as defined in Orion-72093, Orion Concept of Operations. The Orion Vehicle Configuration Matrix configuration summary for the EM-2 mission includes provisions for four crew members for up to 21 days. In this study, the Orion reference configuration was augmented to add EVA, rendezvous and docking, and sample return functionality required to accomplish the ARCM objectives. To minimize the integrated Orion hardware and software configuration changes, the additional ARCM functionality is provided as mission kits that will interface with the Orion. Though the Orion configuration is sized for four crew, only two crew will be flown on this mission. The additional volume and mass are needed for the additional consumables and EVA equipment to perform the 30-day mission with EVAs. The two crew members will both egress the vehicle for EVA. Consumables will be sized for 2 nominal EVAs and 1 contingency EVA.

B. Transit Operations

Orion will launch on the Space Launch System. The outbound transit from launch to the Earth-Moon Distant Retrograde Orbit will take approximately 10 days. During the 10-day transit time, the crew will have an opportunity to prepare the cabin and suits for the upcoming EVAs. Shortly after the Earth departure burn, the Orion cabin will be depressurized to 10.2 psi to facilitate minimal EVA pre-breathe times. The crew will then transform the vehicle and their Modified Advanced Crew Escape Suits (MACES) from the launch configuration to one that supports EVA.

While en-route to the ARV, the crew will perform an EVA dry run including checkout of the MACES and Exploration PLSS and practice suit donning. The EVA checkout activities will include communication checks between suits and the ground. Verification of suit performance will be jointly executed with the Mission Control Center (MCC). The crew will review the EVA preparation, vehicle depress, egress, and repress procedures to ensure adequate reach and access prior to doffing the suit. The EVA tools will be removed from their launch stowage location and configured for EVA. The crew also will perform final battery charging and prepare the mounting of the Orion to ARV translational boom near the EVA hatch.

Flight Day 10, docking day, will include some final EVA and cabin preparations that will likely be scheduled as close to EVA days as possible in order to maintain habitability of the crew cabin. The timing of EVA and cabin preparations will be determined with human-in-the-loop stowage studies. General clean-up and stowing of non-EVA equipment is needed to prepare the cabin for depress and vacuum. Any items that cannot withstand vacuum require special stowage or are not suitable for this mission.

C. Pre-EVA Operations

Prior to each EVA, the Orion Reaction Control System thrusters will be used to slew the stack to a +15° yaw. This attitude change will provide improved illumination of the EVA worksite, and the Orion thrusters will arrest any rates before the vehicle is moded to free drift for the duration of the EVA operations.

On the morning of the first EVA, the crew will complete post-sleep activities and initiate EVA preparations with suit donning. The suit will be purged of cabin air and pressurized with 100% Oxygen (O₂). The crew will then perform suit pressure integrity and system checks followed by a prescribed pre-breathe period. Based on similarity to Shuttle protocols, the in-suit pre-breathe duration will be approximately 40 minutes. Additional analysis is required to verify the time required to de-nitrogenate the MACES.

When pre-breathe and suit leak check are complete, the cabin depressurization will be initiated by the crew. Once at vacuum, the crew will open the hatch and disconnect the MACES umbilicals. The sequence of umbilical disconnection and Exploration PLSS activation will be determined through future integrated testing and verification of the Orion, Exploration PLSS, and MACES systems.

D. EVA Operations

The EVA commences when the Orion hatch is open and the crew is operating on the Exploration PLSS. The EVAs will be designed to be no longer than four hours long. The priorities for this EVA will include sample retrieval, contextual and detailed photographic observations, as well as EVA tool and translation aid deployment.

EVA objectives on the asteroid will be varied. Geological samples may include hammer chips, core samples, soil, float collection, and others. Tasks may include deployment of a sensor array on the asteroid for long term monitoring, or demonstration of anchoring techniques to the rock surface. As possible, imagery will provide MCC situational awareness, geological context, and provide an avenue for public engagement. EVA task definitions will evolve as the mission matures. Definition of the specific objectives is forward work to be coordinated with the scientific, commercial, and international spaceflight communities. Initial mass available to the ARCM may limit asteroid utilization on this first mission. Extending the ARV platform for follow-on missions will provide more utilization options and allow for more detailed studies based on the results of the preliminary data captured by the ARCM.

E. Post-EVA Operations

Once the hatch has been closed and latched, the crew will initiate the repress of the cabin by opening the repress kit tank valve. The feasibility assessment assumes the crew will control the repress by cycling a manual valve as needed for crew comfort and planned holds. The repress will be paused to perform a cabin leak check to verify the integrity of the hatch seals. Assuming a successful leak check, the crew will open the valve and complete the repress to 10.2 psi. The regulator will slowly close, reducing the flow rate as the cabin pressure approaches the regulator set point. This allows the crew freedom to continue other activities without monitoring the cabin pressure. Operation for the first and second repress would be identical.

Following repress, the crew will assist each other with suit doffing. Prior to depressurizing the suits, the crew should inspect the gloves for areas of possible damage and follow up with photos after suit doffing. Most suit refurbishment tasks can be left for the next day, but charging of the suit and tool batteries will likely need to start that evening to ensure they are fully charged to support EVA 2. A space-to-ground conference should occur to discuss any suit fit anomalies and unexpected challenges during EVA 1 that could impact the planned tasks for EVA 2, including asteroid sampling objectives.

Asteroid dust introduces contaminants to the habitable environment that are potentially hazardous to crew respiration and vision. During repress and post-EVA operations, the crew will remove asteroid dust from the suits with a combination of brushing, wipes, and the Orion vacuum. The EVA gloves will likely carry the most amount of dust contaminate, thus mission-specific handling and post-EVA stowage will be planned to minimize the contaminate risk. Due to the high likelihood the EVA glove handling protocol will require containment, a second set of gloves will be included in the EVA Suit Kit to support the second EVA.

F. Non-EVA Days

On the day between EVA 1 and 2, the crew will focus on suit refurbishment and reviewing changes to the EVA 2 plan. The crew will prepare the suits for EVA 2 by recharging oxygen bottles used on EVA 1 in preparation for EVA 2. The crew will also need to replace the thermal loop feedwater bag used to provide cooling. Suit carbon dioxide removal will be provided by Orion assets while connected to the umbilical, and a Rapid Cycle Amine (RCA) system in the Exploration PLSS. This combination does not require refurbishment between EVAs. After the suit consumables have been refreshed, the crew can make any necessary suit sizing adjustments and perform a fit verification if needed. The crew will then reconfigure tools and tethers for EVA 2.

G. Return Operations

On Flight Day 15, after five days at the asteroid, the crew will undock the Orion and depart. Prior to a successful separation, EVA suits and tools will remain configured to protect for a possible contingency EVA to manually separate the vehicles. If such an EVA were required, the duration would be approximately one hour. Orion Service Module gas is budgeted to protect for a contingency EVA of this type. Furthermore, it is likely that one of the EVA crew members would remain on umbilical life support throughout such an EVA as they would also be required to pilot the vehicle to a safe distance after separation. When undocking and separation are complete, the Orion commences the nine day transit back to Earth. The crew will stow EVA hardware and reconfigure the MACES to the entry configuration. On the day prior to re-entry, the crew will repress the cabin back to 14.7 psi using Service Module gas. On re-entry day, the crew will configure the cabin for entry before donning the MACES.

IV. Historical Similarities and Context

This mission requires a capsule based EVA without the use of an airlock. This has been accomplished during Gemini, Apollo, and Skylab programs for NASA missions. In each of the previous programs that performed capsule based EVA, the crew launched in the same suit that performed the spacewalk. Mass and volume considerations were major design drivers that led to the use of one suit in these historical programs. Shuttle and ISS EVA experience is helpful with task determination and operational planning, but the need to launch and land in the suit and egress without an airlock does significantly change the requirements applied to the suit and vehicle systems.

For project Gemini, a two man crew lived in the vehicle for a maximum of two weeks with a total of 9 umbilical based EVAs performed on 5 of 10 manned flights. These EVAs were accomplished with a soft suit with a link-net restraint that was similar to the baseline suit for Orion. The missions determined the need for careful EVA planning including EVA aids for translation and body stabilization, adequate cooling for expected environments and workloads, and invented the use of a water environment to simulate microgravity. During the Apollo program there were 4 microgravity EVAs, consisting of 1 suit-to-PLSS checkout and 3 deep space EVAs to retrieve film canisters from the service module. Each of the deep space Apollo EVAs were accomplished on a low pressure umbilical with air cooling supporting the low metabolic rate EVA. None of these programs perfectly match the requirements for an ARCM mission but each piece of the planned ARCM mission has been demonstrated previously. This allows the comparison of each of the historic options.

V. Trade Study

The trade study team selected the launch/entry suits already being flown on Orion with a PLSS as the choice for performing this 2-person EVA to a retrieved asteroid. Several options were evaluated for both the suit and the life support system.

A. Pressure Garment Options

For the pressure garment of the space suit to be used in the ARCM, previous and current successfully operated EVA hardware and high technology readiness level (TRL) hardware were evaluated, and a trade study was conducted for all possible options. Testing and analysis was conducted and a recommended EVA system architecture was proposed. Pressure garment options that were considered for this mission include the currently in-use ISS EVA Mobility Unit (EMU), all variations of the Advanced Crew Escape Suit (ACES), and the Exploration Z-suit. All available suit options were evaluated to identify the right solution for this mission. The table below features the best options and the figures of merit used in this trade.

Table 1. Pressure Garment Options

Suit	Per Crew Mass (lb)	Accounted for in Orion Mass?	Suit Design Focus	Applicability for dual use?
Shuttle ACES (full gear)	~90	No	Launch/Entry Survival	--
Modified ACES (Orion Baseline less umbilical)	~35	Yes	Launch/Entry Survival	Minor mods for EVA-capable prototyped
EMU	~140	No	Microgravity Mobility	Not appropriate for launch and entry
Exploration Suit (Z-series)	~140	No	Planetary Mobility	Not appropriate for launch and entry

The following figures of merit were considered in this trade:

- Mass: Orion is mass limited. One groundrule for this trade study was to minimize the additional mass to Orion. Related to mass, but not listed is also volume. Orion has very little available stowage volume.
- Accounted for in Orion Mass: Because Orion is mass limited, taking advantage of mass already assigned to Orion is advantageous.

- Suit Design Focus: This figure of merit discusses the capability of the suit to perform the necessary tasks. The design focus does not preclude other uses.
- Applicability for dual use: Can the suit be used for both launch and entry, as well as for EVA?

The trade quickly eliminated the Shuttle ACES suit. The Shuttle ACES was an open loop system that worked well in the cabin of the Orbiter, but for contingency cases where Orion must return to Earth with an evacuated cabin, the Modified ACES closed loop system is the answer. The EMU and Exploration suit were considered, but their hard upper torsos make them massive and difficult to stow in the cabin of Orion. The Modified ACES suit is already being bookkept by Orion as their Launch and Entry suit, making it the most mass efficient choice. However, engineering enhancements are needed to make the Modified ACES an EVA capable suit.

B. Life Support Options

Life support options that were considered included short closed-loop umbilicals, long open-loop umbilicals, the currently in-use ISS EMU Portable Life Support System (PLSS), and the currently in development Exploration PLSS.

Table 2. Life Support Options

Life Support Option	Mass Impact for 2 EVA crew for 3 EVAs	Applicability to Future Exploration Missions	Applicability to ARCM
Short EVA Umbilical (28' Closed Loop)	--	No	Won't support mission due to short length Orion modifications would be required due to fan size
Long EVA Umbilical (100' Open Loop)	944lb (428kg)	No	Could support asteroid mission Supplemental O2 tank required to support metabolic load Boost pump would be required for water cooling
EMU PLSS	--	No	Suit integration effort would be significant Designed for hard upper torso vs. MACES soft upper torso
Exploration PLSS	760lb (345kg)	Yes	Could support asteroid mission

The Life Support trade had two main figures of merit, mass and applicability to the asteroid mission. Applicability to future exploration was considered as well, but not weighed as heavily as applicability to the task at hand. The short EVA umbilical was quickly shown to not support the asteroid mission due to its short length. The EMU PLSS, though a viable option, would present significant integration difficulties with the Modified ACES and was quickly eliminated from this trade study.

The two viable options for the Life Support trade were the Long EVA Umbilical and the Exploration PLSS. A detailed mass study was undertaken comparing the masses of the equipment, the consumables and the tankage for the consumables necessary to make each option work. The detailed works show that most of the equipment and repress consumables and tankage are common between the two, whereas the consumables and tankage needed to use the open loop long umbilical are more massive than the PLSS and its needed water and gas recharge. The reason the umbilical is more massive is due to the open loop design necessary to operate out of Orion. Providing 8 hours of open loop gas and water supply for two crew demands a large amount of consumables. This effect is multiplied by the need to add the tankage for the gas in the cabin because Orion does not have the available tankage.

VI. Proposed Architecture

A. Overview

The following sections cover the details of the proposed pieces of the architecture. The MACES will be configured to operate in its Launch/Entry/Abort function and then transition to the EVA function through the addition of equipment such as the PLSS and the reconfiguration of the suit.

B. Baseline Suit

The baseline suit for the Orion is the Modified Advanced Crew Escape Suit (MACES) a derivative of the shuttle ACES suit. The ACES is manufactured solely for NASA by David Clark Co. Inc (DCCI), located in Worcester, Massachusetts. The ACES is categorically defined as the DCCI Model S1035. The ACES heritage is derived from the original Launch/Entry Suit (LES, DCCI Model S1032) which was incorporated by NASA into the Shuttle Transportation System (STS) as part of the Crew Escape System that was developed after the Challenger Accident (1986). The ACES is a full pressure suit with a nominal contingency operating pressure of 3.46 psid. Oxygen was delivered to ACES from the Orbiter at 100psi and regulated by the suit to atmospheric pressure (or up to 3.46 psid in a cabin depress contingency). The ACES features an “open-loop” demand air system, meaning that expired air is vented out of the suit into the cabin atmosphere at ambient pressure. See Figure 1 below for operation schematic.

In case of an in-flight emergency, the ACES function is to protect the crew from cabin depress and to allow for high altitude (<35,000 ft) bailout. The ACES contains supplementary oxygen in the form of twin 60 cu in. bottles which store the gas at 3000 psi. This provides the crew with approximately 10 minutes of oxygen at sea level and increases exponentially at higher altitudes. The crewmember’s body temperature is regulated within the ACES by a liquid cooling garment that provides cool water flowed though tubes that envelop the entire body. The ACES is comprised of three layers of fabric. The innermost layer, or bladder layer, is the actual pressure vessel. It is comprised of seam sealed Gore-Tex fabric. The second layer of ACES, the restraint layer, is a net type material, dubbed Linknet by DCCI, that provides shape to the bladder layer while allowing for moderate mobility at full pressure. The outer most layer, or cover layer, is made of high visibility orange Nomex. The cover layer serves the purposes of abrasion protection, momentary fire protection, and high visibility for rescue scenarios in the event of an Orbiter bailout.

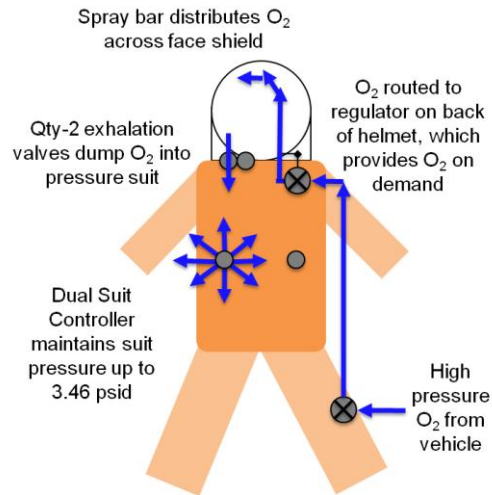

Figure 1. Shuttle ACES Operational Schematic

General physical characteristics of the standard ACES are unchanged for the Modified ACES. Pressure garment composition, helmet, gloves, boots, cooling, communications assemblies, and undergarments are identical. Modifications to the ACES are divided into the following systems:

1. Primary Breathing System

The primary breathing system in the modified ACES is a closed loop system. The breathing loop air inlet is mated through Apollo era fittings manufactured by Air-lock, Inc. The inlet is located on the lower left abdomen. Air is routed through an internal ventilation tree through the neckdam, and into the helmet breathing cavity. Expired breathing gas is vented through the neckdam exhalation valves into the suit body. Gas is exhausted from the suit through an Apollo era connector on the lower right abdomen.

2. Secondary Breathing System

The secondary breathing system used in the modified ACES is an open loop system identical to that of the standard ACES. High pressure (50-120psia) gas is fed through a high pressure hose to the suit breathing regulator located immediately below the neckring on the anterior side. Gas is delivered based on breathing demand through the helmet spray bar. Expired breathing gas is vented through the neckdam exhalation valves into the suit body. Gas is exhausted from the suit through a backpressure regulator that is opened for open loop operations. Air for the

secondary system is provided from either facility provided air, or through leg mounted emergency oxygen bottles as are worn in the current ACES ensemble for shuttle operations. High pressure hoses for the modified ACES are integrated into the coverlayer of the suit and plumbed in series to the legacy Emergency Oxygen System (EOS) bottles, worn in custom pouches on the outer flanks of the lower legs.

3. Auxiliary Modifications

The ACES Life Preserver Unit (LPU) and EOS is incorporated in the Parachute Pack Assembly (PPA) Harness. Since the Orion capsule does not support bailout, a PPA is not needed in the modified ACES. As such, the harness has been simplified and components have been relocated to better integrate to the conformal fit seats employed by the Orion capsule.

The modified ACES has been outfitted with a modified mil-spec LPU-10 life preserver unit. The LPU-10 has been re-sewn to incorporate international orange nomex and webbing for higher visibility. Additionally, the harness has been modified to incorporate lift capabilities for crew rescue operations. This harness may be used for modified ACES testing of seat fit and mobility. Lifting operations tests shall be restricted until proper testing of the harness load rating is performed and all associated hazards are documented and reviewed.

The EOS bottles have been relocated to the outer flanks of the legs via removable Nomex fabric pouches. The EOS bottle pressure regulators are identical to those used in ACES, however the actuation mechanism has been modified to optimize them for leg worn use. The EOS bottles will be attached to the suit mounted high pressure lines via quick disconnect at the regulator.

C. Common Hardware

The helmet remains unchanged from that used in the standard ACES configuration and may be used interchangeably between all suits and suit sizes. Gloves are also unchanged and may be used interchangeably between suits provided they are sized appropriately to the wearer as per standard ACES. Liquid Cooling Garments (LCG) and Thermal Control Underwear (TCU) are under evaluations for redesign to reduce pressure drop. Normal ACES LCGs/TCUs are anticipated to be used in the interim, though any LCG/TCU may be used so long as it can be interfaced through the Biomedical Interface Passthrough (BIP). The Communications Carrier Assembly (CCA) has been unmodified and is interchangeable according to occupant size. Boots and boot style are interchangeable. TCUs are interchangeable for style and size between suits.

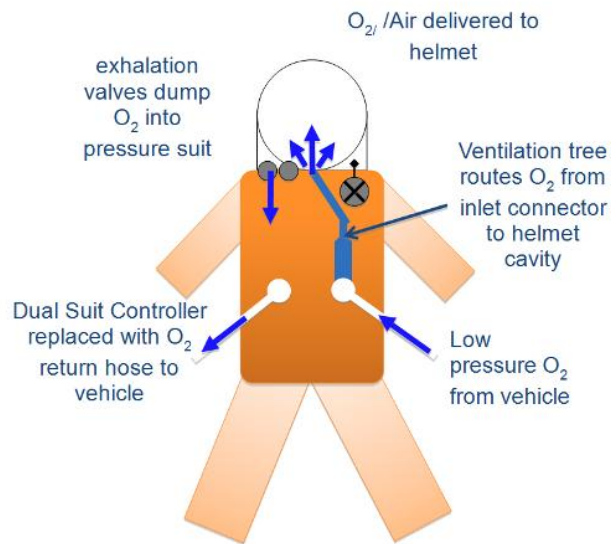

Figure 2. MACES Operational Schematic

D. PLSS

The baseline Portable Life Support System (PLSS) for the ARCM mission is currently under development as part of the Advanced Exploration Systems (AES) Advanced Extravehicular Mobility Unit (AEMU) project. The Advanced PLSS is the next evolutionary step in EVA portable life support systems, providing the astronaut with the ability for longer duration and more capable EVA operations. Development activities in 2012 and 2013 focused on implementation and packaging of advanced PLSS subcomponents, with late 2013 and early 2014 activities tailored around laboratory testing of the packaged Advanced PLSS prototype (PLSS 2.0) in a flight-like environment. Lessons learned from ground testing in 2014 will feed forward into the next iteration of PLSS design, PLSS 2.5, currently in the initial design phase. ARCM-unique considerations are being fed into the design of PLSS 2.5 via requirements definitions and PLSS-to-MACES interface kit testing planned for mid and late 2014.

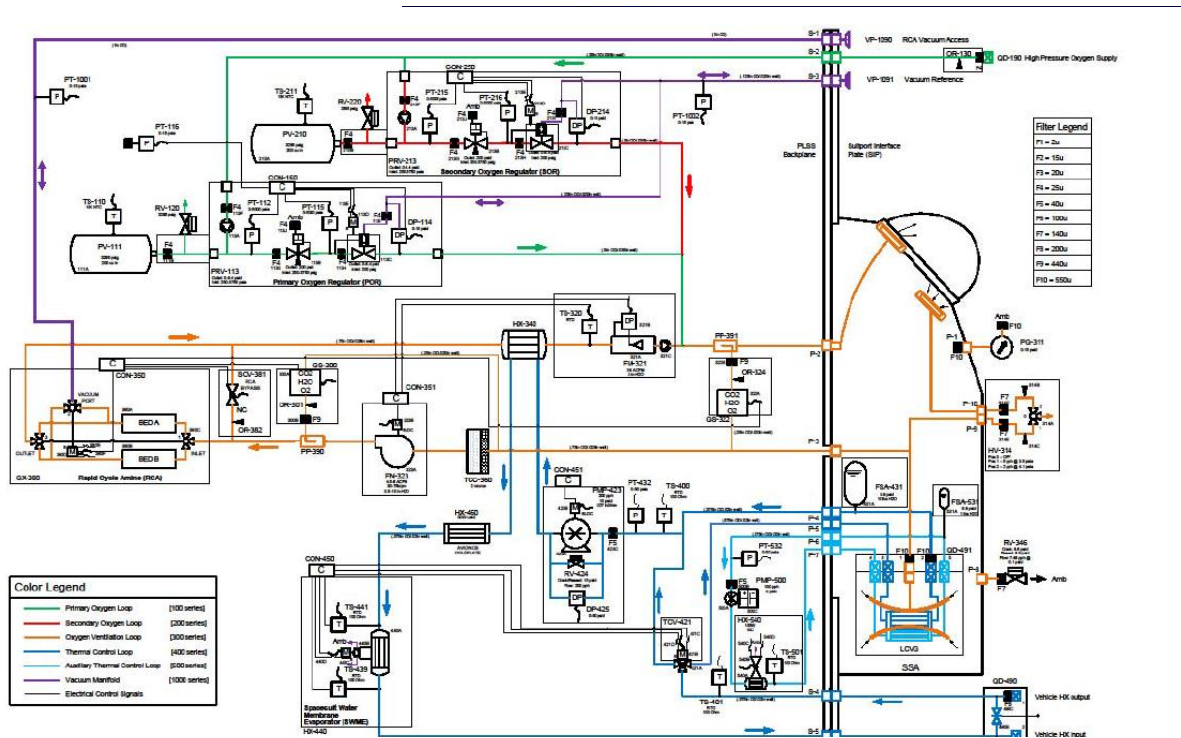

Figure 3. PLSS Pneumo-hydraulic Schematic

1. Ventilation Subsystem

The PLSS Ventilation Subsystem is composed of a high-pressure Primary Oxygen Loop feeding breathing gas into the Oxygen Ventilation Loop, with ventilation loop pressure controlled through the infinitely variable set-point Primary Oxygen Regulator (POR). In the event of a Primary Oxygen Loop anomaly, the Secondary Oxygen Loop is designed to provide at least 30 minutes of breathing gas for contingency return to the vehicle while the PLSS is configured for open loop oxygen purge. Apart from providing the MACES pressure garment pressurization and breathing gas for metabolic consumption, the Oxygen Ventilation Loop removes carbon dioxide from the breathing gas inside the pressure garment via fan-forced ventilation flow through the Rapid Cycle Amine (RCA) system. Trace contaminant control in the Oxygen Ventilation Loop is accomplished via an activated charcoal Trace Contaminant Control (TCC) cartridge, removing trace gases liberated from the crewmember and the small amount of ammonia released during RCA operation. Of note for ARCM-specific cases is the inclusion of specially sized TCC, ventilation purge valve, and positive pressure relief valve (PPRV) in the PLSS-to-MACES interface kit tailored specifically towards the environments identified for the asteroid retrieval mission. The nominal spacesuit pressure during an ARCM EVA is 4.3 psid, with 6 ACFM of ventilation gas flow being provided to the MACES suit via PLSS-to-MACES interface kit manifolding and supply/return umbilicals.

2. Thermal Control Subsystem

The PLSS Thermal Control Subsystem provides metabolic heat removal from the crew member and thermal conditioning for ventilation gas flow into the spacesuit. Thermal control is accomplished via closed loop water circulation using a positive-displacement pump, flowing through the crew-worn liquid cooling garment (LCG) into the Suit Water Membrane Evaporator (SWME). The SWME directly controls thermal loop water temperature by vaporization of some amount of working fluid through the SWME's hydrophobic membrane fibers, with heat rejection rates controlled by adjusting the SWME's backpressure across the SWME membrane fibers. Water lost through vaporization is backfilled by the Feedwater Supply Assembly (FSA), a compliant bladder pressurized by the suit's ventilation loop pressure that provides a forcing function to replenish water lost during the spacewalk. Currently, analysis is being performed to determine the FSA size for the ARCM mission as well as its location within the MACES pressure bladder or mounted as part of the PLSS-to-MACES interface kit assembly. In the event of Primary Thermal Loop failure, the redundant Auxiliary Thermal Control loop provides limited metabolic heat removal from the torso region of the LCG to enable crew members to terminate EVA activities and return to the vehicle. The Auxiliary Thermal Control loop operates in the same fashion as the primary loop, flowing cooling

water in a closed circuit through the auxiliary leg of the LCG into a specially sized miniature SWME with a fixed heatload removal set-point, then back into the LCG. As part of 2014 analysis, the need for an Auxiliary Thermal Control loop is being evaluated to determine the need for an Auxiliary FSA during the ARCM mission.

3. Vehicle Interfaces

For multiple EVAs, the Advanced PLSS allows for on-orbit servicing and refilling of PLSS oxygen and water consumables. In an effort to minimize impacts on capsule design for the ARCM mission, PLSS consumables recharge will be done by the EVA Servicing and Recharge Kit. The baseline operational concept for PLSS recharge has the EVA Servicing and Recharge Kit connecting to a high pressure quick-disconnect (QD-991) located on either the PLSS structure or the PLSS-to-MACES Interface Kit. Thermal control loop feedwater will be replenished by connection to the Orion liquid cooling loop post-EVA. Launch and landing PLSS stowage provisions are currently under development taking into account minimal changes to the Orion vehicle cabin layout.

4. PLSS-to-MACES Interface Kit

In an effort to minimize hardware changes to the MACES or PLSS, interfacing between the pressure garment and the PLSS is accomplished with the use of a self-contained interface kit. The kit contains the hardware to physically connect the MACES suit to PLSS structural and fluid connections via a common set of interfaces modelled after legacy ISS EMU PLSS-to-Hard Upper Torso interfaces. Structurally, the suit is connected to the Suit Interface Pad, a curved ‘cradle’ that conforms to the suit’s back geometry, coupled with a softgoods harness that wraps around the shoulders, chest, and waist of the pressure garment. The Interface Backbone, an aluminum 6061 frame, acts as the intermediate connection point of the Suit Interface Pad to the backplane of the PLSS. Additionally,

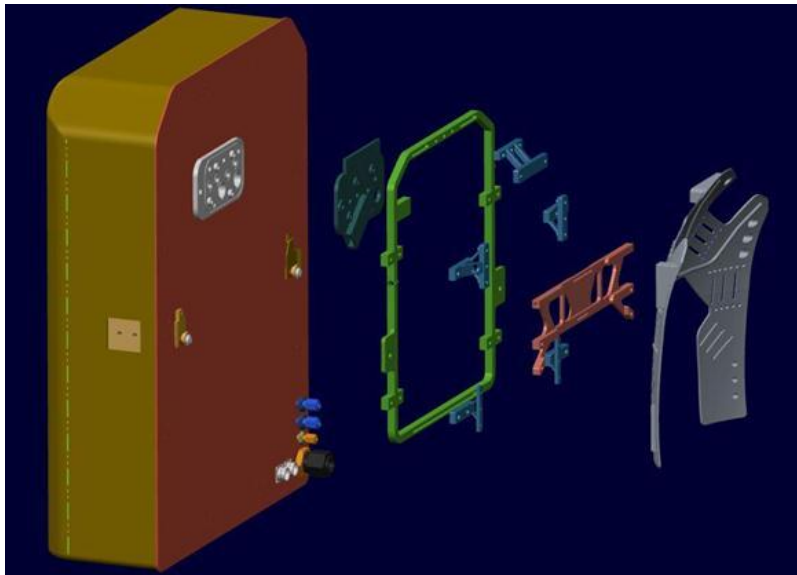

Figure 4. Engineering Graphic of PLSS-to-MACES Structural Interface Design

the Interface Backbone serves as the mounting interface for the Trace Contaminant Control (TCC) cartridge, low profile ventilation/water flow manifolding, and Positive Pressure Relief Valve (PPRV). Also included in the interface kit are Apollo-style umbilicals connected to the ventilation supply and return ports on the MACES. A multi-position purge valve on the return umbilical provides the ability for breathing gas de-nitrication and high flow CO₂ washout during pre-EVA prep and contingency operations respectively.

E. EVA Tools

1. Suit-Tool Interfaces

The EVA Tools subsystem for the ARCM DRM begins with suit-level interfaces to attach hardware to the suit to enable safe EVA operations, specifically an EVA Safety Tether which provides a mechanical means of precluding complete separation of the EVA Crew and the ARCM “stack”. Once safely EVA, the crew member will operate EVA Tools & Equipment through the pressurized glove, creating one of the most significant suit-tools interfaces. For the baseline MACES and the ARCM DRM, the team proposes the use of the existing ISS EMU “Phase VI” EVA Glove given the extensive development and ops-proven capability for EVA’s exceeding the duration and complexity of those specified in the ARCM DRM. Additional mission architecture development is required to determine if it is acceptable to operate the Phase VI glove without additional protection from the unknown nature of the Near Earth Asteroid (NEA) surface or if it is credible to pursue a worksite strategy that precludes glove contact with the surface and NEA materials/samples. Aside from hand-operations, suit-tool interfaces must also provide for attachment of EVA Tools in some manner to the crew member during local worksite operations. The current approach is to utilize



Figure 5 EVA Suit-Tool Interfaces – Gloves, Boots & Soft-Tether Points

the narrowly defined scope of the ARCM Geology Tasks to limit the suit infrastructure developed for this particular problem. Deviating from conventional solutions designed primarily for micro-gravity construction tasks, the MACES suit and ARCM EVA can use soft-tether only (no hard-mounted couplings) to attach the limited set of EVA hand tools to the crew member during the short time the crew member is at the EVA Worksite. This will allow for a reduced-complexity suit load path (no loads put directly into a “hard upper torso”) and firewall the design of much of the tools and their connections off from the details

of the MACES itself, easing the integration burden. Current design concepts utilize a simple harness with tether rings. This may either be worn separately or built into a thermal over-garment, both of which can be separate from the primary suit assembly (see Figure 5 for gloves, boots and tether points on the MACES).

2. *Body-Stabilization*

Body Stabilization is a key concept in micro-gravity EVA and must be addressed to enable the EVA crew member to do useful work. Furthermore, the EVA Crew Member cannot “use one hand to hang on” as all too often many EVA tasks require two-handed actuation to successfully be completed. There are two conventional methods that are well established in the contemporary experience base of micro-gravity EVA; these are “foot restraints” and “rigidizable tethers”. Foot restraints utilize a mechanical interface on the EVA suit’s boots to couple the EVA suit to structure with the subtlety of passing loads through the “air beams” of the inflated lower torso and legs. This provides a significantly rigid assembly that allows for two-handed task work that is comparable to “standing in 1g”, but comes at the price of mass of the foot restraint and the potential loss of EVA timeline for foot restraint set-up each time the worksite must move. For the MACES, the foot restraint option is easily preserved by simply utilizing the ISS EMU Boots which have a field-proven interface that has been evolved over multiple iterations across micro-gravity EVA’s in Skylab, Shuttle and ISS and thus requires little to no improvement for the EVA tasks envisioned in the ARCM DRM. That being said, in many scenarios a rigidizable “Body Restraint Tether” can provide a lower mass, quicker actuation solution but has the challenge of (a) passing loads to the EVA suit in a way that actually stabilizes the crew member and (b) needing a pre-integrated or easily deployed attachment point such as EVA Handrails. For the MACES, this first requirement is a particular challenge- the MACES is a “fully soft suit” or in the very least does not have the type of Hard Upper Torso shell that the ISS EMU does. Thus, a soft suit can face the difficulty of simply bending/deflecting around the attachment point where a rigid member is joined. There are multiple ways to address this, including “bulkhead fittings” and/or load harnesses, but these add mass, reduce mobility, require time to install/tune in mission, and consume suit surface area real estate without necessarily adequately addressing the problem. Thus, for the baseline MACES with a PLSS, the current proposed solution is to mount a bracket on the forward-face of the PLSS that reaches around the crew member’s hip and provides an attachment feature to mount a conventional ISS-style Body Restraint Tether (BRT) or BRT-like device to (see Figure 6). This solution passes the loads through the PLSS structure and takes advantage of



Figure 6 Body Stabilization w/Rigidizable Tether

the PLSS-suit load harness, minimizing the “extra hardware” required to facilitate a basic EVA need. Finally, it should be noted that for the ARCM DRM pre-integrated handrails on the Capture Vehicle can provide time-savings at relatively simple worksites with low-load activities, a prime example of which is accessing the EVA Tool Box and withdrawing/returning tools. Coupled with a limited quantity of high-load EVA Worksites such as those out on the NEA where more aggressive activities such as geology core sampling would be conducted, this blend of foot-restraint and rigidizable tether body stabilization options will cover the needs of the ARCM DRM.

3. EVA Worksites & Micro-Gravity Geology

The primary EVA activity in the ARCM DRM is to acquire geology samples of the NEA. To this end, the previously described EVA Suit-Tool Interfaces and Body Stabilization techniques are recommended from the perspective of enabling a representative list of geology tasks. This is currently conducted using a flight-like BRT and where appropriate a Crew-Deployed Translation Path with a Foot Restraint (currently referred to as the “Stabilization Boom”). These devices allow for conservative evaluation of the MACES suit itself from the perspective of “can the needed tasks be conducted in the MACES with worksites and body restraint techniques like these” and are thus viewed as enveloping- if these systems can be shown to be successful together then it is likely worth further pursuit of optimizing them for flight from many different perspectives that are not worth pursuing at the present (for example, not “cutting weight” on the Stabilization Boom until the ARCM Capture Mechanism and EVA Ops Con are fully potted). For the sake of MACES development evaluations, the list of representative geology tasks has thus far been constrained to “Surface Sampling” of Float or “Stamp” material, Chip sampling of larger body components and subsurface-at-depth or “Core Sampling”. Ultimately development of these tasks and the prototype tools to conduct them are still in-work, though prototypes have been evolved over the recent past under the various NEA mission DRM’s and various AES projects. Thus, the current best-available prototypes have been used in the FY14 ARCM evaluations to drive out worksite needs and in particular are being used in the JSC NBL to determine

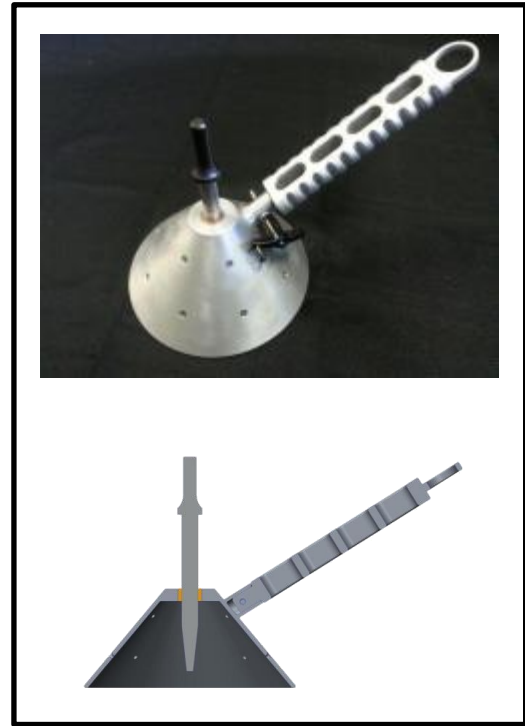

Figure 7 EVA Geology – “Hammer Sampling Cup”



Figure 8 EVA Geology – “Shallow Linear Core Tube”

acceptability of foot-restraint vs. BRT operations when out on the asteroid surface. Where needed, these prototypes utilize pneumatically operated COTs tools (usually air hammers) as an economical approach to quick development in the submerged environment. This approach has allowed the EVA Tools team to focus primarily on the end-effectors or accessories needed to obtain the geology samples in micro-g and defers the cost of developing EVA-compatible electrically operated power tools until the appropriate time in the flight development cycle. Thus far the power-operated hand tools have focused on a “Hammer Sampling Cup”(Figure 7) and a “Shallow Linear Core Tube” (Figure 8). The Hammer Sampling Cup allows the EVA Crew Member to chip off pieces of the larger body while simultaneously entrapping them and preventing their escape in the micro-gravity environment. The Shallow Linear Core Tube conducts light core drilling operations on body types that are limited to loosely-consolidated rubble piles and is not intended for sampling of monolithic (solid) stone. Future development is required to refine both items for greater sample containment and sampling operations of solid target materials, respectively.

For fiscal year 2014, the previously described Exploration EVA H/W Development Tools activities are geared towards supporting the MACES evaluations as the first priority, thus the EVA Tool development is intentionally

constrained in a way so as to minimize the change of variables between runs. Future work would be done to refine design concepts of EVA Tools to flight-appropriate versions, a prime example of which being a mass-driven design solution for the Stabilization Boom (Figure 9). Rather, for the present the EVA System is intended to stack together to allow progressively more complex evaluation tasks of the MACES and the ARCM EVA Timeline to the point where the general EVA requirements, including those of EVA Tools, can be effectively communicated during the Mission Concept Review. Once successfully past the MCR, the next major development cycle of the tools would pursue a round of refinement for flight-appropriate design features that include input from the astro-materials and planetary geology community. Early feedback from the science community has been provided by the NASA-Headquarters chartered CAPTEM (Curation and Analysis Planning Team for Extraterrestrial Materials) panel for the ARCM DRM and is being incorporated into planning and development tasks for early FY15.

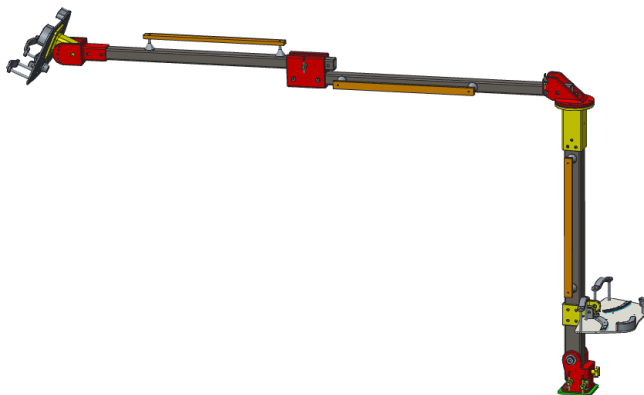

Figure 9. Crew-Deployed Translation Path with a Foot Restraint (“Stabilization Boom”)

VII. Validation Testing

F. MACES testing

In 2010 when the MACES was beginning to be evaluated as the LEA suit for Orion, testing began to assess the suit’s ability to complete pressurized tasks that would be required if the Orion capsule became depressurized. These tasks focused on operations where the suit was restrained in the seat and grew in 2011-2012 to include the ability to ingress the seat and to translate in micro gravity in the unpressurized Orion cabin. Also of interest was the ability of the MACES to be comfortable during extended periods of pressurization. After these evaluations higher fidelity tests were completed on the Active Response Gravity Offload System (ARGOS) and in the Zero-G aircraft. Feedback out of these tests was positive but it strongly pointed to the need for longer duration, multi-axis simulation accomplished in the NBL.

1. Lab Environment Testing

The first pressurized evaluations in this series were completed in the lab environment with the subject in the standing or seated posture (upright and recumbent). It was quickly determined that the sizing procedure for shuttle put the subject into suits that were too large for good pressurized mobility. The shuttle ACES configuration required a parachute harness that is not included in the Orion version. In order to perform its function correctly a parachute harness must be fit tightly to the crewmembers body. In an attempt to make the suit/harness combo more comfortable many crew members would upsize their suit to allow for more movement unpressurized. This also meant that the suit expanded a great deal when pressurized, leading to poor pressurized mobility. Elimination of the harness increased the comfort of the subject and allowed downsizing of the suit for a closer pressurized fit that provided more mobility. Evaluations indicated the need for testing that more closely resembled the conditions on orbit.



Figure 10. MACES in ARGOS



Figure 11. MACES in Zero-G flight

2. ARGOS Testing

The NASA JSC Engineering Robotics division (ER) has constructed a weight-relief system capable of simulating a very low friction environment. This ARGOS system received approval in 2012 for manned testing and work was begun to integrate MACES with this system. The suit is attached to the ARGOS via a hang gliding harness that was modified to interface with the suit. Testing with the ARGOS demonstrated that translation, body stabilization, and tool manipulation are feasible. Operations were conducted with male and female crewmembers. Based on the results of this testing, recommendations were made for higher fidelity testing on the Zero-G aircraft and in the NBL. Due to a failure of the ARGOS in 2013 this ground simulation is not currently available for manned testing.

3. Zero-G Testing

Due to the limitations of the ARGOS to support full 6 degree of freedom, microgravity testing, a Zero-G flight was completed in August of 2012 to determine if the ARGOS results would match the results of higher fidelity tests. Two days of Zero-G testing were completed with 4 subjects attempting to ingress the Orion seat in the pressurized suit and attempting to perform translation and body stabilization. The subjects were all able to ingress the seat and demonstrate the requested translation and body stabilization exercises. The subjects reported that they were less stable in Zero-G than on the ARGOS, but also reported that their experience in ARGOS gave them a good idea of how the suit would perform in Zero-G. The main drawback of the Zero-G test is the short duration of microgravity. Each parabola is ~20 seconds and this amount of time does not allow full simulation of complex tasks like attaching seat belts once inside the seat.

G. NBL Testing

1. Integration

Neutral buoyancy events are continually being used to support ISS EVAs. the MACES was the first use of a new American spacesuit underwater in over twenty years. There is a significant amount of facility support equipment used for EMU training events (breathing gas systems, ISS mockups, medical monitoring, diver support, procedures, etc.) that required a large investment. Given the developmental nature of the project, an attempt was made to leverage as many of these existing NBL systems as possible and to stay within the experience gained with the EMU. To maintain safety, the NBL operates within clearly defined parameters and requires that all changes go through a rigorous screening process. Since the major interface requirements of the MACES matched those of the EMU, the NBL facility systems were not modified. This allowed the use of existing NBL drawings, hazard analysis, and operating procedures for divers, gas and water supply systems, crane operations, and medical support. The NBL suit connector was left unchanged for MACES operations allowing the facility to switch umbilicals between EMU and MACES depending on the suit being supported that day. To accomplish this, a box was built to adapt the NBL connector to the Apollo style connectors that are on the front of the MACES. The NBL Umbilical Interface (NUI) can be seen as the silver box in Figure 8. All NBL services come from the umbilical/NUI and are then routed to their respective suit interface location.

To operate underwater the suit was modified from its intended flight configuration. The secondary oxygen system is not used in the pool and so the line into the suit was capped. Emergency oxygen bottles were removed from the legs and replaced with weight pouches that allowed the suit to be balanced underwater. Prior to manned use, all suit/facility integration operations were simulated unmanned. Training was also completed with the safety divers and subjects on intended nominal operations and emergency responses.

2. Manned Underwater Testing

i. First Runs

During fiscal year 2013 a total of 8 manned MACES events were completed in the NBL. The first runs demonstrated the ability to interface with the NBL systems, weigh-out the suit, and the subject's ability to use the suit underwater. Because of the development nature of the suit, operational time underwater was limited to 2 hours and to tasks that are accomplished regularly in the EMU. Also for these first runs only one suit was constructed for use in the pool. This allowed the team to build confidence in the suit prior to longer test events with more complex objectives. The NBL divers were able to weigh the suit out with the available weight pouches. A new chest weight was added to the suit in the second run that improved downward visibility. During one weigh-out, the crewmember noted that he could change his position inside the suit and modify the weigh-out balance of the suit such

that he could rotate the entire suit without touching any structure. The subjects practiced translation and body positioning. They successfully completed translation and body control exercises and provided feedback that padding could be helpful to reduce shifting in the suit. The weight packs on the arms were noted as causing some resistance to arm motion. Subsequent tests were able to operate without the arm weight packs. It was noted that the MACES has a different work envelope than the EMU and that time in the suit would be required to learn how to work in the suit comparable to how crewmembers learn to work the EMU. Tether points were made available to the subjects attached to the harness and they were able to see the tether points and reach them with the gloved hand. It was noted that having a floating tether point introduces more effort than a solid tether point such as the EMU mini-workstation. The crew simulated placing feet in a foot restraint and felt that using an EMU style foot restraint would not be a problem in this suit. The suit experienced some expansion from the beginning of the run and the crew felt that there was more room overall in the suit than at the beginning of the run. This has been experienced previously in EMU as the soft goods shift but the effect seemed to be a bit more than is typical with EMU.

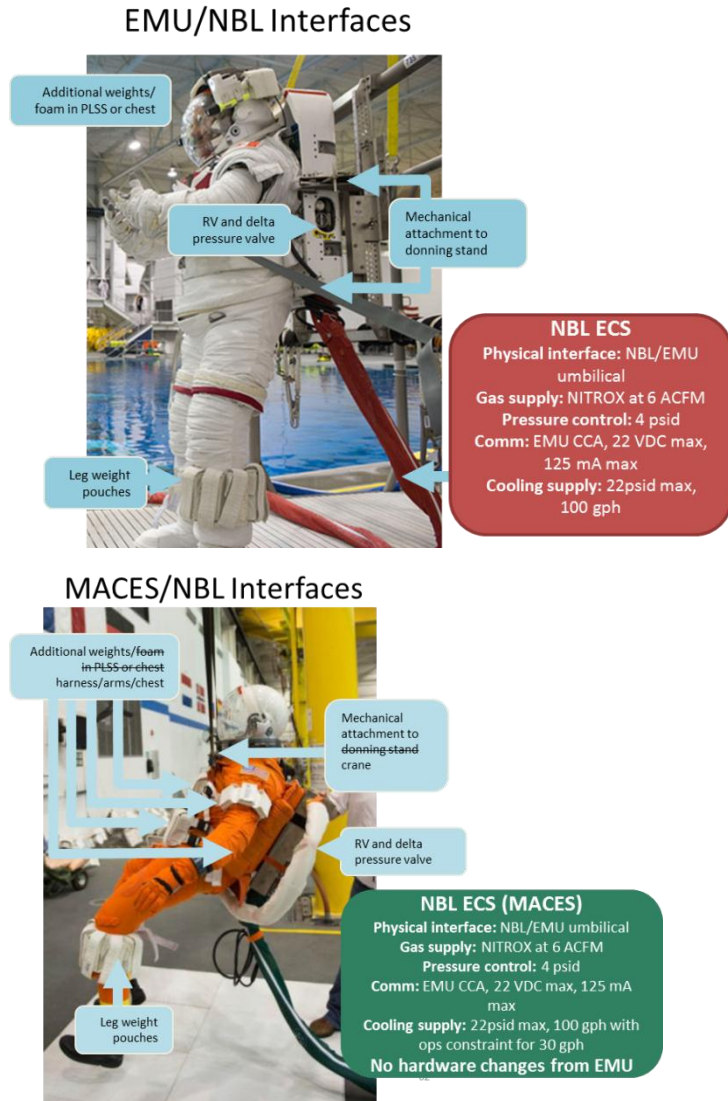

Figure 12. EMU vs. MACES NBL Interfaces



Figure 13. MACES in NBL

were replaced with EMU gloves designed for greater loads and harsh thermal environments.

The subjects in these tests all had significant EMU experience and gave positive feedback the use of the EMU gloves. Since these gloves are already approved for EVA use with a significant number of available sizes and known flight requirements, it makes sense to assume the use of these gloves for a capsule based EVA mission. It also significantly decreases cost and schedule risk since every spacesuit glove certification effort has required 2+ years of development and greater than a million dollars in cost.

During these runs the test subjects began attempting more complex tasks during these runs. Tasks successfully completed included: Ingress/Egress of the ISS airlock hatch, translating with a tool bag, translating across complex geometries including a boom, manipulating medium sized tools/mockups (APFR, GPS antenna), performing two handed tool operations, and early simulation of possible asteroid EVA tasks. These tasks were completed successfully but the crew did note a number of areas where the suit should be improved. The most significant of these comments related to the area of the work envelop and the need for better arm mobility.

It was noted that the ideal work envelope in the MACES is the lower abdomen region with the the subjects hands approximately shoulder width apart. This is due to the MACES being patterned for an aircraft pilot to have their hands on the yoke/stick while in the seated position. During a microgravity EVA, the preferred position of the hands near the level of the face so that the crew can see their hands and protect the helmet from damage. It is also important that the crew is able to bring their hands together to work with tools and tethers. These runs led to the recommendation that the suit arms be rebiased to a higher position with the arms more together. It was also recommended that arm bearings be added to the bicep region to improve mobility.

A TMG was added to the suit to simulate the thermal protection that would be required in a microgravity EVA. The TMG was constructed from a similar fabric layup to an EMU TMG. The exterior is made from Ortho fabric for abrasion protection, the thermal protection is from multiple layers of aluminized mylar, and the liner layer of neoprene coated nylon. The subject commented that the TMG did not limit his mobility and he was mostly unaware that it was present.

Simulated asteroid tasks included translating across ropes over boxes filled with rocks, body stabilization exercises using ropes in tension, and attempting to collect an astroid sample using an EVA wipe. The subjects found that they could translate across the ropes freely,

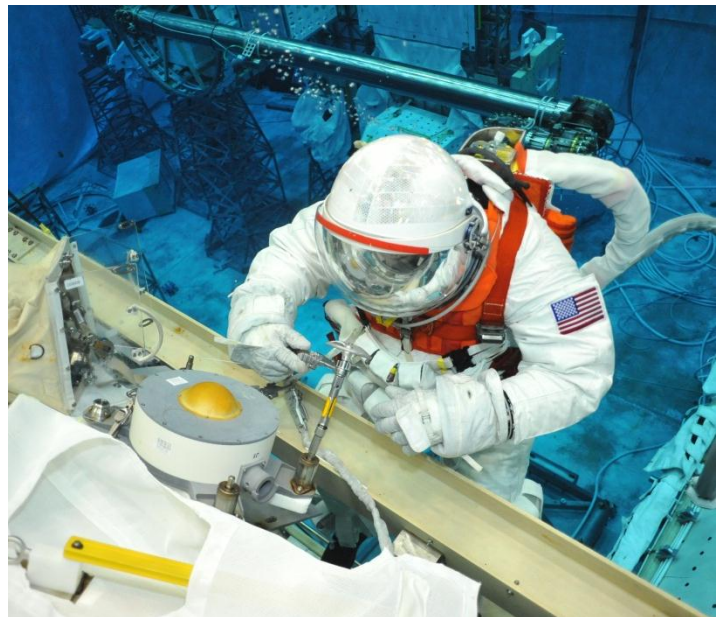

Figure 14. MACES with TMG in NBL

Divers also completed simulated emergency egress operations. It was clear that the mobility of the suit was inferior to that of the EMU but it was higher than had been expected and improvements were planned and implemented.

ii. Later Runs

In the following runs improvements were made to the suit. A second size suit was constructed to expand the subject pool, padding was added to the suit to increase comfort and usability, cooling capability was increased, overall test time was increased to 4 hours based on the incorporation of a drink bag and the completion of cycle testing to prove out the durability of the suit. The ACES IVA gloves

but that body stabilization would need to be improved for detailed sample observation and collection especially if two handed tasks such as core drilling would be required. EMU boots will be incorporated into the MACES in FY2014 for use in the NBL to demonstrate the ability to restrain the MACES to allow two handed tasks.

3. Future NBL work

In 2013 orders were placed for 4 new suits that had mobility enhancements, two with the shoulder rebiased so the neutral arm position is higher and more toward the center of the chest, and two suits with the shoulder rebiased and the addition of an arm bearing along the bicep with higher mobility elbow joint. EMU boots have also been added to the suit and analyzed for possible loads. Major objectives for 2014 testing will include: evaluation of mobility enhancements, attempting to ingress/egress EMU foot restraints, accomplishing two handed tasks inside of the EMU foot restraint, testing with two crew members in the water at one time to evaluate the crew's ability to help one another, and testing on higher fidelity capsule mockups that will more accurately represent an asteroid type EVA.

H. PLSS analysis

Analysis activities completed from August 2013 to February 2014 have been used to determine the feasibility and applicability of the current Advanced PLSS system for use in the ARCM architecture. First, analysis was done to define the thermal environment for a cis-lunar 4-hour EVA based on initial operational constructs for the ARCM mission. The Wissler metabolic model was used along with a Thermal Desktop cis-lunar thermal definition and estimated metabolic rates from early NBL testing to determine the size of both oxygen and water cooling supplies. Alongside PLSS consumables estimation, the PLSS-to-MACES interface kit relief valve and Multi-Position Purge Valve were evaluated to provide overpressure protection and 30-minute purge capability specifically tailored to the ARCM mission.

1. Thermal Environment Definition

In October 2013, analysis was performed to generate a range of parametrically-analyzed environment definitions for the ARCM mission in cis-lunar space. For cis-lunar space, maximum and minimum orbital solar flux values (1354 - 1421.7 W/m²) were used along with Thermal Desktop models of a spherical asteroid and asteroid retrieval spacecraft to determine the minimum and maximum suit heat leak rate and environmental sink temperature. The Thermal Desktop models considered geometry, thermal conductivity, and thermal emissivity. A suited crew member was simulated assuming a 3-5 layer multi-layer insulation (MLI) overcoat worn over the MACES exterior to determine heat leak to the space environment. It was determined that the worst-case heat leak rate based on an all-white reflective covering on the asteroid retrieval enclosure and no asteroid mass thermal conductivity was 146.6 Watts. The heat leak rate was determined based on a corresponding worst-case environment sink temperature of -380 deg. F. The 'cold' case was based on a suited crewmember at the end of the integrated vehicle stack, with the Orion capsule, Asteroid Redirect Vehicle, and asteroid mass shielding the crew member from sunlight. Alternatively, the 'hot' case was based on a suited crew member operating at the intersection of the Asteroid Redirect Vehicle and the asteroid mass in full sunlight, with a white reflective covering on both the retrieval vehicle and asteroid enclosure. Using these assumptions, the suit heat leak rate was -3.9 Watts and thermal sink temperature was 73.8 deg. F. The suit heat leak rates and environmental thermal sink temperatures were then used for thermal cooling Feedwater Supply Assembly (FSA) sizing calculations.

2. Consumables Sizing

Once environment definitions were established, analysis was completed to determine the amount of oxygen breathing gas and liquid cooling water needed for an ARCM 4-hour planned EVA. Emphasis was put on assuming no change to the existing PLSS primary oxygen tank sizes, but rather, analyzing the duration of use for gas contained in the existing planned tank volumes. The amount of feedwater included in the Interface Kit was considered to be a custom variable tailored to the ARCM case.

Primary oxygen tank sizing was done considering a variety of parametric variables. Parameters included EVA duration (4-8 hours), average EVA metabolic rate (1200 BTU/hr average), suit leakage rate (200-400 sccm @ 4.3

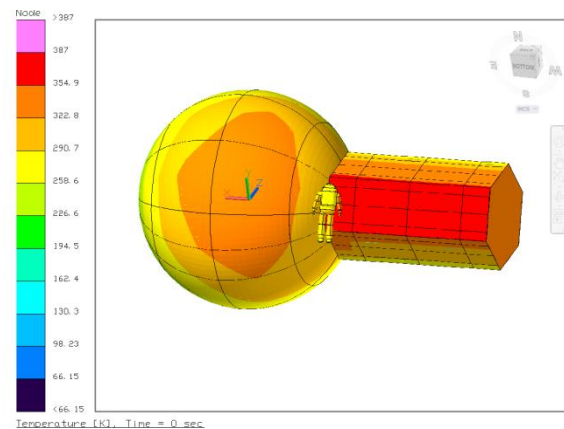

Figure 15. Thermal Desktop Example of ARCM Cis-Lunar Maximum Temperature Thermal Environment

psia), and an RCA ullage ventilation gas loss of 1.875 grams/hr. From preliminary analysis, it was determined that the baseline Advanced PLSS primary oxygen tank volume provides approximately 5 hours of breathing gas during a 4 hour EVA with 300 sccm suit leakage and 1200 BTU/hr metabolic rate. This served to verify the PLSS oxygen supply as applicable for the ARCM mission case. Analysis is currently underway to determine Secondary Oxygen System sizing and applicability to a 30-minute abort scenario in which the Secondary Oxygen System would provide CO₂ washout and ventilation cooling to the crew member.

Variables considered in cooling water consumables analysis were upper and lower bounding crew member metabolic rates, hottest and coldest environment temperatures, and MACES pressure garment bladder moisture permeability. To determine the maximum amount of feedwater needed for a 4 hour ARCM spacewalk, the hottest environmental definition of 73.8 deg F thermal sink temperature was integrated into the Wissler metabolic model to calculate results. For the 4 hour EVA case, assuming a ventilation flow of 6 ACFM and metabolic rate of 1200 BTU/hr, 4.5 pounds of feedwater is required to backfill cooling water used in the MACES liquid cooling garment. Analysis in 2014 is currently in progress to examine the placement of the Primary Feedwater Supply Assembly inside the MACES pressure garment, as well as the need for any contingency feedwater for use in the event of primary cooling loop failure.

3. PLSS Operational Concept Development

A key element of 2013-2014 ARCM architecture development was investigation into the operational concept (ops con) needed to enable capsule egress using the Advanced PLSS inside the Orion vehicle. The Advanced PLSS, as an evolutionary step towards expanded beyond low Earth orbit EVA capability, contains several hardware subcomponents of interest when formulating operational concept constraints. The Advanced PLSS architecture, baselined in 2011, initially assumed the use of a vehicle-mounted suitport or airlock module in which the Rapid Cycle Amine (RCA) CO₂ removal system could be connected to a vacuum port during EVA preparations. High-quality vacuum access is key for the proper function of the RCA swing beds to remove CO₂ from the PLSS ventilation loop, as well as purging any stored ammonia during initial RCA startup. As part of the ARCM mission, EVA preparation is done inside the Orion capsule, with no 'hardlined' vacuum access port, but rather, the entire capsule cabin is brought to vacuum and EVA egress operations begin. Late 2013 efforts were focused determining historical capsule-based EVA preparation precedents, identifying the key steps needed for EVA prep and egress from the Orion capsule in addition to identifying the hardware and operational solutions needed for RCA vacuum access during pre-EVA activities.

As mentioned previously, during NASA's earliest Gemini spacewalks, EVAs were performed at the end of a life support umbilical providing high pressure oxygen to a suit-mounted regulator system. During Apollo deep space EVAs, life support again was provided via umbilical, with an auxiliary Secondary Oxygen Pack worn for contingency use. Current EVAs from the ISS airlock are achieved using the ISS EMU in which pre-EVA checks are performed at space station ambient pressures while attached to the Servicing and Cooling Umbilical that provides liquid cooling and oxygen replenishment during the time preceding an EVA. The PLSS pre-EVA and egress operational concept developed during late 2013 is a hybrid of current and historical means for enabling spacewalking.

From analysis of current and past EVA preparation checklists and procedures, four key steps for pre-EVA prep and PLSS activation were identified. The four steps include PLSS checkout before manned use, ventilation loop nitrogen purge, crew member oxygen pre-breathe activities, and finally, configuration of ventilation and thermal control loops for egress. Addressing the need for RCA vacuum access, analysis is currently being undertaken for the sizing and development of a small vacuum pump system that would evacuate the RCA chamber of any gathered ammonia while providing the vacuum needed for the RCA amine beds to desorb any carbon dioxide. The use of a small vacuum pump provides the capability to perform all pre-EVA checkouts while operating the MACES-PLSS combination above the cabin ambient pressure, reducing the risk of hypoxia and decompression sickness during the activities leading up to EVA egress. It should be noted that the Suit Water Membrane Evaporator (SWME) used for thermal loop cooling also relies on vacuum for functionality. However, during EVA preparations, the need for crew member cooling will be met by connection of the MACES liquid cooling garment into the Orion liquid cooling umbilical loop.

EVA preparation from a PLSS perspective includes the initial startup, checkout, and configuration for EVA of all PLSS subsystems. When formulating the ARCM EVA ops concept, the assumption is made that in the days leading up to a planned ARCM EVA, the crew will do pre-EVA checkouts of the PLSS primary and secondary oxygen regulators, pressurizing their MACES suits while performing suit integrity checks. Additionally, the crew will perform thermal control loop flow checks, configuring the PLSS liquid cooling umbilicals to form a closed loop system, setting the PLSS thermal control loop pump to 200 pounds an hour, and verifying the proper flow. These

relatively simple checks leading up to the day of an EVA ensure a proper PLSS baseline functionality before human-in-the-loop operations on EVA day. On the day of the EVA, the crew members will don their suits, connecting their liquid cooling garments (LCGs) to the Orion liquid cooling loop. Current analysis in this regard is tailored to the identification of the specific hardware and software assets needed to simplify PLSS checkout and verify PLSS functionality in the days leading up to an ARCM EVA. At present, this represents a minimal impact on crew member workload and any checkouts would be modelled after existing ISS EMU-style procedures as applicable.

Ventilation loop purge for EVA was an important constraint considered in the development of the ARCM PLSS ops concept. During EVA preparation, the intent is that the ventilation loop will initially be purged of any accumulated waste gasses to enable crew member pre-breathe activities immediately preceding capsule depressurization and EVA egress. During ops concept formulation, the use of the aforementioned vacuum pumping system was traded against the development of a ventilation loop switchover valve intended to isolate the PLSS ventilation loop from the crew member and vehicle environmental control loop. The isolation valve mass, complexity and EVA work station impacts drove 2014 efforts to focus on the analysis and design of the vacuum pump purge kit rather than valve development. From an operational standpoint, each PLSS' RCA canister will be evacuated before PLSS umbilical connection to the MACES. Immediately following suit donning, the crew members will connect their individual PLSS RCA vacuum reference ports to the on-board vacuum pump assembly and begin evacuating the RCA canister of any CO₂ or trace gases. Once the respective canisters have been properly evacuated, the crew member will connect their PLSS ventilation supply and return umbilicals to the MACES. Additionally, the crew will mate the PLSS oxygen tank recharge umbilical to the EVA Servicing Kit under development to provide in-situ oxygen tank recharge capability during all phases of EVA activities. With helmet visors open and the PLSS ventilation gas sensors set to monitor CO₂ levels, the crew members will initiate flow via the suit-mounted Display and Controls Module (DCM). Once positive flow has been established, the crew members will close and lock their helmet visors and begin suit pressurization to 0.5-1.0 psid above cabin ambient pressure. Once at pressure, the crew members will begin PLSS fan, Secondary Oxygen Regulator (SOR), and Primary Oxygen Regulator (POR) checkouts. Upon satisfactory completion of pre-EVA hardware checks, crew members will set the PLSS POR to 0.5 psid referenced to cabin pressure, and open their MACES-mounted Multi-Position Suit Purge Valves (MSPVs) to purge any nitrogen from the suit cavity and associated umbilicals. Analysis combined with operational cabin atmosphere oxygen saturation constraints will dictate the amount of time for PLSS open-loop purge inside the Orion vehicle. Once open-loop nitrogen purge has been completed, the crew will proceed to EVA pre-breathe to alleviate the physiological risk of decompression sickness. This ventilation loop purge operational paradigm as detailed allows for all operations to be done with a fully-pressurized cabin, following in the precedent of Shuttle and ISS EVA activities. Considered alternatives to this process imposed the need to change breathing gas supply umbilicals at near-vacuum conditions in order to provide real-time exhaled carbon dioxide removal via the RCA. Additionally, if the vehicle Environmental Control System was used for crew member pre-breathe, it was determined via system schematic examination that there existed the chance of atmospheric trace nitrogen inclusion into the pressure garment when the PLSS supply and return umbilicals are connected to the MACES.

Crew member pre-breathe as proposed with this PLSS ops concept may be accomplished with a four-hour in-suit pre-breathe protocol or custom protocol as determined by the aeromedical community. After open-loop purge, the crew members will close and verify secure their MSPVs and begin suit pressurization to 4.3 psid. During this time, metabolic oxygen consumption will be counter-balanced via the EVA Servicing Kit. Liquid cooling will be provided via Orion liquid cooling umbilicals, and RCA vacuum access will be continually provided via the vacuum pump system. At the appropriate time, the cabin will be configured for depressurization. In the event of a PLSS primary oxygen system anomaly, the secondary oxygen system can be activated while the Orion capsule repressurizes. Again it should be noted that all pre-breathe procedures are done with the cabin at ambient conditions with the capability to easily depressurize the MACES and open the helmet visor in the event of ventilation loop failure.

As the Orion cabin depressurizes, crew members will monitor suit pressure as the PLSS POR begins to actively regulate while referencing sub-ambient pressures. The final activities before EVA egress include disconnection from the EVA Servicing Kit and RCA vacuum pump followed by liquid cooling authority transfer. Once the cabin has been depressurized to vacuum, the RCA vacuum pump will be disconnected, with special attention paid to the PLSS gas sensor carbon dioxide reading. In the event of rising ventilation loop carbon dioxide levels before hatch opening, the PLSS would be configured into open-loop purge mode and the cabin would be re-pressurized. The final PLSS-related act before egress is connection to the primary thermal control loop to provide liquid cooling to the crew member. The crew will reconfigure their thigh mounted MACES liquid cooling interfaces to connect to the PLSS cooling umbilical set instead of the Orion liquid cooling loop. Once connected, the crew will perform a short pre-

egress functional check of the SWME and thermal control loop pump, verifying proper cooling and flow. After configuration of space-based radio assets, the EVA will begin.

4. PLSS Operations Concept Development Conclusions

From 2013 and 2014 analysis and development activities, the Advanced PLSS currently under consideration for use in NASA's ARCM effort fits the mission profile with little to no changes to PLSS consumables sizing. Current Advanced PLSS oxygen tank volumes provide for at least five (5) hours of EVA capability operating at a constant average crew member metabolic rate of 1200 BTU/hr. Liquid cooling water sizing analysis yields a modestly-sized primary Feedwater Supply Assembly (FSA) of approximately 4.5 pounds of water, currently under evaluation for integration inside the MACES suit bladder. Furthermore, the operational use of a small, low mass vacuum pump system alleviates the complexities of ventilation loop switch-over following cabin depressurization. For 2014, analysis efforts are focused on the characterization of the MACES-to-PLSS specific hardware items such as the Multi-Position Suit Purge Valves (MSPVs) used for pre-EVA open-loop purge and contingency metabolic cooling and the Positive Pressure Relief Valve (PPRV) designed to prevent MACES over-pressurization over a range of operating conditions. Mid 2014 activities include planned full-mission profile evaluations of the specific operational steps needed to perform MACES-to-PLSS Interface Kit configuration, donning and EVA egress activities as well as the PLSS avionics architecture needed to support such actions.

VIII. Conclusion

There is much work left to complete, but it appears now that an architecture of a Launch/Entry/Abort suit with a PLSS is feasible and the best option for the Asteroid Redirect Mission. NBL testing will continue in order to determine the right requirements to place on the suit. The PLSS interface work will continue as the PLSS itself continues to be developed. As the Asteroid Mission matures, the suit/life support portion of the mission will mature along with it and EVA Tools & Equipment can be iterated to accommodate the overall mission objectives and compromises inherent in EVA Suit optimization.