

IAC-14-B2.3.2

STUDYING NASA'S TRANSITION TO KA-BAND COMMUNICATIONS FOR LOW EARTH ORBIT

David ChelminsNASA Glenn Research Center, United States of America, dchelmins@nasa.gov**Richard Reinhart, Dale Mortensen, Bryan Welch, Joseph Downey, and Michael Evans**

NASA Glenn Research Center, United States of America

As the S-band spectrum becomes crowded, future space missions will need to consider moving command and telemetry services to Ka-band. NASA's Space Communications and Navigation (SCaN) Testbed provides a software-defined radio (SDR) platform that is capable of supporting investigation of this service transition. The testbed contains two S-band SDRs and one Ka-band SDR. Over the past year, SCaN Testbed has demonstrated Ka-band communications capabilities with NASA's Tracking and Data Relay Satellite System (TDRSS) using both open- and closed-loop antenna tracking profiles. A number of technical areas need to be addressed for successful transition to Ka-band. The smaller antenna beamwidth at Ka-band increases the criticality of antenna pointing, necessitating closed loop tracking algorithms and new techniques for received power estimation. Additionally, the antenna pointing routines require enhanced knowledge of spacecraft position and attitude for initial acquisition, versus an S-band antenna. Ka-band provides a number of technical advantages for bulk data transfer. Unlike at S-band, a larger bandwidth may be available for space missions, allowing increased data rates. The potential for high rate data transfer can also be extended for direct-to-ground links through use of variable or adaptive coding and modulation. Specific examples of Ka-band research from SCaN Testbed's first year of operation will be cited, such as communications link performance with TDRSS, and the effects of truss flexure on antenna pointing.

I. INTRODUCTION

NASA's ongoing spacecraft missions to study Earth and space phenomena drive the need for enhanced data return capability. The data rates necessary for today's missions can reach easily into the gigabytes per second of data return for satellites in low earth orbit (LEO). The growing need to return large volumes of data brings with it a need for large amounts of communication bandwidth. The demand for higher data return data rates is now being realized by space missions (Ref 1).

Over the past 50 years, NASA has moved from S-band to X-band communication. Further increases in data rates and volume will push missions to consider Ka-band (Ref 2). The International Telecommunications Union (ITU) makes allocations for the Earth Exploration Satellite Service and the Space Research Service, both of which support NASA missions. The ITU allocated approximately 10 MHz for space science at S-band, 375 MHz for Earth science at X-band, and 2.25 GHz bandwidth for space-to-space links at Ka-band. Ka-band is an appealing communications migration path for data- and bandwidth-intensive missions.

The Communications and Navigation Systems Roadmap (Ref 3), published in 2013, states that NASA currently is "migrating its high rate mission data to Ka-band as part of a continuing trend in high data rate return" and it is "expected that the trend toward higher data rate needs will continue in the future and will eventually surpass the capacity available with radio

frequency Ka-band". In addition to near-term Ka-band migration, which leverages more efficient power amplifiers, the report proposes development of high-efficiency compression, coding, and modulation techniques that will reduce the cost per data bit.

In order to study the transition to Ka-band communication for LEO, NASA developed and launched the SCaN Testbed, which is a software-defined radio payload installed on an external truss of the International Space Station (ISS). The SCaN Testbed project is studying the development, testing, and operation of software-defined radios and their associated applications for future use by space missions. The project conducts research into advanced communications, navigation, and networking techniques that will be applicable to future space missions.

The SCaN Testbed contains NASA's first space-qualified Ka-band transceiver, developed through a cooperative agreement with the Harris Corporation (Ref 4). The SCaN Testbed spectrum license permits communication over Ka-band space-to-space links, intended for communication with NASA's Tracking and Data Relay Satellite System (TDRSS) spacecraft. The Harris radio is the first NASA transceiver of the TDRSS Ka-band capability for on-orbit operations.

This paper discusses the work being performed on SCaN Testbed to use Ka-band. It discusses the on-orbit performance testing conducted on the Ka-band SDR over the past 2 years, and it presents goals for upcoming research in the future.

II. MISSION USE OF 26 GHZ KA-BAND COMMUNICATIONS

There are a number of missions that use Ka-band (26 GHz) for their communications other than the SCaN Testbed. NASA missions such as Solar Dynamics Observatory and Lunar Reconnaissance Orbiter both use Ka-band to return data direct to ground stations. Several JAXA missions, including Advanced Earth Observing Satellite, Advanced Land Observation Satellite, and the Japanese Experiment Module (JEM) on ISS, communicate with the Ka-band Japanese Data Relay Test Satellite (DRTS), named Kodama. The European Space Agency earth observation mission entitled Envisat (recently concluded in 2012) used Ka-band to relay through Artemis. There are also a number of Ka-band missions in development by these three space agencies along with the National Oceanic and Atmospheric Administration (NOAA) and European Organisation for the Exploitation of Meteorological Satellites (EUMETSAT).

Although Ka-band provides potential for order-of-magnitude higher data rates, the transition from S-band to Ka-band in near Earth orbit has been slow. From reusing hardware and systems from previous missions to reduce risk, or more technical concerns of increased complexity of narrow beam antenna pointing, missions have been reluctant to use Ka-band. Through the SCaN Testbed experiments, NASA has demonstrated operations with TDRSS at Ka-band. These experiences will provide lessons learned for future missions considering and planning to use Ka-band and reduce the perceived risks of using this frequency.

III. SCAN TESTBED KA-BAND SYSTEM

The SCaN Testbed communicates with the Tracking and Data Relay Satellites (TDRS) over a full-duplex Ka-band link. The key radio frequency (RF) components that enable communication over this link are a travelling wave tube amplifier (TWTA), a high gain antenna (HGA), and an integrated gimballed assembly, as shown in Figure 1. The state-of-the-art, compact, lightweight TWTA was built by L3 Communications Electron Technologies Inc., and has a minimum output power of 40 W over the characterized frequency range of 25.5 to 25.8 GHz. The high gain antenna is a focal-fed parabolic reflector, with a dish diameter of 0.5 meter. The peak antenna gain is 39 dB for the 22 GHz receive band, and 39.8 dB for the 25 GHz transmit band. The integrated gimballed assembly includes waveguide rotary joints, a 2-axis gimballed pedestal, and associated control electronics. The SDR operating at Ka-band was built by Harris Corporation.

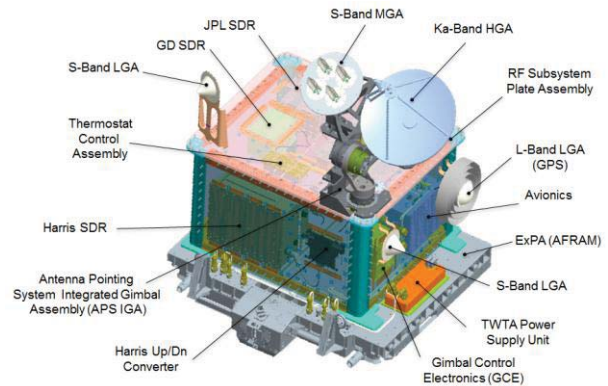

Fig. 1: The SCaN Testbed consists of a number of components that support Ka-band, including a TWTA, HGA, and an integrated gimballed assembly.

The Harris SDR consists of an AITech s950 single board computer, a field-programmable gate array (FPGA)-based signal processing modem board, digital IO board, sampler card, and other components integrated into a 6U compact Peripheral Component Interconnect (cPCI) chassis. The modem board contains 4 Xilinx IV radiation-tolerant FPGAs that are completely reconfigurable during flight. The RF input and output of the SDR occurs at S-band, and an external RF converter is used to bring the signal to Ka-band. The SDR outputs approximately 1 mW at Ka-band, which is then amplified by the TWTA.

IV. SCAN TESTBED OVERVIEW

SDR technology provides the ability to remotely change radio functionality throughout the life of a mission, allowing the radio to adapt to evolving requirements or an unpredictable operations environment. Besides the Ka-band system, the SCaN Testbed also contains S-band SDRs developed by the Jet Propulsion Laboratory (JPL) and General Dynamics Corporation (GD). The JPL radio also provides L-band receive capability, which supports Global Positioning System (GPS) operations. The GD radio contains experimental non-volatile chalcogenide phase-change memory, which provides faster access times and less physical degradation than Flash memory. The suite of SDRs at S-band and Ka-band allows many opportunities to test different applications at both frequencies to gain a better understanding of the advantages and risks of moving mission operations to Ka-band.

The Ka-band provides a 225 MHz channel over TDRS while the S-band allocation is 6 MHz. Waveform data rates at Ka-band exceed those at S-band significantly. The launch S-band return link waveforms operate at various data rates ranging from 24 kbps up to 1 Mbps. The launch Ka-band return link waveform is a variable rate waveform which typically operates from 1

Mbps up to 100 Mbps. Waveforms at both S-band and Ka-band employ various data framing protocols, and forward error correction encoding and decoding.

V. KA-BAND TRACKING OVERVIEW

The Ka-band HGA can be controlled via the Antenna Pointing System (APS) using open-loop pointing or closed-loop tracking. The difference between the two modes is the presence or lack of a feedback signal for the gimbal control system. Either mode utilizes a pre-generated nominal pointing routine. If closed-loop is enabled, a feedback signal derived from the received signal strength is used to maximize signal strength by redirecting the pointing direction. The closed-loop tracking functionality is made up of two modes: an acquisition spiral and an autotrack mode.

The two closed-loop modes can be enabled separately, but both are required for closed-loop tracking to function properly. The spiral track mode enables a growing spiral of user-defined lap size to be added to the nominal pointing routine, such that the received signal is observed until it reaches a user-defined threshold. At that threshold point, the mode switches to autotrack functionality, where dither is performed on a single axis at a time for the purpose of determining how to optimize received signal strength so that the derivative of the signal over the dither period is zero. The autotrack mode also has a cross-over threshold; if the received signal crosses below a certain level, the spiral search mode can be restarted so that the peak signal can be reacquired.

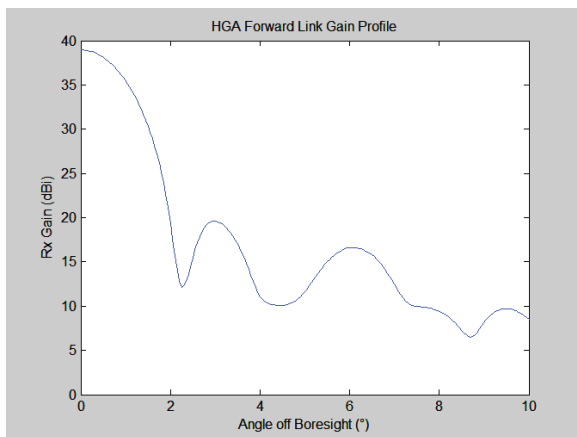

Fig. 2: HGA receive on-orbit antenna pattern.

To implement the SCA_N Testbed closed-loop tracking process, the input signal is received first by the Ka-Band HGA and then it is provided to the Harris SDR via the Ka-Band RF subsystem. The Ka-Band antenna pattern, determined in-situ on ISS, is provided in Figure 2 (Ref 5). This antenna pattern is mapped to expected received signal strength indicators from the Harris SDR

to determine the nominal thresholds to use for Ka-Band closed-loop tracking purposes.

As there exists roughly 20dB between the peak of the receive pattern and the peak of the first side lobe, the thresholds are set roughly 10dB above the received power level of the first side lobe, so that any received signal above threshold is guaranteed to be on the HGA main beam. Second, the thresholds are set roughly 1dB apart (spiral to autotrack transition and autotrack to spiral transition) so as to minimize inadvertent transitions between tracking modes. Based on the beamwidth, the spiral track lap size is set to 1°, so that a spiral lap cannot miss the received signal, as it would if the lap size were set too large. Setting the lap size smaller would allow more opportunities for finding the peak, though increasing the acquisition time for running through the spiral motion. The APS was tuned via ground-based testing, of which the closed-loop proportional and integral gains were obtained that best suited the received signal properties with the model of the underlying control of the APS (Ref 6).

The spiral track search process is optimized to minimize the acquisition process of the TDRSS signal, and thus maximize the time spent during the event with accurate pointing. However, it is important to consider that the closed-loop tracking algorithm's overall performance cannot overcome all shortcomings in the underlying pointing profile. Errors in the pointing profile originate from pointing vectors, commonly called Two-Line Element (TLE) vectors for spacecraft, as well as attitude errors in the receiving spacecraft. Given the orientation of SCA_N Testbed on ISS and more importantly the orientation of the APS axes on SCA_N Testbed, nominal TLE staleness related errors induce pointing errors in the APS azimuth axis, which are errors associated with changes in the ISS argument of periapsis or altitude, as opposed to pointing errors in the APS elevation axis that are associated with changes to the ISS ascending node. Both types of error are possible given TLE staleness, though the dominating error is the error that changes the APS azimuth position. One common observation from this phenomenon is that scheduled events (access performed up to three weeks before the event) can have up to several minutes of waiting time before the TDRSS spacecraft actually enters the gimbal space field of view, where the majority of the event is limited to the movement through the azimuth axis. Therefore, closed loop tracking cannot fully overcome TLE staleness.

Regarding attitude errors, the ISS attitude is determined nominally at the center of mass for ISS, which is located near the center of the ISS. However the SCA_N Testbed is located on the ELC3 truss, which is out away from the center of the ISS. The attitude that is observed from SCA_N Testbed has two error components. First, the nominal attitude profile is only a

control point, for which three axis attitude errors oscillate around the control point periodic with the ISS orbital period (see Figure 3 for reference). Second, as the ISS moves through the orbital period, the truss where SCaN Testbed is located suffers from a flexure that induces additional periodic attitude error. This has been characterized in Ref 7. Here, attitude errors directly induce pointing error, from either the unknown pre-existing attitude vector error, or from the several degree pointing error due to flexure. These attitude errors are specific to the ISS platform and must be overcome for testing on SCaN Testbed; nonetheless, other Ka-band users may have similar issues.

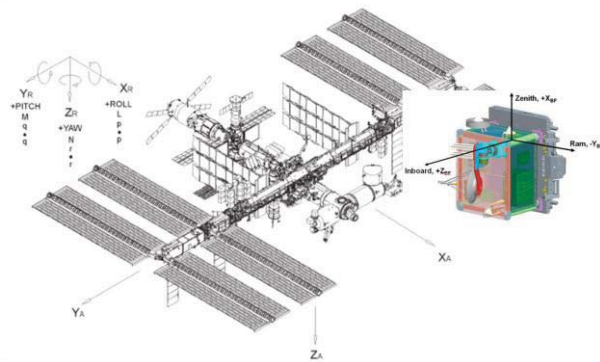

Fig. 3: ISS and SCaN Testbed reference frame.

Closed-loop tracking is preferred, as the many forms of error prohibit open-loop pointing to be performed without very stable and reliable information on current TLE, attitude, and flexure. TLE staleness causing 14 seconds of delay of the signal entering the gimbal space induces a pointing error of 1° , which is already the 3dB antenna beamwidth. In addition to that, the variations of the center of ISS attitude can also induce at most roughly 1 to 2° at the peak of the attitude axis errors. Finally, flexure can add an additional 1 to 2° of attitude error to the pointing error. Together, the cumulative of these errors can easily force the HGA to rarely be aligned in an open-loop mode of operation. The closed-loop tracking routine quickly resolves these errors and maintains lock on the source signal.

VI. LAUNCH WAVEFORM PERFORMANCE

The Ka-band SDR was launched with a relatively simple waveform (WF), compatible with the legacy Space Network (Ref 8). Table 1 describes receive and transmit parameters of the software defined waveform application. The waveform data rates and frequencies are programmable, however the SCaN Testbed regulatory frequency allocation restricts the center frequency.

Table 1: Ka-band Launch Waveform Parameters

Parameter	Receive	Transmit
Modulation	BPSK	SQPSK
Data Rate	3 Mbps	100 Mbps
Forward Error Correction	$\frac{1}{2}$ rate Viterbi	$\frac{1}{2}$ rate convolutional

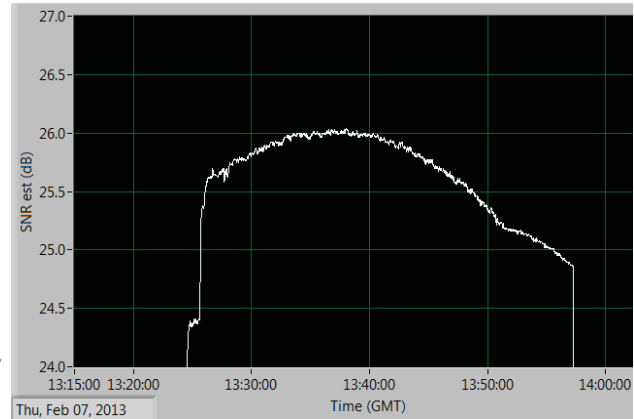

Fig. 4: Forward link signal-to-noise ratio (SNR) for a typical Ka-band pass with TDRSS.

The launch WF performance on-orbit met predictions based on system link margin and pre-flight characterization. A typical forward link SNR profile is shown in Figure 4, illustrating the system's relatively high and steady signal strength with less than 2 dB of variation. The Effective Isotropic Radiated Power (EIRP) is sufficient to maintain a BER of 10^{-8} on both the forward and return links. For these reasons on-orbit tests typically run error-free over the approximately 40 minute pass time even at the highest data rates. The link budget summary is presented in Table 2, yielding ample margin for the given parameters. Closed loop antenna pointing is assumed here but accurate open loop pointing has also been successfully demonstrated in specific cases with fresh TLE information and lower data rates when link margins are higher and accurate pointing is less critical.

Table 2: Link Budget

Parameter	Forward Link (SDR Receive)	Return Link (SDR Transmit)
Frequency (GHz)	22.68	25.65
Data Rate (Mbps)	9.5	100
Modulation	BPSK	SQPSK
Convolutional Coding	$\frac{1}{2}$ rate	$\frac{1}{2}$ rate
Bandwidth (MHz)	38	200
EIRP (dBW)	63	49.2
G/T (dB/K)	2.69	26.51
Required BER	10^{-8}	10^{-8}
Range (km)	43550	
Link Margin	3.0 dB	2.4 dB

Since the link margin is nominally high for the system, some testing was done with planned programmed APS offsets to mis-point the high-gain antenna so as to generate bit errors for performance measurement. Figure 5 shows some 3 Mbps forward link test data from which a performance point of $2.7E-7$ BER at an 11.5 dB E_b/N_0 can be extracted. This performance agrees with pre-flight performance at the same E_b/N_0 level, which can be referenced in Figure 6.

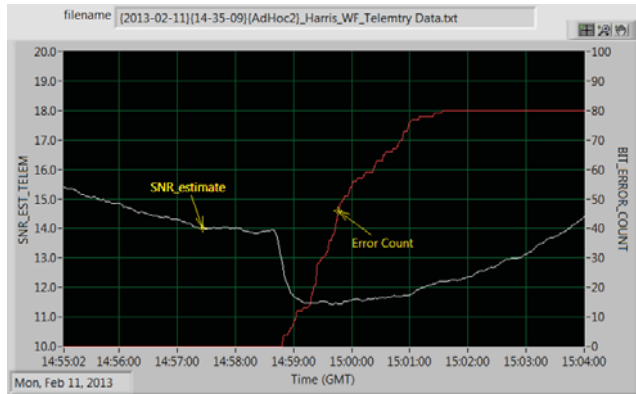

Fig. 5: Forward link errors induced due to mis-pointing the Ka-band antenna.

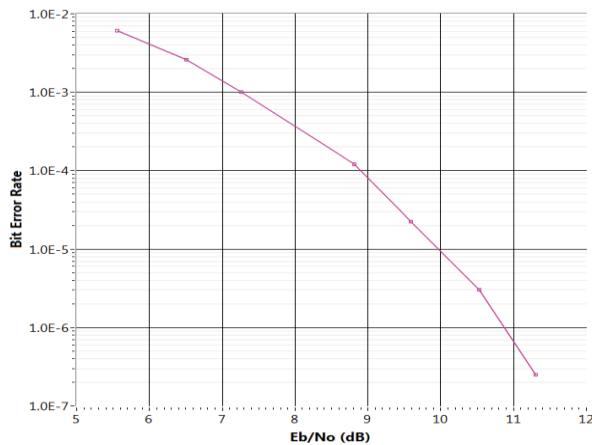

Fig. 6: Pre-launch reference BER performance with a forward link data rate of 3 Mbps uncoded. The 11.5 dB point corresponds approximately with the $2.7E-7$ BER point off the chart.

A fundamental component of the launch WF's pointing capability is the generation of the Antenna Pointing Quality Metric (APQM). This metric is effectively a linear signal strength indicator with decibel units and strong out-of-band noise rejection. The APQM strategy works well for closed-loop antenna pointing based on characterization data, and it is designed for tracking BPSK-modulated data.

An independent APQM design was developed at NASA GRC as part of a generic signal capture waveform application. The purpose of the signal capture

application is to record raw samples from the SDR analog-to-digital converter, allowing processing of arbitrary waveforms on the ground. One of the motivations for this development is that the new algorithm handles any modulation scheme and is not limited to strictly BPSK. Additionally, the GRC-based APQM generator has the option of disabling wideband-noise rejection, and this has proven useful for tracking noise sources (such as the sun) for calibration purposes.

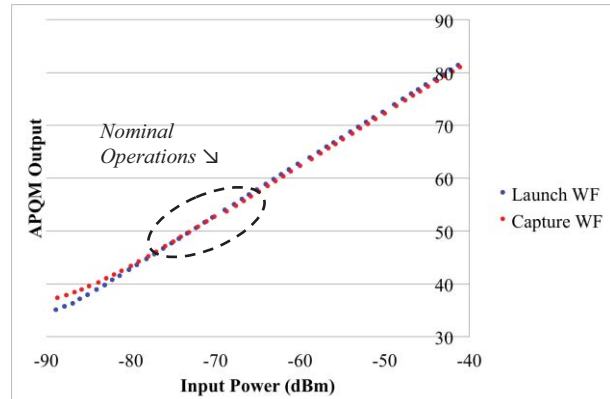

Fig. 7: Antenna pointing quality metric versus input power, showing the comparison between the launch waveform and capture waveform methods.

The new APQM design has been successfully demonstrated on-orbit, and its performance was indistinguishable when compared to the launch WF, as shown in the nominal operations region of Figure 7. Additionally, the GRC-based APQM module will be available in the STRS Application Repository, providing other Ka-band missions an opportunity to reuse this flight-demonstrated approach.

The APQM is a necessary feature of a Ka-band radio to allow closed-loop antenna pointing. As noted above, the design of the APQM should take into account the spectral characteristics of the signal that is being tracked.

VII. TESTING NEW WAVEFORMS

A high-rate bandwidth-efficient waveform experiment has been developed for the Harris SDR. The new waveform employs bandwidth-efficient techniques such as Gaussian Minimum Shift Keying (GMSK) and pulse-shape filtered M-order phase-shift keying (M-PSK) and M-order quadrature amplitude modulation (M-QAM), and modern coding schemes such as Low Density Parity Check (LDPC) codes. The objective of this waveform is to maximize the data-rate over the 225 MHz TDRSS Ka-band service while improving the spectral efficiency. Higher order modulations allow the transfer of larger amounts of data in a shorter time, which minimize mission communication cost and power

requirements. The bandwidth-efficient waveform will support higher data flow using the same or less spectrum as the launch waveform (Figure 8). The waveform is designed to be aligned with future upgrades to NASA’s Space Network (Space Network Ground Segment Sustainment Project - SGSS), which includes 8-PSK modulation and LDPC decoding. The waveform also supports high-order modulations, such as 16-APSK and 16-QAM, which will be evaluated for performance and potential use for band-limited channels.

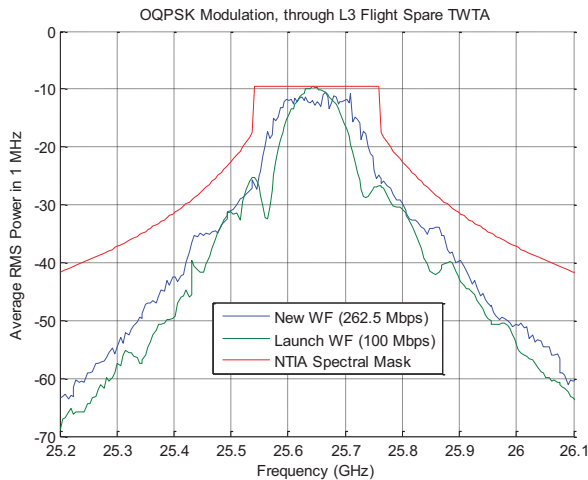

Fig. 8: The new bandwidth-efficient waveform uses approximately the same spectrum as the launch waveform but is capable of more than double the data throughput using higher order modulation.

Higher-order modulation schemes are more sensitive to channel impairments, such as band-limiting filters, phase noise, gain flatness / phase distortion and nonlinear amplification. This experiment will evaluate the performance and demonstrate the ability of space-qualified SDRs to compensate for channel impairments. Digital pre-distortion algorithms have been incorporated into the waveform to compensate for the nonlinear distortions of the amplifier. A combination of pre-filtering on the transmitter and channel equalization on the ground receiver will be necessary to maximize performance.

On-orbit testing with SQPSK modulation has successfully demonstrated data-rates up to 300 Mbps, which is the highest rate the current TDRSS Space Network receivers can support operationally. Additional on-orbit testing is planned to evaluate higher rates using prototype ground modems at the NASA White Sands Complex.

VIII. MODEL KA-BAND USER SPACECRAFT

The Interagency Operations Advisory Group (IOAG) completed a 26-GHz Ka-band study in June 2013 (Ref 9). The purpose of the study was to determine the viability of direct-to-ground Ka-band communication links from low earth orbit. The report focused on the user mission terminal side and less on the infrastructure requirements. The model 26 GHz communications system is shown in Figure 9, with blocks circled that can be evaluated easily using SCA_N Testbed. Although the testbed is designed for space-to-space Ka-band links, several challenges identified in the report are also relevant for space links – specifically:

- Adaptive coding and modulation schemes
- On-board steerable antennas and pointing
- High-rate data interfaces and on-board storage

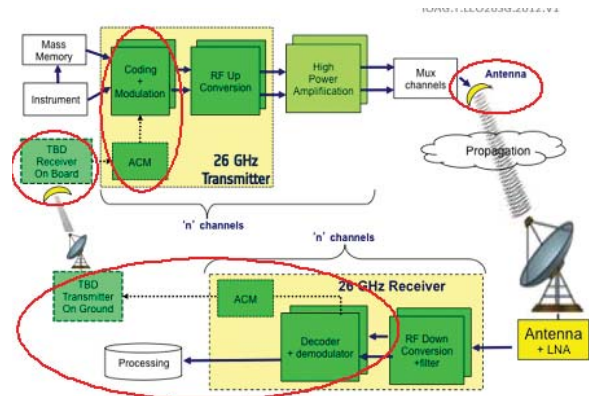

Figure 2-2: Generic functions of the 26 GHz communication system.

Fig. 9: A model 26 GHz communications system. The figure was originally published in the IOAG 26 GHz study in Ref 9. The items circled in red are potential areas for study with SCA_N Testbed.

The SCA_N Testbed Ka-band research presently is focused on coding and modulation schemes, which are applicable across the space and ground domains. Some of the ISS truss flexure investigation results (i.e., unstable platforms) and related APQM and antenna pointing algorithms will help to answer questions related to the user terminal on-board antenna pointing. Finally, SCA_N Testbed implements a high-rate SpaceWire link between the Harris SDR and the avionics processor. Although specific experiments have not been identified to address storage, a parallel or multi-threaded method for storage of high-rate data would be an excellent potential area for study.

The IOAG report calls for adaptive data rate, coding, and modulation techniques that would make use of available link margin as it changes over time (Figure 10). Specifically, for the ground case, the report indicates that the link could change by over 15 dB during a pass. If the waveform does not adapt to the

changing link, a significant amount of link margin is available during the middle of a RF event. Although SCaN Testbed does not see a 15 dB variation with TDRSS, the Ka-band antenna can be mis-pointed in order to simulate such a change and allow for the development of direct-to-ground waveforms.

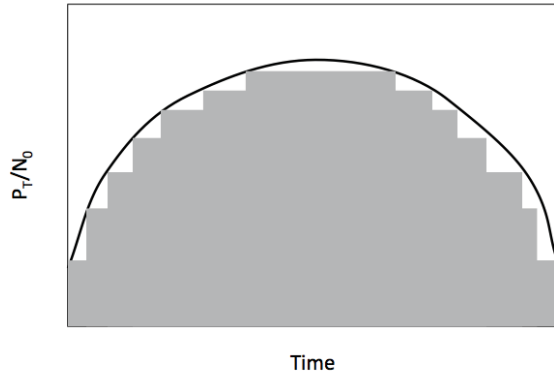

Fig. 10: An example of adaptive waveform techniques using the available link margin. The figure was originally published in the IOAG 26 GHz study in Ref 9.

IX. CONCLUSIONS AND FUTURE WORK

This paper has considered NASA's SCaN Testbed and its approach to testing new user-side technologies for Ka-band space communication in low earth orbit. The testbed has the capability to generate high-rate data sources and evaluate open- and closed-loop antenna pointing algorithms. It is also an excellent platform for the study of new waveform modulation and coding techniques due to the reprogrammable capabilities of the Harris SDR.

Future work is planned to study variable/adaptive coding and modulation advancements for SCaN Ka-band systems to further enhance their capabilities, performance, and reliability. Existing standards, such as DVB-S2, will be considered to leverage working terrestrial protocols and adapt to NASA's unique Ka-band mission architectures. Upon the adaptive techniques, automation and eventually cognitive systems will be built, responding to changing environments, data flow, and spacecraft resource considerations. This research is planned to continue beyond the life of SCaN Testbed.

X. REFERENCES

- [1] – Budinger, J., G. Fujikawa, R. Kunath, N. Nguyen, et al., “Direct Data Distribution from Low-Earth Orbit”, IEEE International Conference on Communications (ICC) 1997 Towards the Knowledge Millennium, Montreal, Volume 2, pp 662 - 673.
- [2] – McCarthy, K., F. Stocklin, B. Geldzahler, D. Friedman, and P. Celeste, “NASA's Evolution to Ka-Band Space Communications for Near-Earth Spacecraft”, AIAA SpaceOps 2010 Conference, April 2010, Huntsville, Alabama.
- [3] – “Space Technology Roadmaps – Communication and Navigation Systems”, TA05, Available at <http://www.nasa.gov/offices/oct/home/roadmaps/>.
- [4] – Skytland, Nick, “What is NASA doing with Big Data today?”, Open NASA, Available at <http://open.nasa.gov/blog/2012/10/04/what-is-nasa-doing-with-big-data-today/>.
- [5] – Welch, B., “SCaN Testbed RF Hardware Interface Description Document,” NASA document GRC-CONN-DOC-1024, 2014.
- [6] – Welch, B., “SCaN Testbed Antenna Pointing System Open-Loop & Closed-Loop Tracking Test Report,” NASA document GRC-CONN-RPT-0836, 2014.
- [7] – Schrage, Dean, “ISS Truss Flexure Measurement Applying Ka-Band Closed-Loop Tracking”, 3rd Annual ISS Research and Development Conference, June 17-19, 2014, Chicago.
- [8] – Downey, J., R. Reinhart, T. Kacpura, “Pre-flight Testing and Performance of a Ka-band Software Defined Radio”, 30th AIAA International Communications Satellite Systems; 24-27 Sep. 2012; Ottawa, Ontario; Canada.
- [9] – “Low Earth Orbit (LEO) 26 GHz K-band Study Group”, Interagency Operations Advisory Group, IOAG.T.LEO26SG.2012.V1, Available at: <https://www.ioag.org/Public%20Documents/Forms/AllItems.aspx>