



A Fully Non-Metallic Gas Turbine Engine Enabled by Additive Manufacturing

Joseph E. Grady
NASA Glenn Research Center

Prepared for the JANNAF Technical Interchange Meeting
on Additive Manufacturing for Propulsion Applications

Huntsville, Alabama
September 3-5, 2014

Project Objectives

Conduct the first comprehensive evaluation of emerging materials and manufacturing technologies that will enable fully non-metallic gas turbine engines.

- Assess the feasibility of using additive manufacturing technologies to fabricate gas turbine engine components from polymer and ceramic matrix composites.
 - Fabricate and test prototype components in engine operating conditions
- Conduct engine system studies to estimate the benefits of a fully non-metallic gas turbine engine design in terms of reduced emissions, fuel burn and cost

Project Team

- **RP+M** (Additive Manufacturing): Tom Santelle, Clark Patterson



- **Honeywell Aerospace** (Engine Systems & Components)

- Mike Vinup, Natalie Wali, Don Weir



- **Ohio Aerospace Institute** (Ceramic Processing): Mrityunjay Singh



- **NASA Glenn Research Center**

- Engine Systems Analysis: Bill Haller, Jeff Berton, Sydney Schnulo, Mike Tong, Scott Jones, Bob Plencner
- Materials Characterization: Kathy Chuang, Mike Halbig, Eugene Shin, Bob Draper
- Component Rig Testing: Phil Poinatte, Doug Thurman

- **NASA Langley Research Center** (Acoustic testing): Mike Jones



- **NASA Aeronautics Academy Students:**

- Chao Lao (Cal Poly), Jeremy Mehl (Princeton), Morgan Rhein (Purdue)

Project Status

- Fabricated prototype engine components using additive manufacturing with Polymer Matrix Composites
 - Compressor Inlet Guide Vane
 - Advanced Acoustic Liner Concept
- Initiated rig testing of components
- Demonstrated additive manufacturing of ceramics
- Estimated the potential reduction of engine emissions and fuel burn due to these new materials and fabrication technologies

Identified High-Payoff Engine Components for Advanced Materials and Manufacturing

Business Jet size
turbofan engine

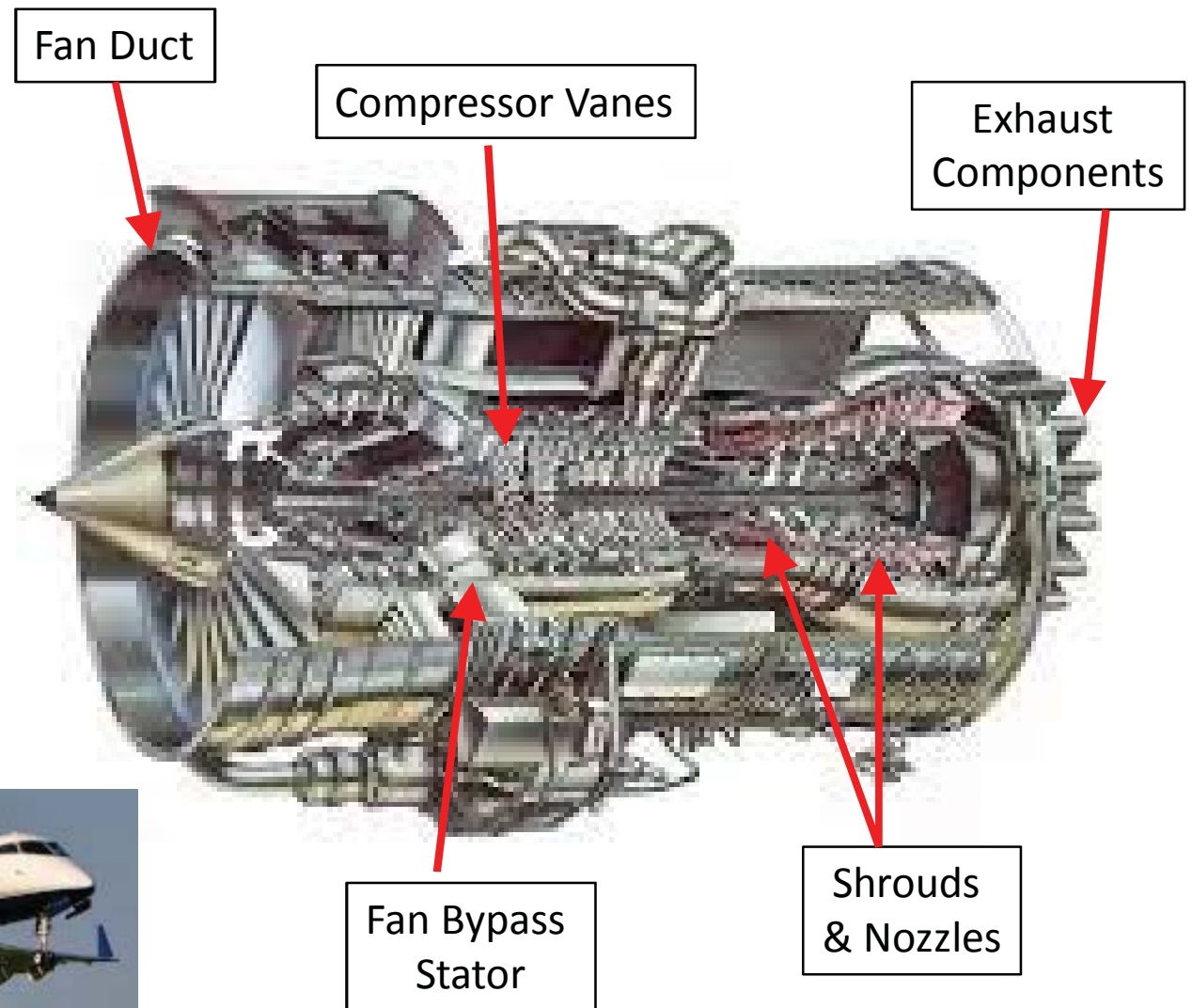

Fabricated Compressor Inlet Guide Vanes with High Temperature Polymer Matrix Composites

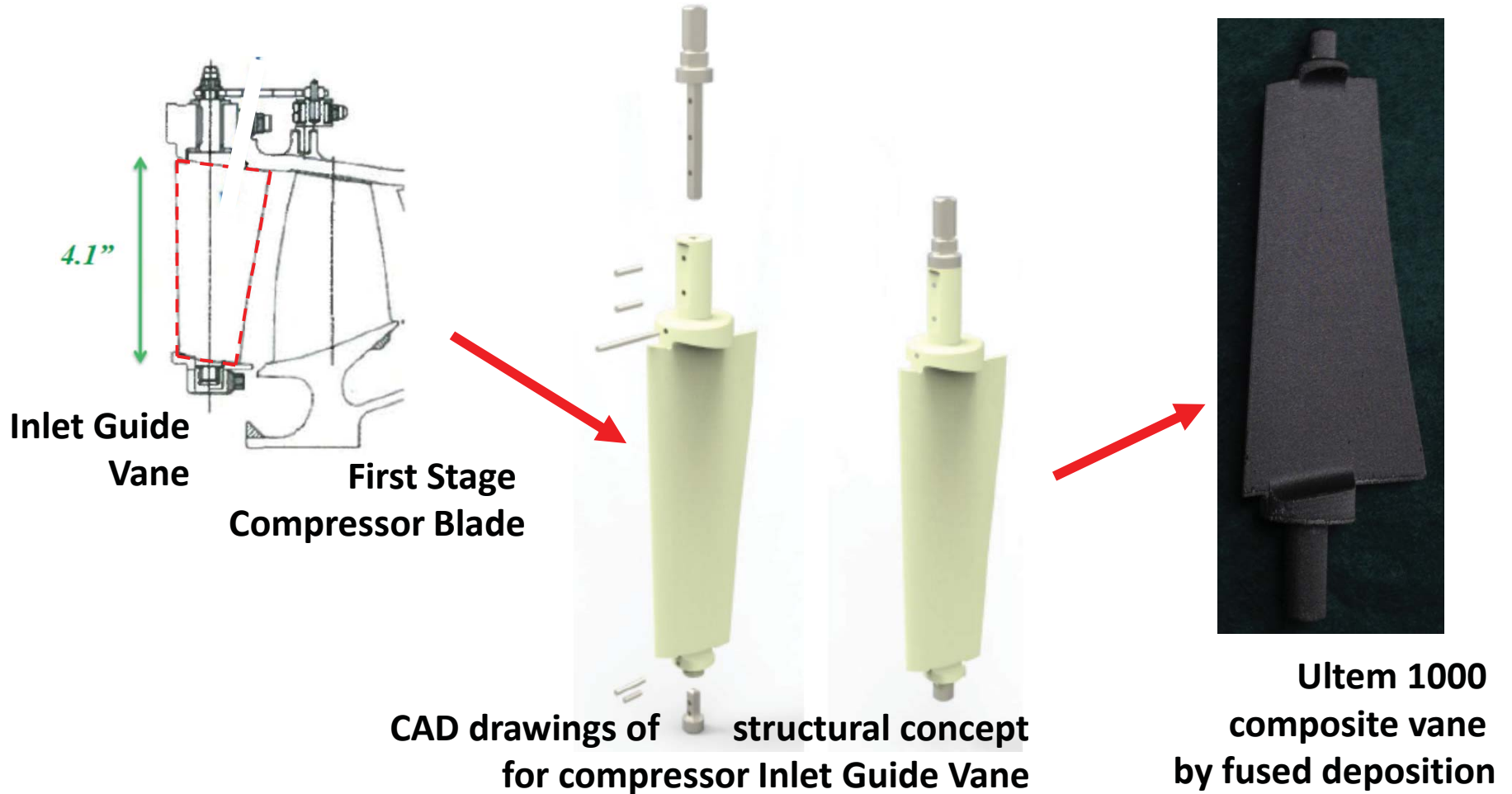

Additive manufacturing of PMC compressor inlet guide vane would reduce engine weight, fuel burn, emissions, part count and component fabrication cost

Material property characterization is in progress

- Tensile, compression, shear & flexure properties were obtained using 3-D optical deformation measurement
- Good correspondence between measured and calculated values for tensile modulus

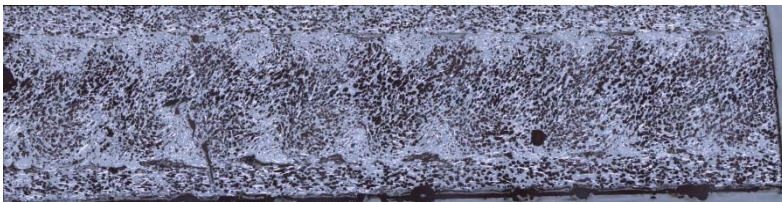

Vertical cross section of Ultem 1000/chopped fibers

- Fiber reinforcement (PMC) is needed for structural components
- Higher temperature polyimide needed for 400°F IGV application

ULTEM9085 Tensile Stress v. Strain at 135 °C

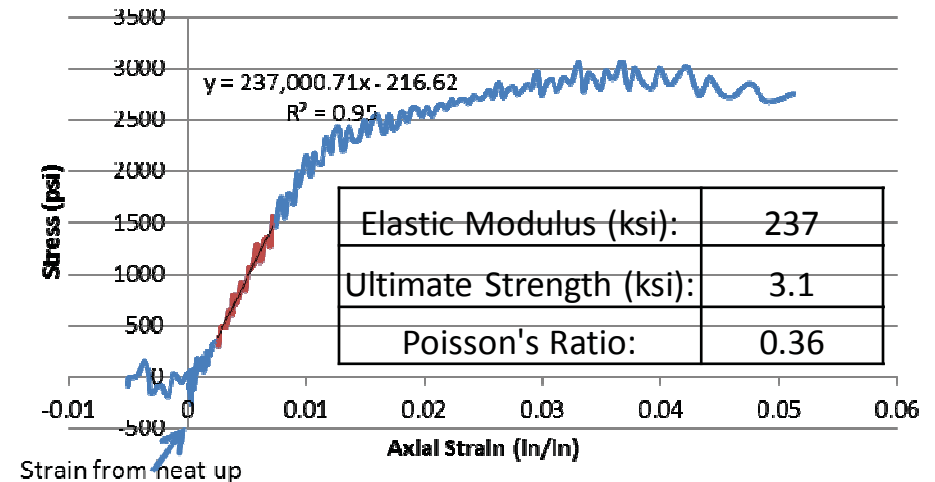

- ~ 5% porosity for Ultem 9085 neat resin
- ~30% porosity for Ultem 1000/Chopped fiber

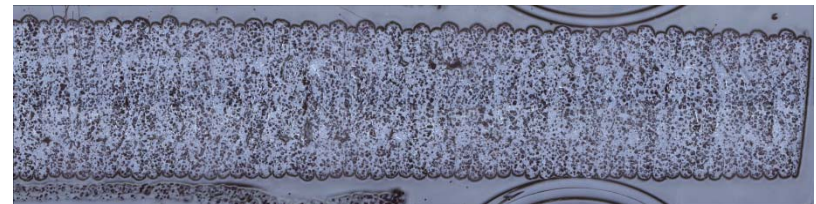

Horizontal cross section of Ultem 1000/chopped fiber

Process optimization is needed for engine applications of Polymer Composites

Initial FDM composites show higher porosity (30%) than neat material (5%) - need to reduce porosity for structural components

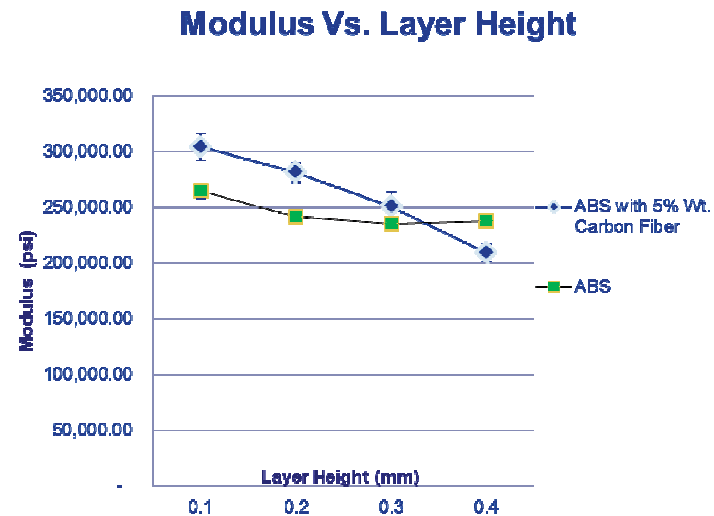
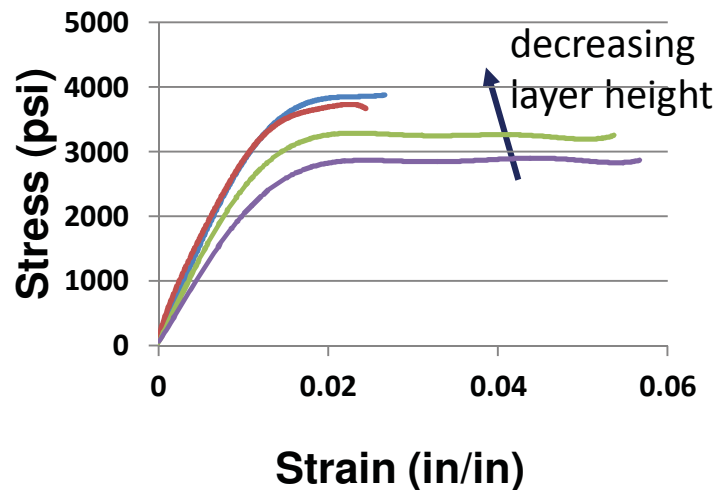

- Experience with ABS composites shows strength and modulus can be increased by reducing layer thickness during FDM process
- Optimization of processing temperature & speed will also improve properties

NASA micromechanical analysis code (MAC/GMC) calculates effect of process parameters on material properties

Tensile Modulus vs. Void Percentage at Varying Raster Angles

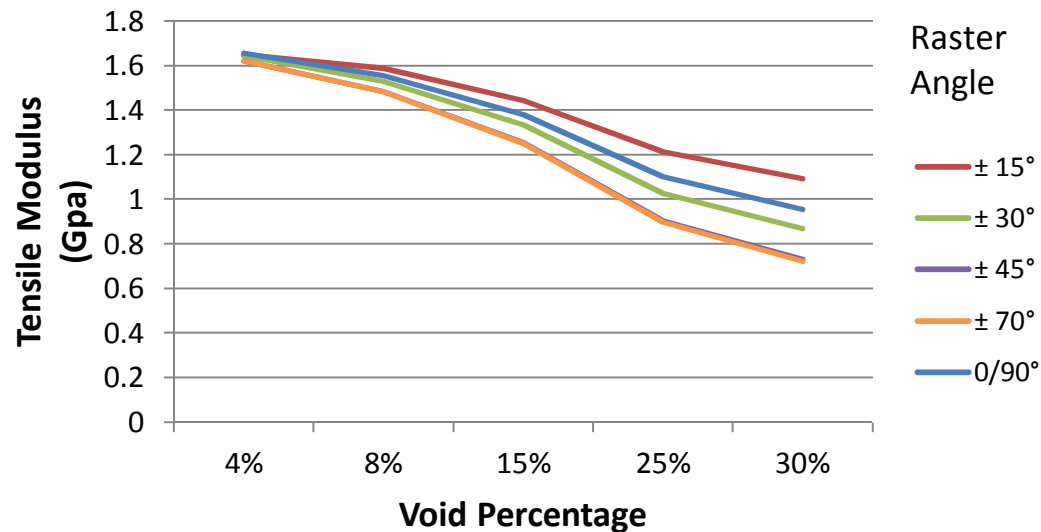

| Raster Angle | Tensile Modulus (ksi) |
|-------------------|-----------------------|
| 0°/90° | 244 |
| ± 15° | 242 |
| ± 30° | 242 |
| ± 45° | 238 |
| ± 70° | 238 |
| Injection Molding | 257 |

Ultem 9085. Simulated conditions are 0.2 in/min at 135C

- Ultem 9085 shows anisotropic behavior
- Increasing raster angle decreases tensile strength & stiffness

Structural integrity of inlet guide vane was evaluated under aerodynamic loading

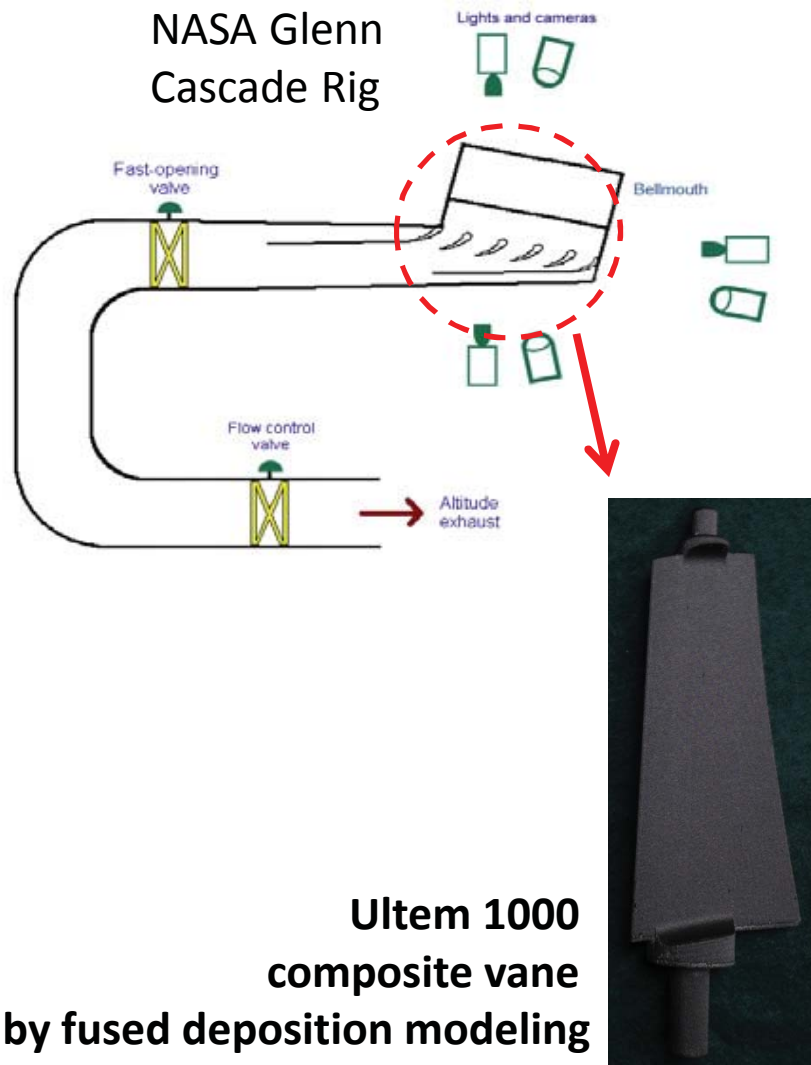

Vane Configuration in Cascade Rig

Other FDM composites being evaluated:

| Matrix (+C fiber) | Application temp (°F) |
|-------------------|-----------------------|
| Ultem 1000 | 350 |
| Ultem 9085 | 275 |
| ABS | 200 |

Validation of structural analysis is underway

- Measured displacements & strain under wind tunnel load
 - ARAMIS digital image correlation
 - Strain gages
- Comparison with Structural analysis is in progress
 - ANSYS finite element analysis
- Need to relate test environment to engine conditions
 - Room temperature test
 - Scale aero load to engine conditions



Test rig with Digital Image Correlation system for measurement of vane deformation

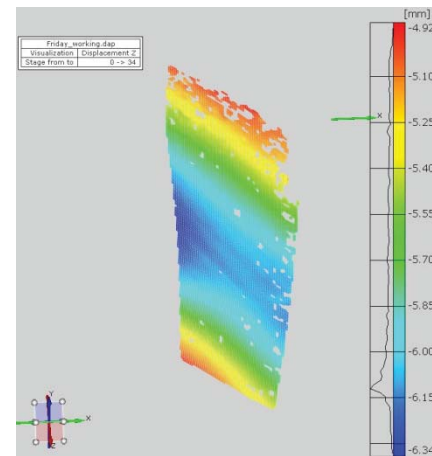

Digital Image Correlation Measurements

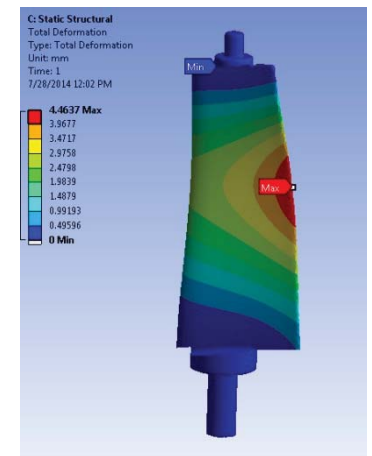

Finite Element Analysis

Fused Deposition Modeling Simplifies Acoustic Liner Fabrication

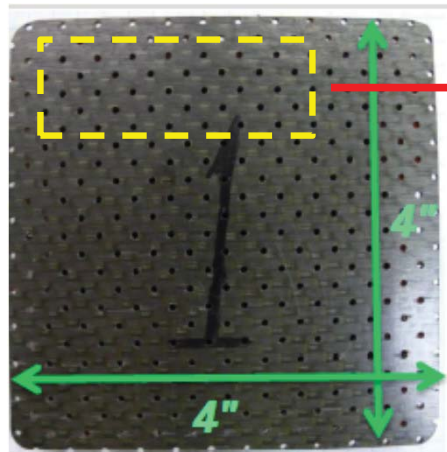

Perforated Facesheet

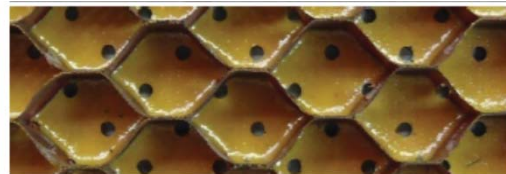

Bonded Structure

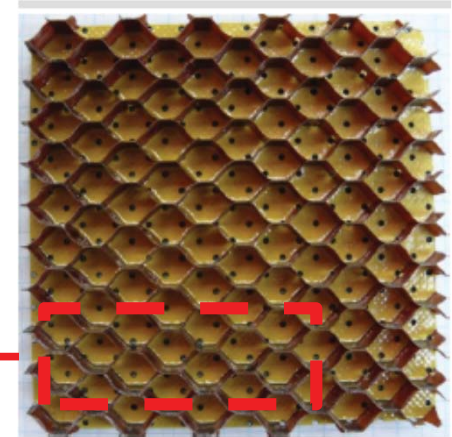

Honeycomb

Current manufacturing approach requires metal forming, bonding and drilling

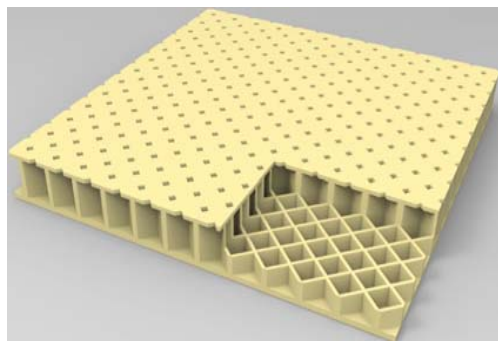

integral facesheet/honeycomb structure is fabricated in one step using Fused Deposition Modeling

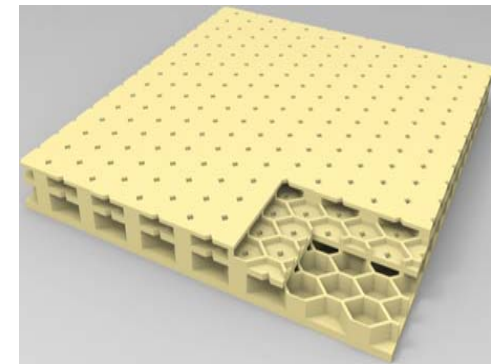

Optimized acoustic absorber would reduce engine fan noise

Fused Deposition Modeling enables fabrication of advanced acoustic liner concepts

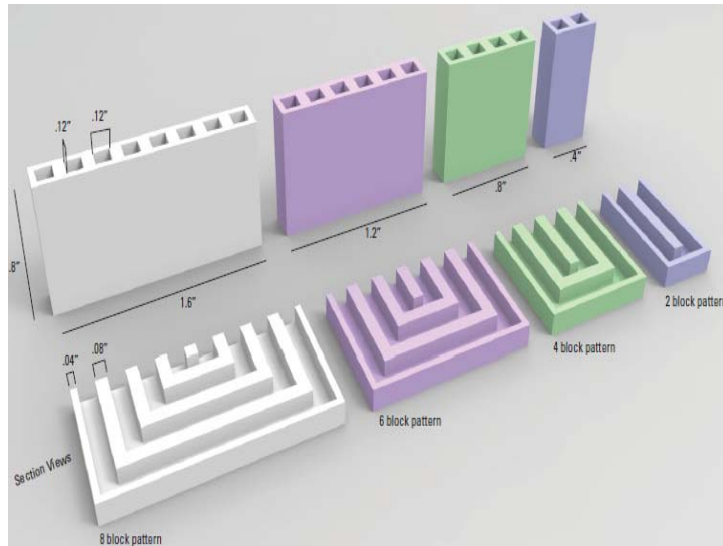

acoustically-tuned passages
provide broadband attenuation
of engine noise

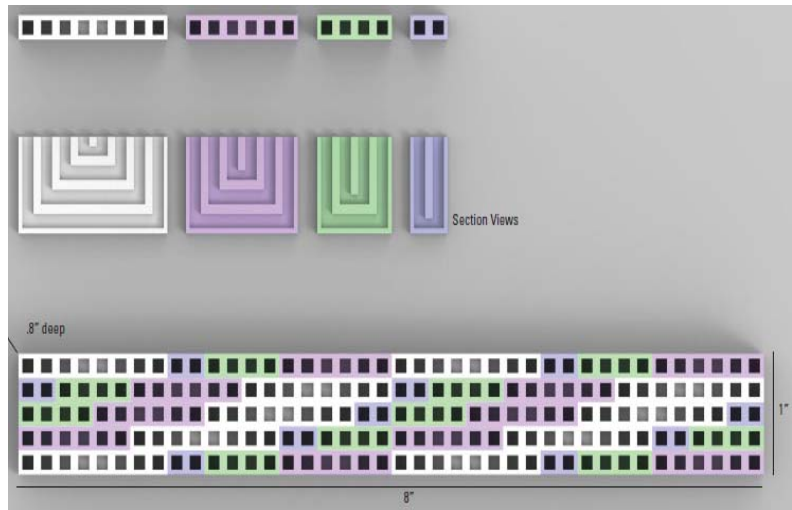

Fabrication of New “Passive-Destructive” Acoustic Liner Concept
is underway for rig testing at NASA Langley Research Center

Noise attenuation of advanced acoustic liner will be evaluated in NASA LaRC Grazing Flow Impedance Tube

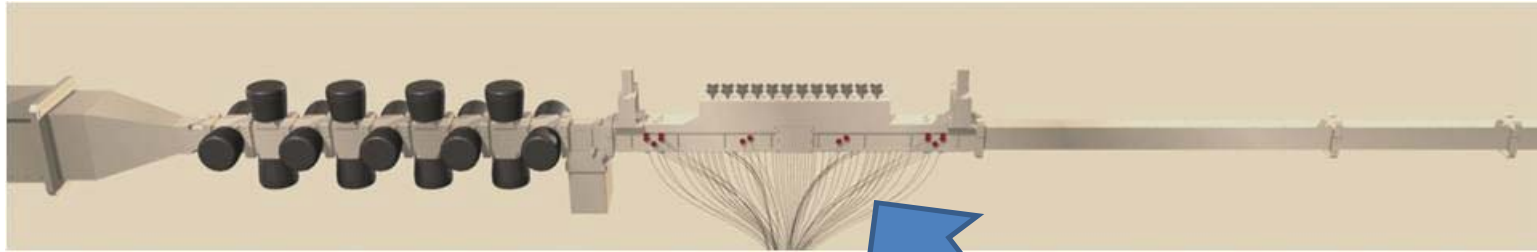

LaRC Grazing Flow Impedance Tube test rig



16x2 inch acoustic test article

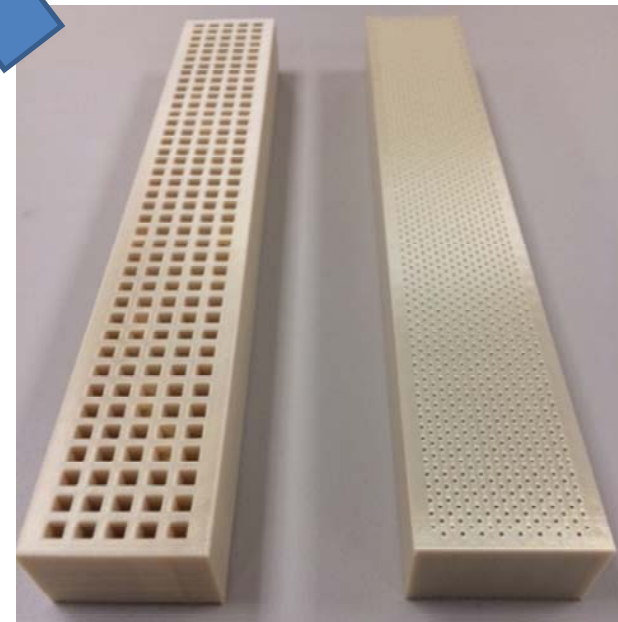

Baseline (right) and advanced liner test articles

Fabricated ceramics using a modified Binder Jet process

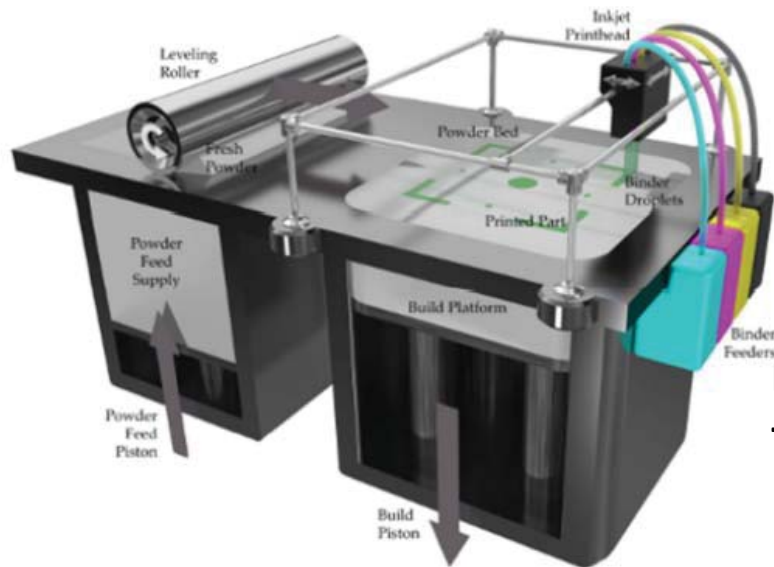

Binder Jet process was adapted for SiC fabrication

Binder Jet process for ceramic-based materials

- Fabricated SiC samples for processing and characterization
- Identified candidate engine components for manufacturing trials
- Optimization of processing approach is needed to reduce porosity

SiC Coupons after 1000°C pyrolysis

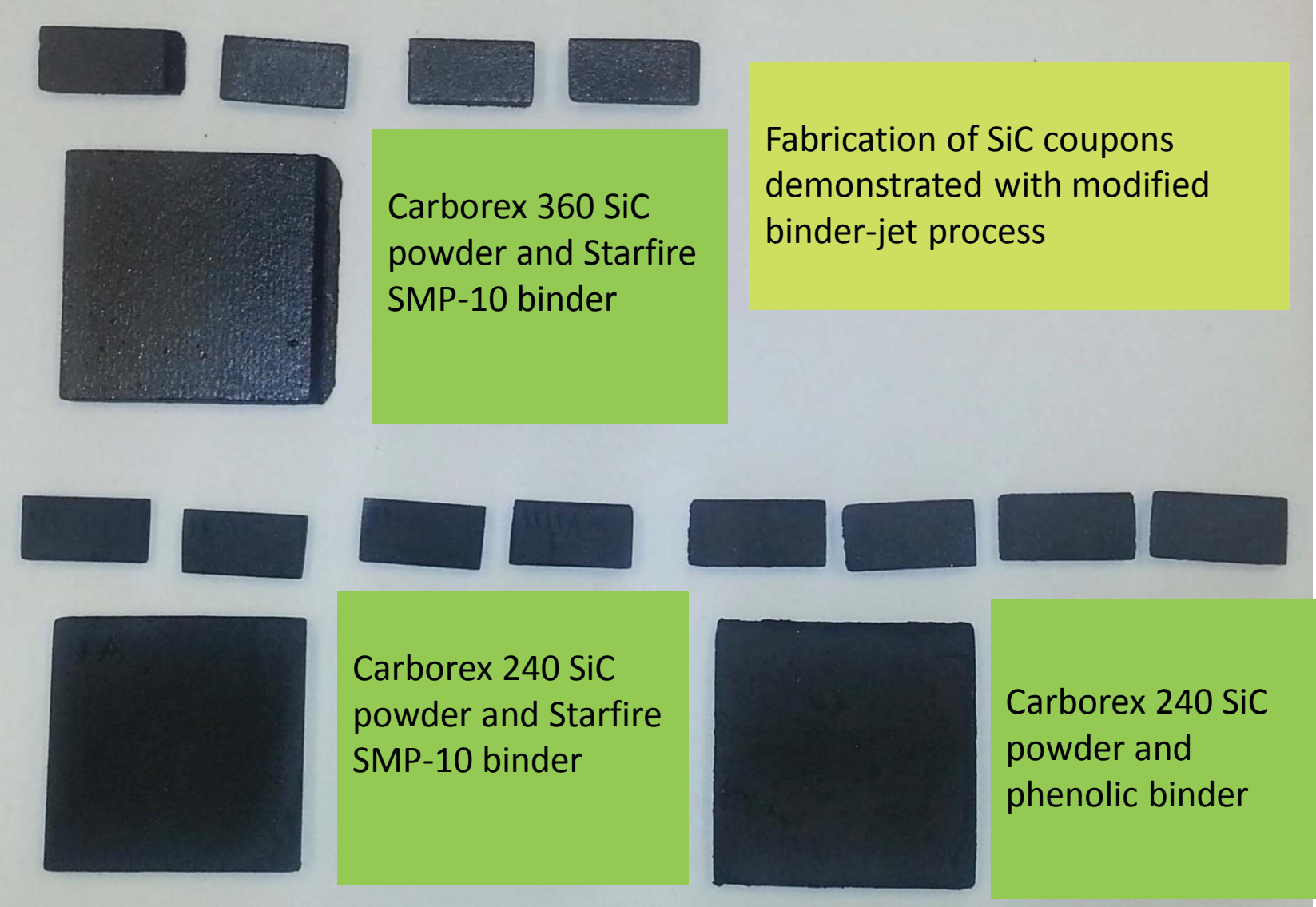

Engine systems analysis process and modeling tools established to assess impact of advanced materials

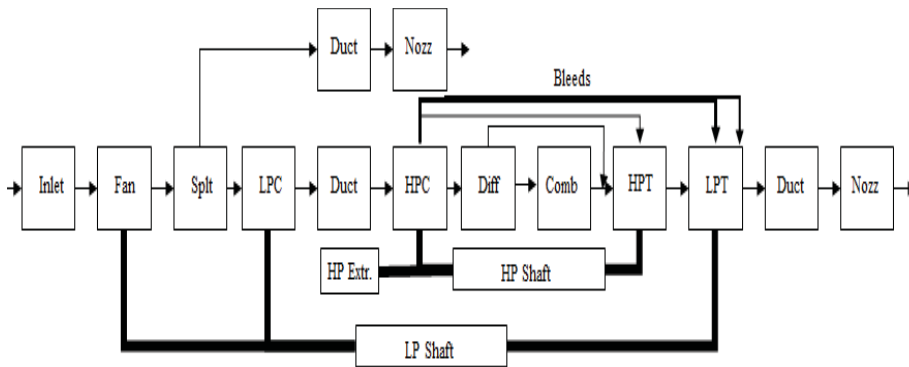

Model Propulsion system performance impacts (using NPSS)

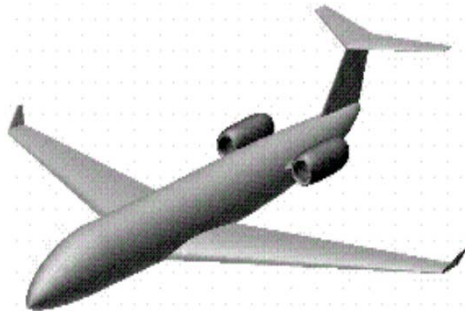

Quantify fuel burn impacts on aircraft (using FLOPS)

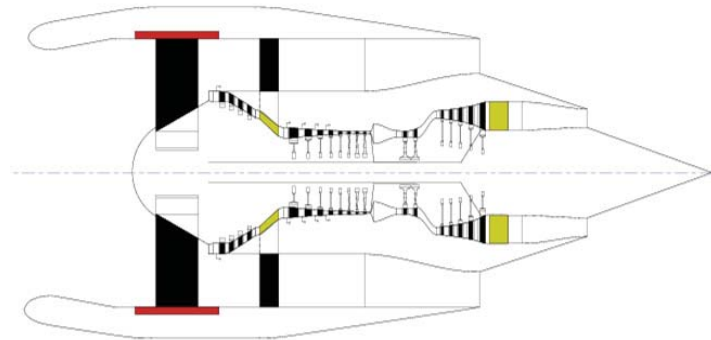

Model Propulsion system weight impacts (using WATE)

Advanced materials & manufacturing technologies would reduce engine weight by 15%

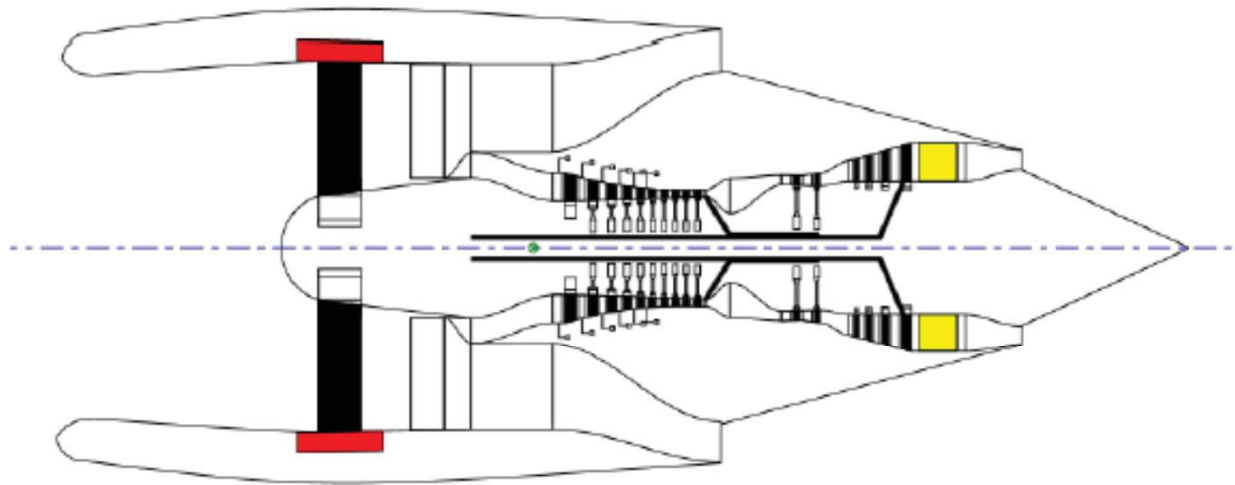

| Weights (lbs) | | Dimensions (inches) | |
|-------------------|------|-----------------------|-------|
| Bare Engine Wt. | 2075 | Engine Length | 91.5 |
| Accessories Wt. | 635 | Engine Pod C. G. | 28.3 |
| Engine Wt. | 2710 | Fan Diameter | 48.1 |
| Inlet/Nacelle Wt. | 505 | Nacelle Max. Diameter | 63.1 |
| Total Pod Wt. | 3215 | Total Pod Length | 125.5 |

~14.5% Reduction
vs. Baseline

Advanced materials & manufacturing technologies would reduce aircraft fuel burn 5%

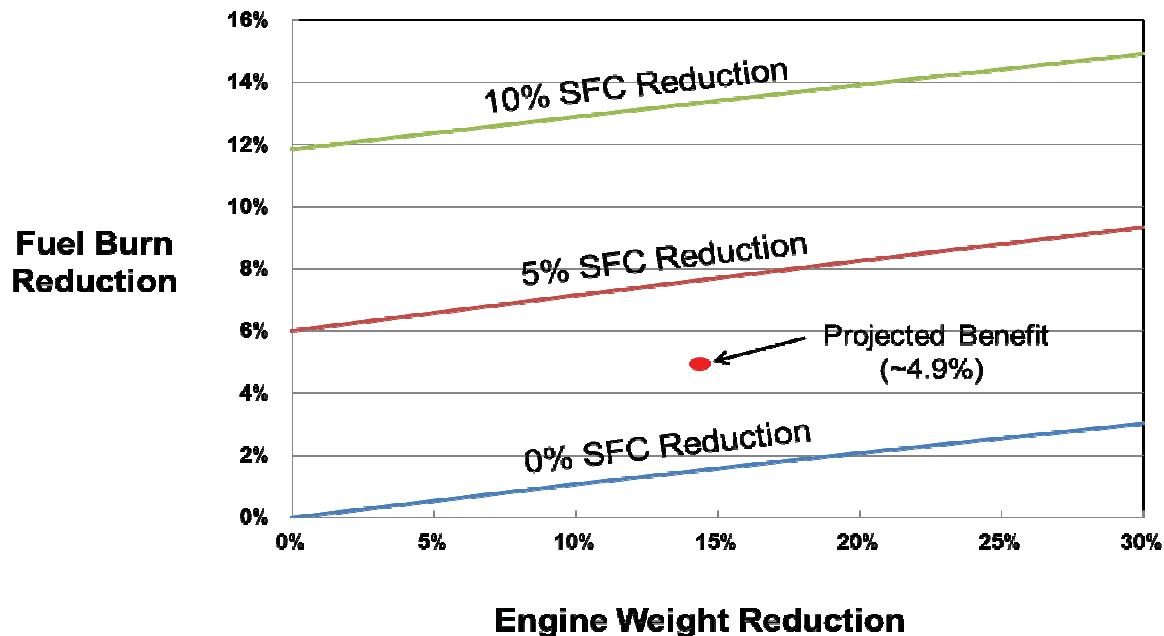

Fuel Burn Sensitivities for baseline Regional Jet show **4.9% reduction in aircraft fuel burn** and a corresponding **8.3% reduction in NOx emissions** due to the use of advanced materials and manufacturing processes

Next Steps

- Optimize FDM process to reduce porosity in Polymer Matrix Composites
- Complete Design-of-Experiments investigation to identify optimal Binder Jet process parameters for ceramic fabrication
- Characterize material properties (PMC, Ceramic and CMC)
- Complete component rig tests & analysis
- Based on these results, determine the maturity (Technology Readiness Level) of these technologies for turbine engine applications

Acknowledgement

This project is funded by the NASA Aeronautics Research Institute as part of the Aeronautics Team Seedling Program