



Evolvable Cryogenics (eCryo) Project Technology Workshop with Industry

Engineering Development Unit (EDU) Workshop

Thermal Venting System (TVS)

Joe Zoeckler

Thermodynamic Vent System



- Removes energy from a cryogenic propellant tank to prevent over-pressurization
- Avoids direct venting which could result in large propellant losses in a microgravity environment
- Typically has (3) elements: a cooling circuit with an expansion orifice, a heat exchanger, and a means to circulate/mix tank contents

EDU TVS System

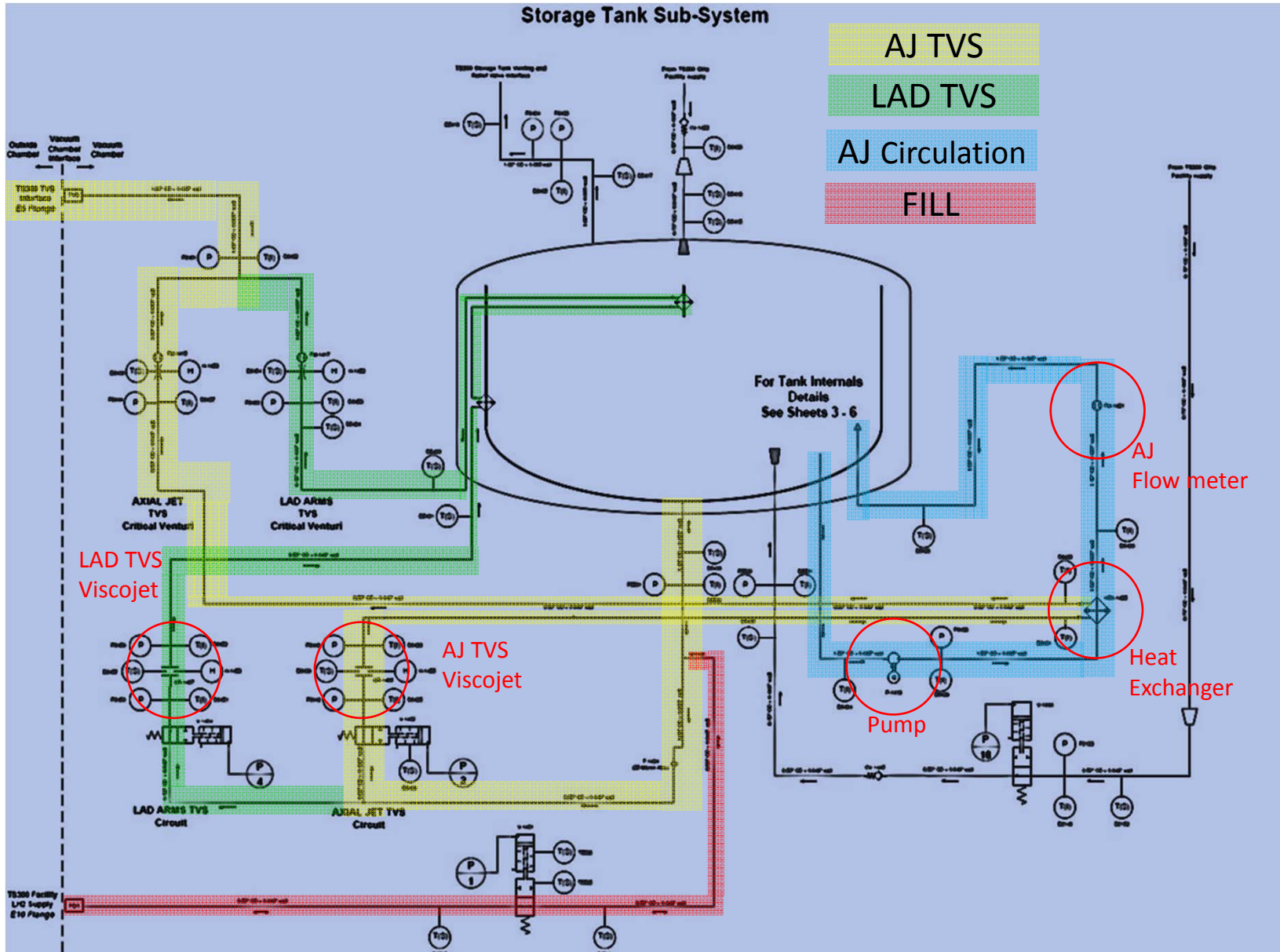

Tank Pressure Rise



- Heat absorbed by the tank contents will result in an increase in pressure
- “Homogeneous” pressure rise: vapor and liquid temperatures are uniform and the pressure rise follows the saturation curve: in this case heat must be removed from the tank to lower the pressure
- “Non-homogeneous” pressure rise: ullage temperature rises faster than the liquid, resulting in faster overall rate of pressure rise and super-saturation conditions in ullage gas: in this case, mixing alone can lower the pressure until the propellant partial pressure in the ullage matches the bulk liquid saturation pressure. Further reduction in pressure requires heat removal. Note that the mixing equipment itself will typically will add some heat to the system.

EDU Self-Pressurization Behavior



Slope after first hour is identical to homogenous model:

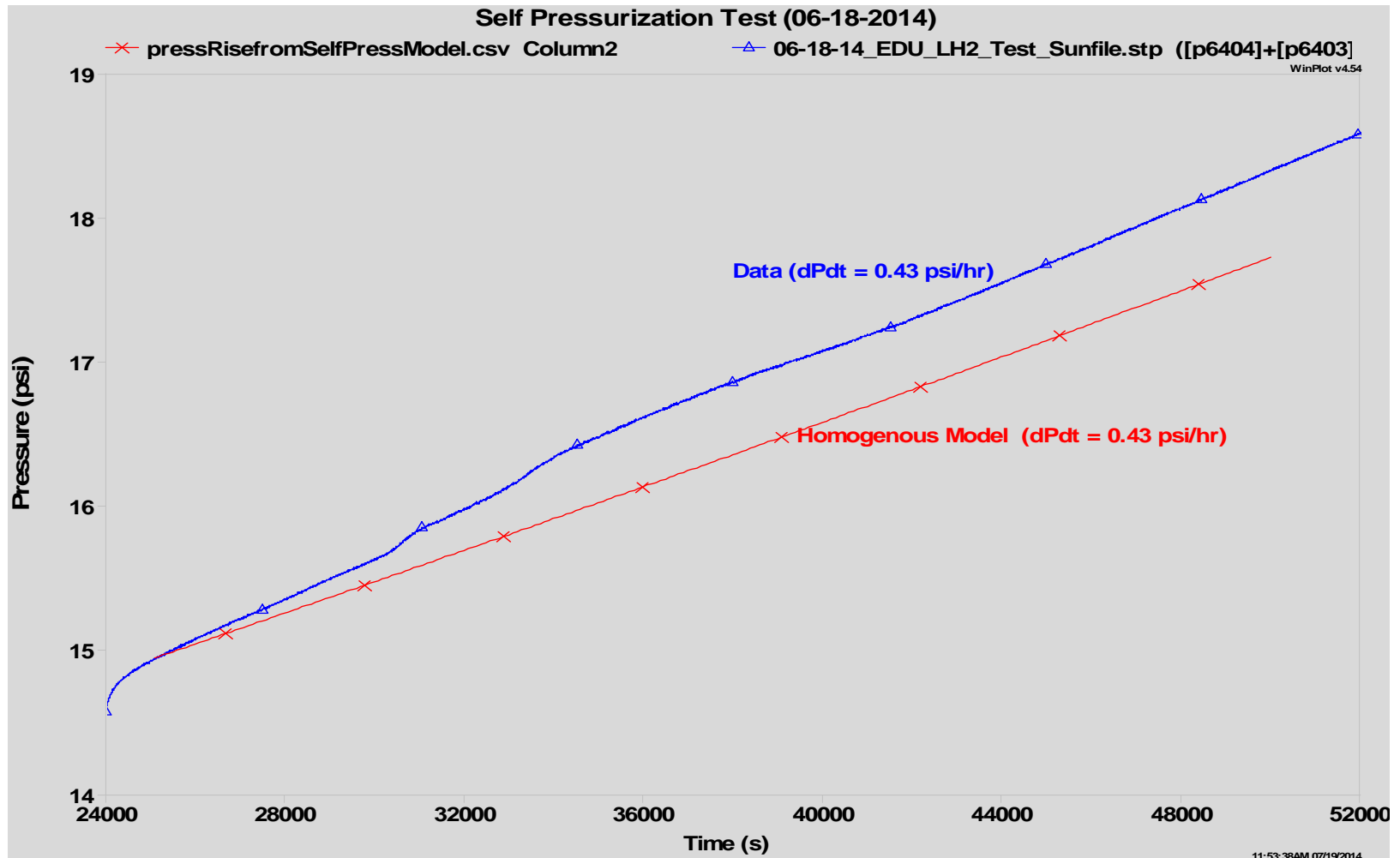



Tank Pressure Reduction

- Non-homogenous pressure rise occurs when a thermal stratification gradient is established at the liquid/gas interface or when warm pressurant gas is introduced into the ullage and/or when the ullage gas is heated above the saturation temperature of the liquid.
- Circulation/disturbance of the liquid in the vicinity of the liquid/gas boundary or direct mixing of gas/liquid will remove energy from the gas and redistribute it in the liquid, resulting in a pressure reduction.
- Mixing alone cannot lower the partial pressure of the vapor in the ullage below the bulk liquid saturation pressure. Further pressure reduction can be achieved by utilizing evaporative cooling produced by expansion of liquid propellant.

Axial jet mixing – hydrogen vapor only in ullage



Pump operation with hydrogen only in ullage generally produced little or no reduction in pressure. This is due to the nearly homogeneous pressure rise behavior, i.e., the tank pressure is closely following the saturation curve.

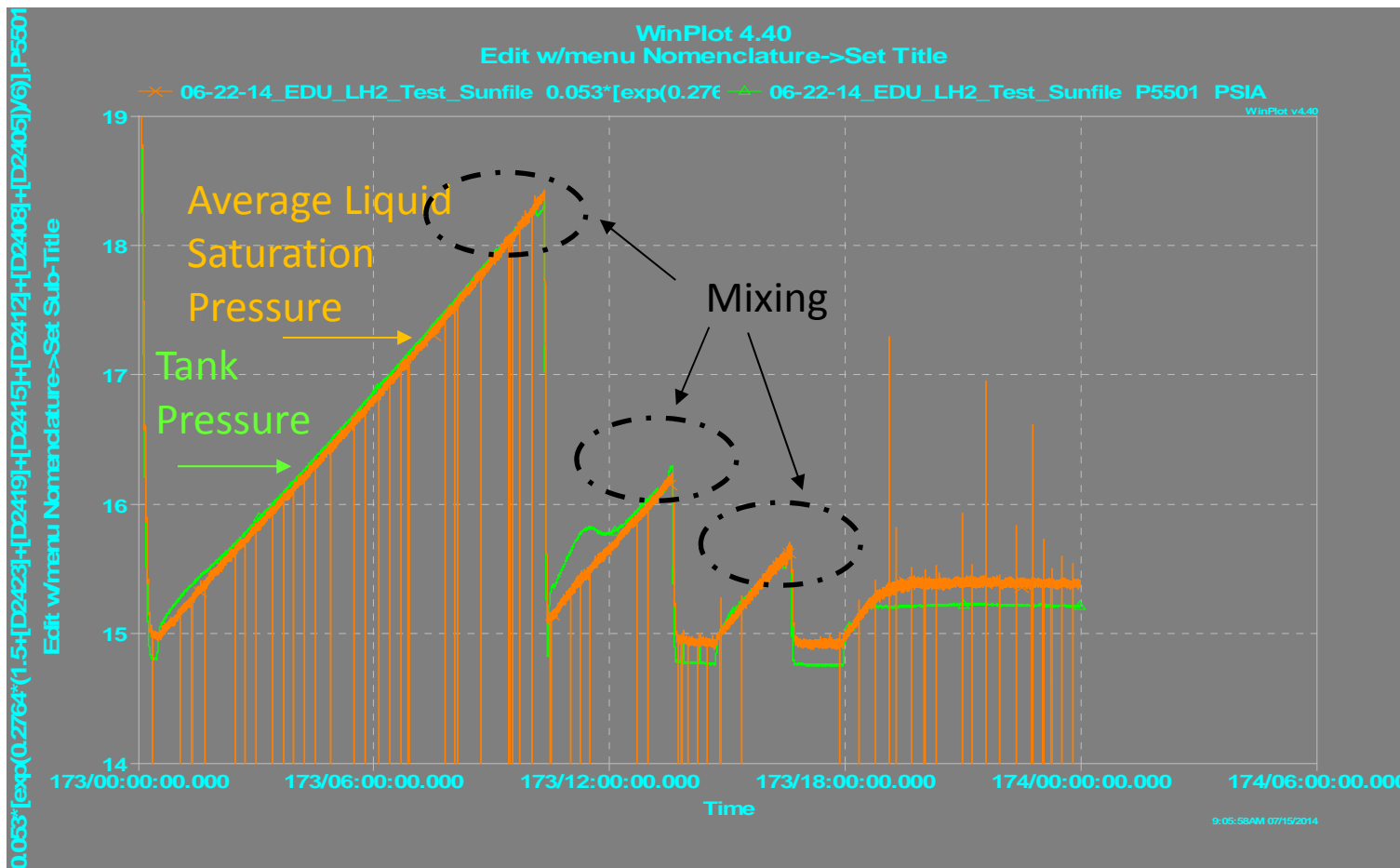



Axial Jet Mixing Tests after Ghe Pressurization

Pump operation with helium in ullage did produce pressure reduction, tending to return pressure to the initial helium pressurization level. Further pressure reduction requires cooling.

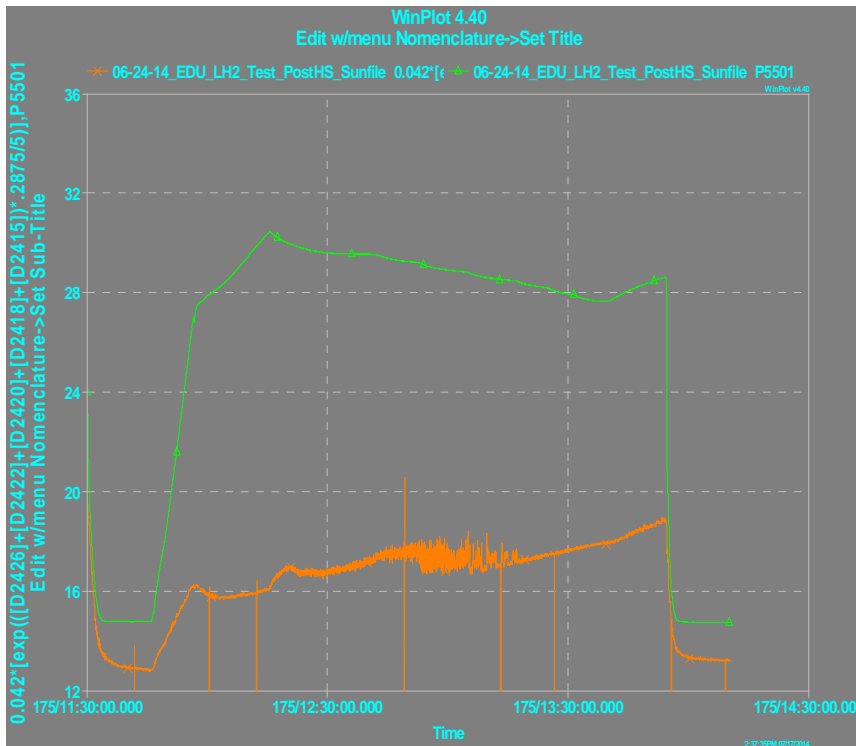

40% fill level, helium pressurization using fwd diffuser

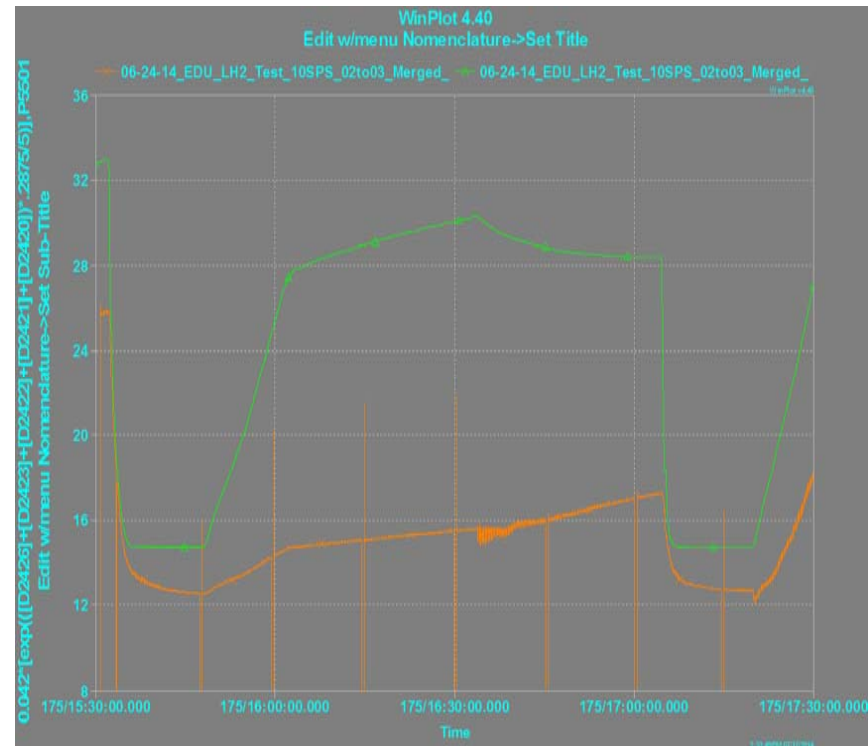

22% fill level, helium pressurization using fwd diffuser

TVS Nominal Design



- Axial jet Viscojet: 2700 Lohms
- 3 to 4 lbm/hr coolant at 20 to 30 psia tank pressure; 150 to 225 watts of cooling capacity
- 7 to 25 gpm centrifugal pump
- LADS cooling Viscojet: 40,400 Lohms
- 0.2 to 0.27 lbm/hr coolant; 10 to 15 watts

TVS Operation



- The simplest operation monitors the pressure and starts mixing and cooling once the pressure reaches an upper limit. It is difficult to say *a priori* whether mixing alone will lower the pressure.
- Mixing can be initiated first, but even if this results in an initial pressure reduction, it is difficult to establish a control point for cooling start up.
- In this configuration, the mixing circuit was always open to the tank liquid volume and flooded. Start and stop of the axial jet was therefore “quick”.
- Ideally want cooling on demand once pump starts

TVS Cooling



- In this configuration, the cooling shutoff valve, the expansion viscojet, and the heat exchanger were all located outside of the tank. The axial jet side of the heat exchanger was flooded, so the heat exchanger itself was cold. However, the remainder of the cooling circuit was dry and at a higher temperature than the tank contents when off.
- The thermal mass of the circuit was large compared to the available flow rate during the cool-down transient. In addition, the heat leak from the surroundings was high enough to raise the circuit temperatures almost back to the initial levels for subsequent cycles, meaning that the chill down period would be about the same for each cycle.

TVS Cooling First Attempt



- The initial checkout of the axial jet cooling circuit was done by opening the valve and allowing saturated fluid to flow to the viscojet. The fluid vaporized upstream of the viscojet and therefore the flow rate was somewhat less than the nominal design flow rate. This reduced flow rate further extended the cool-down time.
- Attempts to run the axial jet pump during this checkout resulted in discovery that the axial jet flowmeter was not working. The pump motor also was thought to have malfunctioned, although it turned out that this was not the case. There was, however, a problem with the pump controller which resulted confusion as to what the motor was doing until the controller was replaced several days later.

AJ TVS Cooldown Day 2

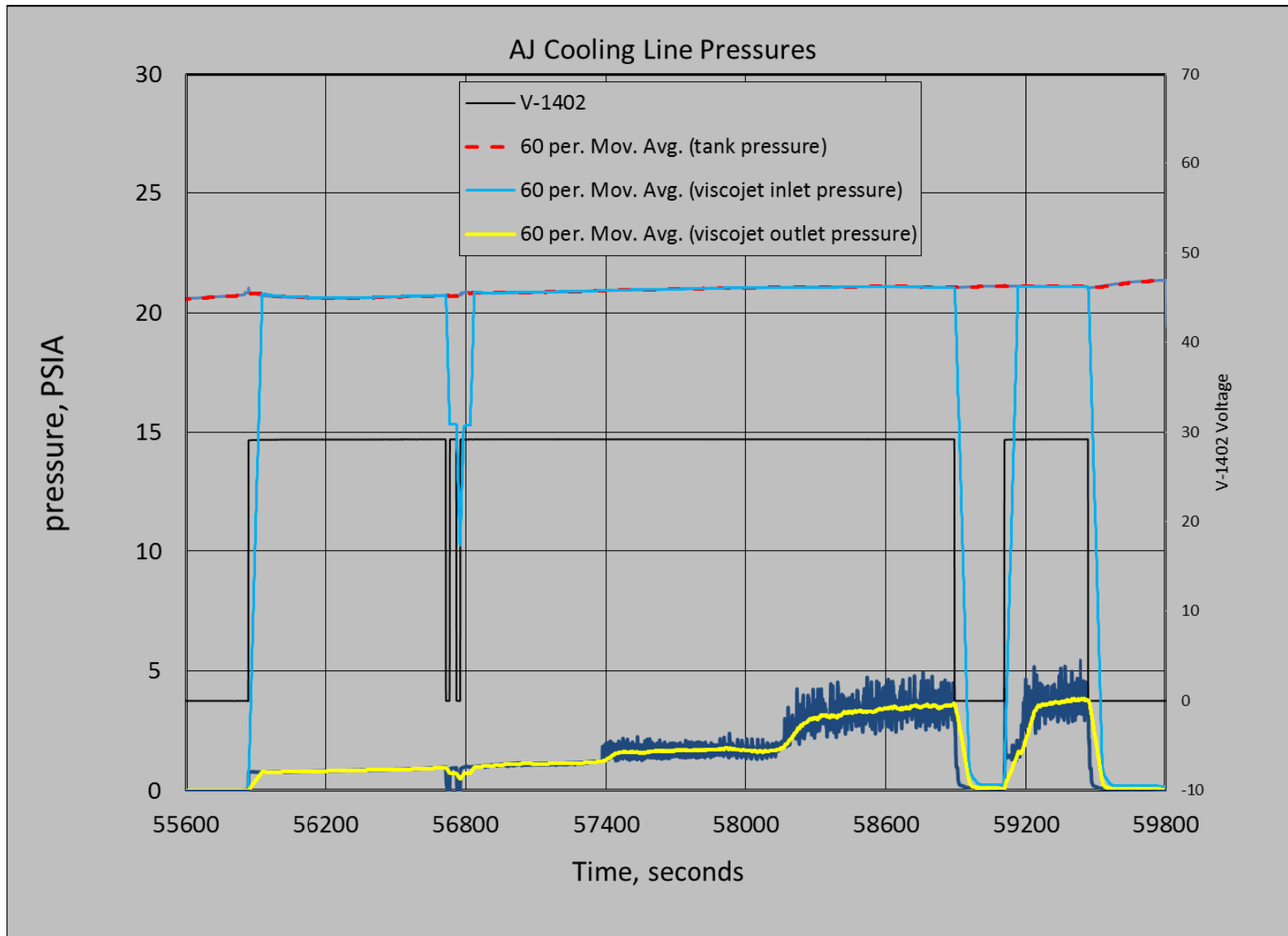

AJ TVS Cooldown Day 2

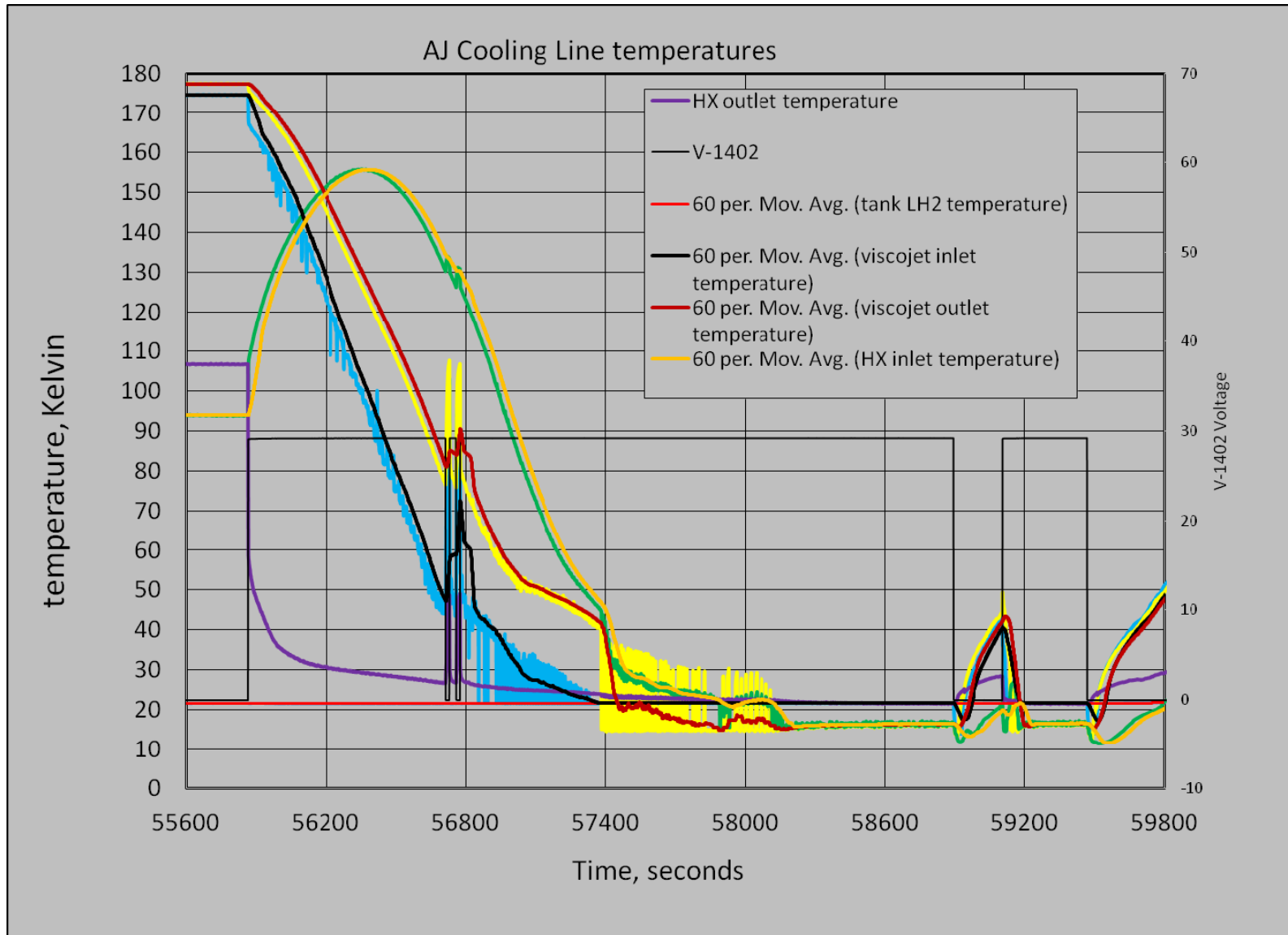

AJ TVS Cooldown Day 2

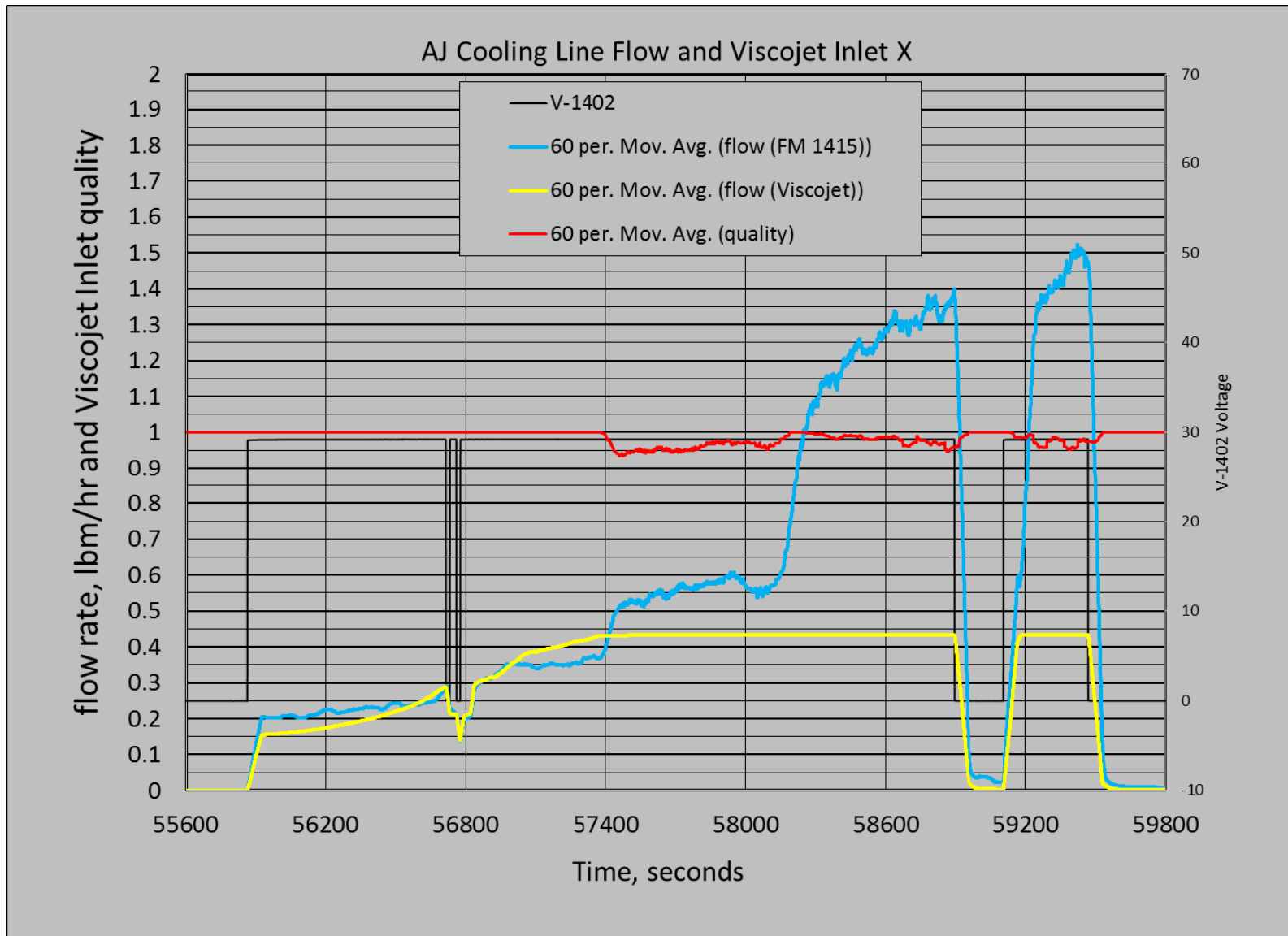

AJ TVS Cooldown Day 2

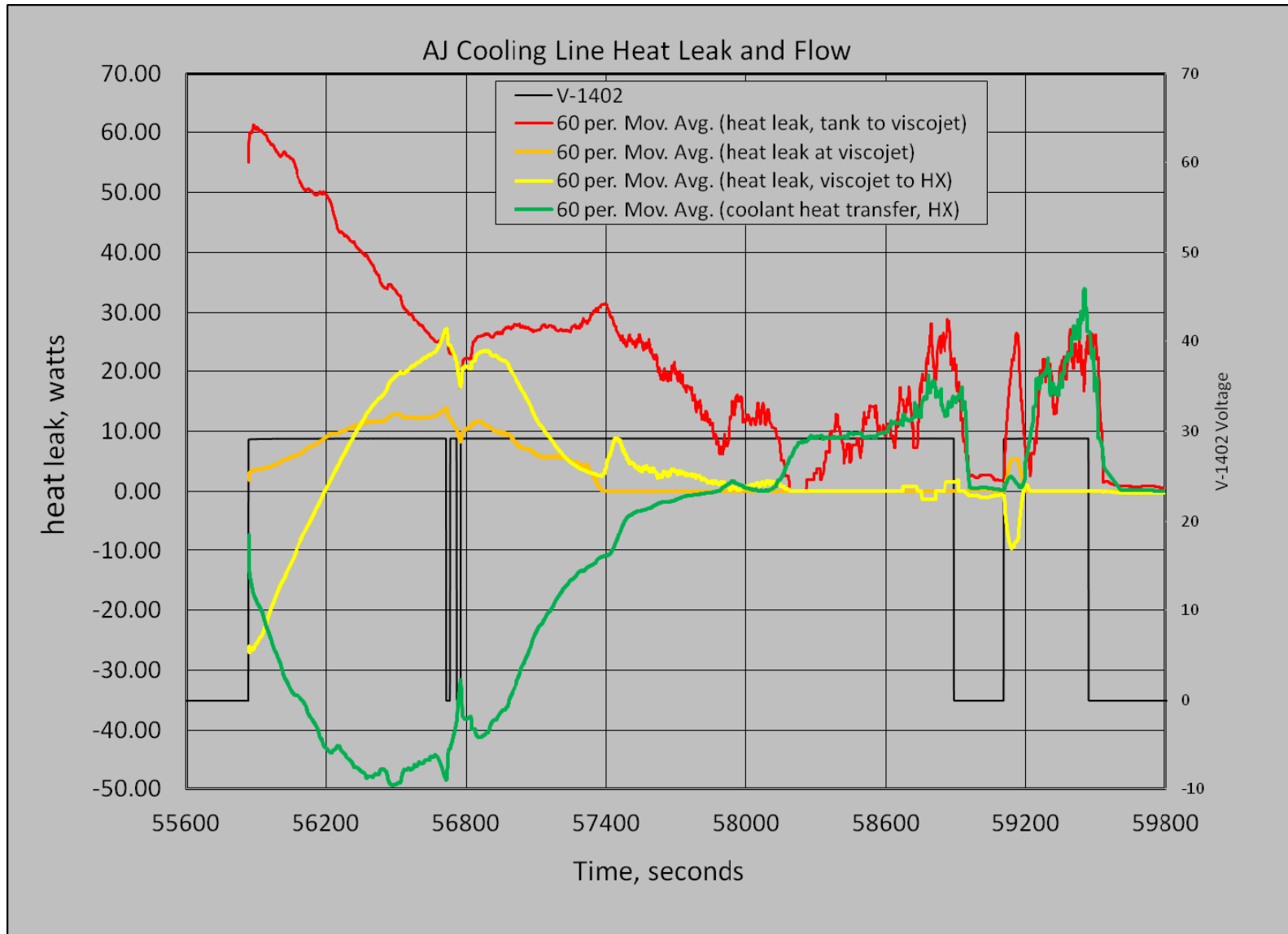

Heat Exchanger Blockage



- After the initial attempt at AJ TVS cooldown, the circuit was not operated for 6 days. When the next attempt was made to flow coolant, there was blockage at the heat exchanger which could not be cleared despite several attempts. This prevented the execution of several cooling/pressure reduction tests.

AJ TVS Cooldown Day 8: Heat Exchanger Blockage

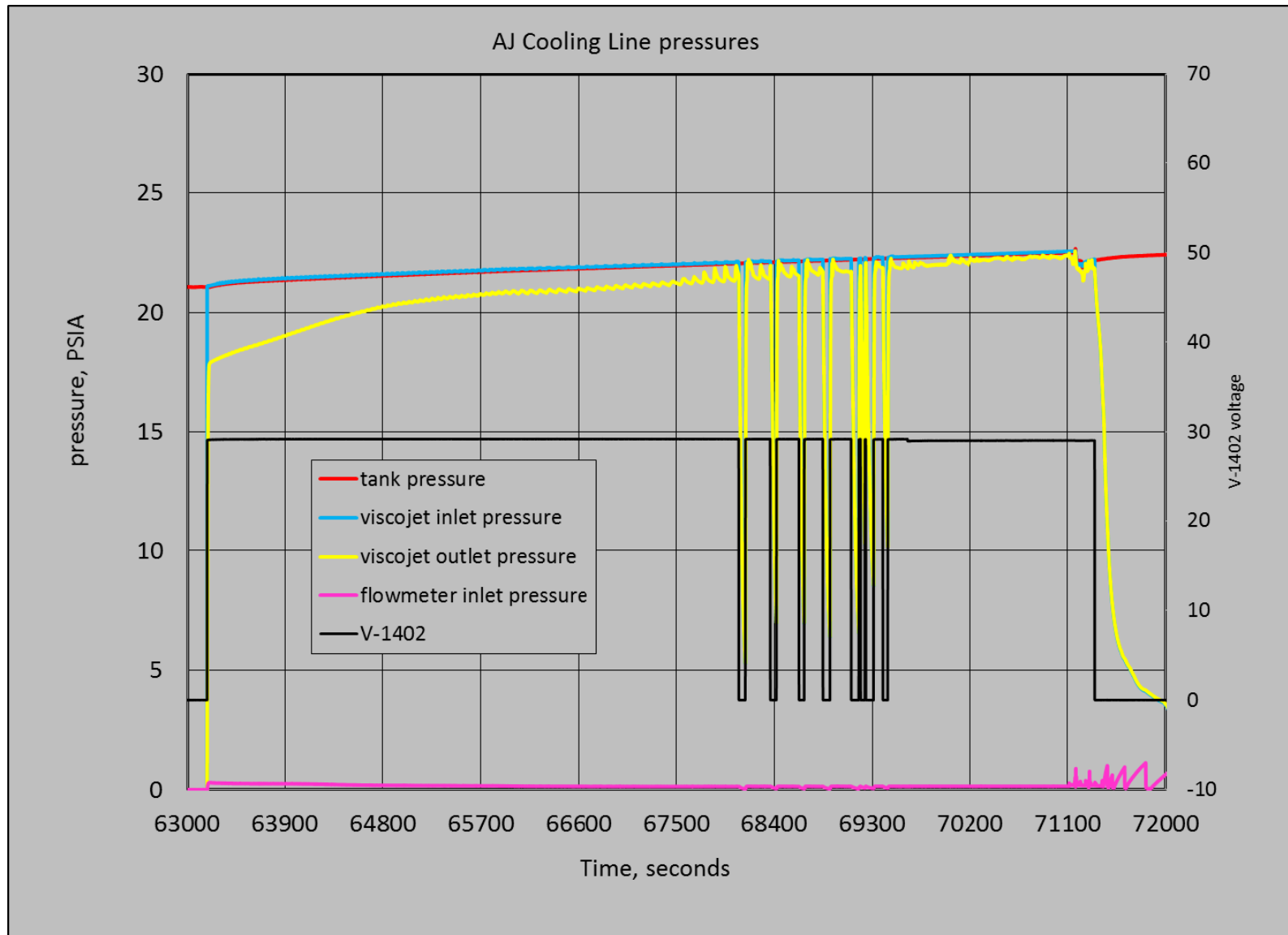

AJ TVS Cooldown Day 8: Heat Exchanger Blockage

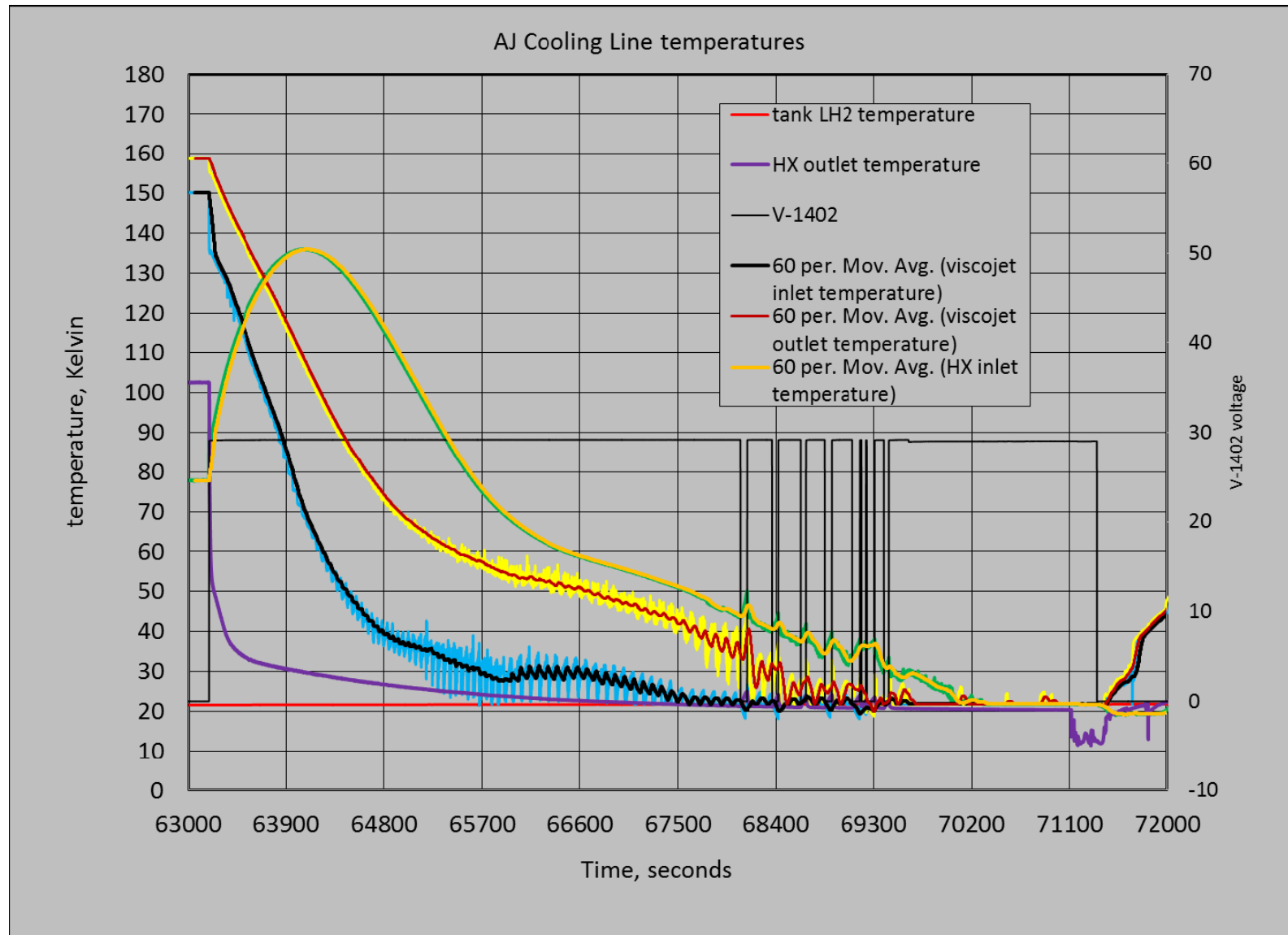

AJ TVS Cooldown Day 8: Heat Exchanger Blockage

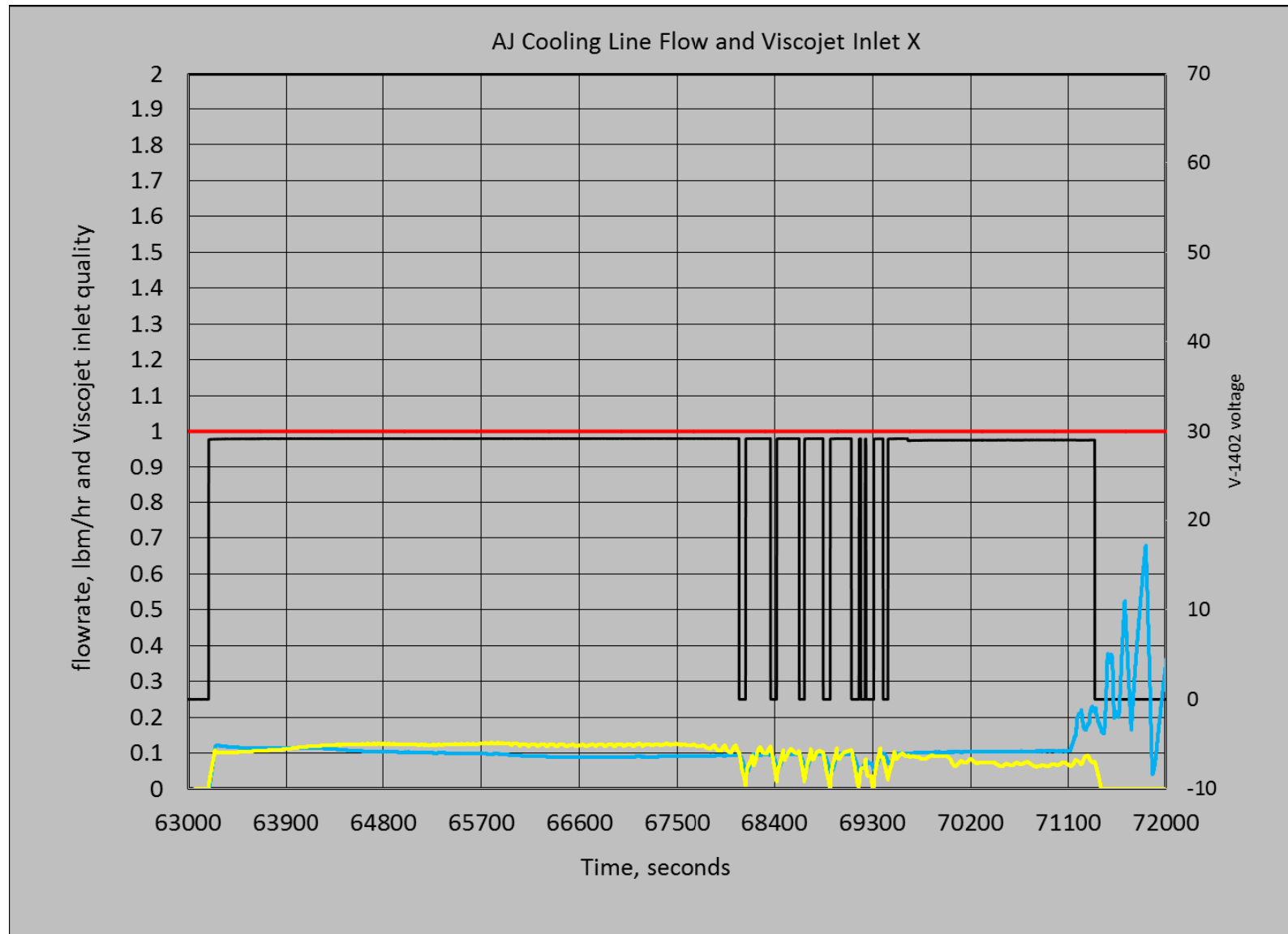

AJ TVS Cooldown Day 8: Heat Exchanger Blockage

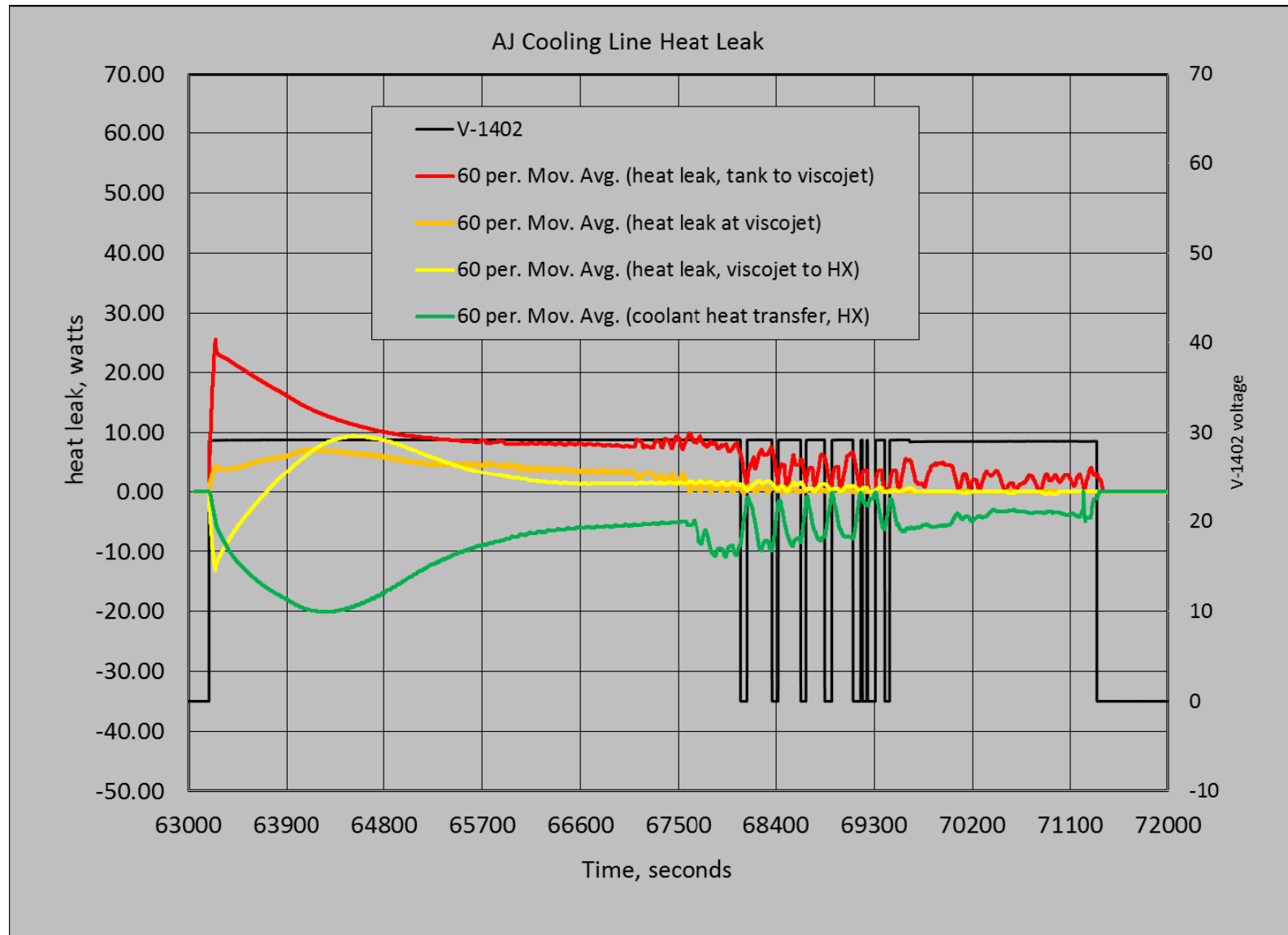

AJ TVS Heat Exchanger Blockage Comparison

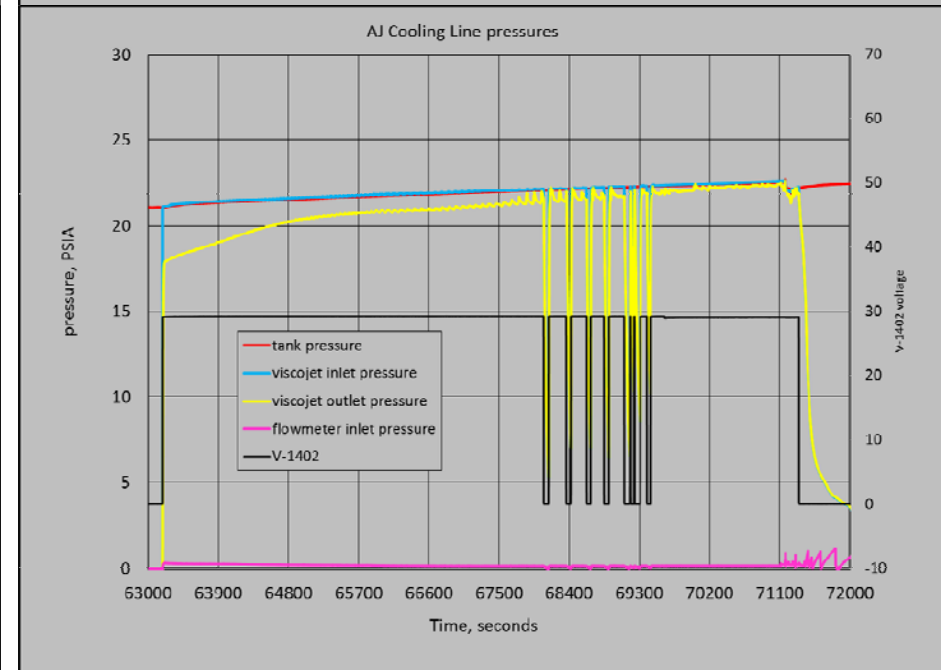
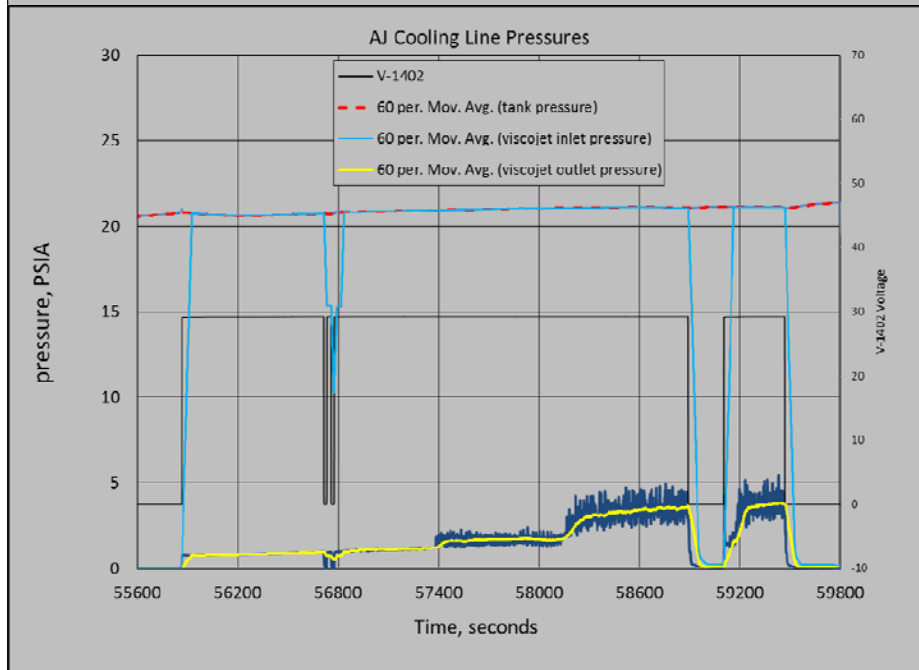
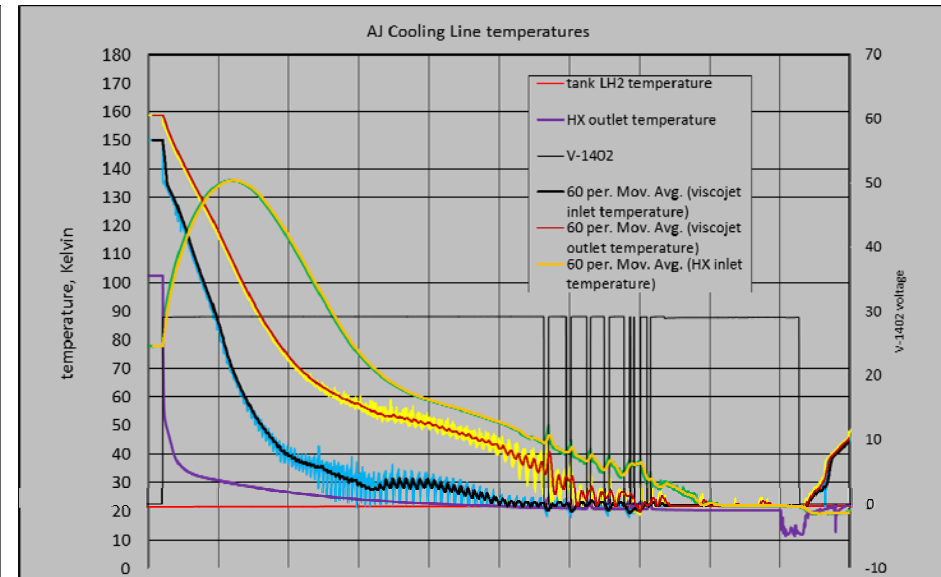
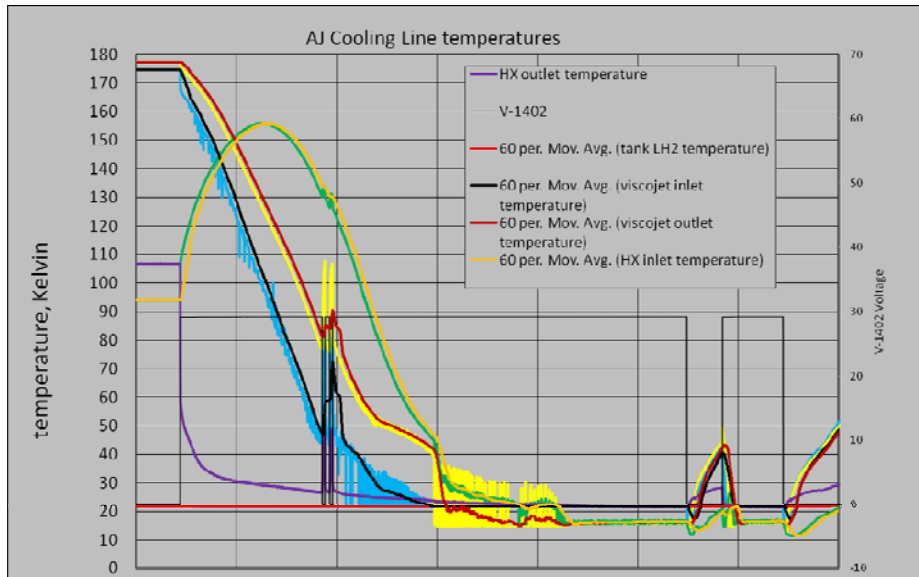

AJ TVS Heat Exchanger Blockage Comparison

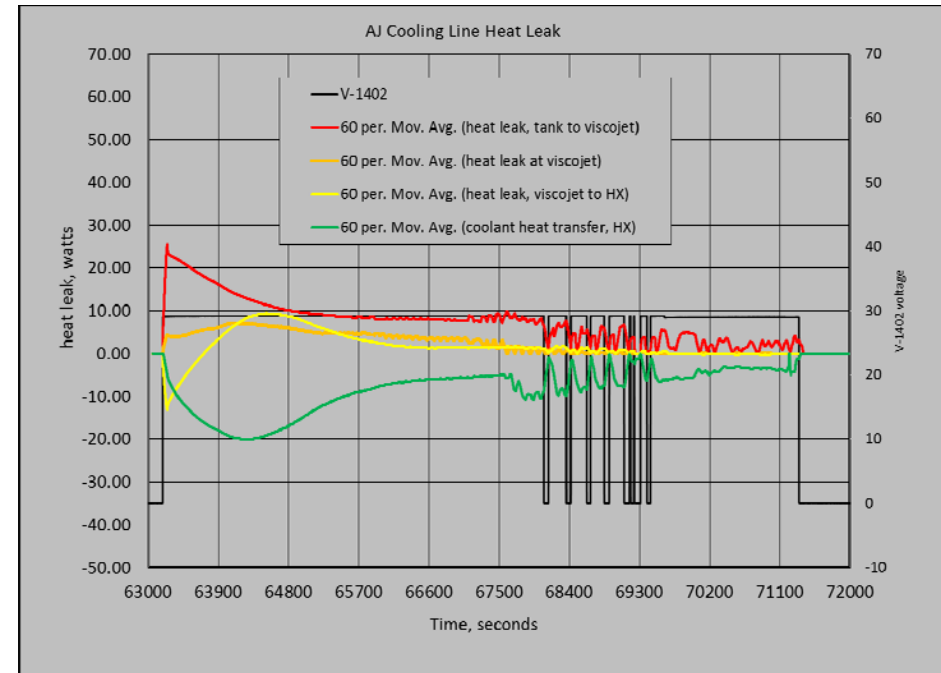
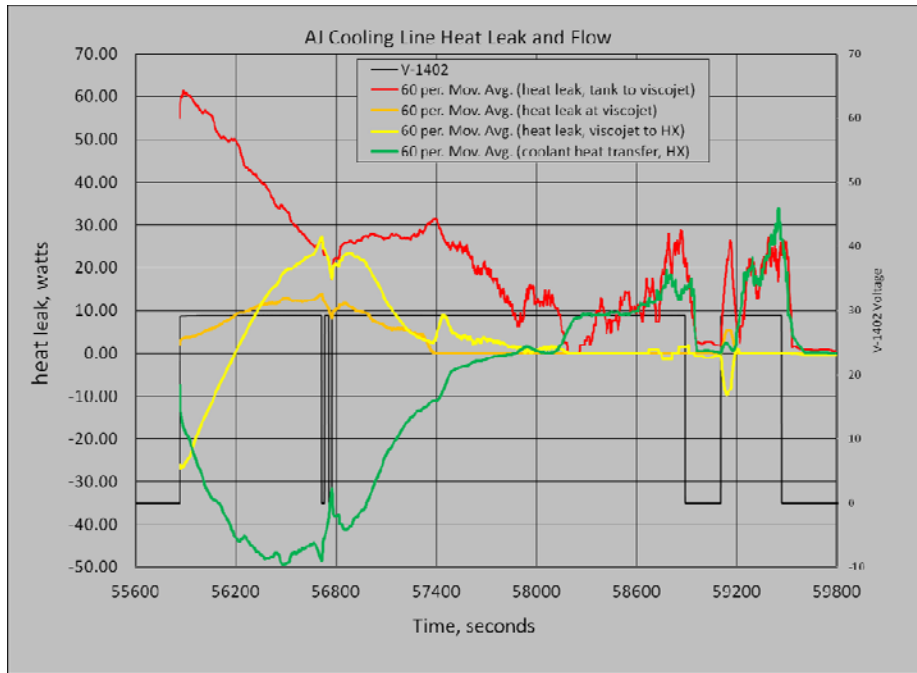

Heat Exchanger Blockage Clearance



- After final test shutdown and with a helium purge on the tank, the blockage cleared during warm up of the heat exchanger.
- The temperature traces at the time of blockage clearing suggest that nitrogen may have frozen in the cooling somewhere inside the heat exchanger. There may also have been some flow area reduction due to weld penetration at the ½ inch to ¼ inch heat exchanger connections which may have been aggravated by thermal contraction.

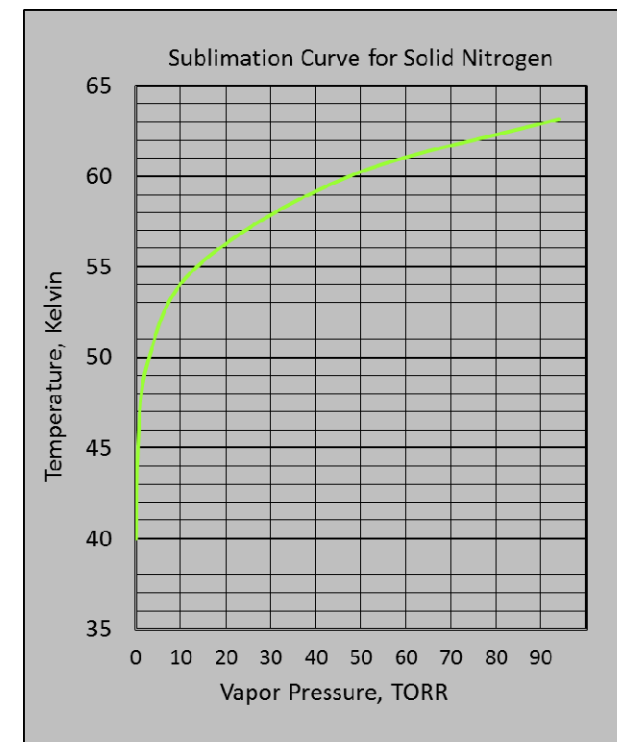
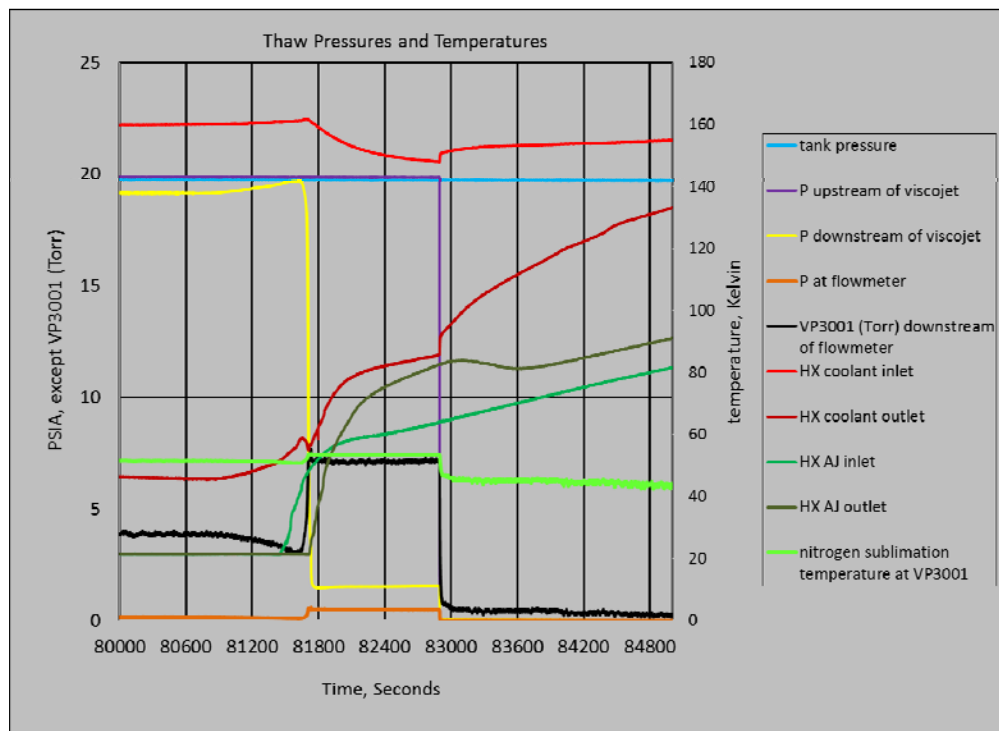



Recommendations

- The TVS cooling circuits had excessive heat leak and could not achieve liquid conditions at the viscojet inlet. The cool-down time should be much less than the tank pressure control band rise time:

$$t_{TVS \text{ cool down}} = \frac{(M\bar{C}_p(T_{max} - T_{operating}))_{metal}}{\int (\dot{m} C_p \Delta T)_{coolant} dt} \ll \frac{\Delta P_{pressure \text{ tolerance band}}}{(\overline{dP/dt})_{tank}}$$

- For effective evaporative cooling, locate expansion device to insure liquid to the inlet if TVS is to be run with saturated liquid. If subcooling is available and the expansion device is not always located in liquid, make sure that after cool-down the expansion device has liquid at the inlet:

$$\dot{q}_{ss,u.s.} < \dot{m}c_p (T_{sat} - T_{subcool})$$

Backup



- Attempts at no vent top off

EDU No-Vent Top Off



- Add-on test objective to try no vent top off of tank from the supply tanker truck
- Observations:
 - Filling through LAD does not promote an adequate amount of mixing in tank
 - Fill was successful when pump was running, even when the wall conditions were at their warmest
 - Supply conditions upstream of the storage tank are unknown – difficult to predict filling behavior of tank
 - Fill line valve is far away from the inlet of the tank, making boundary conditions unknown

No Vent Fill Attempt, Day 9



- Top-off unsuccessful, vented 6 times to relieve pressure
- Fill valve remained open during each vent
- Tank wall was cold (< 24 K) prior to fill
- Slug of 100 K + gas entered tank when V1401 was opened

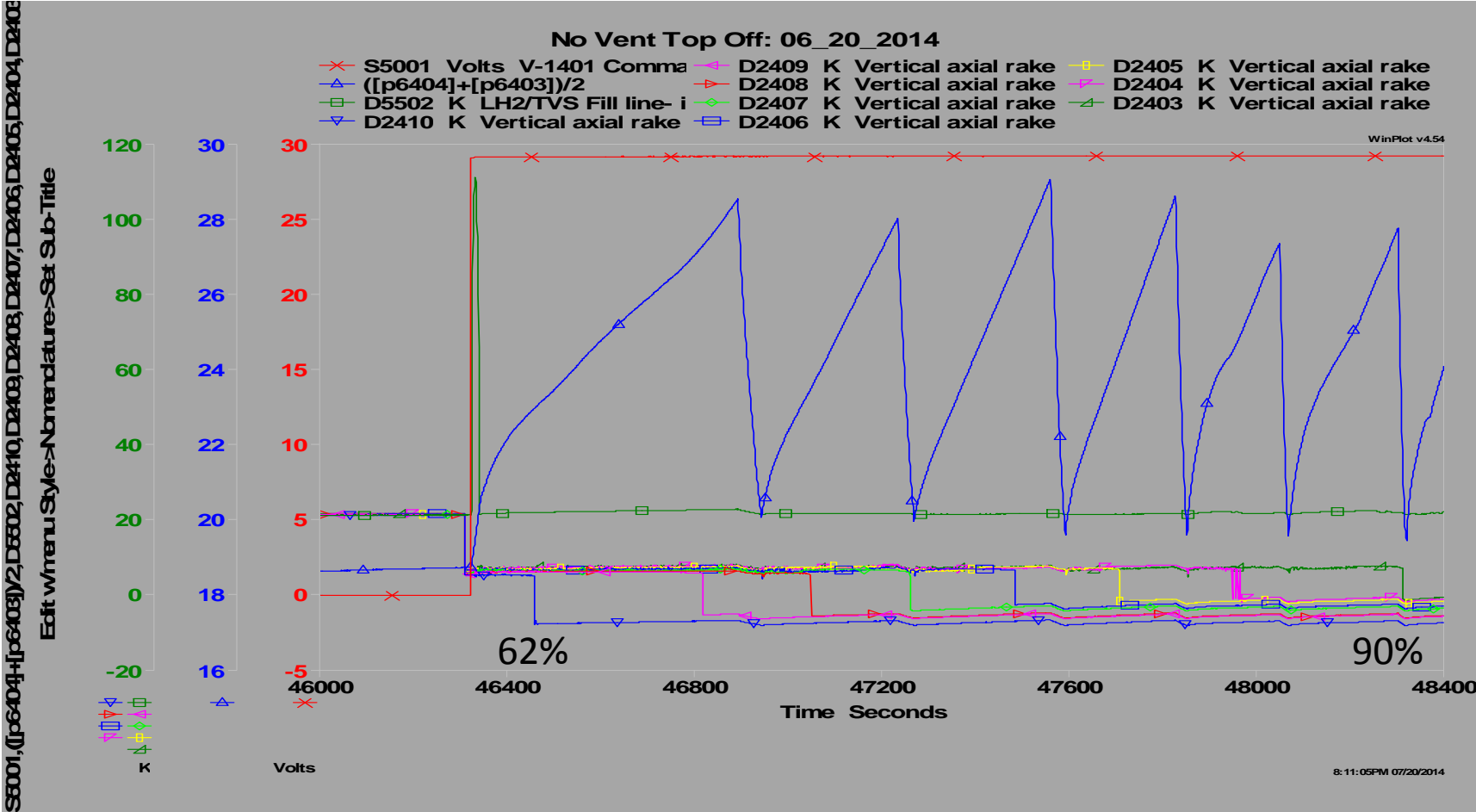

No Vent Fill Attempt, Day 20



- Operation was successful
- Pump was run to agitate the liquid during the fill
- Slug of 100 K + gas entered tank when V1401 was opened
- Tank wall was cold (<40 K), but warmer than day 9 attempt, prior to starting

