

Evaluation of a Gas Chromatograph-Differential Mobility Spectrometer for Potential Water Monitoring on the International Space Station

William T. Wallace, Thomas F. Limero, and Daniel B. Gazda

Wyle Science, Technology, and Engineering Group, Houston, TX 77058

Ariel V. Macatangay

NASA Johnson Space Center, Houston, TX 77058

Prabha Dwivedi and Facundo M. Fernández

Georgia Institute of Technology, Atlanta, GA 30332

Water on the International Space Station

ISS Program established a water quality & monitoring program for regenerated and stored potable water

- Water Recovery System (WRS)
 - Urine Processor Assembly (UPA) processes pretreated urine by distillation and delivers distillate to a wastewater tank where it is combined with humidity condensate.
 - Water Processor Assembly (WPA) treats the wastewater using multifiltration and thermal catalytic oxidation, adds iodine biocide, and stores product water for delivery to the potable water bus.
- Potable Water Dispenser (PWD)
 - Receives WPA product water direct from the bus and dispenses either hot or ambient water after removing iodine at the point of use



WPA Schematic

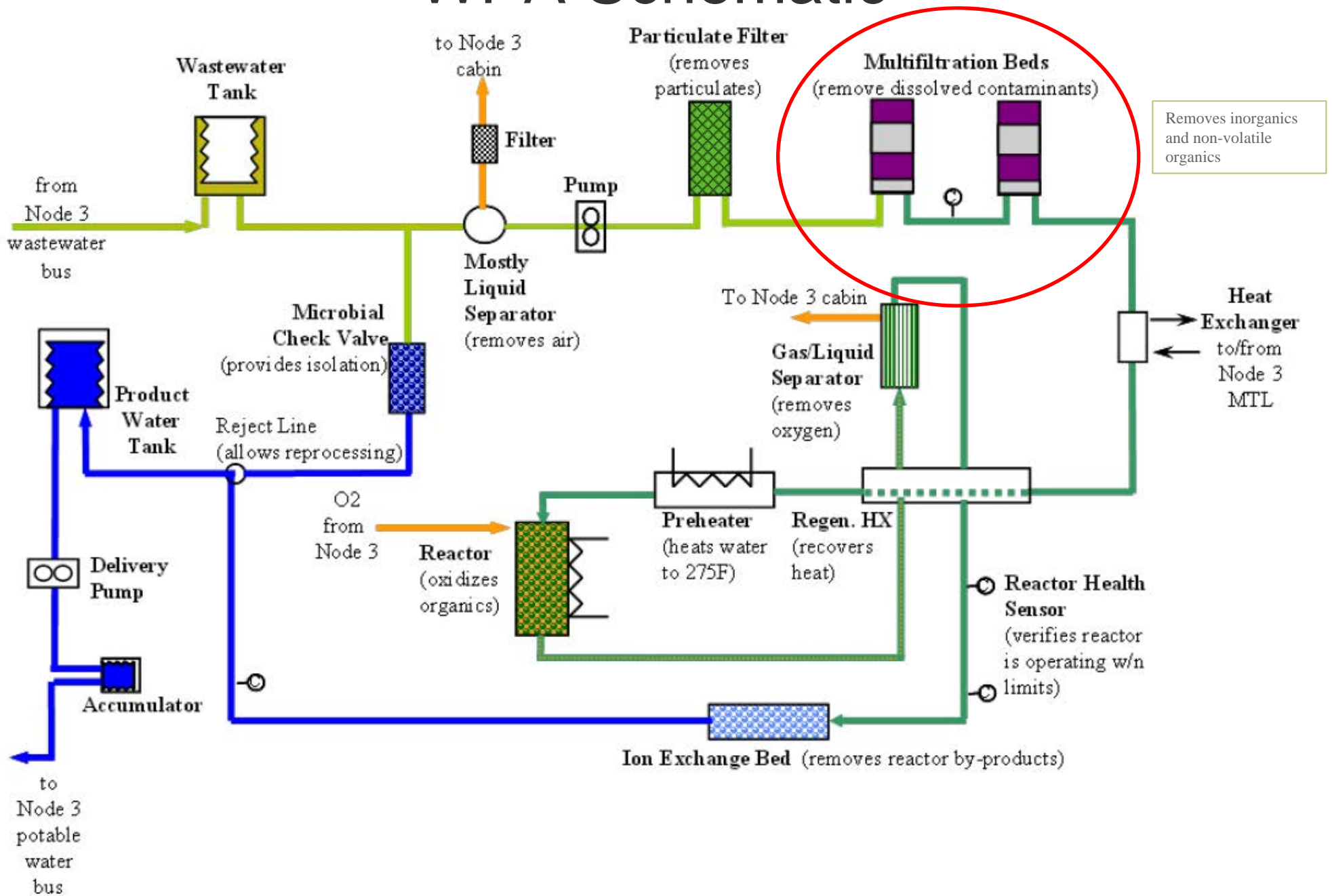

Water Quality Monitoring on ISS

- Due to the relatively high purity of ISS potable water, the water quality monitoring strategy currently employs the following:
 - Monitor TOC (total organic carbon) with TOCA
 - Monitor biocide levels (iodine in US potable water) with CWQMK
 - Archival samples returned for ground analysis



TOCA (total organic carbon analyzer)
– measures total organic carbon concentrations in ISS water using IR



CWQMK (colorimetric water quality monitoring kit)
– measures biocide levels (Ag, I₂/total Iodine) in water using absorbance

Water Quality Monitoring on ISS

- In 2010, crew observed increase in TOC, approaching the 3000 $\mu\text{g/L}$ US Segment Specification for TOC; replacement of multi-filtration bed of WPA required

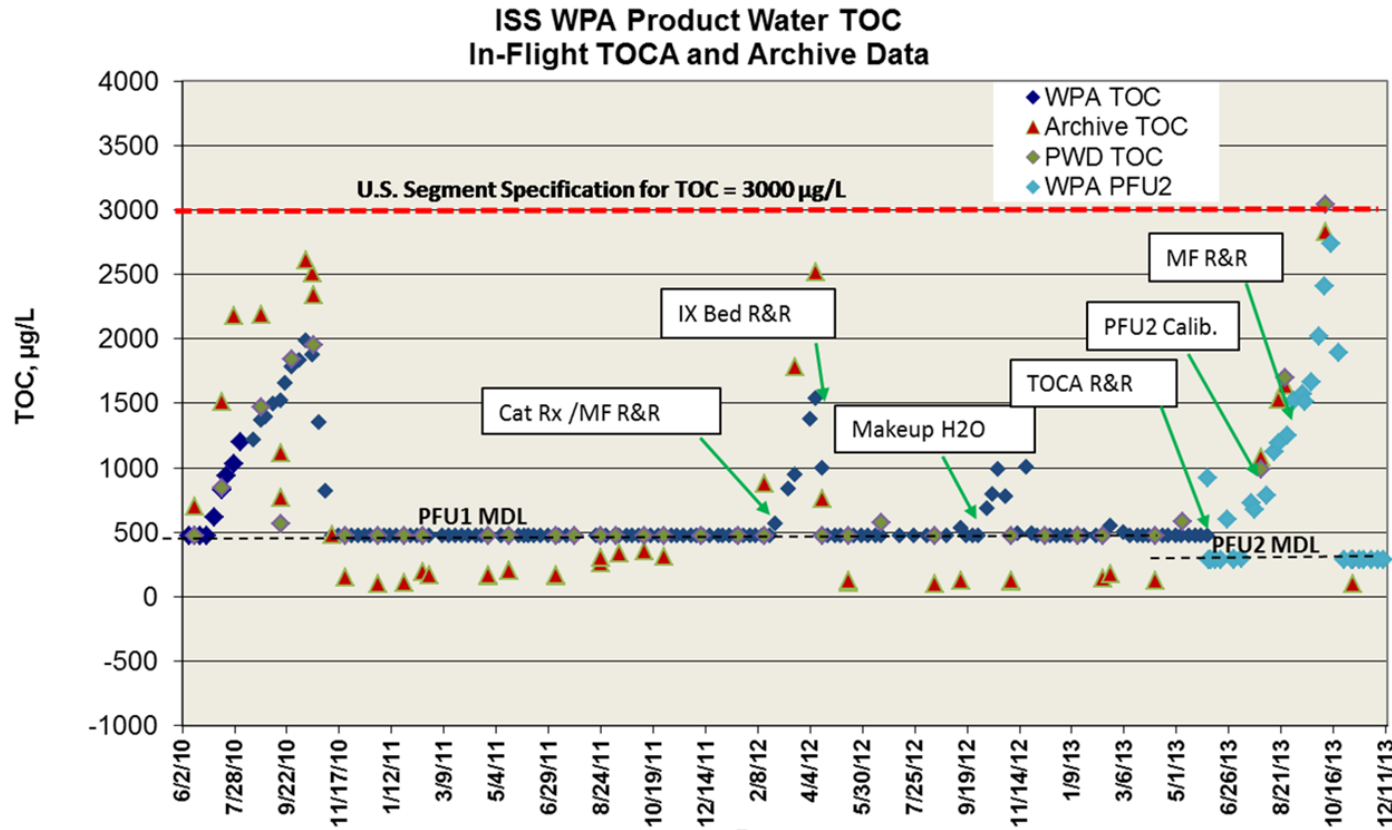

- Return samples and extensive ground analysis attributed rise of TOC (>90%) to presence of dimethylsilanediol (DMSD)

Water Quality Monitoring on ISS

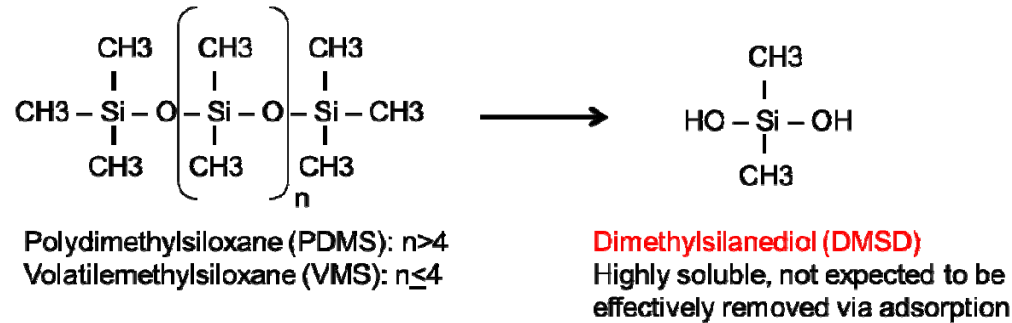

- DMSD not health concern below 35,000 $\mu\text{g/L}$ (equivalent to a TOC of 9000 $\mu\text{g/L}$)
- ECLSS concern since DMSD shortens life of multi-filtration beds of WPA and impacts traffic model
- Increase in TOC continues to occur periodically
- Exposure to DMSD is low risk from crew health perspective, but its ability to increase background TOC has potential to hide other problems
 - Mask presence of more toxic compounds present at low concentrations
 - Mask indication that WPA performance is compromised, e.g., incomplete/partial oxidation of small organics due to problems with oxidation reactor
- *DMSD has effectively shed light on a hole in current ISS water quality monitoring strategy – ability to identify and quantify target species in ISS potable water in real time*

Need for Real-time Monitoring

- TOCA supplies excellent trending data regarding organics (and overall water quality) in ISS water
- Rise attributable to DMSD shows that a single compound can skew the data
- Time delay for return and analysis of archival samples precludes immediate mitigation of problems
 - Return of samples can be > 6 months after collection
- Real-time monitoring of target species a priority, especially for future exploration missions
 - Lack of ground support
- Compound-specific information needed to determine if drastic changes in TOC require mitigation efforts or if water can still be safely used
- *Ground analysis of water samples typically involves same analytical hardware used in the ground analysis of air samples; only difference is method to separate the water from the compounds of interest*
- Air Quality Monitor (AQM) monitors trace volatile organics in real time; many of the target compounds in air are the same for water; presents a potential starting point
- Development of multifunctional monitor would improve current analysis and is a first step towards fulfilling the needs of future missions
- *Need to liberate organics from water matrix for analysis*

Air Quality Monitor (AQM)

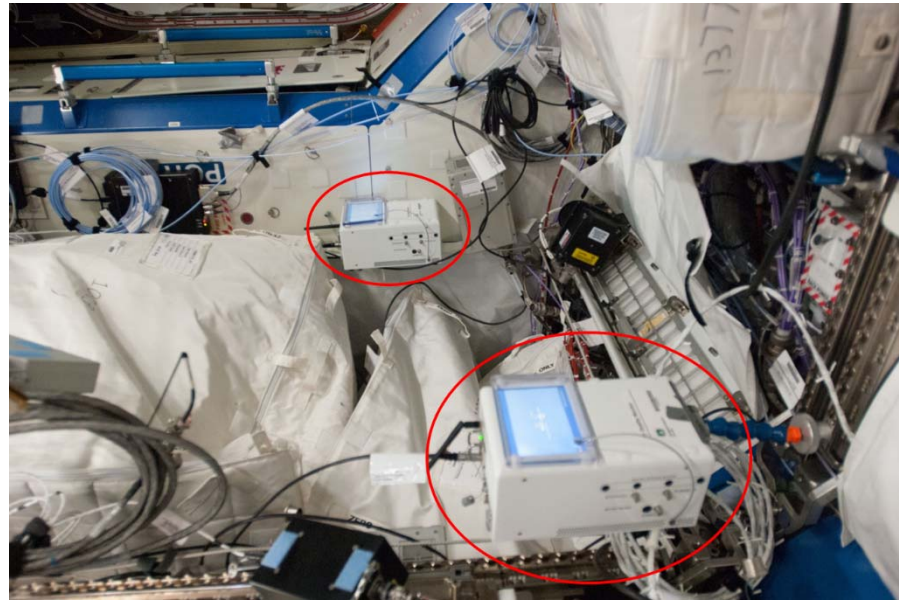
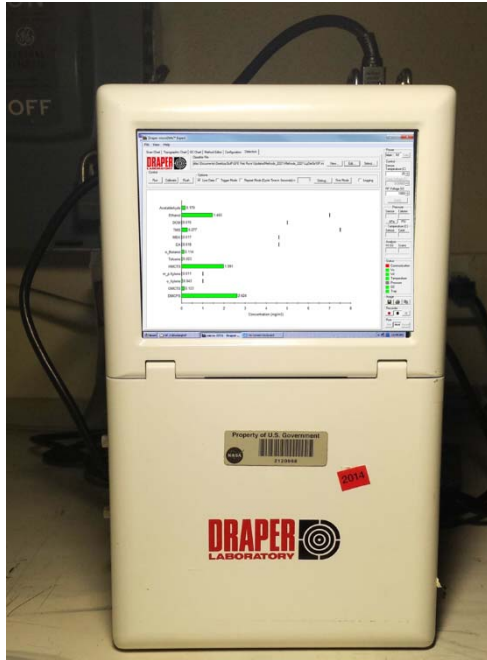

- AQM combines gas chromatography with differential mobility spectrometry
- 2 units currently on board the ISS; different GC columns
- Target list of 22 compounds detected using automated methods
 - Other compounds analyzed manually
- Sample purge available to remove moisture

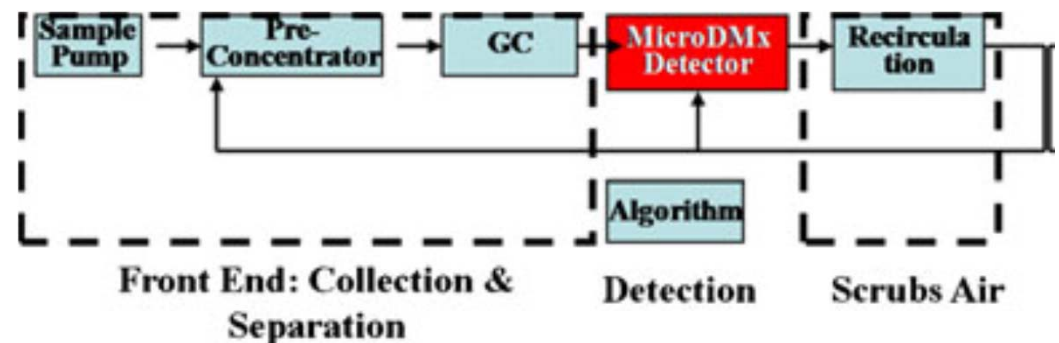

Electrothermal Vaporization (ETV) Inlet

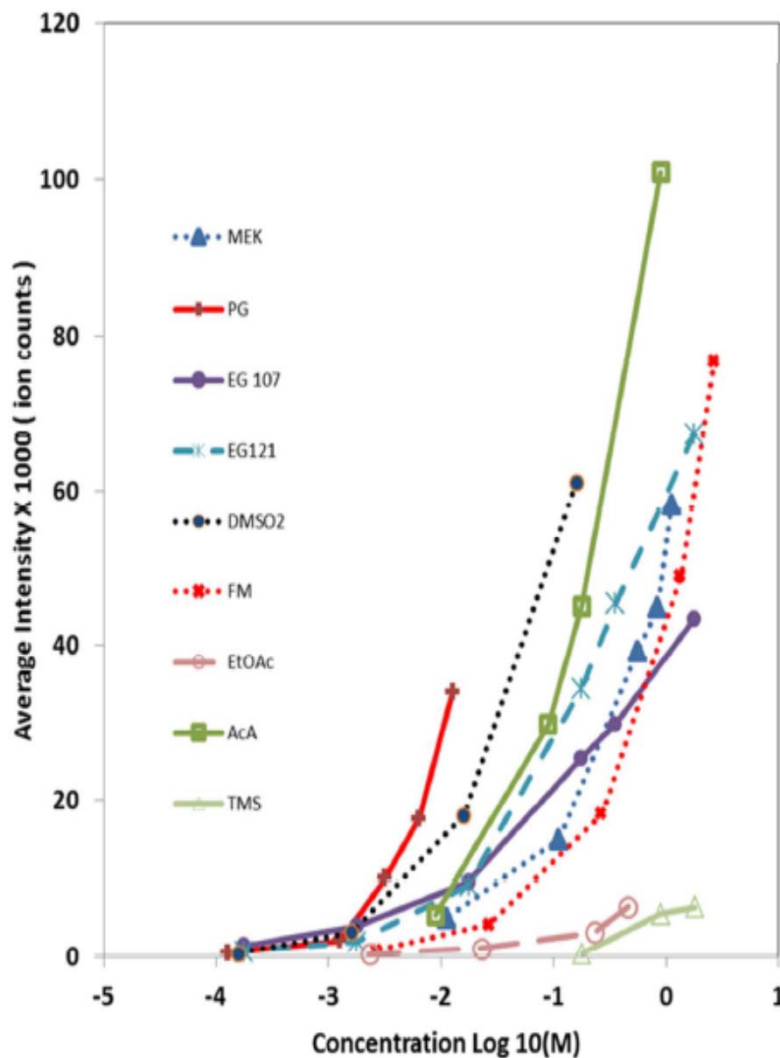
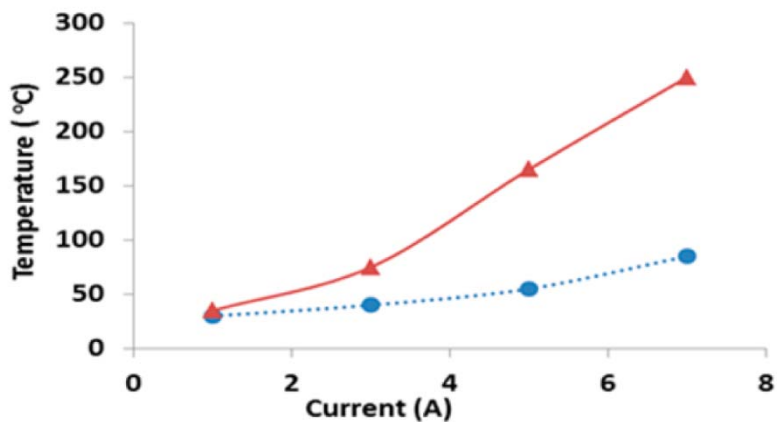
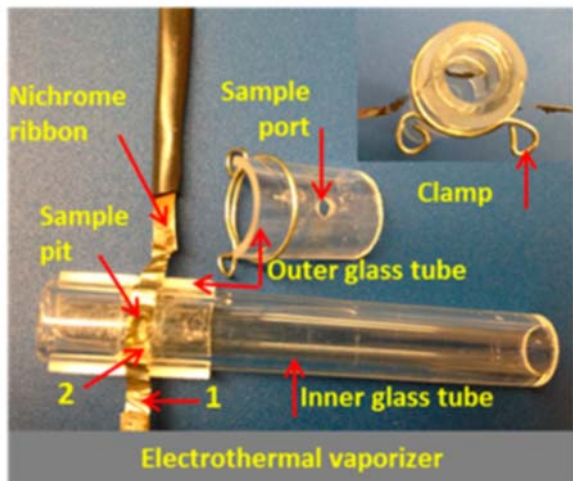

ETV source placed in-line with atmospheric pressure ionization source (DART) coupled with mass spectrometer. As current applied to nichrome ribbon containing sample, water solvent is vaporized and target analytes are volatilized and entrained in carrier gas.

Dwivedi et al., *Anal. Chem.* **85** (2013) 9898-9906.

ETV-AQM

- DART-MS experiments show that ETV holds promise for sample introduction into air monitor
- For spaceflight water monitoring, need to utilize current hardware and reduce reliance on ISS (e.g. power and carrier gas)

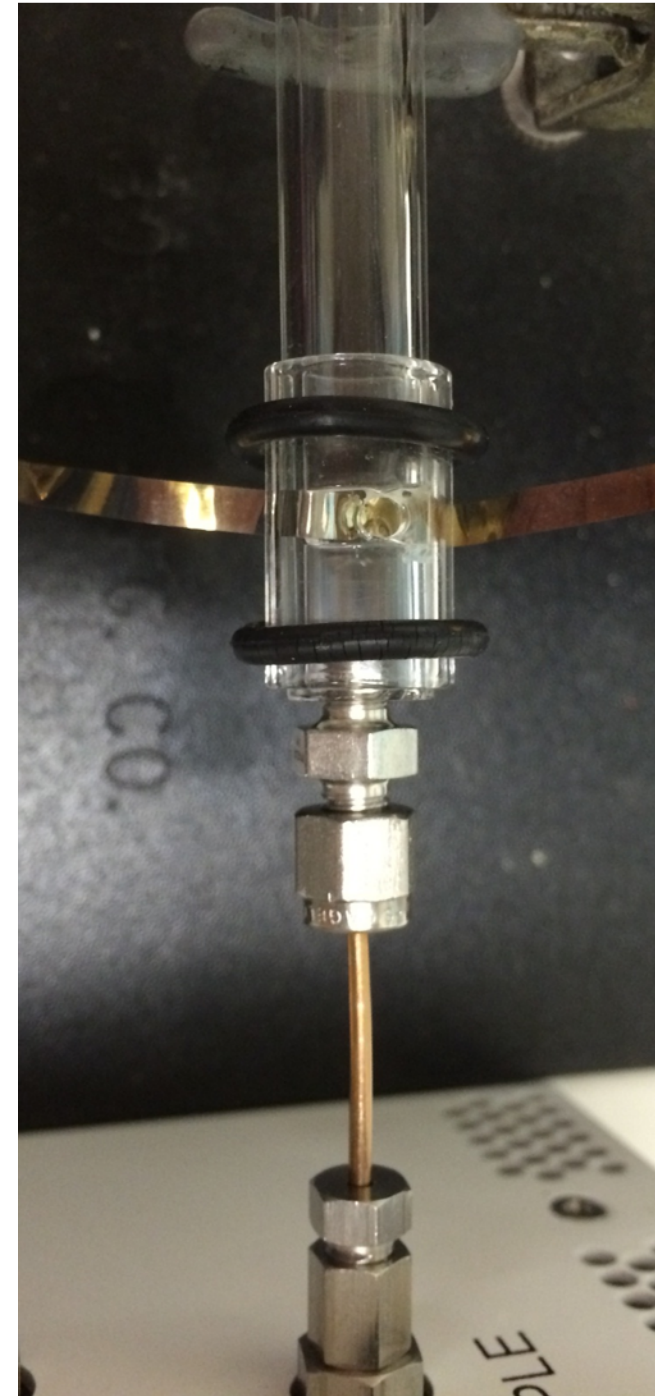
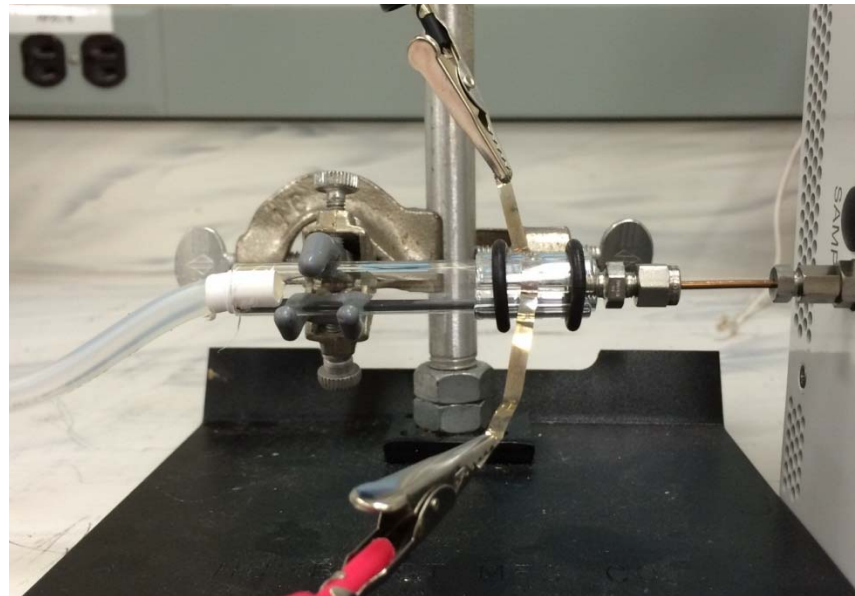

Initial Analysis of Individual Compounds

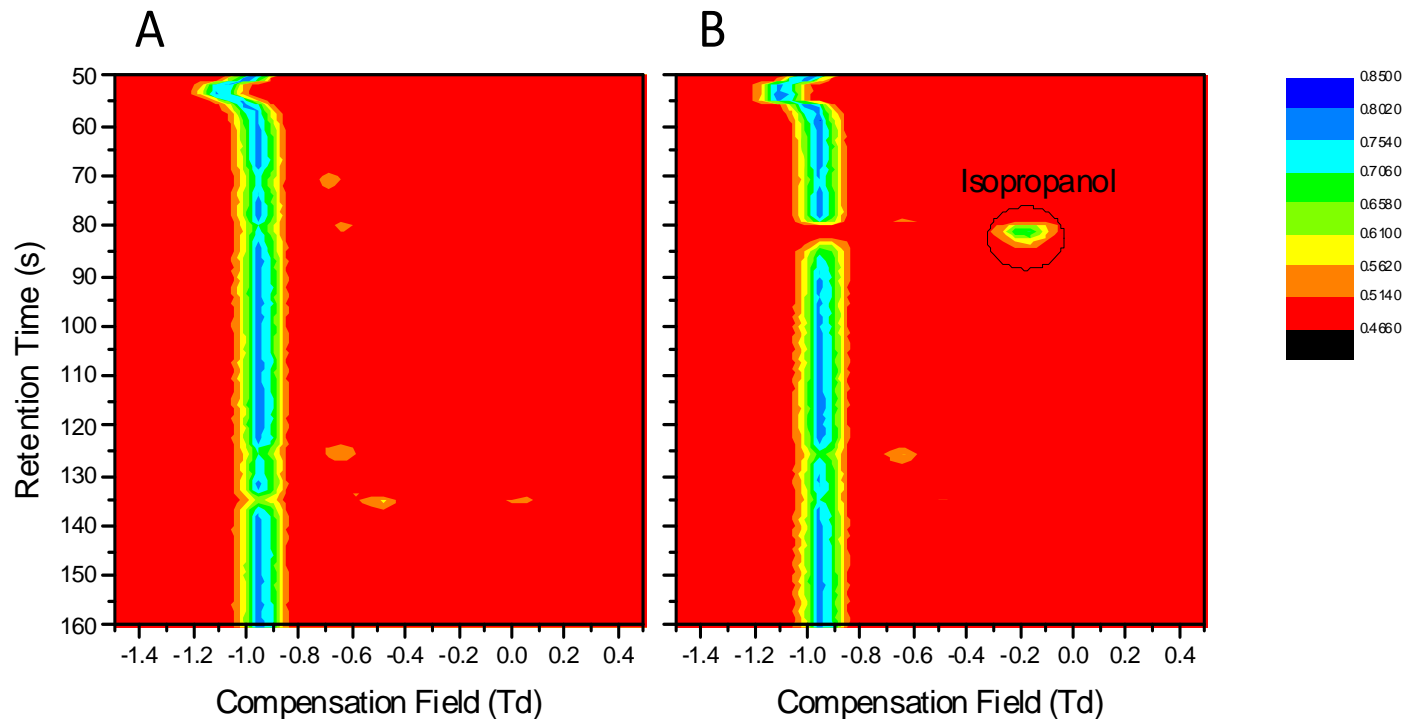

- Tested DI water (A) using ETV-AQM for control
- Added subset of target compounds (B) to determine retention time and DMS parameters
- Concentration Range
 - 1 – 100 mg/L

Wallace et al., *Anal. Chem.* (2015) submitted

Compound (mode)	Retention Time (s)	Separation Field				Compensation Field (Td)
		87 Td	96 Td	106 Td	115 Td	
Methanol (+)	60.7	-0.85	-1.12	-1.50	-1.92	
Ethanol (+)	71.8	-0.32	-0.43	-0.54		
Isopropanol (+)	81.9	-0.11	-0.11	-0.11		
Acetone (+)	82.9	-0.05	-0.05			
Dimethylsilanediol (-)	103.1	-0.16	-0.21	-0.21	-0.59	
Trimethylsilanol (+)	117.3	0.11	0.16	0.16	0.27	
2-Butanone (+)	135.5	0.05	0.05	0.11		

Testing of Mixtures and Preparation of GC Method

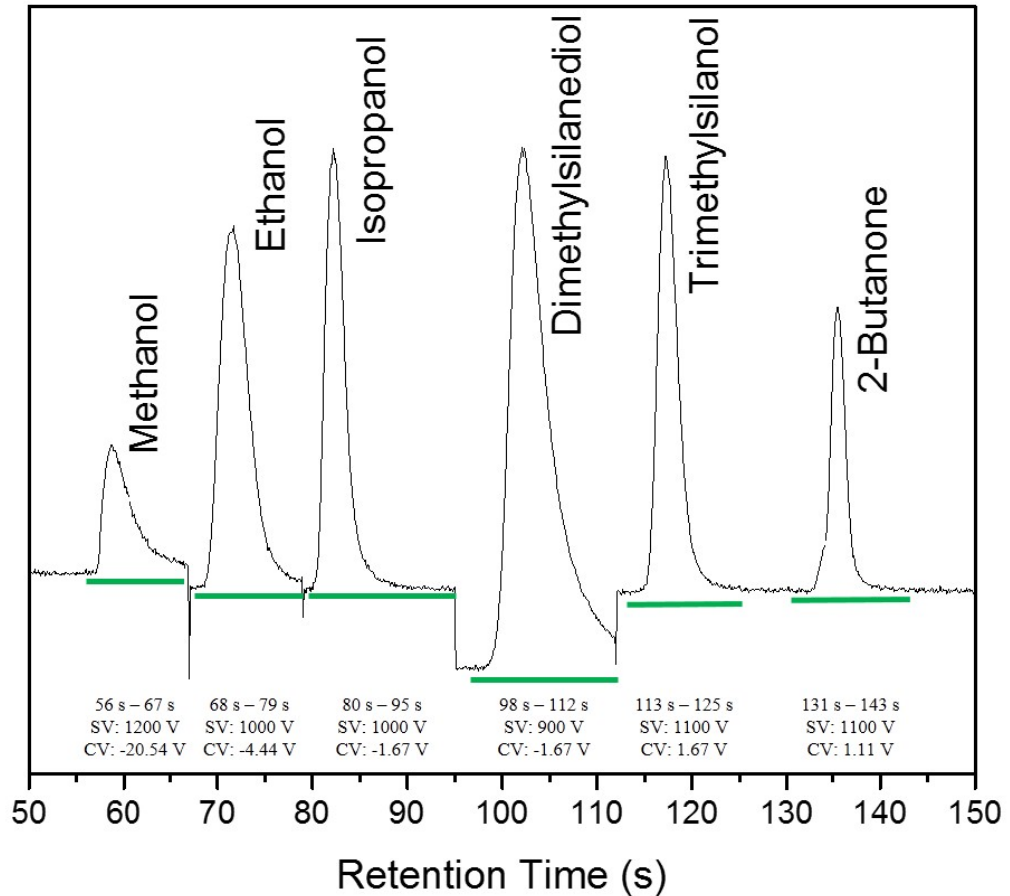
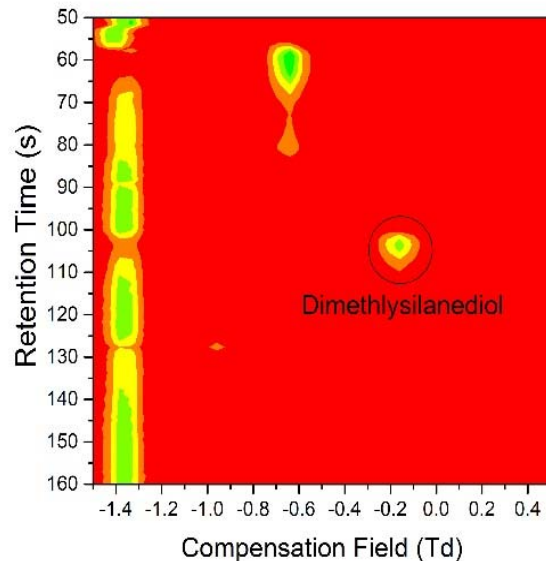
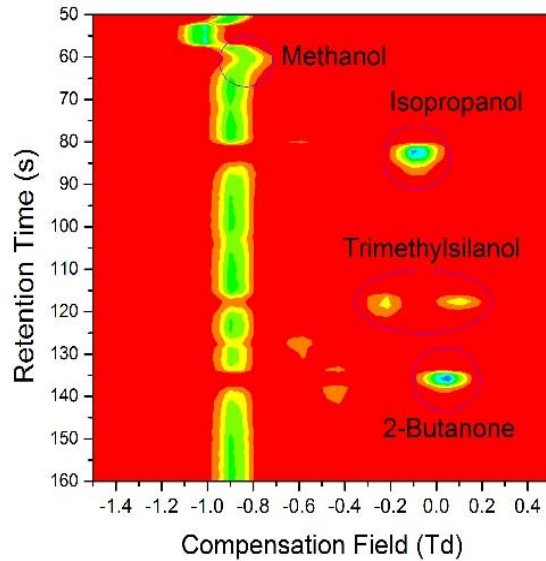

- Testing of mixture shows expected individual compounds
- Scan method does not provide automated, optimized information (i.e. concentration)
- GC method allows a single, short run (240 s) to be used for automated analysis of at least 6 compounds
- Coelution of acetone and IPA
 - **Appropriate C_v allows IPA to be detected**
- Without changes to AQM (cooling/dopant), different column needed for analysis of acetone

Calibration

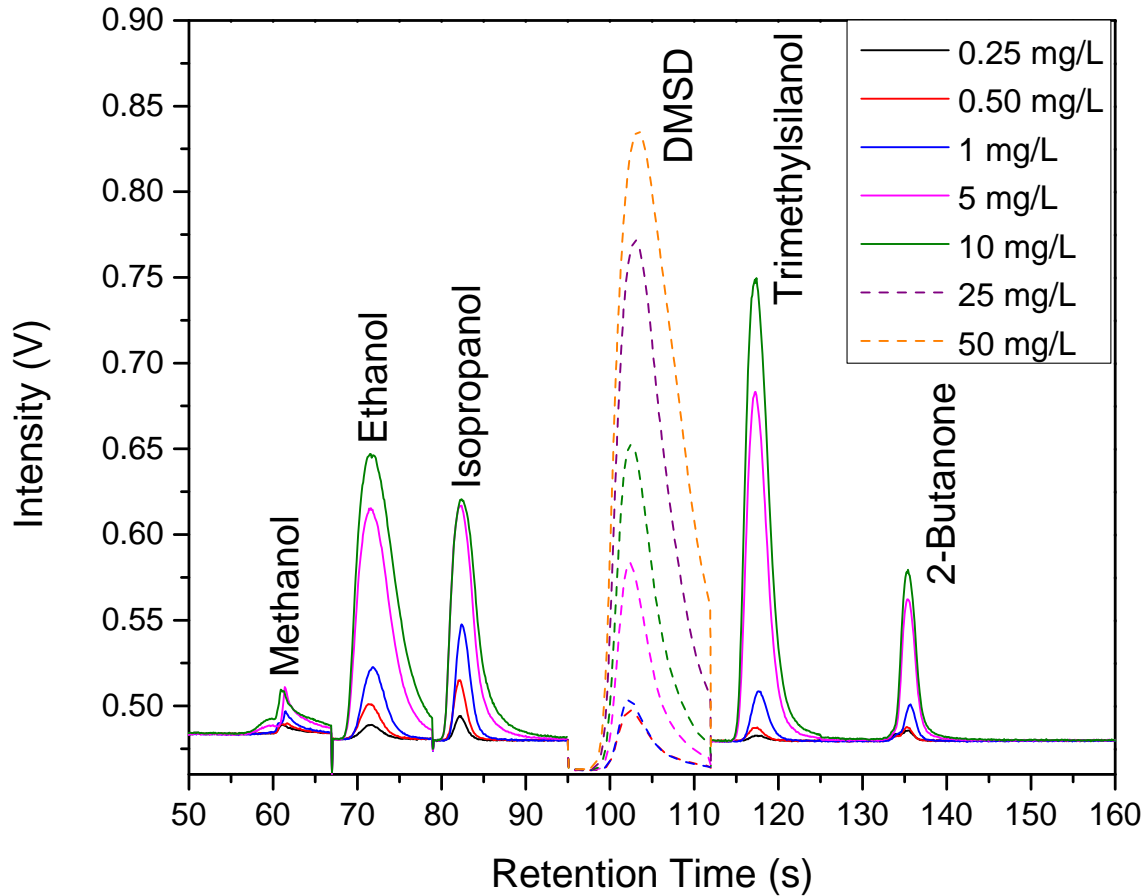

- Calibration of AQM using 7-compound mixtures to build calibration curves
- Appropriate function chosen based on expected/historical concentrations
- Calibration data used to check quality of curves

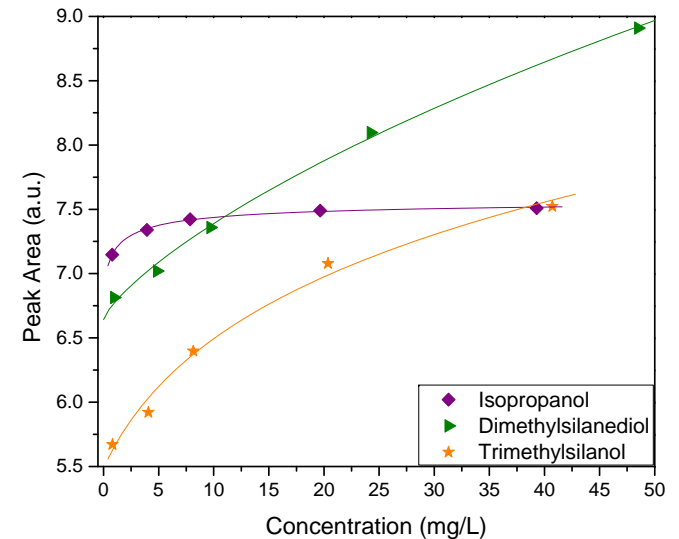
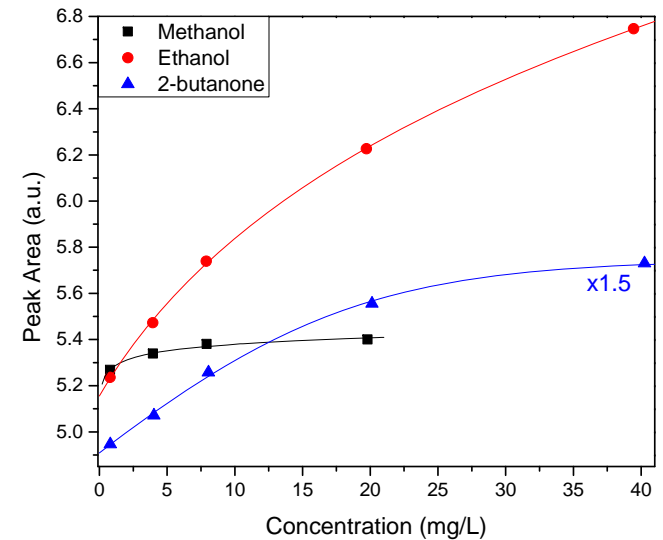

Analysis of ISS Archival Samples

Compound	Units	Potable Water Dispenser 7/30/2013		Product Water 8/19/2013	
		ETV-AQM	GC-MS/LC-RID	ETV-AQM	GC-MS/LC-RID
Methanol	$\mu\text{g L}^{-1}$	17.8	< 200	ND	< 200
Ethanol	$\mu\text{g L}^{-1}$	15.4	< 200	28.9	< 200
Isopropanol	$\mu\text{g L}^{-1}$	ND	< 200	ND	< 200
Dimethylsilanediol	$\mu\text{g L}^{-1}$	4390	3800	6830	5300
Trimethylsilanol	$\mu\text{g L}^{-1}$	403	ND	228	ND
2-butanone	$\mu\text{g L}^{-1}$	41.1	< 5	81.9	< 5

- DMSD, methanol, ethanol, and isopropanol – correlate well with laboratory-based methods
- TMS / 2-butanone values determined by lab-based methods are below the lowest AQM calibration point
 - Reason for higher AQM values unclear

Is DMSD Present in the Atmosphere?

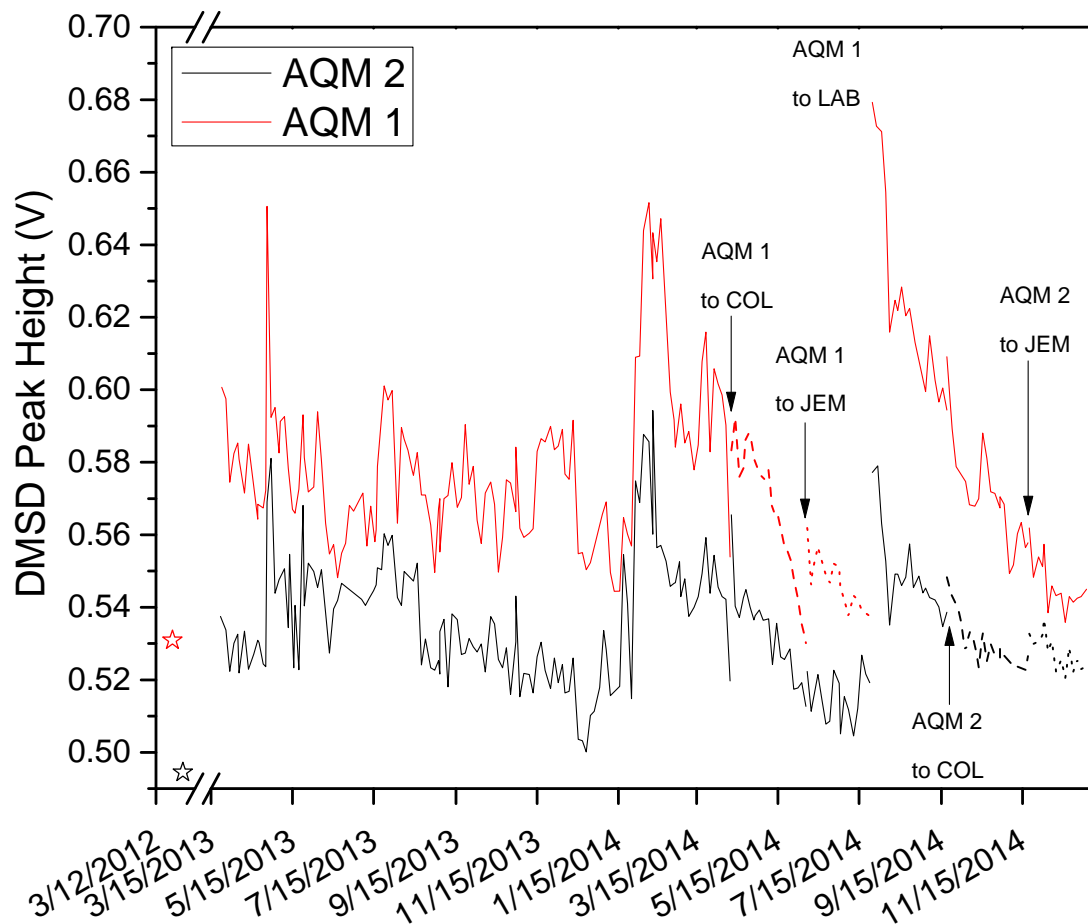

- Vapor pressure of DMSD in solution is low; difficult/impossible to introduce samples into AQM
 - No way to determine analytical parameters (RT, C_v , +/-)
- Testing of ETV with MS gave first surprising information; *DMSD detected as negative ion*
- Integration of ETV with AQM provided other parameters
 - AQM parameters of other organics tested in water matched those tested in air
- Analysis of ground prep data and flight data shows marked increase in DMSD peak
- Presence of peak and similar trends on both instruments indicates not an artifact

Does the Atmospheric DMSD Correlate with the TOC Increases?

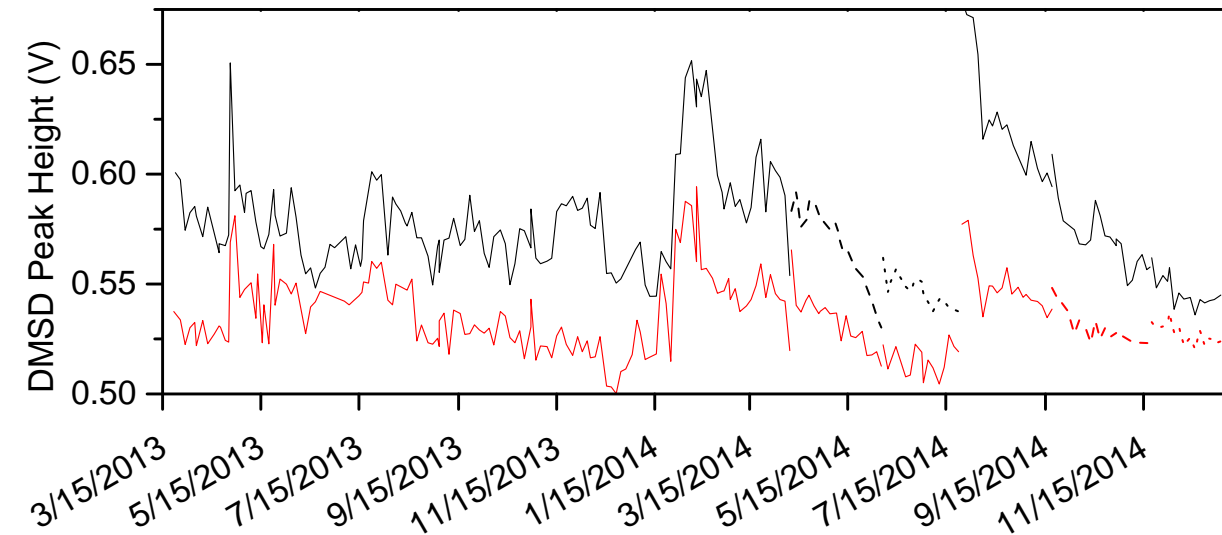
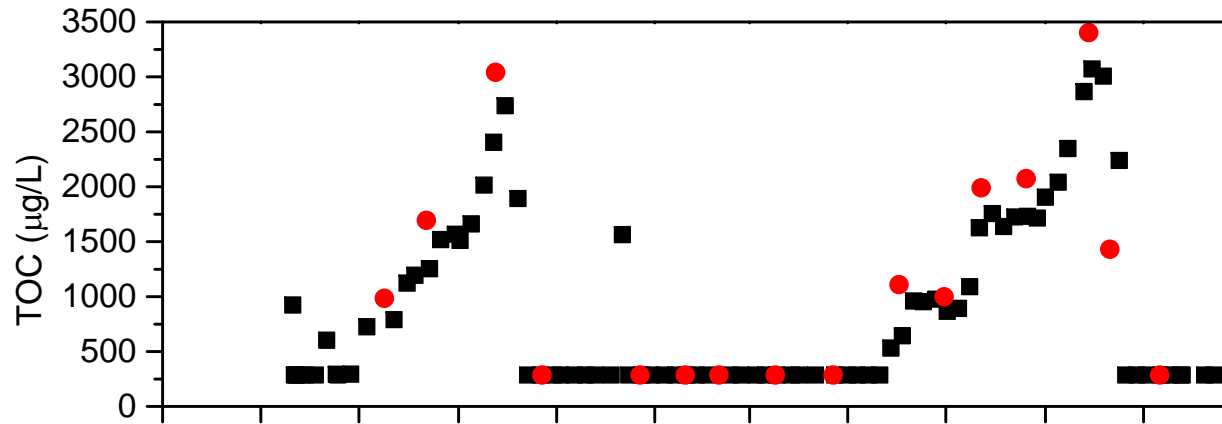

- No obvious correlation between TOCA readings and atmospheric DMSD
- DMSD in product water based on buildup and breakthrough of MF beds
 - Should not expect direct relationship
- Comparison with condensate samples would be interesting
 - Not enough points for comparison currently

Summary

- Real-time environmental monitoring on ISS is necessary to provide data in a timely fashion and to help ensure astronaut health
- Current real-time water TOC monitoring provides high-quality trending information, but compound-specific data is needed
- The combination of ETV with the AQM showed that compounds of interest could be liberated from water and analyzed in the same manner as air sampling
- Calibration of the AQM using water samples allowed for the quantitative analysis of ISS archival samples
- Some calibration issues remain, but the excellent accuracy of DMSD indicates that ETV holds promise for as a sample introduction method for water analysis in spaceflight
- Analysis of atmospheric data shows presence of DMSD, but no direct correlation with TOC

Acknowledgements

- Funding: FY2014 Center-Level IR&D; Bioastronautics Contract # NAS 9-02078
- Herb Hill group – Washington State Univ.
- Dr. Ching Wu – Excellims Corp.
- Jeff Rutz – Wyle Environmental Chemistry Labs
- Debrah Plumlee – Wyle Environmental Chemistry Labs
- Dr. Mike Kuo – Wyle Environmental Chemistry Labs
- Office of the Chief Technologist at JSC

