



Self-Repairing Fatigue Damage in Metallic Structures for Aerospace Vehicles Using Shape Memory Alloy Self-Healing (SMASH) Technology

Investigators:

M. Clara Wright, NASA KSC¹

Michele Manuel, University of Florida²

Terryl Wallace, NASA LaRC³

Andy Newman, NASA LaRC

Cate Brinson, Northwestern University⁴

Team members: Hunter Henderson², Mike Kessler², Alanna Eilenberg², Oscar Figueroa III^{2,3},
Jeff Sampson¹, Thad Johnson¹, Fernando Reyes-Tirado¹, Pingping Zhu⁴

NASA Aeronautics Research Mission Directorate (ARMD)

2015 LEARN/Seedling Technical Seminar

March 18 & 19, 2015



Outline

- The innovation: SMASH technology
- Liquid-assisted self-healing approach
 - Impact of the innovation
- Results of the Seedling Phases I and II efforts
 - Distribution/dissemination
 - Next Steps



SMASH Technology Concept

- Liquid-assisted healing:
 - Clamping force from the SMA wires
 - Partial liquefaction of the matrix
- Proof of concept on Sn-Bi alloys

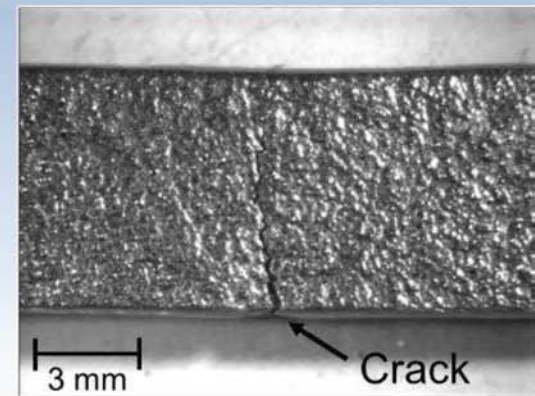
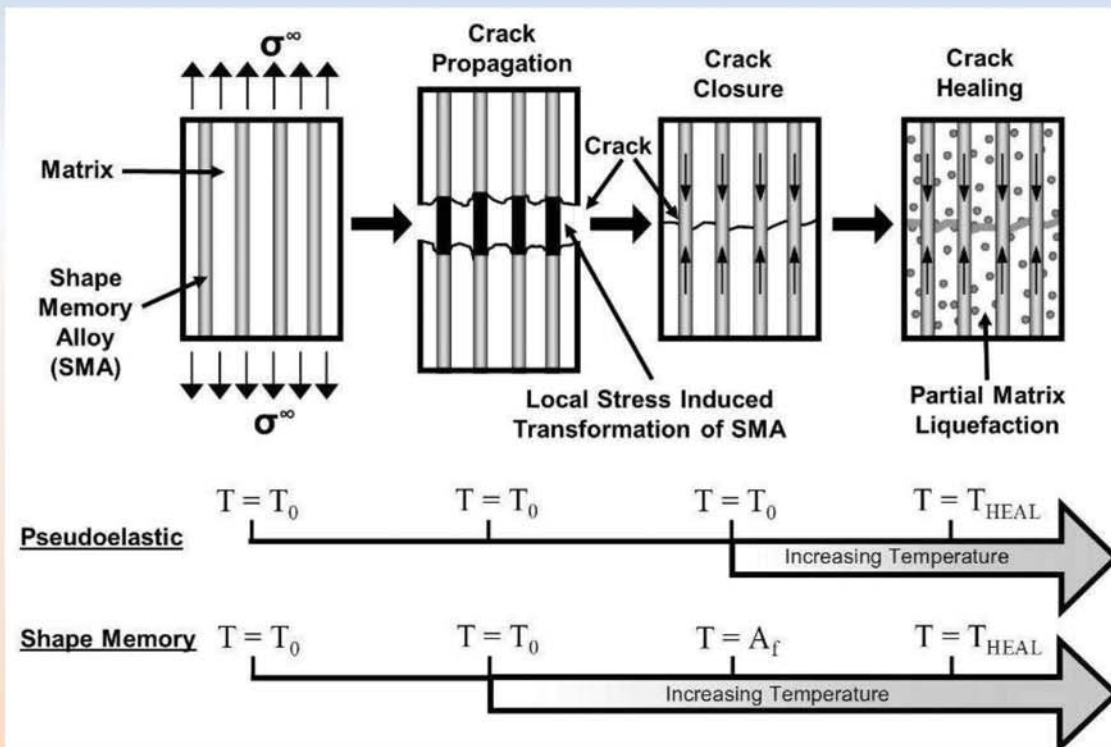

a)

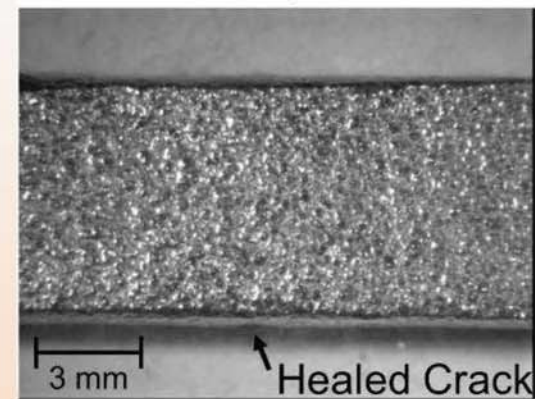

b)

Manuel, M.V, *Principles of Self-Healing in Metals and Alloys: An Introduction, Chapter in Self-Healing Materials: Fundamentals, Design Strategies and Applications*, Ghosh, S. K., Ed. Wiley: 2008;.



SMASH Technology

- Proof of concept: healing cm-long cracks with retention of mechanical properties
 - 95% recovery of ultimate tensile strength

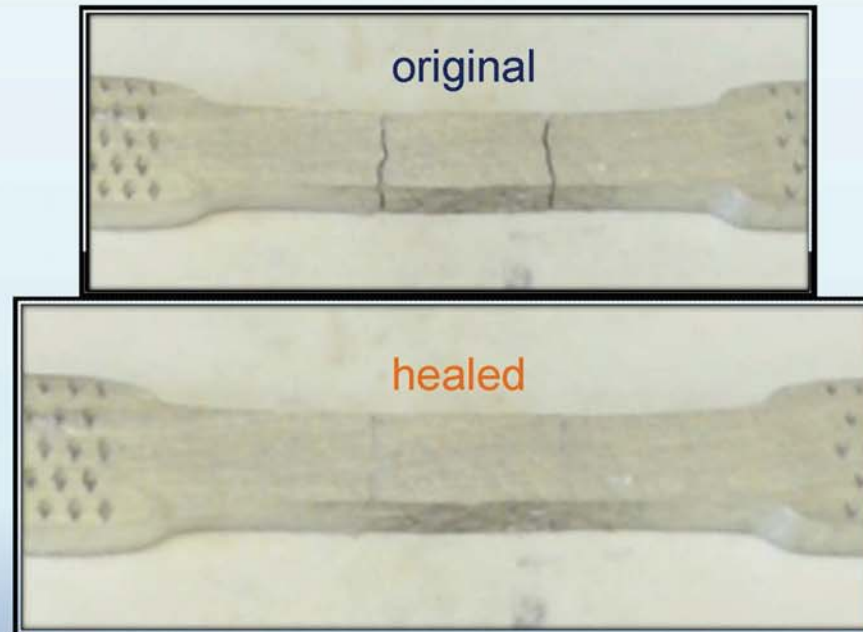

Time-lapse video showing actual healing of two overload cracks on a Sn-Bi dogbone specimen. Healing continues when the specimen is held at temperature and partial matrix liquefaction fills in any remaining gaps in the crack faces.

Technical Approach



- Liquid-assisted healing of fatigue cracks
- Thermodynamic design of matrix
 - Binary and Ternary alloy design
 - Optimization of healing parameters
 - Optimization of microstructure and mechanical properties
- Complex specimen fabrication
 - Multi-layer specimens
- Numerical modeling
 - Model validation
 - Reinforcement architecture

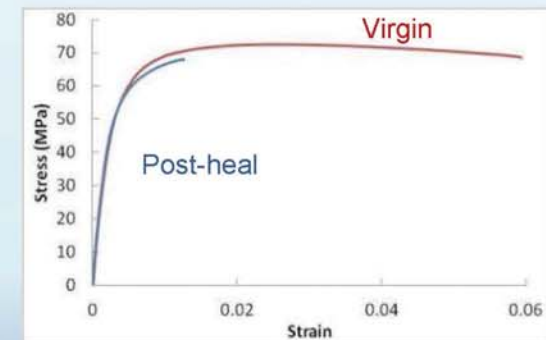
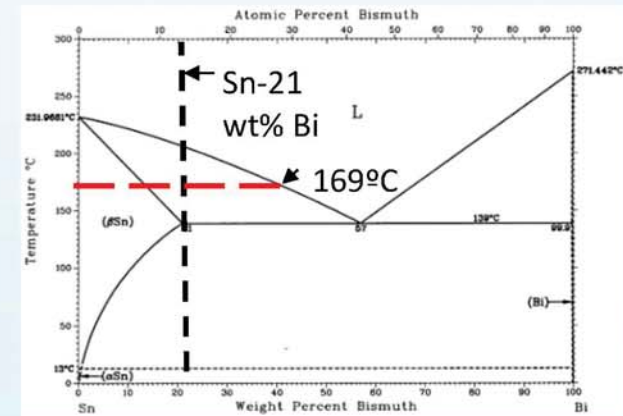

Proof of concept material (top) and mechanical properties of cast Al-Si material (bottom)



Impact of Innovation

- Wrought and cast Al alloys used throughout aircraft
 - Fatigue and fatigue crack growth at high cycles is concern.
- Improve damage tolerance and fatigue life of metals at critical structural locations
- Integrated self-repairing approach would improve durability and sustainability of the aerospace material to ensure vehicle safety

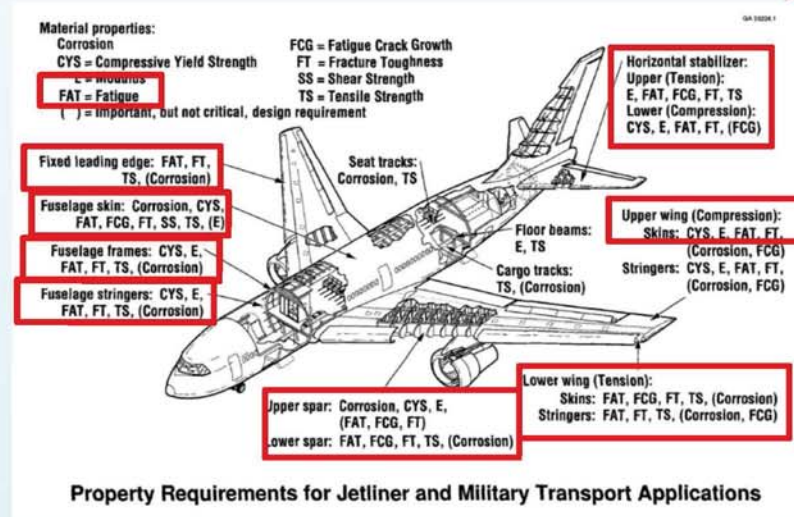

Heinimann et al, Alcoa, "Advanced Metallic and Hybrid Structural Solutions for Light-Weight, Long-Lived Aerospace Structures Aircraft Airworthiness & Sustainment Conference 2012



Results from Phase I

- Self-repair of Al matrix materials
- Fatigue crack repair
- 90% recovery of UTS after healing
- Multiple healing cycles achieved

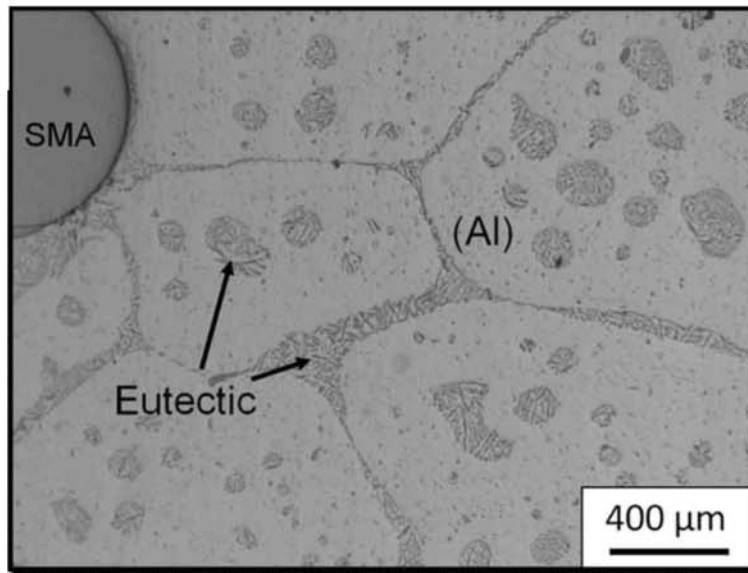

Adequate Al-Si microstructure for healing treatment

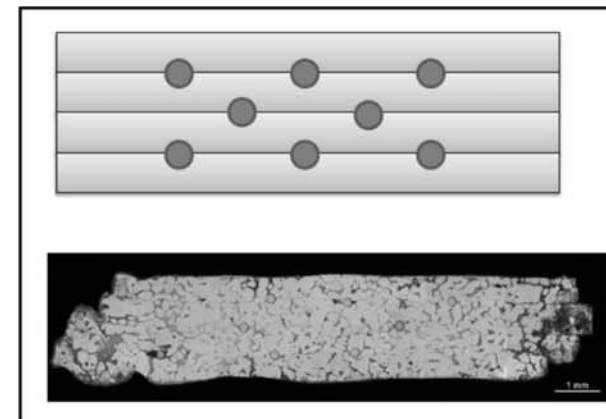
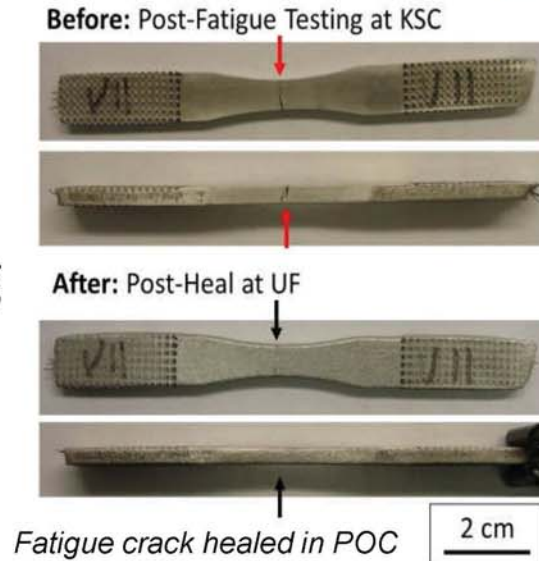

Small-scale multi-ply Al-Cu-Si specimen

Phase I Fatigue Testing Results



- Fatigue testing of matrix material after various healing cycles to study liquid-assisted portion of healing.

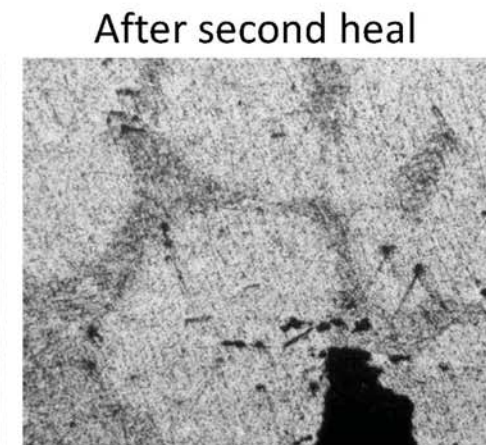
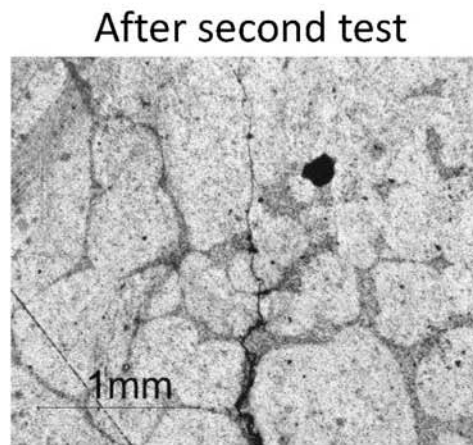
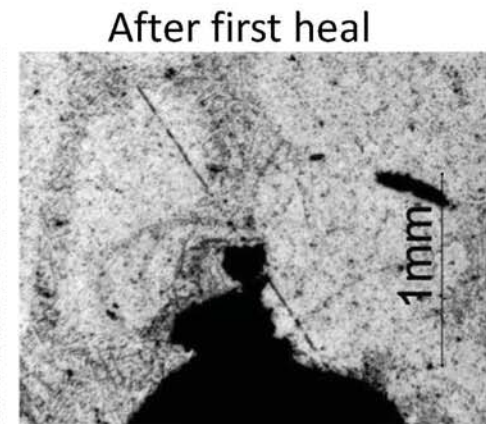
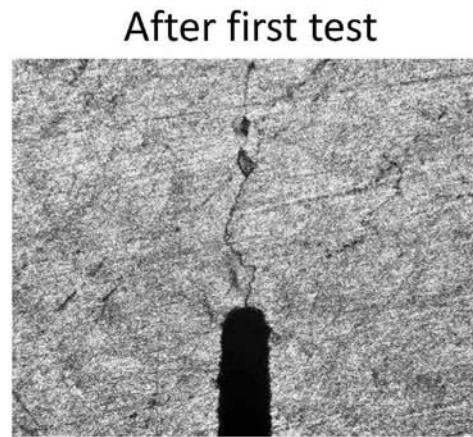
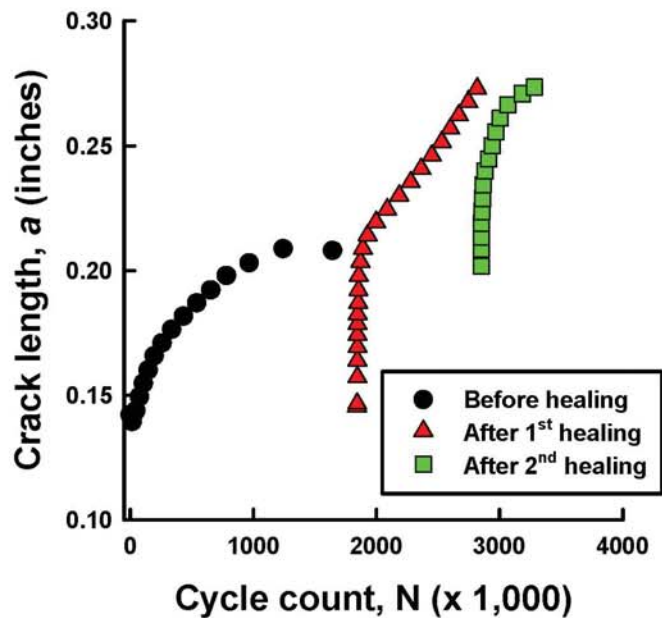

Phase II Results: Fabrication Technique



- Improved upon diffusion bonding technique developed during Phase I by consolidating using vacuum hot pressing (VHP)
 - Larger scales
 - Alignment fixtures
 - Multi-step processing
 - Optimized pressures and temperatures
- Allowed for fabrication of more complex test specimens
- Ensured adequate SMA reinforcement by X-ray and computed tomography (CT)



VHP specimens



EDM of VHP dogbone



CT scan of VHP dogbone

Phase II Results: Fabrication Technique

- VHP samples had a similar microstructure to the cast samples with a decrease in porosity.
- Diffusion bonding interface around wires and between “slices” of matrix material were adequate.
 - Slight bonding line visible, but no contaminants were identified at the interface.



Phase II Results: Healing overload cracks



- Increase in ductility when compared to cast samples from Phase I
 - Resulted in necking of test specimen
 - Healing treatment showed filling of crack

Comparison of cast and healed mechanical properties

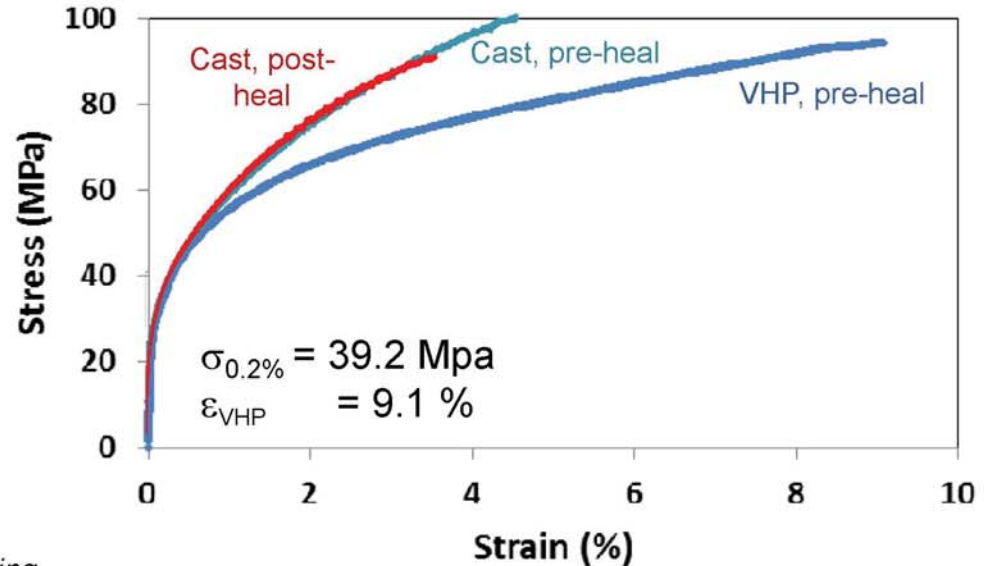

Cast overload sample pre- and post-healing



VHP overload sample pre-healing

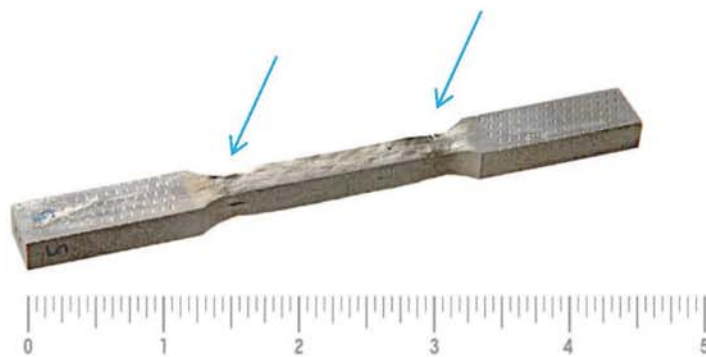

VHP overload sample pre- and post-healing

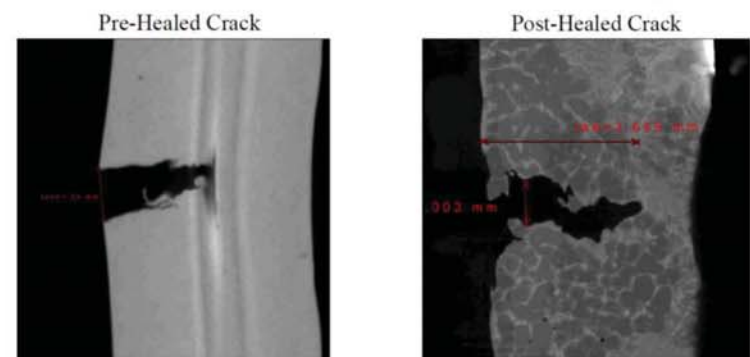

Phase II Results: Driver for treatment optimization



- CT stills showing diffusion front of wire within healed overload composite

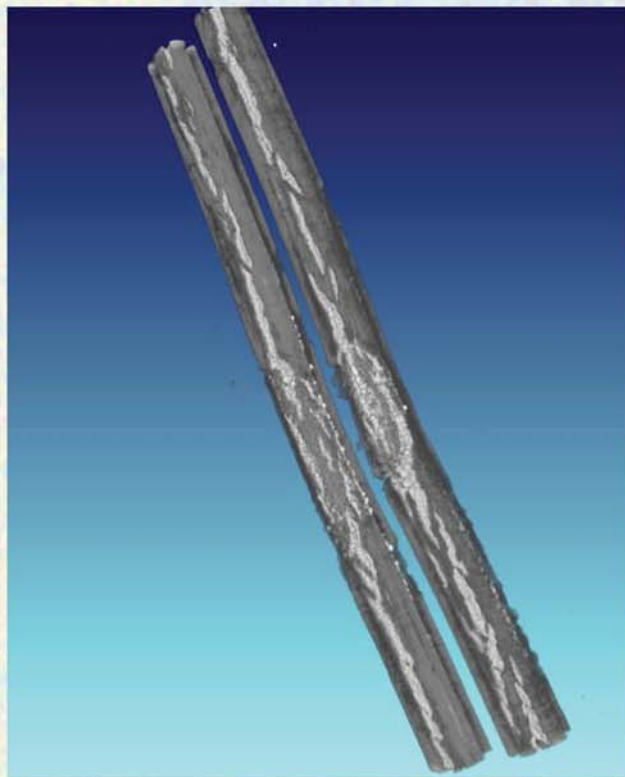

VHP overload sample post-healing (SMA reinforcements)

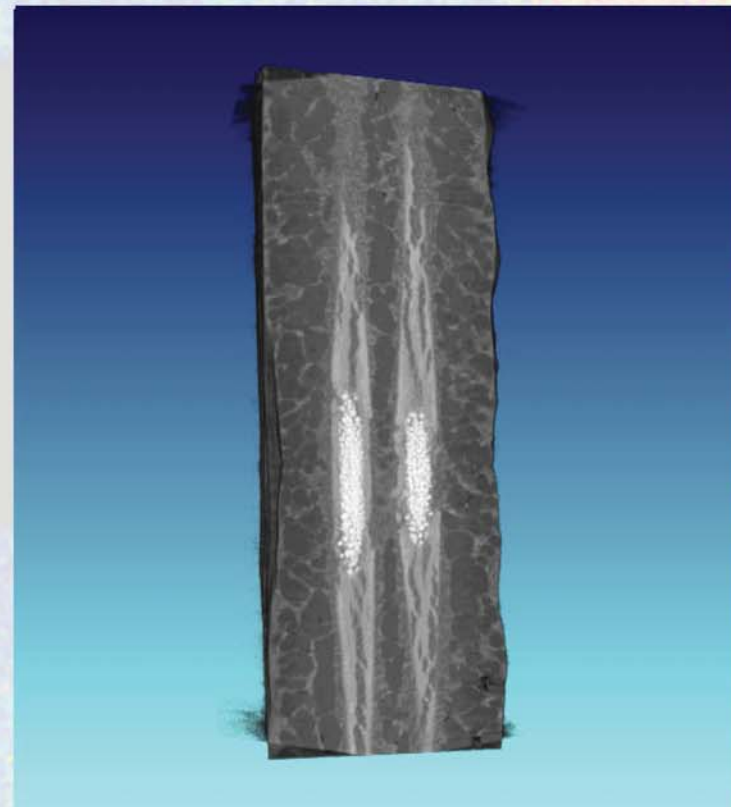

VHP overload sample post-healing

Phase II Results: Driver for treatment optimization



- Non-destructive CT vs. destructive metallography showing diffusion of SMA constituents into matrix.

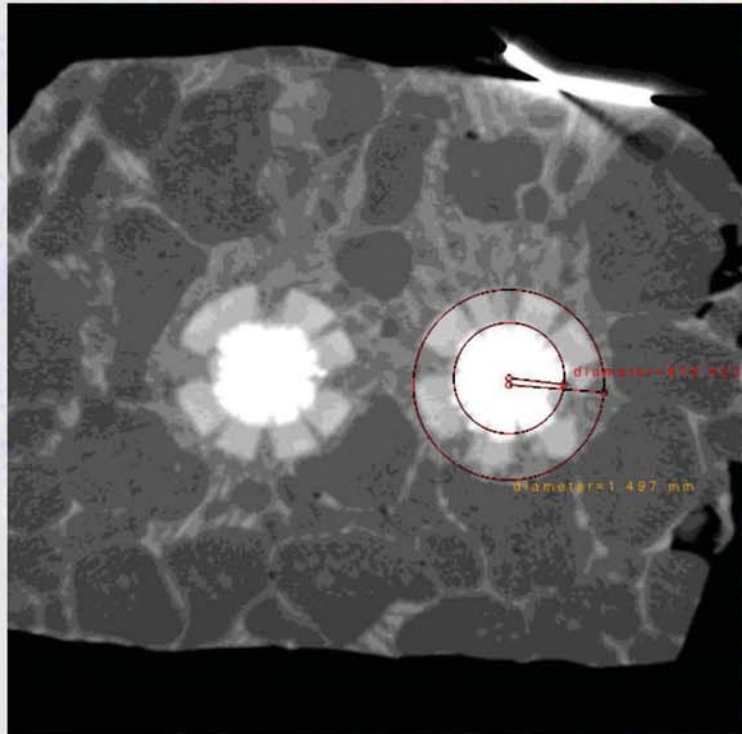

CT of VHP overload sample post-healing

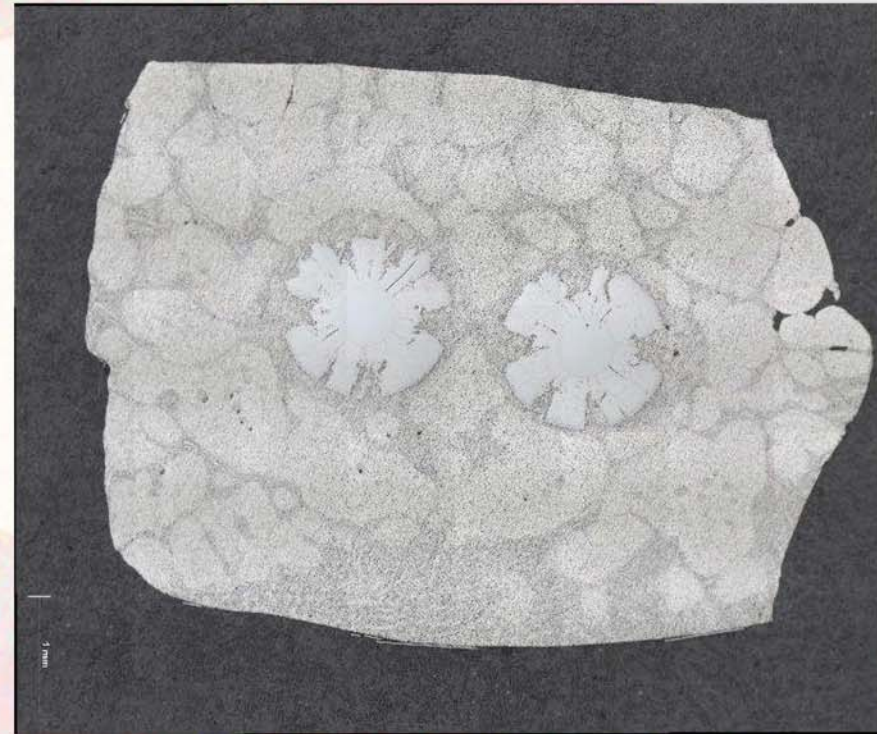

Metallographic specimen of VHP overload sample post-healing

Phase II Results: Driver for treatment optimization

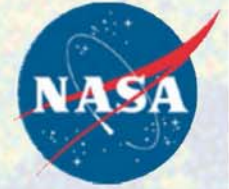

- Sacrificial damage of SMA with original healing treatment

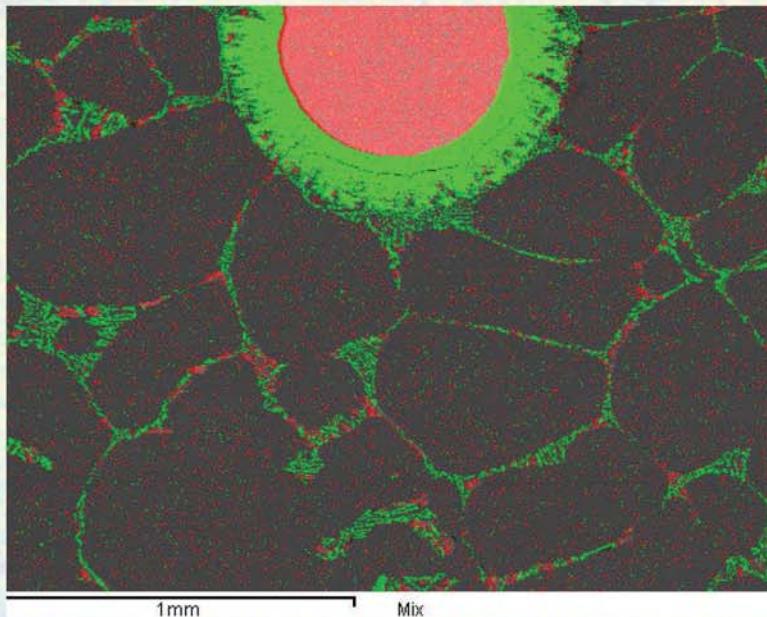
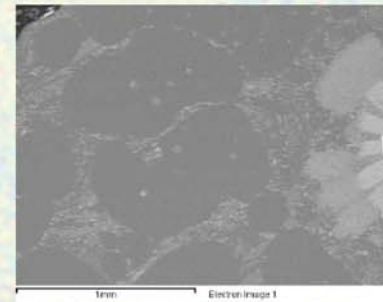

X-ray dot map of VHP sample after 24-hr healing treatment. Red = Ni, Green = Si

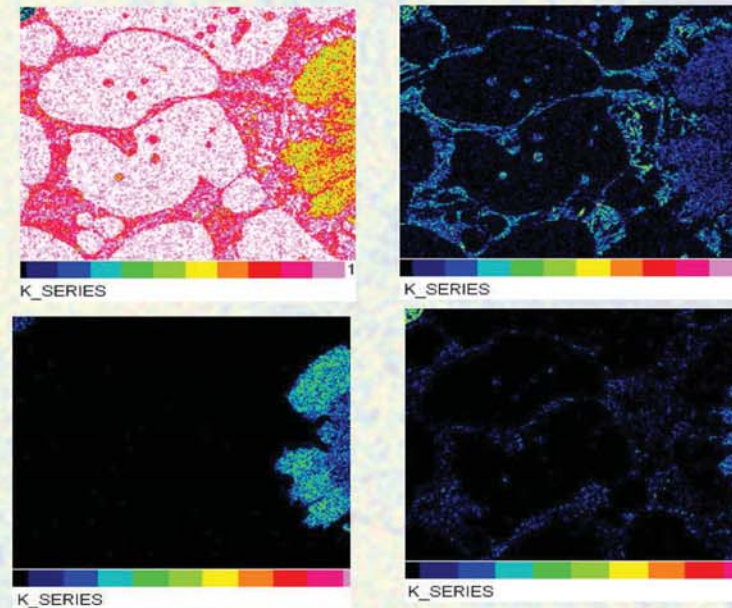

X-ray dot maps of VHP sample after 24-hr healing treatment. Al, Si, Ti, and Ni shown

Phase II Results: Healing Treatment Optimization



- Optimization of:
 - Microstructure
 - Mechanical properties
 - Healing treatment

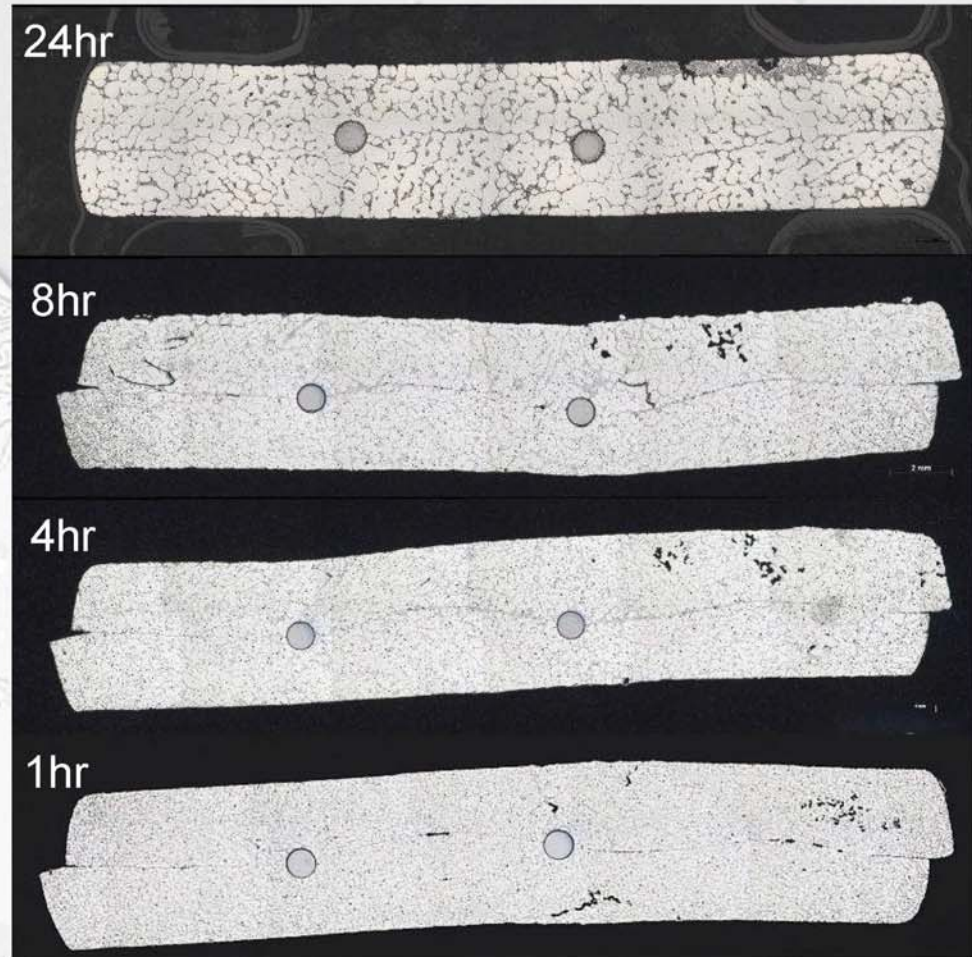

VHP specimens after healing treatment for various time periods.

Phase II Results: Healing Treatment Optimization



- Optimization of:
 - Microstructure
 - Mechanical properties
 - Healing treatment

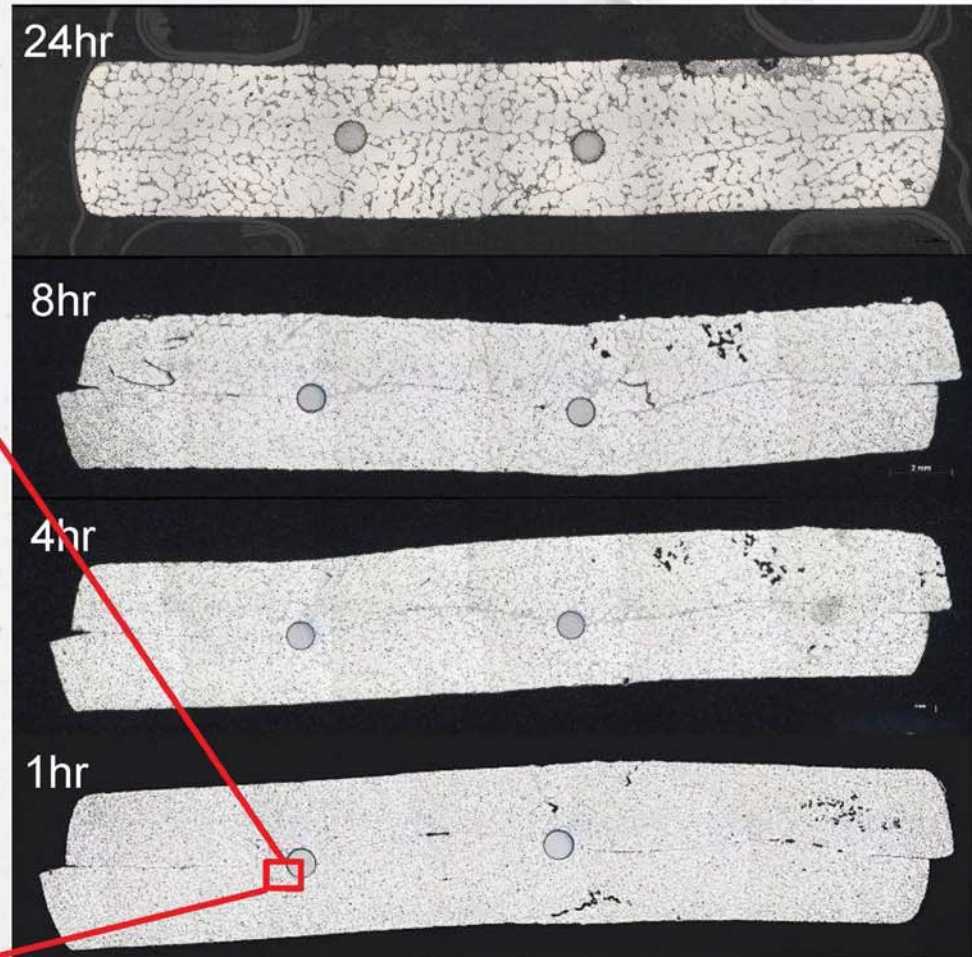
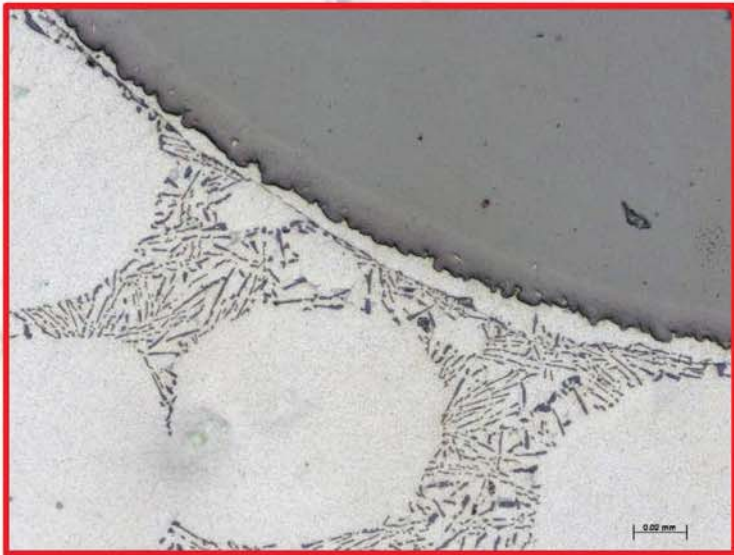

VHP specimens after healing treatment for various time periods.

Phase II Results: Healing Treatment Optimization



- Optimization of:
 - Microstructure
 - Mechanical properties
 - Healing treatment

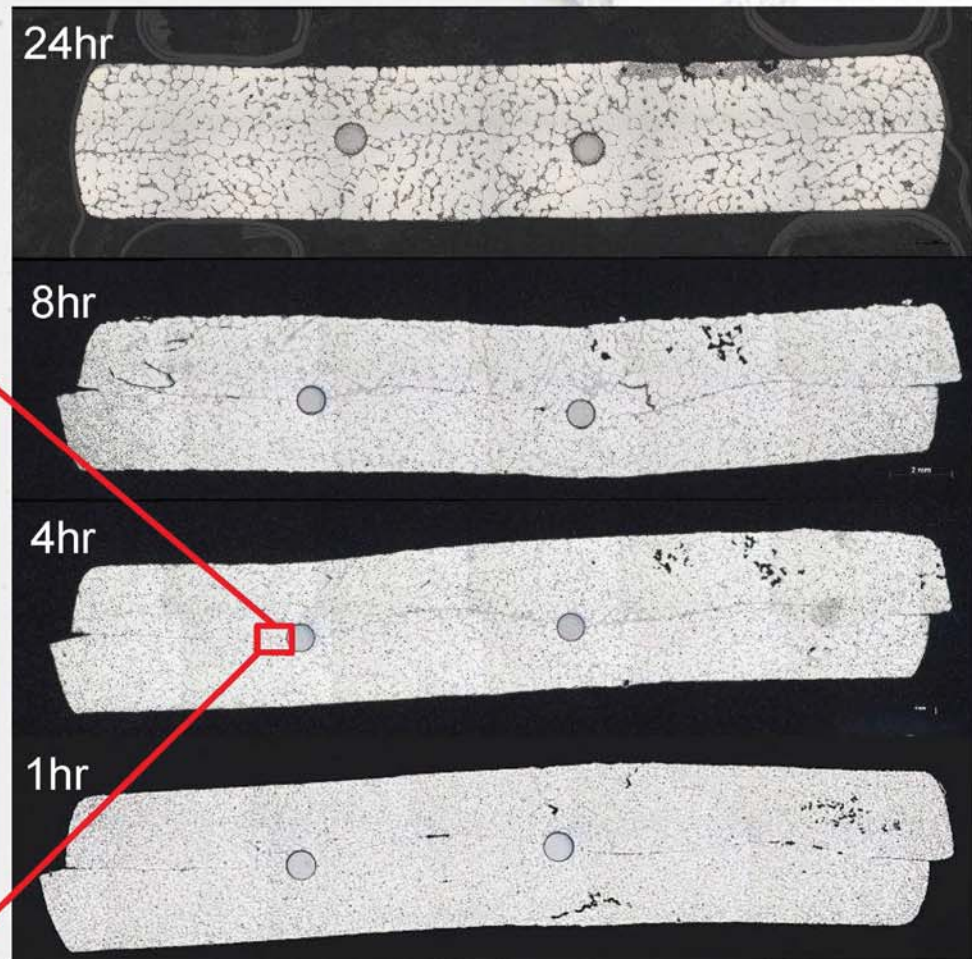
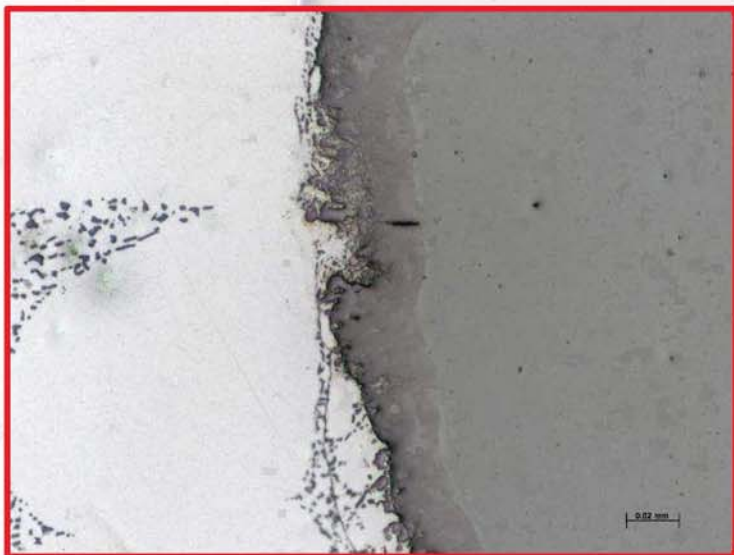

VHP specimens after healing treatment for various time periods.

Phase II Results: Healing Treatment Optimization



- Optimization of:
 - Microstructure
 - Mechanical properties
 - Healing treatment

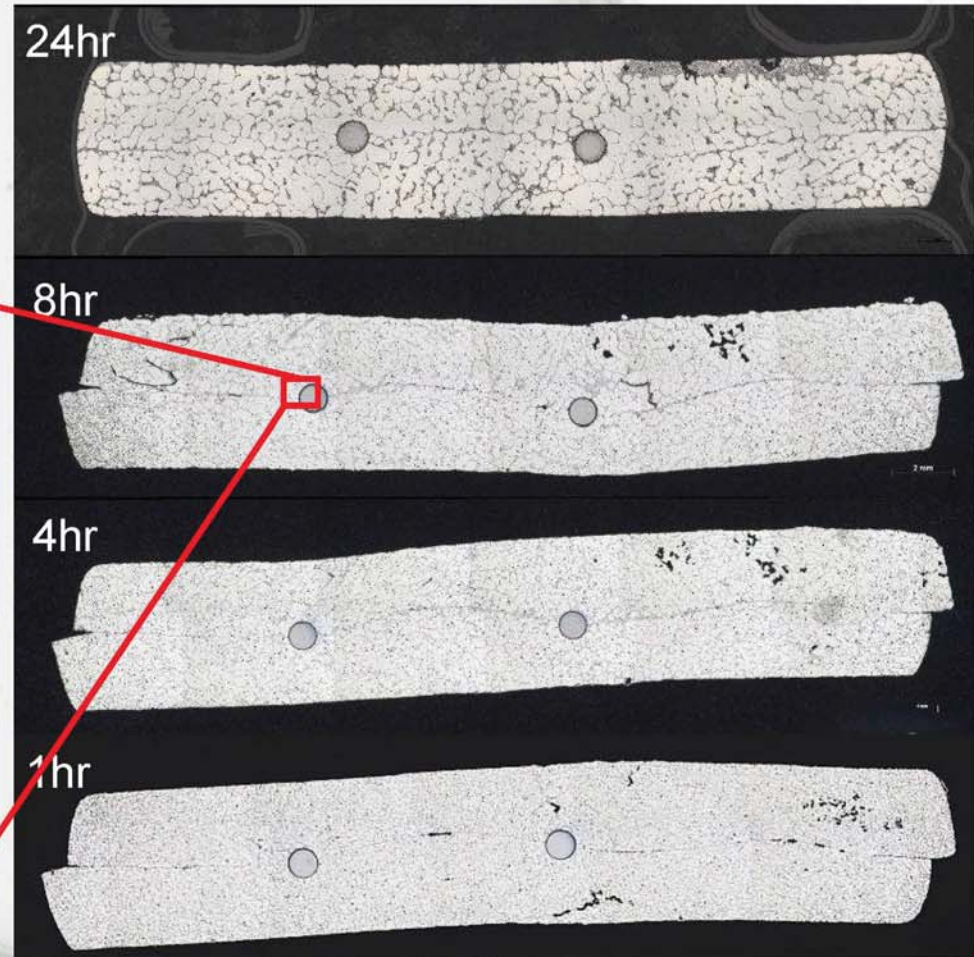
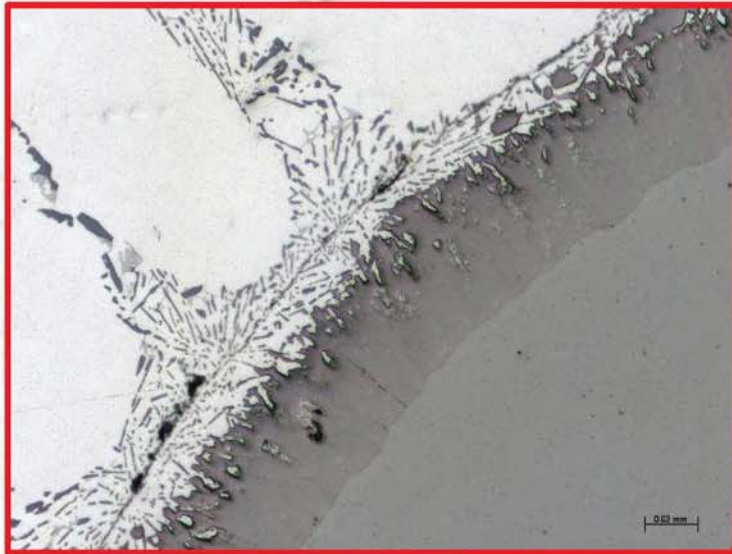

VHP specimens after healing treatment for various time periods.

Phase II Results: Healing Treatment Optimization



- Optimization of:
 - Microstructure
 - Mechanical properties
 - Healing treatment

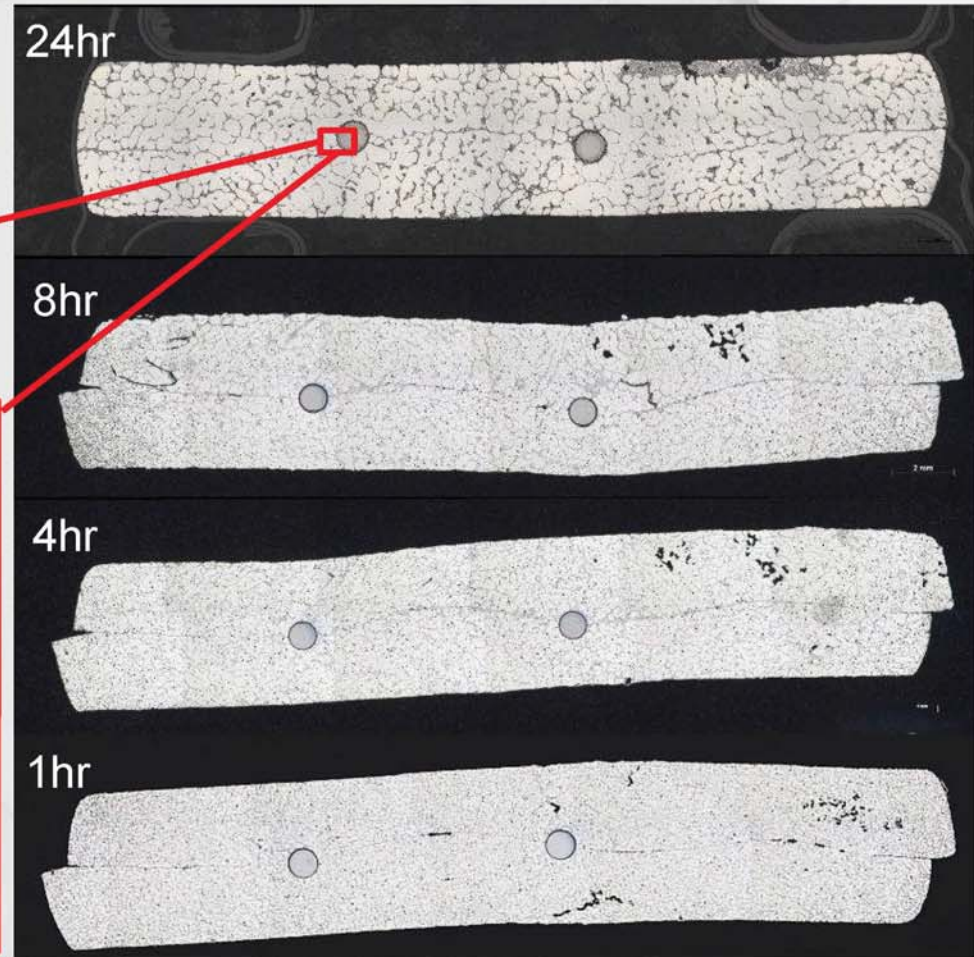
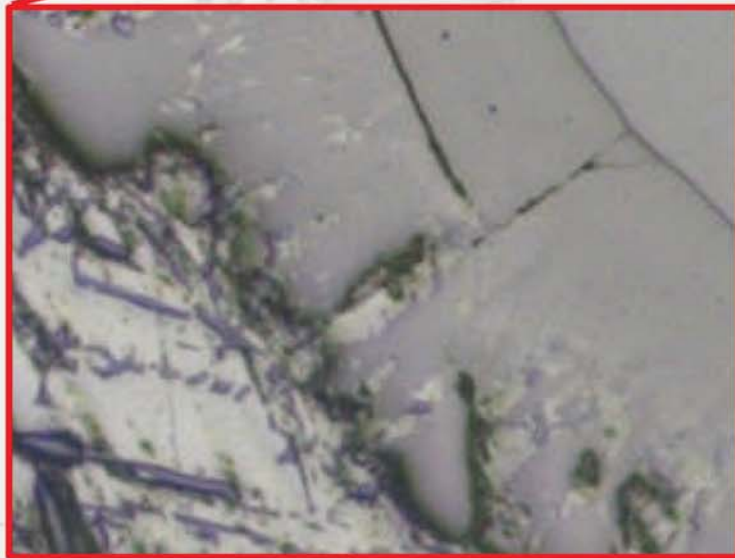

VHP specimens after healing treatment for various time periods.

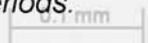

Phase II Results: Healing Treatment Optimization



- Optimization of:
 - Microstructure
 - Mechanical properties
 - Healing treatment

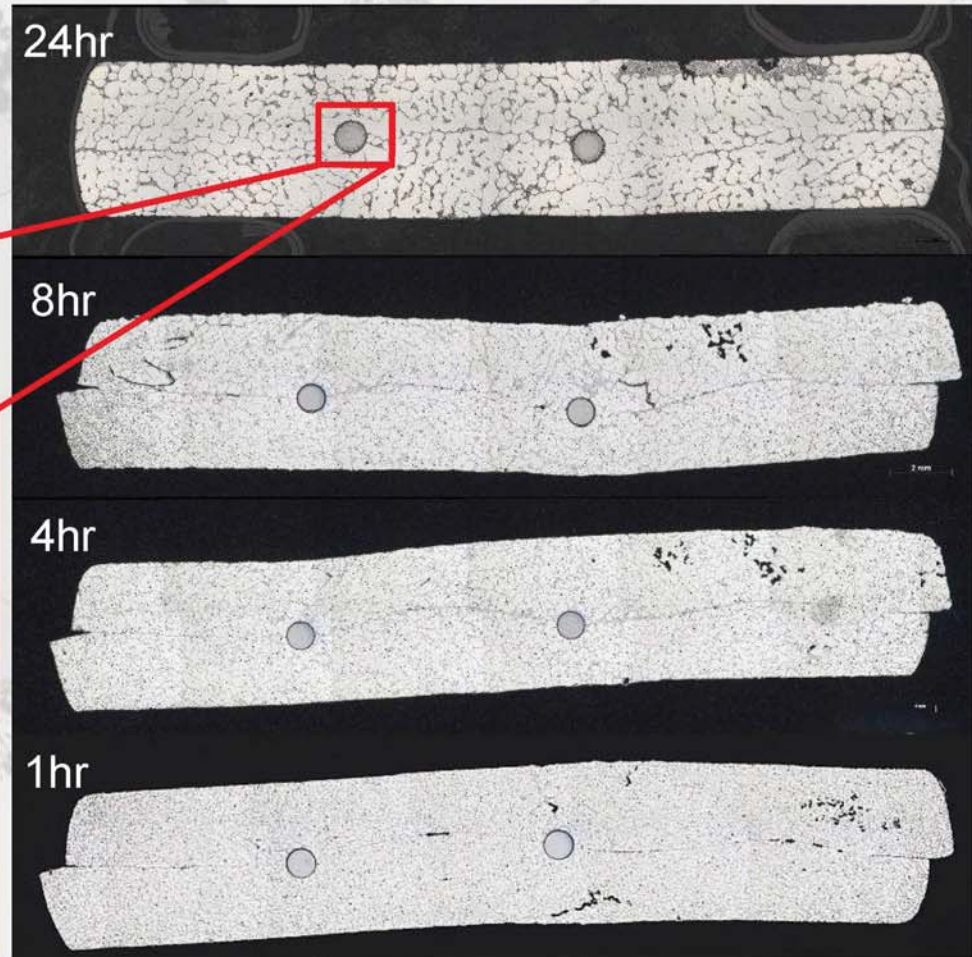
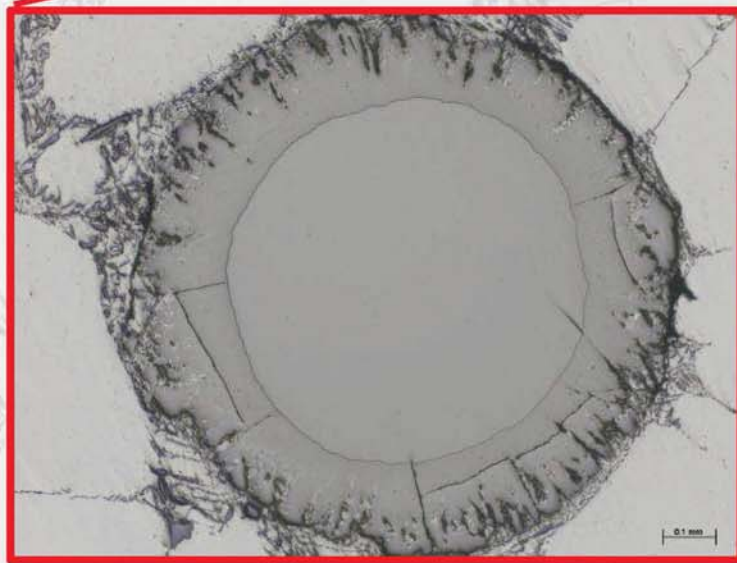

VHP specimens after healing treatment for various time periods.

Phase II Results: Healing Treatment Optimization



- Optimization of:
 - Microstructure
 - Mechanical properties
 - Healing treatment
- Grain growth and diffusion vs. mechanical properties

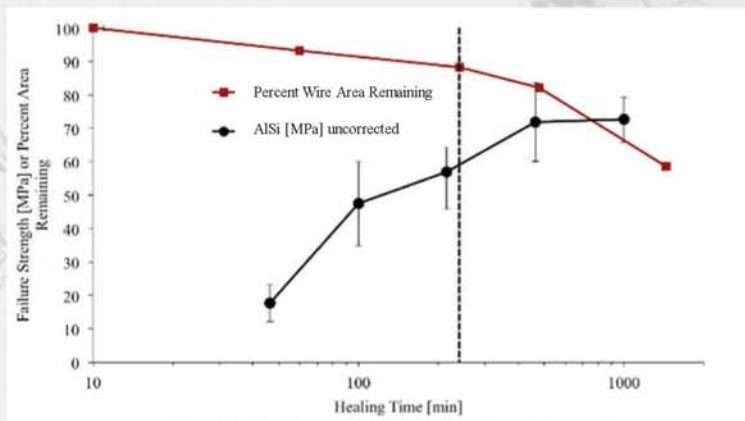

Optimization of healing treatment

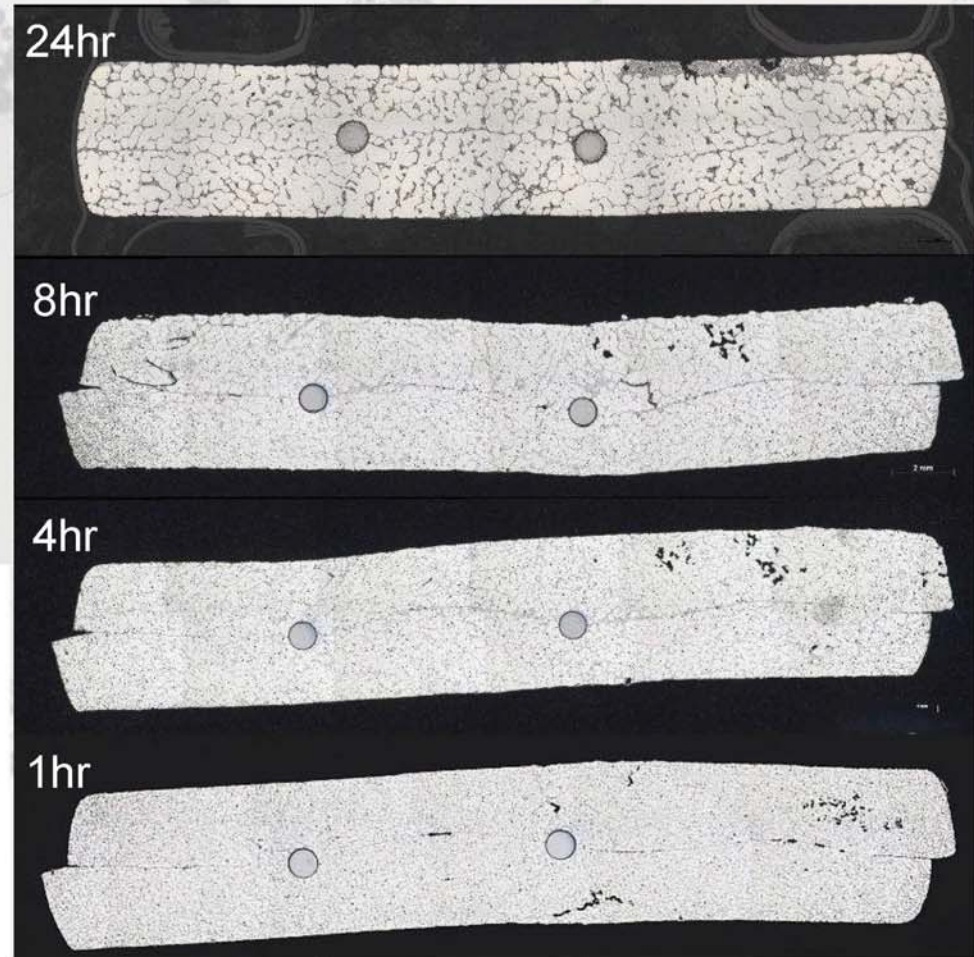

VHP specimens after healing treatment for various time periods.

Phase II Results: Fatigue Crack Growth



- Edgewise single edge notch tension ESE(T) specimens tested by compliance control to grow and heal a small fatigue crack.
 - Surface strain measurements via visual image correlation (VIC-3D)
- FCG specimens were pre-cracked, tested, healed, and re-tested.
 - High-temperature speckle pattern was used to continue strain measurements after healing treatment.

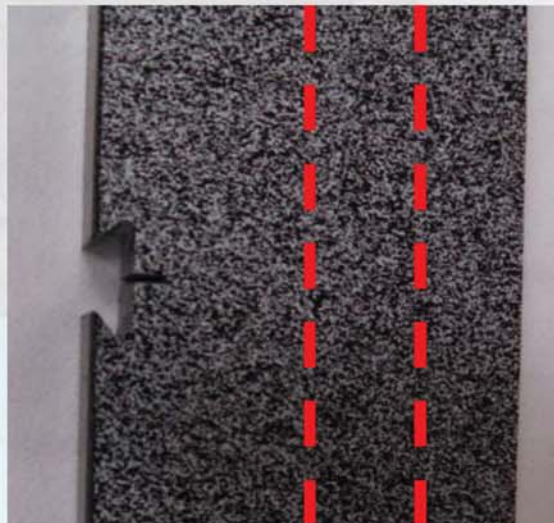

ESE(T) specimen with speckle paint and relative location of SMA reinforcements.

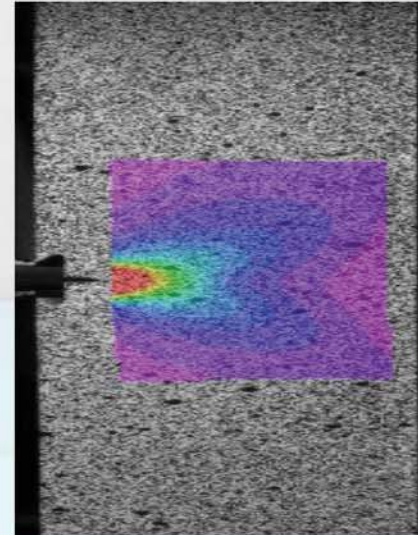

ESE(T) specimen during FCG test with VIC data superimposed.

Phase II Results: Fatigue Crack Growth



- Pre-healing treatment CT

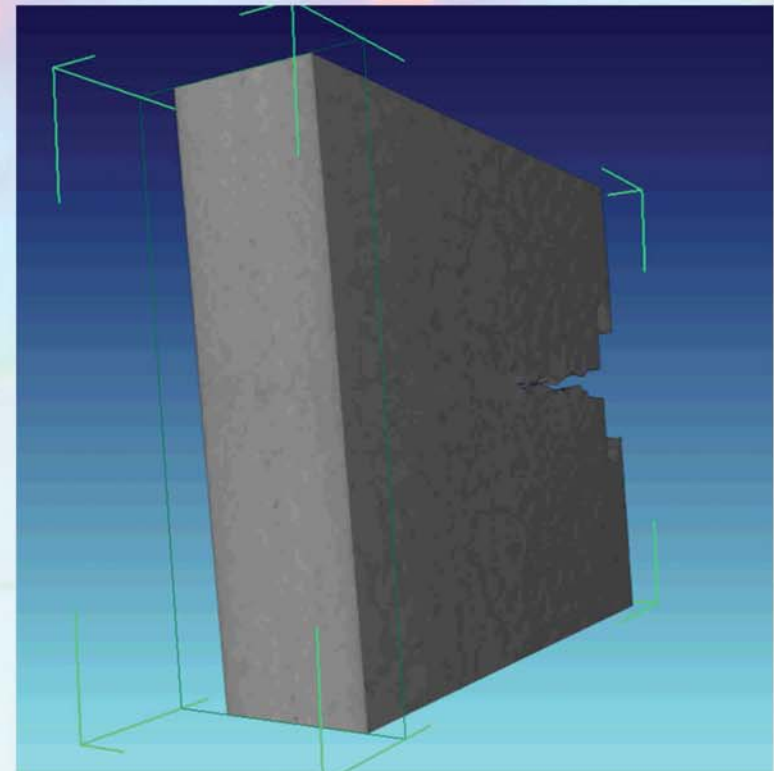
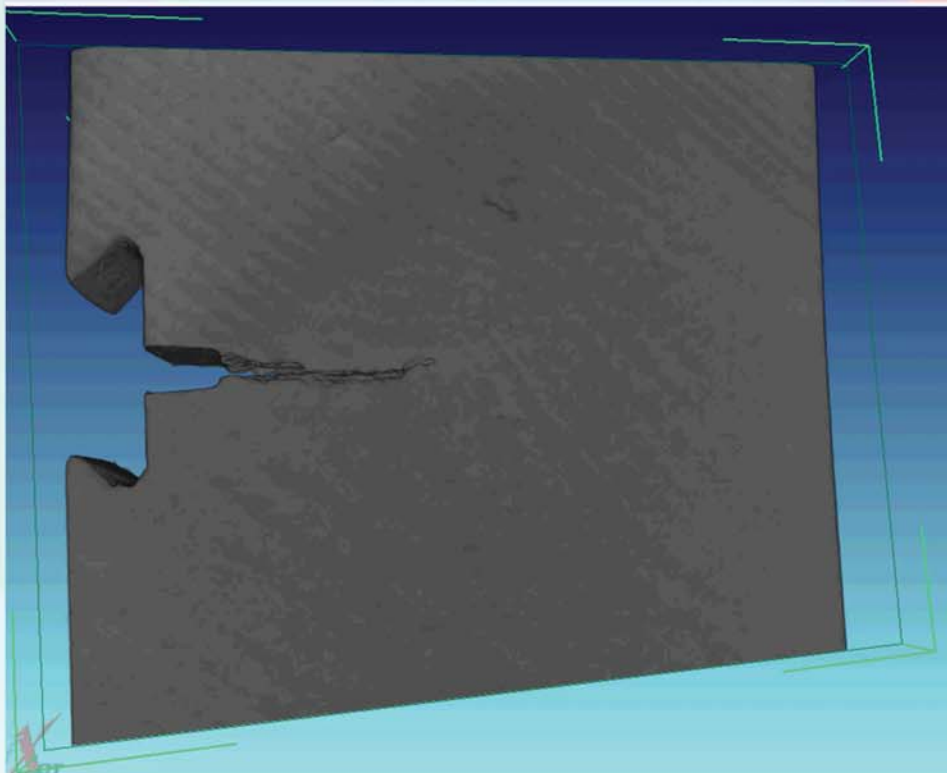

CT movies of ESE(T) FCG specimen pre-healing treatment.



Phase II Results: Fatigue Crack Growth

- Strain fields during first fatigue test, after healing, and at the end of the second fatigue test.

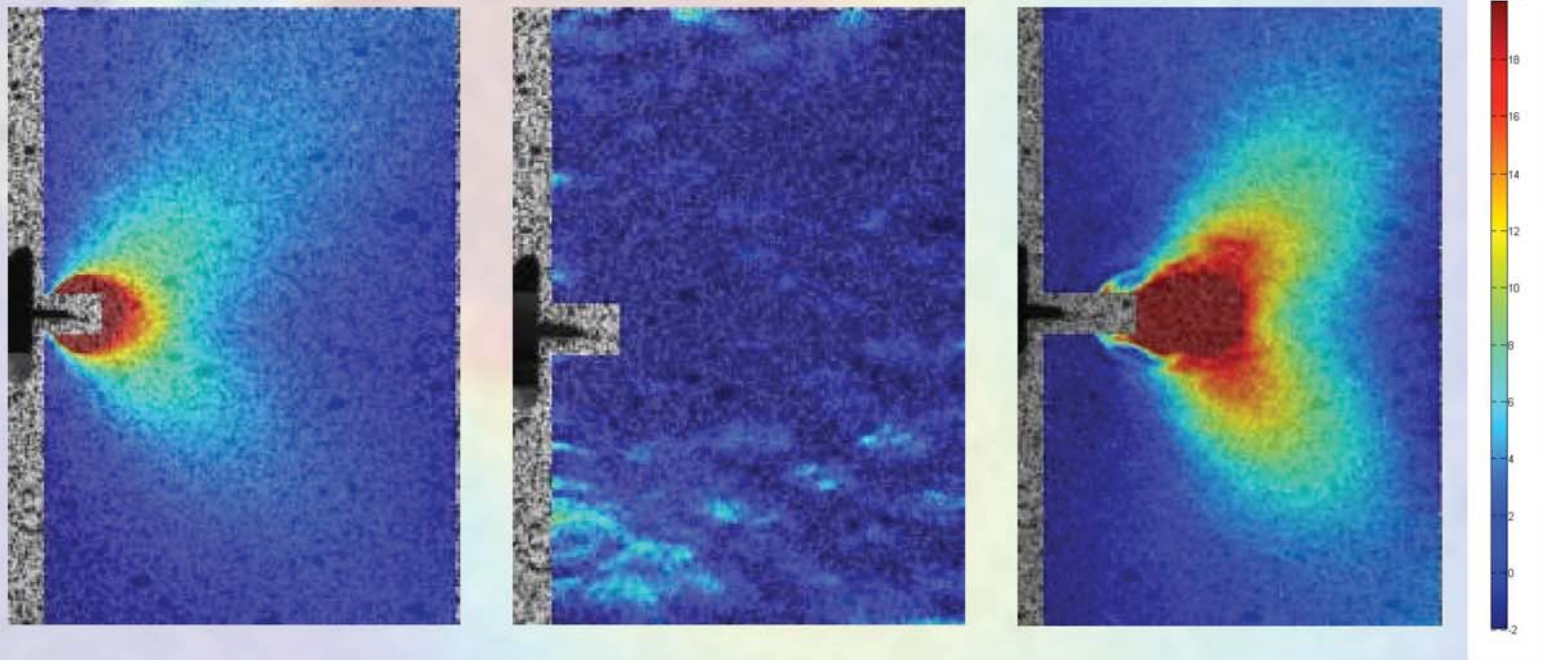

VIC strain field data of ESE(T) FCG specimen pre- and post-healing treatment.



Phase II Results: Modeling

- Modeled composite using various loading scenarios, SMA compositions, wire placement, continuous vs. discontinuous wire lengths, and wire pre-strain.
 - Evaluated plasticity induced on the matrix and wires from loading, unloading, and heating to healing temperatures.
 - Evaluated ability of SMA wires to force crack closure in the SMASH materials system.

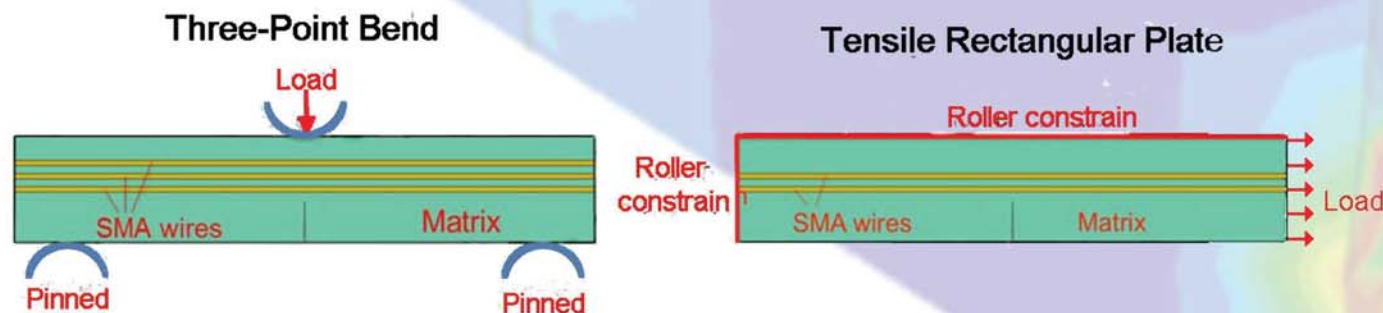

Phase II Results: Validation of Model



- Empirical and model of metal matrix composite 3-point bend tests were in agreement
 - True test data, including material properties at different temperature regimes, was used in the model.
 - Simulation of crack opening displacement (COD) after unloading is in good agreement with the test measurements.
 - Final COD after loading:
 - Model: 0.17 mm
 - Experimental: 0.15 mm

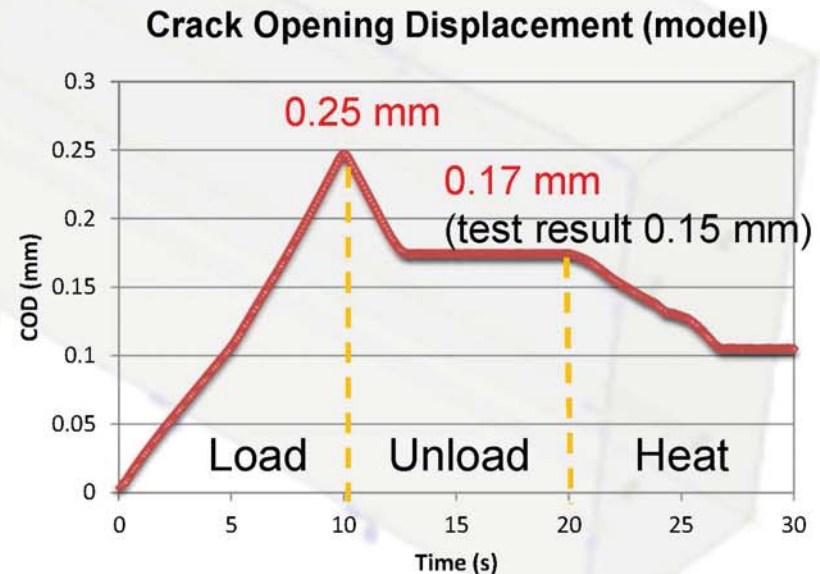
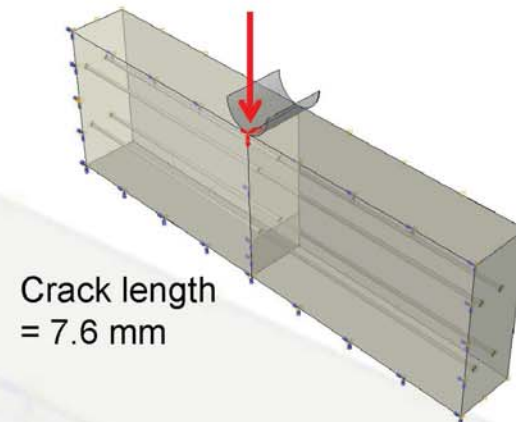

E = 65 GPa for Sn-Bi matrix



Phase II Results: FEA

- FEA showing stress evolution (von-Mises, MPa) upon loading, unloading, and heating.

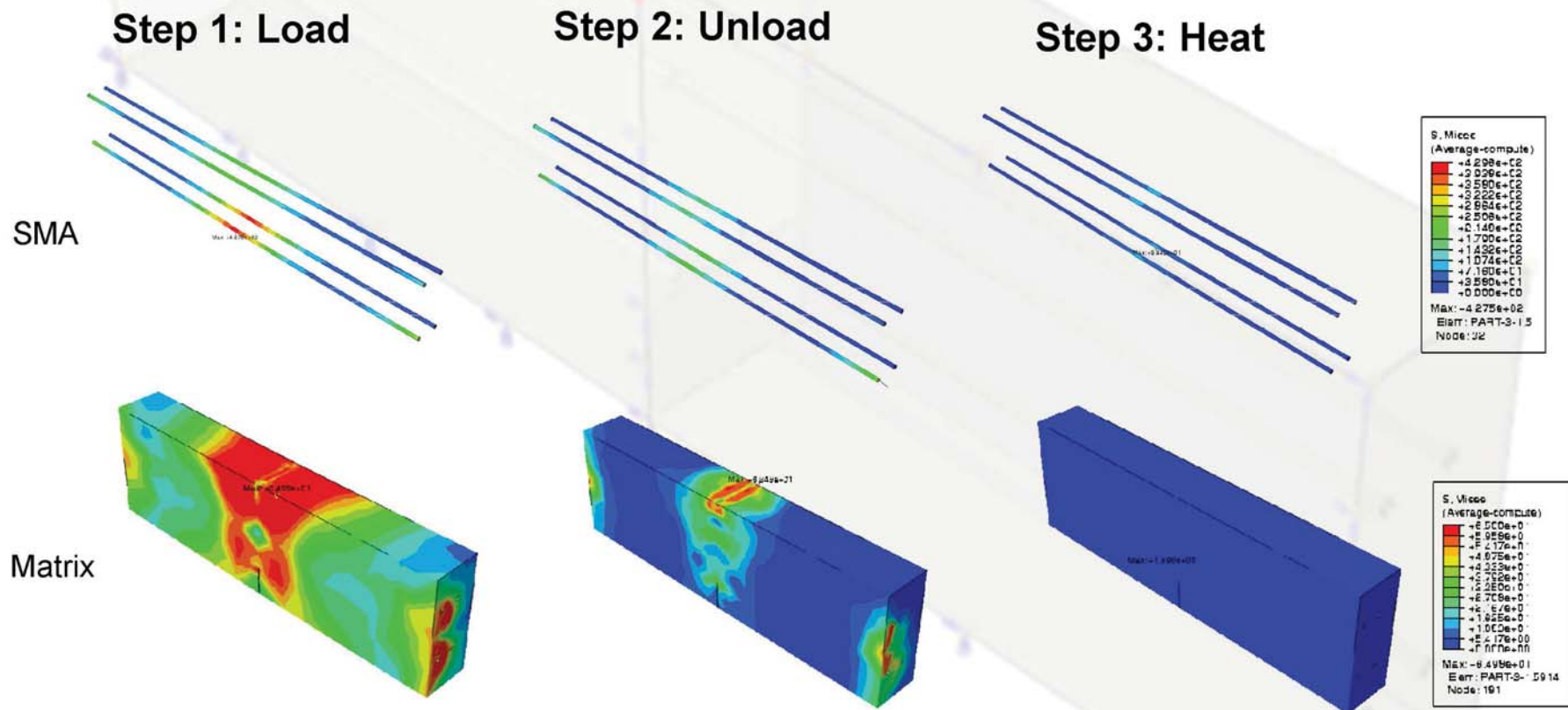

Applying FEA to Fabrication of Complex Specimens



- 3-D model

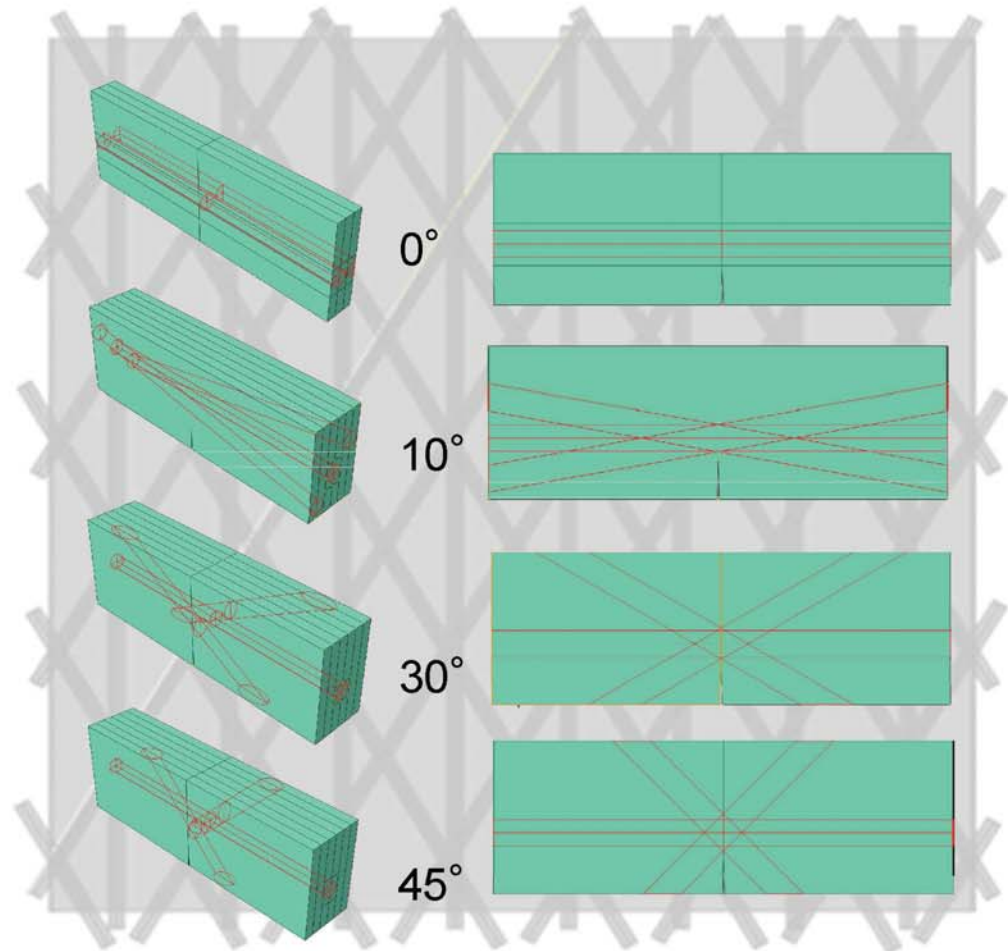
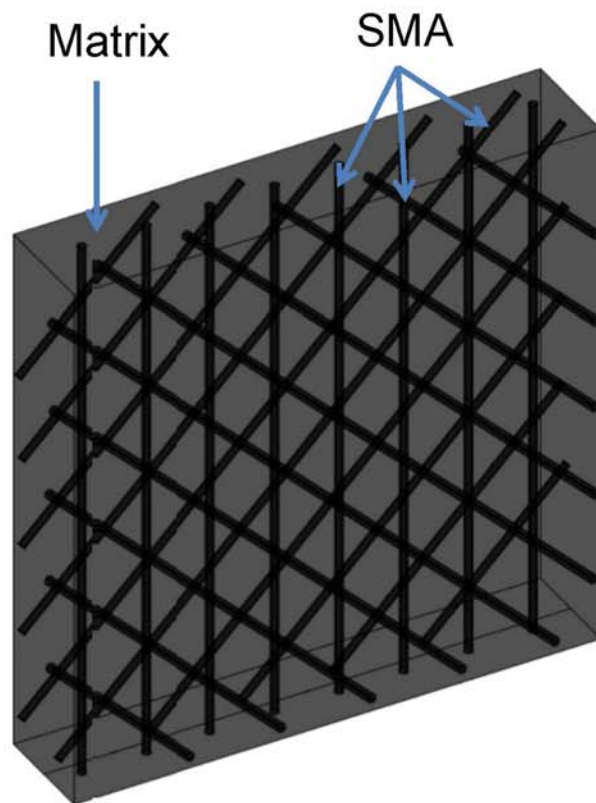

Applying FEA to Fabrication of Complex Specimens



- FEA was used to model two multi-ply hot pressed specimens:
 - -45/0/+45
 - -30/0/+30

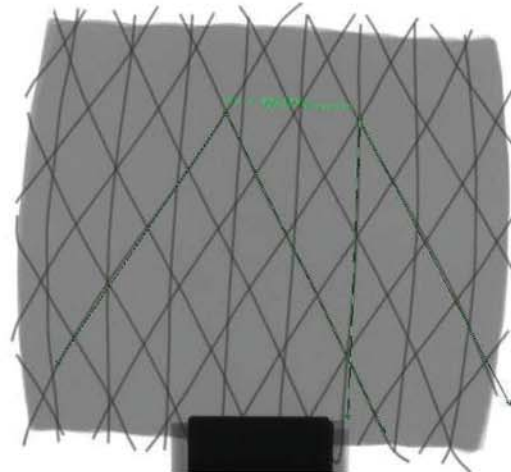
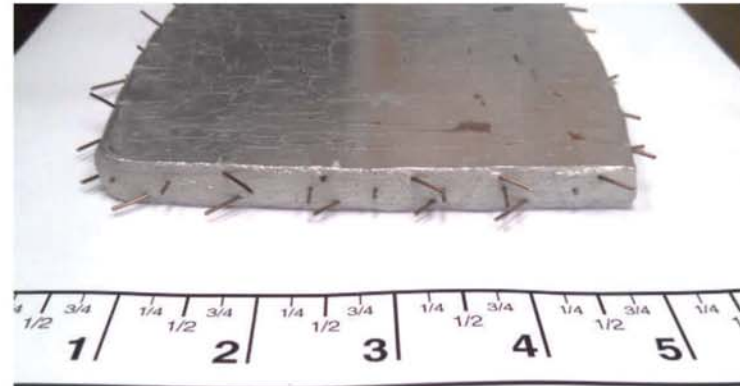

Phase II Results: Using FEA for Extending the Realm of possibilities



- The best wire placement in relation to the crack is perpendicular (0° in figures below)
- Pre-straining reinforcements aids in crack closure

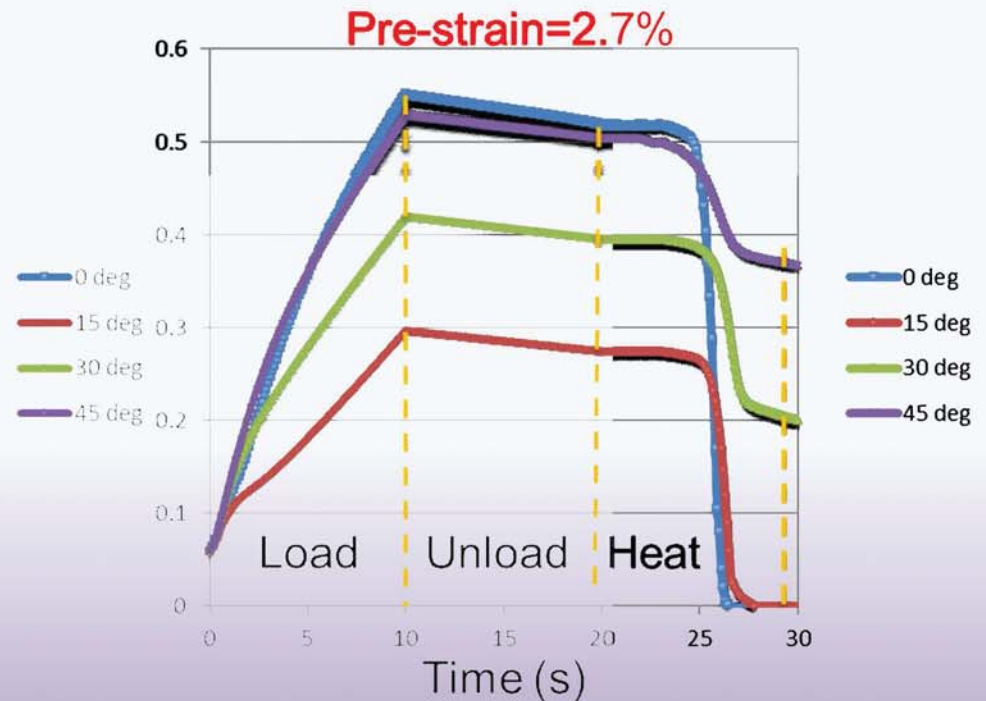
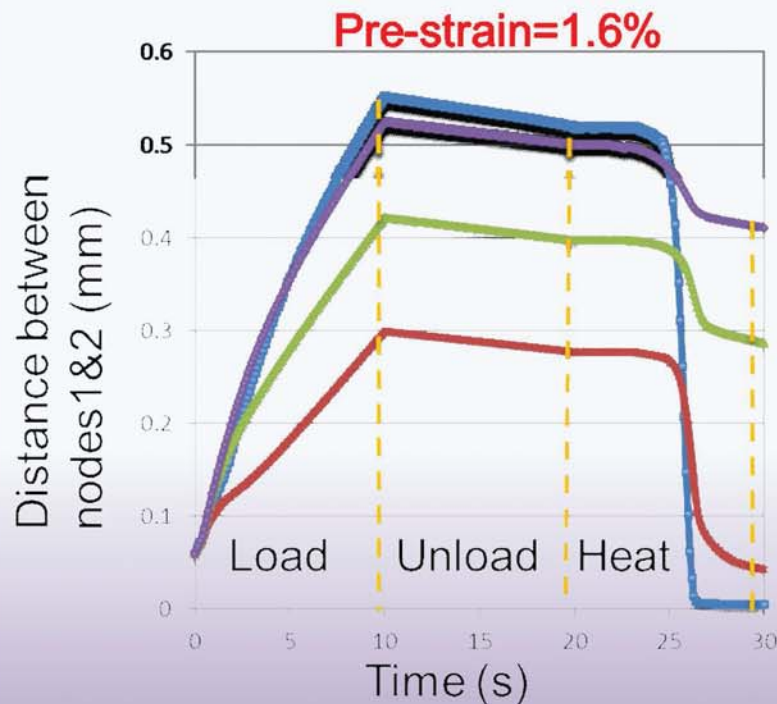

Phase II Results: Using FEA for Extending the Realm of possibilities



- Short vs. Long fibers
 - Continuous vs. discontinuous wire reinforcements were modeled.
 - The best case for crack closure is continuous reinforcements near the crack tip.

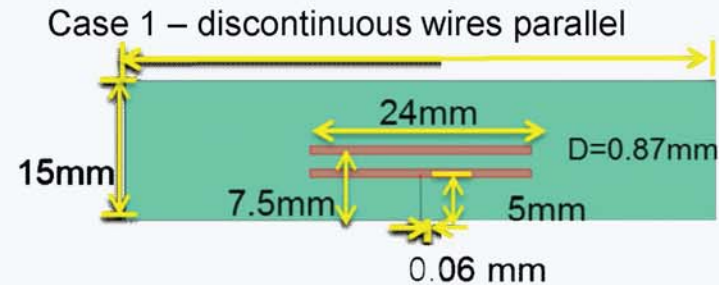
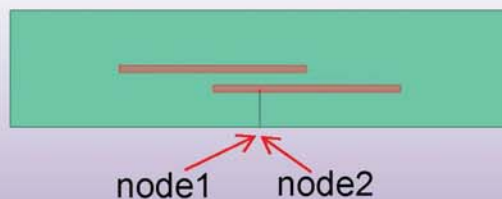
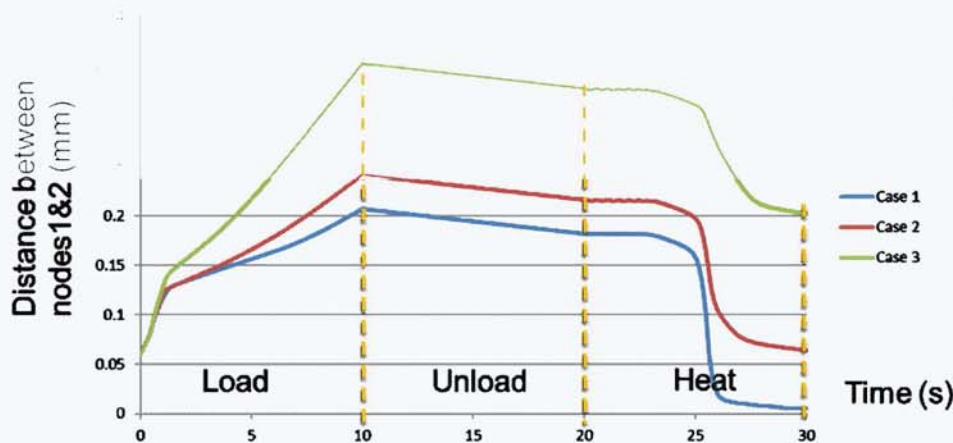

Case 2: discontinuous wires, offset by 12 mm

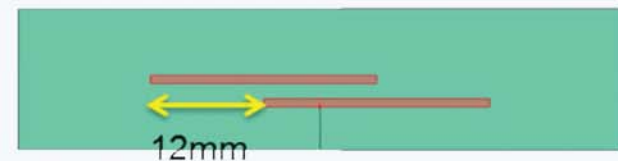

Case 3: discontinuous wires, offset by 20 mm



Phase II Results: Matrix Alloy Design



- Al-Cu and Al-Cu-X systems
- Liquid-assisted step in healing:
 - Eliminates work hardening and grain refinement
 - Leaves precipitation hardening and solid solution strengthening
- Candidates:
 - Al-Cu-Mg alloys that can precipitate the high-strength S-phase and its metastable precursors
- Heat treatment:
 - Cast, solution treat, quench, and age to peak strength.
 - Healing treatment performed on diffusion couples
 - Perform heat treatment again.

Distribution/Dissemination

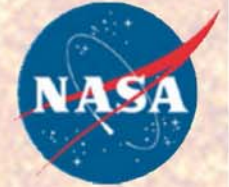

- Patents:
 - A provisional patent application titled *"Self-Repairing Metal Alloy Matrix Composites, Methods of Manufacture and Use Thereof"* was filed in June 2014 with the Patent and Trademark Office.
- NASA Technical Memoranda
 - Fatigue Resistance of Liquid-Assisted Self-Repairing Aluminum Alloys Reinforced with Shape Memory Alloys
 - Assessment of Fatigue Crack Damage and Mitigation in Self-Repairing Metallic Materials
- Invited Talks:
 - TMS 2015 Annual Meeting and Exhibition, March 2015 in Orlando, FL *"Investigating the Fatigue Behavior of Aluminum-Based Shape Memory Alloy Self-Healing (SMASH) Technology"*.
- Other Conference Talks:
 - Aerospace Materials (AeroMat) Conference in June 2014 in Orlando, FL. *"Amending Fatigue Damage Using Shape Memory Alloy Self-Healing (SMASH) Technology"*.
 - International Conference of Self Healing Materials, Ghent, June 2013, *"Design Methodology for Liquid-Assisted Self-Healing Metals"*.
- Media, Articles and Public Relations:
 - Central Florida Fox 35 News, January 2014
 - NASA web article, September 2013, <http://www.nasa.gov/content/smash-alloys-being-designed-to-improve-aerospace-safety-margins/>
 - NASA video highlight: <http://www.youtube.com/watch?v=VBgGpkesHQo>
 - Professor Michele Manuel was deemed as one of three top researchers with groundbreaking research at the University of Florida in part because of the SMASH research, UF Alumni Magazine *"Shaping the Future"*, Spring 2014.



Next Steps

- Currently planning on 7 peer-reviewed journal articles
 - 1 high-level (in work), 2 modeling papers, 2 materials journals, 2 mechanics of materials.
- No-cost extensions granted to universities to complete experimental and modeling work for next 3 to 9 months.
 - Includes testing of multi-ply specimens and precipitation hardened matrix alloys.
- Interest from the Space Technology Mission Directorate to continue work on embedded crack detection and surface or non-contact heating.
- Potential collaboration with JPL to further enhance matrix design.
- Continue to market technology to other NASA Principal Investigators

A scale bar consisting of a horizontal line with vertical end caps, labeled "1 mm" below it.

1 mm

Summary/Conclusions



- Proved healing of fatigue and overload cracks in proof-of-concept and aluminum matrix composites
- Performed fatigue crack growth tests before and after healing
- Experimentally optimized the processing parameters, healing treatment, matrix heat treatment
- Finite element model optimized the SMA reinforcement geometry, length, and pre-strain conditions
- Validated computer model using experimental data.

THANK YOU ARMD and NARI!