



Planetary Protection Knowledge Gaps for Human Extraterrestrial Missions



***ENVIRONMENTAL CONTROL AND LIFE
SUPPORT SYSTEMS FOR MARS MISSIONS***

***ISSUES AND CONCERNS FOR PLANETARY
PROTECTION***

Daniel Barta, Molly Anderson, & Kevin Lange

NASA Johnson Space Center

March 25, 2015



Outline

- ◆ **Outline**
- ◆ **Introduction**
 - Human Life Support Consumables & Wastes
 - ISS ECLSS: The State of the Art & Starting Point for Exploration Systems
- ◆ **Forward Contamination**

A partial quantification of the potential contributions by ECLSS including remarks on mitigation and mission phases

 - Atmosphere Revitalization Systems
 - Cabin Leakage and Contingency Operations
 - Water Recovery Systems
 - Waste Management Systems
 - Bioregenerative Systems
- ◆ **Backward Contamination**
- ◆ **Considerations for ECLSS Architecture, Operations and Technology Selection**
- ◆ **Supplemental Questions & Issues**



Introduction

Selected Principles/Findings/Recommendations from the *Life Support and Habitation and Planetary Protection Workshop, NASA/TM-2006-213485*

- ◆ Human Mars missions will generate materials from both biotic and abiotic sources that could contaminate Mars and/or be classified as indicators of life.
- ◆ No human habitat or EVA system will be fully closed. Missions carrying humans to Mars will inevitably contaminate the planet to some degree.
- ◆ Planetary Protection requirements require definition early in mission development.
 - Definition of “contaminants” is required.
 - *How do you define “biosignature”? Biological and chemical?*
 - Establish forward and back contamination limits.
 - *What releases allowable? Is any contamination acceptable?*
 - Define waste containment and disposal requirements
 - *Can waste be disposed on the surface of Mars? If so, in what state? What would be the containment requirements?*
 - Establish Earth return operations and quarantine requirements
- ◆ Currently, quantitative Planetary Protection guidelines are not available.
- ◆ Define material inventory and characteristics, process products, and release mechanisms.



Human Life Support Consumables & Wastes

Consumables		Kilograms per person per day		Wastes		Kilograms per person per day	
Gases			0.8	Gases			1.0
	Oxygen	0.84			Carbon Dioxide	1.00	
Water			23.4	Water			23.7
	Drinking	1.62			Urine	1.50	
	Water content of food	1.15			Perspiration/respiration	2.28	
	Food preparation water	0.79			Fecal water	0.09	
	Shower and hand wash	6.82			Shower and hand wash	6.51	
	Clothes wash	12.50			Clothes wash	11.90	
	Urine flush	0.50			Urine flush	0.50	
					Humidity condensate	0.95	
Solids			0.6	Solids			0.2
	Food	0.62			Urine	0.06	
					Feces	0.03	
					Perspiration	0.02	
					Shower & hand wash	0.01	
					Clothes wash	0.08	
TOTAL			24.8	TOTAL			24.9

Quantities Fixed – Largely Determined by Basic Human Physiological Requirements

Quantities Variable – Largely Determined by Mission Requirements



ISS ECLSS: “The State of the Art”

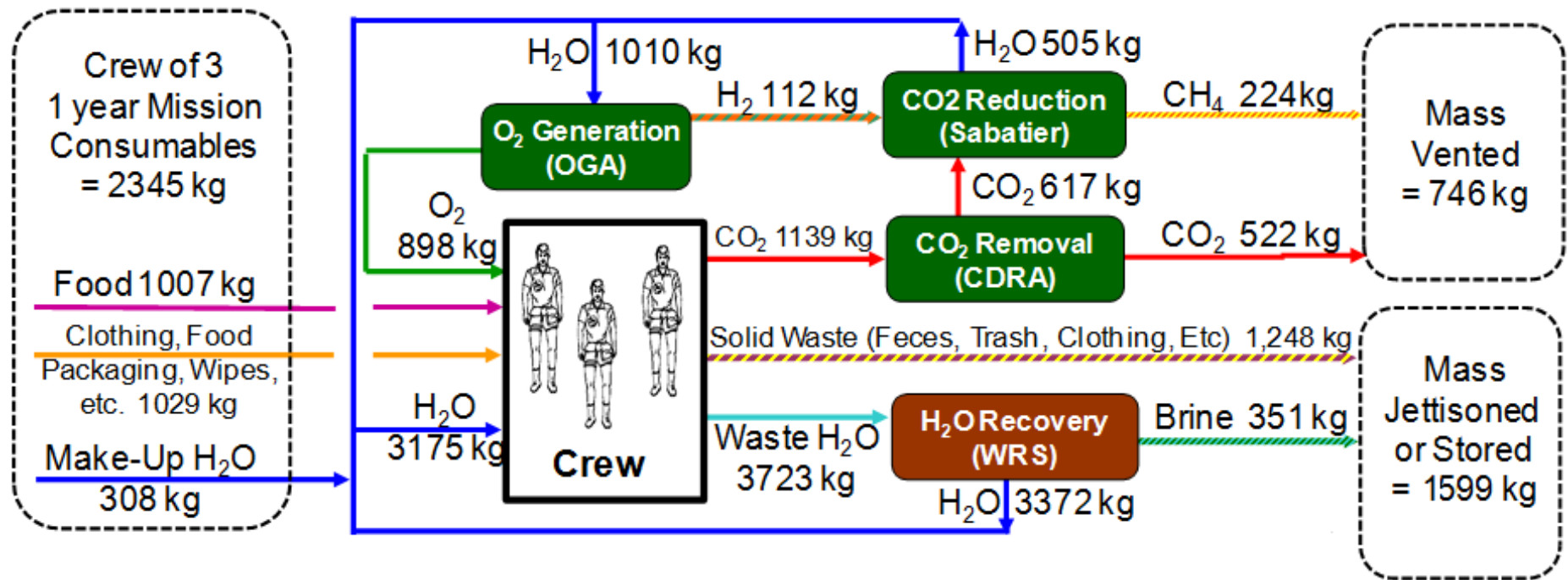

- ◆ Although the state-of-the-art, the ISS ECLSS is only partly closed.
 - *Atmosphere Revitalization: ≈42% oxygen recovery from CO₂*
 - *Water Recovery Systems: 74-85% recovery of water from urine; ≈100% water recovery from humidity condensate; ≈93% total recovery*
 - *Waste Management: no recycling. We collect, store and jettison*
- ◆ Significant amounts of wastes (gas, liquid and solid) are generated during all stages of a human mission to Mars



Atmosphere Revitalization System (ARS) Sources of Forward Contamination

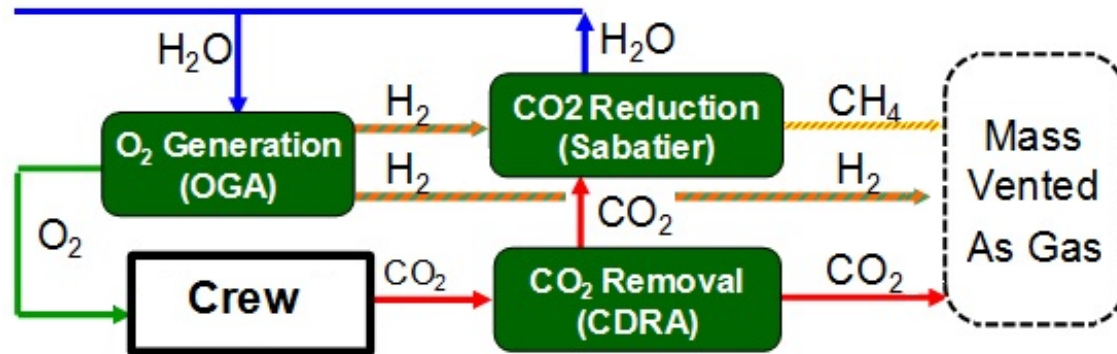

- ◆ The ISS ARS is designed to vent!
 - Gases & amounts will vary depending on the real time operation of ARS hardware.

Possible venting during 540 Day Surface Mission

Vented Gas	Production Rate [†] (kg/CM/day)	Quantity Vented (kg)			
		Sabatier Operating		Sabatier Not Operating	
		Crew 4	Crew 6	Crew 4	Crew 6
Methane	0.21 vs 0	454	680	0	0
Carbon Dioxide*	0.48 vs 1.04	1,037	1,555	2,246	3,370
Hydrogen	0 vs 0.10	0	0	216	324

[†]Two rates are given: the first is if CO₂ reduction hardware is available; the second is if not.

*Carbon dioxide from CDRA may contain 0.04 ppm trace organics. Integrated over 540 days for the 6 crew w/o Sabatier case equates to approximately 141 mg. The presence of micro-organisms is not known.



Atmosphere Revitalization Systems

Forward Contamination Mitigation Options

- Several alternative technologies have the potential to greatly improve closure of atmosphere revitalization systems over the state of the art.
- Most involve improved recycling of hydrogen
- Potential solutions provide additive capability to existing ARS architecture or substitutional capability disruptive to existing architecture
- 3 examples are noted below.

Carbon Formation Reactors (CFR)

- Potential for 100% recovery of oxygen
- Depending on technology, convert methane or syngas to solid carbon and hydrogen or water depending on technology
- Can be used post Sabatier in existing architecture or post SOE
- Challenges: catalyst poisoning; high temperatures; gas separation including purity of gaseous products.

Bosch

- Potential for 100% recovery of oxygen
- Results in solid carbon byproduct rather than methane.
- Would replace Sabatier in existing architecture
- Challenges: catalyst poisoning; high temperatures; gas separation

Solid Oxide Co-Electrolysis (SOE)

- CO₂ reduction and water electrolysis in same process, with direct production of O₂ from CO₂
- SOE with embedded Sabatier may potentially yield 70-80% recovery of O₂ and can approach 100% if followed by a CFR
- Challenges: High temperatures, thermal cycling, electrode life and gas separation

- Others include CH₄ pyrolysis & photosynthesis

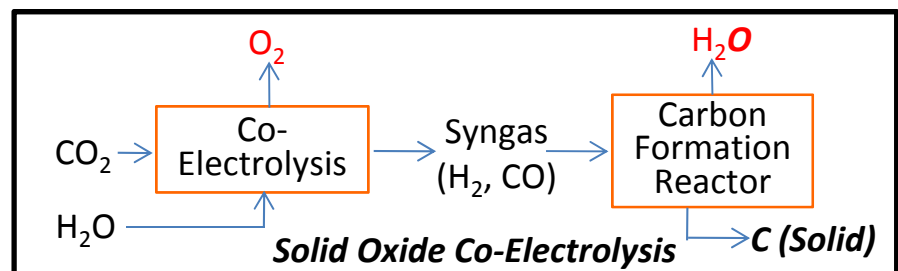
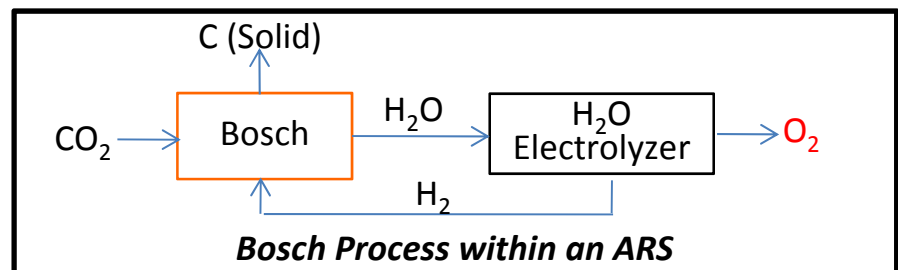
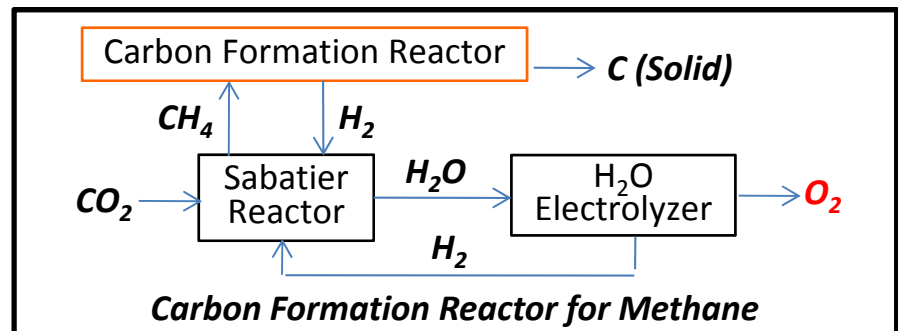
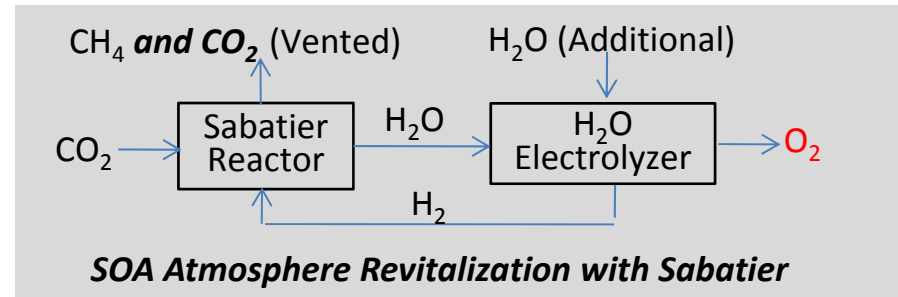



Atmosphere Revitalization Systems Forward Contamination Mitigation Options

Series Bosch:

- Series-Bosch technology can close the atmosphere revitalization loop for complete recovery of oxygen from CO₂.
- It is a two reactor system, Reverse Water Gas Shift (RWGS) followed by a Carbon Formation Reactor.
- From a planetary protection perspective, we trade the venting of methane for solid carbon, which will accumulate as a solid waste within spacecraft at a rate of ≈ 0.27 kg/CM/day
- We have investigated incorporating Bosch carbon into heat melt compactor discs, and also combining the carbon with concreting materials to make “bricks” for as a planetary construction material.
- There is a mass penalty for catalyst
- We have found that Mars simulated regolith can be used as a catalyst for the carbon formation reactor.

REACTIONS OF THE BOSCH PROCESS

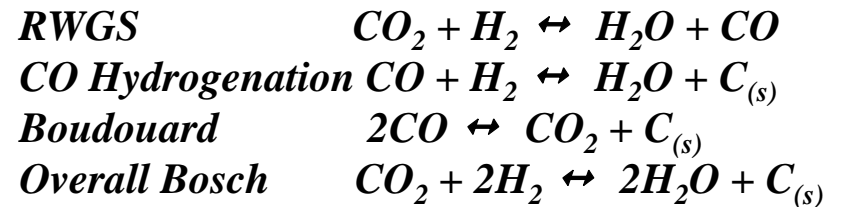

Series-Bosch Test Stand

Quantity Carbon Accumulated (kg)			
180-day Transit		540-day Surface	
Crew 4	Crew 6	Crew 4	Crew 6
204	307	613	920



Estimates of Gas Loss from Leakage & Airlock Use for Mars Habitat Lander

- ◆ **Estimates of gas loss from the habitat lander based on airlock use and cabin leakage calculations**
 - NASA-SP-2009-566-ADD2 (2014) calls for "up to three 6.5-hour EVAs each week for habitat maintenance, trash ops, local exploration, etc." from the habitat lander.
 - Depending on the level of airlock atmosphere recovery, and habitat pressure, 3 EVAs/week would result in an average air loss of 0.18-0.53 kg/day or 95-286 kg for a 540 day surface mission.
 - Given that habitat leakage can be estimated at approximately 0.1 kg/day, the total air loss would be 0.28-0.63 kg/day or 149-340 kg for a 540-day surface mission.
- ◆ **Estimates of gas loss from the habitat lander based on DRM 5.0 makeup gas requirements**
 - NASA-SP-2009-566-ADD (2009) estimates N₂/Ar needs from leakage and EVAs to be 133 kg, which is equivalent to an air loss of 196 kg at 32% O₂.
- ◆ **200 kg total air loss from the surface habitat to the Mars environment per mission is a reasonable estimate for evaluating planetary protection impacts.**



Estimates of Contaminant Release to Mars Surface from 200 kg Gas Loss

Approximate Cabin Atmosphere Contaminant Levels Based on ISS Experience		
<i>Contaminant</i>	<i>Value</i>	<i>Units</i>
Airborne Bacteria	50	CFU/m ³
Airborne Fungi	10	CFU/m ³
Methane	6	mg/m ³
Alcohols + Acetone	6	mg/m ³
Octafluoropropane	9	mg/m ³
Formaldehyde	0.03	mg/m ³
Other VOCs	4	mg/m ³

Estimate Released		
<i>Cabin Pressure</i>		<i>Units</i>
<i>8 psi</i>	<i>10.2 psi</i>	
15,486	12,159	CFU
3,097	2,432	CFU
1,858	1,459	mg
1,858	1,459	mg
2,787	2,189	mg
9	7	mg
1,239	973	mg

- ◆ Potential releases from habitat leakage represent about ¼ of the total and would be hard to mitigate. We are assuming primary leakage is from seals and bulkheads (unfiltered) rather than wall of hull.
- ◆ Potential releases due to airlock use could be mitigated by suit port
- ◆ Unplanned or contingency depresses (in the case of fire or toxic chemical release) could result in the entire cabin volume vented.



Water Recovery System (WRS) Sources of Forward Contamination – ISS SOA

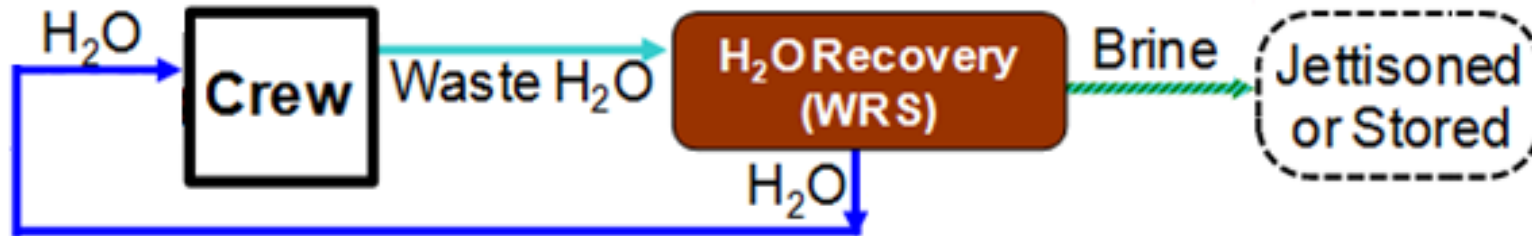

	Production Rate (kg/CM-day)	Mass Fraction H ₂ O	Aprx. Mass Fraction Organics*	Aprx. Mass Fraction Inorganics
Daily Production	0.31	0.900	0.072	0.028

Mission Segment & # of Crew	Total Produced (kg)	H ₂ O Content (kg)	Approx. Organic Content (kg)	Approx. Inorganic Content (kg)
180-day Transit, 4 Crew	222	200	16	6
180-day Transit, 6 Crew	333	299	24	9
540-day Surface, 4 Crew	665	599	48	19
540-day Surface, 6 Crew	998	898	72	28

- ♦ Wastewater brines contain significant organic and nitrogen compounds



Water Recovery Systems

Forward Contamination & Mitigation Options

- ◆ Most water recycling technology options generate brines.
- ◆ The organic content of brines are dependent on initial wastewater composition and water processing technology
- ◆ Dried brine residuals become solid waste

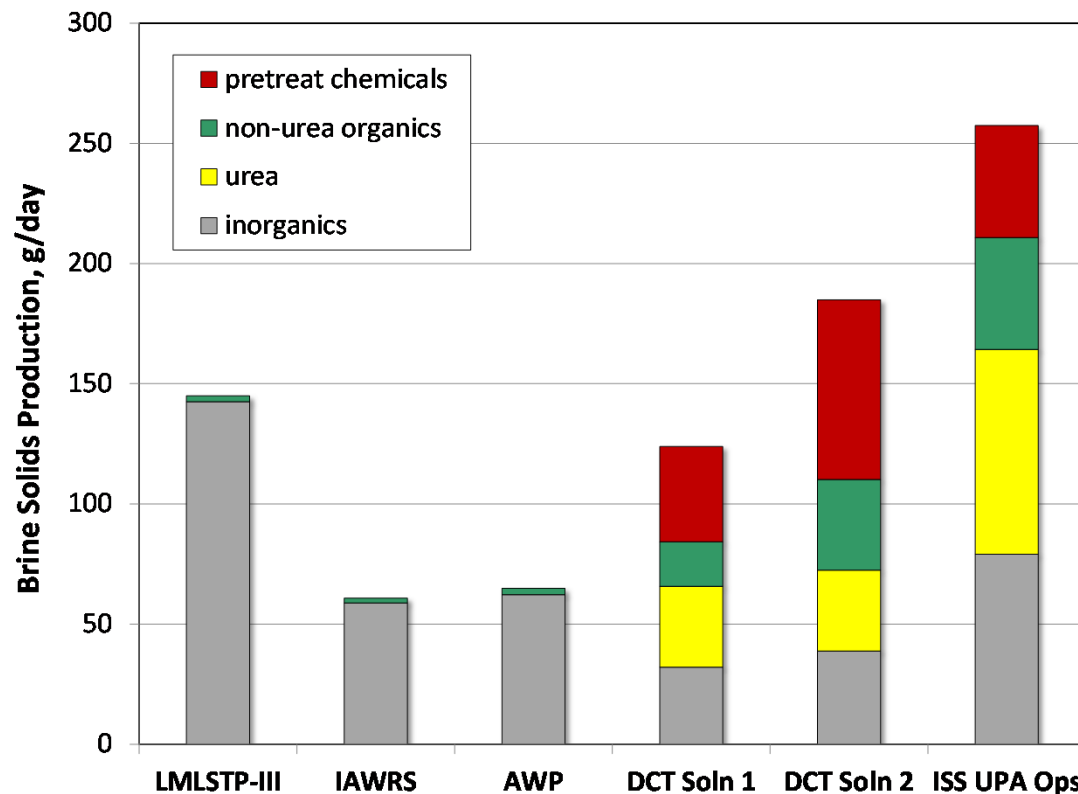

LMLSTP: Lunar-Mars Life Support Test Project

IAWRS: Integrated Advanced Water Recovery System

AWP: Alternative Water Processor

DCT: Distillation Comparison Test

UPA: Urine Processor Assembly

Technology Development Focus is on H₂O Recovery

<i>Aerosol Dryers</i>
Spray Drying
Ultrasonic Nebulization
<i>Wick Evaporation</i>
Air Evaporation System
Air Evap. with Reusable Wicks
<i>Membrane Systems</i>
Brine Evaporation Bag (BEB)
Ionomer-Membrane Water Processor System
<i>Bulk or Surface Drying</i>
Brine Residual In-Containment
Enhanced Brine Dewatering
Lyophilization



Waste Management Systems (WRS) Sources of Forward Contamination

- ◆ The SOA for solid waste management is collection, storage and jettison.

	Production Rate (kg/CM-day)	Mass Fraction H₂O	Mass Fraction Organics*	Mass Fraction Inorganics*
Crew Consumables Trash	0.91	0.184	0.720	0.096
Feces	0.12	0.732	0.268	0.000

Mission Segment, # of Crew	Total (kg)	H₂O Content (kg)	Organic Content (kg)	Inorganic Content (kg)
Feces, 180-day Transit, 4 Crew	89	65	24	0
Feces, 180-day Transit, 6 Crew	133	97	36	0
Trash, 180-day Transit, 4 Crew	654	120	471	63
Trash, 180-day Transit, 6 Crew	982	180	707	95
Feces, 540-day Surface, 4 Crew	266	194	71	0
Feces, 540-day Surface, 6 Crew	399	292	107	0
Trash, 540-day Surface, 4 Crew	1,963	360	1,414	189
Trash, 540-day Surface, 6 Crew	2,945	541	2,120	284

- ◆ Feces & trash have high organic content (includes paper & plastics)



Waste Management Systems (WRS) Sources of Forward Contamination

◆ Trash can be highly biologically active!

AIAA 2012-3565: "Characterization of Volume F trash the three FY11 STS missions: Trash weights and categorization and microbial characterization"



	Fungal Isolates from STS 129-131	Bacterial Isolates from STS 129-132
Personal hygiene waste	Fusarium oxysporum, Candida albicans	Staphylococcus aureus, Bacillus subtilis ss subtilis, Staphylococcus sp, Enterobacter aerogenes, Enterococcus pseudoavium, Staphylococcus aureus, Staphylococcus epidermidis, Bacillus subtilis ss subtilis, Curtobacterium spp, Sphingomonas sanguinis, Enterobacter pyrinus
Food	Rhodotorula hylophyla, Rhodotorula spp, Penicillium steckii, Cryptococcus albidus, Rhodotorula mucilaginosa, Candida albicans	Bacillus spp., Enterococcus pseudoavium, Staphylococcus aureus Staphylococcus saprophyticus, Bacillus pumilus Sphingomonas sanguinis
Drink pouches	Candida catenulate, Rhodosporidium diobovatum, Candida albicans, Cryptococcus laurentii, Rhodotorula, Aspergillus	Bacillus subtilis ss subtilis, Enterococcus pseudoavium, Burkholderia cepacia, Staphylococcus aureus, Enterobacter pyrinus, Citrobacter spp, Sphingomonas sanguinis, Burkholderia multivorans, Enterobacter pyrinus
External surfaces	Cladosporium herbarum, Rhodotorula glutinis, Rhodotorula mucilaginosa, Cryptococcus laurentii, Candida albicans, Aspergillus sydowii	Bacillus amyloliquifaciens, Bacillus pumilus, Microbacterium marytipicum, Bacillus amyloliquifaciens, Paenibacillus pabuli, Bacillus amyloliquifaciens, Burkholderia pyrrocinia
Internal surfaces	Candida albicans, Rhodosporidium diobovatum	Bacillus subtilis ss subtilis, Bacillus subtilis ss subtilis,
MAGS/elbow contents	Candida albicans, Fusarium spp, Rhodotorula spp.	E. coli, Citrobacter murlinae, Shigella flexneri



Waste Management Systems (WRS) Processes & Technology Candidates

Volume Reduction (VR)

Storage space for wastes is very limited on space vehicles. Volume reduction or compaction saves valuable space.

Water Removal and Recovery (WR&R)

Many wastes such as concentrated brines and food waste contain substantial quantities of water.

Safening – Stabilization (S-S)

Safening means processing the waste to make it safe for the crew or harmless to planetary surfaces. Once safened, stabilization assures that waste does not change its state.

Containment and Disposal (C&D)

Contained waste is isolated from the crew and the external environment. Disposal can be onboard, overboard, in space, and on planetary surfaces.

Resource Recovery (RR)

Waste can be processed for reuse for the initial function, or it can be converted to new useful materials. Examples include cleaning clothes for reuse, converting waste to minerals for use as food growth nutrients, and trash to gas.

Technology Candidates	Processes
Plastic Heat Melt Compactor	VR, WR&R, S-S
Lyophilization	WR&R, S-S
Air Drying	WR&R, S-S
Vacuum Drying	WR&R, S-S
Trash to Supply Gas	VR, WR&R, S-S, RR
Pyrolysis	VR, WR&R, S-S
Incineration	VR, WR&R, S-S, RR
Hydrothermal Oxidation	VR, WR&R, S-S, RR
Composting	VR, WR&R, S-S, RR
Clothes Wash	RR
Storage & Jettison	C&D



Forward Contamination Mitigation Solid Waste Mineralization: Trash to Supply Gas



SCWO

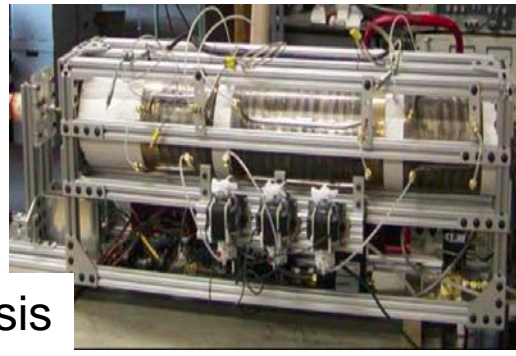

Pyrolysis



Incineration

General Technology	Technology Subtypes	Technology Process Options	Temp. [°C]	Pressure [atm]	Oxygen Requirement	End Products/ By-products	Challenges
Thermal Treatment	Pyrolysis (Thermal decomposition)	Fast pyrolysis	400-650	~1	None	Liquids, tars, char, synthesis gas	tar
	Gasification	Direct/ Partial oxidation	400-800	~1	Substoichiometric	Synthesis gas (CO + H ₂)	waxy residue
	Incineration	Incineration mass burn/auger feed	1000	~1	Excess Oxygen	CO ₂ , H ₂ O, ash	NO _x reduction
Chemical Oxidation	Ozone Oxidation	Wet ozonation	<250	~1	Ozone (O ₃)	CO ₂ , H ₂ O, ash	TBD
	Steam Reforming	Steam Reforming	400-600	~220	Steam with substoichiometric oxygen	H ₂ , CO, CO ₂	TBD
Catalytic Decomposition	Low Temperature Catalytic Decomposition	Photocatalytic oxidation	<100	~1	Stoichiometric	CO ₂ , H ₂ O, ash	TBD
		Wet air oxidation	150-325	20-200	Saturated O ₂	H ₂ , CO, CO ₂ , CH ₄	TBD



Waste Management Systems (WRS) Technology Candidates – Heat Melt Compaction



Heat Melt Compactor

- *Reduces volume, removes & recovers water, encapsulates organics and renders trash a biologically stable and safe product.*
- *Plastic content - potential for radiation shielding*
- *Microbial studies demonstrated efficacy*

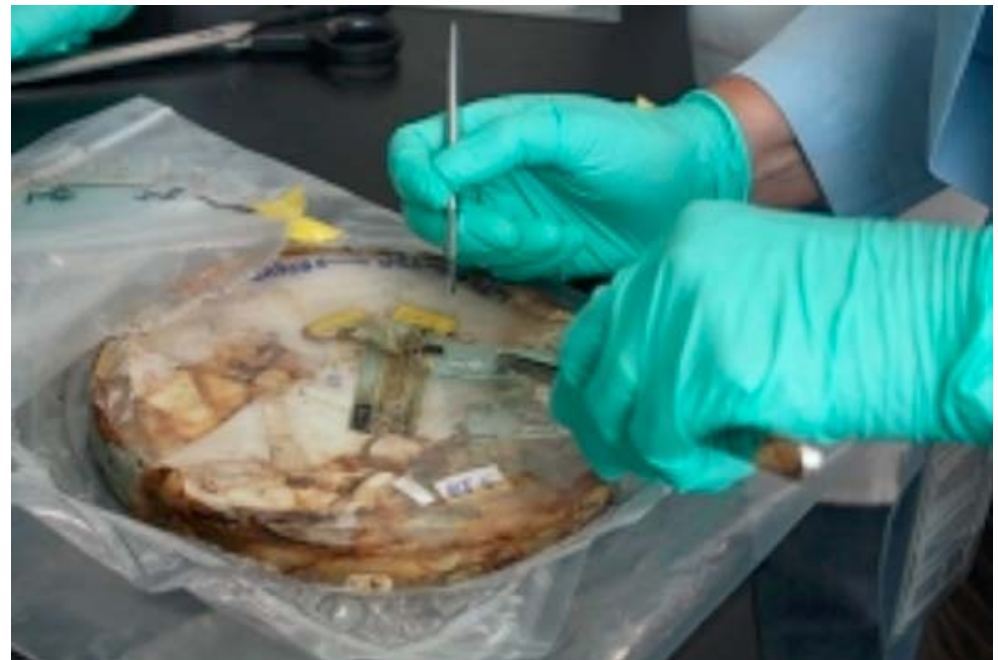

Heat Melt Compactor discs were evaluated with spore test strips (*Bacillus atrophaeus* & *Geobacillus stearothermophilus*)



Bioregenerative Life Support Systems

◆ **Biological systems, including food production, represent the potential “ultimate” in closed life support.**

- Bioreactors and composters could be used to biologically degrade liquid and solid wastes.
- Plants produce food but also photosynthetically convert CO₂ into oxygen and can utilize nutrients in wastewater.
- These systems will include very unique biological burdens
- These could be benefactors for recycling mineralized or composted solid wastes.
- But likely, on a first human mission to Mars, plants may be used only for food system augmentation – for fresh vegetables.

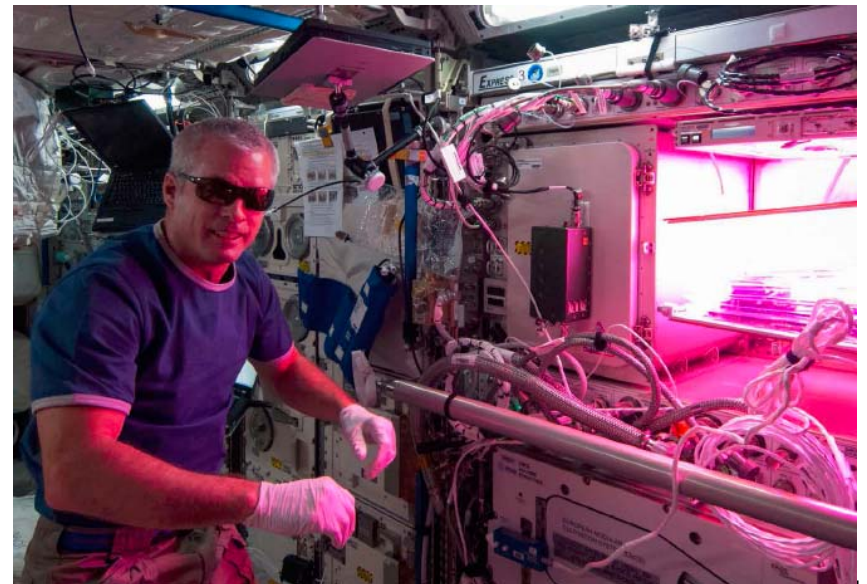



Backward Contamination Considerations

- ◆ Dust mitigation will be a consideration for protection from hazards of Mars regolith, including hexavalent chromium and perchlorates.
- ◆ Human quarantine capability – dual ECLSS systems, compartmented cabin?
- ◆ Continuing the chain – if people have been exposed to Mars materials, what does that say about the return transit vehicle?

- ◆ **Use of ISRU derived life support consumables (water, O₂)**

- The ISS Water Recovery System's Multi-filtration Beds and/or Vapor Compression Distillation assembly would need to be evaluated for removal of chromium and perchlorates
- The Volatiles Removal Assembly (VRA) heats process water to 275F in a catalytic oxidizer. Would this be sufficient to sterilize Mars surface water?

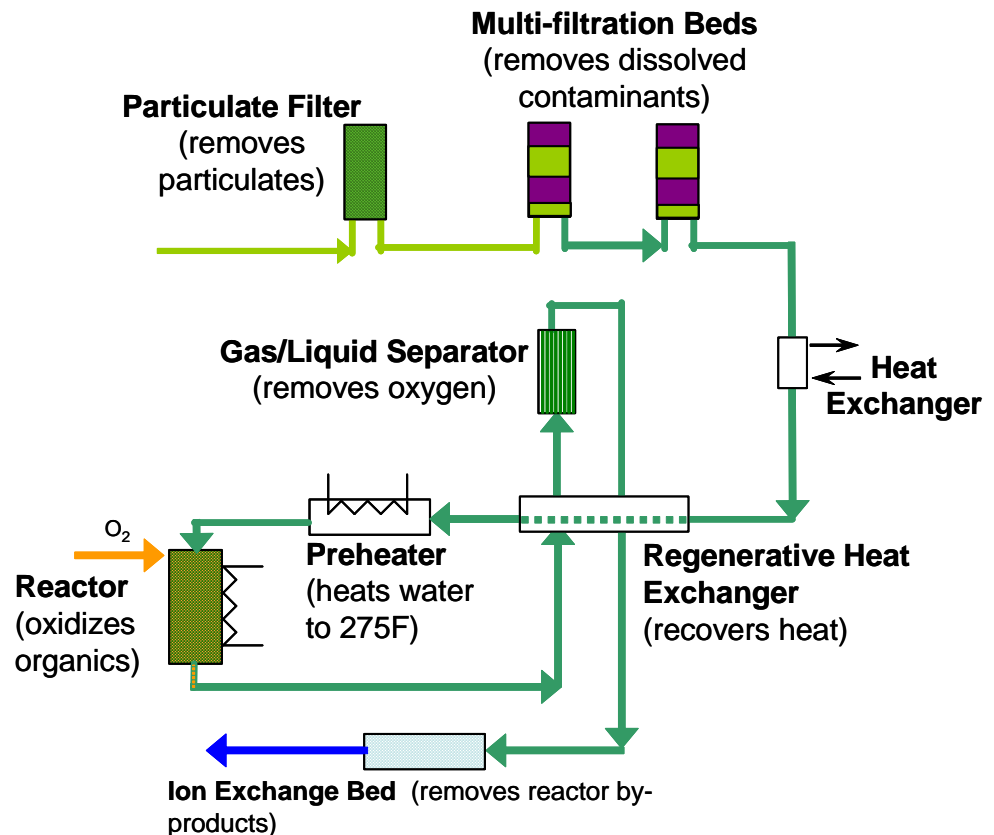



Planetary Protection Considerations for ECLSS Technology Development

- ◆ Planetary protection represents an additional set of requirements that technology developers need to consider early in development programs.
- ◆ Planetary protection will affect technology development by constraining how technologies can operate and what technologies may be considered:
 - Limiting or prohibiting certain kinds of operations or processes (e.g. venting)
 - Necessitating that other kinds of operations be performed (e.g. sterilization)
 - Prohibiting what can be brought on a mission (e.g. extremophiles)
 - Creating needs for new capabilities/technologies (e.g. containment)
 - This may result in certain types of technologies being prohibited (vacuum desorption of beds?) or modifying their use (filtering vent lines)
- ◆ Backward Contamination has impacts (use of ISRU consumables; dispositioning contaminated materials; needs for quarantine capability)
- ◆ A “fully closed” ECLSS may ultimately be ideal for planetary protection, but to achieve this closure, launch mass and complexity may be extremely high – the law of diminishing returns.
- ◆ Ultimately, there will be effects on mission costs, development costs, and the mission trade space. Will a PP compliant ECLSS fit into the mission allocation?



Supplemental Questions & Issues

- ◆ ECLSS engineers hunger quantitative requirements!
- ◆ What constitutes a biomarker?
- ◆ What discharges are acceptable?
- ◆ How can unacceptable discharges be made acceptable?
- ◆ For storage of wastes on the surface, what is the requirement for the life of the containment vessel?
- ◆ How can we certify the quality of ISRU produced consumables before use if we don't know the threat?
- ◆ How much can we learn from precursor robotic missions?
- ◆ Will a conservative approach to planetary protection prohibit using bioregenerative systems?
- ◆ Prioritization of Planetary Protection against other mission requirements, including mass and complexity
- ◆ An ECLSS trade study driven by Planetary Protection requirements needs to be performed.
- ◆ We need to start re-investing in critical low TRL technologies, including waste management



Summary

- ◆ Planetary protection guidelines will affect many operations, processes, and functions that have been utilized in spacecraft life support systems in the past or are under consideration for future missions
 - Venting and discharge of liquids and solids
 - Ejection of wastes
 - Use of ISRU
 - Requirements for cabin atmospheric trace contaminant concentrations and cabin leakage
 - What materials, organisms, & technologies that can be brought on missions
- ◆ Planetary protection represents an additional set of requirements that must be considered during the technology development phase.
- ◆ Planetary protection requirements will have a major impact on technology selection for future missions.
- ◆ Planetary protection requirements need to be considered early in technology development programs.



The Questions

- ◆ **What planetary protection (PP) related research activities or technical developments do you feel are critical for inclusion in your study area?**
 - Properties of regolith & dust to design filtration and removal systems
 - Medical research to set allowable exposure limits
 - Science inputs on how much of what type can be vented. (Zero is not a good answer.)
 - Science inputs on how long wastes (or whole habitats) left on the surface must remain stable and sealed. (Forever is not a useful answer.)

- ◆ **What work/research is already underway?**
 - Life support teams are investing minimal work in planetary focused technologies. Stabilizing or destroying solid wastes is not minimally funded. Regolith focused particulate work is not funded.
 - MEDA on Mars 2020 will do more to characterize regolith (in one location...)
 - Any climate models from Mars 2020 may help science community specify release requirements.



The Questions

- ◆ **Is special information or technology needed to plan for nominal vs. non-nominal situations?**
 - If crewmembers need to be quarantined from each other (and a recycling life support system) then different technology is needed
 - Abort cases could drop significant portions of a spacecraft on a surface and ruin any containment.
- ◆ **Are existing human mission mitigation options and approaches adaptable for PP needs on the martian surface?**
 - Filtration can be applied to known outputs (leakage always happens...), but often at a performance cost
- ◆ **Are there any significant stumbling blocks ahead that are evident? (Including coordination across PP, science exploration, engineering, operation and medical communities.)**
 - Engineers require numbers to drive design and make decisions. “ALARA” requirements are very difficult to use to create good results.



The Questions

- ◆ **In your opinion, what still needs to be accomplished?**
 - Work to set storage time limits for known wastes
 - Identify criticality of impact inevitable leakage to science objectives
 - At minimum, formulate requirements with TBD quantitative levels for human environment conditions soon so we can at least start to address functions
 - Perform a systems analysis and mission trade study for Mars mission ECLSS with focus on Planetary Protection constraints and flush out costs/penalties to mass, power, volume and technology selection.