



Hybrid Boron Nitride Nanotubes – Carbon Nanostructures Supercapacitor with High Energy Density

Diana Santiago, GRC/RXC

Janet Hurst, GRC/RXC

James Wu, GRC/REP

Marisabel Lebron-Colón, GRC/RXP

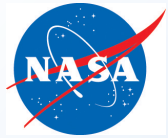

Objective

- We proposed to develop a new class of solid state supercapacitors, with insulating boron nitride nanotubes (BNNTs) as the dielectric layer and high conductivity carbon nanostructures (CNSs) as the electrode material.
 - Calculations predict a conservative estimate of 1000 X increase in stored energy.
 - NASA GRC has developed an effective method for producing BNNTs in large quantities, which can be used to construct supercapacitor materials.

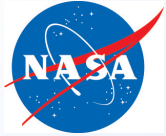

Supercapacitor

- *Supercapacitor* or *Ultracapacitor* is an electrochemical capacitor with high energy density.
- *Capacitor* is two electrical conductors separate by a dielectric used to storage energy.
- *Dielectric* material is an electrical insulator that can be polarized by an applied electric field.
- The ability to storage energy is call *Capacitance (C)*
 - $C = q/V$; q is charge and V is voltage
 - $C \propto A$; A is surface area
 - $C \propto 1/d$; d is distance

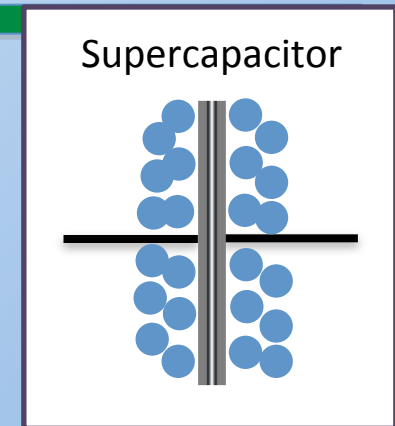
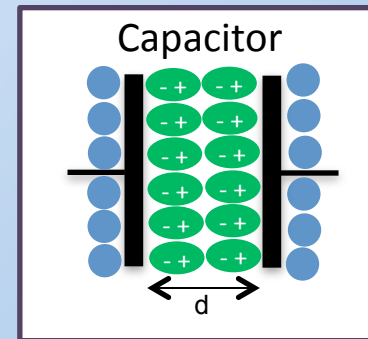

High Surface Area

- Conventional supercapacitor advantages over fuel cell and batteries:
 - *Higher power densities*
 - *Shorter charging time*
 - *Longer cycle life*
- Supercapacitors have less energy densities than fuel cells and batteries.



Types of Supercapacitor

- *Pseudocapacitors*
- *Hybrid Capacitors*
- *Electrochemical Double-Layer Capacitors (EDLC):*
 - Conventional:
 - Activated carbon, carbon nanotubes and aerogels.
 - Non-faradaic, reversible
 - Liquid electrolyte, high surface area, long life, low cost.
 - Solid state supercapacitor:
 - Advantages:
 - Safety use of roll design assembly.
 - Easier fabrication using conventional powder processing technique.
 - Miniaturization.
 - Disadvantages
 - Materials with inferior dielectric behavior.

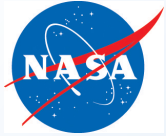

GRC Hybrid BNNT/CNS Supercapacitor

BNNTs have not been explored as dielectric material in a supercapacitor despite being known as one of the materials with the highest dielectric strength of any known material (2×10^5 V/mm).

Proposed Approach:

- The proposed solid state supercapacitor will take the advantage of a long cycle life of the EDCL supercapacitor without the disadvantage of use a liquid electrolyte.
 - High surface area electrodes using carbon nanostructure materials as carbon nanotubes and graphene oxide.
 - Boron nitride nanotubes as electrolyte material - has the highest dielectric strength of any known material.
- *Using these nanomaterials we can create very thin layers increasing the capacitance of the nanocapacitor and avoid a possible electrical arcing because of the excellent dielectric properties the BNNTs.*



Payoff

- Supercapacitors will be critical for future hybrid electric large aircraft where the combination of gas turbine engine and energy storage device will achieve greater than 75 % reduction in fuel burn to meet Subsonic Fixed Wing N+3 goals.
- Advantages of the proposed supercapacitors:
 - High power density and high energy density
 - Fast charge and discharge cycles
 - Recharging time ranging from seconds to a few minutes
 - Ability to operate over a wide temperature range including sub-zero temperatures
 - Longer life.

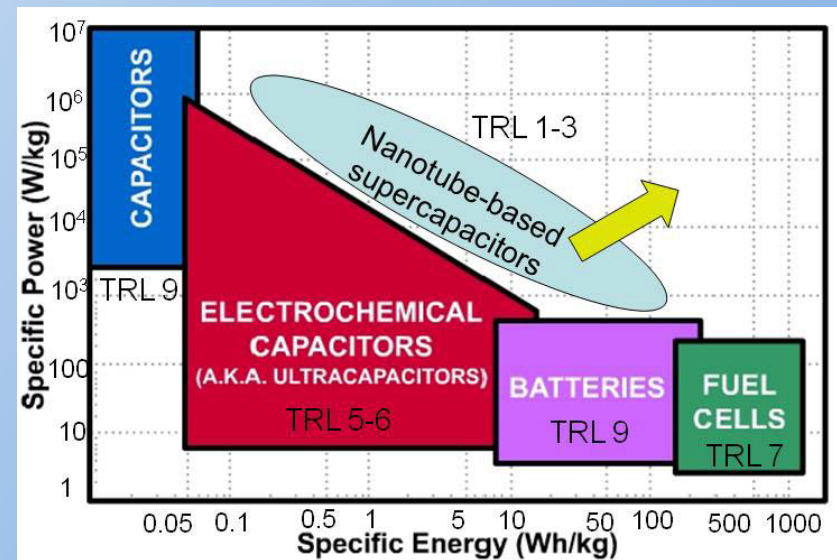

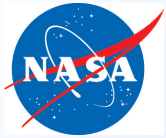

Approach

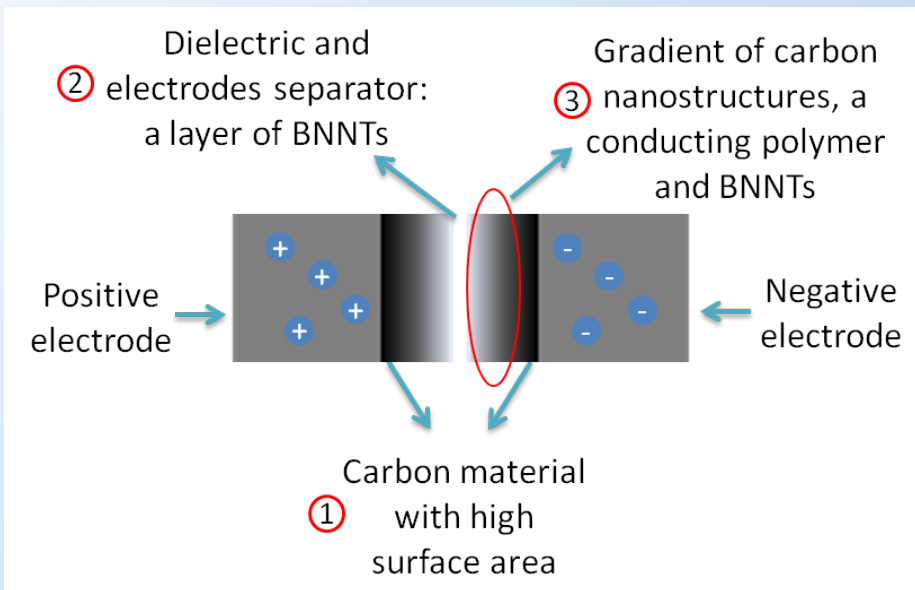

- Why a new composition?
 - To have a more energy density the electrolyte has to have good contact with the electrode material for a better electrical field and keep the charge in place.

- The new idea is to prepare BNNT/CNT hybrid structures with a coherent interface to maintain some characteristics of the CNTs.
- *The hypothesis with this new **Dual Composition of BNNT/CNT** is to introduce some polarization to induce the electrical field inside the electrode and having better interaction with the CNS materials.*

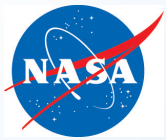

Status of Key Activities for Development of BNNT/CNS Supercapacitors

Activity	Status
Growth of BNNT	Several techniques developed at GRC for growing BNNT prior to Phase I
Growth of dual BNNT/CNT structure	Growth technique developed using CNT as a template for coherent BNNT in Phase I
Dispersion of BNNT and BNNT/CNT dual structure in polymer for thin film preparation	Dispersion technique developed in Phase I
Spin coating and tape casting of BNNT and BNNT/CNT containing slurry to prepare thin film	Initial feasibility established in Phase I for small sample sizes, processing difficulties encountered for larger and thicker samples; fabrication process for large samples to be developed in Phase II.
Electrochemical characterization of each individual layers	Successfully completed
Assembly of individual layers to fabricate supercapacitor devices	Assembly plan developed in Phase I, actual fabrication of device in Phase II
Testing of supercapacitor devices	Phase II

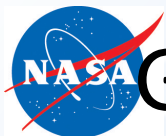

GRC BN Nanotubes Synthesis Processes



2002

Arc Discharge

Easy
Low yield
Mixed phases



2003

Reactive Milling

High yield
Reproducibility issues



2005

CVD

Expensive

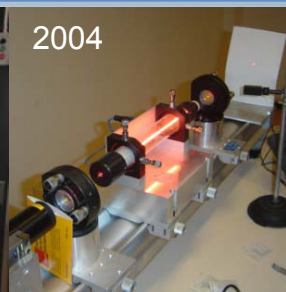

2004

Laser

Low yield
Poor reproducibility
No coating ability
Makes only few walled NT



Plasma CVD

Aligned growth
Expensive

GRC Method - Modified CVD

2 gram/day



2003

- Easy production – similar to existing commercial facilities.
- High yield with short processing time (minutes) – amenable to continuous processing.
- Reproducible – inject nucleation sites .
- Flexible – produces nanotubes in-situ on surfaces -fibers, preforms, powders, aligned growth.
- Low cost reactants: ammonia, B₂O₃, B, similar to industrial BN production.
- Appropriate product for nanocomposites: prefer multi-walled (for mechanical property optimization) with diameter 50 nm – 100 nm (for dispersion optimization).
- Can alter BNNT size and character through processing control.

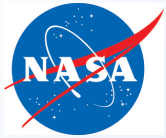

Different BNNT Morphologies

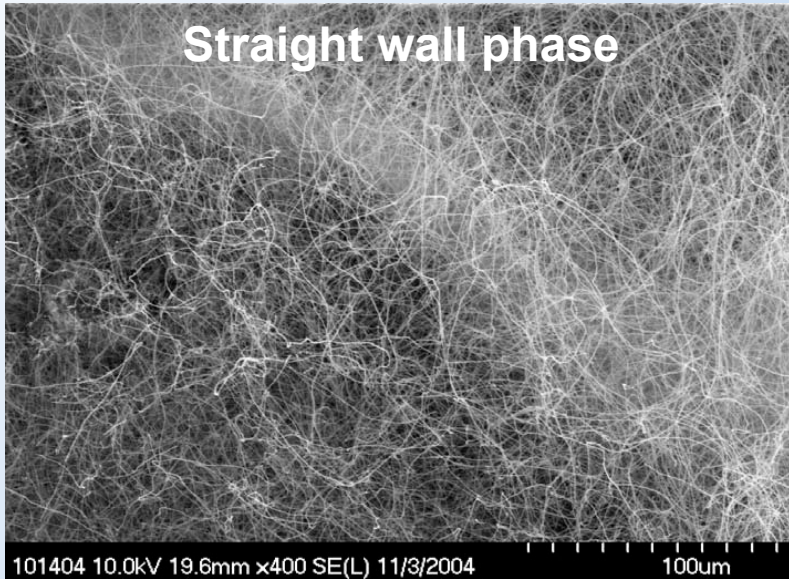

6/6/12

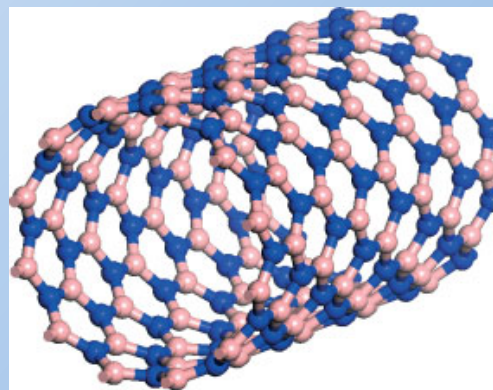

Adv. Mater. 2007, 19, 2413–2432

NASA Aeronautics Research Institute

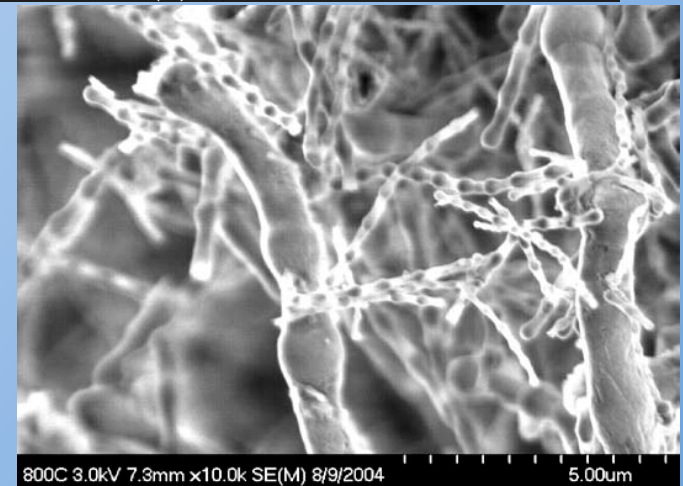

10

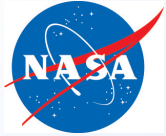

Carbon Nanostructures (CNSs)

Single-walled CNT

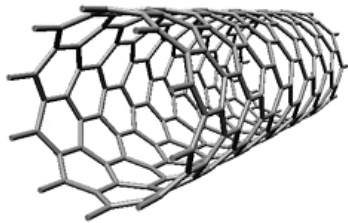

Multi-walled CNT

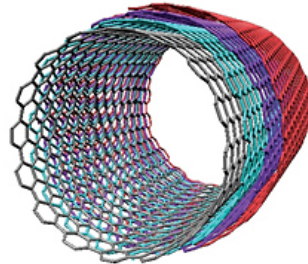

http://science.uwaterloo.ca/~foldvari/research_program/index.html

Graphene oxide

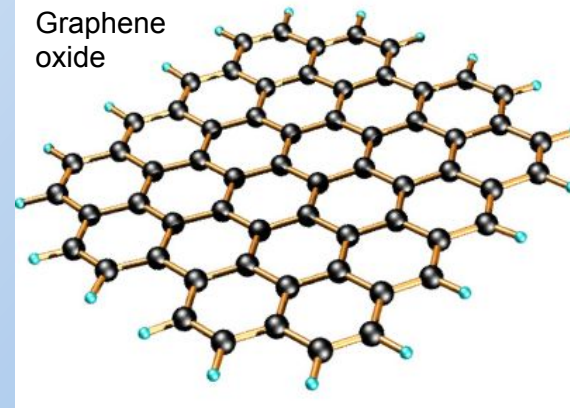

<http://sciencefactsandarticles.blogspot.com/2010/06/graphene-and-graphene-oxide-properties.html>

- **Carbon Nanotubes (CNTs):**
 - One of the allotropes of carbon with a cylindrical structure.
 - Have great electrical, mechanical and thermal conductivity properties.
 - CNTs is the strongest and stiffest material yet discover.
 - Single, double and multi-walled carbon nanotubes have been synthesized.
- **SWCNT was chosen for the Phase I research because of its high surface area of 1315 m²/ g.**

- **Graphene Oxide (GO):**
 - One atomic sheet of graphite oxide.
 - Theoretical specific surface area is 2630 m²/g.

- **CNTs and graphene oxide are generating great attention as energy storage and fuel cell technologies because of their unique properties.**

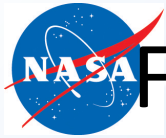

Fabrication of Dual Structure BNNT/CNT

- A new processing technique was developed to create BNNT/CNT dual layers.
- A wide variety of nanotube diameters can be fabricated ranging from 200 nm down to a few nm (SWNT?).
- In Phase I BNNT/CNT dual layers were demonstrated but in Phase II multiple layers will be examined (CNT/BNNT/CNT)
- Processing details are proprietary until a patent is filed on this method.

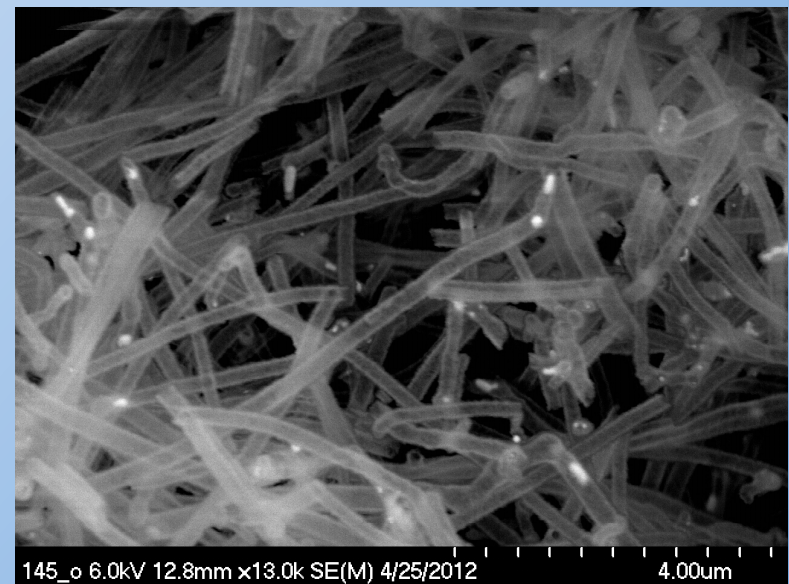
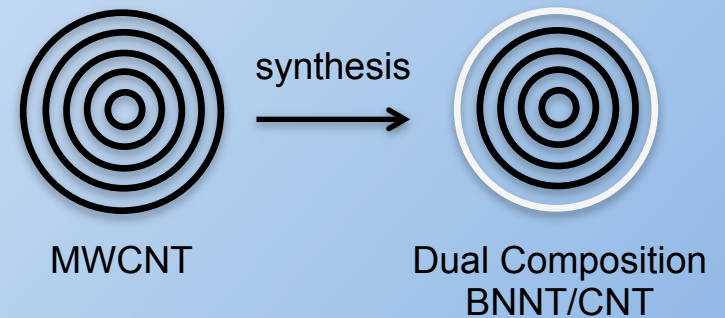

SEM micrograph of the dual composition BNNT/CNT

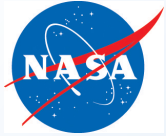

SEM Micrographs

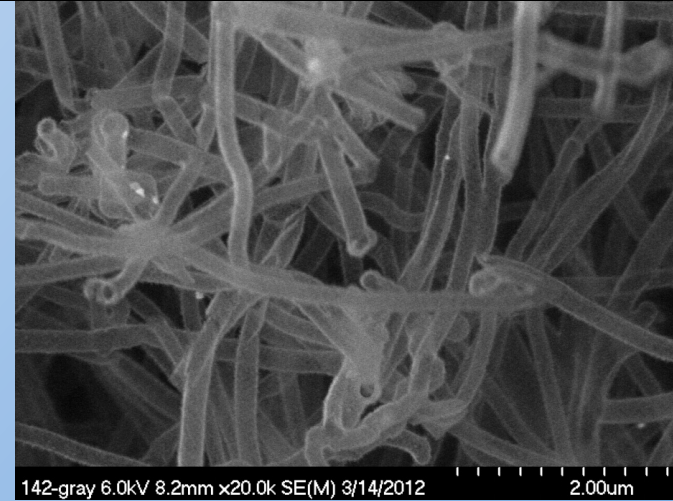
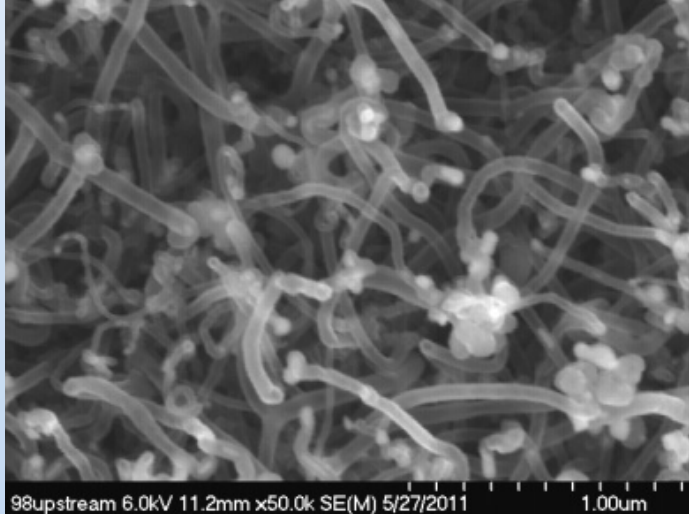
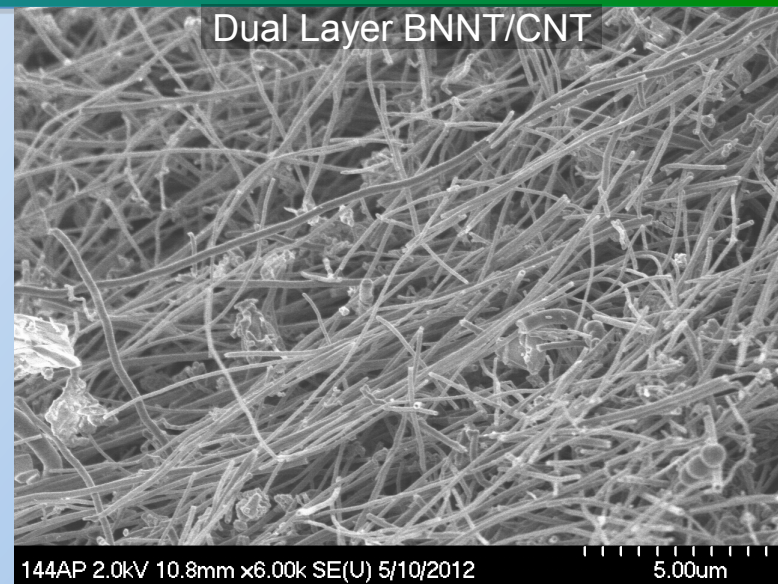
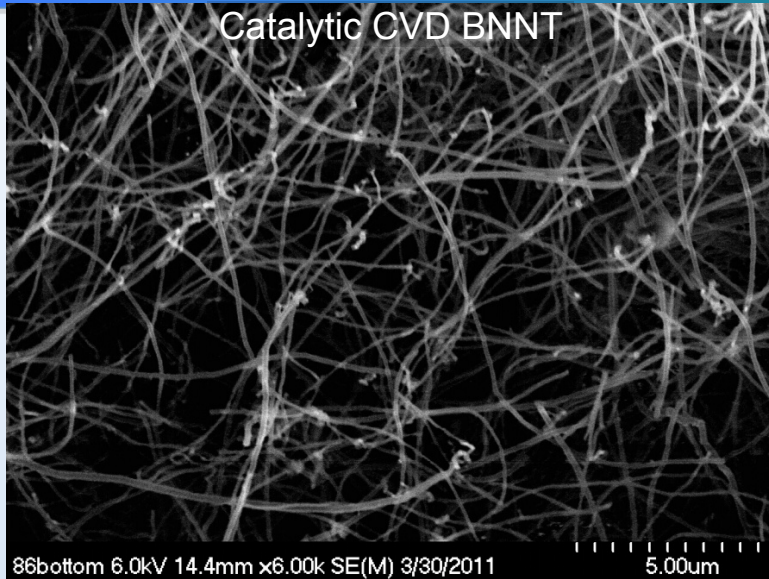

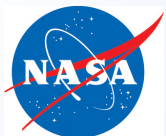

FTIR Characterization of BN

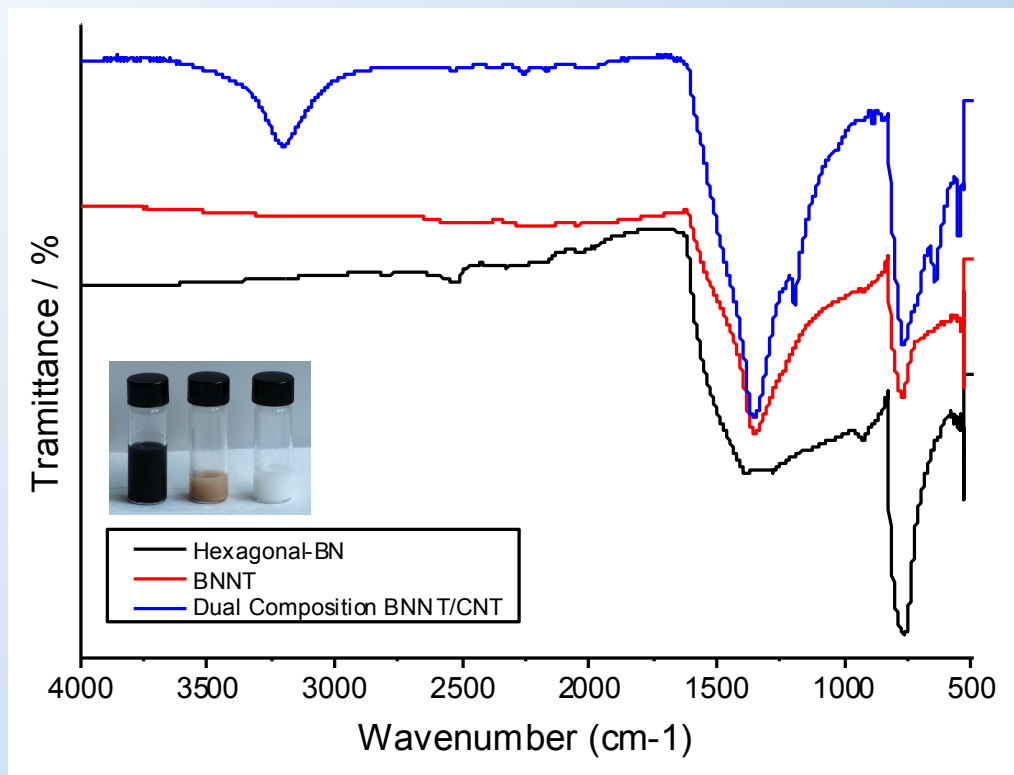

	Stretching Mode (cm ⁻¹)	Bending Mode (cm ⁻¹)
h-BN	1377.6	760.3
BNNT	1349.2	768.0
BNNT/CNT	1353.6	763.9

B-N stretching vibration mode perpendicular to the c-axis

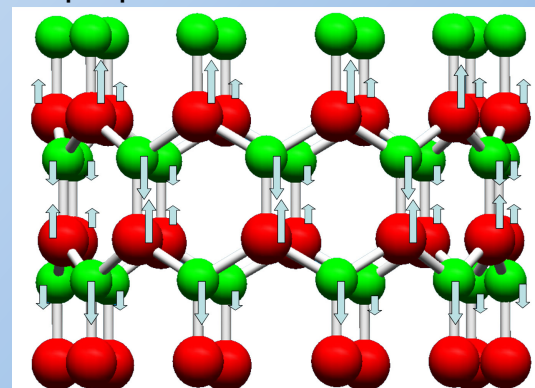

B-N-B bending vibration mode parallel to the c-axis

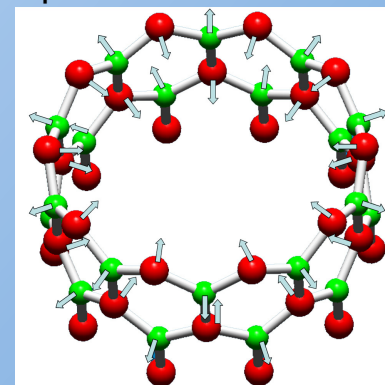

<http://www.phy.mtu.edu/yap/gallery.html>

Successful preparation of BNNTs using MWCNTs as template

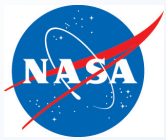

BNNT and BNNT/CNT Dual Structure Dispersion Study

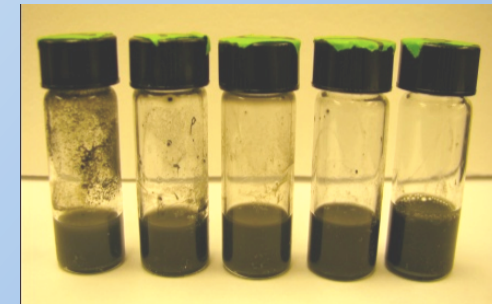
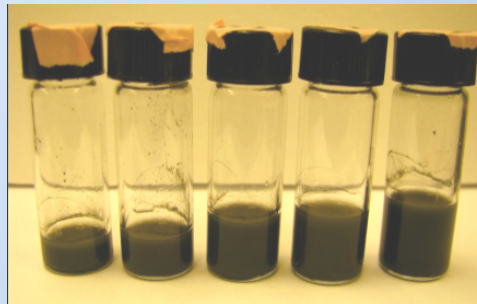
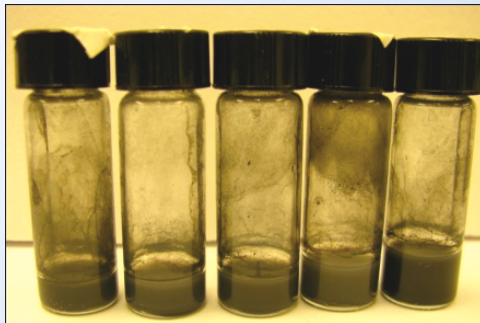

- **Isopropanol** was used to help with the dispersion and dry.

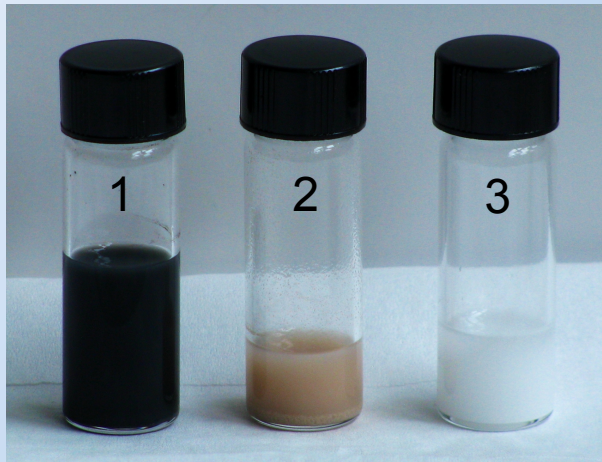

(1) BNNT, (2) **dual structure BNNT/CNT**, (3) hexagonal-BN all dispersed in isopropanol

- BNNT samples were tried to be dispersed on Nafion using two different approaches:
 - Using the same volume of Nafion and increasing the volume of isopropanol
 - Using the same volume of isopropanol and increasing the volume of Nafion.
- *BNNT/CNT dual structure dispersed using the same technique as BN.*



Tape Layers Preparation

- Very thin and small tape layers were prepared using the ink-paste slurries for the electrochemical characterization:
 - SWCNT
 - Mix of SWCNT and BNNT
 - BNNT
 - Dual Layer BNNT/CNT
- Problems were found trying to make thicker and bigger layers. Controlling the humidity and the temperature while the layers are drying we believe is the key to prepared these tape layers successfully.

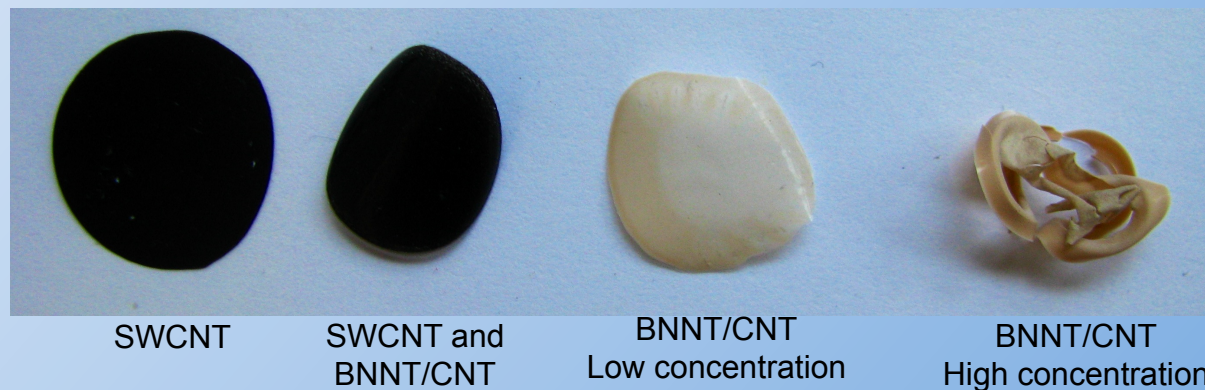



Electrochemical Analysis: SWCNT

- Double layer Capacitance:
 - Electrochemical processes that take place at the electrode/electrolyte interface.
 - One of the easiest way to see the availability of the surface of certain material to accumulate charge.

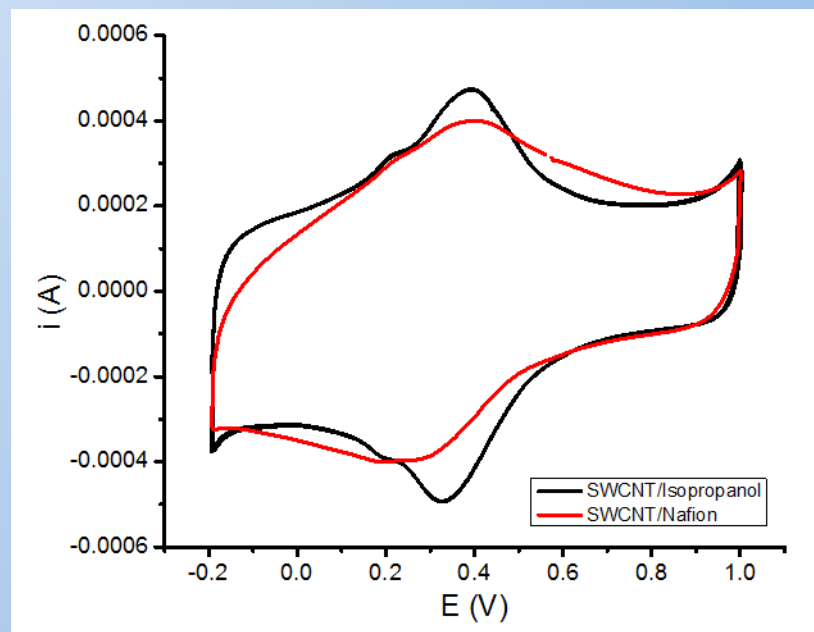
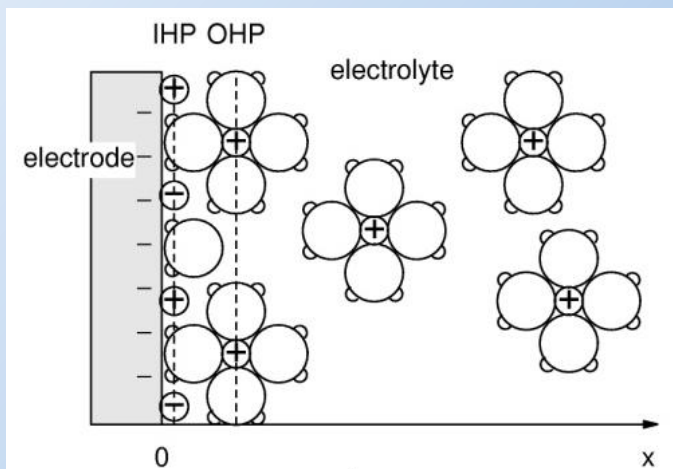

- SWCNT shows a great double layer capacitance.
- The polymer change the electrochemical behavior of the SWCNT, but still let them to keep most of their surface area.

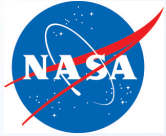

Electrochemical Analysis

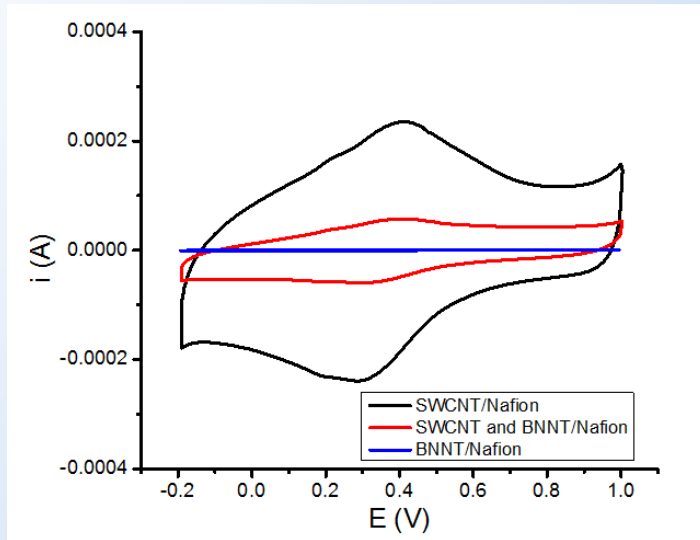

Cyclic voltammeteries of SWCNTs, SWCNTs mix with BNNTs and BNNTs, all dispersed in Nafion. Solution 0.5 M H₂SO₄, reference electrode of Ag/AgCl saturated in NaCl, and can rate of 25 mV/s.

- Dual composition BNNT/CNT was used.
- SWCNT passivates when is mix with BNNT as expected.
- The electrochemical activity of the BNNT is unnoticed compared to the samples containing SWCNT.

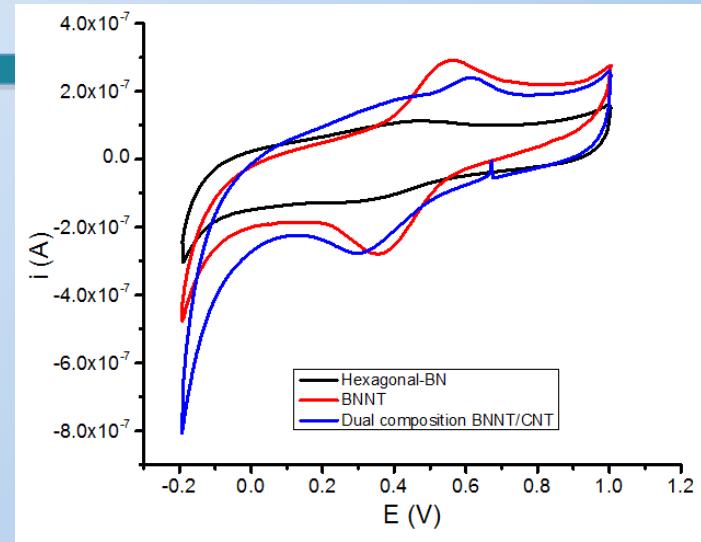

Cyclic voltammeteries of h-BN, BNNTs, and dual composition BNNT/CNT, all dispersed in isopropanol. Solution 0.5 M H₂SO₄, reference electrode of Ag/AgCl saturated in NaCl, and can rate of 25 mV/s.

- All the BN samples show a very small double layer capacitance in the range of 10⁻⁷ amperes doing these excellent materials to be use as a dielectric material.
- **Dual composition BNNT/CNT shows almost the same behavior than samples of just BN, although shows more current at the negative voltages that could be due to the dual structure of BNNT with CNT.**
- BNNT and dual composition BNNT/CNT show redox peaks that could be from some iron impurities from the synthesis process. This needs to be confirmed.



h-BN



BNNT



Dual Composition
BNNT/CNT

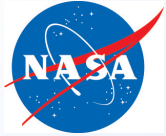

Development of Assembly Procedure

CNT/Nafion used as model system to develop assembly procedure

- A layered supercapacitor was assembled using the ionic polymer Nafion 117 as the electrolyte and SWCNTs as the electrodes.
- The use of Nafion 117 is for the following reasons:
 - To gain experience of assembling
 - To find the best condition for the assembly
 - To determine the best way to incorporate the current collector without damaging the device.
- The Nafion layer was thicker than the layers of SWCNTs before the preparation of the small device, but in the micrographs, the layer of Nafion is very thin compared with SWCNTs suggesting the use of too much pressure in the preparation.

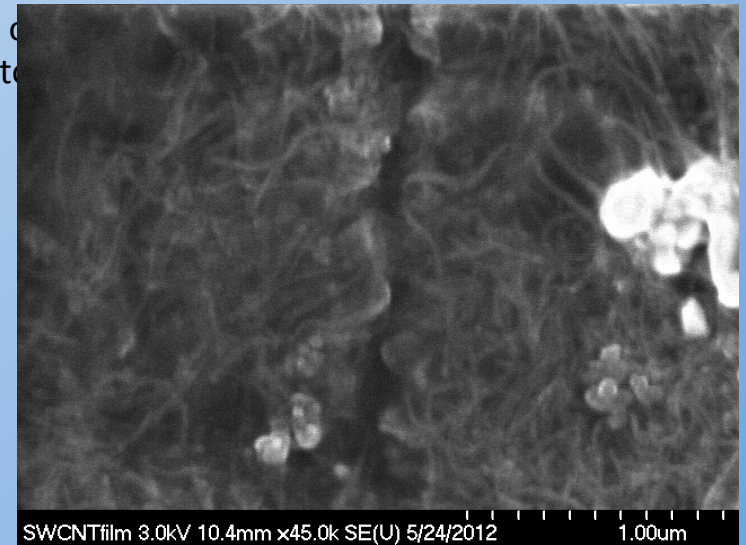
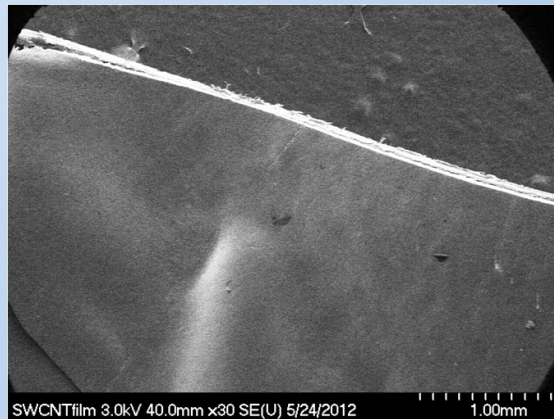
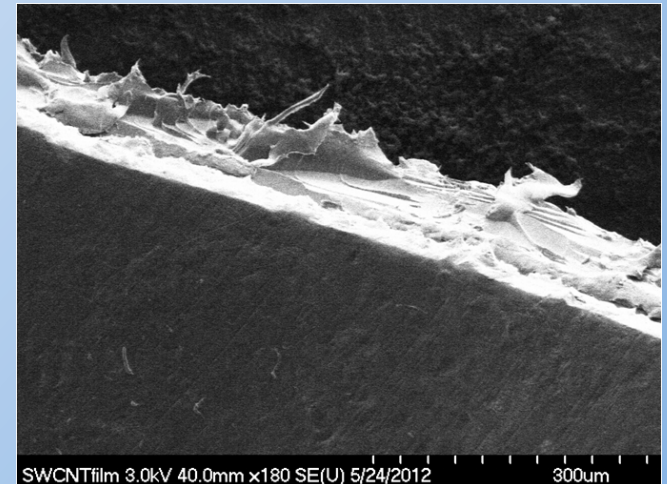



June 2012 Schedule

- Characterization of a new sample of dual composition of BNNT/SWCNT, expecting to have *Single Wall BNNTs*. TEM, FTIR, Electrochemistry, XRD and TGA analyzes are underway.
- Characterization of the SWCNTs oxidized by photo oxidation technique.
- The use of other polymers for the layers will be studied expecting to keep the double layer capacitance of SWCNTs and helping in the preparation of BNNTs layers.
- Impedance, capacitance and charge and discharge analysis also will be done to the new supercapacitors.

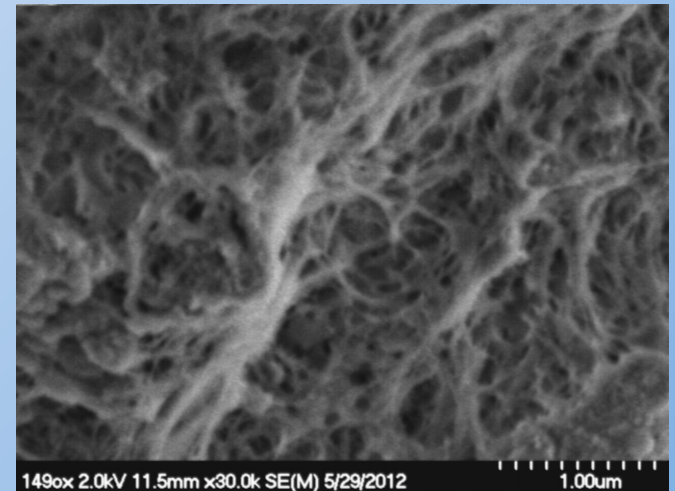

Preliminary SEM micrograph of the dual composition BNNT/SWCNT

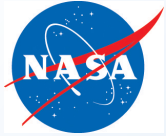

Summary of Accomplishments

- Nanotube growth technique developed for fabricating dual BNNT/CNT electrode structure.
- Dispersion technique developed for dispersing BNNT and BNNT/CNT dual structure in a polymer slurry.
- Fabrication of thin film containing BNNT and BNNT/CNT dual structure demonstrated through tape casting and spin coating
 - Difficulties encountered in fabricating larger samples
- Electrochemical properties of individual electrolyte and electrode layers measured
 - BNNTs show very small currents doing them excellent to be use as a dielectric material.
 - Dual composition BNNT/CNT shows almost the same behavior than samples of just boron nitride. More current at the negative voltages than BN samples could be due to the dual structure of BNNT with CNT.
 - SWCNTs demonstrate that have a great double layer capacitance. The use of a polymer change their electrochemical behavior but not too much the double layer capacitance.
- Assembly plan developed for fabricating supercapacitor device.



Next Steps

- **Task 1:** *Scale up the fabrication of the components of the conventional sandwich-type supercapacitor device using BNNTs in combination with single wall carbon nanotubes and graphene oxide electrode.*
- **Task 2:** *Fabrication of super-nanocapacitors using dual BNNT/CNT structure*
- **Main Milestone:**
 - Assembly technique developed for supercapacitor device (9/12)
 - Fabrication process developed for applying current collector to supercapacitor device (12/12)
 - Process developed for producing multiple layers of dual BNNT/CNT structure (3/13)
 - Electrochemical characterization of multiple layers of dual BNNT/CNT structure (6/13)
 - Supercapacitor properties measured at high temperature (11/13)
 - 2nd iteration of multiple layers of dual BNNT/CNT structure fabricated (9/13)
 - Electrochemical characterization of 2nd iteration multiple layers of dual BNNT/CNT structure (11/13)