

# Design of an 8-40 GHz Antenna for the Wideband Instrument for Snow Measurements (WISM)

Timothy E. Durham\*, Kenneth J. Vanhille\*\*, Christopher R. Trent \*, Kevin M. Lambert\*\*\*, and Félix A. Miranda\*\*\*\*

\*Harris Corporation, Melbourne, FL; \*\*Nuvotronics, Inc., Durham, NC, \*\*\*Vantage Partners, LLC, Cleveland, OH; \*\*\*\*NASA Glenn Research Center, Cleveland, OH

## I. Introduction

This poster describes the implementation of a 6x6 element, dual linear polarized array with beamformer that operates from about 8-40 GHz. It is implemented using a relatively new multi-layer microfabrication process. The beamformer includes baluns that feed dual-polarized differential antenna elements and reactive splitters that cover the full frequency range of operation. This fixed beam array (FBA) serves as the feed for a multi-band instrument designed to measure snow water equivalent (SWE) from an airborne platform known as the Wideband Instrument for Snow Measurements (WISM).



The WISM Antenna Feed is part of an instrument intended to measure various characteristics of snow.

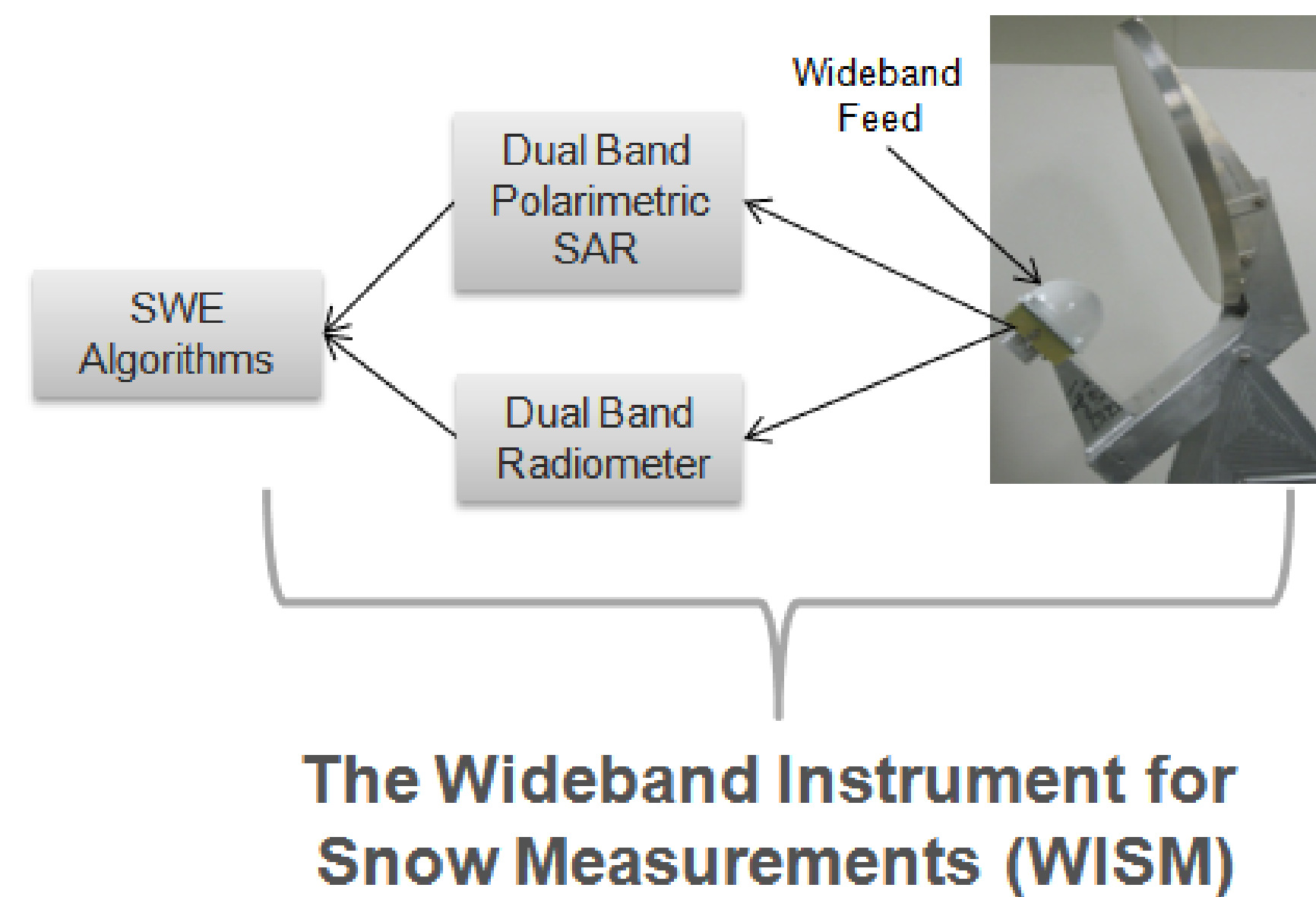

The Wideband Instrument for Snow Measurements (WISM)

## II. Technology Background

The WISM FBA is based on the current sheet antenna concept patented and developed at the Harris Corporation. Near decade bandwidth is achieved by controlling the mutual coupling between elements to achieve a relatively constant active impedance. Traditional fabrication techniques have limited achievable upper bandwidth to about 18 GHz. Use of the Nuvotronics, Inc. PolyStrata fabrication process, a wafer-scale, batch fabrication technique, has enabled the WISM FBA to achieve good performance up to Ka-band while also incorporating all required beamformer components into the antenna.

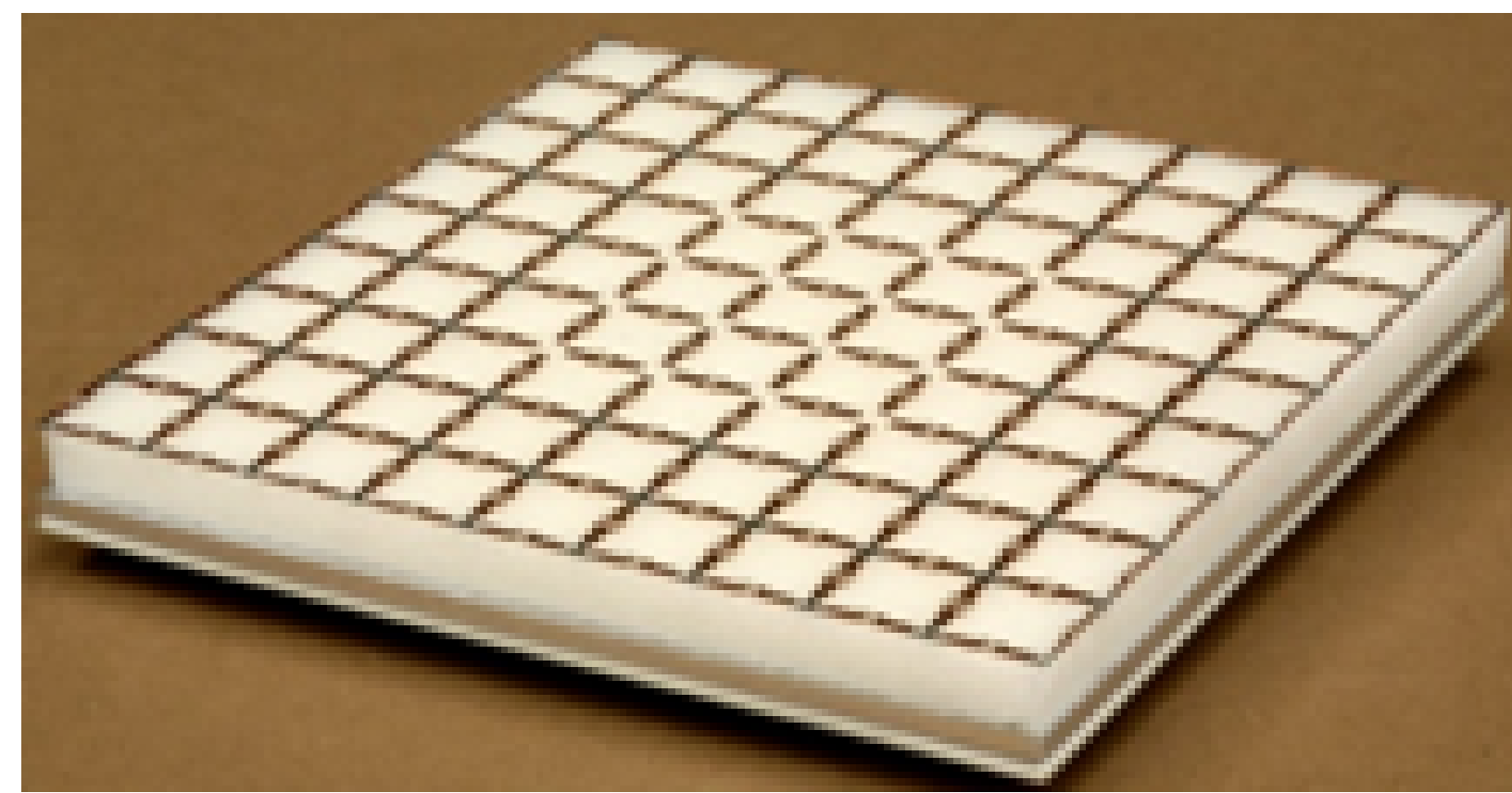

A Current Sheet Array manufactured with traditional printed circuit board technology.

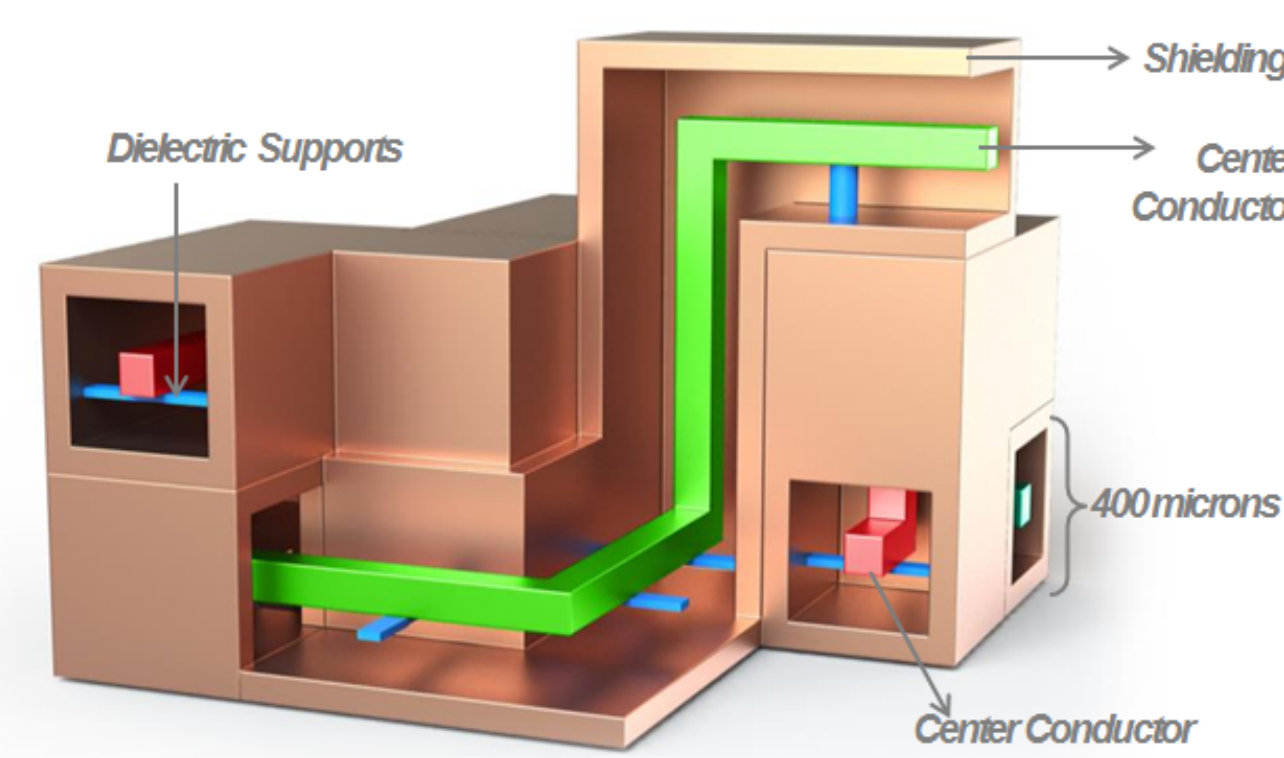

The PolyStrata® process enables integration of aperture and beamformer containing high density components and interconnects.

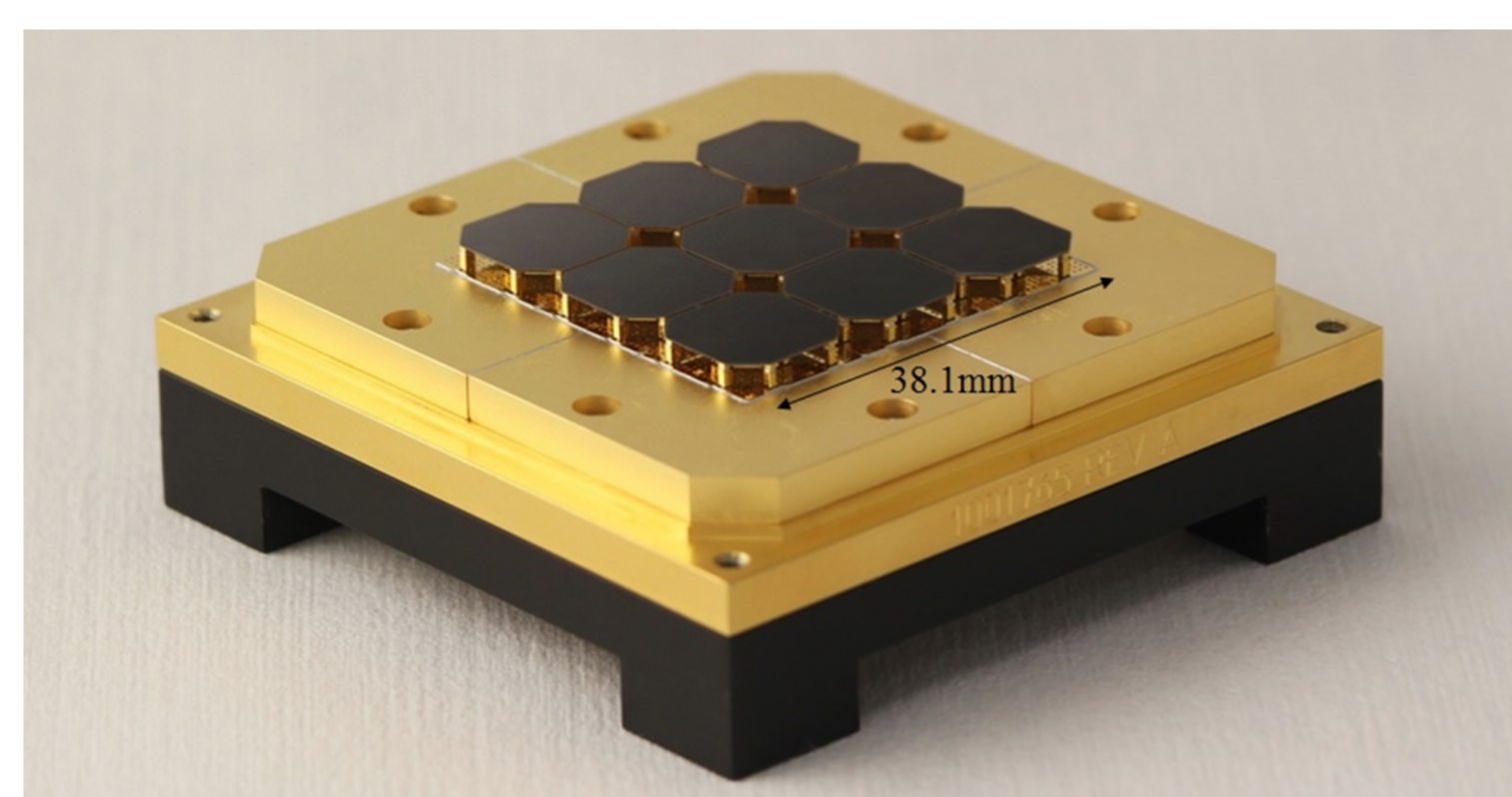

Highly integrated multi-octave millimeter-wave antenna.

## III. Antenna Architecture

The WISM antenna feed is constructed of several fundamental building blocks. A modular approach is key to building larger arrays later and allows for the potential reuse of existing modules. The feed network was designed to provide secondary beamwidths that were somewhat constant at the different frequency bands.

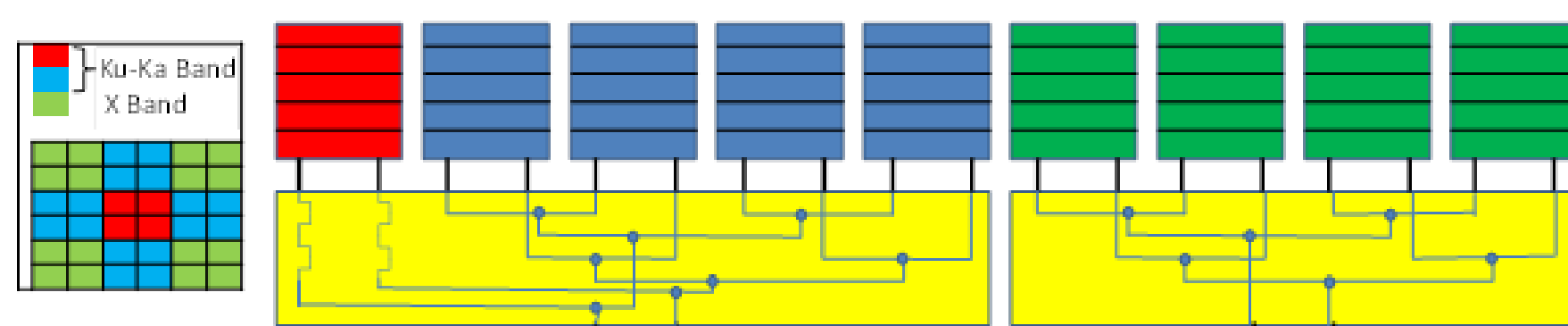

Pictorial representation of the feed network.

(Right) Block diagram of the 6x6 element WISM antenna feed. Each of the nine building blocks is a 2x2 element sub-array. The illumination scheme can be changed by changing only the combining network shown on the right side of the figure.

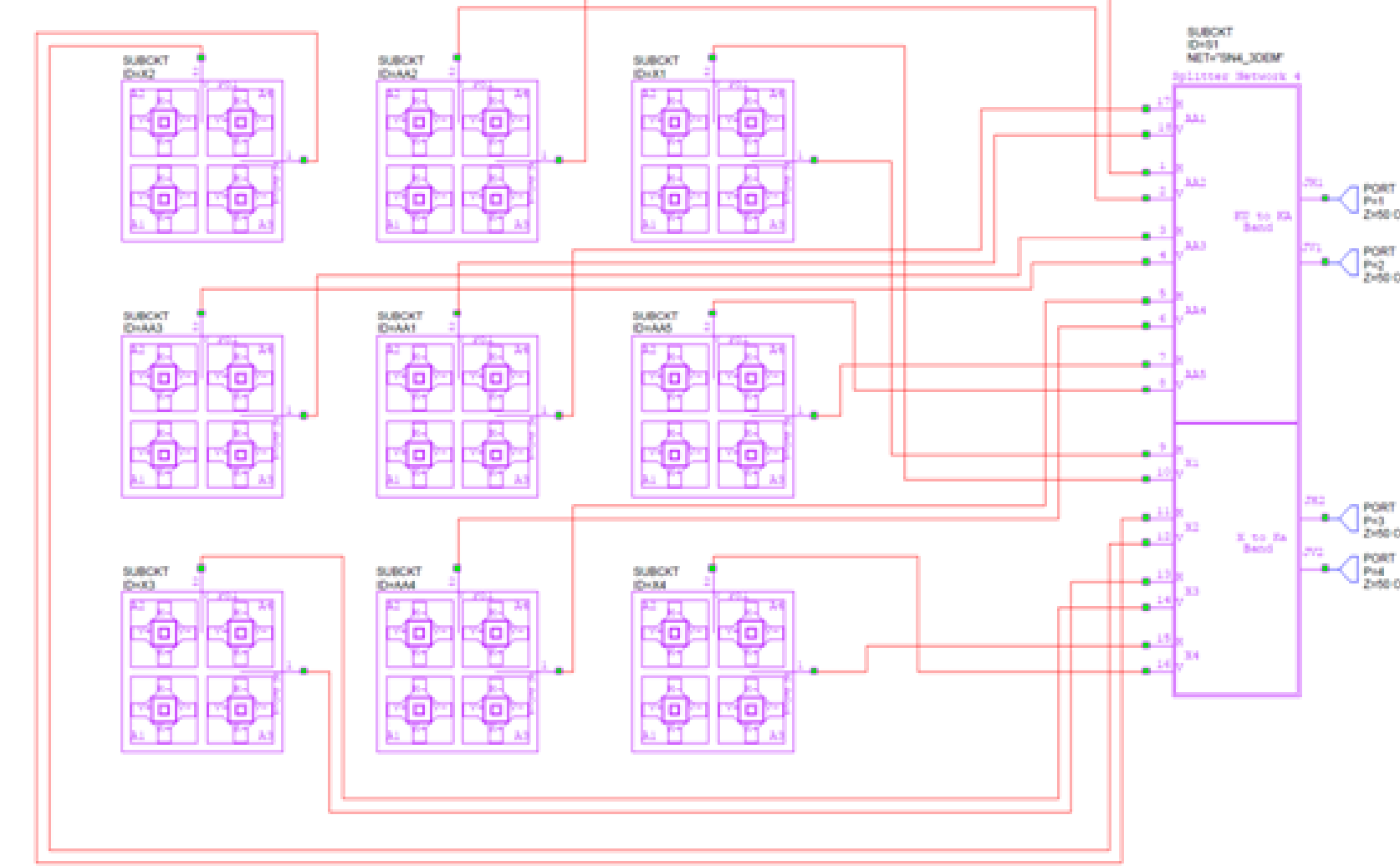

## IV. The 2x2 Antenna Modules

Each antenna module is dual polarized and differentially fed. This requires 16 RF connectors to each module. Splitters combine pairs of elements and baluns combine the differential pairs.

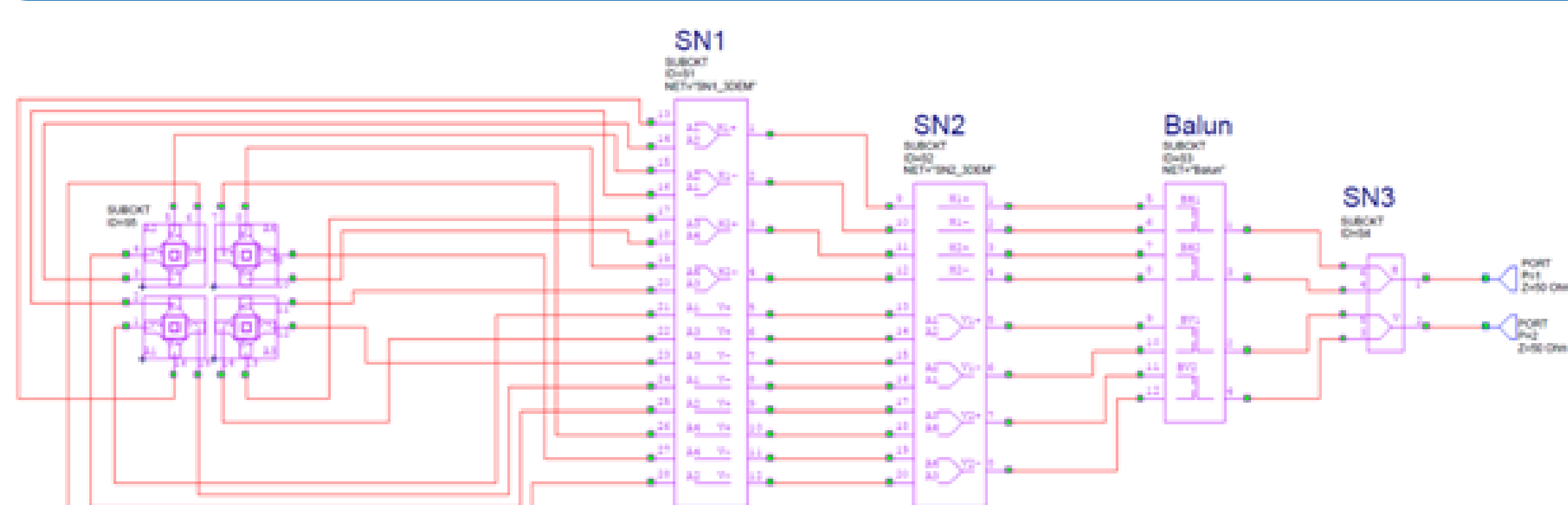

The block diagram of a 2x2 element sub-array that constitutes the basic array building block.

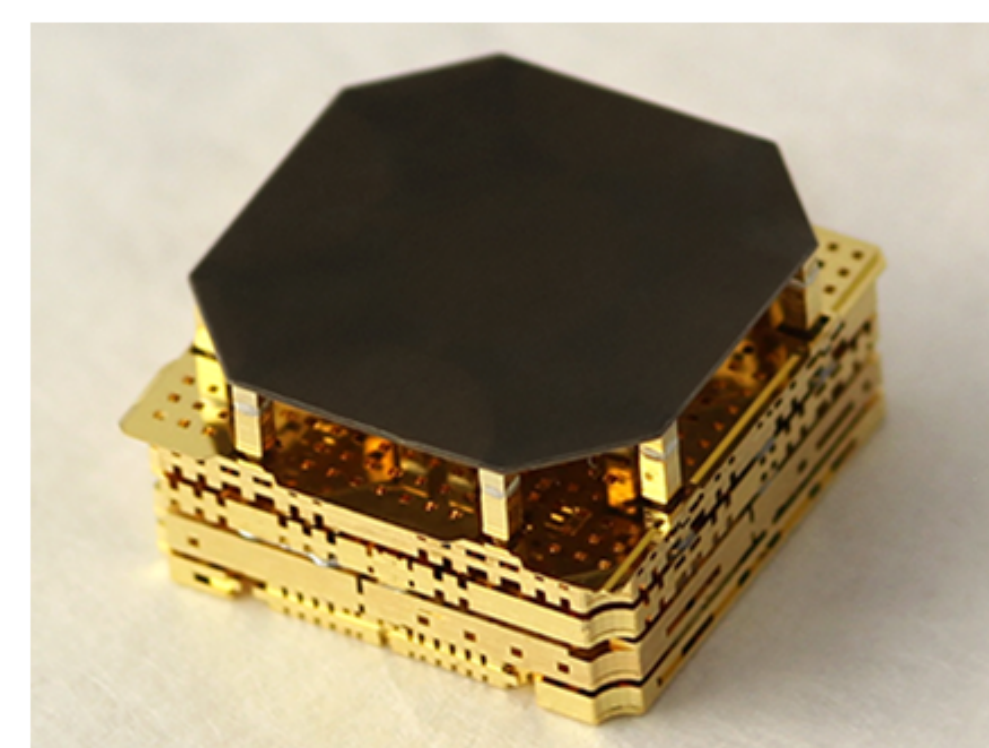

Photograph of an actual 2x2 element sub-array.

## V. Component Performance

Several different components had to be designed for inclusion in the antenna. These included the radiating elements themselves, baluns, splitter networks, vertical transitions, and transitions to connectors. Each was designed, fabricated, and tested individually before being included in the final antenna. Simulations were performed using ANSYS® HFSS™.

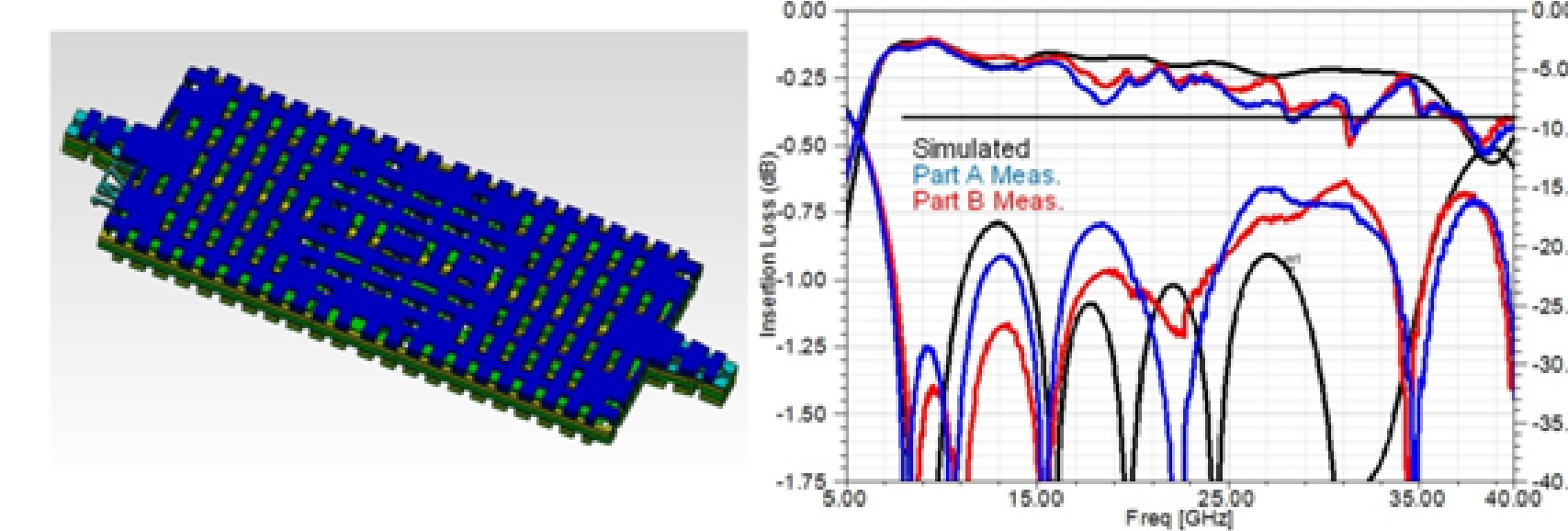

(Left) 3-D model of 8-40 GHz splitter test fixture. (Right) Measured vs simulated performance for two different test fixtures.

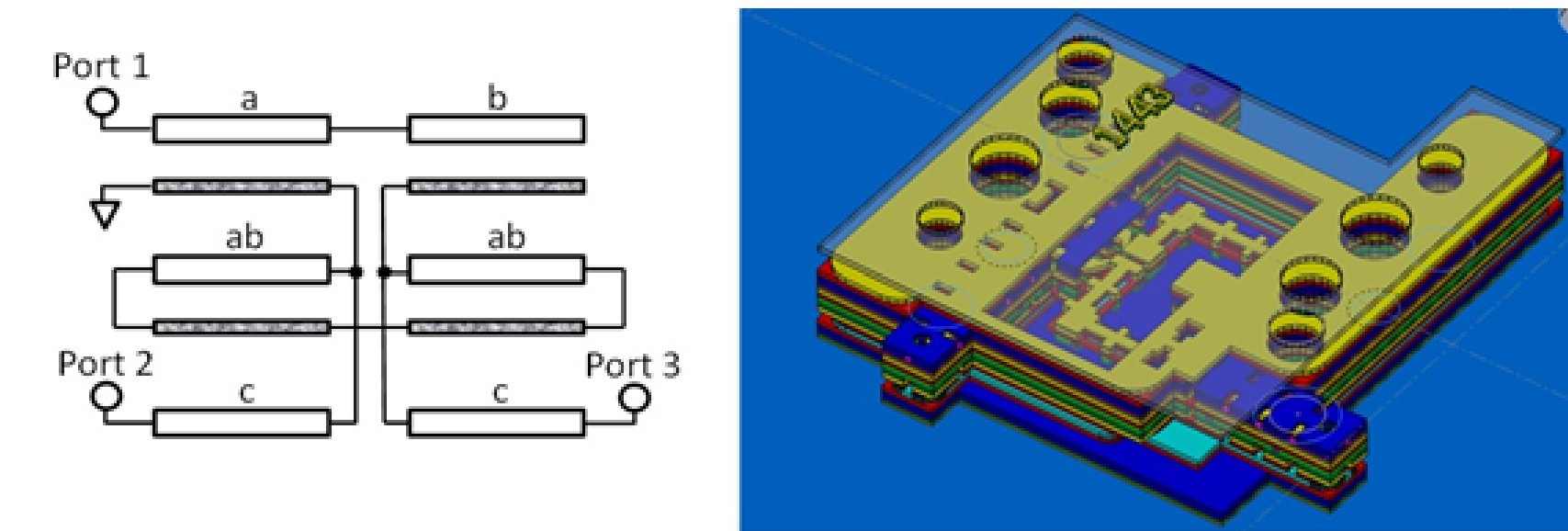

(Top Left) Balun circuit diagram. (Top Right) 3-D model of a single-balun test piece. (Right Upper) Measured vs. simulated |S<sub>21</sub>| and |S<sub>31</sub>| performance in dB of the balun test structure (Right lower) Measured vs. simulated phase difference (180 degrees is the goal across frequency).

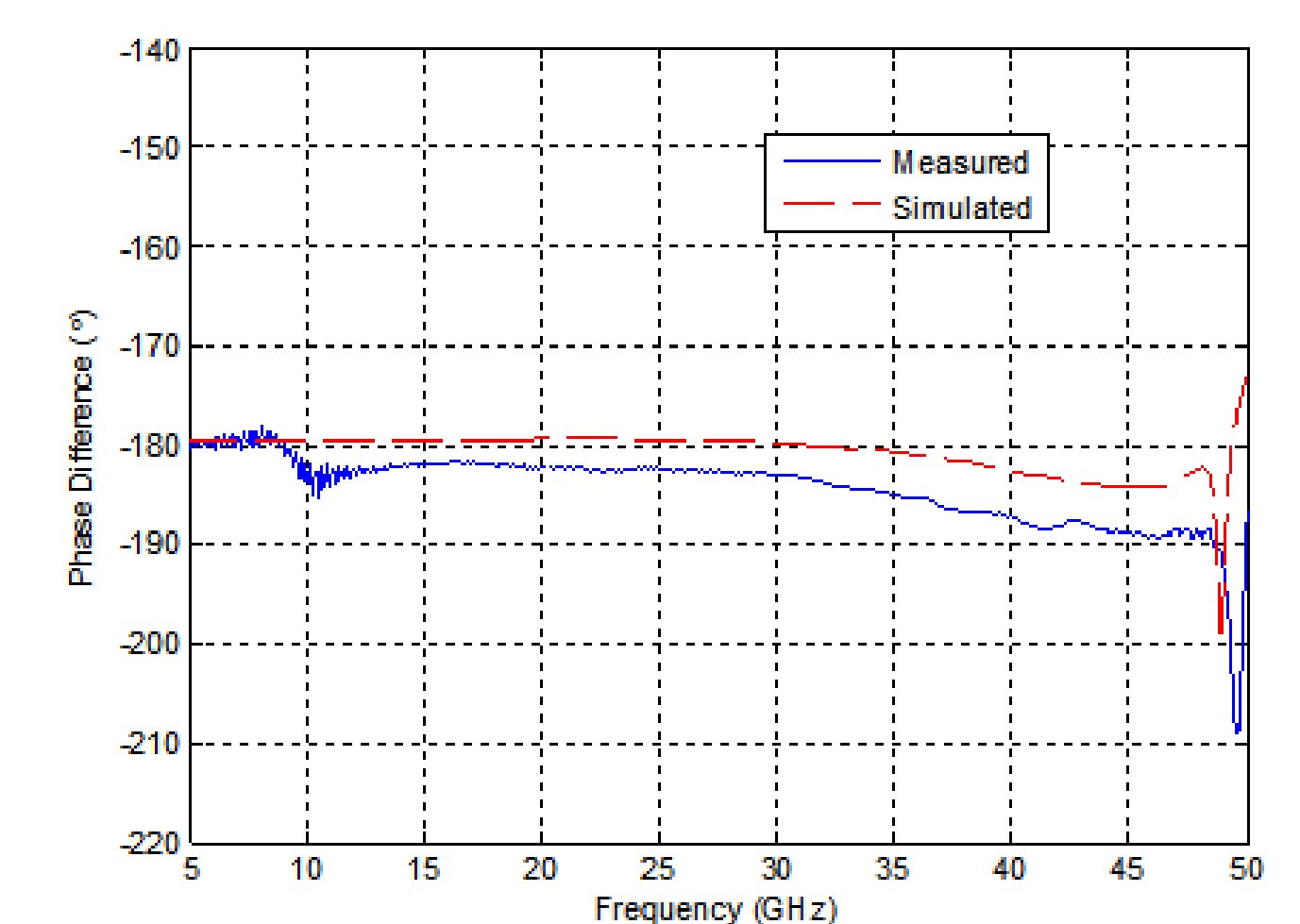
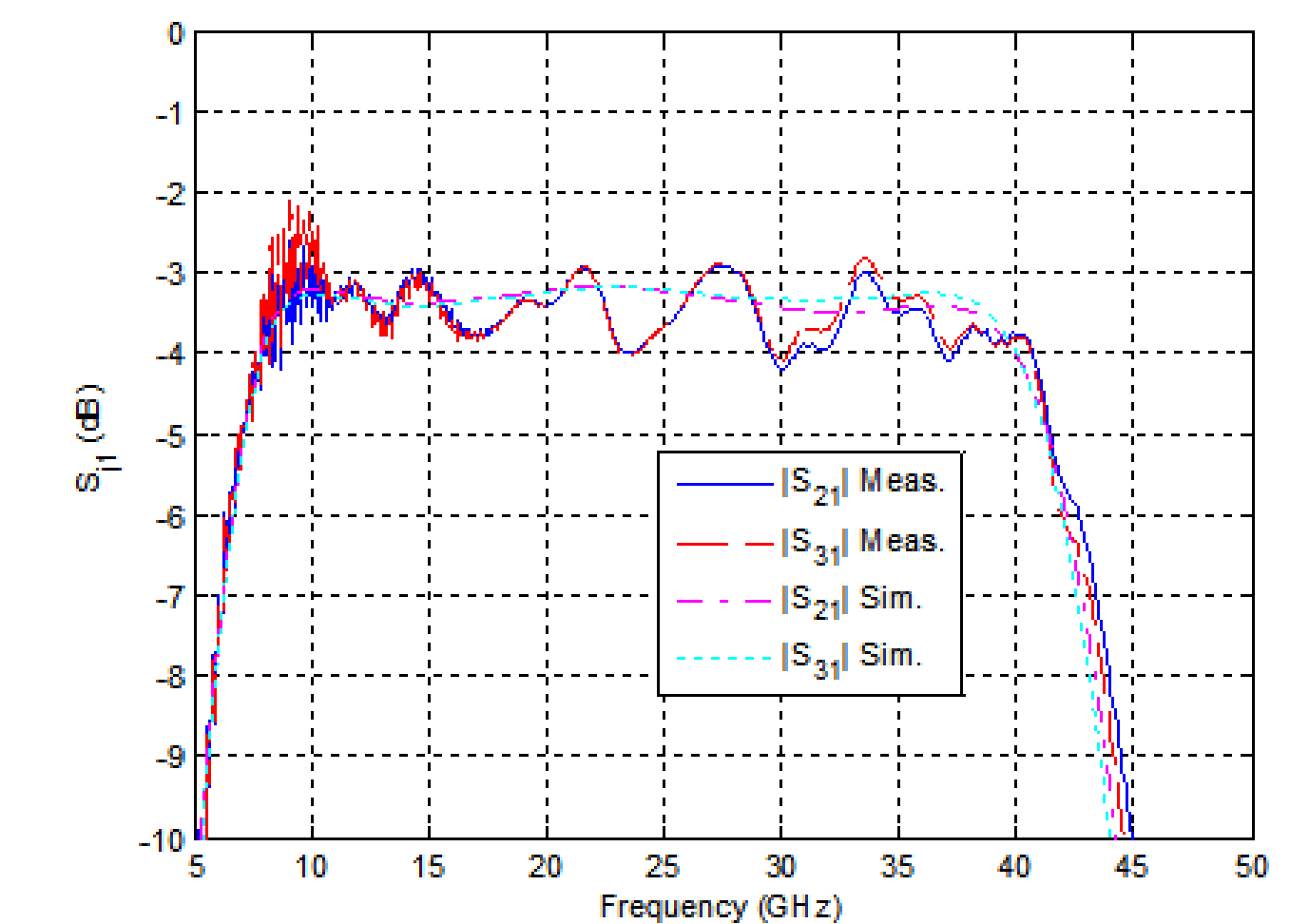

## VI. Measured Beamformer Performance

A time domain measurement was performed so that that the overall performance of the beam-forming network could be assessed. The use of time gating allowed the reflections caused by the radiating elements to be removed.

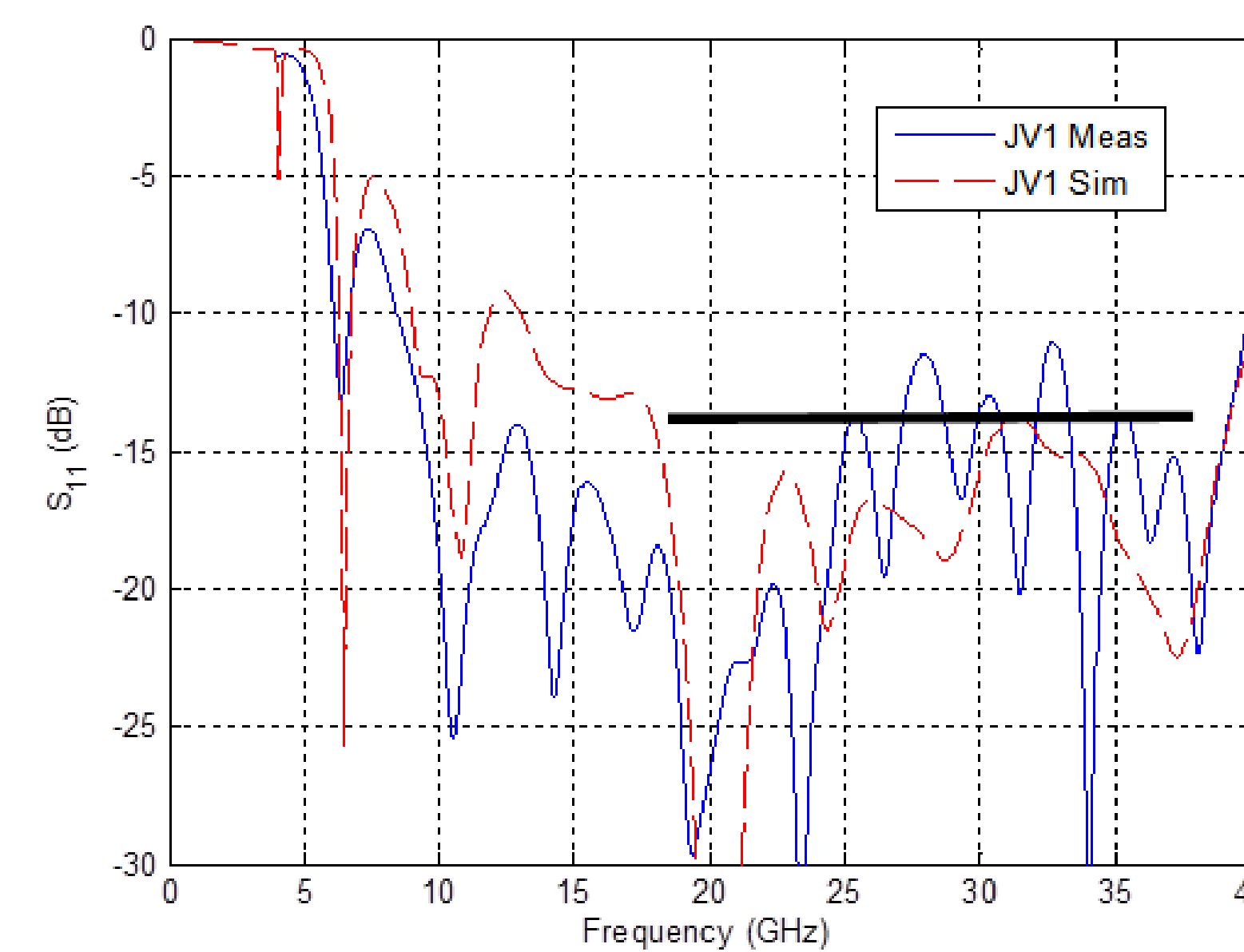

Measured vs simulated performance of the beam-forming network for the Ku-Ka-band portion of the array for vertical polarization with radiating elements gated out.

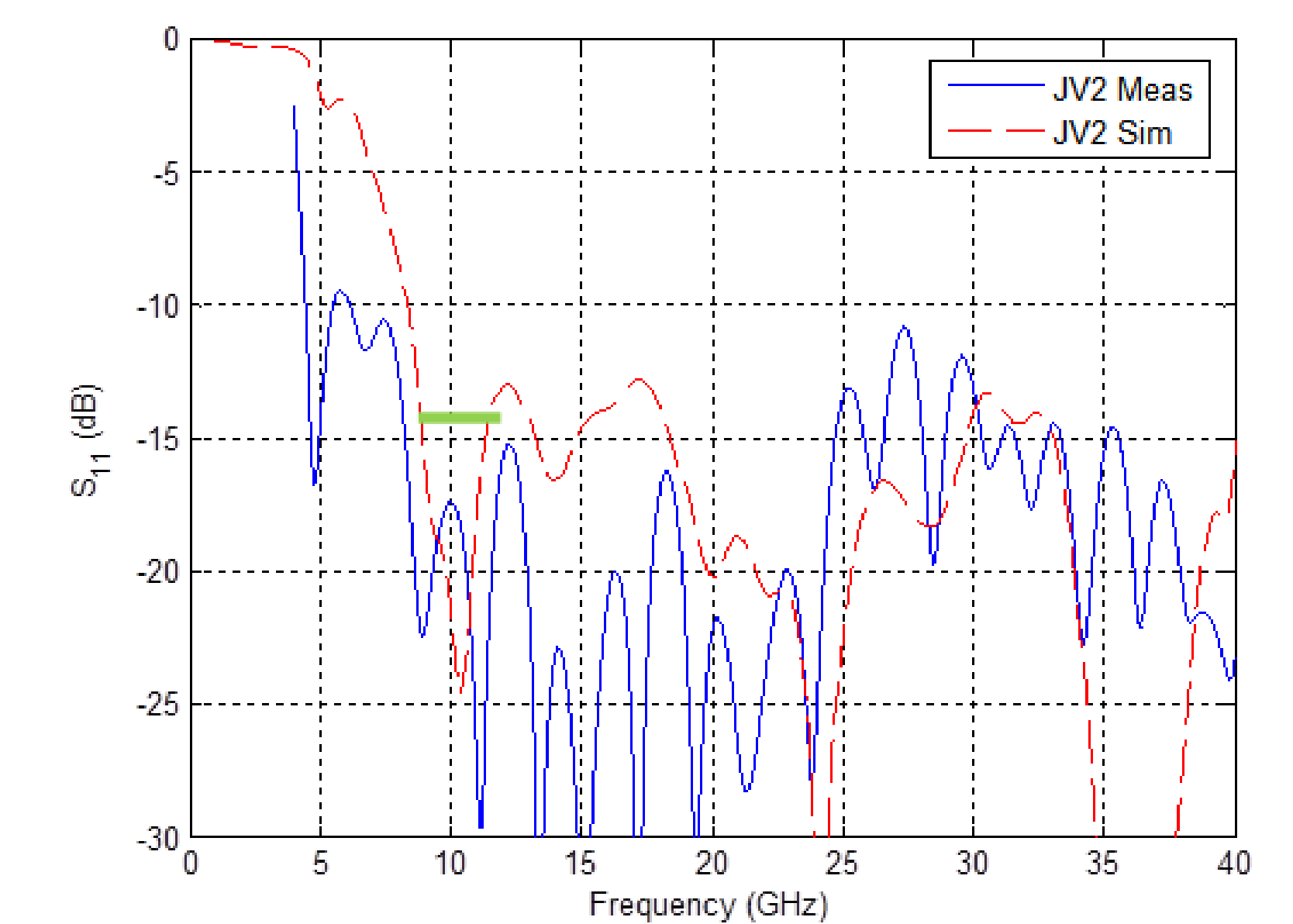

Measured vs simulated performance of the beam-forming network for the X-band portion of the array for vertical polarization with radiating elements gated out.

## VII. Secondary Predicted Performance

The design and layout of the aperture illumination allowed for minimal variation of the antenna beamwidth over frequency as required for improved radar/radiometer performance. This is shown in the predicted contour patterns below.

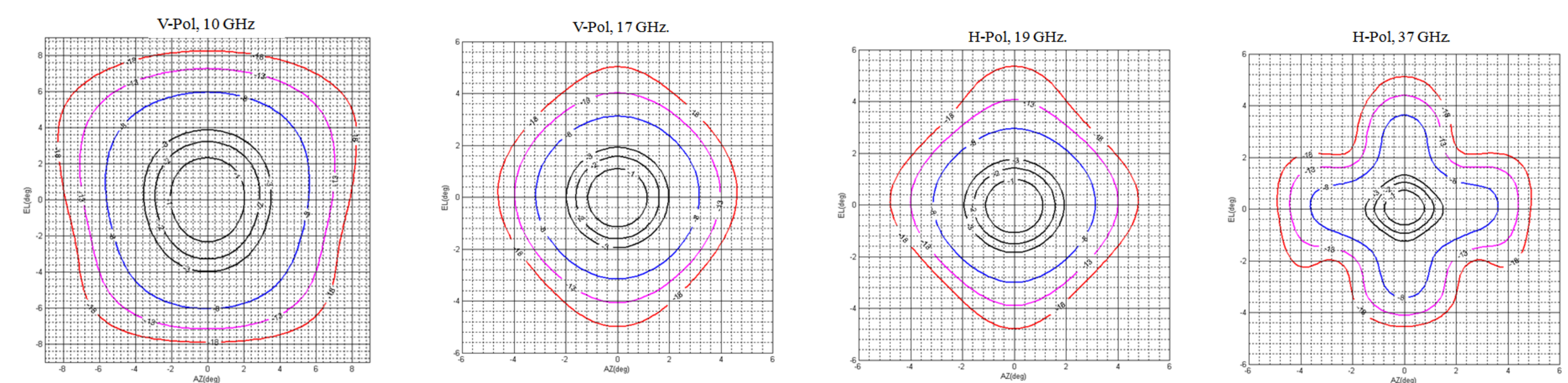

## VIII. Concluding Remarks

The WISM antenna design has been validated by both primary and secondary measurements of the antenna. The results of these measurements are covered in a companion paper in this session titled "Antenna Characterization for the Wideband Instrument for Snow Measurements", by Lambert, et al.

## IX. Acknowledgments

The authors acknowledge the support of NASA's Earth Science Technology Office (ESTO) Instrument Incubator Program (IIP) in furthering the "Enhancement, Demonstration, and Validation of the Wideband Instrument for Snow Measurements (WISM)," work.