

# Volumetric measurement of ultra-long ablation of geologic samples under high vacuum for in situ dating of planetary samples

**Damien Devismes<sup>1</sup>, Barbara Cohen<sup>1</sup>, Harlan Haight<sup>1</sup>**

<sup>1</sup>NASA Marshall Space Flight Center, Huntsville



EMSLIBS 2015 - Linz

# KArLE PROJECT

In situ rock dating on planetary surfaces



## HOW?

Based on K-Ar method:

$$t = \frac{1}{\lambda} \ln \left[ \frac{{}^{40}\text{Ar}^*}{{}^{40}\text{K}} \left( \frac{\lambda}{\lambda_e} \right) + 1 \right]$$

${}^{40}\text{K} \rightarrow {}^{40}\text{Ar}$  (half life:  $1,25 \cdot 10^9$  years)

${}^{40}\text{Ar} \rightarrow$  Mass Spectrometry

%K  $\rightarrow$  LIBS

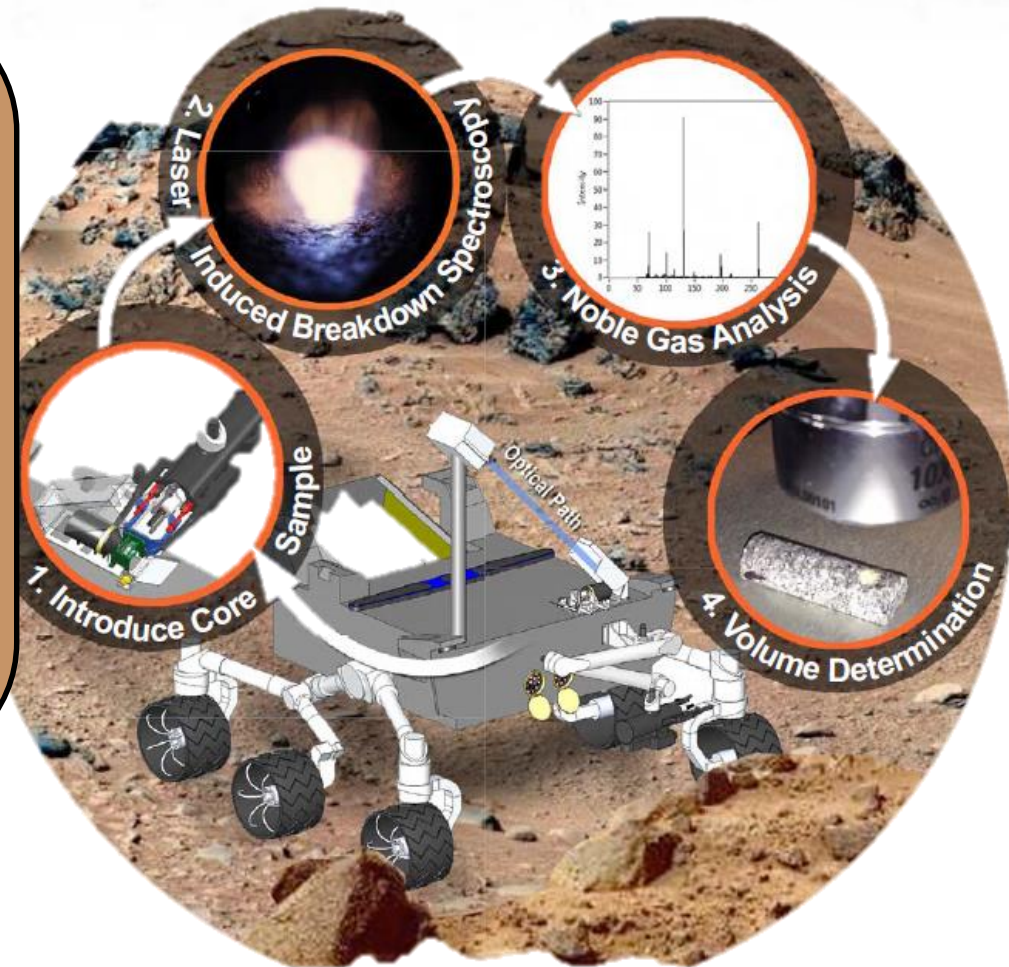

# Ablated mass measurement

$$t = \frac{1}{\lambda} \ln \left[ \frac{{}^{40}\text{Ar}^*}{{}^{40}\text{K}} \left( \frac{\lambda}{\lambda_e} \right) + 1 \right]$$

$${}^{40}\text{K} = a \text{ \%K} \frac{v d}{M_K} N_A$$

${}^{40}\text{Ar}^*$

${}^{40}\text{K}$

$$\underbrace{v \times d}_{=} m_{\text{ablated}}$$



# THE NEED FOR ULTRA-LONG ABLATION

The ablated mass has to free enough  $^{40}\text{Ar}$   
to be measured by the QMS.

We need ultra-long ablation (>100 pulses)

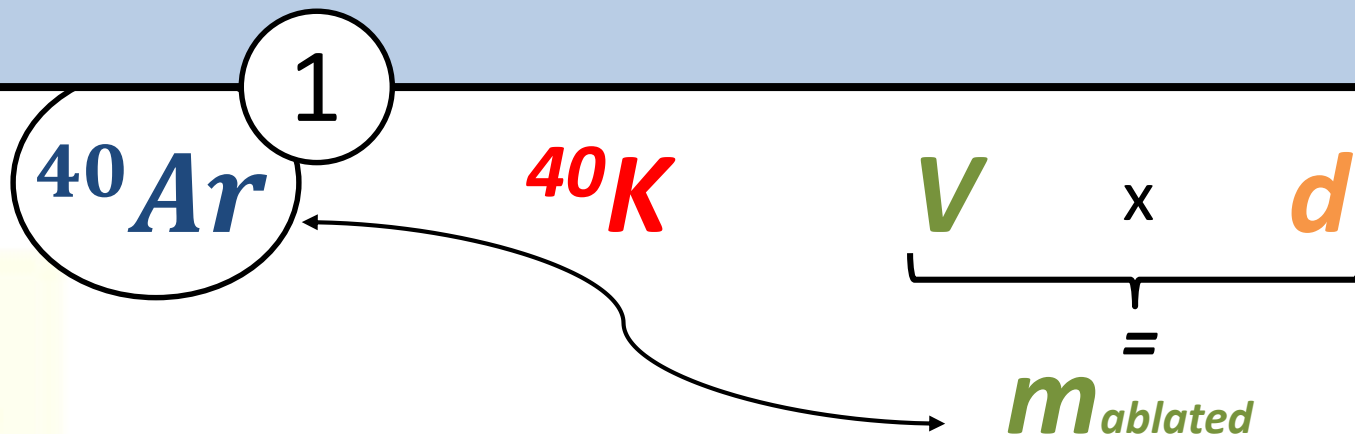

# MEASURING MASS IN SITU

How to measure, in situ, the ablated volume ?

How can we reduce the uncertainties ?

2

$^{40}\text{Ar}^*$

RSD :  $\pm 5\%$

$^{40}\text{K}$

$\pm 8 - 15\%$

$V \times d$   
 $\pm 10 - 15\%$   
=

$m_{\text{ablated}}$





# SOLUTIONS

## TO MEASURE THE ABLATED VOLUME:

- Optical system has to be able to measure a pit of about  $\varnothing$  500  $\mu\text{m}$  and several 100  $\mu\text{m}$  depth.
    - Z-stacking
    - Stereoimaging
  - Use the continuum of the LIBS spectra to estimate the ablated volume.
- ... we need to also estimate the material density.



# A NEW APPROACH

## DIRECTLY MEASURING THE ABLATED MASS VIA THE PLASMA DEPOSITS

- Use a Quartz Crystal Microbalance (QCM)
- High sensitivity
  - Can work at high vacuum
  - LOD of  $10^{-8}$  to  $10^{-7}$ g (the total ablated mass is about  $10^{-5}$  to  $10^{-4}$  g)
  - Used on Mars Pathfinder (Sojourner) and more recently on Rosetta

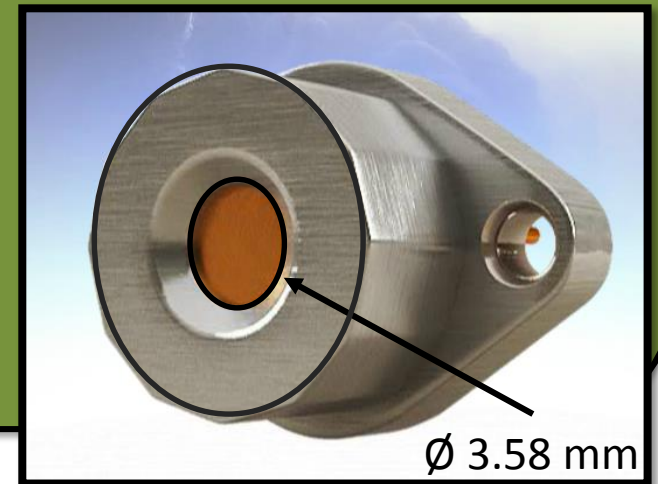

# QCM PROTOCOL

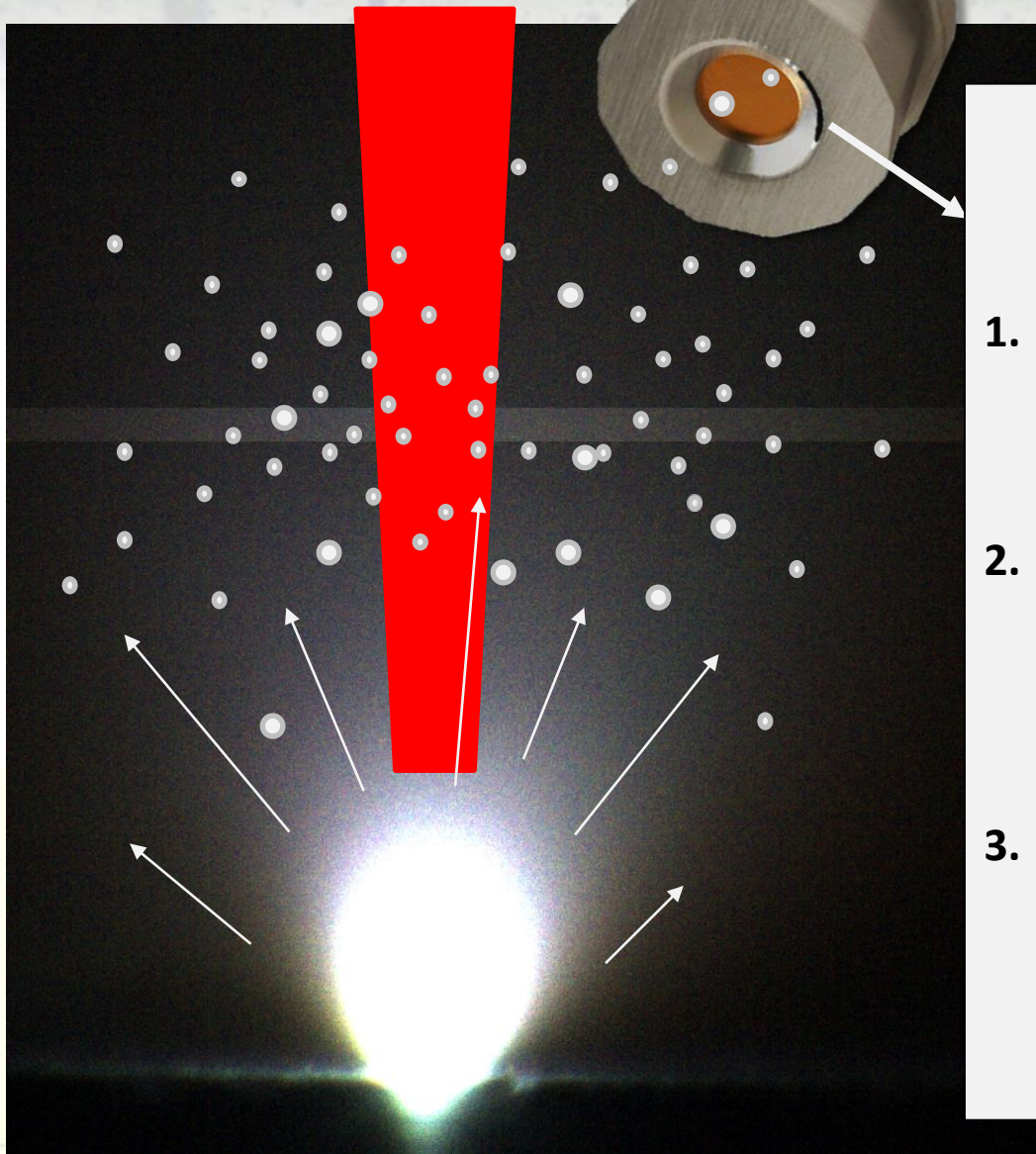

**To measure the ablated mass :**

- 1. Assume a constant pattern of the PD at the scale of the ultra-long ablation.**
- 2. Assume that the measured mass at the sensor is a constant fraction of the ablated mass.**
- 3. Optimize the experimental setup (sensor position, distance, etc) to reliably measure the mass fraction as a function of mass.**





# PRELIMINARY STUDIES



# EXPERIMENTAL

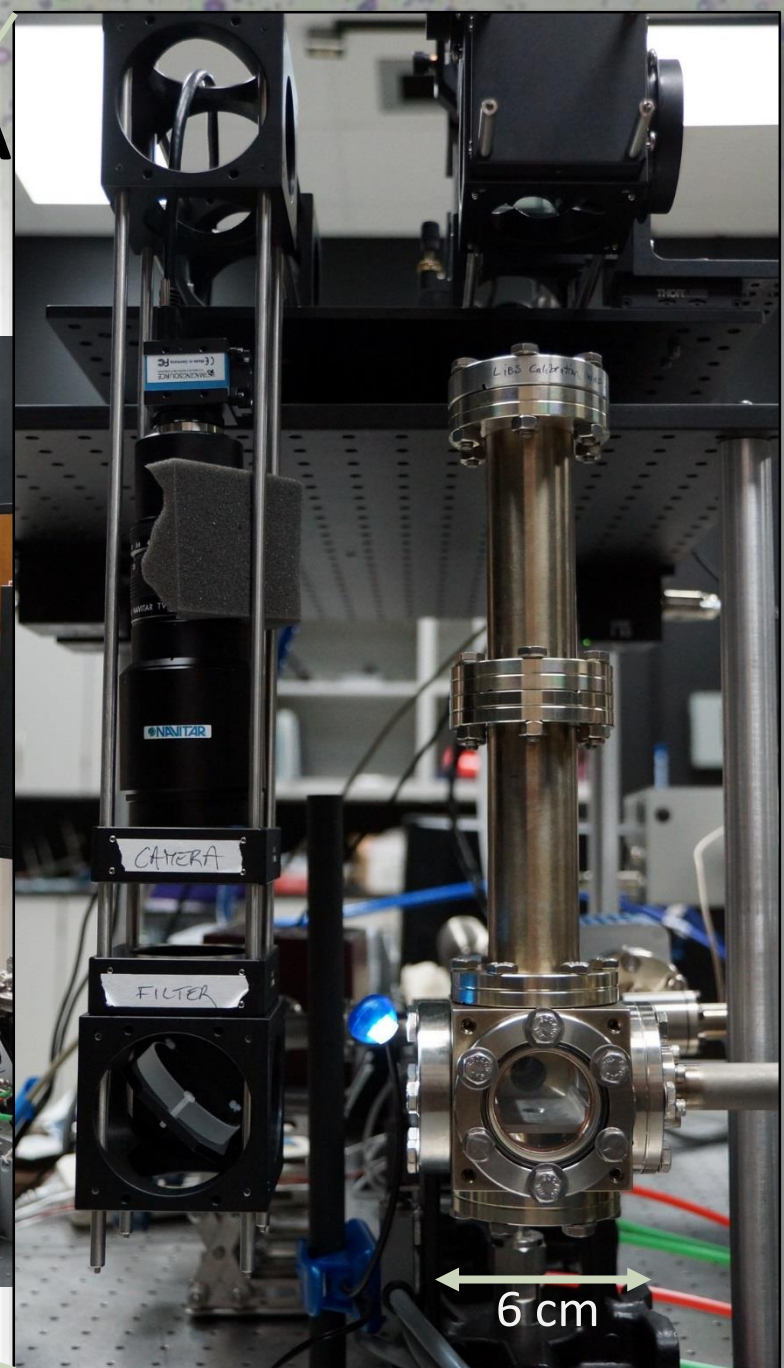
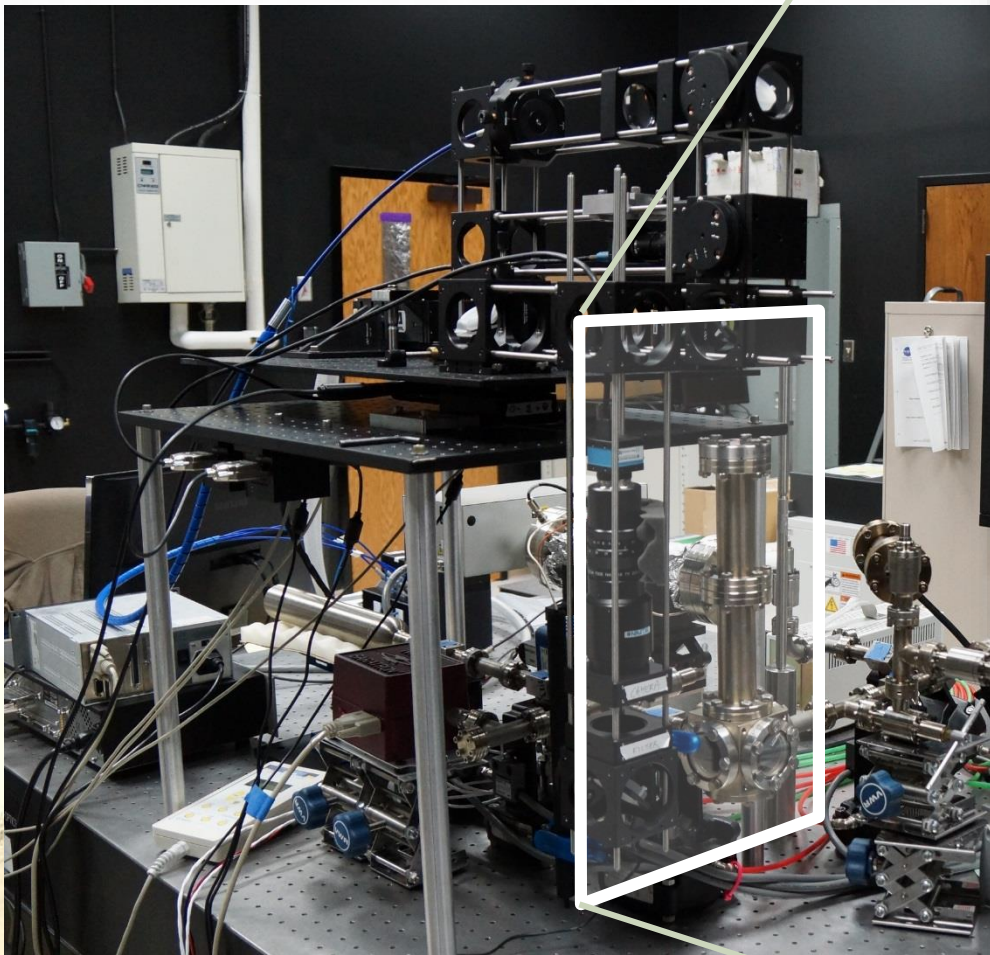



# EXPERIMENTAL SETUP

Laser Quantel Ultra Big sky laser series  
Wavelength: 1064 nm  
Energy: 55 mJ  
Frequency: 10 Hz  
Pulse duration: 14 ns  
Irradiance: 2 GW/cm<sup>2</sup>

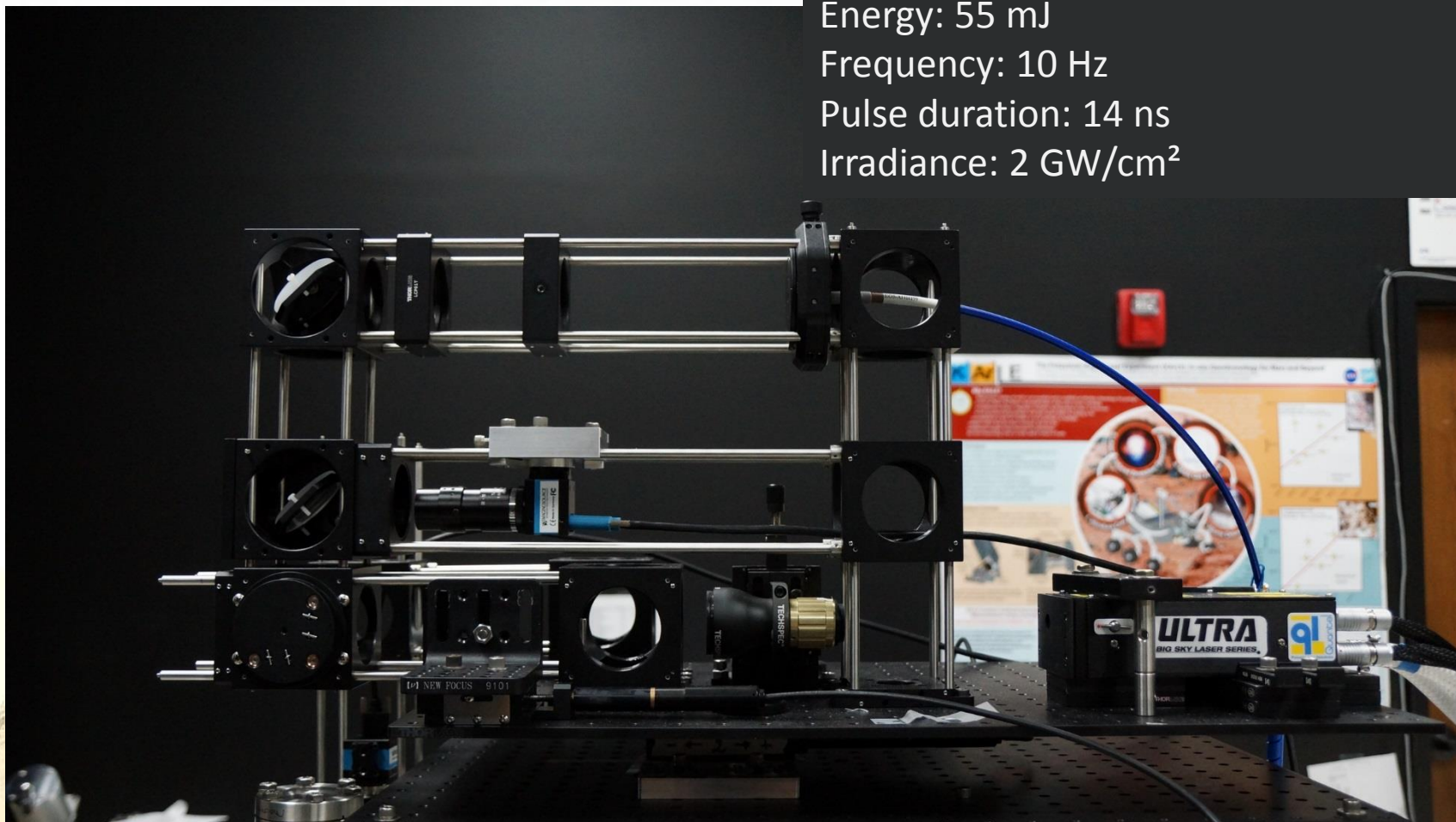

# PLASMA DEPOSITS PATTERN

## Detection and counting

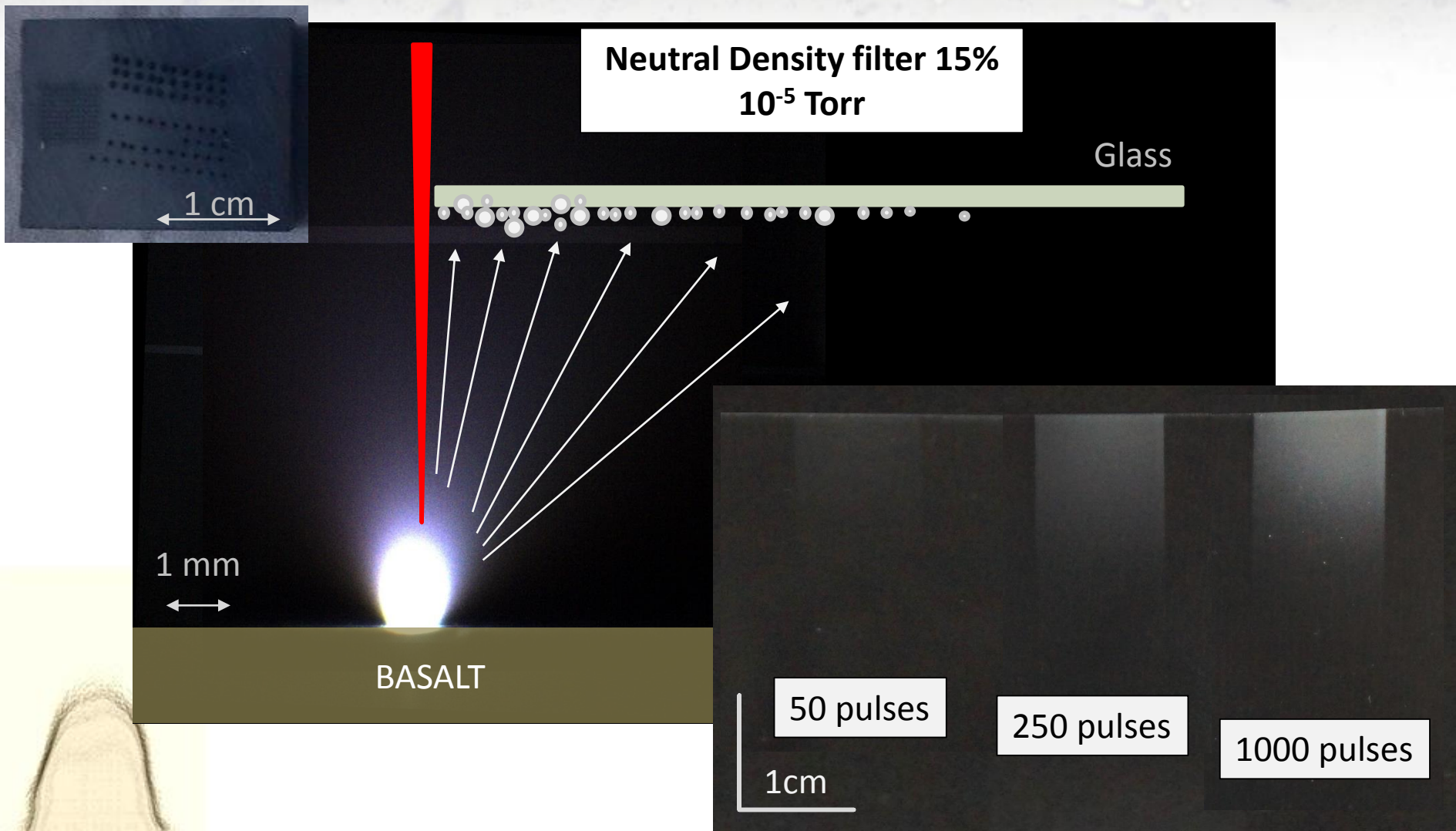



# PLASMA DEPOSITS PATTERN

## Detection and counting

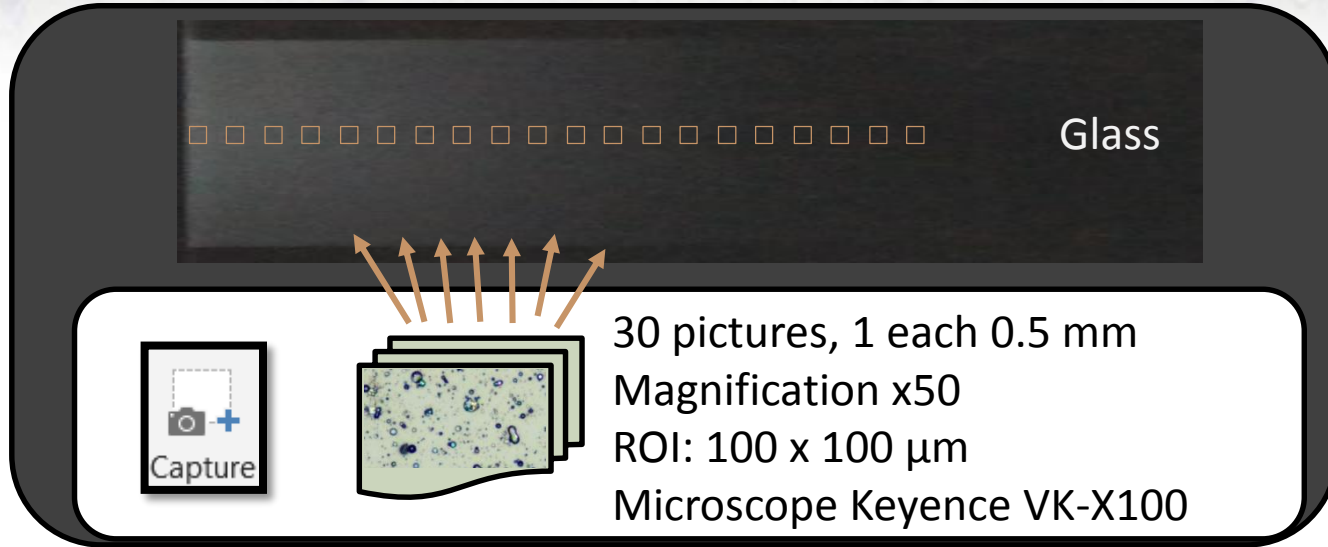

Measure of the ablated volume  
Microscope Keyence VK-X100



- Ablated volume
  - Density
- = Ablated mass

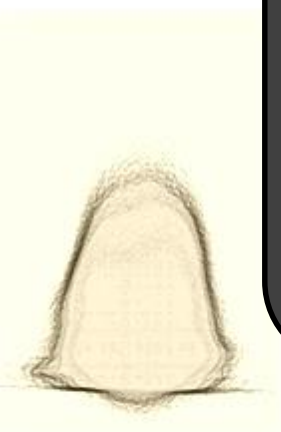
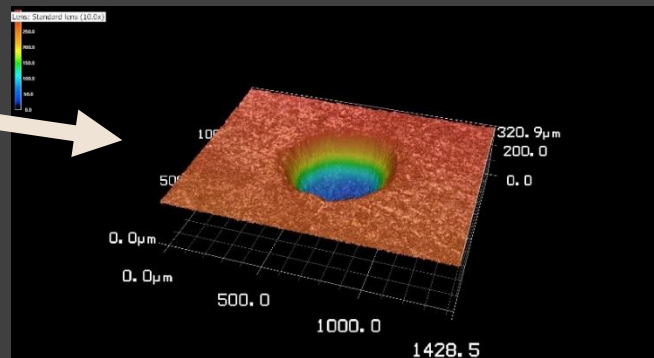

# PLASMA DEPOSITS PATTERN

## Detection and counting

### PLASMA DEPOSITS

100 laser pulses

Glass is 12 mm  
above the sample.

Picture #01

Position X axis:  
1 mm

Angle:  $\sim 5^\circ$

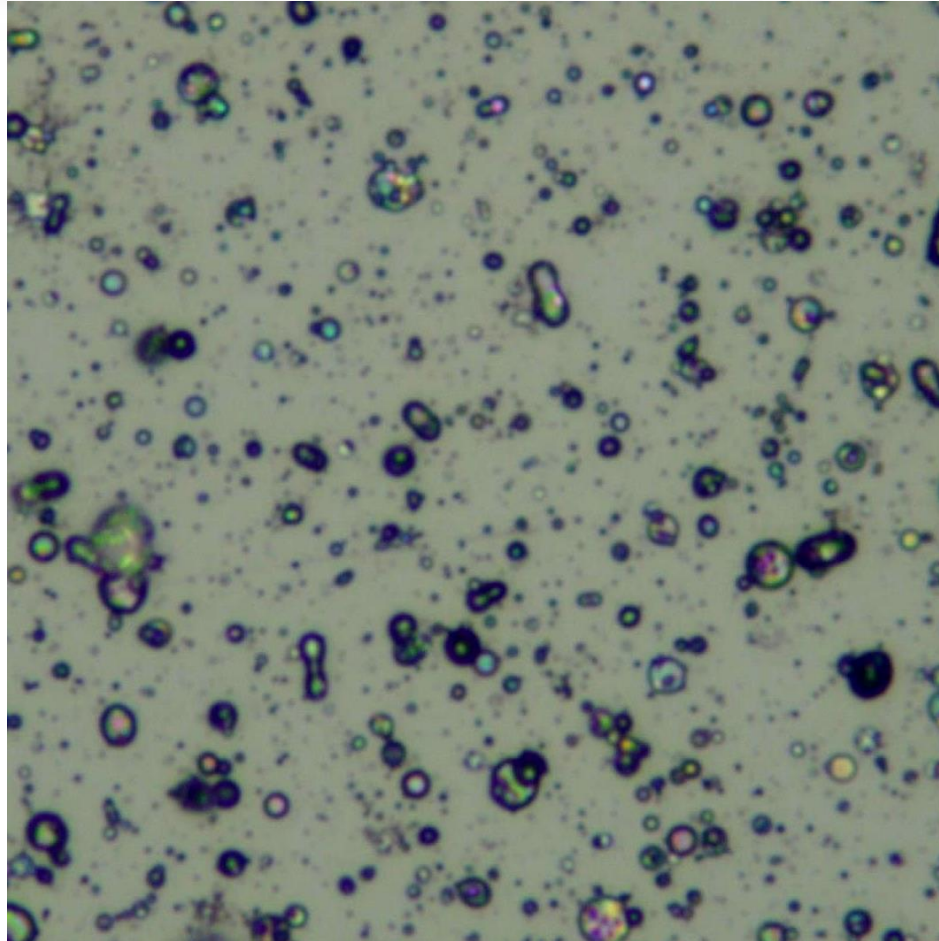

100  $\mu\text{m}$



# PLASMA DEPOSITS PATTERN

## Detection and counting

### PLASMA DEPOSITS

100 laser pulses

Glass is 12 mm  
above the sample.

Picture #04

Position X axis:  
2.5 mm

Angle: 12°

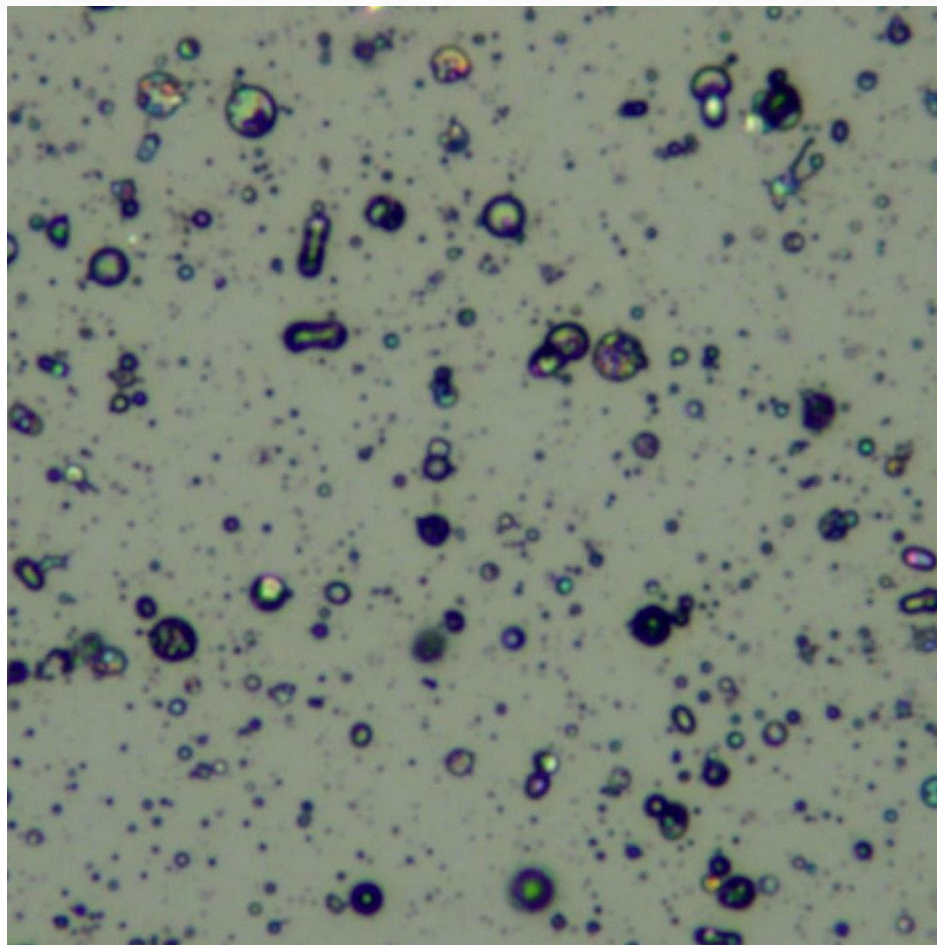

100  $\mu\text{m}$

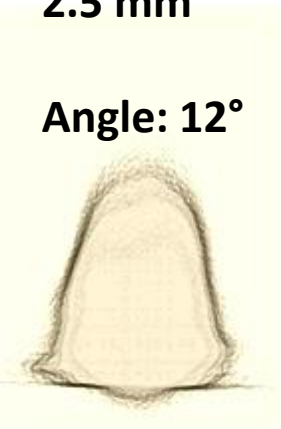



# PLASMA DEPOSITS PATTERN

## Detection and counting

### PLASMA DEPOSITS

100 laser pulses

Glass is 12 mm  
above the sample.

Picture #09

Position X axis:  
5.0 mm

Angle: 23°

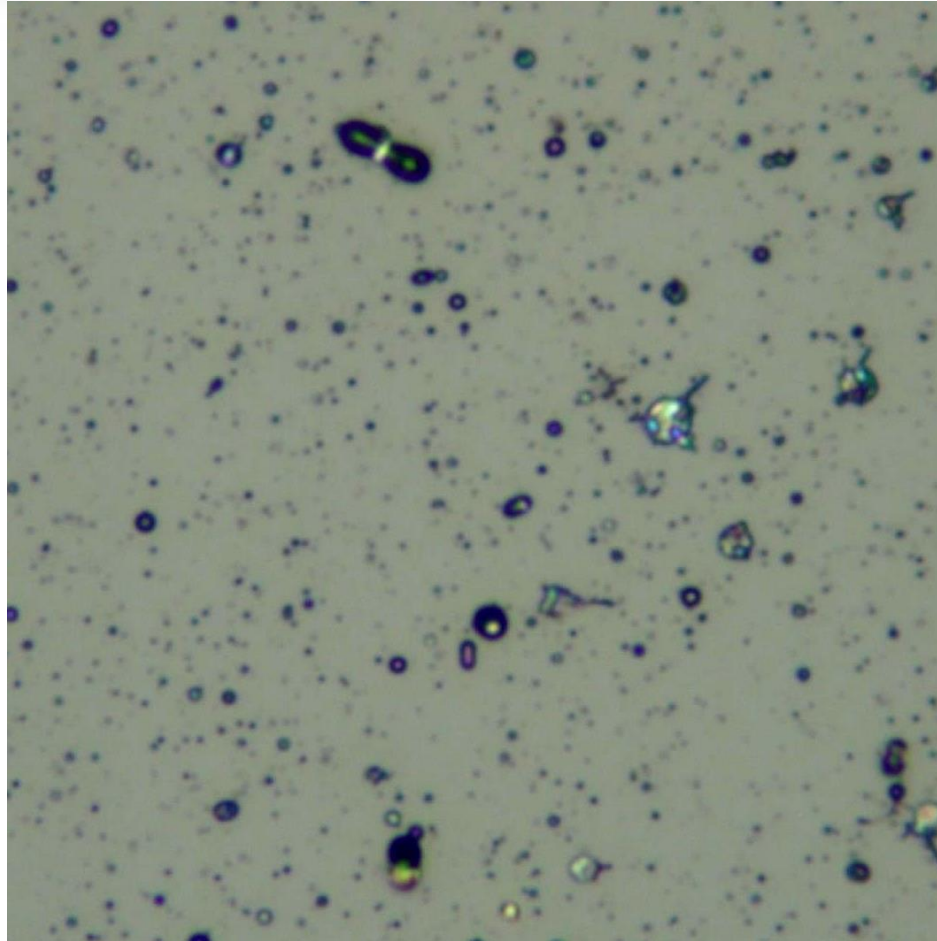

100  $\mu\text{m}$





# PLASMA DEPOSITS PATTERN

## Detection and counting

### PLASMA DEPOSITS

100 laser pulses

Glass is 12 mm  
above the sample.

Picture #14

Position X axis:  
7.5 mm

Angle: 32°

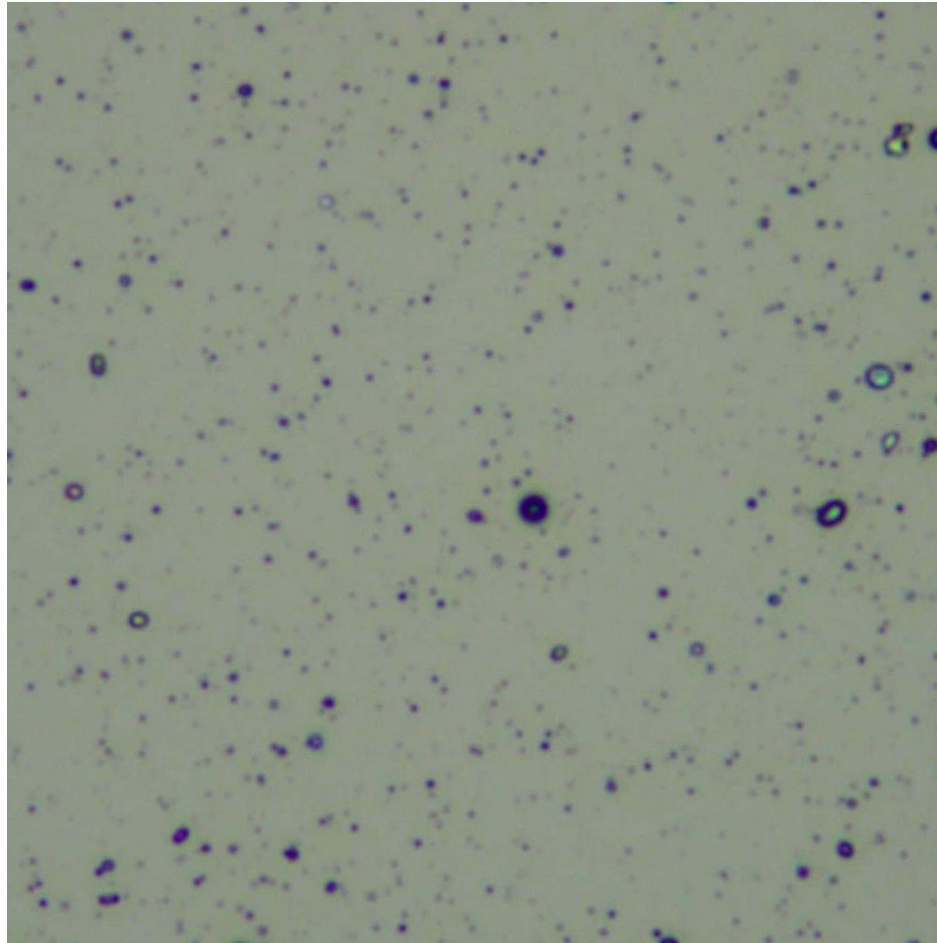

100  $\mu\text{m}$

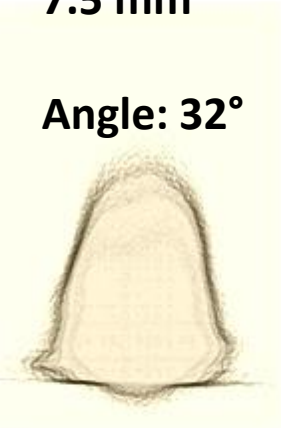

# PLASMA DEPOSITS PATTERN

## Detection and counting

### PLASMA DEPOSITS

100 laser pulses

Glass is 12 mm  
above the sample.

Picture #19

Position X axis:  
10 mm

Angle: 40°

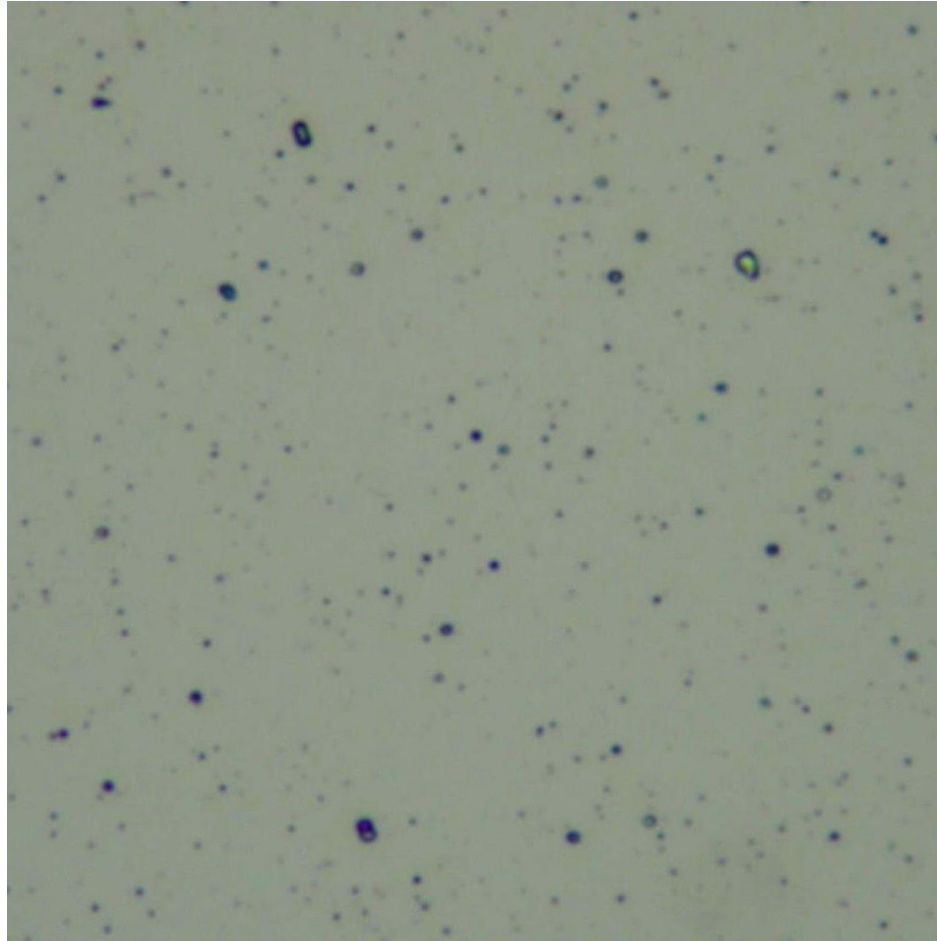

100  $\mu\text{m}$

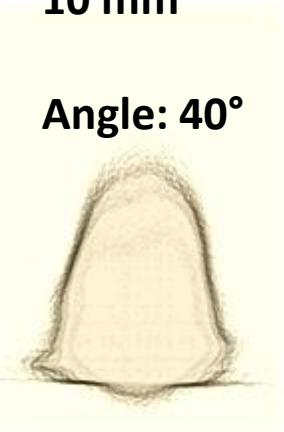

# PLASMA DEPOSITS PATTERN

## Detection and counting (LabVIEW)

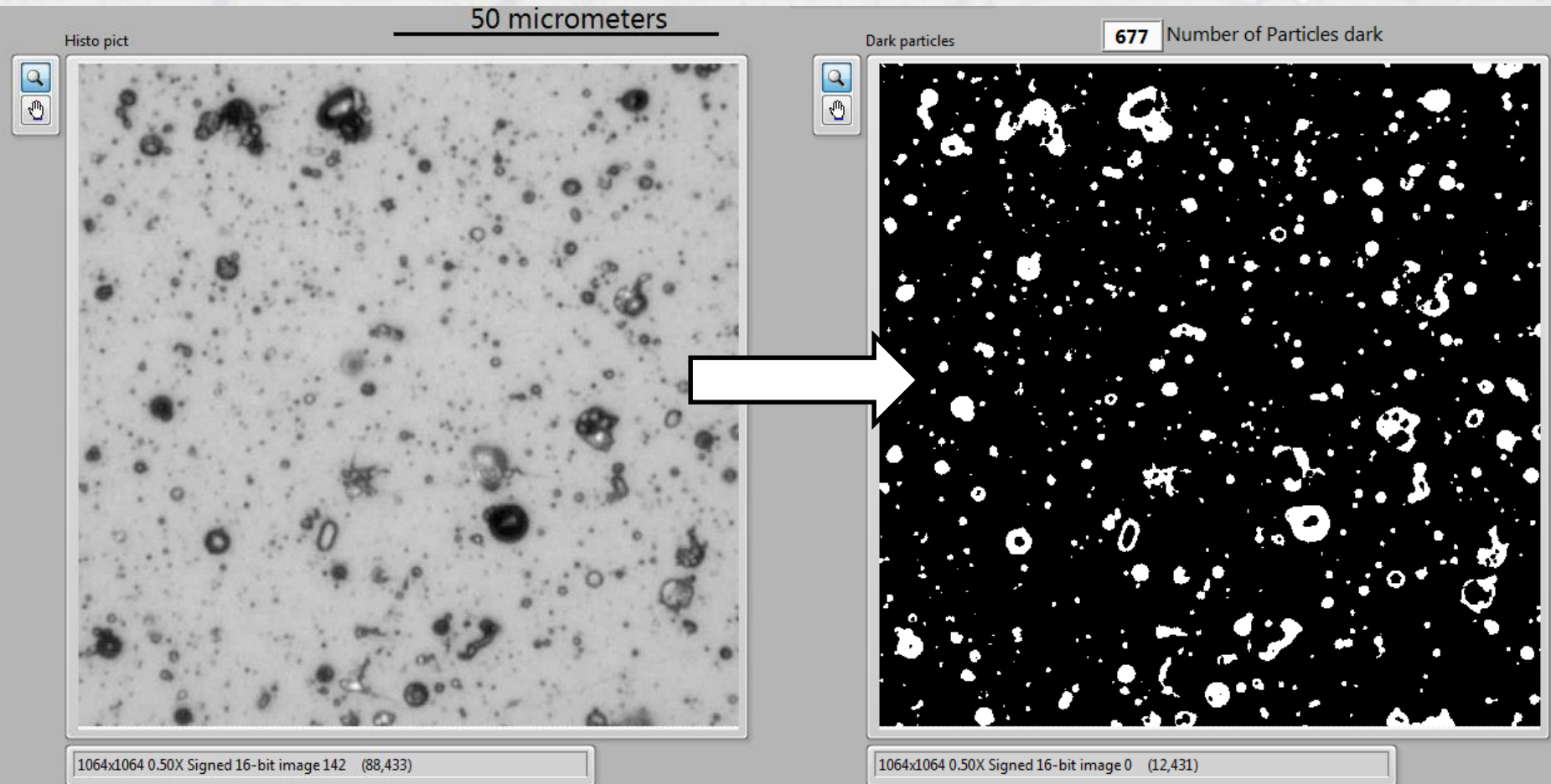

Counted and sorted in 3 categories:  
 $0.01 < 0.1 \mu\text{m}^2$  /  $0.1 < 1 \mu\text{m}^2$  /  $>1 \mu\text{m}^2$

# PLASMA DEPOSITS PATTERN RESULTS

0.01 < 0.1  $\mu\text{m}^2$  pattern for 250 pulses

Density per  
100  $\mu\text{m}^2$

475

0

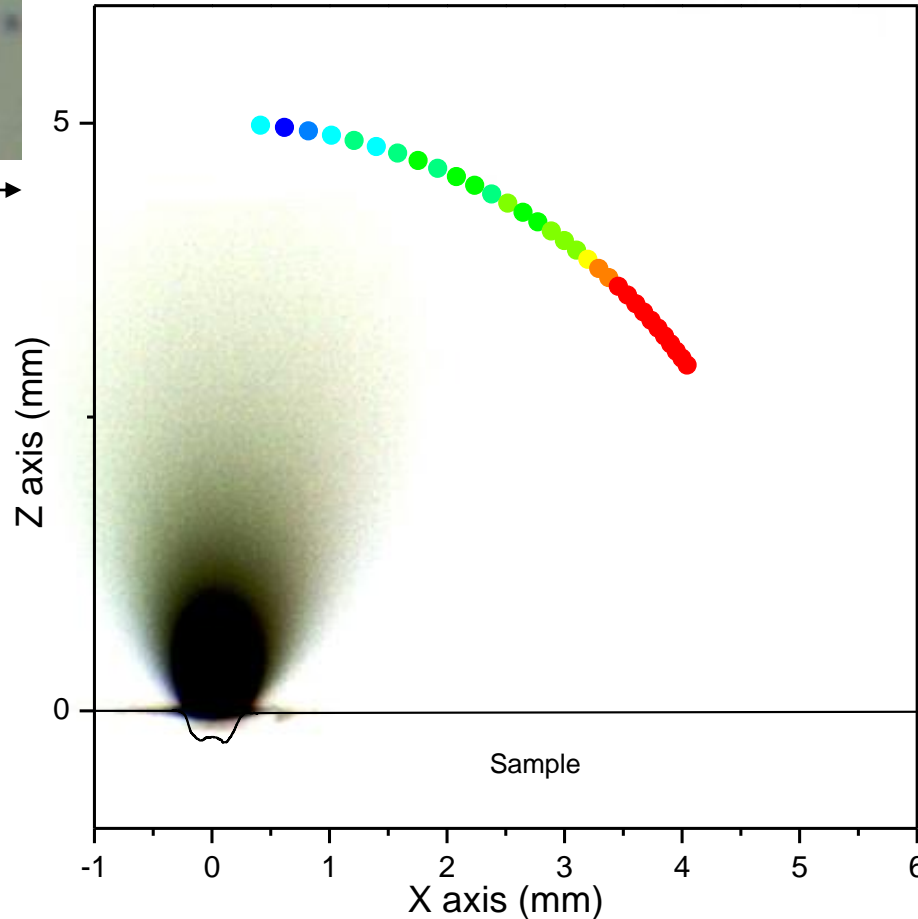

$\sim 15 \mu\text{m}$



# PLASMA DEPOSITS PATTERN RESULTS

$0.1 < 1 \mu\text{m}^2$  pattern for 250 pulses

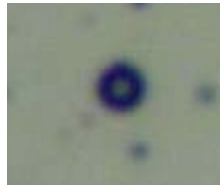

$\sim 15 \mu\text{m}$

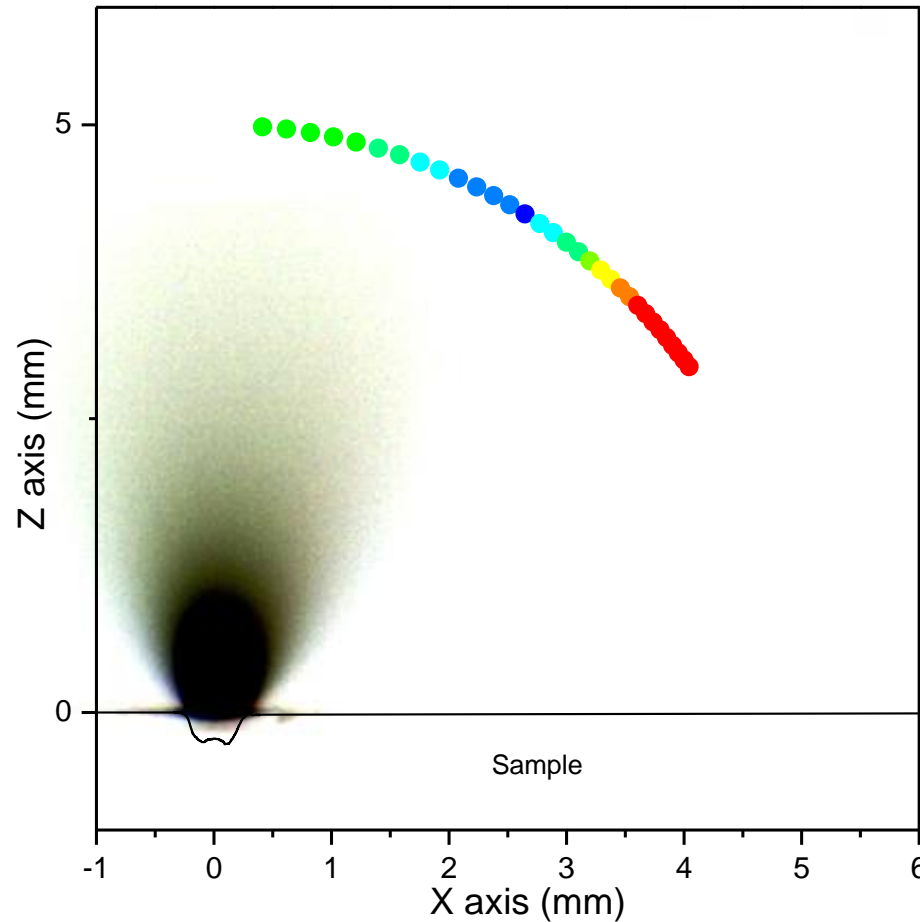

Density per  
 $100 \mu\text{m}^2$

800

0

# PLASMA DEPOSITS PATTERN RESULTS

> 1  $\mu\text{m}^2$  pattern for 250 pulses

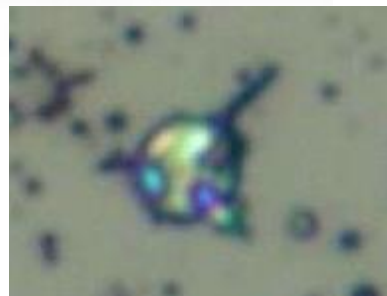

~15  $\mu\text{m}$

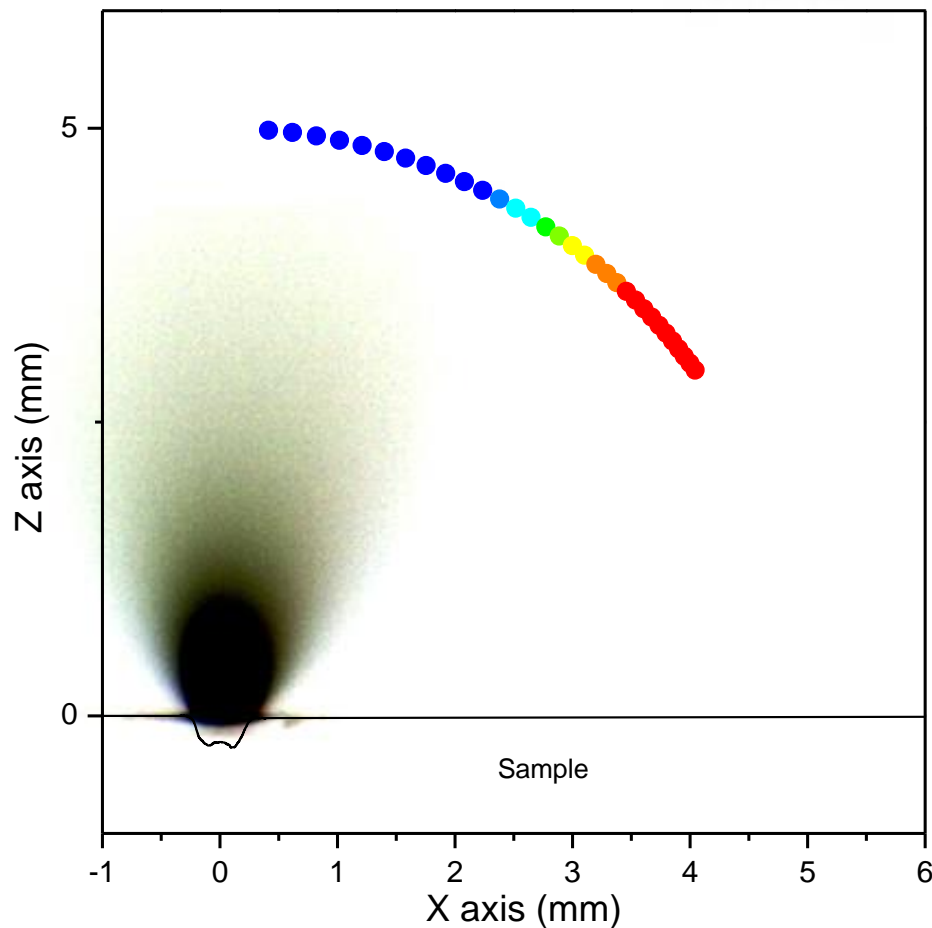

Density per  
100  $\mu\text{m}^2$

450

0



# PLASMA DEPOSITS PATTERN

## Prediction of the ablated volume via the PD

Quantity of PD > 1 $\mu$ m per angle of ejection\*

Plasma microparticles deposits  
(density: count/100 $\mu$ m<sup>2</sup>)

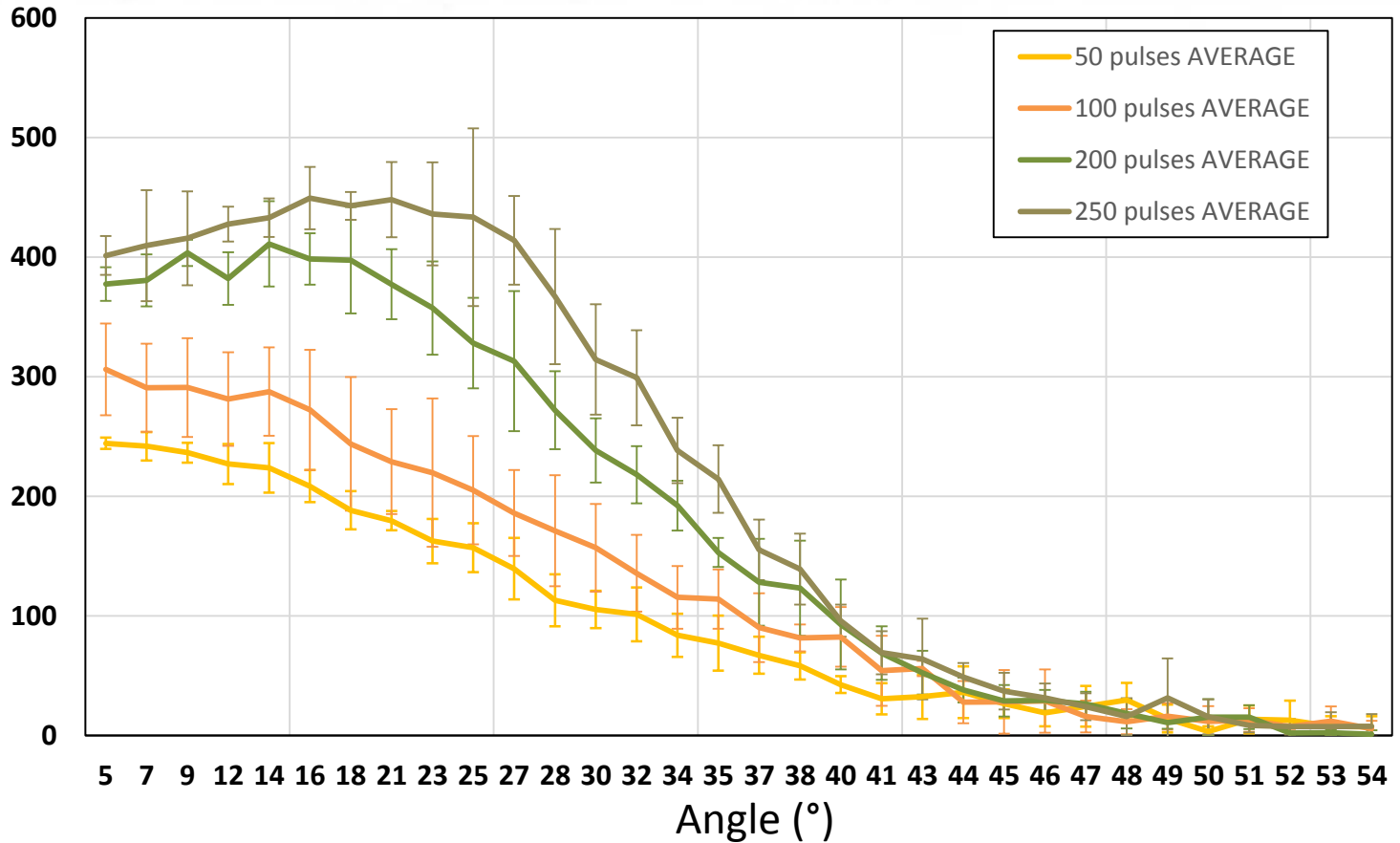

\* Data normalized per angle



# PLASMA DEPOSITS PATTERN

## Prediction of the ablated volume via the PD

Integral of the PD >1 $\mu$ m per ablated mass (mg)

Plasma  
microparticles  
deposits  
(sum)

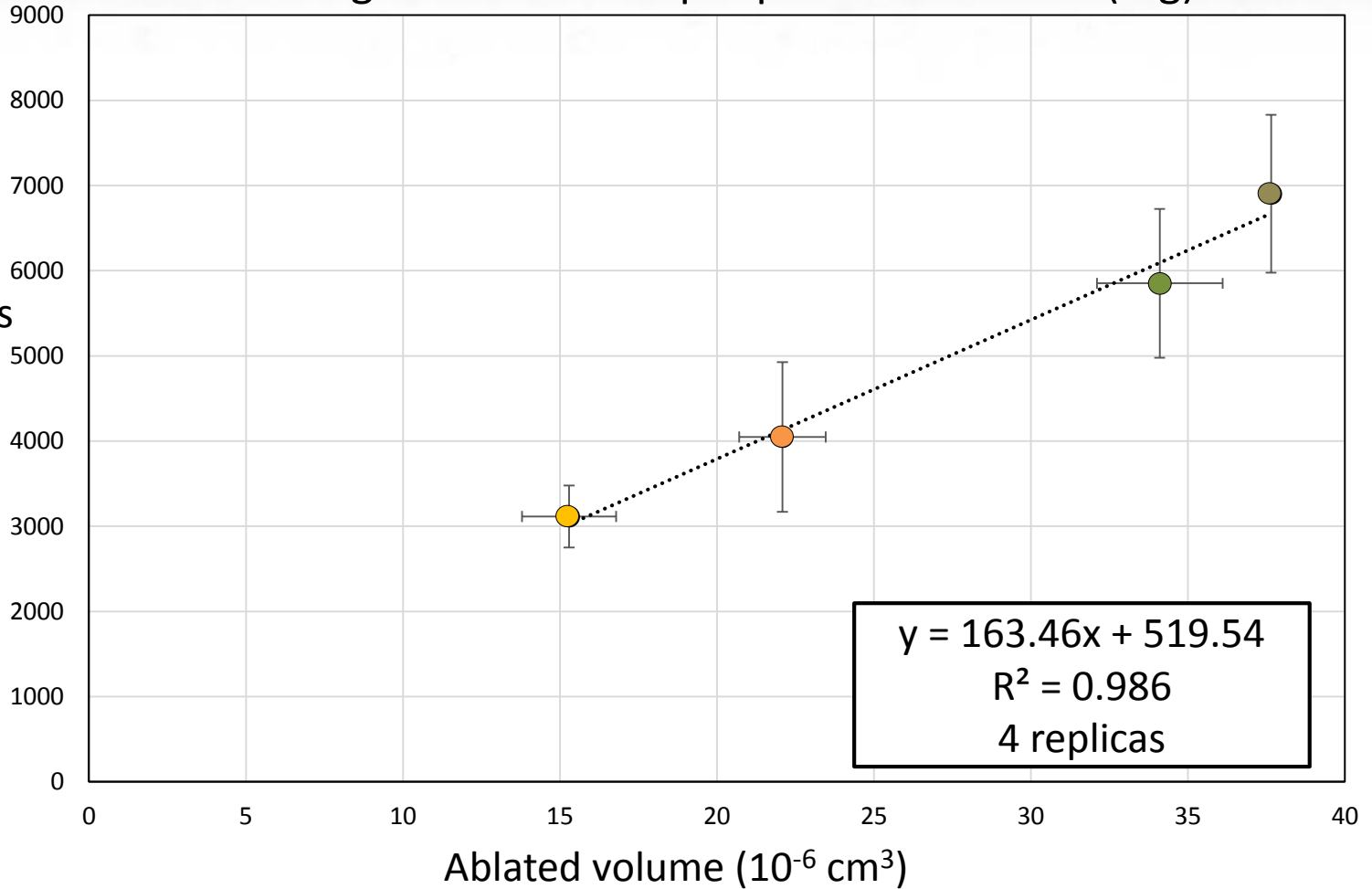



# DISCUSSION – CONCLUSION

## PLASMA DEPOSITS PRELIMINARY STUDIES

- Estimations of the whole PD of 1 ablated pit that can be measured during this study is only about **2 to 4 %** of the total ablated mass.
- The prediction of the ablated volume based on the PD counting is feasible for ablation between 50 and 250 pulses.
- Some 'blind test' have determined the ablated volume only based on PD within the 1 sigma uncertainties.
- On other mineralogies and rocks, with different densities, it may be difficult with this protocol, but better with the QCM.
- The **position** and the **orientation** will be important parameters to obtain a good **correlation** between the **fraction** measured and the **total ablated mass**.

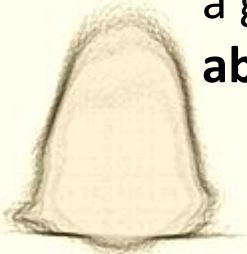

# DISCUSSION – CONCLUSION

## EFFECTS OF ULTRA LONG ABLATION

**Ablation  
> 100 pulses**

**POSITIVE  
FEEDBACK**

**NEGATIVE  
FEEDBACK**

**HIGH VACUUM &  
VARIATION OF PRESSURE  
(high vacuum:  $<10^{-4}$  Torr)**

- Ablation is more efficient compared to ambient pressure
- Good signal-to-noise ratio (LIBS)

- Lower intensity of the LIBS spectra
- Small variation of the peaks intensities with the variation of pressure

**VARIATION OF  
GEOMETRY OF THE PIT  
(100 to 500  $\mu\text{m}$  deep)**

- Variation of continuum can be related to the ablated volume
- Variation of the ablation efficiency

Important variation of the continuum

**PLASMA DEPOSITS**

PD can be related with the ablated mass via a QCM

PD on the window can lower the laser efficiency and the LIBS signal

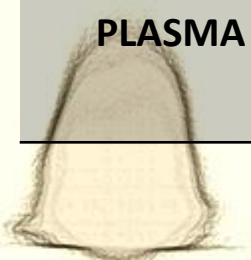

# THANK YOU

Ablation of 1000 pulses of a basalt, at  $10^{-5}$  Torr, laser at 55 mJ.  
500 pictures animated in a video of 20s.



1 mm



# SUPPLEMENTARY MATERIAL (VIDEO)





# THANK YOU

Ablation of 1000 pulses of a basalt, at  $10^{-5}$  Torr, laser at 55 mJ.  
500 pictures animated in a video of 20s.

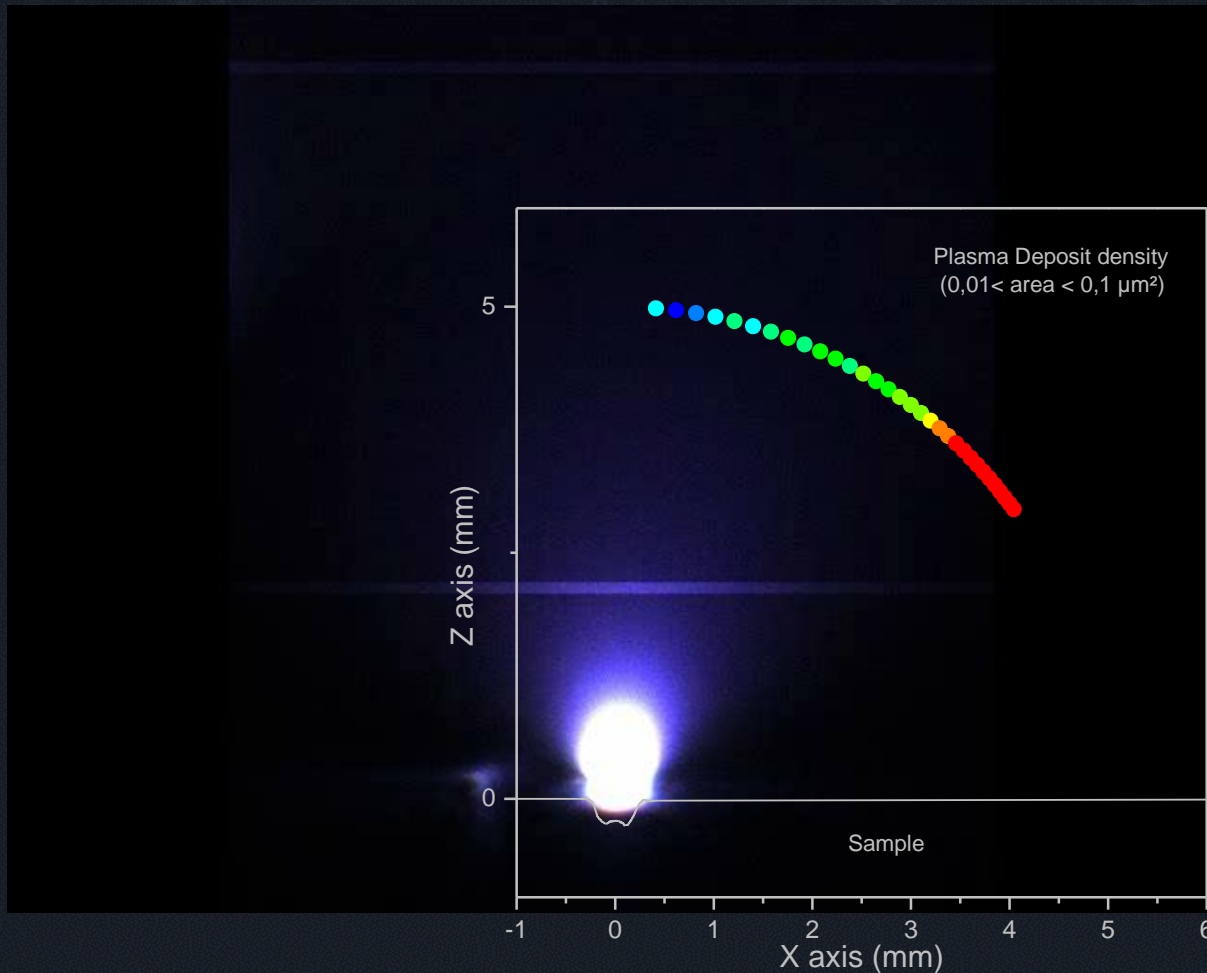



# THANK YOU

Ablation of 1000 pulses of a basalt, at  $10^{-5}$  Torr, laser at 55 mJ.  
500 pictures animated in a video of 20s.

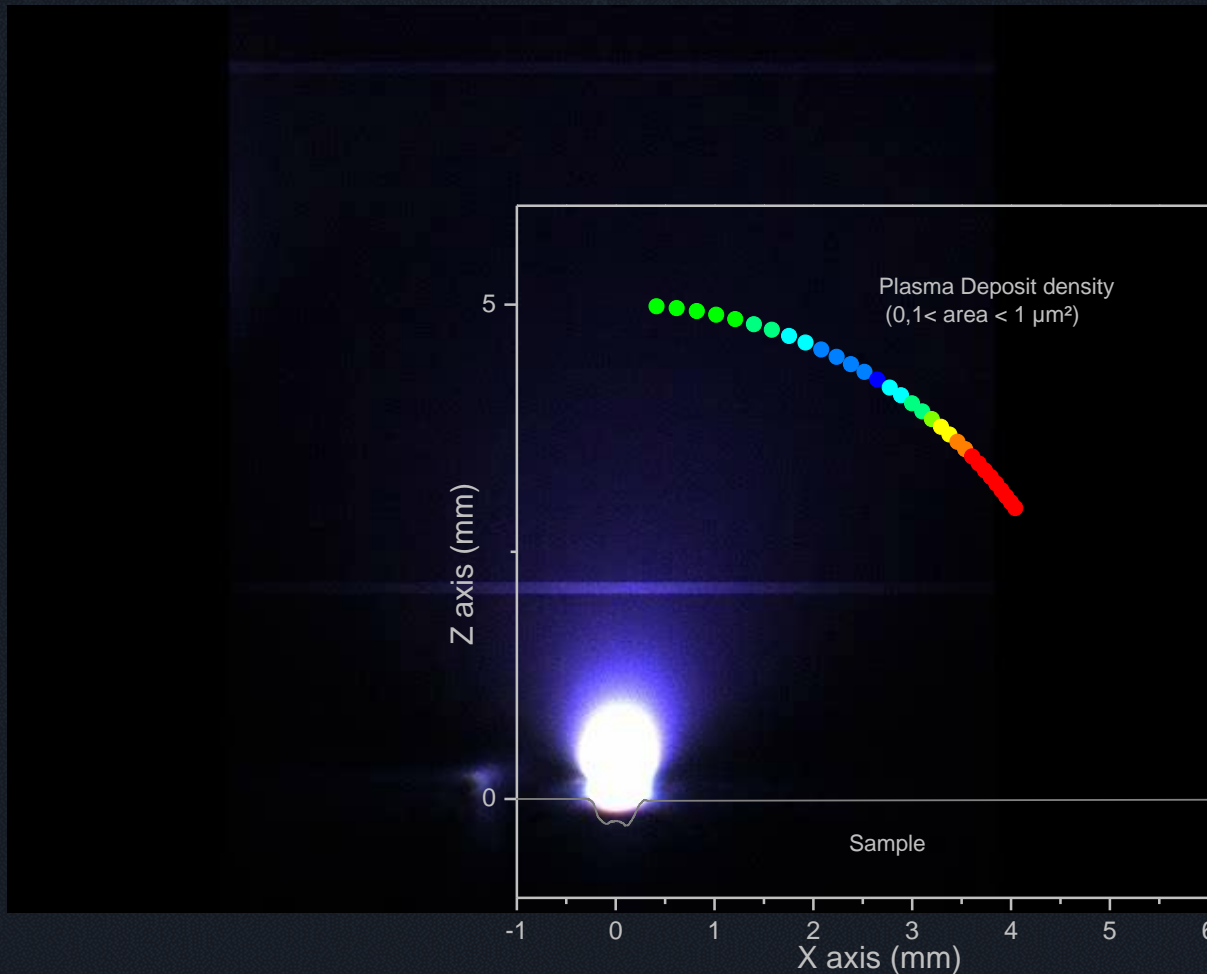

# THANK YOU

Ablation of 1000 pulses of a basalt, at  $10^{-5}$  Torr, laser at 55 mJ.  
500 pictures animated in a video of 20s.

