

Affordable Development and Demonstration of a Small NTR Engine and Stage: How Small is Big Enough?

Stanley K. Borowski¹, Robert J. Sefcik¹, James E. Fittje², David R. McCurdy², Arthur L. Qualls³, Bruce G. Schnitzler³, James E. Werner⁴, Abraham Weitzberg⁵ and Claude R. Joyner⁶

¹NASA Glenn Research Center, Cleveland, OH 44135

²Vantage Partners, LLC at Glenn Research Center, Brook Park, OH 44142

³Oak Ridge National Laboratory, Oak Ridge, TN 3783

⁴Idaho National Laboratory, Idaho Falls, ID 83415

⁵DOE Consultant, 5711 Como Circle, Woodland Hills, CA 91367

⁶Aerojet Rocketdyne, West Palm Beach, FL 33410

telephone: (216) 977-7091, email: Stanley.K.Borowski@nasa.gov

The Nuclear Thermal Rocket (NTR) derives its energy from fission of uranium-235 atoms contained within fuel elements that comprise the engine's reactor core. It generates high thrust and has a specific impulse potential of ~900 seconds – a 100% increase over today's best chemical rockets. The Nuclear Thermal Propulsion (NTP) project, funded by NASA's AES program, includes five key task activities: (1) Recapture, demonstration, and validation of heritage graphite composite (GC) fuel (selected as the "Lead Fuel" option); (2) Engine Conceptual Design; (3) Operating Requirements Definition; (4) Identification of Affordable Options for Ground Testing; and (5) Formulation of an Affordable Development Strategy. During FY'14, a preliminary DDT&E plan and schedule for NTP development was outlined by GRC, DOE and industry that involved significant system-level demonstration projects that included GTD tests at the NNSS, followed by a FTD mission. To reduce cost for the GTD tests and FTD mission, small NTR engines, in either the 7.5 or 16.5 klbf thrust class, were considered. Both engine options used GC fuel and a "common" fuel element (FE) design. The small ~7.5 klbf "criticality-limited" engine produces ~157 megawatts of thermal power (MW_t) and its core is configured with parallel rows of hexagonal-shaped FEs and tie tubes (TTs) with a FE to TT ratio of ~1:1. The larger ~16.5 klbf Small Nuclear Rocket Engine (SNRE), developed by LANL at the end of the Rover program, produces ~367 MW_t and has a FE to TT ratio of ~2:1. Although both engines use a common 35 inch (~89 cm) long FE, the SNRE's larger diameter core contains ~300 more FEs needed to produce an additional 210 MW_t of power. To reduce the cost of the FTD mission, a simple "1-burn" lunar flyby mission was considered to reduce the LH₂ propellant loading, the stage size and complexity. Use of existing and flight proven liquid rocket and stage hardware (e.g., from the RL10B-2 engine and Delta Cryogenic Second Stage) was also maximized to further aid affordability. This paper examines the pros and cons of using these two small engine options, including their potential to support future human exploration missions to the Moon, near Earth asteroids, and Mars, and recommends a preferred size. It also provides a preliminary assessment of the key activities, development options, and schedule required to affordably build, ground test and fly a small NTR engine and stage within a 10-year timeframe.

Nomenclature

<i>AES / AISP</i>	=	Advanced Exploration Systems / Advanced In-Space Propulsion
<i>DDT&E / DOE</i>	=	Design Development Test and Evaluation / Department of Energy
<i>GTD / FTD</i>	=	Ground / Flight Technology Demonstration
<i>K / klbf</i>	=	Temperature (degrees Kelvin) / thrust (1000's of pounds force)
<i>LANL / LH₂</i>	=	Los Alamos National Laboratory / Liquid Hydrogen
<i>NERVA / NNSS</i>	=	Nuclear Engine for Rocket Vehicle Applications / Nevada National Security Site
<i>t / ΔV</i>	=	metric ton (1 t = 1000 kg) / velocity change increment (km/s)

I. Introduction, Background, and Overview

Renewed interest and funding for NTP began in FY'11 under the AISP component of NASA's Exploration Technology Development and Demonstration (ETDD) program. A strategy for NTP development was outlined that included two key elements – “Foundational Technology Development” followed by system-level “Technology Demonstration” projects. Five task activities were initiated for Foundational Technology Development and became the basis for the NCPS project started in FY'12 under the newly created AES program that was to replace ETDD.

During Phase 1 (FY'12-14), NCPS project was primarily focused on (1) Recapturing fuel processing techniques and demonstrating the ability to fabricate short fuel element (FE) segments based on the “heritage” designs and candidate fuel forms that included Rover/NERVA graphite “composite” (GC) and UO₂ in tungsten (W) “cermet”. Work on GC fuel processing, FE fabrication and coating was performed at the Oak Ridge National Laboratory (ORNL) while the Marshall Space Flight Center (MSFC) led the development effort on the cermet option. The Phase 1 effort also included: (2) Engine Conceptual Design; (3) Mission Analysis and Operational Requirements Definition; (4) Identification of Affordable Options for Ground Testing; and (5) Formulation of an Affordable and Development Strategy for NTP.

To focus the fuel development effort and maximize use of its limited resources, the AES program decided in FY'14 that a “leader – follower” fuel down selection between GC and cermet was required. The chosen “lead” fuel would receive increased resources to mature and qualify it more quickly and to increase the fidelity of engine designs that would use it. Work on the “follower” fuel would also continue but at a lower “basic research” level.

To aid them in their decision, the AES program convened an Independent Review Panel (IRP) in July 2014 and tasked them with reviewing the available data for both fuel types then making a recommendation on a leader – follower fuel. A compelling argument for selecting GC fuel over the cermet option was presented by DOE and GRC at a second meeting of the IRP at NASA HQ on December 16, 2014 and a follow-on report was provided to them one month later [1]. *In February 2015, the report's findings and recommendation that GC fuel be the lead fuel option was endorsed by the IRP and subsequently adopted by the AES program.*

In FY'15, the NCPS project was renamed the NTP project. Five key task activities were identified for Phase 2 (FY's 15 – 17) by the participating NASA centers and DOE laboratories. They included: (1) GC fuel development, demonstration and validation; (2) conceptual design and (3) requirements definition for a small, but scalable, low thrust engine; (4) identifying the best options and requirements for ground testing; and (5) formulating an affordable DDT&E plan and development schedule supporting system-level ground and flight technology demonstrations within a 10-year timeframe following an “authority to proceed” (ATP) decision. *Determining how small the engine thrust level should be to ensure an affordable GTD and FTD program, and if it's large enough to support proposed NASA human missions, are key questions that need to be answered and are the primary focus of this paper.*

Fabrication and testing of a partial length (~16 inches) GC fuel element is a key FY'15 milestone for the NTP project. The FE will be fabricated at ORNL using depleted uranium (DU) or a surrogate material and its exterior and internal coolant channel surfaces will be coated with zirconium carbide (ZrC) using a chemical vapor deposition (CVD) process. The FE will then be shipped to the MSFC where it will undergo non-nuclear testing in the NTR Element Environmental Simulator (NTREES) facility [2]. With the upgrades to NTREES completed in FY'14, the facility will be capable of providing up to 1.2 megawatts of radiofrequency power for FE “thermal cycle” testing in flowing hydrogen at pressures up to 1000 psi and temperatures up to ~3000 K. NTREES will be used to validate the heritage Rover/NERVA FE geometry, its GC fuel-matrix material, and its protective coatings prior to beginning irradiation testing in FY'17. The latter would be conducted at a DOE facility like the Advanced Test Reactor (ATR) at the Idaho National Laboratory (INL) or the High Flux Isotope Reactor (HFIR) at ORNL.

Another key component of a viable NTP development plan is affordable ground testing. During the NTP project's Phase 2 effort, the different approaches will be evaluated and some non-nuclear “proof-of-concept” subscale validation of candidate concepts like the SAFE (Subsurface Active Filtration of Exhaust) option – also referred to as “borehole” testing – could also be conducted. This subscale test would be performed at the NNSS using a small liquid oxygen / hydrogen chemical rocket operated “fuel-rich” to simulate the NTR engine [3]. Other possible testing options at the NNSS include the use of long, large diameter horizontal tunnels at either the underground U1a complex or the P-tunnel complex located inside the Rainier Mesa.

In FY'14, a preliminary DDT&E plan and development schedule was produced by GRC, DOE and industry for the AES program. It included foundational technology development and significant system-level demonstration projects involving GTD tests at the NNSS, followed by a FTD mission. Some key activities from the schedule / plan are shown below in Fig. 1.

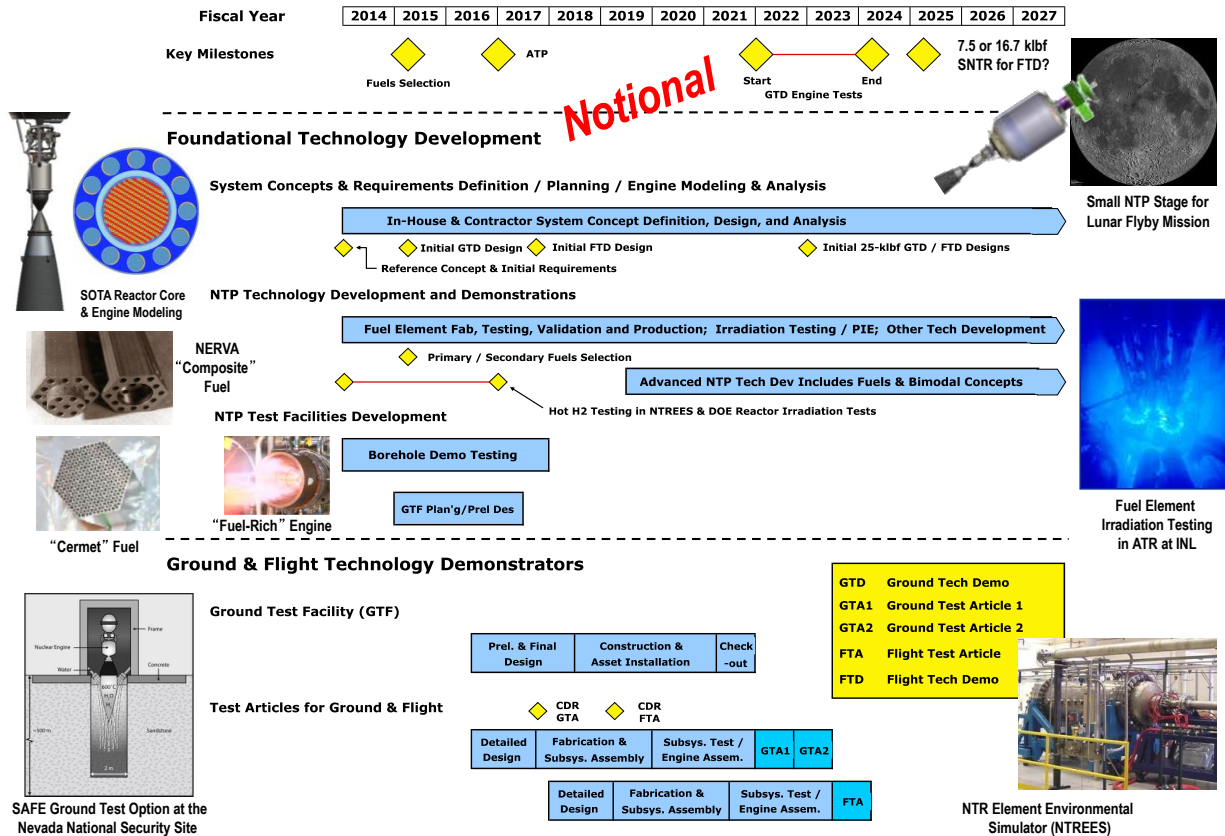

Figure 1. Notional NTP Development Schedule Includes Foundational Technology Development, Followed by System-Level Ground and Flight Technology Demonstrations

The *Foundational Technology Development* component of the schedule includes “State-of-the-Art” (SOTA) reactor/engine modeling, conceptual design and operational requirements definition, along with planning and schedule development discussed in this paper. As mentioned above, NTP technology development is primarily focused on demonstrating the viability and performance of GC fuel through “separate effects” tests involving NTRRES and irradiation testing followed by post-irradiation examination (PIE) and evaluation. Last, but not least in order of importance, is an assessment of candidate ground test facility (GTF) options and the selection of a primary approach. Subscale validation testing would demonstrate the concept, provide data for benchmarking codes, and help anchor GTF planning and preliminary design activities. Final GTF design, construction, startup and checkout would occur during the *Ground and Flight Technology Demonstration* portion of the development schedule.

In order to reduce development time and cost, the GTD tests and the FTD mission will use a small, low thrust engines (in either the ~7.5 or 16.5 klbf thrust class) that has a common fuel element design. This approach is attractive because it allows scalability to higher thrust engines, if and when required, by increasing the number of elements and the reactor core diameter so that it has a greater thermal power output. A small NTP ground test engine should also easier to transport, assemble and disassemble after testing has been completed. As currently envisioned, the GTD project would build and test 1-2 ground test articles (GTA1, GTA2) and one flight test article (FTA) that provides system technology demonstration and design validation for the follow-on FTD mission.

The FTD mission chosen is a simple “1-burn” lunar flyby mission selected to minimize the engine burn duration, the LH₂ propellant loading, stage size and complexity. The demonstration stage also maximizes the use of existing and flight proven liquid rocket and stage components to further ensure affordability.

This paper examines the pros and cons of using these two small engine options, including their potential to support future human missions, and then recommends a preferred size. It also provides a preliminary NASA, DOE and industry assessment of the key activities, development options, and schedule required to affordably build, ground test and fly a small NTR engine and stage within a 10-year timeframe. It ends with a summary of our findings and some concluding remarks.

II. NTR Engine Description and Demonstrated Technology

The NTR uses a compact fission reactor core containing 93% “enriched” uranium (U)-235 fuel to generate 100’s of megawatts of thermal power (MW_t) required to heat the LH_2 propellant to high exhaust temperatures for rocket thrust. In an “expander cycle” Rover/NERVA-type engine (Fig. 2), high pressure LH_2 flowing from either a single or twin turbopump assembly (TPA) is split into two paths with the first cooling the engine’s nozzle, pressure vessel, neutron reflector, and control drums, and the second path cooling the engine’s core support tie-tube assemblies. The flows are then merged and the heated H_2 gas is used to drive the TPAs. The hydrogen turbine exhaust is then routed back into the reactor pressure vessel and through the internal radiation shield and upper core support plate before entering the coolant channels in the reactor’s GC fuel elements. Here it absorbs energy produced from the fission of U-235 atoms, is superheated to high exhaust temperatures ($T_{ex} \sim 2550 - 2950$ K depending on uranium fuel loading), then expanded out a high area ratio nozzle ($\sim 300:1$) for thrust generation.

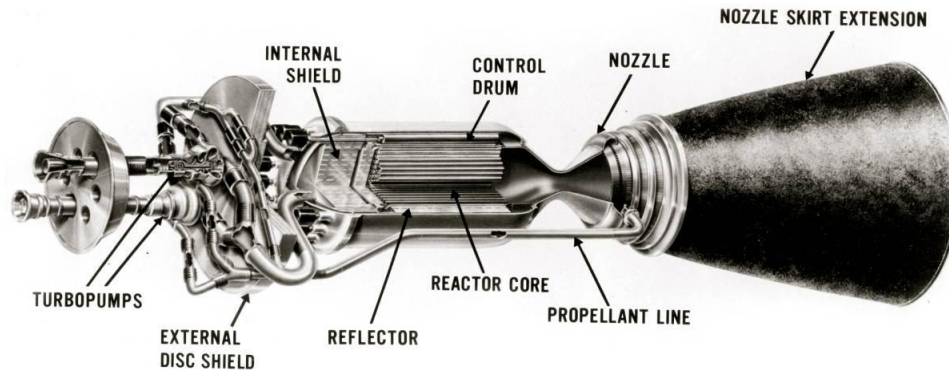

Figure 2. Schematic of “Expander Cycle” NTR Engine with Dual LH_2 Turbopumps

Controlling the NTR during its various operational phases (startup, full thrust and shutdown) is accomplished by matching the TPA-supplied LH_2 flow to the reactor power level. Multiple control drums, located in the reflector region surrounding the reactor core, regulate the neutron population and reactor power level over the NTR’s operational lifetime. The internal neutron and gamma radiation shield, located within the engine’s pressure vessel, contains its own interior coolant channels. It is placed between the reactor core and key engine components to prevent excessive radiation heating and material damage.

The fuel elements tested in the Rover / NERVA programs [4] were fabricated using a “graphite matrix” material that contained the U-235 fuel in the form of either coated particles of uranium carbide (UC_2) or as a dispersion of uranium and zirconium carbide ($UC-ZrC$) referred to as “composite” fuel. The higher performance GC fuel was developed as a “drop-in replacement” for the coated particle fuel and was tested in the Nuclear Furnace element test reactor (NF-1) [4] toward the end of the Rover program. *The GC elements were successfully tested for ~2 hours at peak power densities of ~5 MW_t per liter (~5000 MW_t/m^3) and achieved peak fuel and hydrogen exhaust temperatures of $T_{peak} \sim 2700$ K and $T_{ex} \sim 2450$ K, respectively.* The GC elements also demonstrated better corrosion resistance than the standard coated particle graphite matrix fuel element used in the previous Rover/NERVA reactor tests. Composite fuel’s improved corrosion resistance is attributed to its higher coefficient of thermal expansion (CTE) that more closely matches that of the protective ZrC coating, thereby helping to reduce coating cracking. Electrical-heated composite fuel elements were also tested by Westinghouse in hot hydrogen at 2700 K for ~600 minutes – equivalent to ten 1-hour cycles. At the end of Rover/NERVA program, composite fuel performance projections [5] were estimated at ~2-6 hours at full power for hydrogen exhaust temperatures of ~2500-2800 K.

Heritage Rover/NERVA fuel elements had a hexagonal cross section (~0.75 inch across the flats) and 19 axial coolant channels that were CVD-coated with niobium carbide (NbC) initially, then with ZrC to reduce coating cracking, hydrogen penetration and subsequent erosion of the graphite matrix material. Individual elements were 1.32 m (52 inches) in length and produced ~1 MW_t during steady state, full power operation.

In addition to the FEs, later Rover/NERVA reactor cores used improved hexagonal-shaped tie tube (TT) elements in place of the earlier tie rods to provide axial structural support to the adjacent FEs surrounding them. The tie rods and TTs were both attached to an aluminum support plate located at the cold end of the reactor. Unlike the single pass tie rods that discharged their hydrogen coolant directly into the core exit chamber, the two-pass regenerative

cooled TTs had a coaxial Inconel tube to carry the hydrogen coolant that was discharged into the core inlet allowing further FE heating and significantly raising the engine's specific impulse. These same TTs are used to supply a source of heated hydrogen for turbine drive power in the expander cycle engine designs current under study.

A sleeve of zirconium hydride (ZrH) moderator material can also be incorporated in the TTs to help increase core reactivity and allow construction of smaller size reactor systems like the Rover program's Pewee engine [4]. Pewee was designed and built to evaluate higher temperature, longer life fuel elements and improved coatings. It produced ~25 klb_f of thrust and set several performance records including the highest fuel element hydrogen exhaust temperature of ~2550 K, and the highest peak fuel temperature of ~2750 K. Other performance records included average and peak power densities in the reactor core of ~2340 MW_t/m³ and ~5200 MW_t/m³, respectively. Improved ZrC coating was also introduced in Pewee and showed performance superior to the NbC coating used in previous reactor tests. This same ZrC coating is being applied to the GC fuel elements currently being fabricated at ORNL.

A final reactor design, known as the Small Nuclear Rocket Engine (SNRE) [6], was developed by Los Alamos National Laboratory (LANL) near the end of the Rover/NERVA program. Although it was not built, it incorporated lessons learned from Pewee and other reactor designs and test results. The SNRE FE had the same hexagonal cross section and coolant channel number, but was shorter (0.89 m / 35 inch), and produced ~0.65 MW_t. Because it was smaller than Pewee at ~16.4 klb_f of thrust, the SNRE required additional ZrH tie tubes to provide the extra neutron moderation needed in the engine's smaller core. In the SNRE core, each FE had 3 TTs and 3 FEs surrounding it (shown in Fig. 3). It also used GC fuel elements (with ~35 volume % UC-ZrC content) and an expander cycle with the turbine drive power provided solely by TT hydrogen discharge. *The SNRE is the larger of the two small engine designs that were considered for ground and flight technology demonstration in this preliminary assessment.*

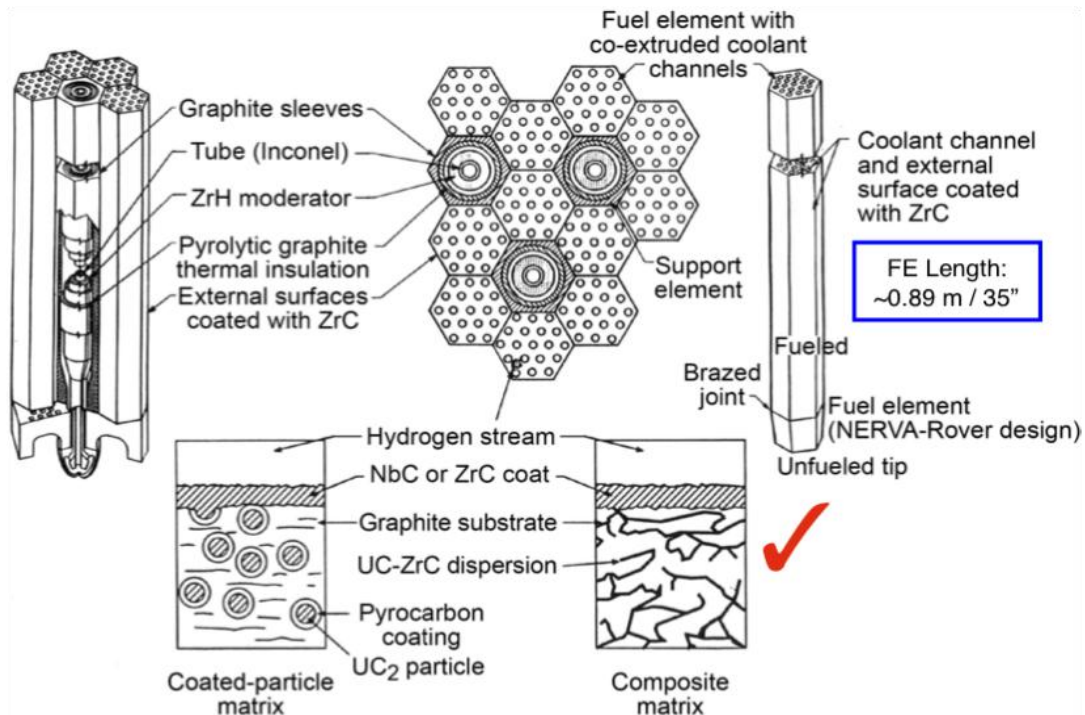

Figure 3. Coated Particle and Composite SNRE Fuel Element and Tie Tube Arrangement

Regarding demonstrated technology, NTP has a proven track record plus a specific impulse potential 100% higher than today's best chemical rockets. During the Rover/NERVA programs (1955-1972), a technology readiness level (TRL) of ~5-6 was achieved. Twenty rocket reactors were designed, built and ground tested [4] demonstrating: (1) a wide range of thrust levels (~25, 50, 75 and 250 klb_f); (2) high temperature graphite-based coated particle and composite nuclear fuels; (3) hydrogen exhaust temperatures up to 2550 K (*achieved in Pewee*); (4) sustained engine operation (*over 62 minutes for a single burn achieved in the NRX-A6*); as well as (5) accumulated lifetime at full-power; and (6) restart capability (*>2 hours with 28 startup and shutdown cycles achieved in the NRX-XE experimental engine*) – all the requirements needed for human missions to Mars. Despite these accomplishments, the Rover/NERVA program was cancelled in January 1973 without a flight demonstration. Today, NASA is providing

modest funding for a small but focused technology development and demonstration effort that it hopes will lead to the successful ground testing and eventual flight of a small NTR engine.

III. Recent Reactor / Engine Modeling and Conceptual Design Activities

Candidate “Heritage” Fuel Element Designs

In the Rover program, a common fuel element / tie tube design was developed and used to construct a wide range of different thrust engines. This included the 50 klb_f Kiwi-B4E (1964), the 75 klb_f Phoebus-1B (1967), the 250 klb_f Phoebus-2A (June 1968), then less than six months later, the 25 klb_f Pewee engine (Nov-Dec 1968). This same approach *but in reverse* is being followed by the NTP project – design, build, ground test, then fly a small NTR engine first, then scale it up in size to the larger 25 klb_f “Pewee-class” engines featured in NASA’s Mars Design Reference Architecture (DRA) 5.0 study [7, 8].

During Phase 1 of the NCPS project, “Point-of-Departure” (POD) engine designs for both a small “criticality-limited” and full size (25 klb_f class) engine were developed for both fuel types using the heritage fuel element designs shown in Fig. 4. For the GC fuel, the well-established 19-hole hexagonal FE and TT geometry from the Rover/NERVA program was baselined. Ceramic-metal or “cermet” fuel, composed of uranium dioxide (UO₂) in a tungsten (W) metal matrix material, was also developed during the 1960’s to early 1970’s by General Electric (GE) and Argonne National Laboratory (ANL) as a backup to the Rover/NERVA fuel. Several conceptual reactor/engine designs were generated by the GE-710 Program [9] and the ANL Nuclear Rocket Program [10]. The GE-710 element was designed for use in higher thrust engines and in general did not scale down well to lower thrust levels. The reverse is true for the ANL-200 element. It was designed for a low thrust engine but did not scale up well to higher power levels. The cermet engine cores also required “seven to ten times more” U-235 fuel than the GC core for the full size 25 klb_f-class engine [1].

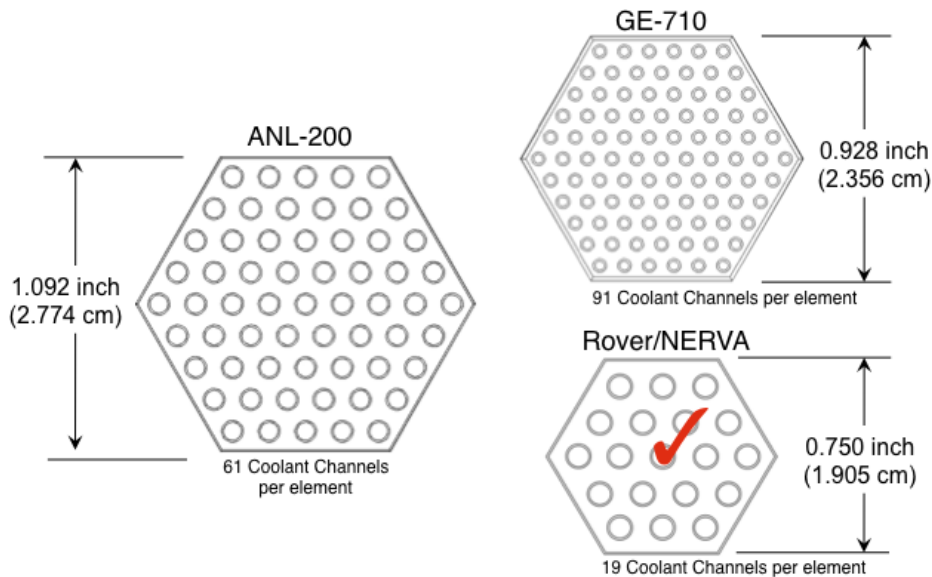

Figure 4. Heritage Fuel Element Geometries and Relative Size Comparison

Compared to the graphite-based fuels tested during Rover/NERVA, cermet fuel requires considerably more research and development time since its compositional makeup and fabrication processes are still not well defined [1]. Demonstrated operating temperatures and volumetric power densities for cermet fuel samples tested in a reactor environment (~20 samples in all) were well below that required for a viable NTP system [1]. Lastly, the cermet engine designs developed by GE and ANL were only conceptual and *no NTP cermet reactor has ever been constructed or tested – a stark contrast to the 20 reactor cores tested with graphite fuel during the Rover/NERVA program*. It is for all these reasons that composite fuel was the logical choice in developing a schedule focused on ground- and flight-testing a small engine within a 10-year timeframe.

Collaborative Modeling Approach

A collaborative integrated reactor/engine modeling effort between GRC and ORNL has been used to develop the POD designs for both the small “criticality-limited” and full size engine. Both engines used GC fuel and the established FEs and TTs used in the Rover/NERVA cores. The design and analysis sequence is an iterative one that includes the following steps: (1) establish a preliminary core configuration that meets the fundamental neutronic performance requirements of criticality and adequate control swing; (2) estimate the approximate thrust level based on power density considerations for the particular fuel being analyzed; (3) modify the core configuration to adjust criticality, control swing, and estimated thrust level of the engine; (4) use the neutron and gamma energy deposition rates resulting from steps (1-3) as input to a coupled thermal-fluid-structural (TFS) analysis of the GC core’s interior components, specifically the coupled FE and TT; and (5) once acceptable neutronic and TFS performance is achieved, perform engine cycle balance analysis and estimate of the engine’s overall size and mass.

This collaborative methodology between GRC and DOE is depicted in Fig. 5 and shows the flow of data between the different computational tools used in developing the POD designs. These tools include MCNP (Monte Carlo N-Particle transport code) for reactor neutronics [11], ANSYS for multi-physics analysis [12] and NESS (Nuclear Engine System Simulation code) for engine cycle balance analysis and mass estimation [13].

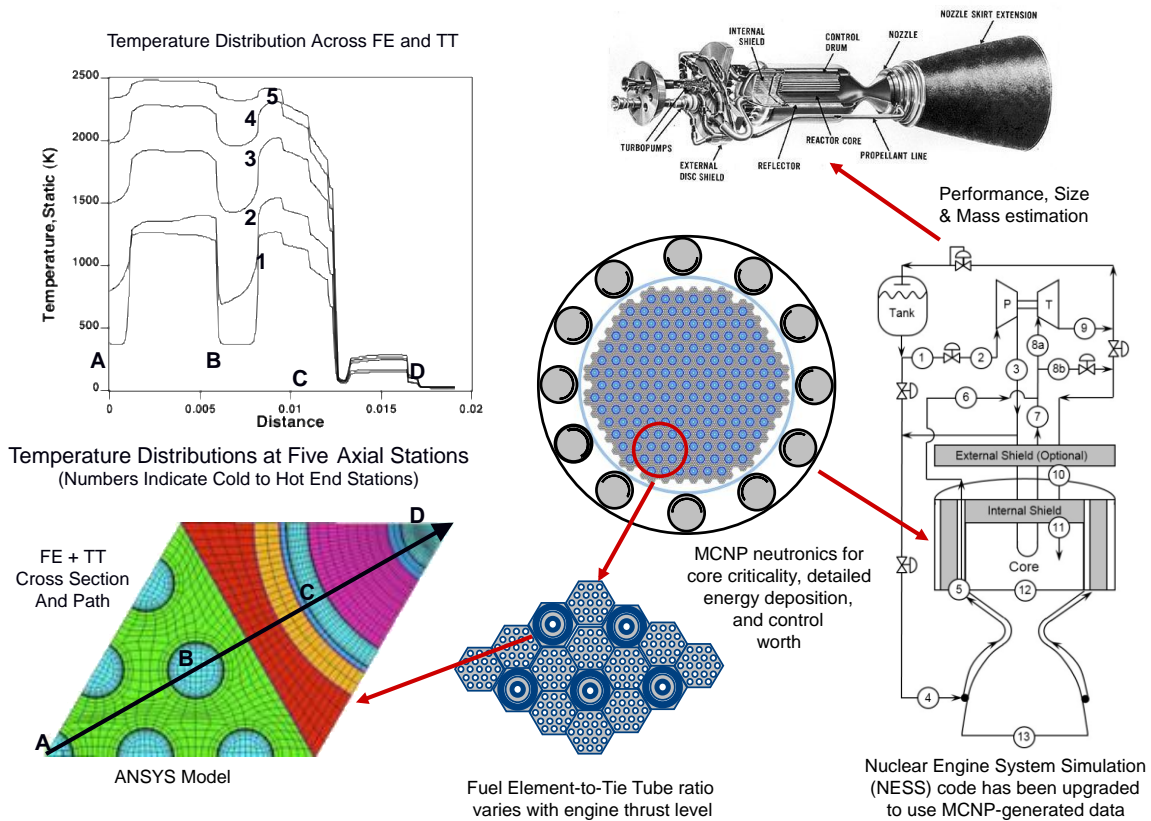

Figure 5. Computational Tool Methodology used in Designing Rover/NERVA-derived GC Engines

Criticality-Limited, SNRE and Pewee-class Graphite Composite Engine Designs

For Rover/NERVA-derived engine designs, a variety of different FE – TT arrangements are possible depending on the desired thrust class of the engine (see Fig. 6). In the larger size engines tested in the Rover program, a “sparse” FE – TT arrangement was used with each FE having 2 adjacent TTs and 4 adjacent FEs comprising its six surrounding elements. In this sparse pattern, the FE to TT ratio is ~3 to 1. In the SNRE design, shorter FEs were used and additional TTs were included in the reactor to increase core reactivity. With the “SNRE” FE – TT pattern each FE has 3 adjacent TTs and 3 adjacent FEs surrounding it and the FE to TT ratio is ~2 to 1. With this arrangement, each FE is held in position by the lower support pedestals of three adjacent TTs that provide redundant mechanical support to the FE. A cutaway view of a FE – TT bundle showing additional detail and the “outer mold

line” of the support pedestal is shown in Fig. 7 [6]. An important feature common to both the sparse and the SNRE FE – TT patterns is each tie tube provides redundant mechanical support for six adjacent fuel elements.

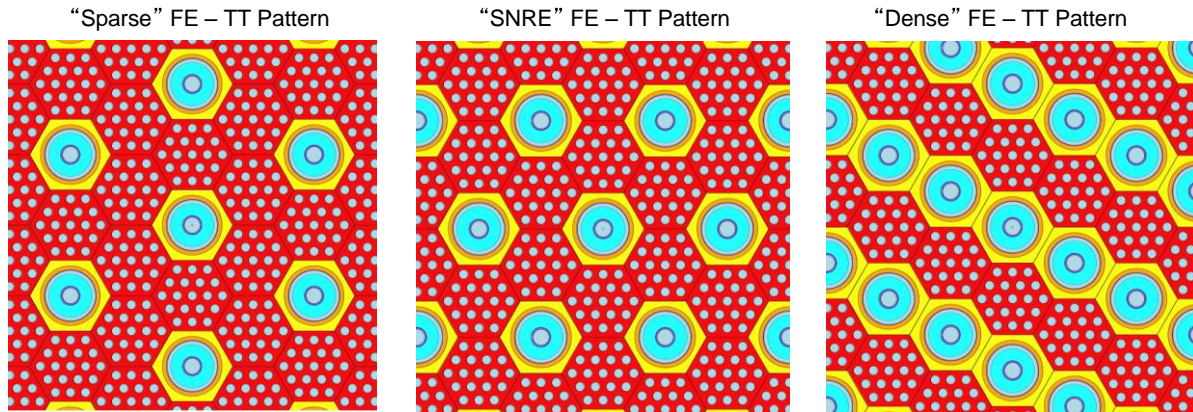

Figure 6. Possible FE – TT Arrangements for Different Thrust Class GC Engines

Recent MCNP transport modeling of engine reactor cores by Schnitzler et al., [14,15] has shown that the SNRE design can be scaled down to even lower thrust levels (~7.5 klb_f) or up to the full size 25 klb_f-class engine. For lower thrust engines with short length elements, additional reactivity gains can be achieved by employing an entirely new FE – TT arrangement identified by Schnitzler as the “dense” element pattern (shown in Fig. 6) consisting of parallel rows of FEs and TTs. In this configuration each FE has 4 adjacent TTs and 2 adjacent FEs surrounding it and the FE to TT ratio has now decreased to ~1 to 1.

Table 1 summarizes engine and reactor performance characteristics for several GC engines ranging in size from a small “criticality-limited” engine to the 25 klb_f “Pewee-class” engine used in Mars DRA 5.0. All the designs utilize an expander cycle and assume a peak fuel temperature of ~2860 K and nozzle area ratio (NAR) of 300:1. The criticality-limited engine has a thrust of ~7.52 klb_f and an engine thrust-to-weight (T/W_{eng}) ratio of ~1.9. It uses the dense FE – TT pattern (FE to TT ratio of ~1:1), 35 inch (~89 cm) long FEs and TTs, and has a fissile fuel loading of ~600 mg of 93% enriched U-235 per cm³. With a hydrogen flow rate of ~3.82 kg/s, a chamber pressure of ~565 psia and a gas temperature exiting the fuel elements (the chamber inlet temperature) of ~2739 K, the engine’s specific impulse (I_{sp}) is ~894 s. The maximum fuel temperature before melting begins is estimated to be ~2900 K for the high fuel loading used in this small engine so the temperature margin from peak to melt is ~40 K. The total quantity of enriched U-235 fuel in the engine is ~27.5 kilograms (kg). At ~7.52 klb_f thrust, the small engine has a nominal power output of ~157 MW_t and an average power density of ~3.0 MW_t per liter. The corresponding peak power density is ~5.37 MW_t per liter – just slightly higher than the ~5 MW_t per liter value demonstrated for composite fuel in the Nuclear Furnace. The engine’s overall length is ~6.19 m, which includes an ~1.26 m long, retractable radiation-cooled nozzle skirt extension. The corresponding nozzle exit diameter is ~1.38 m.

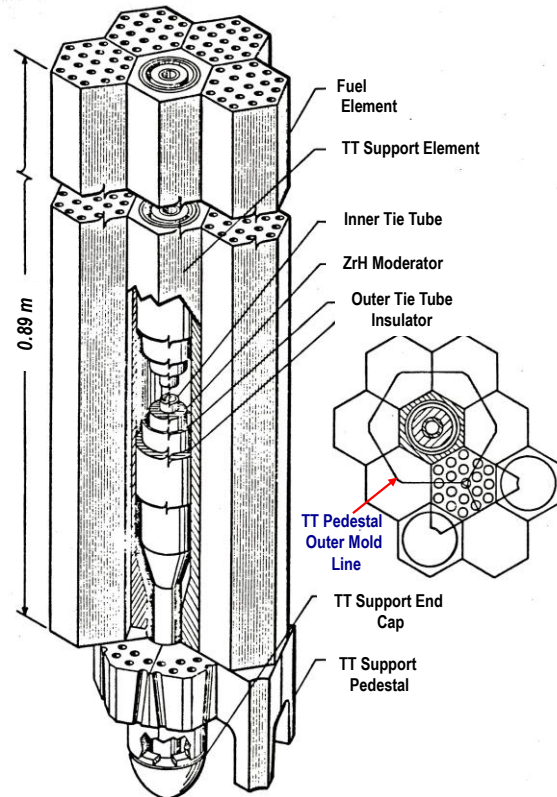

Figure 7. SNRE FE – TT Bundle Cutaway Showing TT Support Pedestal Features and Outer Mold Line

Table 1. Performance Characteristics for “Small-to-Full Size” Graphite Composite Engines

Performance Characteristic	Small Criticality	SNRE		25 klb _f Axial Growth Option	
	Limited Engine	Baseline	Baseline +	Nominal	Enhanced
Engine System					
Thrust (klb _f)	★ 7.52	16.4	★ 16.7	25.2	25.1
Chamber Inlet Temperature (K)	2739	2695	2733	2790	2940
Chamber Pressure (psia)	565	450	450	1000	1000
Nozzle Area Ratio (NAR)	300:1	100:1	300:1	300:1	300:1
Specific Impulse (s)	894	875	900	909	945
Engine Thrust-to-Weight	1.91	2.92	3.06	3.42	3.41
Approx. Engine Length* (m)	6.19	4.46	6.81	8.69	8.69
Length w/ Retracted Nozzle (m)	4.93	N/A	3.65	6.53	6.53
Reactor					
Active Fuel Length (cm)	← 89 →	89	89	132	132
Reflector Thickness (cm)	14.7	14.7	14.7	14.7	14.7
Pressure Vessel Diameter (cm)	87.7	98.5	98.5	98.5	98.5
Element Fuel/Tie Tube Pattern Type	Dense	SNRE	SNRE	SNRE	SNRE
Number of Fuel Elements	260	564	564	564	564
Number of Tie-Tube Elements	251	241	241	241	241
Fuel Fissile Loading (g U per cm ³)	0.60	0.60	0.60	0.25	0.25
Maximum Enrichment (wt% U-235)	93	93	93	93	93
Maximum Fuel Temperature (K)	2860	2860	2860	2860	3010
Margin to Fuel Melt (K)	40	40	40	190	40
U-235 Mass (kg)	27.5	59.6	59.6	36.8	36.8

*Varies with thrust level, chamber pressure, NAR and TPA/TVC layout

The performance parameters for both the 1972 baseline SNRE engine and a recent updated version (SNRE⁺) are shown in Table 1. The baseline SNRE, shown in Fig. 8, had a nominal power output of ~367 MW_t, an average power density of ~3.44 MW_t/liter, and operated with a peak fuel temperature of ~2860 K. The reactor core had 564 fuel elements, 241 tie tubes, a 14.7 cm thick reflector and a pressure vessel diameter of ~98.5 cm. The engine’s nozzle was regeneratively-cooled to a NAR of 25:1 and included a rotating uncooled nozzle skirt out to a NAR of 100:1. In its fully extended position, the engine’s overall length was ~4.5 m and its T/W_{eng} ratio was ~2.92. With a fissile fuel loading of ~0.60 grams/cm³, and over 300 more fuel elements, the U-235 fuel inventory in the SNRE core was ~59.6 kg. Other key performance parameters include a thrust of ~16.4 klb_f, a hydrogen exhaust temperature of ~2695 K, hydrogen flow rate of ~8.5 kg/s, chamber pressure of ~450 psia, and an engine I_{sp} of ~875 s.

The SNRE⁺ uses the same reactor system but produces slightly more thrust (~16.675 klb_f) and operates at a higher exhaust temperature (~2733 K). With a hydrogen flow rate of ~8.40 kg/s, a chamber pressure of ~450 psia, and a larger NAR of ~300:1, the achievable engine I_{sp} is ~900 s. The total engine length is ~6.81 m with the nozzle extended, and the nozzle exit

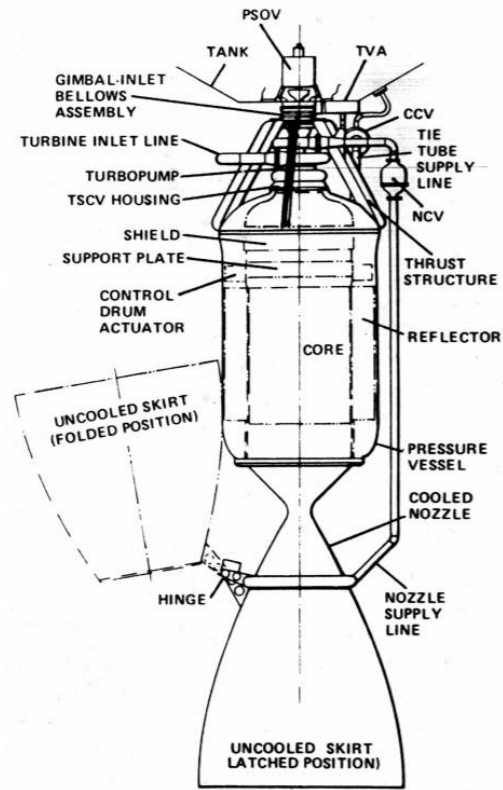

Figure 8. SNRE Schematic and Key Components

diameter is ~2.26 m. The engine T/W_{eng} is also a little higher at ~3.06.

The performance characteristics for a 25 klb_f-class GC engine, similar to that used in NASA's DRA 5.0, is based on an "axial-growth" version of the SNRE [14,16]. It uses the same SNRE FE – TT pattern but the FE length is increased from 0.89 m to 1.32 m (the same length used in the Pewee engine). The engine's performance parameters include: T_{ex} ~2790 K, chamber pressure ~1000 psia, hydrogen flow rate ~12.5 kg/s, I_{sp} ~909 s, and T/W_{eng} ~3.42. The engine has a nominal power output of ~563 MW_t and the corresponding average and peak power densities are ~3.36 and 5.70 MW_t / liter, respectively. The overall engine length is ~8.69 m, which includes an ~2.16 m long, retractable radiation-cooled nozzle skirt extension. The corresponding nozzle exit diameter is ~1.89 m. A higher chamber pressure is used in this design to help maintain reasonable nozzle dimensions at the assumed NAR.

The engine's reactor core contains 564 FEs and 241 TTs – the same number found in the SNRE. It also has the same reflector thickness and pressure vessel diameter as the SNRE. With its longer fuel elements and tie tubes, however, the U-235 fuel loading used in the reactor FEs can be reduced to ~0.25 grams/cm³ thereby lowering the inventory of 93% enriched U-235 in the core to just under 37 kilograms. Lowering the fuel loading from ~0.60 to 0.25 grams/cm³ also allows the FEs to operate at a higher peak fuel temperature of ~3010 K while still staying below the melt temperature for composite fuel of ~3050 K. The corresponding increase in the exhaust temperature to ~2940 K results in an ~35 second increase in I_{sp} to ~940 s if required to help stretch the available LH₂ propellant loading to meet mission requirements, or in the case of an emergency to allow a safe return of the crew.

Between the two small engine options analyzed – the ~7.5 klb_f criticality limited engine and the SNRE options – the SNRE⁺ configuration is an attractive option for development, ground testing and flight demonstration for the following reasons: (1) a previously developed program plan for the SNRE already exists [17] and can be used as a point of comparison; (2) the SNRE FE – TT arrangement has 6 FEs surrounding each of TT so the pedestal geometry at the bottom of each TT is the same as that used in the larger ~25 klb_f-class engine; and (3) both engines use 35 inch long FEs so the SNRE⁺ is only ~0.6 m longer than the 7.5 klb_f engine despite its higher thrust output. It can therefore be used for the single engine FTD mission, and with clustered SNRE-class engines can be used for cargo delivery and crewed lunar landing missions [18], as well as, near Earth asteroid (NEA) missions [19]. Even human Mars missions appear possible if smaller payload elements are considered along with a reduced crew size as currently being envisioned in NASA's "Evolvable Mars Campaign". *This could lead to a "one size fits all" approach to NTR development using the SNRE-class GC engine.*

On the negative size, each SNRE / SNRE⁺ reactor core has 304 more FEs than the smaller 7.5 klb_f engine core (shown Table 1). Choosing the SNRE / SNRE⁺ for GTD and FTD will require additional production capacity be brought on line to fabricate the extra 912 FEs in time to meet the start dates for the GTD tests and the FTD mission.

IV. NTP Technology Development: Recapture, Fabrication and Testing of Composite Fuel

As mentioned in the Introduction, recapturing past fuel processing techniques and demonstrating the ability to fabricate partial length FEs for testing and performance validation has been the primary focus of the NCPS and current NTP project. During the Rover/NERVA program, many thousands of high quality, precision-made FEs were produced at LANL, ORNL's Y-12 Facility, and the Westinghouse Astronuclear Laboratory (WANL). A wealth of data was generated on the required processing parameters and specifications, materials of construction, and the equipment used in fabricating and coating both particle and composite fuel. These results were documented, in great detail, in reports by Taub [5], Lyon [20] and Davidson [21].

Since 2011, researchers at ORNL have been reviewing the literature, procuring hardware, and assembling the equipment needed to fabricate and coat heritage GC fuel elements. Lab-scale equipment for FE fabrication is shown in Fig. 9 [22]. It includes the extruder, dies for producing initial 4-hole test elements and follow-on 19-hole heritage elements, and an element layout tray. Equipment setup has benefited from past "lessons learned" during the fabrication of the heavier composite elements. Due to increased friction as the fresh extrusion moved from the die along the graphite layout tray, the rear portion of the FE tended to compress and bulge so FE dimensions were wider at the back than in the front. By introducing a series of small air holes in the base of the layout tray – a feature incorporated in ORNL's current graphite insert (see Fig. 9) – the GC elements were now able to move on a film of air minimizing the sliding contact between the element and tray and eliminating fuel element distortion.

Composite fuel elements, consisting of uranium carbide, zirconium carbide and graphite matrix materials, were produced from a blended mixture of graphite flour, carbon black, ZrC powder, UO₂ powder, and thermosetting resin

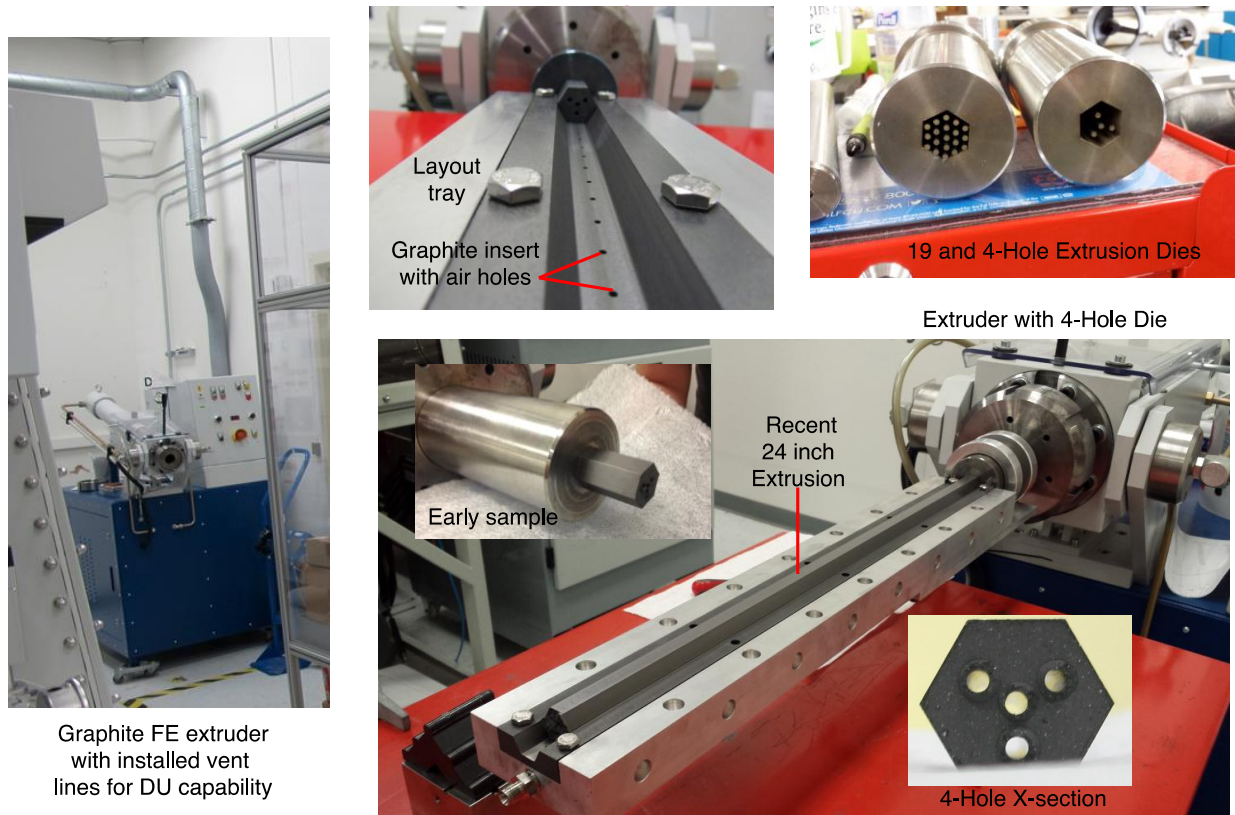

Figure 9. Equipment Assembled at ORNL for Extrusion of Composite Fuel Elements

(binder) using an extrusion process. The extruded fuel elements were then heat treated to form a “web-shaped dispersion” of solid solution UC-ZrC fuel within the graphite matrix material. In addition to reconstituting lab-scale fabrication capability, ORNL researchers face another challenge that of duplicating the source materials used to produce the composite fuel elements successfully tested in the past. Due to the inability to procure exact matches for these materials, substitutions in the fuel formulation must be made and their impact determined through testing.

Coating is another key technology that underwent significant development during the Rover/NERVA program. The CVD process became quite sophisticated allowing the nineteen 2.4 mm diameter coolant channels in each FE to be coated with NbC tailored in thickness from ~50 - 100 μm over the full 1.32 m length of the element. The coating material was later changed to ZrC – the current baseline material – because it better adhered to the graphite and had more desirable neutronic characteristics and lower fission product diffusion rates.

Key parameters important to the coating process are the optimization and control of the coating temperature and the reactant species composition as it is flowed through the element. Temperature control was accomplished using a multi-zone inductively heated furnace with the reactant gas flowing from the “cold to hot” end of the element. In order to achieve the desired coating properties over the entire FE length, the coating temperature had to be increased incrementally from the inlet to the exit end of the coating furnace to compensate for the depletion of the reactant gas as it traveled along the axial length of the fuel element [23,24].

A new “6-zone” CVD coating furnace (with 4 heating coils per zone) has been set up at ORNL (Fig. 10) to demonstrate the ability to deposit tailored thicknesses of the ZrC coating along the FE length [25]. With improved fabrication measurement techniques and coating capabilities, better matching of the CTE for the composite fuel and ZrC coating can hopefully be achieved as compared to what was possible in the 1970s. It is also envisioned that the use of current day technology, including the use of modern computer controlled temperature sensors and electronic mass flow controllers, will help improve the CVD coating process so as to further minimize cracking and erosion.

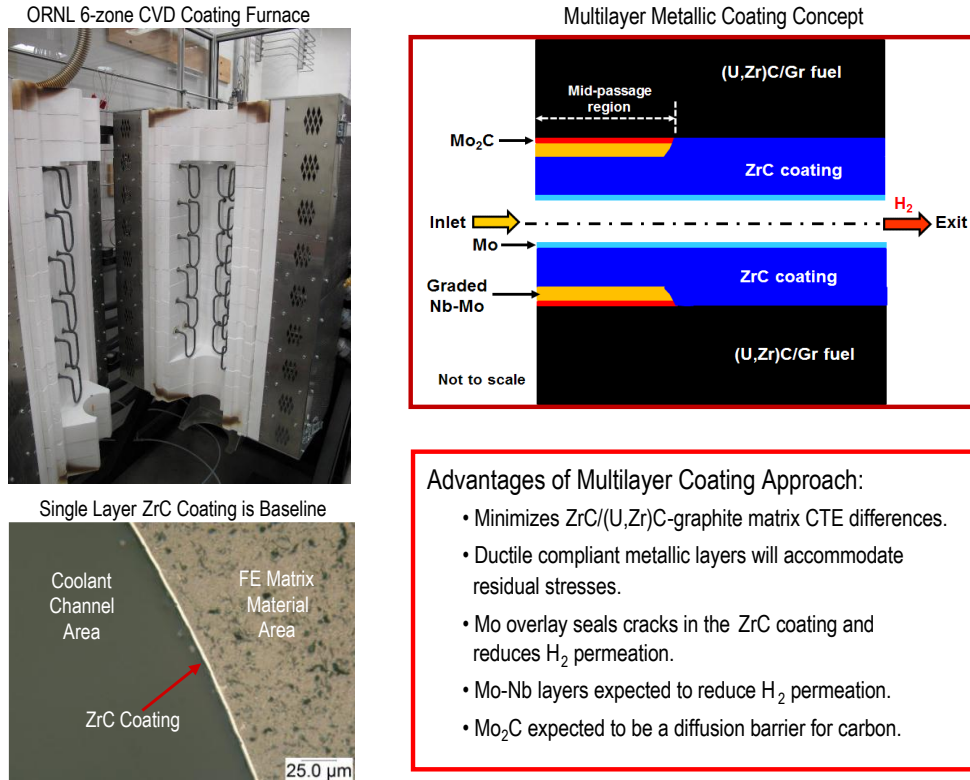

Figure 10. ORNL CVD Coating Furnace, Baseline and Alternative Coating Concepts

Additional coating materials and concepts are also being studied and developed at GRC [26] to help prevent or minimize cracking and could be applied if it persists using the baseline ZrC coating. A new, multilayer metallic coating architecture has been proposed for application to the “mid-band erosion” area of the FE where cracking was observed during the Rover/NERVA program. The new coating approach (shown schematically in Fig. 10) uses graded layers of molybdenum-niobium (Mo-Nb) positioned between the graphite matrix material and the outer ZrC coating. Its potential advantages are highlighted in Fig. 10. A Mo overlay, effectively used in some Rover/NERVA engine tests [4], can also be applied to seal any developing cracks in the ZrC and further help reduce H₂ permeation.

Lastly, because of its established database, the fuel specifications and production requirements for GC fuel are not expected to change significantly. As a result the major portion of the development plan for GC fuel will likely focus on validating new production samples and elements and correlating data on them to historical data to increase confidence in the fuel’s performance and to reduce programmatic risk.

V. NTP Ground Test Facility (GTF) Options and ConOps

Ground test demonstrations of NTP components, subsystems, and the integrated reactor/engine system are a necessary precursor to qualifying a system for flight demonstration. In contrast to the “open air” testing conducted during Rover/NERVA, current environmental protection (NEPA) standards prohibit any significant release of radioactive particulates into the air from a nuclear test facility. *As in the past, the preferred and logical location for conducting NTR ground tests is the NNSS formerly known as the Nevada Test Site.* The Site occupies ~1375 square miles and provides a large secure safety zone containing valuable on-site assets and a variety of locations well suited for NTP testing.

The pros and cons for the different ground test options can best be discussed by considering the scope of activities involved in an overall “Concept of Operations” (ConOps) for testing shown in Fig. 11. Fabricating the required number of precision fuel elements containing highly enriched U-235 (HEU) will be done at either ORNL’s Y-12 Facility or by an industry contractor team responsible for building the reactor and engine system. Building up the reactor subsystem will involve integrating the core assembly with its peripheral reflector and control drums and its

placement within the reactor pressure vessel. The hydrogen turbopump assembly, exhaust chamber and truncated regenerative-cooled nozzle will then be added to the pressure vessel to complete the engine assembly.

This buildup process will likely be performed at the Device Assembly Facility (DAF) located within the NNSS. The DAF is a state-of-the-art facility that includes a collection of steel-reinforced concrete test cells connected by a rectangular corridor. The entire complex is covered by compacted earth and spans an area of ~100,000 square feet (the size of ~11 football fields). The DAF has multiple assembly/test cells designed to handle special nuclear materials, plus high bays with multi-ton crane capability sufficient to handle the small engine sizes currently being considered. It is envisioned that the DAF will be used as a pre-test staging area for component aggregation, engine assembly and “0-power” critical testing prior to being transported to the chosen test location.

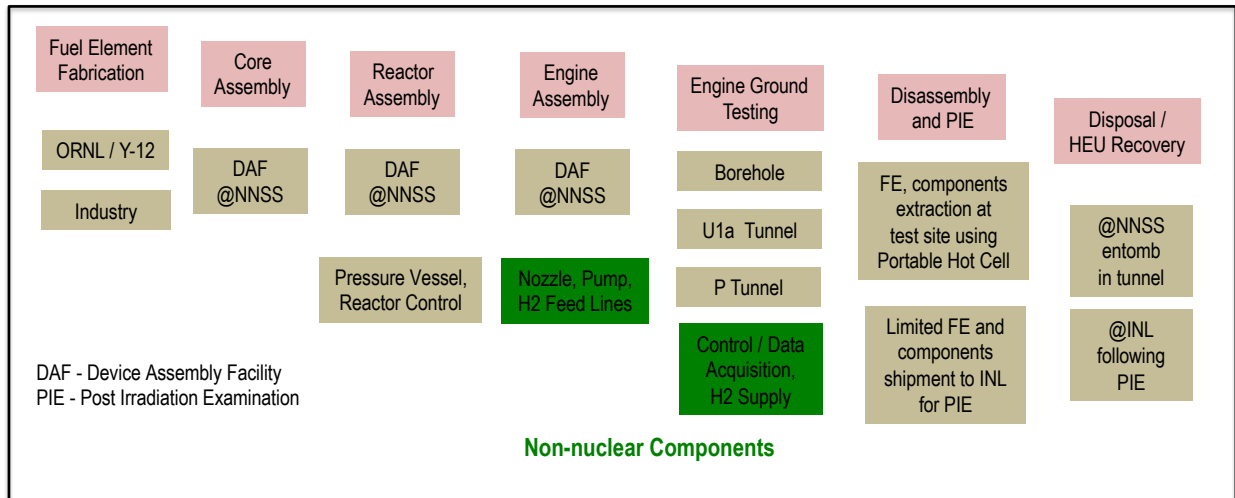

Figure 11. Possible Concepts of Operation for NTP Ground Testing

With the potential for radioactive effluent release to the atmosphere with open air testing, future test methods will require that the engine exhaust be scrubbed to remove any radioactive contaminants. This can be accomplished in one of two ways. The first option is to develop an above ground effluent treatment system (ETS) that would be attached to the engine’s nozzle and used to scrub and filter the hydrogen exhaust of any radioactive particulates and low-level fission product gases. The hydrogen-rich filtered exhaust would then be burned off in a flare stack. The design and technical feasibility of this type of ETS was successfully demonstrated on the NF-1 fuel element test reactor [4] at the end of the Rover/NERVA program. Operating at ~44 MW_t, NF-1 represents an ~1/4th - 1/10th scale demonstration of the ETS that would be needed to test the 7.5 klb_f and SNRE-class engines being considered here.

Another above ground option, referred to as “full-containment” [27], burns the hydrogen exhaust with additional oxygen to create oxygen-rich steam that is then cooled by heat exchangers, converted to water, and collected in large storage tanks. Filters and particle traps positioned along the exhaust stream remove the radioactive contaminants while the stored water is slowly filtered into retention ponds where it subsequently evaporates.

Both of the above options scale in size with engine thrust level and hydrogen throughput and can therefore become quite large and complex increasing the time and cost to build them. The second approach capitalizes on the existing geology and infrastructure at three different locations at the NNSS (included in Fig. 9) to help simplify and lower the cost of ground testing. The three sites include: (1) several deep (~1200 ft), large diameter (~8 ft) vertical holes dug previously for underground nuclear weapons testing; (2) the underground U1a complex; and (3) the P-tunnel complex located inside the Rainier Mesa.

In the SAFE (Subsurface Active Filtration of Exhaust) concept originally proposed by Howe et al., [26], the vertical boreholes and the natural geology of the soil (alluvium) are exploited to provide “in-situ” capture, holdup and subsequent filtration of the engine exhaust. Conceptually simple, the engine is enclosed within a steel containment structure attached to a concrete slab surrounding the top of the borehole. A seal around the nozzle throat extends down to the top of the hole to prevent exhaust gas release to the surface. As the engine fires down into the hole, a water or liquid nitrogen spray cools and condenses the exhaust. The pressure builds and eventually reaches a level where the amount of gas and water vapor driven into the porous soil and rock equals the mass flow

of the engine. *There is no costly fixed infrastructure. Mobile trailers are used for control and data acquisition and tank cars supply the hydrogen propellant and water used during the test.* Recent analysis of the SAFE concept and the design for a small, non-nuclear, subscale validation test of concept feasibility are reported on elsewhere [3, 29].

A disadvantage of the borehole approach is its “above ground” location that will require increased cost to maintain a secured perimeter around the site. These increased security measures are needed to protect the HEU contained within the engine and to restrict and/or limit access to the site during engine operation, the post-test cool down period, and the subsequent disassembly phase as outlined in Fig. 11. It is envisioned that a “mobile hot cell” unit would be used to disassemble and remove an initial sampling of FEs and reactor components from the engine’s reactor core for shipment to INL for PIE. The unit would be similar to that shown in Fig. 12 and developed with IAEA (International Atomic Energy Agency) funding for the recovery and packaging of Spent High Activity Radioactive Sources (SHARS) [30].



Figure 12. SHARS Mobile Hot Cell Unit with Interior Remote Manipulator Arms

Over time all of the fuel elements would be removed and transported to INL using existing shipping containers for HEU recovery before disposal since very little fuel will be consumed during engine testing. Other reactor and engine components can be shipped to INL for evaluation and disposal as well, or disposal at an appropriate NNSS location may be possible. *The NNSS has two other “less accessible” locations that can help lower the security requirements and cost to test there. At both locations, long, large diameter horizontal tunnels would be used for engine testing.*

The expansive U1a complex is located ~1000 feet below the surface and contains a series of interconnected tunnels used in conducting subcritical tests. For use in NTP testing, a new dedicated tunnel would need to be excavated to accommodate the expected NTP test conditions. To run the test, hydrogen would be supplied from the surface using double-walled piping and a water supply would cool and condense the engine exhaust before it penetrates the surrounding porous alluvium soil. A nearby parallel drift would accommodate a portable SHARS-like hot cell unit for post-test engine disassembly, FE and component removal and packaging, then transport to the surface and on to INL for PIE and disposal.

Tunnel testing deep underground can also provide an added measure of safety. Should a serious accident occur causing a significant release of fissile material, or conditions preventing safe access to the engine for test personnel, a large “quick closing valve” can be activated to entomb the disabled engine in place by sealing off the test tunnel from the rest of the complex. Entombment within the tunnel may also be a final disposal option if it is determined that the time and cost to ship the engine’s components to INL for HEU recovery and disposal are prohibitive.

Using the P-tunnel complex for NTP testing appears to be a viable option based on preliminary analysis [27]. In contrast to the boreholes and U1a tunnels dug primarily in alluvium soil, the P-tunnel walls are composed mostly of rhyolite, an extrusive igneous rock containing ~70% SiO₂. During NTR testing, these rock walls can provide a large surface area for heat dissipation reducing the need for water spray cooling. A heat exchanger can be used to condense the exhaust and reduce pressure buildup, and a nitrogen-cooled, charcoal filter can be used to remove any low-level fission product gases that might escape the fuel elements and enter the engine’s hydrogen exhaust stream. A flare stack positioned at the end of the tunnel and exiting to the surface would burn off excess hydrogen to further regulate the tunnel pressure during the test. Radiation detectors would also be used to measure radionuclide emissions within the tunnel and in the case of a significant release from failed fuel would activate a “quick closing valve” to seal off the flare stack and prevent any release to the atmosphere.

From a security and operational standpoint, testing in the P-tunnel complex is an attractive option because it has more direct access, only one entry portal to protect, and the surrounding Mesa prevents any other access to the tunnel and its interior assets. The complex is also less developed and utilized than U1a so the additional security measures that would be required for NTP testing will have less impact than if testing were to be conducted at U1a. Lastly, the tunnel already exists so the cost of digging a new one is eliminated.

VI. Candidate FTD Mission: A “Single-Burn Lunar Flyby”

To reduce the cost of the FTD mission, a simple “1-burn” lunar flyby mission is assumed. The small NTP stage (SNTPS) also maximizes the use of existing flight proven liquid rocket and stage components to further ensure affordability. The flight stage shown below in Figs. 13 uses the small criticality-limited 7.5 klb_r engine discussed in Section II. Its key features and performance characteristics are provided in Table 1 and a layout of the engine with dimensions is shown below in Fig. 13. The engine uses an RL10-class LH₂ turbopump and a lightweight radiation-cooled, retractable composite skirt like that used on the RL10B-2 engine (shown below in Fig. 14) [31, 32].

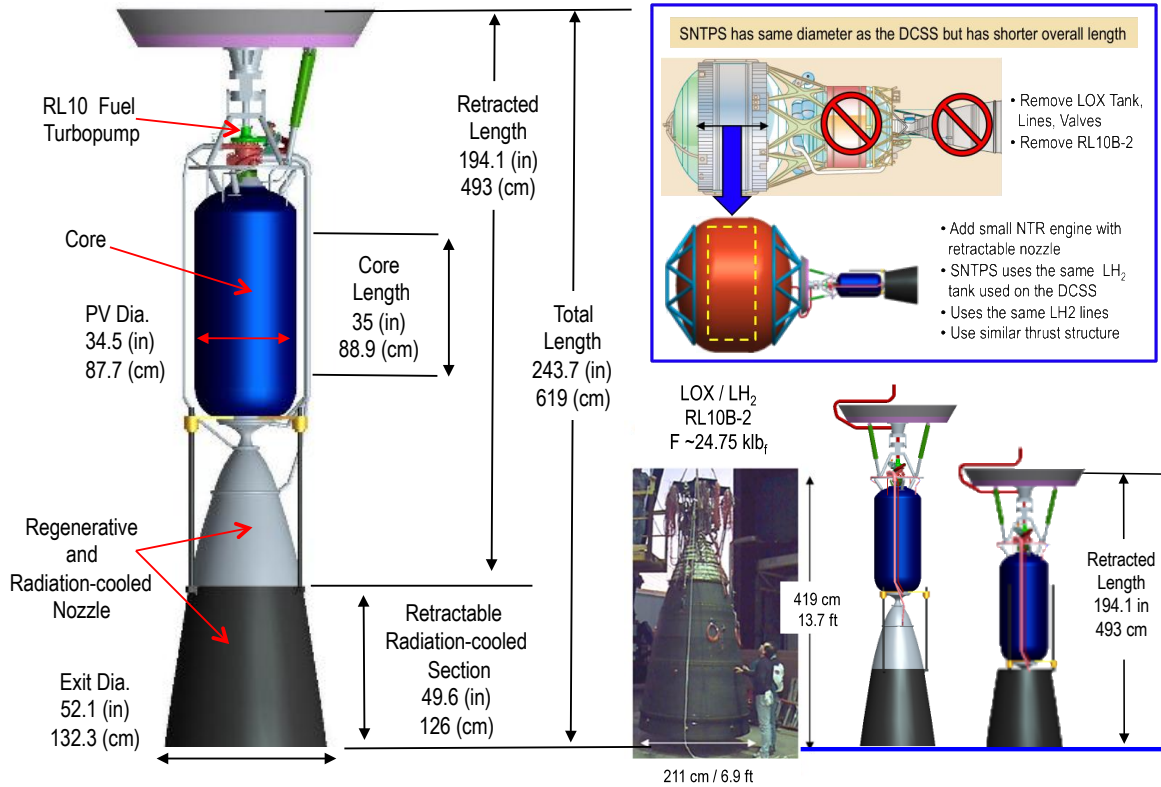

Figure 13. Engine Layout / Features for Small 7.5 klb_r NTR Engine and Stage

The thrust chamber and nozzle are regeneratively-cooled to an area ratio of 25:1 in keeping with the SNRE design. The nozzle then continues using a radiation-cooled carbon composite nozzle extension. As shown in Fig. 8, the original SNRE design used an uncooled nozzle extension to an area ratio of 100:1 that folded about a hinge located at the edge of the nozzle circumference [6]. In the engine designs presented here, a nozzle area ratio of 300:1 is used to increase I_{sp} to ~900 s. In an effort to reduce the engine’s overall length to accommodate a small mission payload and the stage’s LH₂ tank within the launch vehicle’s payload fairing, the designs presented in this paper utilize an RL10B-2 style nozzle deployment mechanism. This mechanism allows a sizeable portion of the uncooled nozzle extension to retract over the engine’s regeneratively-cooled thrust chamber, nozzle, and power head assembly (shown in Fig. 14), thus effectively reducing the engine’s stowed length by ~50%. The deployment mechanism consists of a support structure, control electronics, a drive motor, and a set of

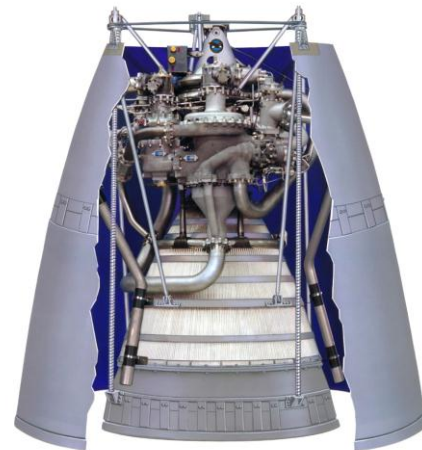

Figure 14. RL10B-2 engine with retracted nozzle extension

belt driven ball screw actuators that axially translate the nozzle skirt downward from its stowed position to its deployed position [33, 34]. When retracted, the small engine (minus the forward radiation shield) has approximately the same length as the RL10B-2 engine used on the Delta Cryogenic Second Stage (DCSS) [31].

The SNTPS uses the same LH₂ tank as that used on the DCSS so it has the same outer diameter but has a shorter overall length as shown in Fig. 13. An additional barrel section can be added to the LH₂ tank to accommodate more propellant for higher energy missions [31]. The SNTPS also utilizes other flight proven stage components found on the DCSS (e.g., systems for pressurization, attitude control, avionics and power, plus interstage and thrust structure).

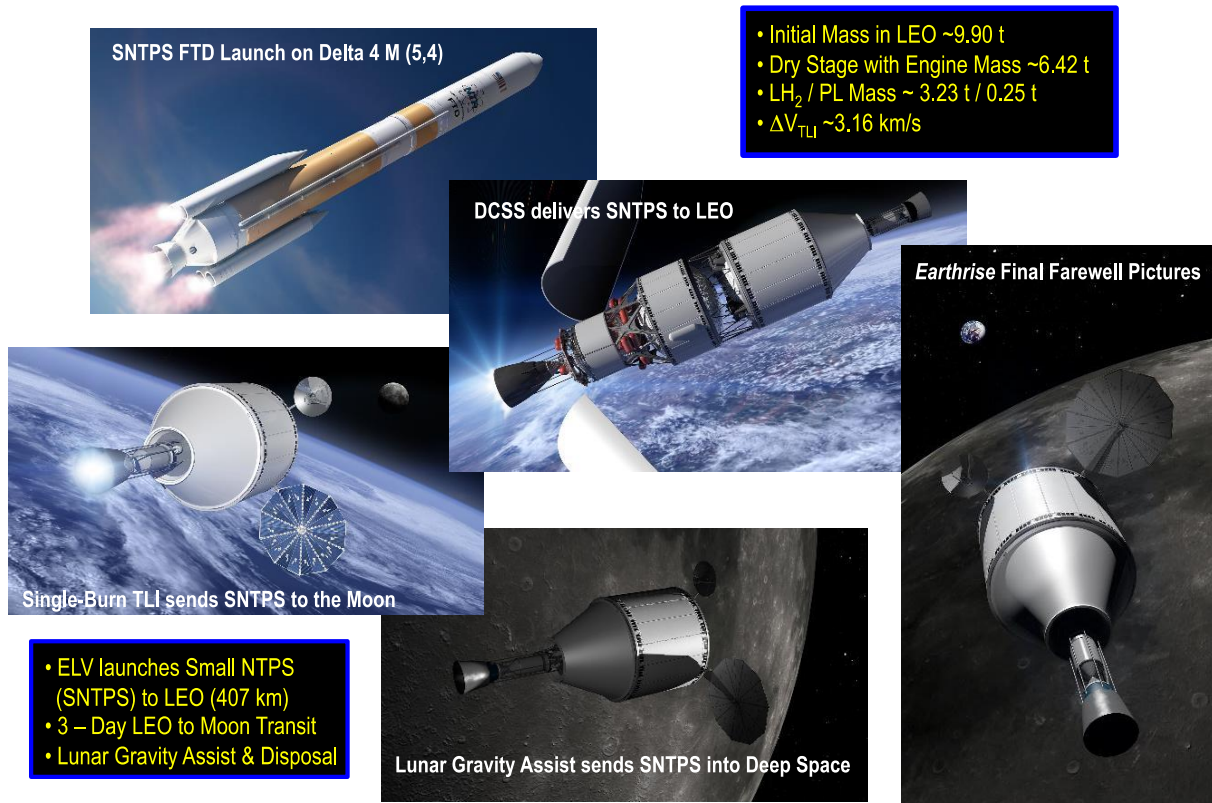

Figure 15. Key Mission Phases / Features of the Lunar Flyby FTD Mission

The FTD mission assumes the SNTPS is launched in an inverted orientation within the 5 m fairing of a Delta 4 M (5,4) and placed into low Earth orbit (LEO) using the Delta 4 DCSS as shown in Fig. 15. The Atlas 5 launch system with its 77 and 87 foot fairings can also be used and provides more payload volume and better lift capability to LEO. After separation from the DCSS, the SNTPS deploys its photovoltaic array and at the appropriate time fires its small engine to begin the 3-day journey to the Moon. Data on engine performance is transmitted back to Earth and evaluated during the outbound transit. Upon reaching the Moon, a lunar gravity assist maneuver is executed that places the SNTPS on a trajectory into deep space for disposal. As validation of a successful mission, the SNTPS might also transmit a final farewell picture – possibly of Earthrise with the lunar landscape in the foreground.

For this particular mission, the SNTPS carries ~3.23 t of LH₂ propellant and uses ~2.97 t during its single trans-lunar injection (TLI) maneuver. With ~7.52 klb_f of thrust and a I_{sp} of ~894 s, the hydrogen flow rate is ~3.82 kg/s and the total engine burn time is ~12.96 minutes. The U-235 burn-up for this mission is minuscule. With a nominal power output of ~157 MW_t and assuming ~1.2 grams consumed per megawatt-day of engine operation, the amount of U-235 consumed is ~1.70 grams which is ~0.0062% of the total ~27.5 kg contained in the small engine.

Using the SNRE⁺ – which is longer (by ~0.6 m) and heavier (by ~0.64 t) – increases the length of the SNTPS along with its LH₂ propellant loading to ~3.66 t of which 3.37 t is used during TLI. With a thrust of ~16.675 klb_f, I_{sp} of ~900 s, and a hydrogen flow rate is ~8.4 kg/s, the total engine burn time is cut in half to ~6.69 minutes. For the higher operating power (~367 MW_t), but shorter burn duration, the U-235 burn-up during the FTD lunar flyby mission is ~2.05 grams which is ~0.0035% of the total ~59.6 kg contained in the SNRE⁺.

VII. Applicability of “SNRE⁺-class” Engine for Future NASA Human Exploration Missions

While the 7.5 klb_f engine is sufficient for the FTD mission and a variety of robotic science missions [31, 35], the higher thrust ~16.7 klb_f SNRE⁺-class engine is better suited to support future human exploration missions. Using a common NTP stage (NTPS) with a 3-engine cluster of SNRE⁺ engines, along with a supplemental in-line LH₂ tank, year-long round trip near Earth asteroid (NEA) missions [19], lunar cargo and crewed lunar landing missions [18], and even human Mars missions are possible assuming smaller individual payload elements and crew size as currently envisioned in NASA’s Evolvable Mars Campaign (EMC). A brief discussion of these candidate missions along with the associated vehicle features and operational requirements on the SNRE⁺ engines is provided below.

Reusable Crewed Mission to NEA 2000 SG344

Crewed NEA missions have been studied previously by NASA as attractive precursors for demonstrating key in-space exploration technologies and capabilities (e.g., reliable life support systems, long duration habitation and cryogenic fluids management, and advanced propulsion) required for traveling through and living in deep space. In addition to the scientific knowledge gained by an “up close and personal” examination of these primordial objects, NEA missions can also provide a proving ground for validating the spacecraft systems that will be needed before sending astronauts to Mars.

The small NEA, 2000 SG344, is an example of low energy target. It has a 2028 launch date and a round trip time of ~327 days that includes a 7-day stay time. Specific mission ΔV budget details include trans-NEA injection (TNI) $\Delta V_{TNI} \sim 3.254$ km/s, braking upon arrival $\Delta V_{Arrival} \sim 0.144$ km/s, trans-Earth injection (TEI) $\Delta V_{TEI} \sim 0.392$ km/s and Earth orbit capture (EOC) $\Delta V_{EOC} \sim 1.203$ km/s (into an assumed 500 km perigee x 20,238 km apogee 6-hr elliptical Earth orbit (EEO) with an arrival V_{inf} at Earth of ~0.855 km/s).

Key features of the nuclear-powered Asteroid Survey Vehicle (ASVN) developed for this mission are shown in Fig. 16. Called “*Search Lite*”, it is a zero-gravity (0-g_E) in-line vehicle that uses autonomous rendezvous and docking (R&D) for assembly and has three key elements: (1) the “core” NTPS; (2) an integrated “saddle truss” and LH₂ drop tank assembly; and (3) the crewed NEA payload (PL) element. The latter includes the Orion Multi-Purpose Crew Vehicle (MPCV), a TransHab module outfitted for 4 crew, deployable rectangular photovoltaic arrays (PVAs) used for primary power, a 2-person Multi-Mission Space Exploration Vehicle (MMSEV) used for close-up inspection and sample gathering, and a short saddle truss connecting the payload element to the rest of the ASVN. The MMSEV is attached to the TransHab via a short transfer tunnel that also contains a secondary docking port.



Figure 16. “*Search Lite*” ASVN used in Reusable Crewed Mission to NEA 2000 SG344

Search Lite’s NTPS uses a three-engine cluster of SNRE⁺ engines and carries external radiation shield mass on each engine for additional crew protection. The NTPS uses a 7.6 m diameter aluminum-lithium (Al/Li) LH₂ tank and housed within its forward cylindrical adaptor section are the reaction control system (RCS), avionics, batteries,

deployable twin Orion-type circular PVAs, and docking system, along with a reverse turbo-Brayton cryocooler system for zero boil-off (ZBO) LH₂ storage. The Brayton cryocooler system mass and power requirements increase with tank diameter and are sized to remove ~42 watts of heat penetrating the 60 layer MLI system while the stage is in LEO where the highest tank heat flux occurs. To remove this heat load, the 2-stage cryocooler system requires ~5.3 kW_e for operation. Twin circular PVAs on the propulsion stage provide the electrical power for the ZBO system in LEO until the primary PVAs on the crewed PL section are deployed prior to TNI.

Individual vehicle components for *Search Lite* are limited to 70 t and it is assumed that three “upgraded” SLS-1B launches, each with a capable expendable upper stage, are available to deliver them to the 407 km LEO assembly altitude. The vehicle’s initial mass in LEO (IMLEO) is ~184.6 t which includes the NTPS (~70 t), the saddle truss and drop tank assembly (~59.2 t) and the PL section (~55.4 t). The overall vehicle length is ~78.3 m including the 8.9 m long Orion MPCV. The long and short saddle truss segments connecting the vehicle elements together are a composite structure whose mass scales with tank diameter and length.

The LH₂ tank lengths and propellant loadings are ~15.7 m and ~39.7 t for the NTPS, and ~16.7 m and ~42.6 t for the drop tank. The NTPS used on *Search Lite* is the same as that used on the reusable, lunar cargo delivery and crewed landing missions discussed below. It is the crewed mission application that actually determines the NTPS’s physical dimensions and characteristics. Maximizing the use of common hardware elements (e.g., same size NTPS, propellant tanks) for different mission applications has been an important consideration emphasized here to help reduce vehicle development and recurring costs.

The reusable crewed mission to 2000 SG344 requires 5 primary burns (4 restarts) that use ~76.2 t of LH₂ propellant. With ~50 klbf of total thrust and a I_{sp} of ~900 s, the total engine burn time is ~50.4 minutes. The first of the two TNI perigee burns is the longest single burn at ~27.4 minutes after which the vehicle’s drop tank is drained and jettisoned. The NTPS provides the LH₂ propellant needed for the remaining propulsive maneuvers: the second perigee burn (~9.7 minutes), braking at 2000 SG344 (~1.2 minutes), TEI (~3.1 minutes), and EOC (~9.0 minutes). With the vehicle’s available propellant capacity, it is also capable of capturing into a lower apogee, higher energy 6-hr EEO at the end of the mission. For this round trip mission, the U-235 burn-up in each engine is ~15.4 grams which is less than 0.026% of the total ~59.6 kg contained in the SNRE⁺.

Reusable Lunar Cargo Delivery Mission

Nuclear thermal propulsion can also play an important role in returning humans to the Moon by providing an affordable in-space lunar transportation system (LTS) with reuse capability that could allow initial lunar outposts to evolve into eventual settlements capable of supporting commercial activities. *The NTPS is the “workhorse” element of the LTS* [18] and has the same features and characteristics as that used on *Search Lite*. The second major element is an “in-line” Al/Li propellant tank that connects the NTPS to the forward PL element. It has the same 7.6 m diameter and supplies the LH₂ propellant needed for the “2-perigee burn” TLI maneuver. Depending on the mission and the PL carried, the tank length can vary from ~15.7 m (same length as in the NTPS) to ~18.7 m and capable of holding ~49.0 t of LH₂ propellant. The in-line tank element also includes forward and aft cylindrical adaptor sections that house quick connect/disconnect propellant feed lines, electrical connections, a RCS along with docking and payload adaptors. A ZBO cryocooler system is not used on the in-line LH₂ tank since it is drained during the TLI maneuver. The total length of the in-line element varies from ~20.7 to 23.7 meters.

On cargo flights, the lunar NTR (LNTR) transport can deliver an ~60 t integrated habitat lander with surface mobility to low lunar orbit (LLO) then return to Earth for refueling and reuse. Three SLS-1B launches are again used to deliver the vehicle and payload elements to LEO for assembly via autonomous R&D. The LNTR cargo transport then departs from LEO ($C_3 \sim -1.678 \text{ km}^2/\text{s}^2$, $\Delta V_{\text{TLI}} \sim 3.214 \text{ km/s}$ including a g-loss of ~117 m/s) and captures into a 300 km circular LLO (arrival $C_3 \sim 1.151 \text{ km}^2/\text{s}^2$ and $\Delta V_{\text{LOC}} \sim 906 \text{ m/s}$ including g-loss) approximately 72 hours later. Key phases of the cargo delivery mission are illustrated in Fig. 17.

Once in orbit, the habitat lander separates from the LNTR transport and descends to the surface, landing autonomously at a predetermined location on the Moon. It is assumed that the habitat landers use LOX/LH₂ chemical engines and are also equipped with either deployable wheels (shown in Fig. 17) or articulated landing gear allowing movement in both the vertical and horizontal directions so that the landers can either “drive or walk” short distances from the landing site. Connecting several “functionally different” lander modules together (for habitation, science, equipment servicing) would form a large contiguous pressurized volume for the crew and also provide a “building block” approach to establishing an initial lunar base.

After payload separation and a day in LLO, the LNTR cargo transport performs a TEI burn ($C_3 \sim 0.945 \text{ km}^2/\text{s}^2$, $\Delta V_{\text{TEI}} \sim 857 \text{ m/s}$ including g-loss) and returns to Earth 72 hours later. On final approach, it performs a braking burn

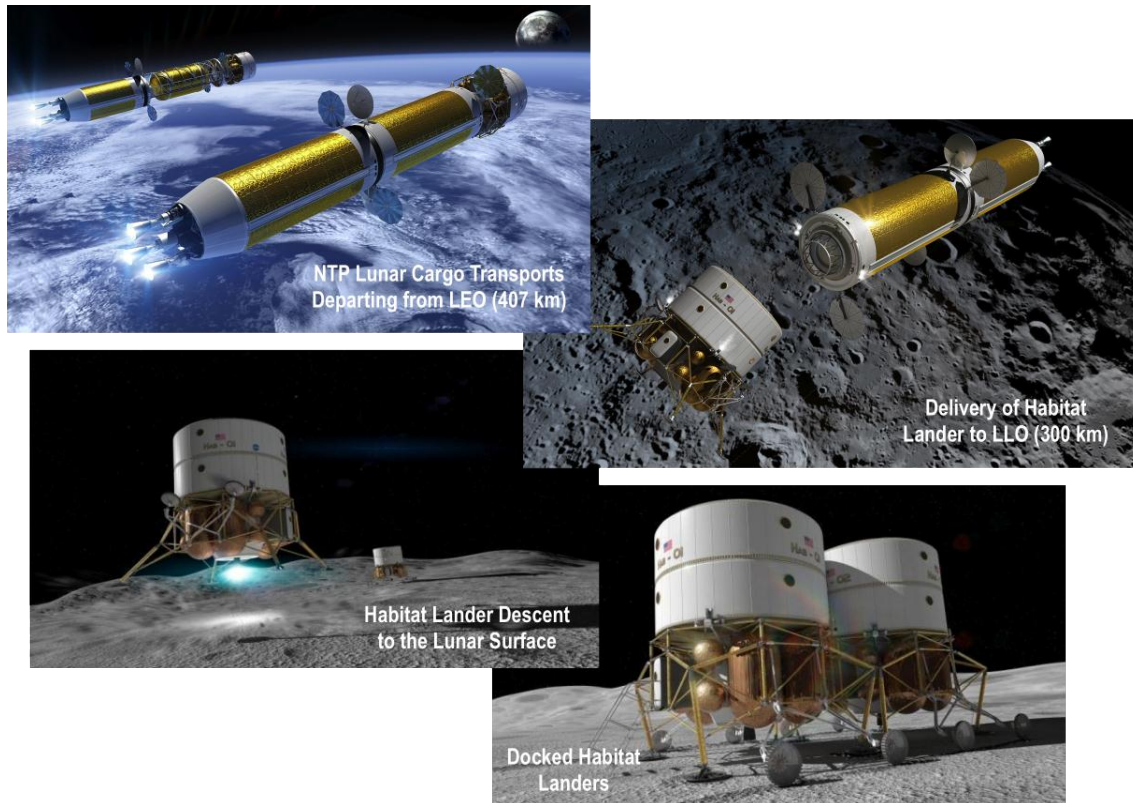

Figure 17. Reusable NTP Lunar Cargo Delivery Mission Phases

(arrival $C_3 \sim -1.755 \text{ km}^2/\text{s}^2$, $\Delta V_{\text{EOC}} \sim 366 \text{ m/s}$) and captures into a 24-hour EEO with a 500 km perigee x 71,136 km apogee. Post burn engine cool-down thrust is then used to assist in orbit lowering. An auxiliary tanker vehicle, operating from a LEO servicing node/propellant depot, supplies the additional LH_2 propellant to the cargo transport for final orbit lowering and rendezvous with the LEO transportation node where it is refurbished and resupplied before its next mission.

The LNTR cargo transport shown in Fig. 17 has an IMLEO of $\sim 186.7 \text{ t}$ consisting of the NTPS ($\sim 70 \text{ t}$), the in-line tank element ($\sim 52.6 \text{ t}$), and the habitat lander ($\sim 61.1 \text{ t}$) with its connecting structure ($\sim 3.0 \text{ t}$). The overall vehicle length is $\sim 60.4 \text{ m}$. The cargo transport also uses $\sim 15.7 \text{ m}$ long tanks in both the NTPS and in-line element with each tank carrying $\sim 39.7 \text{ t}$ of LH_2 propellant. By using clustered SNRE⁺ engines and maximizing the use of common hardware elements (e.g., same size NTPS, propellant tanks) for a variety of mission applications it should be possible to reduce vehicle development and recurring costs while also improving the overall LTS affordability.

For the reusable cargo delivery mission, 5 primary burns by the SNRE⁺ engines use $\sim 74.5 \text{ t}$ of LH_2 propellant. With $\sim 50 \text{ klb}_f$ of total thrust and $I_{\text{sp}} \sim 900 \text{ s}$, the total engine burn time is ~ 49.2 minutes. The first of the two TLI perigee burns is the longest at ~ 21.4 minutes. The durations of the remaining burns are as follows: ~ 15.5 minutes (second perigee burn), ~ 8.0 minutes (LOC), ~ 3.1 minutes (TEI) and ~ 1.2 minutes (EOC). These operational requirements are well below those demonstrated in the NERVA program that included a 62 minute maximum single burn demonstrated by the NRX-A6, and ~ 2 hours of accumulated burn time with 27 restarts demonstrated by the NRX-XE [4]. Lastly, for this round trip cargo mission, the U-235 burn-up in each SNRE⁺ is ~ 15.05 grams which is $\sim 0.025\%$ of the total quantity of HEU contained in the engine's core.

Reusable Crewed Lunar Landing Mission

On the crewed landing missions, the LNTR transport carries a forward mounted saddle truss that connects the payload elements to the transfer vehicle's in-line tank. The truss is open on its underside and its forward adaptor ring provides a docking interface between the Orion MPCV and a single stage LOX/ LH_2 lunar descent/ascent vehicle (LDAV) as shown in Fig. 18. The LDAV is a "heritage" design [36] analyzed in considerable detail by NASA and

industry during the Agency’s Space Exploration Initiative of the early 1990’s. It carried a crew of 4 plus 5 t of surface payload stored in two “swing-down” containers mounted on each side of the crew cab.

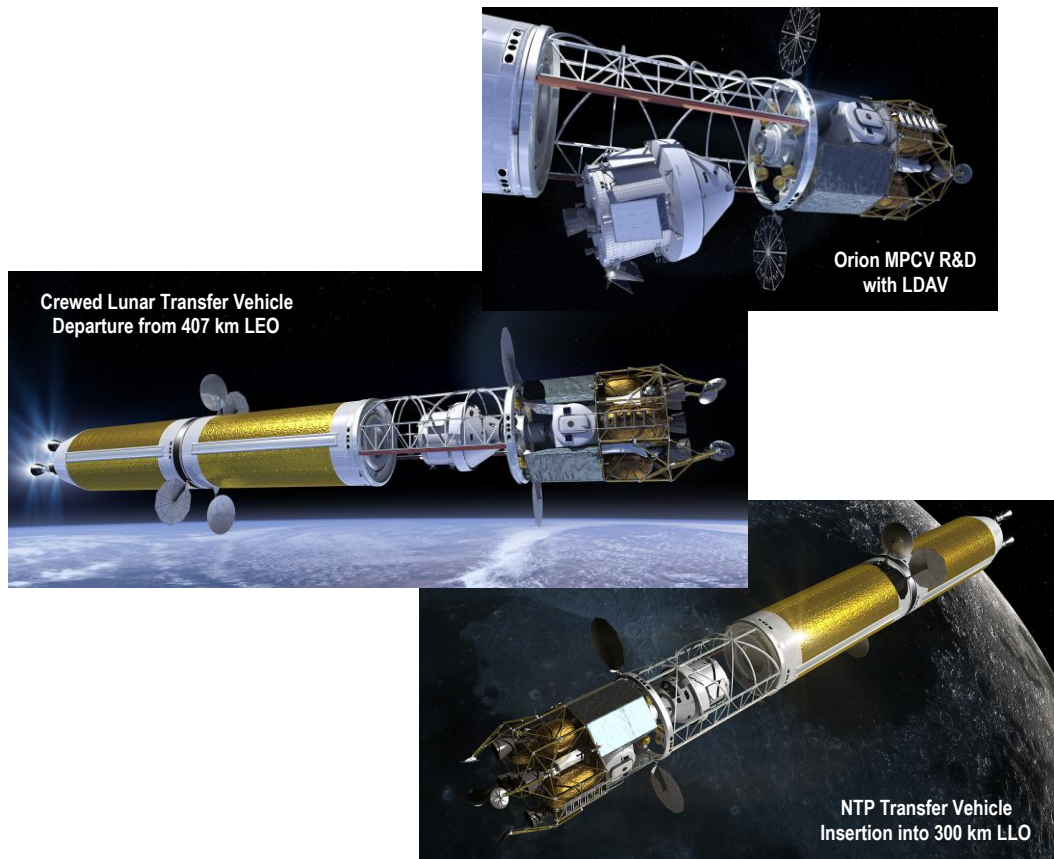

Figure 18. Reusable NTP Crewed Lunar Landing Mission – Outbound Mission Leg

Again, as with the cargo mission, three SLS-1B launches are used to deliver the two NTR vehicle elements and the payload element – consisting of an integrating saddle truss assembly (STA) and a LDAV with its surface cargo containers – to LEO for assembly via autonomous R&D. In addition to a front and rear docking capability, the STA’s forward adaptor ring also carries twin PVAs and a RCS. Once assembled, the Orion MPCV and crew are launched and rendezvous with the LNTR vehicle positioning itself inside the STA and docking with the LDAV using a docking port and transfer tunnel mounted to the STA’s forward adaptor ring (shown in Figs. 18). The key phases of the crewed NTR landing mission are illustrated in Figs. 18 and 19.

After the “2-perigee burn” TLI maneuver ($C_3 \sim -1.516 \text{ km}^2/\text{s}^2$, $\Delta V_{\text{TLI}} \sim 3.214 \text{ km/s}$ including a g-loss of $\sim 110 \text{ m/s}$), the crew begins its 3-day coast to the Moon. Because the crewed LNTR transport carries a significant amount of payload mass (the STA, MPCV, and LDAV) back from the Moon, it uses a longer ($\sim 18.7 \text{ m}$) in-line tank to supply the required amount of LH_2 propellant needed for this reusable mission. After its 72-hour transit, the LNTR vehicle performs the LOC burn (arrival $C_3 \sim 1.217 \text{ km}^2/\text{s}^2$ and $\Delta V_{\text{LOC}} \sim 913 \text{ m/s}$ including g-loss) inserting itself and its payload into LLO.

Once in LLO, the crew enters the LDAV, separates from the LNTR transport and lands on the Moon (shown in Fig. 19). The LDAV has a “wet” mass of $\sim 35.3 \text{ t}$ that includes the crew cab ($\sim 2.5 \text{ t}$), the descent/ascent stage ($\sim 6.1 \text{ t}$) and its LOX/LH_2 propellant ($\sim 20.9 \text{ t}$), surface payload ($\sim 5 \text{ t}$), plus the 4 crew and their suits ($\sim 0.8 \text{ t}$). After separating from the LNTR, the LDAV’s two payload containers are rotated 180 degrees and lowered into their landing position in preparation for descent to the lunar surface. The ΔV budget for the LDAV includes the following [36]: $\Delta V_{\text{des}} \sim 2.115 \text{ km/s}$ and $\Delta V_{\text{asc}} \sim 1.985 \text{ km/s}$. The LDAV uses five RL 10A-4 engines that operate with a $I_{\text{sp}} \sim 450 \text{ s}$ consistent with the Martin Marietta design [36]. It expends $\sim 13.4 \text{ t}$ of LOX/LH_2 propellant during the descent to the surface. After lunar touchdown, the crew can operate out of the LDAV for $\sim 3 - 14$ days using its surface landed payload or longer (~ 180 days) using the pre-deployed habitat landers.

As the surface mission nears its completion, the crew prepares the LDAV for departure. At liftoff, the LDAV mass is ~15.1 t and ~5.5 t of propellant is used during the ascent to LLO. The LDAV, with 100 kg of lunar samples, then rendezvous with the LNTR vehicle and preparations for the TEI maneuver begin. After completing the departure burn ($C_3 \sim 0.949 \text{ km}^2/\text{s}^2$, $\Delta V_{\text{TEI}} \sim 856 \text{ m/s}$ with g-loss), the crew spends the next 3 days in transit readying the LNTR for the final phase of the mission – capture into a 24-hr EEO (arrival $C_3 \sim -1.740 \text{ km}^2/\text{s}^2$, $\Delta V_{\text{EOC}} \sim 367 \text{ m/s}$) with the MPCV and LDAV (shown below in Fig. 19) followed by MPCV separation and capsule re-entry of the crew.

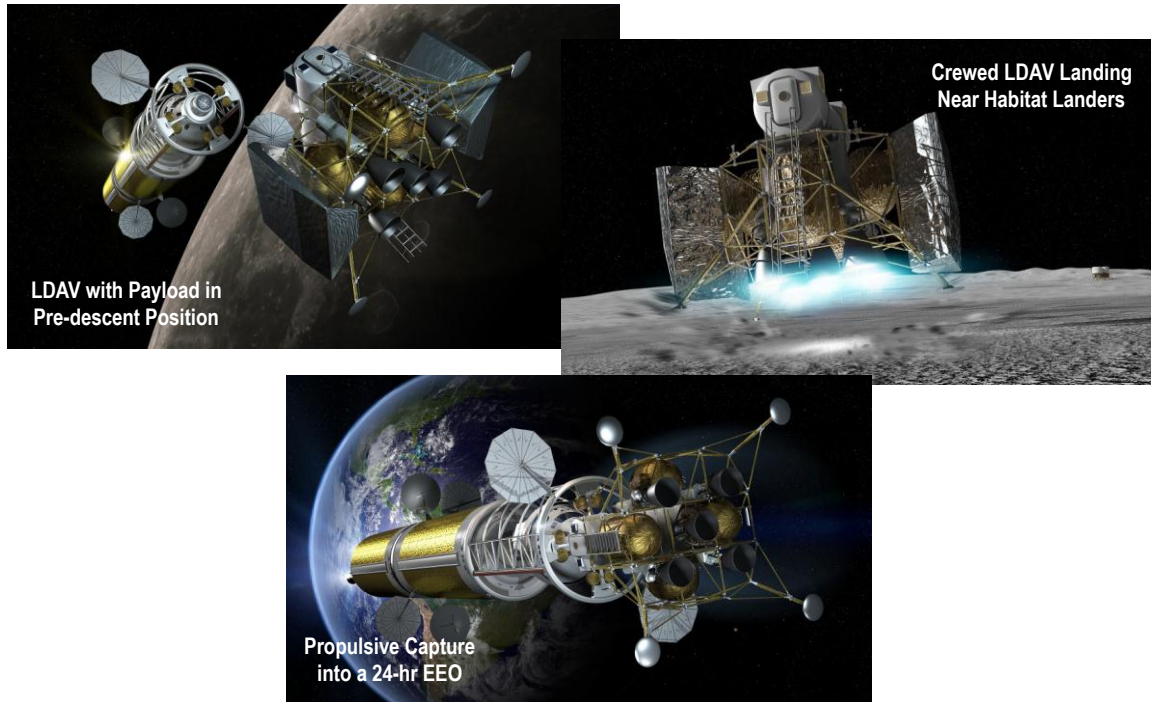

Figure 19. Reusable NTP Crewed Lunar Landing Mission – Landing and Return Mission Leg

The crewed lunar landing mission has an IMLEO of ~188.6 t that includes the NTPS (~70.0 t), the in-line tank assembly (~63.3 t), the STA (~6.4 t), the wet LDAV (~29.5 t) with its surface payload (~5 t), the Orion MPCV (~13.5 t), consumables (~0.1 t), and 4 crewmembers (~0.8 t includes lunar EVA suits). The overall vehicle length is ~77.3 m. For the crewed mission, the LH_2 propellant loads in the NTPS and in-line tank are at their maximum capacity of ~39.7 t and ~49.0 t for their specified tank lengths of ~15.7 m and ~18.7 m, respectively.

The crewed landing mission also requires 5 primary burns. With 50 klb_f of total thrust, $I_{\text{sp}} \sim 900 \text{ s}$, and ~83.2 t of LH_2 propellant used during the mission, the total engine burn time is ~55 minutes, again well under the capabilities demonstrated in the NERVA program. The first perigee burn is the longest at ~21.0 minutes with the duration of the remaining burns as follows: ~16.2 minutes (second perigee burn), ~8.2 minutes (LOC), ~6.9 minutes (TEI) and ~2.7 minutes (EOC). Finally, for the round trip crewed mission, the U-235 burn-up in each engine is ~16.8 grams which is ~0.028% of the total quantity contained in each engine core.

Key features and the relative size comparison of the *Search Lite* ASV, lunar cargo delivery and crewed landing mission vehicles are shown in Fig. 20. Other interesting lunar mission applications of NTP include robust crewed science missions to a small asteroid returned to E- ML_2 using solar electric propulsion (SEP) and “week-long” orbital tourism flights that include a day in lunar orbit for some “out of this world” sightseeing. Additional details on these missions and the associated vehicles – all using SNRE⁺-class engines – can be found in Ref. [18].

Reusable Crewed Mars Mission Possibilities Using “Evolvable Mars Campaign” (EMC) Assumptions

The EMC is a spartan, minimalist approach [37, 38] to human Mars exploration focused on using near-term space transportation system elements currently under development or being planned by NASA – such as the SLS, Orion, a deep space habitat, 100-300 kW_e-class SEP, along with existing storable bi-propellant chemical propulsion (CP) –

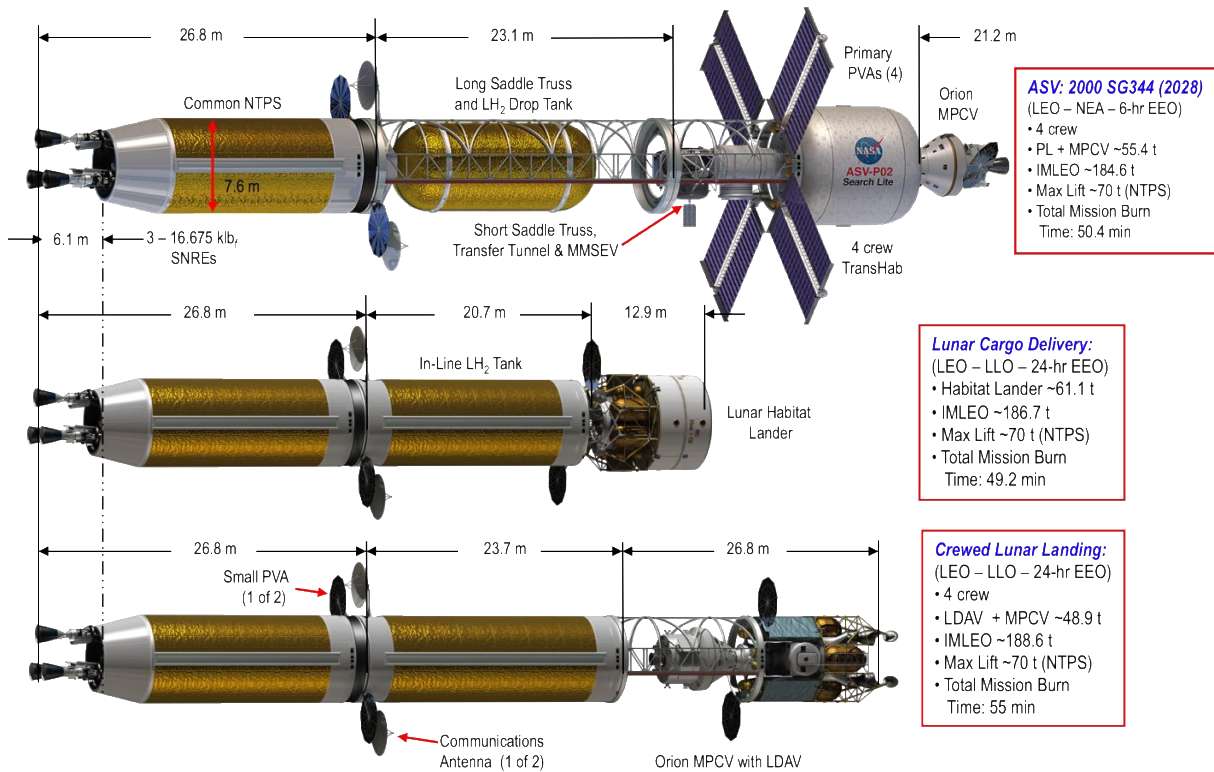

Figure 20. Reusable NTP Vehicles for NEA, Lunar Cargo and Crewed Landing Missions

and determining if such missions are possible within the projected annual budgets envisioned for the Agency in the future. A variety of mission architectures and technology options have been examined for the EMC but most involve the use of several high power / high I_{sp} SEP cargo tugs to preposition assets in the Mars system prior to crew arrival. Transit times to Mars for the SEP mission are on the order of 3.5 years [37]. The crewed mission uses CP (specifically the cryogenic expendable upper stage (EUS) from the SLS) to depart from a high Earth orbit plus a separate Mars orbit injection (MOI) storable stage for capture into a 1-sol elliptical Mars orbit (EMO) with a 250 km perigee and ~33,793 km apogee. A prepositioned storable trans-Earth injection (TEI) stage is used for Earth return.

A hybrid SEP/CP architecture [38] would depart from a Lunar Distant Retrograde Orbit (LDRO) where both the propellant (storable bi-propellant for the CP system and xenon for the SEP stage) and additional logistics required for the Mars mission would be aggregated and used to outfit the hybrid spacecraft. The Mars crew would R&D with the hybrid spacecraft only after it had departed its LDRO on a 6-month long transfer to a Lunar Distance High Earth Orbit (LDHEO) via a solar perturbation loop and a pair of Lunar Gravity Assists (LGAs) [38].

The crew transit time to Mars would be ~200-250 days. On Mars approach, the CP component of the crewed hybrid system performs the MOI burn and captures into a highly elliptical Mars orbit (HEMO) with a period of ~5 - 10 sol. These larger Mars orbits are required for this architecture and can reduce the propellant requirements on the storable CP system by more than 50% compared to that required for capture into a 1-sol orbit.

A stepwise approach to human activities is envisioned in the EMC with an orbital survey mission of Mars and a visit to its moon, Phobos, in 2033, followed by a short-stay landing on Mars in 2039, then a one-year stay in 2043 [37]. Once in Mars orbit, the crewed Mars transfer vehicle (MTV) would rendezvous with the prepositioned assets. For the Phobos mission this would be a Phobos transfer stage that would carry the Orion capsule with its 4 crew to a habitat module placed on Phobos during an earlier SEP cargo mission. After an ~1-year stay on Phobos, including extensive surface exploration and scientific observations of Mars, and a possible stopover at Mars' other moon, Deimos, the crew returns to the deep space habit (DSH) in its EMO. Because the MOI stage is drained of propellant during the capture burn, it is jettisoned and the DSH and Orion are reconfigured with the prepositioned TEI stage. At the conclusion of the ~500-day stay in the Mars system, the TEI stage sends the DSH and Orion on an ~200-250-day return trajectory to Earth where the crew performs a direct Earth re-entry and landing using the Orion capsule. All total, the mission duration would be ~900 – 1000 days in a 0- g_E environment.

For the SEP/CP orbital mission discussed above, four upgraded SLS launches are required. For the short and long surface stay landing missions, the required number of SLS launches increases to six and ten, respectively [37]. On these landing missions, two SEP cargo flights are again used along with additional CP cargo flights to preposition landers in Mars orbit and a surface habitat module for the long-stay surface mission.

Overall, these mission architectures are quite complex involving critical R&D maneuvers, vehicle reconfiguring, and, in the case of aggregating key mission elements in LDRO, adding significant time to the overall mission. Also, because of the long outbound transit times for the SEP cargo flights (~3.5 years), crewed flights to Mars are limited to every other opportunity.

A “scaled-down” crewed MTV, comparable in size to the *Search Lite* ASVN, is possible using the same general assumptions being used in the current EMC studies – namely a reduced crew size of 4, and prepositioned Earth return propellant – the latter delivered by a SEP cargo vehicle. A nuclear-powered Mars Survey Vehicle (MSVN) analogue of *Search Lite* is shown below in Fig. 21. Individual vehicle components, again limited to 70 t, are delivered to a 407 km LEO where assembly is accomplished via two simple R&D maneuvers. After assembly and crew boarding, the MSVN begins its 2033 orbital mission to Mars with a “2-perigee burn” trans-Mars injection (TMI) maneuver ($C_3 \sim 9.87 \text{ km}^2/\text{s}^2$, $\Delta V_{\text{TMI}} \sim 3.760 \text{ km/s}$ including g-losses) then captures into a 1-sol EMO (arrival $V_{\text{inf}} \sim 3.470 \text{ km/s}$, $\Delta V_{\text{MOC}} \sim 1.335 \text{ km/s}$) 180 days later.

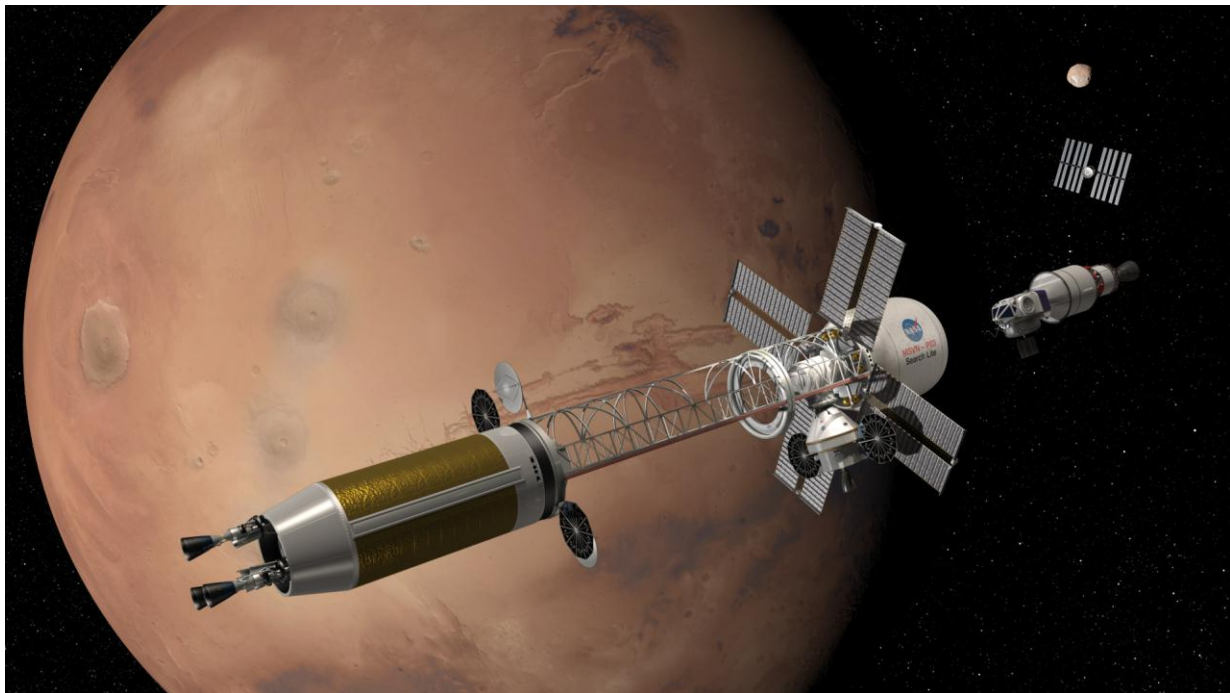

Figure 21. “Search Lite” MSVN Carries 4 Crew and Uses SEP-delivered LH₂ Propellant for Earth Return

The crewed MSVN then rendezvous with the prepositioned MMSEV and transfer stage (shown in Fig.21) and carries out multiple crewed sorties to Phobos and Deimos over the next ~1.5 years. During the last month in the Mars system, the crew oversees the transfer of ~23.3 t of LH₂ propellant from the SEP cargo vehicle to *Search Lite*’s NTPS in preparation for the return to Earth. After refueling has been completed, *Search Lite* performs the TEI burn ($C_3 \sim 9.170 \text{ km}^2/\text{s}^2$, $\Delta V_{\text{TEI}} \sim 1.089 \text{ km/s}$) and begins the 180-day trip back to Earth. It then captures into a 24-hr EEO (arrival $V_{\text{inf}} \sim 3.277 \text{ km/s}$, $\Delta V_{\text{EOC}} \sim 934 \text{ m/s}$) followed by Orion separation, re-entry and landing of the crew. An auxiliary tanker vehicle, operating from a LEO servicing node/propellant depot, will subsequently supply additional LH₂ propellant to the MSVN for its final orbit lowering and rendezvous with a LEO transportation node where it can be refurbished and resupplied before its next mission.

The crewed MSVN has an IMLEO of ~174.8 t that includes the common NTPS (~69.8 t), the saddle truss and drop tank assembly (~57.5 t) and the PL section (~47.5 t). The overall vehicle length is ~78.3 m including the Orion MPCV. The LH₂ drop tank also has the same length and propellant capacity as the NTPS at ~15.7 m and ~39.7 t.

The reusable crewed MSVN requires 5 primary burns (4 restarts) that use ~93.0 t of LH₂ propellant. With ~50 klb_F of total thrust and a I_{sp} of ~900 s, the total engine burn time is ~61.5 minutes. The first of the two TMI perigee burns is the longest single burn at ~24.2 minutes after which the vehicle’s drop tank is drained and jettisoned. The duration of the remaining burns are as follows: ~13.6 minutes (second TMI perigee burn), ~9.2 minutes (MOC), ~8.3 minutes (TEI) and ~6.2 minutes (EOC). For this round trip crewed Mars mission, the U-235 burn-up is ~18.8 grams which is ~0.032% of the total quantity found in each engine.

With reduced crew size and repositioned return propellant at Mars, smaller, reusable MTVs using SNRE⁺-class engines are possible allowing simpler mission architectures with shorter crew transit times to and from Mars thus reducing their exposure to the debilitating effects of 0-g_E and the energetic particle radiation permeating space. As discussed above, the SNRE⁺ can also be used for variety of future human exploration missions and the performance requirements on the GC fuel and the engine system appear quite reasonable. The engine operational parameters for the missions discussed above are summarized in Table 2 and assume a peak fuel temperature of 2860 K and a HEU fuel loading of ~0.6 grams per cm³. Other key reactor and engine design / performance characteristics are summarized in Table 1.

Table 2. Small Engine Operational Parameters for FTD, Cargo Delivery and Crewed Exploration Missions

Requirements Missions	Engine Thrust (klb _F)	T/W _{eng}	T _{ex} (°K)	I _{sp} (s)	No. Engines	U-235 Mass (kg)	No. Burns	Longest Single Burn (min)	Total Burn Time (min)	U-235 Burnup (%)
Lunar Flyby FTD Mission	~7.5	~1.9	2739	894	1	27.5	1	~13.0	-	~0.0062
Lunar Flyby FTD Mission	~16.7	~3.1	2733	900	1	59.6	1	~6.7	-	~0.0035
Lunar Cargo Delivery	~16.7	~3.1	2733	900	3	59.6	5	~21.4	~49.2	~0.025
Lunar Landing Crewed	~16.7	~3.1	2733	900	3	59.6	5	~21.0	~55.0	~0.028
NEA 2000 SG344 Crewed	~16.7	~3.1	2733	900	3	59.6	5	~27.4	~50.4	~0.026
EMC Crewed	~16.7	~3.1	2733	900	3	59.6	5	~24.2	~61.5	~0.032

VIII. Notional Schedule to Flight Details

Assumptions Made in Schedule Formulation

In FY’14, a preliminary development schedule / DDT&E plan was produced by GRC, DOE and industry for the AES program. It assumed a 10-year duration during which time a ground tested and qualified engine would be readied for flight demonstration around the ~2025 timeframe. By necessity, the project would be a success-oriented, high-risk activity requiring an immediate start and dedicated financial commitment by NASA. It also assumed the following: (1) a streamlined management and acquisition strategy; (2) use of GC fuel; (3) an immediate scale up in FE production levels before verification of all fuel processing activities are completed; (4) utilization of existing facilities (e.g., DAF) and borehole or tunnel testing at the NNSS; (5) starting NEPA (National Environmental Policy Act) and launch safety analyses; (6) identifying fuel and reactor transportation requirements; and (7) initiating facility modifications at the Cape required for assembly, test, and launch operations (ATLO).

The schedule also assumed co-location of a portable hot cell unit (like the mobile SHARS unit) near the site where testing is to occur. The unit would be a “turnkey” procurement and used to disassemble the reactor after testing to extract a sampling of FEs and reactor components for shipment to INL for PIE as discussed in Sect IV. Afterwards, the unit would package smaller groupings of fuel and reactor components for shipment in existing casks to a DOE facility for processing and disposal thus avoiding the added expense and time to develop a new “Cat 1” container.

Lastly, it was assumed that the GTD project would build and test two units; the first being an engineering reactor/engine test article with ~90% design fidelity in 2023 and the second unit being a qualification engine with ~100% design fidelity in 2024. The final flight unit – identical to the qualification unit – would be launched in 2025.

Parallel Activities and Other Important Considerations in Schedule Development

A number of activities need to occur before a SNTPS can be launched. These include: (1) Fuel and reactor materials development and qualification; (2) Reactor and engine design; (3) GTF design, construction and checkout; (4) Ground test article development, fabrication and demonstrations; (5) Flight system design and fabrication; (6) Transportation (for both the ground test articles and flight unit); (7) Engine, stage and launch vehicle integration and checkout at the Cape; and then (8) Launch.

Reactor design can be performed in parallel with fuel development and qualification so that reactors can be fabricated as soon as acceptable reactor fuel is available and the necessary facilities and test infrastructure are in place and available. Three primary activities must therefore begin in the initial phase of a flight development program: (1) fuel development and qualification; (2) integrated reactor, engine and stage design; and (3) GTF selection, design, and construction. Fuel development and qualification will include fuel performance validation and documentation of the fuel fabrication process parameters and specifications, required source materials and equipment necessary to insure reproducibility. With this information private sector vendors can be engaged to scale up fuel fabrication from lab-scale single element extrusions to an established fuel fabrication line capable of the producing the large numbers of HEU fuel elements needed for the ground test articles and the flight engine.

The availability of required facilities is another important consideration. In addition to the GTF and fuel fabrication facility, a number of other nuclear and nuclear-related test facilities will be required to successfully execute this program. Facilities for conducting cold and hot critical experiments and establishing component tolerance limits to neutron and gamma radiation will need to be identified at existing DOE facilities or new analogues will have to be built. Other likely facilities include reactor component and control system test facilities, as well as, simulator facilities to help train and prepare the operators who will be conducting the actual engine ground testing.

Schedule Task Activities and Timing

Key task activities associated with the ground and flight technology demonstration schedule are shown in Fig. 22. The schedule assumes GC fuel is selected as the lead fuel option consistent with the IRP's recommendation and the AES program's endorsement of this fuel option this past February. As discussed above, there are three activities that start immediately. The first is GC fuel and coating development and qualification. It uses separate effects testing involving NTREES and irradiation testing conducted in either the High Flux Isotope Reactor (HFIR) at ORNL or the ATR at INL. Once qualified, fuel element fabrication begins using HEU at either ORNL's Y-12 Facility or an industry contractor. Second is engine design and development. This work will be performed by a government/industry contractor team who will provide the necessary design details needed for the mission concept, system requirements, preliminary and critical design reviews that occur over the next 4 years. Third is GTF concept evaluation and selection between the borehole and tunnel options (at either P-tunnel or the U1a complex).

New facility development, whether for a GTF or fuel fabrication facility, is typically a long lead item within DOE involving a 5-year design, construction and checkout period. DOE will need to submit a budget request by Critical Decision-0 (CD-0) before starting conceptual design, preparing NEPA documentation, and seeking permit approval from the state with regulatory authority. This information provides the basis for continuing with facility preliminary design (CD-1). Approval for final design and construction start occurs during CD-2 and CD-3, respectively. Operator training, facility qualification and Operational Readiness Review (ORR) occur during CD-4. Prior to preliminary design of the GTF, non-nuclear subscale validation testing of the selected concept may be required. Validation testing of the SAFE concept is shown as an example in Fig. 22.

Design and development activities on the stage start after engine design and development is underway. The DDT&E effort on the non-nuclear engine and stage components is not expected to be a pacing element in the development schedule since many of these components and subsystems already exist and have flown in space as discussed Section VI. The main technical issue is material and component tolerance to a radiation environment for short periods and whether selective use of particular types of materials may be required. Candidate fabrication materials for NTP TPAs, nozzles, controls, valves and instrumentation were identified and documented by Aerojet and demonstrated during extensive testing on the NERVA program's NRX-XE experimental engine in 1969 [4].

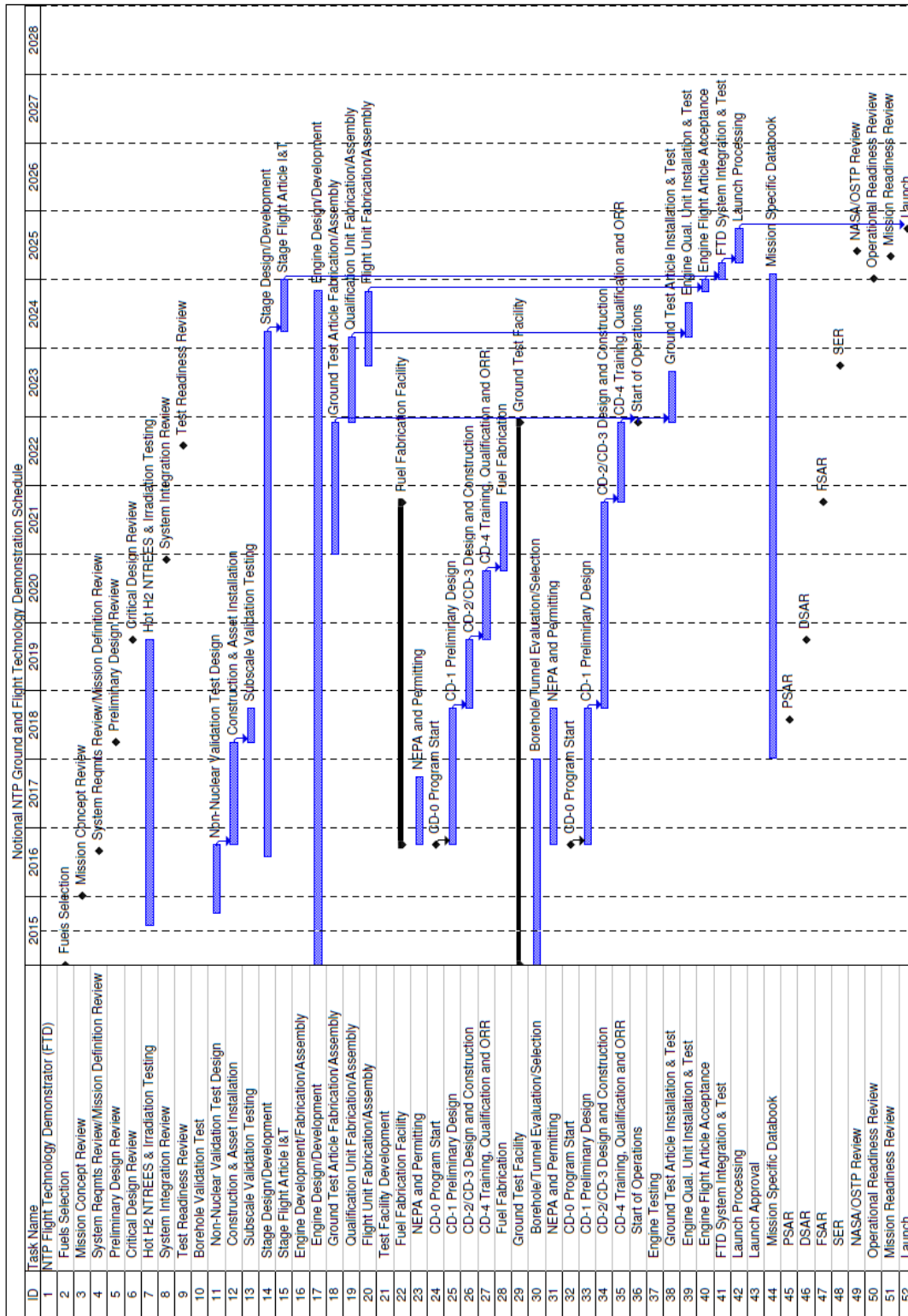

Figure 22. Key Task Activities Involved in NTP Ground and Flight Test Demonstrations

In parallel with GTF qualification, ORR and start of operations, components for the first engineering ground test article will be fabricated and sent to DAF for assembly, then installed and tested at the GTF in 2023. The installation, test and post-test evaluation process is expected to take ~6-9 months. Similar fabrication and assembly of the second test article, the qualification unit, will occur in 2023 followed by its installation and testing in 2024.

After the ground test campaign is finished, program focus will shift to the FTD mission and activities at the Cape. Fabrication and assembly of the reactor subsystem for the flight unit would be done at the industry contactor. The unit will then be shipped to the Cape for acceptance testing and integration with its non-nuclear engine components, the flight stage and launch vehicle.

The launch approval process will require preparation of a FSAR (Final Safety Analysis Report) and a SER (Safety Evaluation Report) by DOE and INSRP (Interagency Nuclear Safety Review Panel), respectively, along with Operational and Mission Readiness Reviews by NASA before approval to proceed with the mission is provided by the White House Office of Science and Technology Policy (OSTP) leading to a launch in late 2025.

After the GTD tests and FTD mission, other single engine NTP robotic science missions are possible [39]. This would be followed by a clustered engine demonstration of the NTPS (e.g., on a lunar cargo delivery flight) before being used on the crewed exploration missions discussed above.

IX. Summary and Concluding Remarks

Today, NASA is providing modest funding for a small but focused technology development effort that it hopes will lead to the successful ground testing and eventual flight of a small NTR engine within a 10-year period. Following the IRP recommendation and AES program endorsement of graphite composite fuel as the “lead fuel” option, the NTP project is now focused on fabricating and testing GC fuel elements. An ~16 inch partial length FE with 4-holes and ZrC coating has been fabricated by ORNL and will undergo non-nuclear “thermal cycling” tests in NTREES in FY’15 – a major project milestone. NTREES testing of a coated 19-hole element containing depleted uranium will be conducted next, followed by irradiation testing in a DOE reactor in the FY’16-17 timeframe.

In addition to recapturing and demonstrating GC fuel fabrication and coating processes using current day equipment and source materials, NASA and DOE are also using SOTA computational tools to develop conceptual designs for several small engines – one a criticality limited 7.5 klb_f engine and the other an updated version of the SNRE producing just under 16.7 klb_f of thrust. Both engines are candidates for ground testing and flight demonstration, but *the SNRE⁺ option is recommended for development for the following reasons: (1) it has design heritage and a previously developed program plan that can provide a point of comparison to the current effort; (2) its FE – TT arrangement and TT configuration are the same as that used in larger engine designs; (3) it uses the same 35 inch long FEs and is only slightly longer than the 7.5 klb_f engine despite its higher thrust output; and (4) it can be used for the single engine FTD mission, and with three clustered engines can support reusable lunar cargo delivery, crewed landing, and NEA survey missions. Even human missions to Mars are possible with the smaller crew size and prepositioning of assets currently being envisioned in NASA’s EMC. This can lead to an affordable “one size fits all” approach to NTR development using the SNRE-class graphite composite engine.*

Regarding ground testing, NASA and DOE personnel have twice traveled to the NNSS in the past year and a half, visiting the DAF and touring candidate ground test locations including a vertical borehole, and horizontal tunnels at the underground U1a and P-tunnel complexes. The pros and cons of testing at each of these locations have been discussed and a Concept of Operations for ground testing has been outlined.

The preliminary DDT&E plan and schedule for affordably ground and flight-testing a small NTR engine and stage, developed by GRC, DOE and industry, has been presented. The assumptions and important considerations used in developing the schedule and the key task activities included in it have also been discussed.

The keys to affordability include using: (1) proven “graphite composite” fuel with its well-documented fabrication processes and large database; (2) “separate effects” testing (e.g., NTREES and irradiation) to qualify the fuel and coatings; (3) SOTA “benchmarked” numerical models to design, build and operate the engine computationally; (4) the SNRE⁺ design with its “common” FE – TT arrangement that is scalable to larger thrust levels when and if required; (5) existing DOE facilities and infrastructure at the NNSS (e.g., DAF, boreholes or tunnels); and (6) flight-proven, non-nuclear engine and stage hardware to the maximum extent possible for the FTD mission.

Although not discussed in this paper, a rough order of magnitude (ROM) cost estimate was made for the GTD tests and FTD mission. It is premature, however, to discuss cost at this time since the AES program has just requested a more in-depth requirements assessment and cost estimate be made by the NTP project over the next two years. The information presented here will provide a good starting point for that assessment.

Acknowledgments

The authors wish to thank Chris Moore and John Warren (AES Division), Anthony Belvin (DOE/NE-75) and Mark Klem (GRC) for their continued encouragement and strong support of this work. The author (SKB) also expresses his thanks to Mike Trammel and Brian Jolly (ORNL) for the fuel element fabrication and coating equipment pictures shown in Figs. 9 and 10, Bob Cataldo (GRC) for the ConOps illustration in Fig. 11, and Bob Sauls (bob.sauls@xp4d.com) for the digital images depicted in Figs. 15 – 21 of this paper.

References

- [1] Nuclear Cryogenic Propulsion Stage Project Fuel Evaluation and Recommendation Report to the Independent Review Panel, prepared by the Nuclear Cryogenic Propulsion Stage Fuel Evaluation Committee, January 2015.
- [2] Emrich, William J., Moran, R. P., and Pearson, J. B., “Nuclear Thermal Rocket Element Environmental Simulator (NTREES) Upgrade Activities”, AIAA- 2012-4307, July 2012.
- [3] Howe, Steven D., et al., “Ground Testing a Nuclear Thermal Rocket: Design of a Sub-scale Demonstration Experiment”, AIAA-2012-3743, July 2012.
- [4] Koeing, D. R., “Experience Gained from the Space Nuclear Rocket Programs (Rover/NERVA)”, Los Alamos National Laboratory, Report LA-10062-H, Los Alamos, NM, May 1986.
- [5] Taub, J. M., “A Review of Fuel Element Development for Nuclear Rocket Engines”, Los Alamos National Laboratory, Report LA-5931, Los Alamos, NM, June 1975.
- [6] Durham, F. P., “Nuclear Engine Definition Study Preliminary Report, Volume I - Engine Description”, Los Alamos National Laboratory, Report LA-5044-MS Vol. I, Los Alamos, NM, September 1972.
- [7] Human Exploration of Mars Design Reference Architecture 5.0, Drake, Bret G., ed., National Aeronautics and Space Administration, NASA-SP-2009-566, Washington, DC, July 2009.
- [8] Borowski, S. K., McCurdy, D. R., and Packard, T. W., “7-Launch NTR Space Transportation System for NASA’s Mars Design Reference Architecture (DRA) 5.0”, AIAA-2009-5308, August 2009.
- [9] 710 High-Temperature Gas Reactor Program Summary Report, General Electric, Report GEMP-600, Volume 1, Cincinnati, OH, 1968.
- [10] Nuclear Rocket Program Terminal Report, Argonne National Laboratory, Report ANL-7236, Argonne, IL, 1968.
- [11] Schnitzler, Bruce G., and Borowski, Stanley K., “Neutronics Models and Analysis of Small Nuclear Rocket Engine (SNRE)”, AIAA-2007-5618, July 2007.
- [12] Stewart, Mark E., and Schnitzler, Bruce G., “Thermal Hydraulics and Structural Analysis of the Small Nuclear Rocket Engine (SNRE) Core”, AIAA-2007-5619, July 2007.
- [13] Fittje, James E., “Upgrades to the NESS (Nuclear Engine System Simulation) Code”, AIAA-2007-5620, July 2007.
- [14] Schnitzler, B. G., Borowski, S. K., and Fittje, J. E., “25,000-lbf Thrust Engine Options Based on the Small Nuclear Rocket Engine Design”, AIAA-2009-5239, August 2009.
- [15] Schnitzler, B. G., Borowski, S. K., and Fittje, J. E., “Lower Thrust Engine Options Based on the Small Nuclear Rocket Engine Design”, AIAA-2011-5846, August 2011.
- [16] Schnitzler, B. G., “Recommended Point-of-Departure Designs of Small Reactors Suitable for Direct Nuclear Thermal Propulsion”, Oak Ridge National Laboratory, Oak Ridge, TN, October 2014.
- [17] Durham, F. P., “Nuclear Engine Definition Study Preliminary Report, Volume III - Preliminary Program Plan”, Los Alamos National Laboratory, Report LA-5044-MS Vol. III, Los Alamos, NM, September 1972.
- [18] Borowski, S. K., McCurdy, D. R., and Burke, L. M., “The Nuclear Thermal Propulsion Stage (NTPS): A Key Space Asset for Human Exploration and Commercial Missions to the Moon”, AIAA-2013-5465, September 2013.
- [19] Borowski, S. K., McCurdy, D. R., and Packard, T. W., “Modular Growth NTR Space Transportation System for Future NASA Human Lunar, NEA and Mars Exploration Missions”, AIAA-2012-5144, September 2012.
- [20] Lyon, L. L., “Performance of (U,Zr)C-Graphite (Composite) and of (U,Zr)C (Carbide) Fuel Elements in the Nuclear Furnace 1 Test Reactor”, Los Alamos National Laboratory. Report LA-5398-MS, Los Alamos, NM, September 1973.
- [21] Davidson, K. V., Martin, W. M., Shell, D. H., Taub, J. M., and Taylor, J. W., “Development of Carbide-Carbon Composite Fuel Elements for Rover Reactors”, LA-5005, Los Alamos National Laboratory, October 1972.
- [22] Trammel, M. P., Jolly, B. C., and Qualls, A. L., “Extrusion Development of Graphite-Based Composite Fuel for Nuclear Thermal Propulsion”, AIAA-2015-3776, July 2015.

- [23] Caputo, A. J., “NERVA Fuel Element Development Program Summary Report: July 1966 – June 1972, Characterization of Vapor Deposited Niobium and Zirconium Carbides,” Y-12 Plant report Y-1852 Part 3, Oak Ridge National Laboratory, Oak Ridge, TN (1973).
- [24] Caputo, A. J., “NERVA Fuel Element Development Program Summary Report: July 1966 – June 1972, Vapor Deposition of Metal Carbides,” Y-12 Plant report Y-1852 Part 4, Oak Ridge National Laboratory, Oak Ridge, TN (1973).
- [25] Jolly, B. C., Trammell, M. P., and Qualls, A. L., “Coating Development on Graphite-Based Composite Fuel for Nuclear Thermal Propulsion”, AIAA-2015-3777, July 2015.
- [26] Raj, S. V., and Nesbitt, J. A., “Development of Advanced Coatings for NERVA-type Fuel Elements”, NETS2015-5072, Nuclear and Emerging Technologies for Space (NETS) 2015, Albuquerque, NM, February 2015.
- [27] Coote, D., “Review of Nuclear Thermal Propulsion Ground Test Options”, NETS2015-5146, Nuclear and Emerging Technologies for Space (NETS) 2015, Albuquerque, NM, February 2015.
- [28] Howe, S. D., Travis, B., and Zerkle, D.K., “SAFE Testing of Nuclear Rockets”, Journal of Propulsion and Power, Vol. 17, No. 3, pg. 534-539 (2001).
- [29] Marshall, W. M., “Subscale Validation of the Subsurface Active Filtration of Exhaust (SAFE) Approach to NTP Ground Testing”, AIAA-2015-3775, July 2015.
- [30] “SHARS - A Shared Solution for Risky Radioactive Sources”, IAEA Bulletin 49/1, September 2007.
- [31] Joyner, C. R., Levack, D., and Borowski, S. K., “Affordable Development of a Nuclear Thermal Propulsion Flight Demonstrator Based on a Small Propulsion Engine that is Scalable to Human Missions”, GLEX-2012.4.4x12224, Global Space Exploration Conference, Washington, DC, May 2012.
- [32] Fittje, J. E., Borowski, S. K., and Schnitzler, B. G., “Parametric Analysis of a 75 kN Thrust Class Composite Fuel Based NTR Engine”, AIAA-2014-3431, July 2014.
- [33] Ferlin, M., “Assessment and Benchmarking of Extendible Nozzle Systems for Liquid Propulsion Engines,” AIAA 2012-4136, August 2012.
- [34] Santiago, J. R., “Evolution of the RL-10 Liquid Rocket Engine for a New Upperstage Application,” AIAA 96-3013, July 1996.
- [35] Borowski, S. K., Sefcik, R. J., Fittje, J. E., McCurdy, D. R., Qualls, A. L., Schnitzler, B. G., et al., “Affordable Development and Demonstration of a Small NTR Engine and Stage: A Preliminary NASA, DOE and Industry Assessment”, AIAA 2015-3774, July 2015.
- [36] Hodge, J., et al., “Space Transfer Vehicle – Lunar Transportation Ground Based LEO Rendezvous and Docking Study”, NAS8-37856, Martin Marietta, August 1991.
- [37] Price, H. W., Baker, J. D., and Naderi, F., “A Minimal Architecture for Human Journeys to Mars”, New Space, Vol. 13, No. 2, pg. 73-81 (2015).
- [38] Merrill, R. G., Strange, N., Qu, M., and Hatten, N., “Mars Conjunction Crewed Missions with a Reusable Hybrid Architecture”, IEEE Aerospace Conference, 2015-8.0104, March 2015.
- [39] Joyner, C. R., Kokan, T. S., and Levack, D. J. H., “Solar System Missions with a Small Nuclear Thermal Propulsion Stage”, NETS2013-6717, Nuclear and Emerging Technologies for Space (NETS) 2013, Albuquerque, NM, February 2013.