

NASA/CR—2015-218899



Development of Advanced Low Emission Injectors and High-Bandwidth Fuel Flow Modulation Valves

Adel Mansour
Parker Hannifin Corporation, Mentor, Ohio

November 2015

NASA STI Program . . . in Profile

Since its founding, NASA has been dedicated to the advancement of aeronautics and space science. The NASA Scientific and Technical Information (STI) Program plays a key part in helping NASA maintain this important role.

The NASA STI Program operates under the auspices of the Agency Chief Information Officer. It collects, organizes, provides for archiving, and disseminates NASA's STI. The NASA STI Program provides access to the NASA Technical Report Server—Registered (NTRS Reg) and NASA Technical Report Server—Public (NTRS) thus providing one of the largest collections of aeronautical and space science STI in the world. Results are published in both non-NASA channels and by NASA in the NASA STI Report Series, which includes the following report types:

- **TECHNICAL PUBLICATION.** Reports of completed research or a major significant phase of research that present the results of NASA programs and include extensive data or theoretical analysis. Includes compilations of significant scientific and technical data and information deemed to be of continuing reference value. NASA counter-part of peer-reviewed formal professional papers, but has less stringent limitations on manuscript length and extent of graphic presentations.
- **TECHNICAL MEMORANDUM.** Scientific and technical findings that are preliminary or of specialized interest, e.g., “quick-release” reports, working papers, and bibliographies that contain minimal annotation. Does not contain extensive analysis.
- **CONTRACTOR REPORT.** Scientific and technical findings by NASA-sponsored contractors and grantees.
- **CONFERENCE PUBLICATION.** Collected papers from scientific and technical conferences, symposia, seminars, or other meetings sponsored or co-sponsored by NASA.
- **SPECIAL PUBLICATION.** Scientific, technical, or historical information from NASA programs, projects, and missions, often concerned with subjects having substantial public interest.
- **TECHNICAL TRANSLATION.** English-language translations of foreign scientific and technical material pertinent to NASA's mission.

For more information about the NASA STI program, see the following:

- Access the NASA STI program home page at <http://www.sti.nasa.gov>
- E-mail your question to help@sti.nasa.gov
- Fax your question to the NASA STI Information Desk at 757-864-6500
- Telephone the NASA STI Information Desk at 757-864-9658
- Write to:
NASA STI Program
Mail Stop 148
NASA Langley Research Center
Hampton, VA 23681-2199

NASA/CR—2015-218899

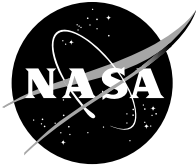

Development of Advanced Low Emission Injectors and High-Bandwidth Fuel Flow Modulation Valves

Adel Mansour
Parker Hannifin Corporation, Mentor, Ohio

Prepared under Contract NNC11CA09C

National Aeronautics and
Space Administration

Glenn Research Center
Cleveland, Ohio 44135

November 2015

Acknowledgments

The work reported herein was supported by grant number NNC11CA09C from NASA under NASA's Environmentally Responsible Aviation (ERA) Project. The project team would like to thank Dr. Clarence T. Chang, the NASA Technical Point of Contact, and Dr. Chi-Ming Lee, Chief of the NASA Glenn Combustion Branch, for their guidance and support throughout the project. We also want to thank Mr. Derek P. Podboy and the NASA combustion team for their support during testing.

Level of Review: This material has been technically reviewed by NASA technical management.

Available from

NASA STI Program
Mail Stop 148
NASA Langley Research Center
Hampton, VA 23681-2199

National Technical Information Service
5285 Port Royal Road
Springfield, VA 22161
703-605-6000

This report is available in electronic form at <http://www.sti.nasa.gov/> and <http://ntrs.nasa.gov/>

Development of Advanced Low Emission Injectors and High-Bandwidth Fuel Flow Modulation Valves

Adel Mansour
Parker Hannifin Corporation
Mentor, Ohio 44060

Executive Summary

In November of 2011, Parker entered into a contract with NASA to conduct research in support of the Environmentally Responsible Aviation Project (ERA). During the project, Parker built and tested multipoint Lean Direct Injection (LDI) fuel injectors designed to meet NASA's N+2 objective to reduce NO_x emissions of aviation gas turbine engines by 75% from the ICAO standard adopted at CAEP/6. The injectors are based on Parker's three-zone injector (3ZI) concept which has its origin in multi-point LDI injectors developed by Parker under NASA's Ultra Efficient Engine Technology (UEET) program that delivered record-low emissions in flame tube tests and sector tests. The current injectors improve on the technology in terms of thermal performance, aerodynamic design flexibility, and integration with conventional combustors. They are highly practical, manufacturable, and scalable to various engine sizes. The innovative concept and construction offers a pathway to even higher pressure ratios than the target N+2 design.

The injectors that were built and tested during this project were sized for a 60,000 lbf thrust, 55:1 Overall Pressure-Ratio (OPR) engine. They contain fifteen injection points and incorporate staging to enable operation at low power conditions. Alternative designs were studied in a combustion testing campaign focused on ignition and stability performance; ignition was demonstrated at air pressure drop as low as 0.3% of ambient and fuel-to-air ratio (FAR) as low as 0.011, and Lean Blow Out (LBO) occurred at FAR as low as 0.005. A high pressure combustion testing campaign was conducted in the CE-5 test facility at NASA Glenn Research Center at pressures up to 250 psi and combustor exit temperatures up to 3,200 °F (2,033 K). The tests demonstrated estimated LTO cycle emissions that are about 31% of CAEP/6 for a reference 60,000 lbf thrust, 55-OPR engine. These NO_x emissions are based on extrapolation beyond the tested conditions, thus additional testing at higher temperature and pressure is recommended. An updated injector was built and delivered to NASA and now awaits a new round of testing in the CE-5 test facility. That injector incorporates changes that are expected to lead to further reductions of LTO cycle emissions below 31% of CAEP/6.

During this project Parker also built and tested a high-bandwidth piezoelectric valve to enable electronically controlled fuel trim function as well as high-bandwidth modulation of fuel flow. The fuel trim function enables detailed control of staging and pattern factors in future engines, contributing to efficient fuel burn and extended engine life. Applying high-bandwidth modulation to the primary fuel circuit promises to extend the lean stability limit and control combustion dynamics. The ability to control and modulate fuel flow at 1,000 Hz with over 10% modulation authority was demonstrated in a lab setting.

Parker successfully met injector and combustion hardware deliverables over the two years and four months of the program, and all piezo valve hardware was built and delivered according to the needs of the testing program. In particular, all hardware necessary for the key first round of high-pressure combustion tests in the NASA Glenn Research Center CE-5 test facility was delivered on time under an accelerated schedule.

The Parker 3ZI has proven to be a promising technology, not only because of the demonstrated emissions performance and the maturity of the injector relative to thermal and mechanical design, but also because of the inherent flexibility and scalability of the concept. Clear opportunities still exist to further improve the injector emissions performance at both low and high thrust settings. Emissions performance can be improved through optimization of the atomizer flow numbers and optimizing the atomizer insertion depth in each spray cup, swirl number of the spray cups, sizing of the individual spray cups, and a staging scheme. Thus, Parker is confident that the NASA ERA emissions goal can be exceeded using the 3ZI technology.

Table of Contents

1	Introduction	4
1.1	Objective	5
1.2	Approach.....	6
1.3	Project Plan and Schedule.....	7
1.4	Summary of Accomplishments	8
2	Three-Zone Injector (3ZI) Development	10
2.1	Design Approach	11
2.2	Three-Zone Injector Design and Manufacture.....	15
3	Atmospheric Combustion Rig	17
4	Aerodynamic and Spray Performance of the 3ZI.....	18
4.1	Effective Area Measurements.....	18
4.2	LDV Investigation	19
5	Atmospheric Combustion Tests	22
5.1	Test Setup & Instrumentation	22
5.2	Ignition & LBO test procedure	23
5.3	Single-cup Pilot Ignition/LBO Envelope	25
6	High Pressure Combustion Tests	26
7	Valve Development.....	33
7.1	Valve Design.....	33
7.2	Valve Manufacturing.....	37
7.3	Valve Performance.....	38
8	Conclusions	44
	Acknowledgments.....	45
	References	46

1 Introduction

Parker Hannifin designs and produces fuel injection systems for the world's most advanced propulsion systems and, for more than 20 years, has been at the forefront of developments in emissions-abatement technologies for gas turbine engines. Working with various OEM customers to develop both lean premix (LP) and lean direct injection (LDI) combustion technologies, Parker has developed fuel injectors for the world-leading gas turbine engine platforms. This includes the General Electric GENx engine and the Rolls-Royce Trent 1000 that power the Boeing 787 aircraft, as well as the LEAPx and GE9x engines currently under development.

While we are intimately familiar with the challenges involved with making fuel injectors and combustion systems that can survive the rigor of a practical implementation, we are also heavily involved in developing innovative injector concepts and manufacturing technologies that push the envelope on what is achievable in injector technologies. To this end, we have worked with government labs and facilities to develop and demonstrate advanced fuel injectors and combustor technologies under programs such as NASA AST and UEET [1,2], DOE Future Gen and the DOD Active Combustion Control Systems program. In these programs we tested new technologies, such as Macrolamination technology, that ultimately found their way into new engine programs. Macrolamination is a manufacturing technique that allows complex internal flow channels to be formed by fabricating the fuel injectors in layers. These layers are subsequently bonded to form a monolithic structure with material properties approaching the parent metal properties. Using this technology (US Patents 5,435,884, 6,672,066, 6,711,898, 7,083,122, 7,021,562 and others), multi-point fuel injection can be achieved without the associated hardware complexities and weight penalties of conventional designs. Macrolamination enabled the TAPS injector of the GENx engine and has found its way into other injectors as well as numerous other products. Macrolamination technology was also used in Parker's work under NASA Ultra Efficient Engine Technology (UEET), where breakthrough reductions in NO_x levels were demonstrated using multi-point lean-direct injection concepts. In the UEET Program we achieved NO_x emissions 83% below the 1996 ICAO standard [1, 2], which is equivalent to 75% NO_x reduction from CAEP/6, or equal to the NASA N+2 goal.

The effort reported herein was conducted under contract with NASA, following the acceptance of a proposal submitted by Parker Hannifin in response to NASA's solicitation for the "Environmentally Responsible Aviation Project (ERA)" – solicitation number NNC10ZRT025N. In this ERA project we built on our success in the UEET and subsequent projects, developing and testing a new generation of

multi-cup LDI injectors designed to achieve both the ultra-low emissions of the best UEET injector and the practicality of a production-worthy injector concept. The new injectors are based on an innovative concept, called the three-zone-injector (3ZI) which will be introduced in subsequent sections. The injector development was complemented by the development of a high-speed piezoelectric valve that can be used for both the fuel trim function and high-speed modulation of the fuel flow to the fuel injector, thereby offering an opportunity to control combustion dynamics.

This final report is organized as follows. First, the following introductory subsections provide a brief description of the objective and approach to the ERA project, along with the project plan and a summary of technical accomplishments. Section 2 discusses the development of the three-zone-injector (3ZI) concept, including a detailed overview of the spray cup design and the manufacturing and testing of four 3ZI variants that were produced during the project. Section 3 provides a brief description of the rig designed and built for atmospheric testing. Section 4 reports on the characterization of the aerodynamic performance of the 3ZI variants, including effective area measurements and results from laser Doppler velocimetry (LDV) mapping. Section 5 presents results from atmospheric ignition and lean blow out (LBO) testing conducted of three 3ZI variants at the University of Cincinnati. Section 6 reports on the high pressure flame tube combustion experiments conducted at the NASA CE-5 facility. Section 7 summarizes the piezo valve development effort. Finally, conclusions based on the completed work are discussed in Section 8.

1.1 Objective

The overall objective of this research was to develop the next generation of fuel injector technologies that achieve reduced emissions of harmful pollutants and are applicable to future generations of high pressure ratio jet engines. The research had three specific objectives:

- Develop and test novel multipoint lean direct injection schemes for control of mixture homogeneity to achieve the N+2 NO_x performance goals of the NASA Environmentally Responsible Aviation Project.
- Develop a piezo-electric valve that modulates fuel flow in real time with both proportional and high-speed modulation capabilities. This valve will add significant flexibility to the control of injector fuel flow and combustor performance.
- Integrate the high bandwidth, fast response piezoelectric valve with the pilot circuit of one of our selected injector concepts and demonstrate its capability in controlling combustion dynamics.

The first two objectives were both successfully met within the program time frame and only the tests required to complete the demonstration for the third objective remain. These tests were delayed past the end of the research contract, primarily due to scheduling priorities at the NASA tests facilities where the tests were to be conducted.

1.2 Approach

The multipoint lean direct injection scheme developed during this project is based on Parker's three-zone injector (3ZI) concept. The 3ZI concept has its origin in multi-point LDI injectors developed by Parker under NASA's UEET program. It utilizes the same multipoint spray-cup concept but improves upon the technology by insulating the fuel circuits from the air circuits for greatly improved thermal performance. Furthermore, new spray cup designs were implemented that offer improved aerodynamics and greater design flexibility. Finally, the injector can be inserted into an engine in a conventional manner through an opening in the combustor casing, which is critical for practical injectors, even for highly advanced engines.

Figure 1 illustrates the 3ZI concept. Figure 1(a) shows a single injector, while Figure 1(b) illustrates three injectors installed in a combustor sector. Each injector has three main burning zones, with one forward primary combustion zone and two secondary zones on either side of the primary zone. The forward zone can be used for low load operation while the secondary zones are operated during high load. Each burning zone has a number of spray cups (seven cups per zone in Figure 1), each consisting of an air swirler and a pressure-swirl atomizer located at the base of each cup. Air that flows through each of the swirlers generates a swirling flow field with a small recirculation zone for burning. The small multi-burning zones provide for reduced burning residence time, resulting in low NO_x formation as was demonstrated in the UEET program.

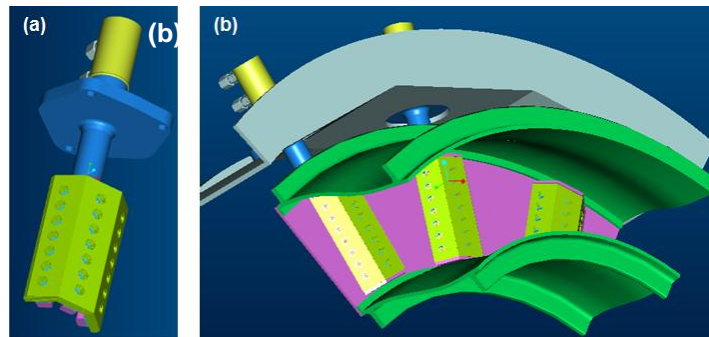

Figure 1: The original 3ZI concept: (a) single injector, and (b) three injectors installed in a combustor sector

The valve concept used in this project for fuel flow modulation and control is based on technology developed by Parker for high-bandwidth electronic flow modulation. The valve technology comprises a pressure-balanced metering spool driven by a proportional piezo actuator that is proprietary to Parker. The actuator is currently in production for industrial valve applications, and can operate at much higher frequencies than conventional electromechanical actuators of comparable force and stroke. Figure 2 shows a model of a representative prototype valve as implemented by Parker Gas Turbine. The valve may be designed with an internal bypass channel that sets the nominal (unactuated) flow area, as well as the capacity to modulate a second flow area when actuated. The ERA valve design had a target operating frequency of 1,000 Hz. To accomplish this, the actuator was redesigned to increase its resonant frequency.

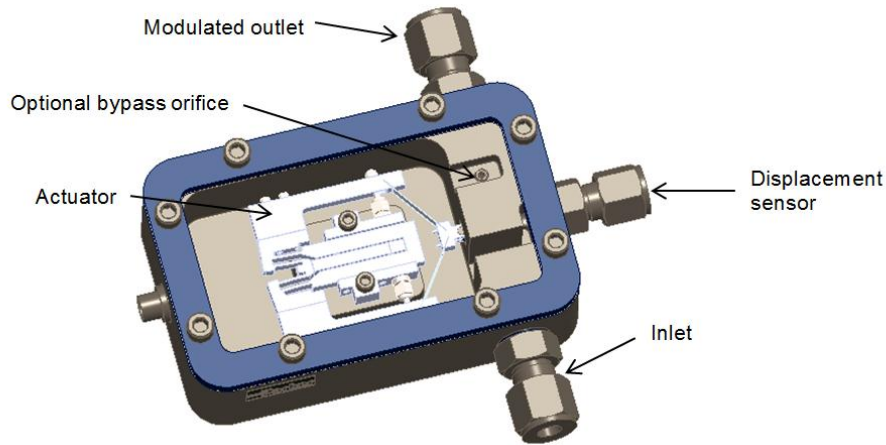

Figure 2: Piezo valve prototype

1.3 Project Plan and Schedule

This development project was executed over a period of two years and four months. The project plan was designed to advance the Technology Readiness Level (TRL) of the injector and valve to TRL 4 through high pressure combustion tests. The first year of the program, which began in November 2011, focused on the development of two injector concepts as well as the fuel modulation valve. It included spray performance characterization and atmospheric ignition and lean blowout combustion tests. The second year saw a down-selection to one injector concept that was tested in NASA Glenn Research Center's CE-5 combustion facility at pressures up to 250 psi as well as fabrication of piezo valves capable of handling the desired fuel trim function and flow modulation at up to 1,000 Hz. The plan was to initiate additional combustion tests at NASA using modulated fuel spray in the pilot cup. NASA will conduct these tests in 2014.

The main tasks for Year I were to: (a) develop and manufacture two variants of Parker's Macrolaminate multi-point fuel injectors that seek to improve the static stability of the injectors while operating on Jet-A, (b) develop a piezo valve that modulates fuel flow in real time with both proportional and high-speed modulation capabilities, and (c) conduct a detailed experimental program at our university partner facility to map the stability boundaries of the injectors and perform phenomenological studies of ignition and lean blowout in an atmospheric combustion facility.

The key objectives for the Year II effort were to demonstrate: (i) low-NO_x performance of the 3ZI at engine-like combustion pressures (up to 250 psi), and (ii) viability of the piezo valve to affect 3ZI dynamics. The Year-II plan was executed under an accelerated delivery schedule for both the injector and the piezo valve, relative to the original plan, in order to ensure their availability during open CE-5 test windows. The accelerated schedule was met for all combustion hardware. However, the modulated combustion tests planned for CE-5 were delayed into calendar year 2014 due to scheduling priorities at NASA Glenn Research center, government furloughs, cold weather, and facility maintenance.

1.4 Summary of Accomplishments

Overall, the program was executed on schedule and all fuel injectors and combustion-rig hardware was delivered to NASA on schedule. The first round of combustion tests in the CE-5 combustion rig were then completed in the first quarter of CY2013 with the 3ZI demonstrating excellent performance both in terms of emissions and durability. Atmospheric, non-modulated combustion tests for an identical injector were then completed in the third quarter of CY2013.

In the second quarter of CY2013, Parker built and delivered a fourth variant of the 3ZI that incorporates design changes intended to further improve emissions performance. This new injector is currently at NASA GRC and awaits installation into the CE-5 Rig for use in modulated combustion tests that are currently expected to be conducted in late spring of CY2014 after the close of the current contract. All valve hardware fabrication was completed in time for all combustions tests.

The following summarizes the main accomplishments of this program:

- Parker designed and fabricated four 3ZI variants (E01, E02, E03, and E04). Design enhancements were incorporated into each successive design to improve injector performance and advance the TRL, based on experience acquired from the atmospheric testing.

- High maturity level was demonstrated, with thermal structural analysis of the test hardware indicating an LCF life over 4,000 thermal cycles, which is well beyond the need of rig hardware.
- Atmospheric combustion tests were conducted at the University of Cincinnati, demonstrating ignition and flame stability at fuel injection pressure as low as 2 psig, air pressure drop as low as 0.3% of ambient pressure, and fuel-air ratio (FAR) as low as 0.029 and 0.009 at ambient and preheated conditions, respectively.
- High pressure combustion tests were conducted in the NASA Glenn Research Center's CE-5 test rig and successfully completed on 3/21/13, with the E03 injector operating for over 40 hours at pressures up to 250 psi and combustor exit temperatures up to 3200 °F (2033 K).
- The E03 injector emerged from the combustion tests without damage or signs of thermal distress or flame ingress. The combustion tests demonstrated the durability of the injector, which results from the maturity of the 3ZI with respect to thermal and mechanical design.
- Extrapolation based on the combustion test data set yielded estimated LTO cycle emissions that are about 31% of CAEP/6 for a reference 60,000 lbf thrust, 55-OPR engine. Additional reductions of LTO cycle emissions below 31% of CAEP/6 are anticipated through further optimization of atomizer performance.
- The fourth injector variant was delivered to NASA on 10-June-2013 for combustion testing in the CE-5 combustion rig. The injector incorporates lower flow number atomizers (for finer spray) than the third injector, which is expected to improve both operability and emissions.
- Piezo actuators for the valves were characterized and 1,000 Hz operation was demonstrated ($\pm 0.003''$ displacement). A prototype piezo valve (E01 variant) was then demonstrated to meet the performance requirement of at least 10% modulation authority up to 1,000 Hz.
- Parker completed final assembly and validation testing of two piezo valves. Valve performance was confirmed to meet target specs for modulation authority (at least 10%) and bandwidth (1,000 Hz). Valve performance was found to be consistent with predicted results.
- Parker delivered a piezo valve to NASA for use in combustion tests that NASA plans to conduct after the official end of this research program. The tests will use the fourth variant of the 3ZI.

2 Three-Zone Injector (3ZI) Development

The multipoint injector developed for the NASA ERA program has its origin in multipoint LDI fuel injectors developed as a part of NASA's Ultra Efficient Engine Technology (UEET) program. The UEET program employed the multipoint Macrolaminate injector concept shown in Figure 3a and achieved breakthrough reductions in NO_x emissions, 83% below the 1996 ICAO standard, which is equivalent to a 75% NO_x reduction from CAEP/6 and equal to the NASA N+2 goal [1,2]. Each injection point in the monolithic Macrolaminate injector was formed with a spray cup comprising a pressure swirl atomizer and integrated radial air swirler. Air flowing through the swirler generates a down-stream flow field with a small recirculation zone for burning. The small burning zone provides for reduced burning residence time, contributing to low NO_x formation. The overall injector structure and spray cup design was improved through the ERA program, resulting in the 15-cup injector shown in Figure 3b. The main design objectives for the 3ZI fuel injector were to maximize the effective area of the individual spray cups while still attaining adequate aerodynamics performance and NO_x emissions and to improve the thermal performance of the injector with consideration of the N+2 engine specification and subject to envelope constraints derived from current combustor design.

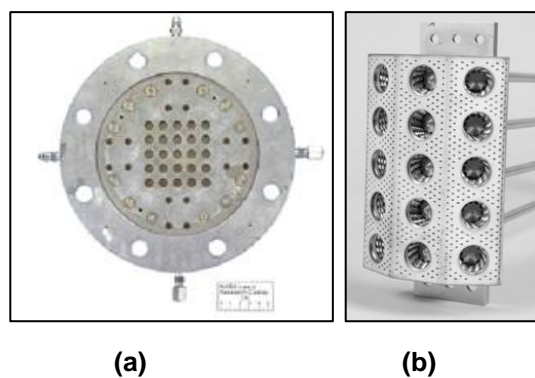

Figure 3: (a) UEET 25-cup I-Dome and (b) ERA 15-cup 3ZI

Four variants of the 3ZI were built and tested during this program, all based on the staged, 15-cup injector design shown in Figure 3b. The first two injectors, designated “E01” and “E02”, were built for atmospheric combustion tests conducted at the University of Cincinnati. Concurrent with these tests the “E03” variant was designed and built for testing at high pressure conditions in the CE-5 test cell at NASA Glenn. Following the first set of high-pressure tests, the “E04” injector was designed for a second CE-5 test campaign. The following sections discuss the development of the 15-cup 3ZI spray cup and injector design and the differences between the four variants as incremental changes were made throughout the program.

2.1 Design Approach

The 3ZI was sized based on engine operating conditions provided by NASA for a target 60,000 lbf thrust N+2 aircraft engine. For this engine, 100% power operating point corresponds to P3 above 800 psia and T3 above 950 K and AFR of 34. From the outset, Parker decided to pursue a design that could lead to a practical injector for this engine size and operating conditions. This demanded that special attention be given to the thermal aspect of the injector design. The cruise condition, with high combustor inlet air temperature and relatively low fuel flow, demands careful attention to the thermal aspects of the fuel injector design in order to ensure acceptable wetted wall temperatures (WWT).

To address the thermal aspect of the design, the fully integrated and monolithic ML structure used for the UEET design has been replaced with a structure composed of two main parts, namely a heat-shielded fuel distribution support and a spray-cup assembly. The spray cup assembly resembles the highly successful UEET design but is given a new shape. It comprises 15 separate spray cups (air swirlers) arranged to form three main combustion zones, namely, one forward primary zone and two secondary zones on either side of the primary zone. Fuel is routed inside the heat-shielded fuel distribution support to multiple fuel atomizing tips that mate with spray cups with minimum thermal contact between the fuel-carrying components and hot external spray-cup components. The back side of the spray cup is open to air flow, allowing flexibility for the spray cup design and placement.

In addition to addressing the thermal aspect of the injector design upfront, certain envelope constraints were assumed, based on practical engine constraints. The 3ZI envelope that was assumed was based on current engine technology while making allowance for the increased air-effective area of the combustor front end as required for lean burn technology. Thus, constraints were placed on the injector front-panel length and the maximum width was limited such that the injector could be inserted through a hole in the engine casing. The number, size, and air-circuit design of the individual spray cups were then optimized to minimize injector length, width and weight subject to constraints imposed by the required effective areas of swirlers, the aerodynamics necessary for stable combustion, and manufacturability considerations.

The 3ZI configuration maintains the flexibility of the multipoint Macrolaminate construction with respect to fuel staging, but is not limited to a coplanar arrangement of spray cups. The 15 spray cups of the 3ZI are arranged in three groups of five spray cups, with each group separated by an angular displacement. As a result the injector can be inserted in a conventional manner through an opening in the combustor casing. This arrangement also allows the burning zones to be isolated from adjacent zones for

more stable staged operation. For example, the forward zone may be used for low load operation, and the secondary zones added for high load operation.

The basic elements of the spray cup as employed in the 3ZI are distinct from the spray cup design used in the UEET program [1,2] in that the 3ZI cup features a detached, centrally-located pressure swirl atomizer, provides axial swirling flow through the base of the cup, and uses a diverging radial swirler. The detached atomizer in the 3ZI spray cup allows for variable placement of the exit orifice with respect to the spray cup air swirling features. The depth of insertion is a parameter of particular interest as it relates to the interaction of fuel and air as well as the practical spray angle for the atomizer that may be employed.

The 3ZI spray cups must pass 80% to 90% of the combustion air into the combustor to achieve the targeted ultra-low emissions. The cup size required to pass this quantity of air depends on the number of cups, the available pressure drop, and the geometry-induced characteristics of the flow in the cup, especially the strength of the swirl induced by the cup. The design can be tailored to achieve a wide range of swirl numbers and discharge coefficients. High discharge coefficients can be achieved with non-swirling axial flow entering through the bottom of the cup combined with low-swirling flow through the radial swirler. A stabilizing flow recirculation can be achieved by introducing strong swirling axial flow entering through the bottom of the cup or by blocking the axial inlet altogether while at the same time employing a higher-turning radial swirler. Thus, an optimal spray cup design balances the need for a stable reaction region and the desire for a high discharge coefficient. To that end, a CFD study was executed to study the effect of the various spray cup design parameters.

2.1.1 CFD analysis of the 3ZI spray cup

The CFD effort focused on modeling the individual spray cup to study the aerodynamics within the spray cup for varying swirler and atomizer geometry. The primary goal was to maximize discharge coefficient while still producing vortex breakdown at the cup exit for flame stabilization. After selecting a spray cup design, the 15-cup injector design was developed based on the envelope constraints described above. A three-cup segment of the design was then modeled to study cup-to-cup interaction at relevant N+2 engine conditions.

The single-cup CFD study was aimed at selecting appropriate axial and radial swirler parameters as well as integration of the atomizer tip into the spray cup. Aerodynamic performance and flow characteristics were evaluated for 14 different configurations. Typically Large Eddy Simulations (LES) were employed to accurately capture the swirling flow within the cups. During the design evolution,

single-cup simulations were conducted, using appropriate boundary conditions to model the effects of neighboring swirlers.

Figure 4 shows sample results for the cup design selected for the 3ZI hardware. The flow solutions shown are from LES studies where the solution has been time averaged for a time period greater than three times the through-flow time for the cup. The simulations were done in Fluent 13.0 assuming incompressible flow at atmospheric conditions under a 4% pressure drop. Figure 4a shows the time-averaged velocity field. The figure shows that the cup design provides a robust, downstream recirculation zone which reaches into the cup. Figure 4b shows instantaneous velocity vectors plotted on top of contours of the RMS value of velocity magnitude. The figure shows that highest unsteadiness is observed in the shear layer between the reversed flow and the air flowing through the cup. Compared to other designs, this cup exhibits higher turbulence (higher RMS value) in the reversed flow core.

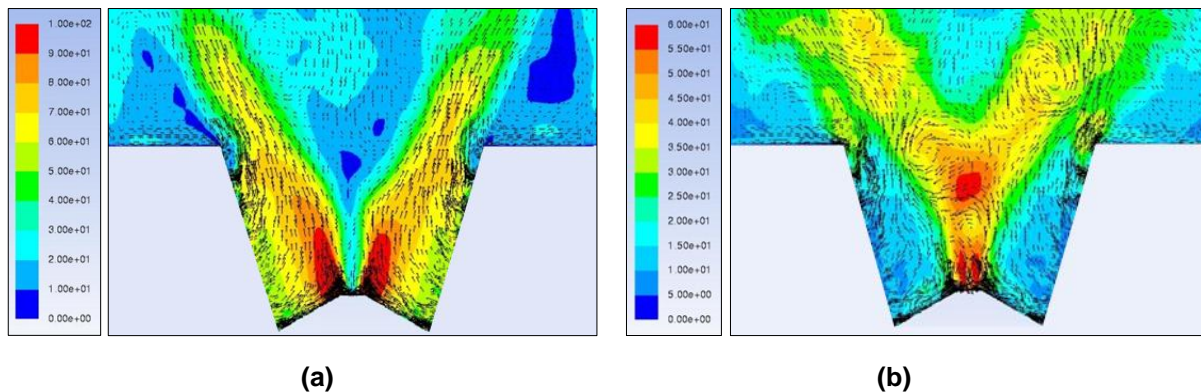

Figure 4: Velocity field in the 3ZI spray cup design; (a) time-averaged velocity vectors plotted onto contours of time-averaged velocity magnitude, (b) instantaneous velocity vectors plotted onto contours of RMS values of velocity magnitude

Upon selection of a swirler design for the 3ZI rig injector hardware, a three-cup CFD model was prepared to evaluate cup-to-cup interaction and airflow splits between cups in the center panel and side panels. Figure 5 shows the model geometry. The simulations were for both atmospheric condition and a nominal 85% power condition, assuming a 4% pressure drop in both cases. The computational mesh contained 39 million cells which were clustered primarily in the cup region. Appropriate boundary conditions were used to model the effect of neighboring rows of spray cups. A realizable k- ϵ turbulence model was used to account for the effects of turbulence on the flow.

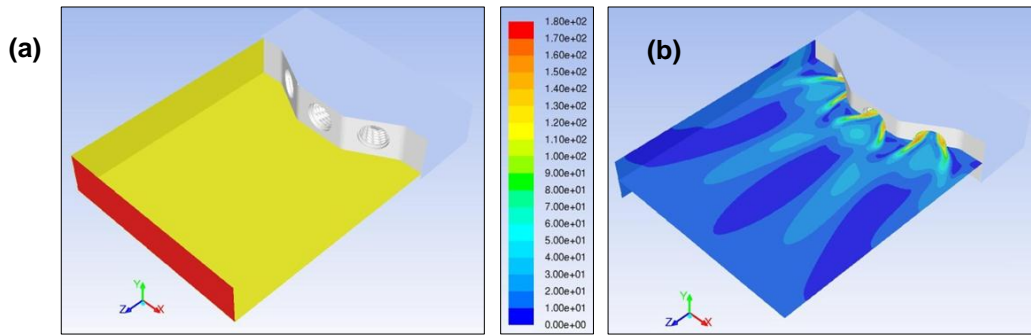

Figure 5: A three-cup model of 3ZI rig injector – (a) flow volume geometry, (b) contours of velocity magnitude in center plane

Figure 6 shows a close-up view of the velocity field downstream of the cup for the 85% power operating point. Figure 6a shows the velocity vectors along with contours of velocity magnitude. The figure shows a reversed flow near the cups that closely resembles that predicted by the single-cup LES simulations for the same cup design. Figure 6b shows the velocity vector along with contours of RMS velocity computed from the predicted turbulent kinetic energy. Again, when compared to the RMS values predicted by the atmospheric LES simulation for the region immediately downstream of the cup, the current values are about 80% higher. However, the current RANS simulations do not predict the high RMS values within the reversed-flow air core inside the cup that were predicted by the LES. The simulations show that the air flow is evenly split between the cups, with less than one-half percent difference between the three cups. The even split suggests that the fuel distribution support and atomizer bodies on the upstream side of the spray cups do not significantly interfere with the airflow into the cups.

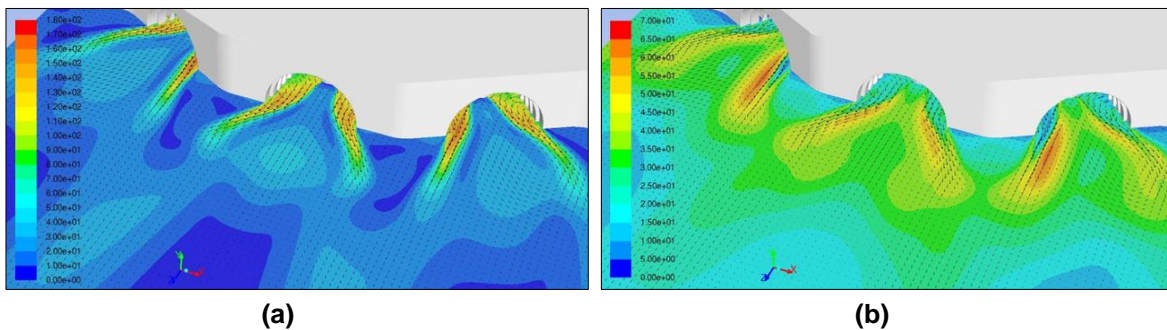

Figure 6: Velocity field for the 3ZI at 85% operating point (a) velocity magnitude, (b) RMS values of velocity computed from predicted turbulent kinetic energy

2.1.2 Thermal & structural analysis of the 3ZI spray cup

A finite element analysis (FEA) was undertaken to predict the thermal and structural performance of the 3ZI. For simplicity, a single spray-cup and fuel tip assembly was analyzed, including the connection

to the fuel distribution support. The analysis yielded predictions of wetted wall temperature (WWT) and maximum stress to which the tip will be subjected under different operating conditions. At less than full power, the analysis predicted wall temperatures will within acceptable range. At full power, the maximum WWT is predicted to be slightly above what is generally considered a threshold where coking can occur. However, due to the limited duration of engine operation at this extreme condition, it is anticipated that little coking of the fuel circuit will occur. Parker has significant experience with injectors operating under these conditions.

The maximum predicted stress under maximum power conditions translates to a predicted life in excess of 4,000 cycles, which exceeds the needs of this test program. Additional, straight-forward improvements can be made to reduce the stress level in the high-stress area and improve life above 4,000 cycles.

2.2 Three-Zone Injector Design and Manufacture

Four variants of the 3ZI were built and tested during the program. The four versions, designated “E01”, “E02”, “E03”, and “E04”, all employ the same 15-cup spray-cup array described above. The injectors differ in atomizer design, the placement of the atomizer tips within the spray cups, and the location and number of pilot cups. The spray cups are arranged with alternating swirl direction as shown in the UEET program to be effective [1-3]. Fuel tubes attached to the rear of the fuel distribution support supply fuel to each of the three to four stages of the injector, depending on the version. Note that a practical LDI fuel injector would ideally incorporate at most two independent fuel inlets, although additional staging flexibility may be attained using advanced valves. Here, however, the extra stages were incorporated to facilitate experimentation with various staging options.

The E01 and E02 injectors were designed for ignition and lean-blow-off (LBO) performance testing in atmospheric combustion experiments conducted at the University of Cincinnati. In these injectors, the 15 spray cups are divided into four independently fueled stages to allow flexibility when testing for ignition and low-power operation. Pilot-1 is a single cup located in the center panel of the injector, second row from the top. Pilot-2 fuels the remaining two cups in the second row. The Main-1 fuel circuit comprises the four cups remaining in the center panel not fueled by Pilot-1. Finally, Main-2 fuels the eight cups in the two side panels not fueled by Pilot-2. The pilot circuits are intended for use during ignition and for piloting of the flame. Main-1 along with the pilot circuits is intended for low power operation while Main-2 is intended for use during high power and cruise operation in combination with the remaining fuel circuits.

The E01 and E02 injectors differ primarily in the location of the atomizer tips within the spray cups with respect to the cup exit (insertion depth). Based on results from atmospheric combustion tests (see Section 4) the insertion depth of the E02 injector was chosen for the E03 injector. A number of design enhancements were incorporated into the E03 injector to improve performance and accommodate flame tube testing in the CE-5 rig at NASA Glenn Research Center. The atomizer tips were modified slightly, and the pilot was moved to the first row. Also, the heat shielding was installed to the support subassembly to accommodate high temperature air flow in the combustion rig.

Figure 7 shows a representative photograph of an assembled 3ZI injector along with images of the sprays from the atomizers within the spray cups. Note that no air is flowing. In flow tests, the atomizer tips proved very consistent and the sprays were observed to be uniform, with no streaks or voids.

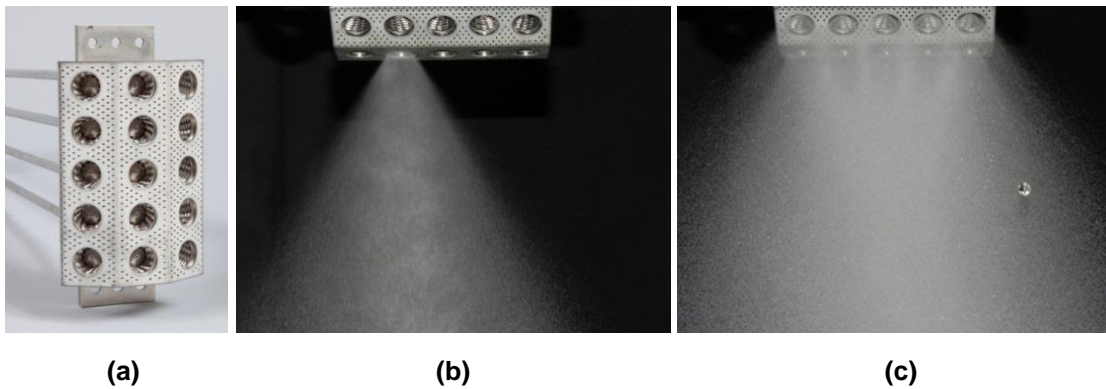

Figure 7: Complete 3ZI (a) injector, (b) pilot spray at 100 psi, (c) pilot and main spray at 100 psi

The results of flame-tube experiments using the E03 injector led to further refinements of the 3ZI design that were incorporated into the E04 variant that aimed at improved emissions and turn-down performance. While retaining the E03 fuel staging scheme, the E04 variant features reduced flow number atomizer and modified front heat shield. The reduction in atomizer flow number will result in improved atomization, especially at low flows, which in turn is expected to improve emissions and enhance operability at low and intermediate power.

3 Atmospheric Combustion Rig

The atmospheric tests conducted at the University of Cincinnati included both ignition and mixing studies which required two different rig configurations. The two configurations differ in exit geometry as shown in Figure 8. The ignition study configuration is shown in the middle of the figure and comprises an air box, a central flange, and a liner assembly with instrumentation and optical access. In the image on the right, the liner assembly has been replaced by an alternate outlet plate to provide unrestricted access to the region downstream of the injector for mixing measurements. In both configurations the injector is mounted to the upstream side of the central flange and enclosed within the air box which provides a conditioned air flow to the inlet side. The injector fuel tubes pass through the inlet flange of the air box and are captured by compression fittings. The image on the left shows the inlet flange as viewed from upstream. In this view the two air inlets are visible.

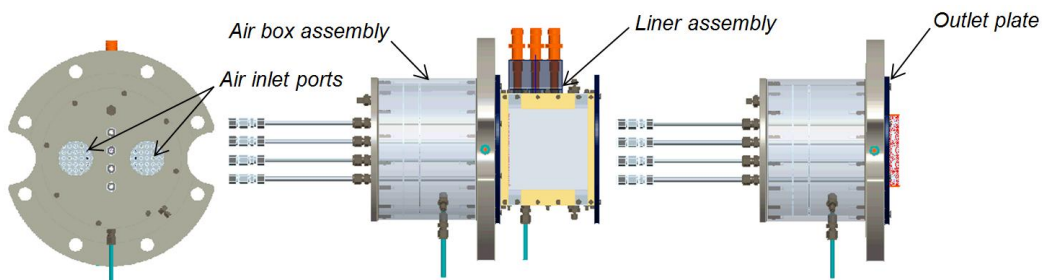

Figure 8: Atmospheric combustion rig - liner assembly and open exit configurations

The liner assembly comprises an upper and lower liner wall and two quartz side walls. Both effusion-cooled and solid liner walls were tested. The three orange components represent three possible igniter positions available during ignition studies. During testing the temperature and pressure (dynamic and static) were monitored both upstream and downstream of the injector, with additional temperature probes within the cooling air passages adjacent to the upper and lower liner walls. A photograph of the combustion rig with the 3ZI installed is shown laying on its right side in Figure 9.

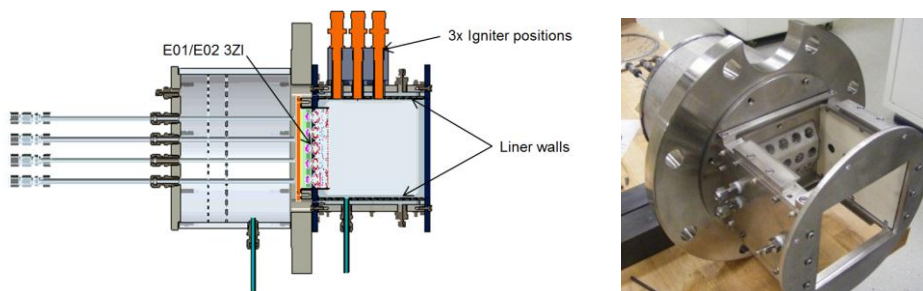

Figure 9: Atmospheric combustion rig with liner assembly

4 Aerodynamic and Spray Performance of the 3ZI

Several tests were conducted to characterize the aerodynamic and spray performance of the 3ZI. These tests were conducted at the University of Cincinnati (UC) School of Aerospace Systems Combustion Research Laboratory, which is located in the University's Center Hill Facility. The tests included effective area measurements and Laser Doppler Velocimetry (LDV) characterization of the flow field downstream of the injector, both of which are presented below.

4.1 Effective Area Measurements

The E02 injector was installed in the atmospheric rig to measure the effective area of the spray cups and liner cooling holes for pressure drops ranging from 5 cm H₂O (0.5%) to 60 cm H₂O (6%). The spray cup geometry was common to all injector variants, thus the effective area measurements were applicable to all injectors built during the project. The effective area curve-fits shown in Figure 10 were used in all calculations of air mass flow. Note that the effective area changes by only 3.7% as the pressure drop is increased from 10 cm H₂O to 50 cm H₂O (or 1% to 5%). The effective area of the effusion-cooled liner was about 20% of the injector effective area.

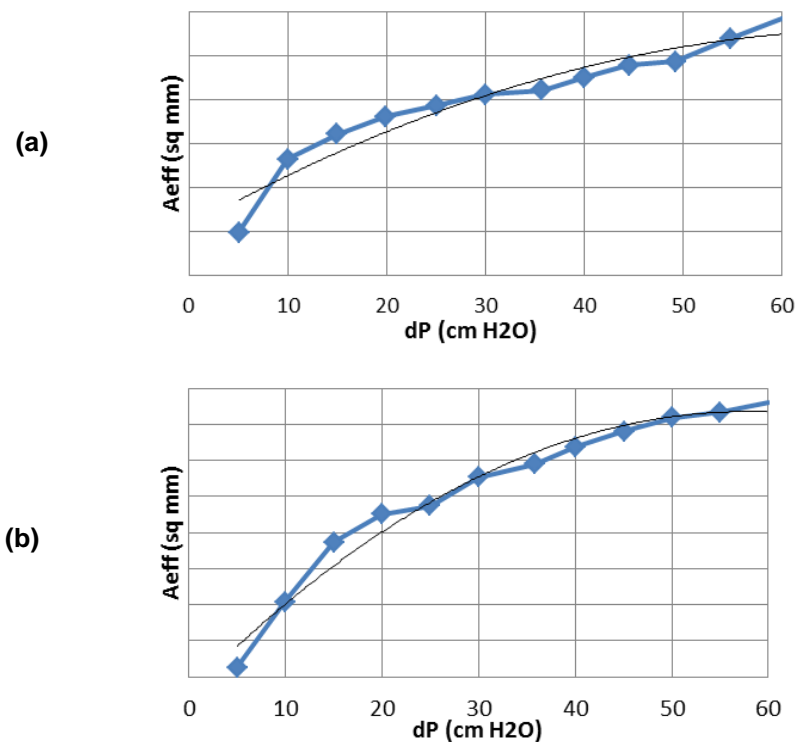

Figure 10: Measured effective area as a function of air pressure drop for (a) 3ZI and (b) 3ZI and effusion-cooled liner

4.2 LDV Investigation

4.2.1 LDV test setup and scope of measurements

For the LDV study, the injector was installed in the air box described in Section 3 and shown in Figure 8 while the downstream air flow was confined by a Plexiglas air-box. The LDV measurements were conducted using an Artium PDI-200 system. The coordinate frame of reference was chosen with the origin on the center axis of swirler 3 with X-axis directed towards swirler 13, Y-axis directed towards swirler 2 and Z-axis directed in the streamwise flow direction. LDV measurements were carried out in the center plane (YZ plane at $X = 0$) and several cross-section planes (XY planes). The injector geometry restricted optical access in some parts of these planes.

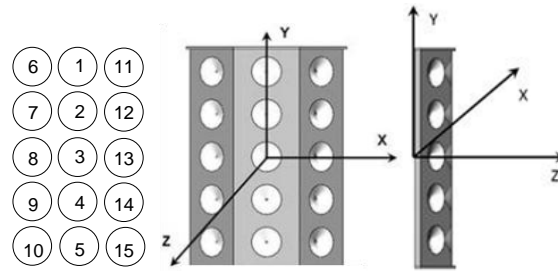
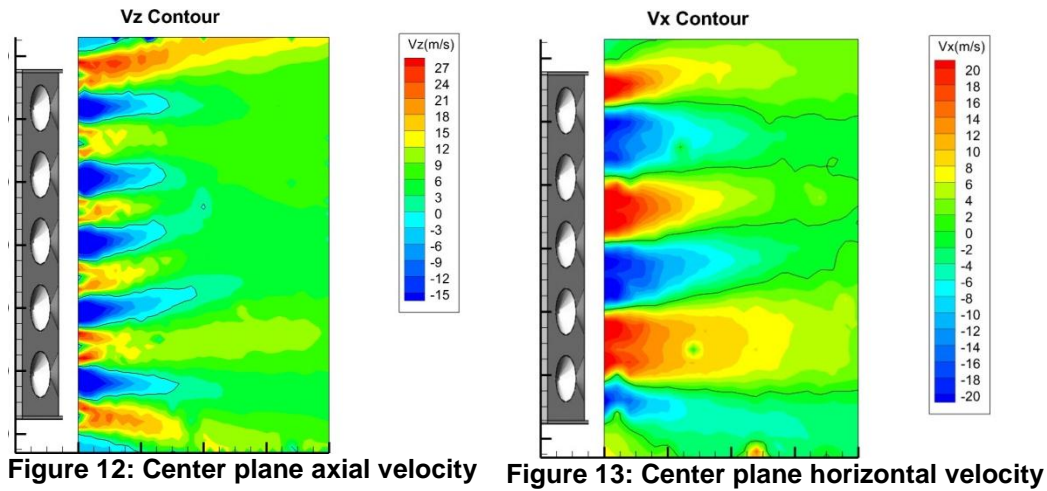

Figure 11: Injector Schematic and coordinate frame

To facilitate the discussion of the results, the spray cups are numbered as shown in Figure 11. Specifically, the cups in the center column are numbered 1-5 while the cups in the left and right columns are numbered 6-10 and 11-15, respectively. Note that the swirl direction of each spray cup is opposite to those of its neighbors along its row and column.

4.2.2 Results of LDV testing

The YZ plane at $X = 0$ mm is the vertical center plane of the injector and of the center-panel air swirlers, 1-5. Figure 12 and Figure 13 show contours of the axial (V_z) velocity and the horizontal (V_x) components of velocity in this plane and include lines indicating the locations of zero velocity. The V_z contour (Figure 12) shows the center recirculation zones (CRZ) for swirlers 1-5. The CRZs have lengths between 2.3 to 3.0 times the swirler diameters. Since neighboring swirlers are counter-rotating, the V_x components of the merging swirling jets have the same sign (Figure 13), avoiding large shear stresses between the jets. Regions of high V_z (Figure 12) near the top and bottom are assumed to be due to leakage in the clearance between the base plate and the injector. These can impact ignition and lean blow-out of the flames at swirlers 1 and 5.



The XY plane at 0.7 cup diameters (0.7D) from the injector face was the cross-sectional plane closest to the exit plane of the center swirlers with full optical access. Figure 14 shows the contours of V_z in in that plane overlaid with vectors representing the in-plane velocities (V_x and V_y). The CRZs for swirlers 1-5 are surrounded by the swirling jets, seen in Figure 12, whose shapes are impacted by interaction with neighboring swirlers. The clockwise rotations of swirlers 1 and 3 and counter-clockwise rotation of swirler 2 induce negative V_x velocity between swirlers 1 and 2 and positive V_x velocities between swirlers 2 and 3, causing the shape of the swirling jet around cup 2 to become slightly oblong and stretch towards its top left and its bottom right corner. Negative axial velocities representing corner recirculation are observed near the chamber walls on all sides.

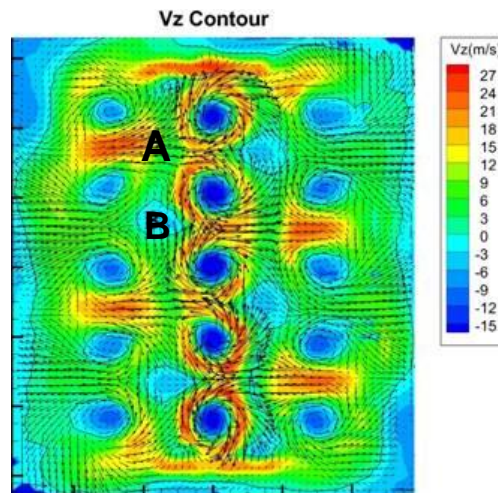

Figure 14: Axial velocity with in-plane velocity vectors in a plane 0.7D from the injector front panel

The LDV measurements show secondary flows in the region between the vertical swirler columns. These are clearly seen in Figure 14 in two regions; region A bordered by swirlers 1, 2, 6 and 7, and region B below it, bordered by swirlers 2, 3, 7 and 8. In region A, the interaction between swirler 1 and 2 on the right of A, and between swirlers 6 and 7 on the left of A induces mass flow into region A with high V_x velocities on both the left and right. Weaker interaction between swirler pairs 1 and 6 above region A and between swirlers 2 and 7 below region A induces mass flow out of region A, but with V_y velocities that are substantially lower in magnitude than the V_x velocities entering region A. With the injector wall behind the measuring plane, the net flow into region A in the measuring plane causes the air mass to move downstream, away from the injector face, with positive V_z . The opposite mass movements in and out of region B bordered by swirlers 2, 3, 7 and 8, results in low pressure which induces mass to move towards the injector face from the downstream side, i.e. with negative V_z .

Figure 15 shows the contours of V_z in plane 1.7 cup diameters (1.7D) from the center panel. As in Figure 14, the contours are overlaid with vectors representing the in-plane velocity components. Compared to the plane at 0.7D in Figure 14, there has been an overall redistribution of axial momentum at this location resulting in lower magnitudes of both positive and negative V_z in the plane. The regions of recirculation, like region B in the upstream plane shown in, seem to have merged with CRZs of the adjacent side swirlers to form large areas of slightly negative V_z .

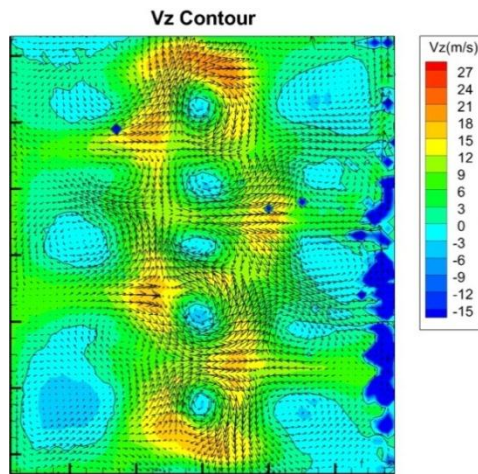

Figure 15: Axial velocity with in-plane velocity vectors at Z = 1.7D

Overall, the LDV study of the aerodynamics of the Parker 3ZI reveals several important flow characteristics produced by the injector, such as the length of the central recirculation zones at the center-panel swirler, the impact of leakage flows, and the secondary flows produced by swirler-to-swirler interactions.

5 Atmospheric Combustion Tests

Atmospheric ignition and lean blow-out analysis on injector variations E01, E02 and E03 was performed at the University of Cincinnati (UC) Center Hill Facility. A wide range of air and fuel flow rates were explored to map the low power ignition and LBO conditions for the Pilot, Main 1, and Main 2 fuel circuits. The tests were performed with the injectors firing in a horizontal direction using the atmospheric test rig design described in Section 3. The E01 injector was tested with both an effusion cooled liner and the solid liner (see Section 3). For the E02 and E03 injectors only the effusion cooled liner was used. Ignition testing was conducted for several different staging approaches. Specifically, ignition of Pilot 1 alone was tested as well as ignition of Main 1 from Pilot 1 and ignition of Main 1 and Pilot 1 together (i.e., the entire front panel of the 3ZI). Ignition of Main 2 from Pilot 1 and Main 1 was tested as well. A wide range of air and fuel flow rates were explored to map the low power ignition and LBO conditions for various fuel staging schemes.

5.1 Test Setup & Instrumentation

The atmospheric test rig with 3ZI installed was connected to UC's Horizontal Test Rig. This Horizontal Test Rig is equipped with a 72 kW inline air heater for preheating the combustion air. The air was supplied by an Atlas Copco GA90FF rotary screw compressor which is rated for a flow rate of 600 CFM at pressures up to 110 psig. The air system consists of a settling tank, pressure regulator, and a network of pipes and hoses leading to the Horizontal Test Rig. The combustion air flow rate was controlled by a manual gate valve located at the inlet of the Test Rig. Air pressure in the manifold was measured by a Meriam 2110 Smart Gage series differential pressure transducer. The air temperature in the manifold was monitored by a type K thermocouple.

Fuel flow to all three circuits was provided by a single fuel pump. The fuel line from the pump was divided into three lines, with a shut-off and a manual metering valve on each line for controlling flow rates. Flow rates on the three circuits were monitored by Micro Motion Coriolis Flow Meters, model CMF 010. The schematic for the test setup with plumbing and instrumentation is shown in Figure 16.

The ignition rig had three preconfigured igniter locations as described in Section 3 and shown in Figure 16. The igniter, which was supplied by Parker, was installed at location 2 for most tests. All instances of ignition and blow-out were visually observed and manually recorded.

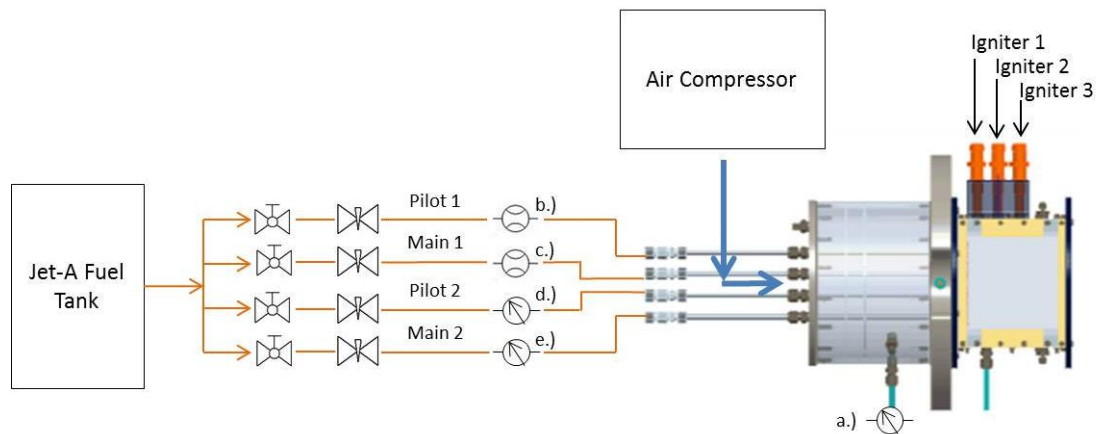

Figure 16: Plumbing Schematic for the atmospheric combustion rig

For ease of reporting results, the individual injector cups of the center column, which contains the Pilot 1 and Main 1 circuits, are numbered 1-5 from top to bottom, as shown in Figure 11. Recall that the E01 and E02 injectors contain two pilot circuits, and the single-cup pilot stage designated Pilot 1 is at location 2. The E03 injector contains one single pilot cup at location 1.

5.2 Ignition & LBO test procedure

The procedure for each test was as follows:

1. Preheat air to desired temperature. For ambient air, start with step 2
2. Set air differential pressure (dP)
3. Set fuel flow rate
4. Spark 3 times to attempt stable ignition. If successful, move to step 6
5. If ignition is unsuccessful, increase fuel flow rate and repeat step 4
6. Once at least one injector cup has ignited, increase fuel flow rate until target cups have ignited
7. When stable ignition is achieved for all injector cups under consideration, slowly decrease fuel flow until all cups blow out, noting locations for each blowout

Initial tests were conducted with ambient temperature air, followed by tests with preheated air. For each case, the starting fuel flow rate was set to a very low flow rate. In case of unsuccessful ignition, the flow rate was increased by a small amount, until ignition was achieved. A typical increase in fuel flow rate was 1 pph/cup. A sample ignition event on Pilot 1 is shown in Figure 17.

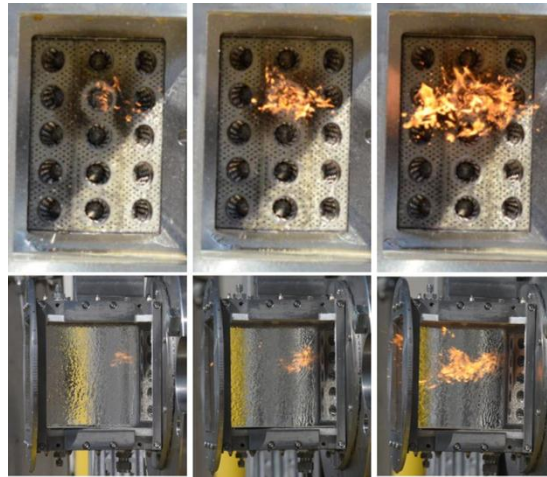

Figure 17: Example of Pilot 1 ignition for Injector E01

With a flame on one or more circuits, LBO tests were conducted by gradually reducing the fuel flow to one circuit at a time, recording the fuel flow at which the flame on any cup was observed to extinguish. Once all cups of the circuit being adjusted had blown out, the fuel flow to that circuit was shut-off. In all cases, flow to Main 2 was adjusted first (if it was lit in the preceding ignition test), followed by Pilot 2, Main 1 and, finally, Pilot 1, in that order. Figure 18 shows an example of the visible flame for an ignition of Pilot 1 and Main 1 flowing together and the subsequent flame outs, first on Main 1 and then on Pilot 1, as fuel flow is reduced.

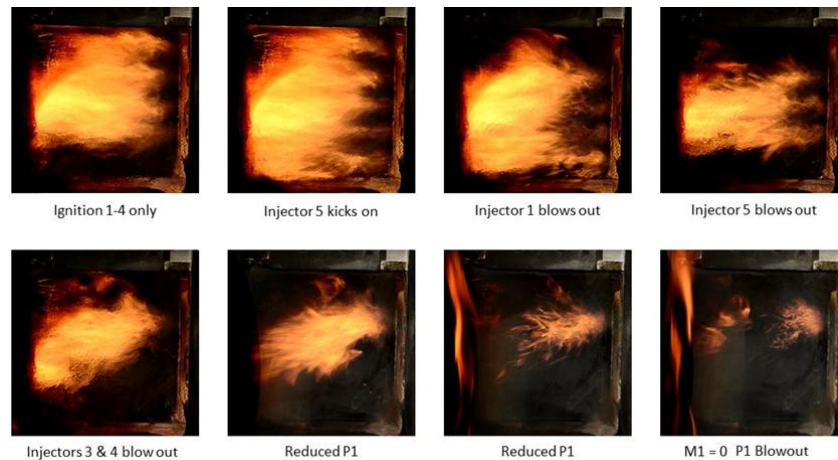

Figure 18: Example of ignition and LBO sequence for the E01 injector when Pilot-1 and Main-1 are both fueled

5.3 Single-cup Pilot Ignition/LBO Envelope

The ignition and LBO performance for the three injectors is compared in Figure 19. The figure shows the fuel-air ratio (FAR) at ignition and lean blow-out of Pilot 1 for each injector operating with preheated air and uncooled liner. Clearly, Injector E03 offers the best performance in these tests with ignition occurring at less than ½ of the fuel flow required for Injector E01 and E02. Injector E02 still offers advantages over injector E01. Injector E03 also has improved LBO limit at the very low air pressure drops. At 2% pressure drop, the E01 and E03 perform similarly. Based on the LBO performance of E01 and E02 at 0.5% and 1% pressure drop, one can conclude that all three injectors will have the same LBO performance at 2% pressure drop.

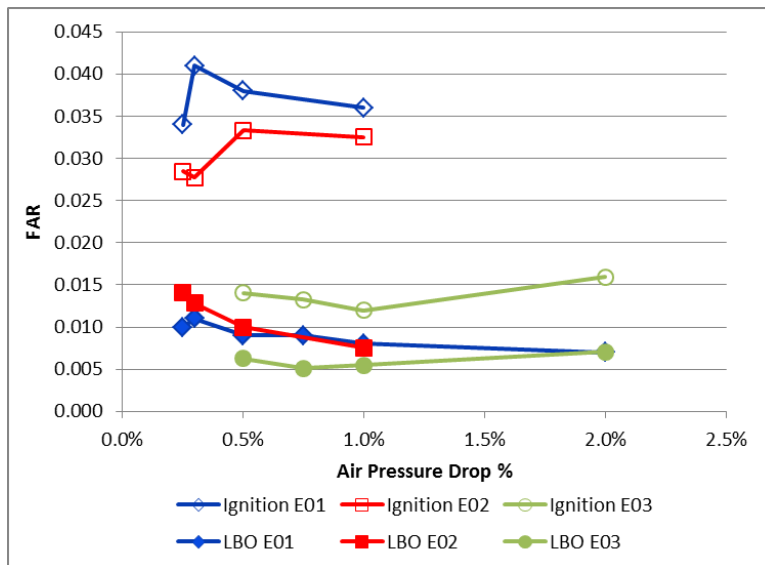

Figure 19: FAR at ignition and LBO of E01, E02 and E03 operating on Pilot 1 with preheated air

6 High Pressure Combustion Tests

In January of 2013, Parker delivered the third generation (E03) of the 3ZI (P/N 6110077DHE03) to NASA Glenn for combustion testing in NASA intermediate pressure combustion rig (CE-5). Combustion tests were then performed from 2/19 to 2/21 and from 3/19 through 3/21. As described in Section 2.2, the injector has three fuel circuits, namely, a pilot circuit that feeds a single spray cup at one end of the center panel, a main flow circuit (Main-1) that fuels the remaining four spray cups in the center panel, and a second main flow circuit (Main-2) that feeds all ten spray cups on the two side panels.

After the injector was instrumented with thermocouples by NASA, the injector was installed in the CE-5 test rig for combustion testing. The tests were conducted at four different operating pressures, nominally 100 psia, 150 psia, 200 psia and 250 psia, and three different operating temperatures, nominally 567 °F (570 K), 864 °F (736 K) and 1034 °F (830 K). The tests covered a range of equivalence ratios from 0.163 to 0.677 (fuel-air ratios from 0.011 to 0.046). Note that in the actual tests, the pressures and temperatures deviated slightly from the nominal values. After over 40 hours of testing, the injector was removed from the rig in excellent condition, demonstrating the high technology readiness level of the mechanical and thermal aspects of the injector design. The individual spray cups and atomizer tips are clean without any evidence of flame ingress. The thermal barrier coating on the injector face was intact with no evidence of spallation during combustion tests.

In the tests, NO_x emissions data was collected with the injector operating in staged mode on five cups (Pilot-1 and Main-1) and when operating on all 15 cups. Data was also collected on dynamics in the combustor. In this report, only emissions results obtained with all spray cups flowing are shown, as these are of greatest interest for high-power operation and allow comparison to earlier results using Parker's Macrolaminate injector designs described in [1, 2]. All NO_x emissions are reported in terms of NO_x Emissions Index scaled using an emission value attained at a high FAR at high pressure.

Figure 20 shows the scaled emissions plotted against the global Fuel-Air Ratio (FAR) while Figure 21 shows the corresponding combustion efficiency. The fuel-air ratio includes air used for effusion cooling of the injector face, which is estimated to be 6.5% of the total air flow. Note that data in Figure 20 and Figure 21 are labeled according to the nominal operating pressure and temperature but the data plotted are raw, i.e., without corrections to the emissions due to deviation of the actual operating point from the nominal operating conditions. The nominal operating points were selected for the purpose of giving as much useful data as possible from these intermediate pressure tests to enable prediction of LTO cycle emissions for a reference 60,000 lbf, 55 Overall Pressure Ratio (OPR) N+2 engine.

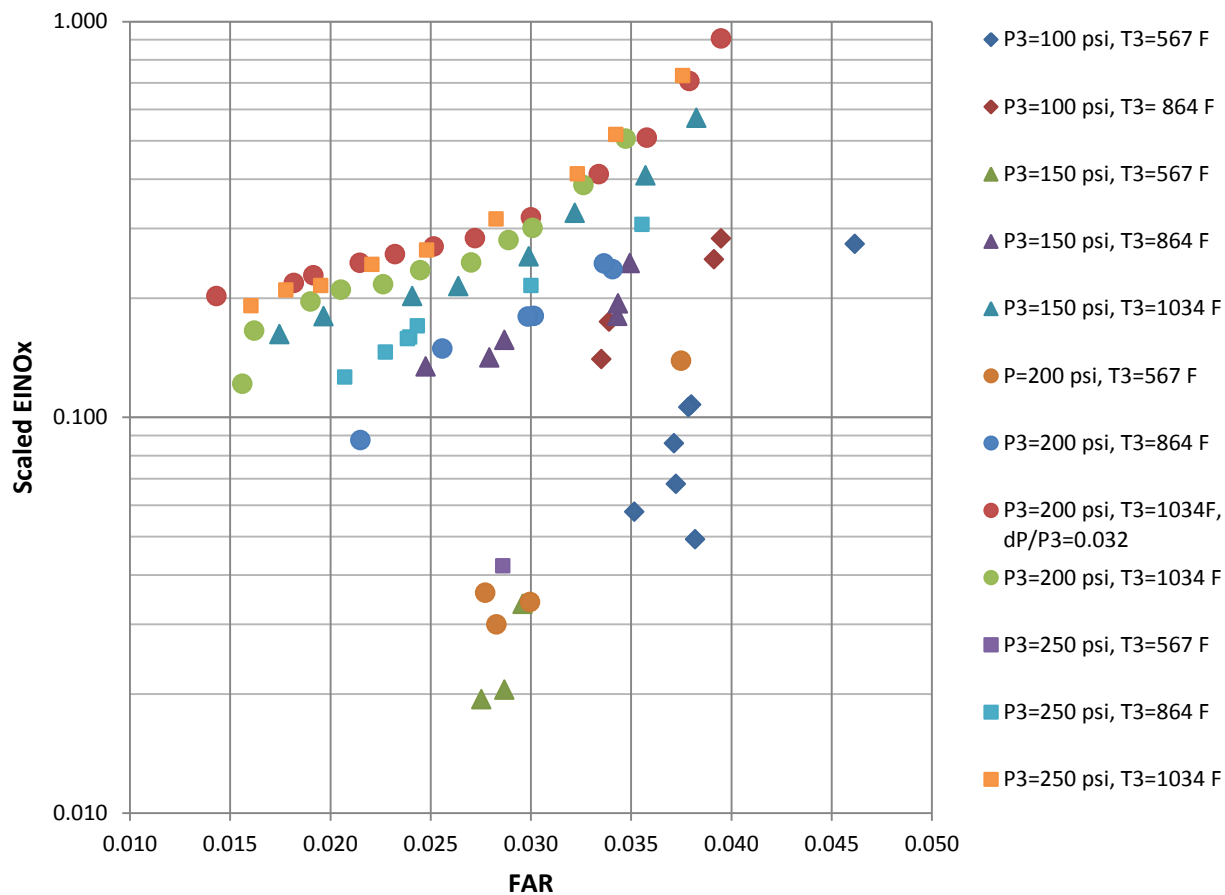

Figure 20: Scaled NOx emissions as a function of over-all FAR – all data is at nominal 4% air pressure drop except as labeled

For P3=100 psi and T3=567 °F, Figure 20 shows that NOx emissions are very low compared to the higher P3 and T3 values, as expected. The combustion efficiency was high (99.95% or higher) for all values of FAR displayed for this condition and the recorded CO emissions were less than 1 ppm, indicating a stable flame. However, below a FAR of 0.035 CO emissions started to climb and combustion efficiency dropped and the flame became less stable. One likely reason is that fuel flow rate is very low at this low pressure and air density is relatively low so atomization becomes increasingly poor as the FAR decreases, resulting in low vaporization rates and poor dispersion. This is supported in part by improved operability for the same T3 when the combustor pressure is raised to P3=150 psi. For this higher P3, stable operation and very low NOx emissions were attained at global FAR of 0.0275, where atomization is improved due to both higher atomization pressure at a given FAR and improved air blast atomization due to higher air density. This suggests that using lower flow-number atomizers in future versions of the injector will likely enable operation at lower FAR than recorded in these tests.

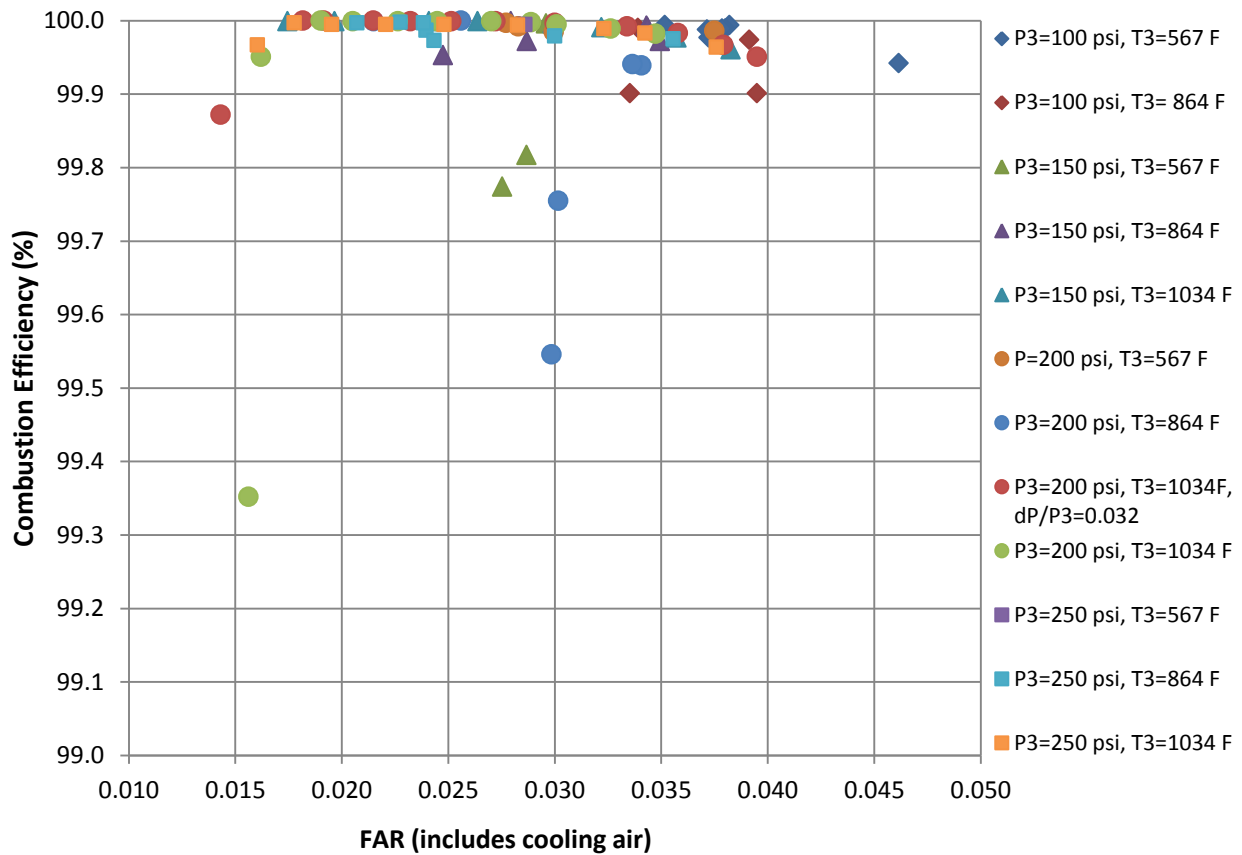

Figure 21: Combustion efficiency as a function of global Fuel-Air Ratio (FAR) – all data is at nominal 4% air pressure drop except where labeled

To operate this version of the injector at still lower FAR than shown here at the 100-psi operating point, staging of the injector cups would be required such that spray cups that are fueled operate at a FAR of 0.035 or higher. For instance, operating on five cups would yield a global FAR just under 0.012.

Figure 22 shows the scaled NOx emissions attained for T3=864 °F for the four different operating pressures tested, with the highest pressure being the upper limit for the combustion rig. The figure reveals a very consistent emissions trend as a function of FAR for the higher operating pressures while some scatter in the data is present at the lower pressures. In particular, the data shows stable operation at lower FAR as the pressure increases from 100 psi to 250 psi. Specifically, for P3 of 200 psia and 250 psi, stable flames were obtained at substantially lower FAR than at 100 psia and 150 psia. This points to improved atomization and, possibly, improved dispersion of the spray at the higher pressures. Further improvements in turndown can almost certainly be achieved by employing atomizers with smaller flow numbers, especially at the lower pressures, and possibly by further optimizing the position of the atomizers within the spray cups to achieve better air blast atomization and dispersion.

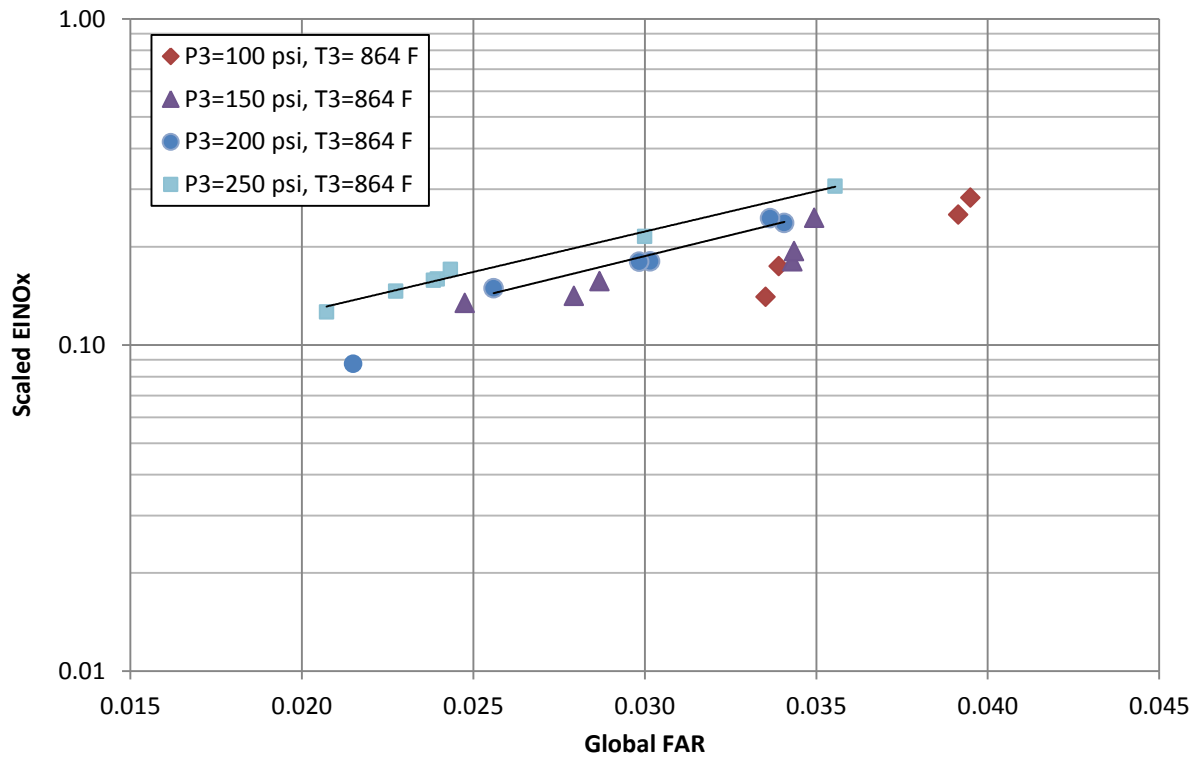

Figure 22: Measured NOx emissions at T3=864 °F (736 K)

Figure 23 shows the scaled NOx emissions at T3=1034 °F, the highest temperature permitted for the CE5 rig. For this high temperature, very consistent emissions trends are observed. The injector could be operated at FAR as low 0.017 corresponding to equivalence ratio of 0.25. This is considerably lower than demonstrated for the UEET injectors. Also, although the comparison is not shown here, the actual NOx emissions of the current 15-point 3ZI (E03 version) were shown to be considerably lower than the 25-point UEET injector when compared at the same tested P3 and T3 [1]. Also, the turndown was shown to be better. Both imply a substantially improved design.

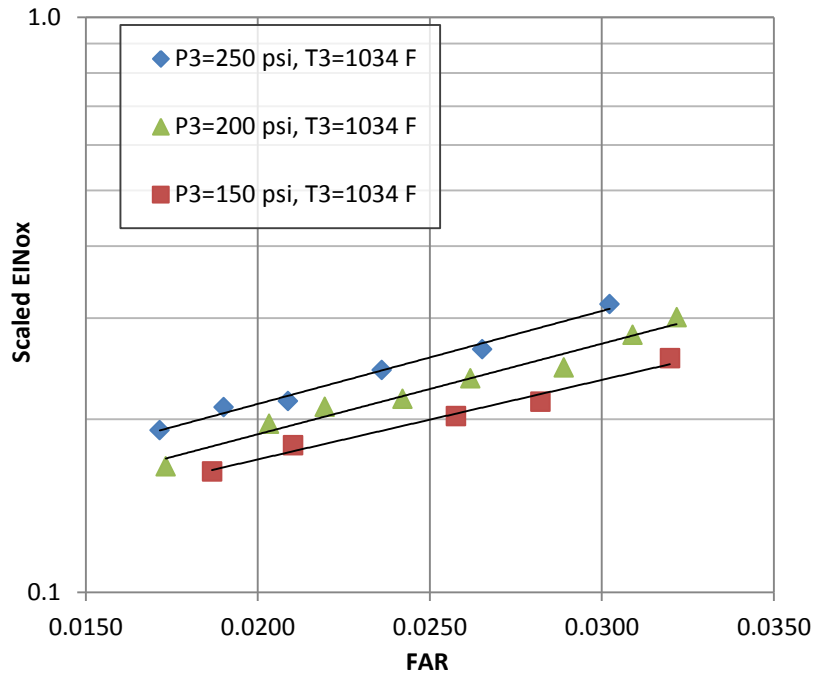

Figure 23: Scaled NOx emissions at nominal inlet temperature of 1,034 °F (830 K)

In order to predict LTO cycle emissions of the reference N+2 engine, it is necessary to obtain valid correlations to extend emissions predictions beyond the current test range obtained in the CE5 test facility. Extrapolation from the current data to the high pressures and temperatures would be unreliable. However, in light of the parallels between the performance of current injector and that of the IDome injector it is preferable to use or build on existing correlations that have been developed for the IDome injectors [1- 3]. Thus, the pressure and temperature dependence of the correlations developed by Wey [1- 3] can be used, namely:

$$E_{INOx} \propto P_3^{0.594} \exp(T_3)$$

This dependence on pressure and temperature has been demonstrated to provide a good correlation for various IDome injectors [1, 2, 3].

When plotting the emissions predicted by Wey's correlations against all the measured data from the current injector experiments, substantial scatter is observed and useful trends are not obvious. However, when limiting the data to $T_3 = 1,034 \text{ °F}$ and $P_3 \geq 200 \text{ psi}$, which is in the range of pressures and temperatures that were used in the development of Wey's correlations, and plotting the ratio of measured emissions to predicted emissions against the FAR in combustion zone (i.e., cooling flows are excluded to

be consistent with the correlation), a useful trend is observed. This is shown in Figure 24. For FAR above about 0.027 the current measured emissions are lower than those predicted by the correlations for the UEET injector and at a local FAR above 0.03 the measured emissions are about 5% lower than predicted by the correlation. Note that the UEET injectors could not be operated at FAR below about 0.022.

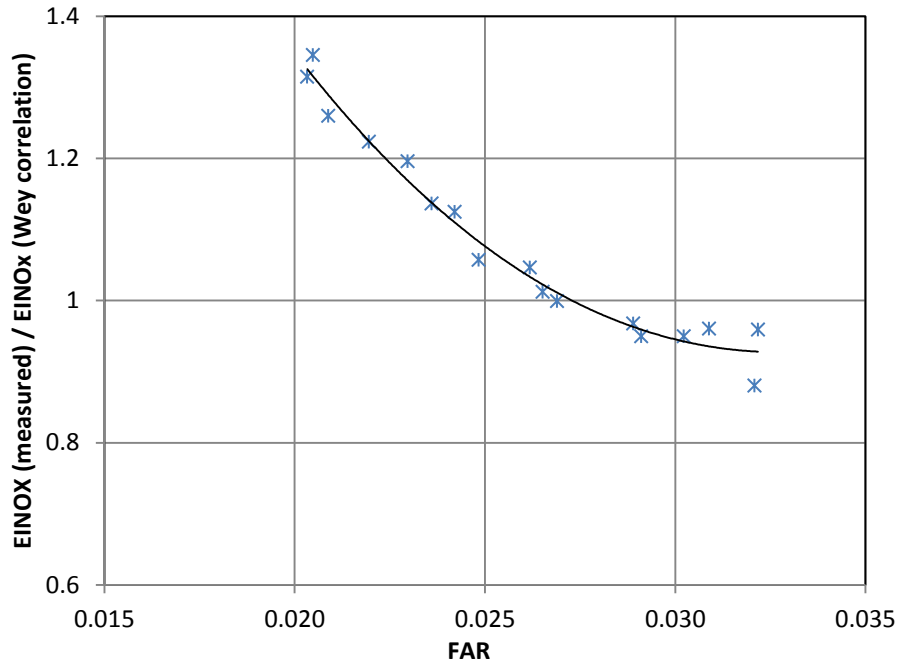

Figure 24: Comparison of measured NOx emissions and emissions predicted by the Wey correlation (measured data is from tests of 200 psi and 250 psi, for nominal inlet temperature of 1,034 °F (830 K))

If it is assumed that the ratio shown in Figure 24 can be used as correction factor for the Wey correlation at high power settings, the LTO Cycle emissions can now be predicted. With this approach, and using a proprietary LTO cycle provided by NASA Glenn Research Center, emissions of 24.6 g NOx /kg fuel and 36.4 g NOx /kg fuel are obtained for the 85% and 100% thrust settings of the reference 60,000 lbf, N+2 engine. Using these emissions numbers along with conservative estimates of emissions for the 7% and 30% thrust settings that are based more directly on the measured data, the LTO NOx emissions for the reference engine can now be estimated as shown in Table 1.

Table 1: Summary of estimated emissions for 60,000lbf, 55 overall pressure ratio N+2 engine

Thrust Setting	LTO Time	Fuel Flow	EINOx	Total NOx
%	Minutes	kg/s	g NOx / kg fuel	g
100%	0.7	1.91	36.4	2,924
85%	2.2	1.59	24.6	5,057
30%	4	0.48	3.9	452
7%	27	0.137	3.0	662

Based on the data in Table 1 the LTO cycle emissions of the reference N+2 engine would be 34.1 g NOx / kN, or 31% of the 108.6 g/kN CAEP/6 emissions target (-1.04 +2OPR, where OPR is the overall pressure ratio of the engine at 100% rated thrust).

While the emissions results demonstrated with the current 3ZI are already excellent, Parker is confident that further improvements can be made. First and foremost, the atomizer flow numbers can be reduced to produce finer spray with higher injection velocity at any given operating point. This is expected to improve both low-power operability and reduce high-power emissions. Second, the injector insertion depth can be adjusted to find an optimum for critical performance characteristics. Thirdly, flexible staging schemes can easily be incorporated into the injector. Finally, the combustor liner geometry can be optimized for the current injector to reduce the time of hot products in the combustor and lower emissions.

Following the completion of the combustion tests with the E03 injector, Parker manufactured the E04 injector, which incorporates lower flow number atomizers and other changes, and delivered to NASA for testing in the CE5 rig. These tests could not be completed before the program ended as access to the CE5 test rig was delayed by several months, in part by unusual cold weather conditions in the latter months of 2013. The tests of the E04 injector are expected to be completed by late spring of 2014. Parker is confident that the tests will show improved operability (turn down) and lower emissions.

7 Valve Development

Parker developed a high-speed fuel valve for this project based on its proprietary piezo actuator technology. The valve enables fuel trim function and it provides means to for high-bandwidth modulation of fuel flow in the primary fuel circuit in order to extend the lean stability limit and control combustion dynamics. Key design requirements for valve operation are a bandwidth of 1,000 Hz and a modulation authority of at least 10% at 1,000 Hz. Both targets have been met in verification testing at Parker. At the end of the program, Parker delivered a valve to NASA support modulated experiments that will be conducted in 2014.

The following sections summarize the valve development effort, including valve design, valve manufacture and assembly, and valve performance.

7.1 Valve Design

The electronic fuel modulation valve technology that Parker has been developing in recent years has been advanced under the ERA program to meet high-bandwidth requirements. The valve is a pressure-balanced metering valve driven by a proportional piezo actuator that is proprietary to Parker. The actuator has demonstrated operation in excess of a few billion cycles and can operate at much higher frequencies than conventional electromechanical actuators while delivering comparable force and stroke. The actuator is currently in production by Parker for industrial valve applications and has been suitably adapted for operation with liquid fuels. The fuel modulation valve can be designed with an internal bypass channel that sets a nominal (unactuated) flow area if desired. A key feature of the valve is an in-situ displacement sensor to monitor spool position in real time; position information can be used as a feedback signal for closed-loop control of the valve, as well as for diagnostic purposes.

Two different prototype valve designs have been demonstrated under prior development programs and both have been successfully operated in combustion rigs. The first valve was operated in proportional mode (no high-frequency dither component) using Jet-A liquid fuel in a high-pressure combustor. In series with a fuel injector, it was able to achieve a modulation authority of over 20% of nominal flow. The second valve was deployed in an atmospheric combustor fueled by gaseous hydrogen. This valve was operated with a sinusoidal drive signal at frequencies as high as 500 Hz. It demonstrated the capability to control both the amplitude and the frequency content of combustor pressure and heat release rate.

In building a valve for the current program, features from both predecessor valve designs were incorporated; namely, the liquid fuel capability from the first valve and the high-speed dither capability

from the second valve. A key design challenge, however, was to increase the operating bandwidth of the actuator within the valve from 500 Hz to 1,000Hz. Previous actuators were limited to resonant frequencies below 500 Hz. While they can be driven above resonance, the resulting actuator stroke is significantly diminished. In addition, driving at or near resonance can potentially damage the actuator. The approach taken for this program was to incorporate a new actuator design that increased the resonant frequency of the actuator beyond 1,000 Hz. Figure 25 shows photographs of the redesigned piezo actuator; it uses a symmetric displacement amplifier design coupled to second stage that results in motion along the axis of the piezo stack when actuated. The addition of the second stage, with compliant springs, significantly increased the resonant frequency of the actuator. Also, carbon fiber material was used for the arms to minimize the driven mass.

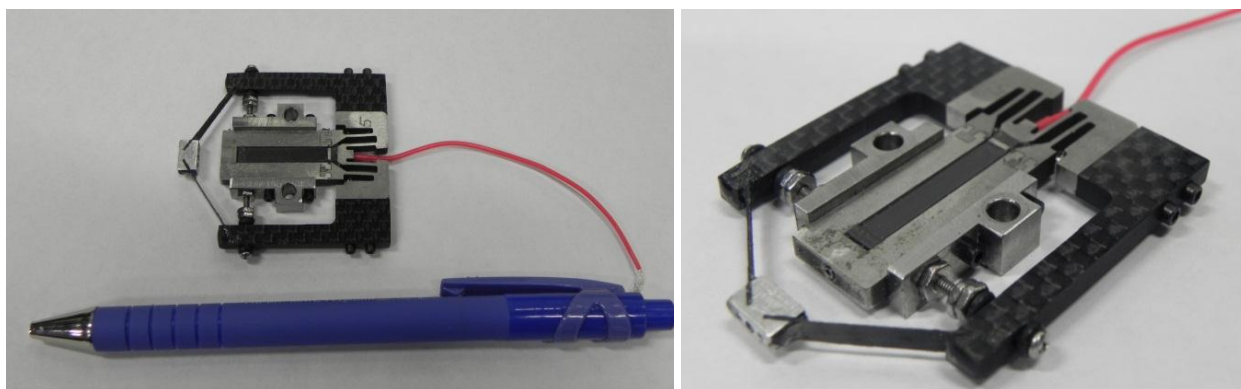

Figure 25: Photograph of high-frequency piezo actuator (E02 design)

After completing actuator design and verification testing (see Valve Performance section) the design effort shifted to the valve assembly. Three valve designs were completed under this program. The first two valves (designated “E01” and “E02”) were sized for the E01/E02 fuel injector variants. After fabrication and performance validation of the E01 valve, the third valve (E03) was designed for the E03 injector.

The valve is intended to be placed upstream of and in series with the pilot injector. Accordingly, the overall flow number (FN) of the pilot circuit will be a combination of the flow numbers of the valve and the pilot tip; see Figure 26 for a flow schematic. The valve itself has potentially three parallel flow paths within the valve: (1) leakage due to diametral clearance between spool and sleeve, (2) an optional bypass channel, and (3) the variable flow area metered by the actuator. The total valve flow number is a combination of all three. Modulation authority is defined as: $(FN @ 100\% - FN @ 0\%) / (FN @ 0\%)$, where the percentages refer to the stroke of the piezo actuator, with 0% representing unactuated (nominal) position and 100% representing maximum stroke.

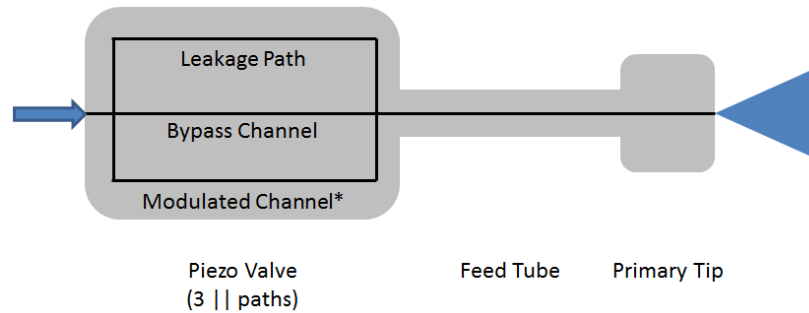

Figure 26: Flow schematic of modulated primary circuit

The size of the metering slot was chosen based on the 1,000 Hz actuator response to meet the 10% modulation authority target. This allows the pilot circuit FN to be set as much as 10% richer than nominal (statically), or to oscillate (dynamically) with variable amplitude up to 10% peak-to-peak around a preset value to control combustor dynamics.

In order to meet the above design requirement, a decision was made to eliminate the bypass channel in the valve and instead meter all the flow through a single, variable area channel. Figure 27 shows predicted valve response (FN vs. displacement) on the left, and the resulting pilot circuit response on the right. The solid vertical marker at 0.011" corresponds to the mean displacement at 1,000 Hz, while the dashed lines at 0.008" and 0.014" correspond to the min and max displacements at 1,000 Hz, respectively. Thus, the nominal flow condition can be set by driving the actuator to a stroke of 0.008" regardless of operating frequency. The 10% authority can be achieved by driving the spool position to higher displacement and opening the metered flow area. Note that at lower frequencies, higher modulation authorities can be achieved since the peak-to-peak variation of actuator displacement is greater than at 1,000 Hz (effectively, the dashed lines move outward).

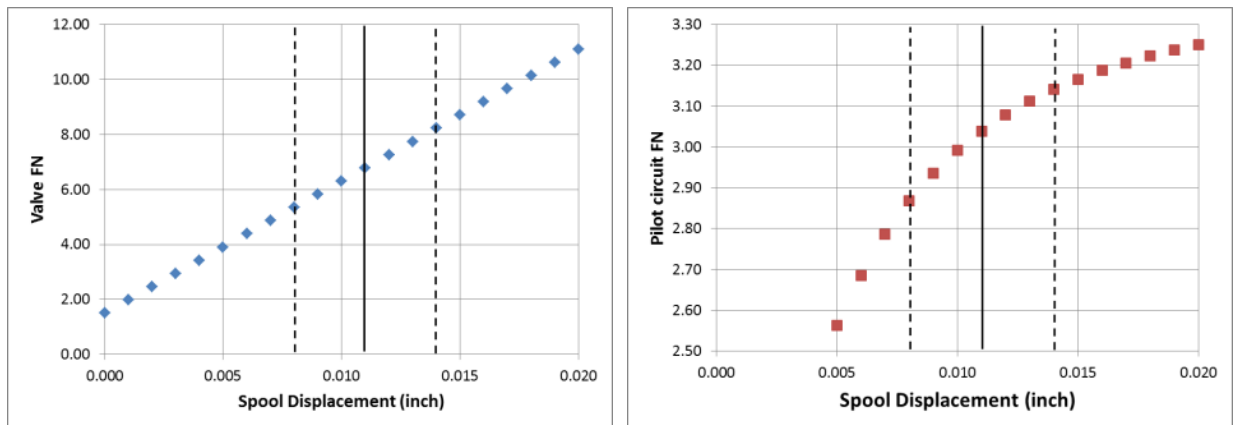

Figure 27: Predicted E01/E02 valve (left) and pilot circuit (right) response as a function of piezo actuator displacement

The E01 valve design was fabricated and tested; details are provided in the following sections of this report. The valve performed in line with predictions, validating the design approach as well as the actuator performance. Note the spool mass is approximately 0.44 g, which is an order of magnitude reduction over the most recent Parker design. Following this, the E03 version piezo valve was designed. The valve has four ports: (1) fuel inlet, (2) fuel outlet, (3) electrical feed-through for actuator lead wire, and (4) *in situ* displacement sensor.

The metering geometry of the valve was specified to provide at least 10% modulation authority across the entire 1,000 Hz bandwidth based on the performance of the piezo actuator. Figure 28 shows a plot of predicted maximum modulation authority as a function of oscillation frequency. Note that authority greater than 10% can be achieved over the entire target bandwidth. Furthermore, the valve can be also operated to achieve a “flat” 10% authority response by lowering the amplitude of the piezo drive voltage at lower frequencies (although the closed-loop control required for this is beyond the scope of this effort).

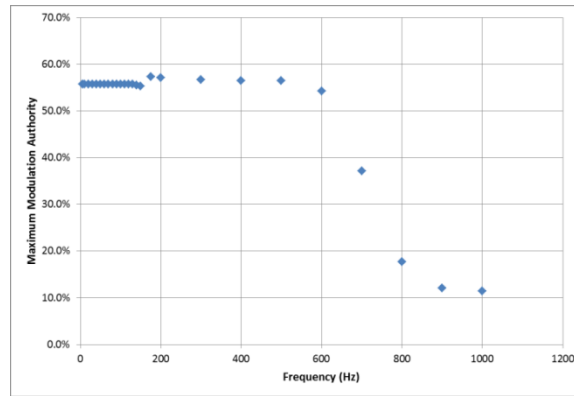

Figure 28: Predicted maximum modulation authority vs. operating frequency for E03 valve

7.2 Valve Manufacturing

As described above, three versions of the piezo valve assembly were fabricated. Given the technical risk relative to earlier valve designs – especially use of a 2-stage piezo actuator and significantly smaller spool and sleeve components – Parker accelerated fabrication of the prototype valve from Year 2 to Year 1. The E01 and E02 design packages were finalized in late July 2012 and released in early August 2012. Valve components were received by mid-September 2012, and the E01 valve was assembled shortly thereafter. No noteworthy issues were encountered during fabrication or assembly.

The E03 design package was released in March 2013, and valve assembly was started in June 2013 after receipt of components. Two E03 valves were manufactured; one valve was delivered to University of Cincinnati for atmospheric combustion experiments while the other valve is slated for future high-pressure combustion experiments in NASA’s CE-5 facility. Figure 29 shows a photograph of one of the E03 valves during assembly with the cover removed. Figure 30 shows the entire valve system, including the piezo valve assembly, in-situ displacement sensor readout unit (tethered to the valve via fiber-optic cable), and high-pulse power amplifier for driving the actuator up to 1,000 Hz.

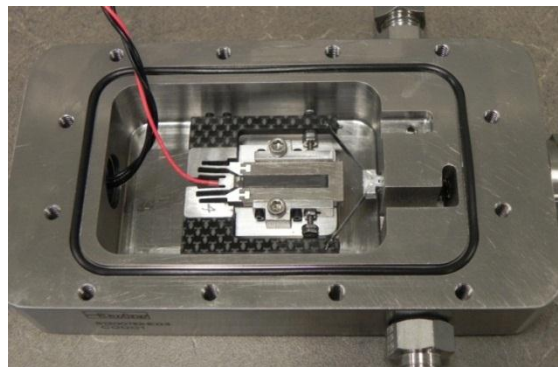

Figure 29: Photograph of piezo valve assembly (E03)

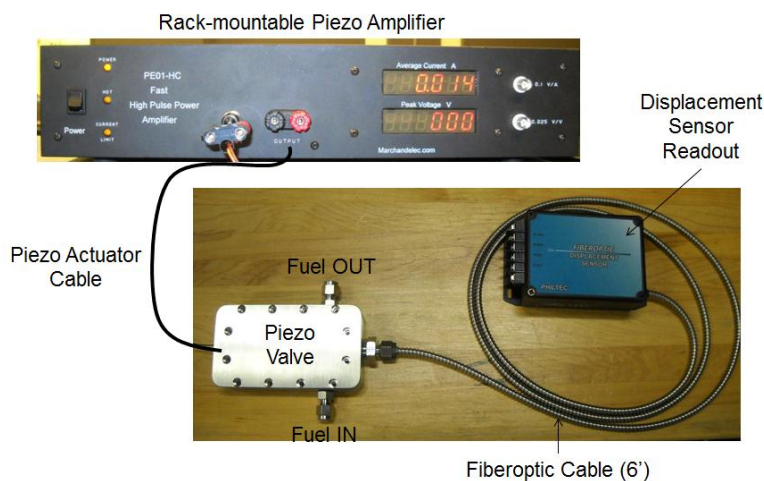

Figure 30: Complete piezo valve system

7.3 Valve Performance

This section summarizes the performance validation measurements performed by Parker during ERA valve development, along with the associated experimental results. The E03 valve has been verified to meet target requirements for bandwidth and modulation authority. However, as mentioned above, operation of this piezo valve has not yet been demonstrated in combustion rig testing with Parker’s ERA fuel injector.

The first characterization testing was performed on the redesigned 2-stage piezo actuator. A standard battery of tests was performed, including: displacement vs. applied voltage, hysteresis, resonant frequency, and dynamic response to sinusoidal waveforms of varying frequency (10 to 1,000 Hz). Maximum displacement was found to be 0.019” under DC excitation, which is comparable to the output of single arm actuators with the same piezo element. Hysteresis was measured to be 10%, which is typical for piezo actuators. For the actuator alone, resonant frequency was measured to be approximately 800 Hz; resonance was reduced to 550 Hz and 450 Hz, for 0.5 g and 1 g mass loads, respectively.

Figure 31 shows the frequency response for an actuator with 0.5 g mass load, including both a predicted response curve (blue) and measured values (red dots) along with their corresponding time plots of displacement at three different frequencies: 10 Hz, 850 Hz, and 1,000 Hz. In each case, the actuator was driven with the largest allowable sine wave (85 ± 85 V). The predicted curve is calculated assuming the actuator behaves as an underdamped oscillator with a resonant frequency of 550 Hz. The measured peak-to-peak displacements are 0.018” at 10 Hz, 0.012” at 850 Hz, and 0.007” at 1,000 Hz, in good

agreement with the predicted response. Measured average displacement is 0.011". These results indicate an upper bound on the displacement range that the piezo actuator can provide across the target operating bandwidth, assuming the spool can be designed with a mass of 0.5 g, a target that was indeed met. These results confirm that the actuator can meet the 1,000 Hz operating requirement and is expected to provide up to ± 0.0035 " stroke variation at 1,000 Hz. Furthermore, the actuator should have a "flat" response up to approximately 750 Hz.

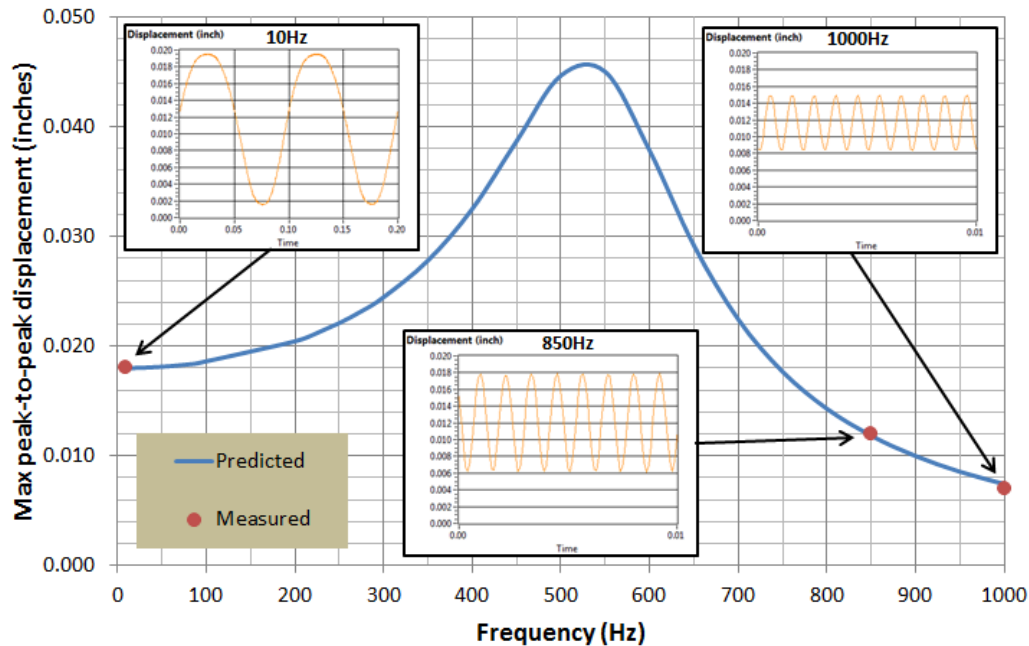

Figure 31: Frequency response of piezo actuator with 0.5 g load for 85 ± 85 V sinusoidal input

Following assembly of the E01 piezo valve, its performance was characterized on an existing Parker flow stand. The performance was investigated under both static and dynamic operating conditions, both in a valve-only configuration (discharging directly to atmosphere) and in series with a downstream orifice restrictor of flow number approximately equal to that of the injector primary tip. The majority of the flow tests were performed with MIL-PRF-7024 test fluid at 80°F at an inlet pressure of approximately 100 psig. Mass flow rate was measured with a Coriolis flow meter, fluid pressures upstream (P1) and downstream (P2) of the valve were measured with Druck transducers, and spool position (i.e., valve stroke) was measured *in situ* with a Philtec fiberoptic non-contact sensor. A LabView DAQ system was utilized to apply analog waveforms to the valve actuator and acquire measurement data in real time.

Figure 32 shows a graph of flow number vs. valve stroke under static operating conditions. For each value of stroke, the flow numbers of the valve, the orifice, and the series combination of the two were

calculated based on measured flow rate and associated pressure drops. The valve exhibits linear increase in flow number beyond an initial 0.005” deadband. The orifice flow number is relatively constant, as expected. The assembly response can be used to predict average flow number and modulation authority under dynamic operation. For example, if the valve is operated at an average stroke of 0.010” with a dither amplitude of 0.003”, the modulation authority will be based on the flow numbers at 0.007” (i.e., minimum) and 0.013” (maximum) stroke. The mean dynamic flow number can be determined by integrating the curve between these two stroke values; note that due to the asymmetry of the curve, this mean flow number will be slightly different than the flow number at the average of the two stroke extremes (i.e., 0.010” in this example).

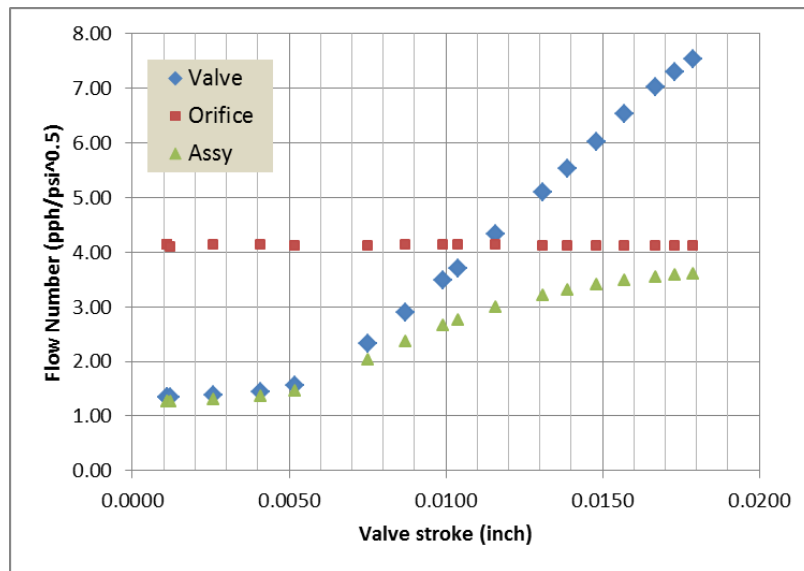

Figure 32: Graph of flow number as a function of E01 valve stroke

Figure 33 shows the frequency response of the valve actuator when driven from rail to rail (i.e., 0 to 170 V) with a sinusoidal input. Note that the voltage amplitude was reduced at 500 Hz and 600 Hz so as not to overdrive the actuator near its resonance frequency. Note also that the actuator is capable of providing 0.006” peak-to-peak stroke at 1,000 Hz, consistent with earlier actuator measurements, which will be sufficient to produce at least 10% modulation authority.

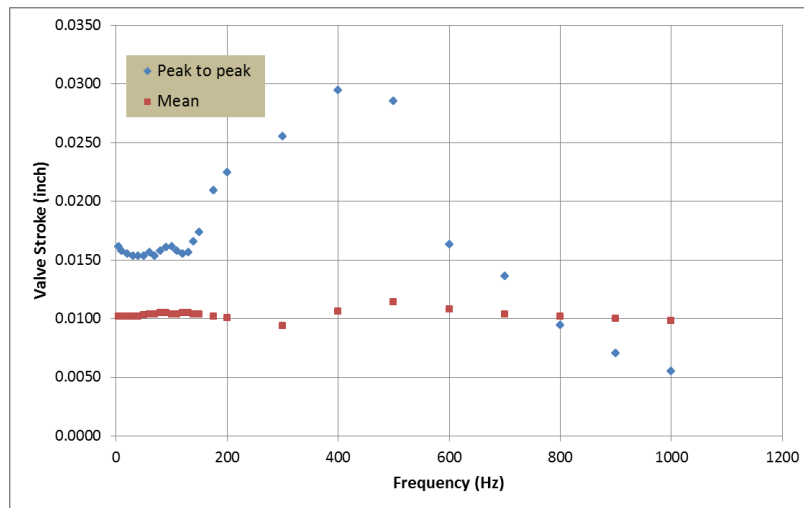

Figure 33: Measured frequency response of piezo valve actuator

Based on the positive results from the E01 valve prototype testing, the E03 valve was designed and built, and then characterized using the same testing approach as described previously for both the static and dynamic tests. As before, most testing was performed at a nominal inlet pressure of 100 psig based on the range of the available pressure transducers, although the valve is rated for 650 psig inlet pressure. Performance at higher inlet pressures should be substantially the same because the spool is pressure-balanced.

Figure 34 shows the results of the static measurements (circles), overlaid onto the predicted performance (solid lines). The predicted response was calculated based on the geometry of the metering slot, deadband, leakage flow (determined by earlier experimental measurements), and estimated Cd. Note the excellent correlation between measured and predicted response, except at low displacements. In this range, flow is minimal and small measurement errors in pressure translate to relatively large errors in the calculated flow number. The valve response is linear, as expected; also, per the design intent, at higher displacement values, the pressure drop across the valve is minimal and the series flow number is approximately equal to the tip flow number.

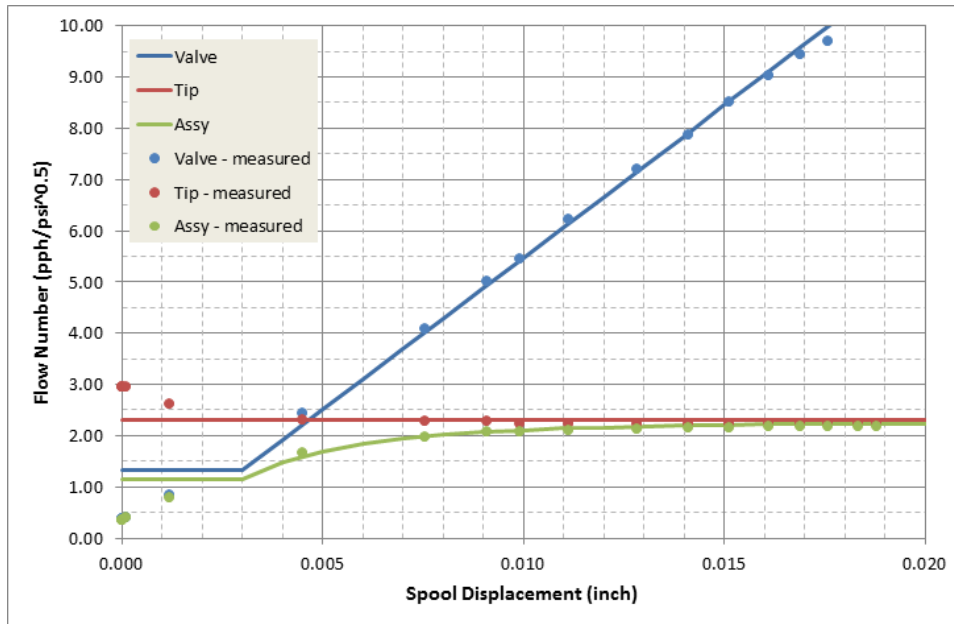

Figure 34: Graph of flow number as a function of spool position under static operation, including both measured and predicted responses

Dynamic operation was characterized following the static measurements. As before, the piezo actuator was driven with a sinusoidal waveform; in most cases the mean voltage was set to mid-range amplitude of 85 V. At low frequencies the actuator provides 0.015” peak-to-peak displacement around a mean value of 0.011”. At 1,000 Hz the actuator is capable of providing 0.008” peak-to-peak variation around a mean value of 0.012”; this can also be seen in Figure 35, which shows a snippet of the time response of measured spool position under 1,000 Hz excitation.



Figure 35: Time response (in seconds) of spool position under a 1,000 Hz excitation

Mean flow number was measured across a frequency range from 5 Hz to 1,000 Hz. Note that the coriolis mass flow meter cannot respond fast enough to measure instantaneous flow under dynamic

excitation, thus it only reports time-averaged flow rate. Valve modulation was therefore confirmed by monitoring the pressure and displacement signals, both of which responded sufficiently fast across the measured range of frequencies.

The valve modulation authority at 1,000 Hz is estimated to be 11%, which meets the target authority for this program. The modulation authority can be substantially higher than 11% at lower frequencies since a larger peak-to-peak displacement variation can be produced by the piezo actuator. With closed-loop control of the valve based on in-situ displacement monitoring, achieving a “flat” response across the entire frequency range is possible (although not demonstrated under the scope of this effort).

Parker has completed assembly and validation testing of a second identical E03 valve for delivery to NASA, and will support installation and operation in CE-5 (or another NASA rig) as needed when a test window opens.

8 Conclusions

In this project, Parker delivered new LDI fuel injectors based on Parker's 3ZI technology along with high-speed fuel valves capable of both fuel trim function and modulation of fuel flow for control of combustion dynamics. All combustion hardware was delivered on time under a program plan that was accelerated on request from NASA. Atmospheric combustion experiments demonstrated the excellent ignition and LBO performance of the 3ZI. Emissions obtained with the first 3ZI variant tested at high pressure were almost on target for the ERA project, demonstrating 69% reduction in emissions from CAEP/6. A second variant awaits testing and is expected to show still further reduction in emissions. The high speed valve was demonstrated in laboratory tests to deliver the desired fuel modulation amplitude at the target 1,000 Hz frequency, and has been delivered to NASA for implementation in the pending high pressure combustion testing of the E04 3ZI.

In addition to demonstrating excellent emissions performance, the Parker 3ZI design has proven to be highly capable with respect to the desired thermal and mechanical characteristics of a field-worthy injector. Furthermore, the concept has inherent flexibility and offers a clear path forward to further reduce emissions at both high and low thrust settings as well as optimized operability at low power settings. Specifically, performance can be improved through modification of the atomizer flow numbers and through optimization of the atomizer insertion depth in each spray cup, the swirl number of the spray cups, the size of the individual spray cups, as well as by employing new innovative cup designs and staging schemes. The injector is also highly scalable offering an opportunity to employ the same injector concepts to vastly different engine sizes.

The inherent design flexibility of the 3ZI concept makes it a very capable technology for current and future aviation gas turbine engines. In particular, the 3ZI technology has a promising path forward to application in future high pressure ratio engines where auto ignition and flash back will prove a major challenge for conventional low emissions combustion technology. Parker looks forward to realizing these improvements in the next generation of hardware in support of the N+3 program.

References

- [1] Tacina, R, Wey, C, Laing, P, A. Mansour, 2001, "*A Low NO_x Lean-Direct Injection, Multipoint Integrated Module Combustor Concept for Advanced Aircraft Gas Turbines*", Clean Air Conference, Porto, Portugal.
- [2] Tacina, R, Wey, C, Laing, P, A. Mansour, "*Sector Test of A low NO_x, lean Direct Injection Multipoint Integrated Module Combustor Concept*", Paper 2002-GT-30089, ASME: Turbo Expo 2002, Amsterdam, The Netherlands.
- [3] Tacina, R., Mansour, A., Partelow, L. and Wey, C, "Experimental Sector and Flame-Tube Evaluations of a Multipoint Integrated Module Concept for Low Emission Combustors" Paper 2004GT-53263, ASME: Turbo Expo 2004, Vienna, Austria.

