

High Performance Torso Cooling Garment

Bruce Conger,¹
Jacobs, Houston, Texas, 77058

and

Janice Makinen²
NASA Johnson Space Center, Houston, Texas, 77058

The concept proposed in this paper is to improve thermal efficiencies of the liquid cooling and ventilation garment (LCVG) in the torso area, which could facilitate removal of LCVG tubing from the arms and legs, thereby increasing suited crew member mobility. EVA space suit mobility in micro-gravity is challenging, and it becomes even more challenging in the gravity of Mars. By using shaped water tubes that greatly increase the contact area with the skin in the torso region of the body, the heat transfer efficiency can be increased. This increase in efficiency could provide the required liquid cooling via torso tubing only; no arm or leg LCVG tubing would be required. Benefits of this approach include increased crewmember mobility, enhanced evaporation cooling, increased comfort during Mars EVA tasks, and easing of the overly dry condition in the helmet associated with the Advanced Extravehicular Mobility Unit (EMU) ventilation loop currently under development.

This report describes analysis and test activities performed to evaluate the potential improvements to the thermal performance of the LCVG. Analyses evaluated potential tube shapes for improving the thermal performance of the LCVG. The analysis results fed into the selection of flat flow strips to improve thermal contact with the skin of the suited test subject. Testing of small segments was performed to compare thermal performance of the tubing approach of the current LCVG to the flat flow strips proposed as the new concept. Results of the testing is presented along with recommendations for future development of this new concept.

Nomenclature

<i>AEMU</i>	=	Advanced Extravehicular Mobility Unit
<i>Btu</i>	=	British thermal units
<i>EMC</i>	=	Evolvable Mars Campaign
<i>EMU</i>	=	Extravehicular Mobility Unit
<i>EVA</i>	=	extravehicular activity
<i>HAT</i>	=	Human Space Flight Architecture Technology
<i>HITL</i>	=	Human-in-the-Loop
<i>hr</i>	=	hour
<i>ICA</i>	=	Innovation Charge Account
<i>ISS</i>	=	International Space Station
<i>IVA</i>	=	intravehicular activity
<i>JSC</i>	=	Johnson Space Center
<i>min</i>	=	minute
<i>PLSS</i>	=	portable life support subsystem

¹ Engineering Analysis Lead, Thermal and Environmental Analysis, 2224 Bay Area Blvd./JE-5EA.

² Aerospace Technologist, Thermal Systems Branch, Crew and Thermal Systems Division, 2101 NASA Parkway/EC6

I. Introduction

This document presents results of analysis and testing of the innovation to improve thermal efficiencies of the space suit liquid cooling and ventilation garment (LCVG). This effort was funded by a NASA Johnson Space Center Innovation Charge Account (ICA) program during the period of June through October of 2015.

Extravehicular activity (EVA) space suit mobility in micro-gravity is a significant challenge and in the gravity of Mars, improvements in mobility will enable the suited crew member to efficiently complete EVA objectives. The idea proposed is to improve thermal efficiencies of the LCVG in the torso area in order to free up the arms and legs by removing the liquid tubes currently used in the International Space Station (ISS) EVA suit in the limbs. By using shaped water tubes that greatly increase the contact area with the skin in the torso region of the body, the heat transfer efficiency can be increased to provide the entire liquid cooling requirement and increase mobility by freeing up the arms and legs. Additional potential benefits of this approach include enhanced evaporative cooling, increased comfort during Mars EVA tasks, and easing of the overly dry condition in the helmet associated with the Advanced Extravehicular Mobility Unit (EMU) ventilation loop currently under development (see **Error! Reference source**



Figure 1. The High Performance Mars Liquid Cooling and Ventilation Garment has a goal of enhancing the EVA experience on Mars and in many other applications

not found.).

A. Anticipated Benefits and Potential Applications

Increased mobility and comfort during EVA are the key benefits of this technology. If adopted, this technology would benefit current EVA's being performed at the International Space Station. Increased EVA space suit mobility and comfort during EVA will be of even greater importance with Mars EVA's considering the added workloads and carry weight associated with the gravity of Mars. Increased intravehicular activity (IVA) space suit mobility and comfort are also possible with this technology. If adopted, this technology would benefit space suits that support commercial high altitude and space flights.

Non-space applications of this technology are also possible. Military personnel and fire-fighters working in hot environments may benefit from the increased cooling efficiencies offered by this technology. Potential uses could also include any application where people are working in warm environments with the benefit of reduced occurrences of the heat-related human error and injuries including heat stress and heat stroke. Medical conditions that require cooling of the body may also benefit from this technology.

B. How Mars LCVG Innovation Relates to NASA Goals

EVA capabilities need to be robust to enable and achieve certain Evolvable Mars Campaign (EMC) goals including development of technologies that can evolve with the EMC missions and lead to an eventual landing on Mars. Also, Human Space Flight Architecture Technology (HAT) performance targets include improvements to the

Mars surface space suit to help offset the increased crew member workloads associated with EVA's performed in the Mars gravitational environment

The high efficiency LCVG approach has the potential to significantly improve suit mobility and comfort associated with the LCVG. Also, with an anticipated increase in evaporative cooling, over drying of the helmet inlet gas experienced in the current Advanced EMU ventilation loop (under development) may be mitigated. If LCVG efficiencies are significantly improved, the water temperature within the LCVG can be raised, and this could also lead to a reduction in the size of the suit cooling unit. To show whether this high efficiency approach will provide the anticipated increase in LCVG heat transfer efficiencies, sample LCVG sections are being built up and tested against sections representing the current LCVG water tube configuration.

C. Description of Innovation Charge Account Activities

Analysis and test activities were performed to evaluate the potential improvements to the thermal performance of the LCVG during this ICA effort. Analysis was performed to evaluate potential tube shapes for improving the thermal performance of the LCVG. The analysis results fed into the selection of flat flow strips to improve thermal contact with the skin of the suited test subject. Testing of the proposed tube design versus the current LCVG tubing design was performed using a human analog test rig. ICA testing of small segments was performed to compare thermal performance of the tubing approach of the current LCVG to the flat flow strips proposed as the new concept.

II. Analysis and Selection of Test Article Design Concept

The heat transfer capability of various tube shapes were investigated to aid the selection of the tube configuration to be tested as part of this ICA effort. Results indicated that the flat rectangular tube configuration shown in **Error! Reference source not found.** should provide significantly higher heat transfer rates from the skin to the cooling water transported through the tubes.

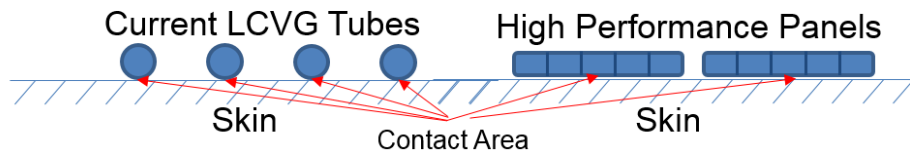

Figure 2. The tube configuration for the high performance panels (right) provide much greater surface contact with the skin and greater heat transfer capacity than the current LCVG tube configuration (left).

A rough concept of the vest configuration of the high performance LCVG concept based on the selected flat strip flow channels is shown in **Error! Reference source not found.**. In this concept, no water tubes or channels are required in the arms or legs; all of the cooling is accomplished in the torso region of the body. It is envisioned that the vest will be fully adjustable to ensure good fit in all portions of the vest. Lacing or straps assumed to be placed in the front of the vest for easy access are possible implementations that could accomplish the adjustment function.



Figure 3. The high performance LCVG concept provides all of the required cooling in the torso region of the body

Based on the results of the ICA analysis described above, test articles were developed to investigate the potential improvement in heat rejection of the flat strip flow channels as compared to the ISS EMU LCVG tubes currently in use. Eight inch by eight inch testing sections were developed in order to be tested on a flat hot plate that would simulate heat coming from the skin. One test article was developed to represent the tube geometry of the current ISS EMU LCVG. This test article has 9 tubes (1/8" OD and 1/16" ID, 1/32" wall thickness) spaced 1 inch apart (see **Error! Reference source not found.**). This spacing is based on an estimated average overall tube spacing of the current LCVG. The body area covered by the LCVG is estimated to be 1.776 square meters (19.1 ft²)¹ and the total length of tubing in an average sized EMU LCVG is 250 feet³ yielding a tube length to covered body area ratio of 13.1 ft/ft². Given that the test article is 8 in by 8 in or 64 in² (0.444 ft²), the total length of tubing targeted for this test article is 0.444 ft² * 13.1 ft/ft² or 5.8 ft. Since each tube is 8 inches (0.667 ft) long, the resulting calculation of 5.8 ft / 0.667 ft or 8.7 tubes was rounded off to the final design of 9 tubes.

The second test article represents the flat strip flow channel approach being recommended for the new concept. This test article has 1 13/16" inch width strips with flow channels 1/16" high and a wall thickness of 1/32" as shown in **Error! Reference source not found.**. CAD models of the test article concepts were developed and printed with a 3-D printer in order to produce functioning units that hold water and transfer heat similar to actual cooling garments. The 3-D printed test articles are shown in **Error! Reference source not found.** and **Error! Reference source not found.**

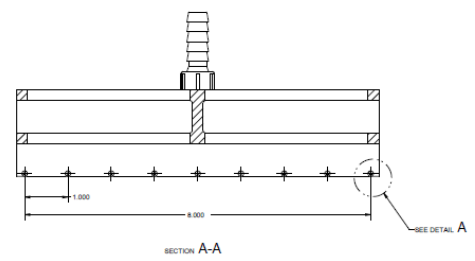
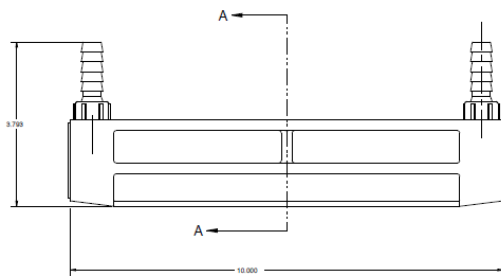
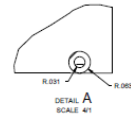
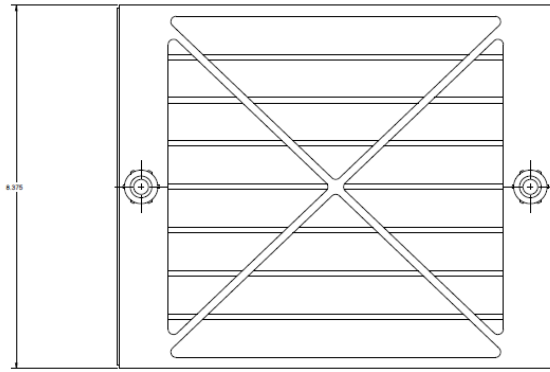

Figure 11. Dimensions of Test Article #1 – Simulating current LCVG tube layout.

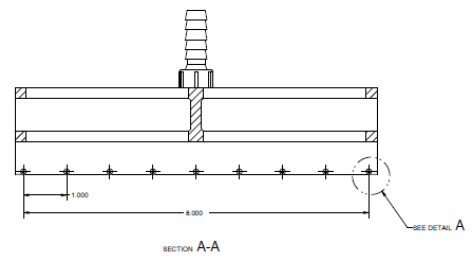
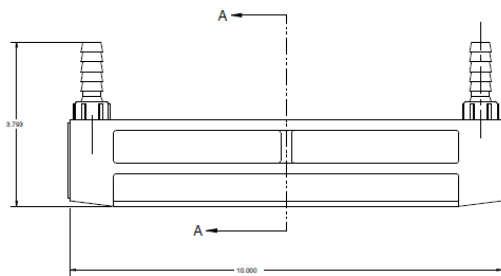
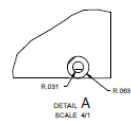
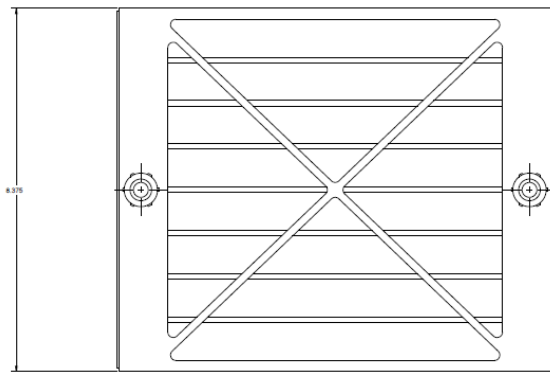

Figure 11. Dimensions of Test Article #2 – flat strip flow channels.

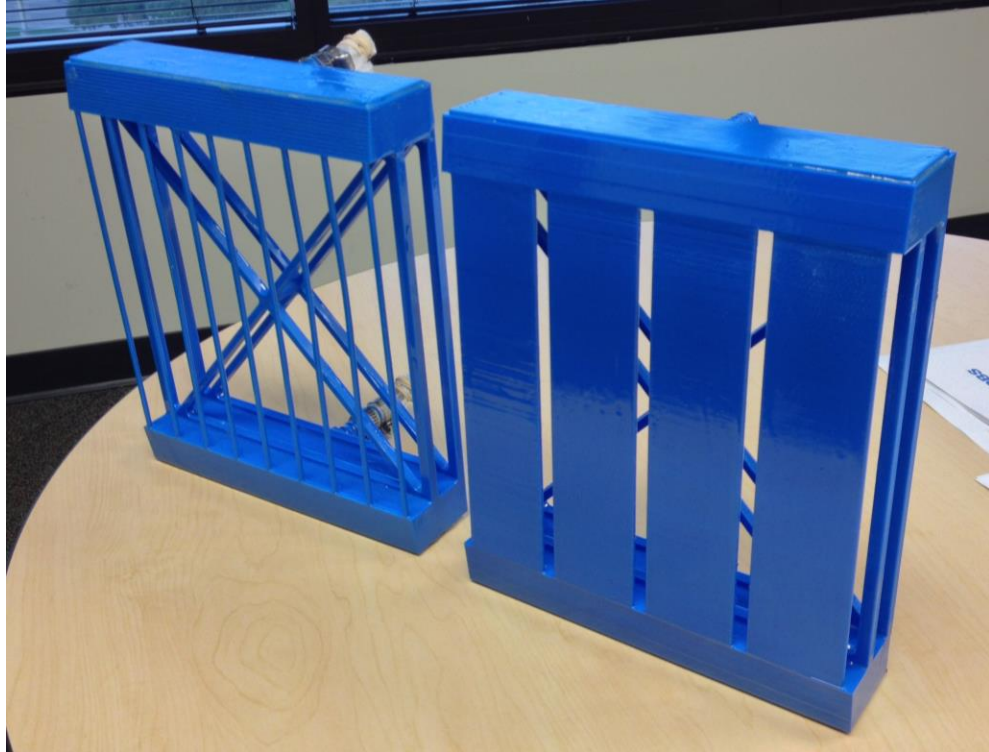

Figure 11. Test article surface that would sit on the hot plate is facing the reader in this view.



Figure 11. Test article surface that would sit on the hot plate is facing away from the reader in this view and the barbed fittings representing the inlet and outlet ports of the test articles are facing the reader.

III. Testing

Testing was performed in the JSC Building 7 Portable Life Support System (PLSS) Lab (room 2005) during September, 2015.

A. Test Setup

The test articles discussed above were connected to a chiller cart set up in the PLSS Lab (see **Error! Reference source not found.**). The chiller cart delivered water at approximately 50 °F, the temperature that the Advanced PLSS is currently targeting for delivery to the LCVG. One thermistor was placed at the inlet to the test article and another thermistor was placed at the water outlet from the test article (see **Error! Reference source not found.**). The thermistors were placed inside of the tubing leading to and from the test article in order to obtain an accurate reading of the water temperature at these locations.

A hot plate (NuWave PIC Gold Induction Cooktop, NuWave, LLC.) that could be controlled to temperatures of 100 °F and higher in 10 °F increments was used to control the temperature of a skin simulant material (EasyLiner Brand Shelf Liner – solid white distributed by Shurtech Brands, LLC). A cast iron pan was used between the hot plate and the test article since the induction cooktop requires a steel or iron based pan to enable the magnetic fields produced by the cooktop to generate heat. Also, a thin black foam insulating material and an aluminum plate was placed on top of the tubes for both test articles to provide some weight on the tubes to improve the contact between the tubes and the skin simulant material. One thermocouple was placed on the simulated skin surface and a second thermocouple was placed on the water tube of the test article as shown in **Error! Reference source not found.**. Flow rates were measured by periodically directing the outlet water flow into a graduated cylinder and timing the rate that the cylinder was being filled provided the flow rate information. With temperature information at the test article water inlet and outlet along with the flow rate information, the amount of heat being transferred from the simulated skin to the water in the test article can be calculated.

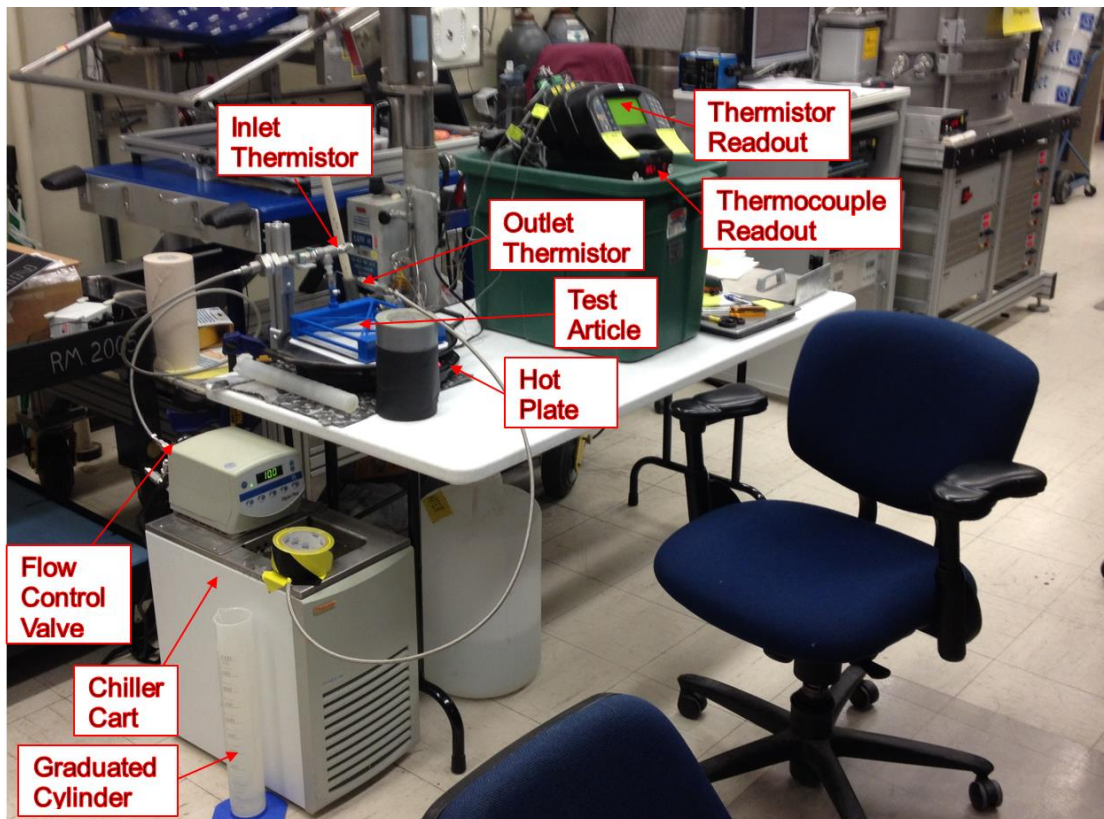

Figure 12. Test setup in Room 2005 of JSC Building 7

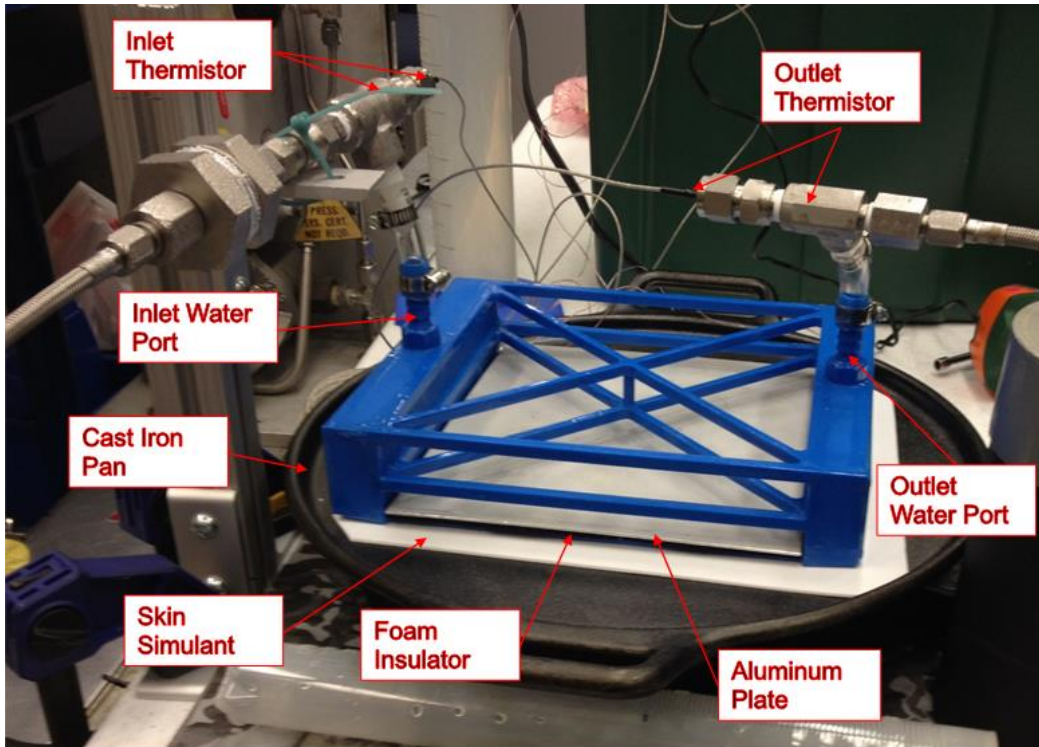

Figure 12. Temperature sensors include 2 water insertion thermistors with one at the inlet to the test article and one at the outlet of the test article. The white skin simulant material, foam insulator and aluminum plate are also shown in this figure.

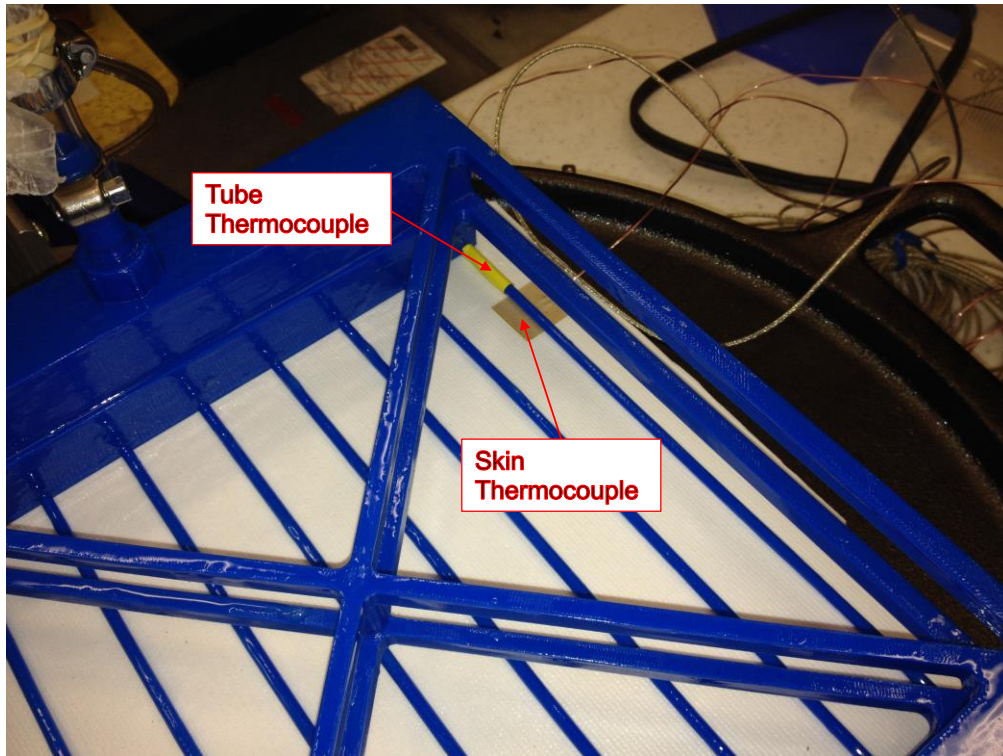

Figure 12. Two thermocouples were used in this test, one on the skin simulant under the tube and the 2nd thermocouple on the tube itself (yellow tape is covering the tube thermocouple; also foam insulator and aluminum plate were removed for clarity in this picture).

B. Testing Procedure

Test points were run in the PLSS Lab on September 16th and 17th. Once the test article was connected to the chiller cart tubing, the instrumentation and chiller cart were turned on. Flow was adjusted to 40 to 50 ml per 10 second intervals for the majority of the test trials. This flow rate for test article #1 results in a flow rate per tube that is approximately equal to the flow per tube in the current LCVG when used with the Advanced PLSS. The Advanced PLSS water loop flow rate is currently 200 lb/hr (or 1512 ml/min in terms of volumetric flow of water at 50 °F) and there are 48 tubes in the current EMU LCVG. This results in a flow of 31.5 ml/min per tube and since the test article #1 is made up of 9 tubes, the equivalent flow to the test article is 283.5 ml/min or 47.3 ml every 10 seconds. Test articles #1 and #2 were tested with targeted flow rates of 40 to 50 ml per 10 second intervals. Since the test article #2 represents a flow configuration that is proposed to be used only in the torso as opposed to the current LCVG which flows over the torso, the arms, and the legs, a higher flow rate per skin area covered is also reasonable. Therefore, for test article #2, a second set of test points were run at a much higher flow rate (140 to 150 ml per 10 second interval).

For each test trial, the water flowing back to the chiller cart was diverted to a graduated cylinder and the flow rate was determined by timing the rate at which the graduated cylinder was filled. Care was taken to ensure that the water tube was kept at the same elevation while filling the graduated cylinder as it was when flowing into the chiller cart water bath. This was done to keep the flow rate and pressure drop of the chiller cart test loop constant so that the measured flow rate was the same as the flow rate experienced during the test trials.

Once the water chilled down, infrared camera images were taken to show that chilled water was flowing through all of the water flow tubes of the test articles. **Error! Reference source not found.** shows the infrared images taken that indicate that all 9 tubes of test article #1 are flowing chilled water (blue indicating cool temperature) and that the 4 flat strip channels of test article #2 are also flowing chilled water.

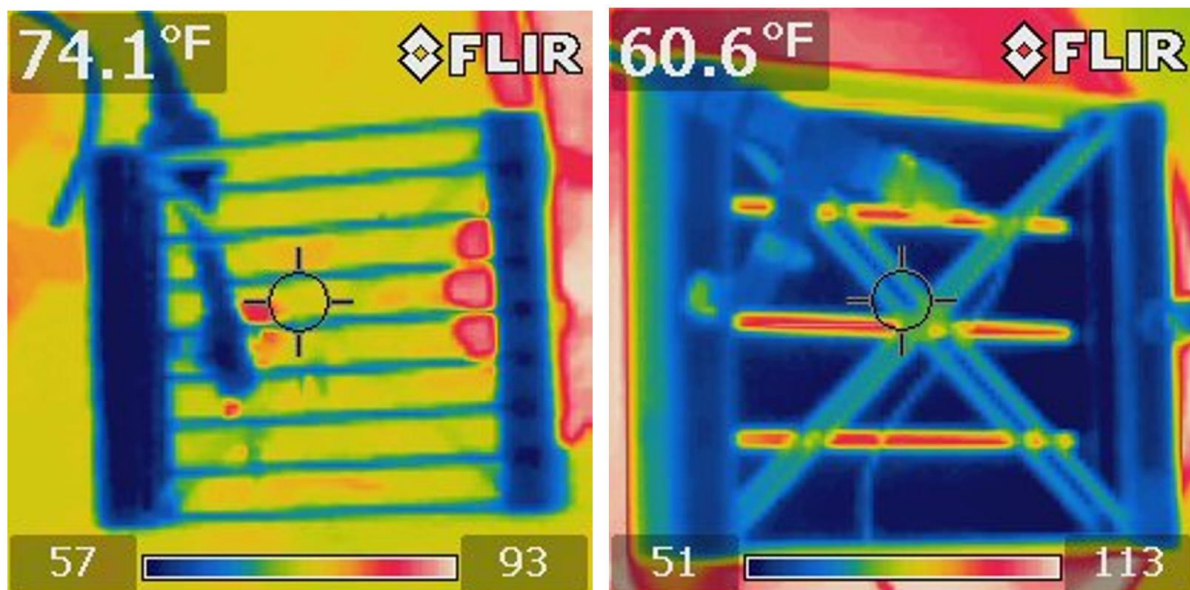

Figure 12. Infrared images of test article #1 (left) and test article #2 (right) indicate that all flow passages are flowing chilled water.

C. Test Results

Table 4.1 includes the temperature and flow rate results for the test points run with test articles #1 and #2. A calibration was performed on the morning of September 17th. Thermocouple #2 was determined to be 0.1 F cooler than thermocouple #3. Also, thermistor #1 was found to be 0.37 F cooler than thermistor #2. All of the temperature measurements shown in Table 4.1 were adjusted to correct for these offsets.

The test results shown in Table 4.1 were used to calculate heat transferred from the simulated skin to the water with the equation $Q = \dot{m} * C_p * (T_{out} - T_{in})$ where Q is the heat transferred to the water, \dot{m} is the water mass flow rate, C_p is the heat capacity of water, T_{out} is the test article outlet water temperature, and T_{in} is the test article inlet water temperature. The calculated heat transfer results for each test trial are also shown in Table 4.1. The

average heat transferred for all of the test article #1 trials was 61.0 Btu/hr and the average for all of the test article #2 trials was 214.0 Btu/hr.

The flow rates for test article #1 decreased as the test trials progressed even though the flow control valve was left in the wide open position for all of the test article #1 trials. It is not known what caused the decrease in flow rate for test article #1. As a result, the highest flow rate for test article #1 was 52 ml per 10 seconds. The test trial for test article #2 that comes closest to matching this flow rate is trial #3. In this trial, the heat removed is 216 Btu/hr which is approximately 2.7 times the heat transfer removed by test article #1 (81.3 Btu/hr) at the similar flow rate of 52 ml per 10 seconds mentioned above.

The results above show an approximate heat transfer improvement for the test article #2 compared to test article #1 ranging from a factor of 2.7 to 3.5. The EMU LCVG used in a 1992 Segmented Liquid Cooled Garment test had a skin area distribution of 44.6, 38.9, and 16.5 percent in the torso, legs, and arms respectively.² Assuming this skin area distribution, a torso-only LCVG configuration would need to remove a minimum of 100/44.6 or a factor of 2.24 times the heat removal capability of the EMU LCVG on an equivalent area basis. Since the test article #2 (flat strip flow channel configuration) performed 2.7 to 3.5 times better than the test article #1 (representing the EMU LCVG configuration), there is some expectation that it may be possible for the torso-only LCVG with the flat strip flow channel configuration to remove heat from the body at levels equal to or greater than that removed by the current EMU LCVG. Human heat transfer characteristics are much more complicated than those of the testing performed with the ICA investigation. Therefore, human testing with a prototype torso-only LCVG with the flat strip flow channel configuration is recommended.

Figure 4.5 and Figure 4.6 show the dependency of test article heat transfer rates on simulated skin temperature and flow rate respectively. These figures indicate that heat transfer rates for test article #1 increase with increasing simulated skin temperature and with increasing flow rate. Test article #2 does not show significant dependency on either simulated skin temperature or on flow rate. Since skin temperature and flow rate were not varied independently, additional investigations into these dependencies are recommended. In general, however, test article #2 removes significantly more heat than test article #1 over a range of simulated skin temperatures and flow rates.

Table 1. Corrected Test Temperatures, Flow Rates, and Heat Transfer Results

Test Article #	Test Point #	Trial #	Flow (ml in 10 sec)	Temperature (°F)				Mass Flow (lb/hr)	Heat Transferred (Btu/hr)
				Water Inlet	Water Outlet	Skin	Tube		
1	1	1	52	51.68	53.65	91.1	69.9	41.2	81.3
1	1	2	41	51.74	53.47	86.5	68.2	32.5	56.3
1	1	3	38	51.81	54.03	90.3	69.8	30.1	66.9
1	1	4	38	52.01	54.30	89	69.5	30.1	69.0
1	2	1	25.6	52.87	55.53	81.5	66.5	20.3	54.0
1	2	2	25.6	52.96	55.54	81	66.4	20.3	52.4
1	2	3	23.8	52.9	55.39	79.1	65.6	18.9	47.0
Average Heat Transfer Test Article #1									61.0
2	1	1	Low	n/a	n/a	n/a	n/a		
2	1	2	40	n/a	59.12	82.3	n/a		
2	1	2	40		59.16	82.1		31.7	
2	1	2	40	52.19	59.08	79.9	76.4	31.7	218.6
2	1	3	50	51.79	57.26	81.3	78.5	39.7	216.9
2	1	3	50	51.8	57.23	81.4	78.4	39.7	215.4
2	2	1	150	50.65	52.64	84.5	80.9	119.0	236.8
2	2	1	150	50.65	52.56	83.2	79.9	119.0	227.3
2	2	2	140	50.66	52.66	83.4	79.3	111.0	222.2
2	2	2	140	50.66	52.54	82.3	79.4	111.0	208.8
2	2	3	140	50.65	52.56	82.7	79.3	111.0	212.2
2	2	3	140	50.66	52.54	82.9	79.1	111.0	208.8
2	2	4	140	50.73	52.47	83.7	75.8	111.0	193.3
2	2	4	140	50.71	52.45	83.6	76.5	111.0	193.3
Average Heat Transfer Test Article #2									214.0

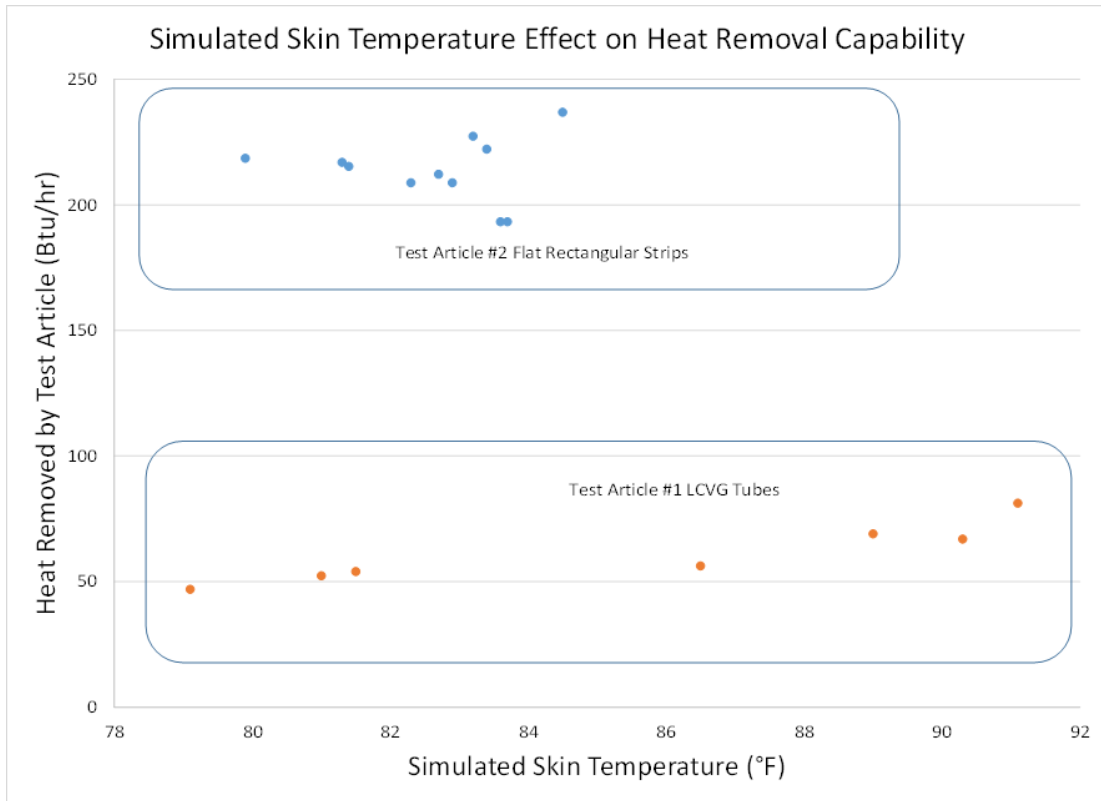

Figure 12. Dependency of heat transferred on simulated skin temperature.

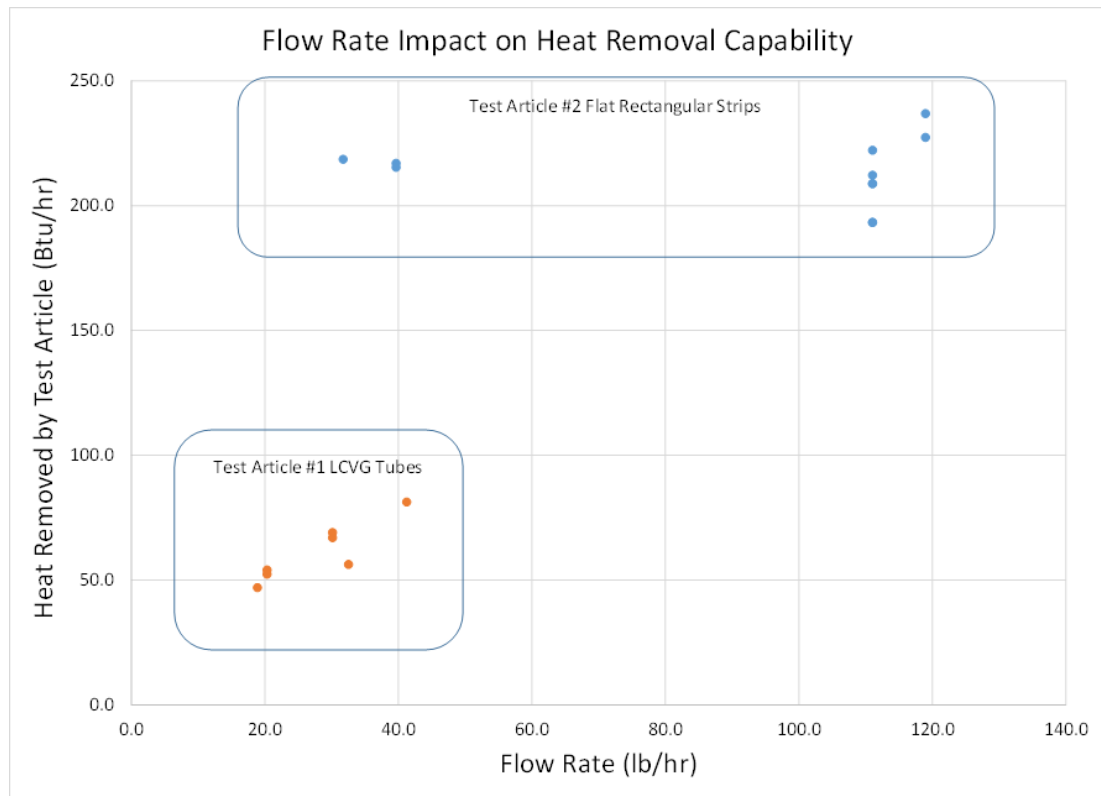

Figure 12. Dependency of heat transfer on flow rate through the test articles.

IV. Conclusions and future work

This investigation has shown that the proposed flat strip flow channels have the potential to remove significantly higher heat loads from the skin than the current LCVG on a per area basis. Test articles were designed and built representing the proposed flat strip flow channels and the current LCVG tube geometry respectively. Results indicated that the proposed geometry test article removed between 2.7 and 3.5 times the amount of heat as compared to the test article representing the current LCVG tube geometry. This indicates that it may be possible to remove the same amount of total heat from the body in the torso area only as compared the amount of heat removed by the EMU LCVG that currently covers the torso, the arms and the legs.

Even though this investigation suggests the new cooling garment tube geometry is more efficient than the LCVG tube geometry, the testing has limitations. Human thermal responses are complex and were not part of this investigation. Skin temperatures were simulated but the effects of blood flow interactions with heat transfer at the skin were not evaluated. Evaporation of sweat is another heat transfer mechanism occurring at the skin and this effect was also not simulated.

The positive results from this investigation indicate that further development and testing are recommended to determine whether the approach will be effective as proposed. It is recommended that a cooling garment prototype be produced and tested with human test subjects and compared to the performance of the current LCVG under the same conditions.

Acknowledgments

The authors of this paper would like to thank the following for their significant efforts to enable the success of this investigation: Matt Vogel for providing guidance and performing thermal performance analysis on the various tube shapes; Ross Harold for generating the CAD design and running the 3-D printing process for the test articles; Alan Bell for performing the water-proofing coating process; David Westheimer for providing invaluable test lab resources, Bryan Kanne for patching the test articles to eliminate leaks; Walt Vonau for providing review of the assessment and report; Cinda Chullen for guidance on the ICA process; and finally NASA for providing the funding through the Innovation Charge Account program..

References

¹Nyberg, K., "Design and Evaluation of Automatic Control for Human / Liquid Cooling Garment Thermal Interaction," University of Texas at Austin Ph.D. Dissertation, Austin, TX, August 1998.

²Smith, G., Pantermuehl, J., "Segmented Liquid Cooled Garment Final Test Report", CTSD-ADV-032, NASA Johnson Space Center, Houston, TX, 15 June 1992.

³Vogel, M., Ross, A., "Integrated Portable Life Support System 2.0/Human-in-the-Loop (PLSS 2.0/HITL) Summary Test Report," EM-PEM-15-0002, NASA Johnson Space Center, Houston, Texas, 14 May 2015.