

NASA/TP-2015-217532



International VLBI Service for Geodesy and Astrometry 2014 Annual Report

Karen D. Baver, Dirk Behrend, and Kyla L. Armstrong

National Aeronautics and
Space Administration

**Goddard Space Flight Center
Greenbelt, Maryland 20771**

July 2015

NASA STI Program ... in Profile

Since its founding, NASA has been dedicated to the advancement of aeronautics and space science. The NASA scientific and technical information (STI) program plays a key part in helping NASA maintain this important role.

The NASA STI program operates under the auspices of the Agency Chief Information Officer. It collects, organizes, provides for archiving, and disseminates NASA's STI. The NASA STI program provides access to the NASA Aeronautics and Space Database and its public interface, the NASA Technical Report Server, thus providing one of the largest collections of aeronautical and space science STI in the world. Results are published in both non-NASA channels and by NASA in the NASA STI Report Series, which includes the following report types:

- **TECHNICAL PUBLICATION.** Reports of completed research or a major significant phase of research that present the results of NASA Programs and include extensive data or theoretical analysis. Includes compilations of significant scientific and technical data and information deemed to be of continuing reference value. NASA counterpart of peer-reviewed formal professional papers but has less stringent limitations on manuscript length and extent of graphic presentations.
- **TECHNICAL MEMORANDUM.** Scientific and technical findings that are preliminary or of specialized interest, e.g., quick release reports, working papers, and bibliographies that contain minimal annotation. Does not contain extensive analysis.
- **CONTRACTOR REPORT.** Scientific and technical findings by NASA-sponsored contractors and grantees.
- **CONFERENCE PUBLICATION.** Collected papers from scientific and technical conferences, symposia, seminars, or other meetings sponsored or co-sponsored by NASA.
- **SPECIAL PUBLICATION.** Scientific, technical, or historical information from NASA programs, projects, and missions, often concerned with subjects having substantial public interest.
- **TECHNICAL TRANSLATION.** English-language translations of foreign scientific and technical material pertinent to NASA's mission.

Specialized services also include organizing and publishing research results, distributing specialized research announcements and feeds, providing help desk and personal search support, and enabling data exchange services. For more information about the NASA STI program, see the following:

- Access the NASA STI program home page at <http://www.sti.nasa.gov>
 - E-mail your question via the Internet to help@sti.nasa.gov
 - Fax your question to the NASA STI Help Desk at 443-757-5803
 - Phone the NASA STI Help Desk at 443-757-5802
-

NASA/TP-2015-217532



International VLBI Service for Geodesy and Astrometry 2014 Annual Report

Karen D. Baver (ed.)

NVI, Inc., Greenbelt, Maryland

Dirk Behrend (ed.)

NVI, Inc., Greenbelt, Maryland

Kyla L. Armstrong (ed.)

NVI, Inc., Greenbelt, Maryland

National Aeronautics and
Space Administration

**Goddard Space Flight Center
Greenbelt, Maryland 20771**

July 2015

Notice for Copyrighted Information

This manuscript has been authored by employees of the *NVI, Inc.*, with the National Aeronautics and Space Administration. The United States Government has a non-exclusive, irrevocable, worldwide license to prepare derivative works, publish, or reproduce this manuscript, and allow others to do so, for United States Government purposes. Any publisher accepting this manuscript for publication acknowledges that the United States Government retains such a license in any published form of this manuscript. All other rights are retained by the copyright owner.

Trade names and trademarks are used in this report for identification only. Their usage does not constitute an official endorsement, either expressed or implied, by the National Aeronautics and Space Administration.

Level of Review: This material has been technically reviewed by technical management

Preface

This volume of reports is the 2014 Annual Report of the International VLBI Service for Geodesy and Astrometry (IVS). The individual reports were contributed by VLBI groups in the international geodetic and astrometric community that constitute the permanent components of IVS.

The IVS 2014 Annual Report documents the work of the IVS components for the calendar year 2014, our sixteenth year of existence. The reports describe changes, activities, and progress of the IVS. Many thanks to all IVS components who contributed to this Annual Report.

With the exception of the first section, the contents of this Annual Report also appear on the IVS Web site at

<http://ivscc.gsfc.nasa.gov/publications/ar2014>

This book and the Web site are organized as follows:

- The first section contains general information about IVS, a map showing the locations of the components, information about the Directing Board members, and the annual report of the IVS Chair.
- The second section holds two special reports. The first report, “Foundation of the Asia-Oceania VLBI Group for Geodesy and Astrometry”, describes the progress towards establishing a new subgroup of the IVS, the Asia-Oceania VLBI Group (AOV), that will focus on the regional community of Asia-Oceania. Progress in 2014 has included development of Terms of Reference, election of a Chair and appointment of a Secretary, and a survey of regional resources, such as schedulers, antennas, correlators, and analysis centers. The group’s goal is to

begin the first Asia-Oceania VLBI network observations in early 2015. The activities of the AOV are expected to enhance the quality of Asia-Oceania data products and to contribute to the construction of Asia-Oceania reference frames. The establishment of the AOV is a necessary and exciting development not only for Asia-Oceania VLBI but also for the IVS. The second report, “VGOS Data Transmission and Correlation Plan”, discusses the transmission of data from IVS Network Stations to IVS Correlators and the correlation and fringe fitting of the data within the VLBI Global Observing System (VGOS). This report covers topics such as e-transfers and physical shipment of media, playback systems at the correlators, and correlator CPU and storage requirements. The report then assesses current and planned correlator resources and issues recommendations.

- The next seven sections hold the reports from the Coordinators and the reports from the IVS Permanent Components: Network Stations, Operation Centers, Correlators, Data Centers, Analysis Centers, and Technology Development Centers.
- The next section contains a compilation of publications in the field of geodetic and astrometric VLBI during 2014.
- The final section provides reference information about IVS. Following the current version of the IVS Terms of Reference, a reference table is provided with links to the IVS Member and Affiliated organizations, the IVS Associate Members, and the IVS permanent components.

Table of Contents

Preface	iii	Metsähovi Radio Observatory Network Station 2014 Annual Report	83
About IVS	1	VERA 2014 Geodetic Activities	87
IVS Organization	2	Noto Station Status Report	90
IVS Component Map	4	Ny-Ålesund Geodetic Observatory 2014 Annual Report	92
IVS Directing Board	6	German Antarctic Receiving Station (GARS) O'Higgins	95
IVS Chair's Report	8	Onsala Space Observatory – IVS Network Station Activities during 2014	98
Special Reports	9	Parkes 2014 IVS Report	102
VGOS Data Transmission and Correlation Plan ...	11	Korea Geodetic VLBI Station, Sejong	103
Foundation of the Asia-Oceania VLBI Group for Geodesy and Astrometry	20	Shanghai Station Report for 2014	106
IVS Coordination	27	Simeiz 22-m Radio Telescope as an IVS Network Station	109
Coordinating Center Report	29	Svetloe Radio Astronomical Observatory 2014 IVS Annual Report	113
Analysis Coordinator Report	32	JARE Syowa Station 11-m Antenna, Antarctica .	116
Network Coordinator Report	35	Last Year of Operation of the TIGO VLBI Station in Concepción	120
IVS Technology Coordinator Report	41	Tsukuba 32-m VLBI Station	124
Network Stations	45	Nanshan VLBI Station Report 2014	128
Badary Radio Astronomical Observatory 2014 IVS Annual Report	47	New Zealand VLBI Station, Warkworth	130
Effelsberg Radio Observatory 2014 Annual Report	50	Westford Antenna 2014 Annual Report	134
Fortaleza Station 2014 Annual Report	53	Geodetic Observatory Wettzell - 20-m Radio Telescope and Twin Telescopes	137
Goddard Geophysical and Astronomical Observatory	56	Instituto Geográfico Nacional of Spain	141
Hartebeesthoek Radio Astronomy Observatory (HartRAO)	59	Zelenchukskaya Radio Astronomical Observatory 2014 IVS Annual Report	145
AuScope VLBI Project and Hobart 26-m Antenna	63	Operation Centers	149
Kashima 34-m VLBI Station	67	Bonn Geodetic VLBI Operation Center	151
Kokee Park Geophysical Observatory	71	CORE Operation Center 2014 Annual Report ...	153
Kashima and Koganei 11-m VLBI Stations	75	NEOS Operation Center	157
Matera CGS VLBI Station 2014 Annual Report ..	79		
Medicina Station Status Report	82		

Correlators	159	USNO Analysis Center for Source Structure Report	276
The Bonn Astro/Geo Correlator	161	Vienna Special Analysis Center Annual Report 2014	278
Haystack Observatory VLBI Correlator	164		
IAA Correlator Center 2014 Annual Report	168		
Shanghai VLBI Correlator	171		
Tsukuba VLBI Correlator	175		
Washington Correlator	179		
Data Centers	181	Technology Development Centers ..	283
BKG Data Center	183	Canadian VLBI Technology Development Center Report	285
CDDIS Data Center Summary for the IVS 2014 Annual Report	185	GSFC Technology Development Center Report ..	286
Italy INAF Data Center Report	188	MIT Haystack Observatory Technology Development Center	289
Data Center at NICT	189	IAA Technology Development Center Report 2014	292
Paris Observatory (OPAR) Data Center	192	NICT Technology Development Center 2014 Annual Report	296
		Onsala Space Observatory – IVS Technology Development Center Activities during 2014	300
		IGN Yebes Technology Development Center	304
Analysis Centers	195	Bibliography	309
Analysis Center of Saint Petersburg University ..	197	Bibliography	311
Geoscience Australia Analysis Center 2014 Annual Report	199		
Report for 2014 from the Bordeaux IVS Analysis Center	200		
BKG/DGFI Combination Center Annual Report 2014	204	IVS Information	329
Matera CGS VLBI Analysis Center	208	IVS Terms of Reference	331
DGFI Analysis Center Annual Report 2014	210	Links to Additional IVS Information	338
GFZ Analysis Center 2014 Annual Report	213		
BKG/IGGB VLBI Analysis Center	217		
GSFC VLBI Analysis Center Report	221		
Haystack Observatory Analysis Center	225		
IAA VLBI Analysis Center Report 2014	229		
Italy INAF Analysis Center	233		
JPL VLBI Analysis Center Report for 2014	235		
KASI Combination Center 2014 Annual Report ..	239		
KTU-GEOD IVS Analysis Center Annual Report 2014	240		
Analysis Center at the National Institute of Information and Communications Technology	243		
NMA Analysis Center 2014 Annual Report	247		
Paris Observatory (OPAR) Analysis Center	249		
Onsala Space Observatory – IVS Analysis Center Activities during 2014	252		
PMD Analysis Center 2014 Annual Report	256		
Pulkovo IVS Analysis Center (PUL) 2014 Annual Report	260		
SAI VLBI Analysis Center 2014 Annual Report ..	264		
SHAO Analysis Center 2014 Annual Report	266		
Tsukuba VLBI Analysis Center	269		
U.S. Naval Observatory VLBI Analysis Center ..	273		



About IVS

IVS Organization

Objectives

IVS is an international collaboration of organizations which operate or support Very Long Baseline Interferometry (VLBI) components. The goals are:

1. To provide a service to support geodetic, geophysical and astrometric research and operational activities.
2. To promote research and development activities in all aspects of the geodetic and astrometric VLBI technique.
3. To interact with the community of users of VLBI products and to integrate VLBI into a global Earth observing system.

The IVS

- Interacts closely with the IERS, which is tasked by IAU and IUGG with maintaining the international celestial and terrestrial reference frames (ICRF and ITRF),
- coordinates VLBI observing programs,
- sets performance standards for the observing stations,
- establishes conventions for data formats and products,
- issues recommendations for analysis software,
- sets standards for analysis documentation,
- institutes appropriate product delivery methods in order to insure suitable product quality and timeliness.

Realization And Status Of IVS

IVS consists of

- 32 Network Stations, acquiring high performance VLBI data,
- 3 Operation Centers, coordinating the activities of a network of Network Stations,
- 7 Correlators, processing the acquired data, providing feedback to the stations and providing processed data to analysts,
- 5 Data Centers, distributing products to users, providing storage and archiving functions,
- 28 Analysis Centers, analyzing the data and producing the results and products,
- 7 Technology Development Centers, developing new VLBI technology,
- 1 Coordinating Center, coordinating daily and long term activities.

Altogether

- 83 Permanent Components, representing 43 institutions in 21 countries,
- ~300 Associate Members.

In addition the IVS has:

- Directing Board, determining policies, standards and goals; the board is composed of 16 members (elected and ex officio), including
- Coordinators for the network, analysis and technology.

ORGANIZATION OF INTERNATIONAL VLBI SERVICE

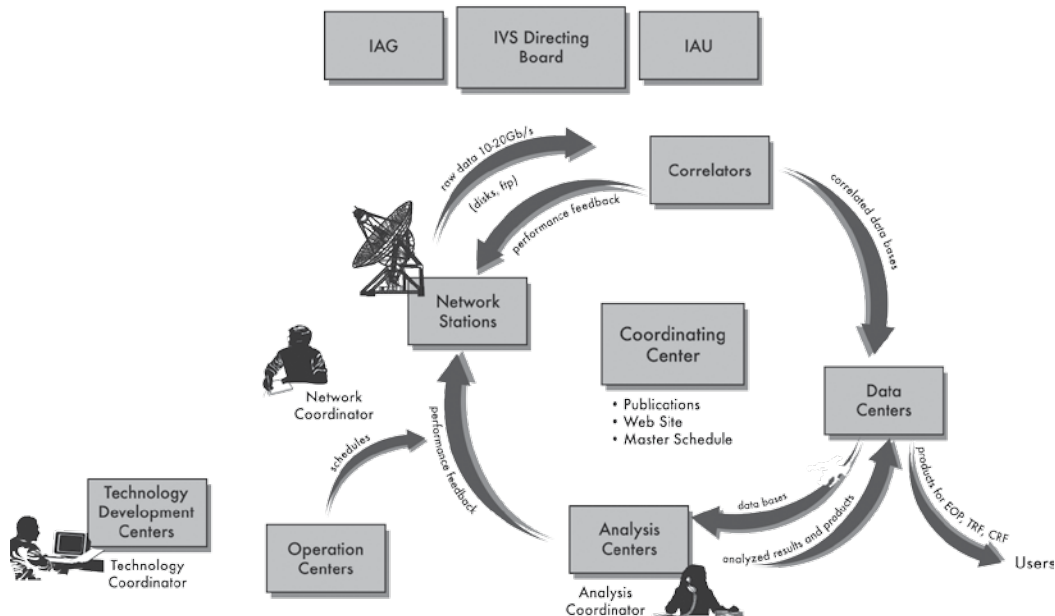

IVS Member Organizations

The following organizations contribute to IVS by supporting one or more IVS components. They are considered IVS Members. Listed alphabetically by country.

Organization	Country
Geoscience Australia	Australia
University of Tasmania	Australia
CSIRO	Australia
Vienna University of Technology	Austria
Centro de Rádio Astronomia e Aplicações Espaciais	Brazil
Geodetic Survey Division, Natural Resources Canada	Canada
Dominion Radio Astrophysical Observatory	Canada
Universidad de Concepción	Chile
Instituto Geográfico Militar	Chile
Chinese Academy of Sciences	China
Finnish Geodetic Institute, Aalto University	Finland
Observatoire de Paris	France
Laboratoire d'Astrophysique de Bordeaux	France
Deutsches Geodätisches Forschungsinstitut	Germany
Bundesamt für Kartographie und Geodäsie	Germany
Institut für Geodäsie und Geoinformation der Universität Bonn	Germany
Forschungseinrichtung Satellitengeodäsie, TU-Munich	Germany
Max-Planck-Institut für Radioastronomie	Germany
GeoForschungsZentrum Potsdam	Germany
Istituto di Radioastronomia INAF	Italy
Agenzia Spaziale Italiana	Italy
Politecnico di Milano DIIAR	Italy
Geospatial Information Authority of Japan	Japan
National Institute of Information and Communications Technology	Japan
National Astronomical Observatory of Japan	Japan
National Institute of Polar Research	Japan
Auckland University of Technology	New Zealand
Norwegian Mapping Authority	Norway
Astronomical Institute of St.-Petersburg University	Russia
Institute of Applied Astronomy	Russia
Pulkovo Observatory	Russia
Sternberg Astronomical Institute of Moscow State University	Russia

Organization	Country
Hartebeesthoek Radio Astronomy Observatory	South Africa
Korea Astronomy and Space Science Institute	South Korea
National Geographic Information Institute	S. Korea
Instituto Geográfico Nacional	Spain
Chalmers University of Technology	Sweden
Karadeniz Technical University	Turkey
Main Astronomical Observatory, National Academy of Sciences, Kiev	Ukraine
Laboratory of Radioastronomy of Crimean Astrophysical Observatory	Ukraine
NASA Goddard Space Flight Center	USA
U. S. Naval Observatory	USA
Jet Propulsion Laboratory	USA

IVS Affiliated Organizations

The following organizations cooperate with IVS on issues of common interest, but do not support an IVS component. Affiliated Organizations express an interest in establishing and maintaining a strong working association with IVS to mutual benefit. Listed alphabetically by country.

Organization	Country
Australian National University	Australia
University of New Brunswick	Canada
FÖMI Satellite Geodetic Observatory	Hungary
Joint Institute for VLBI in Europe (JIVE)	Netherlands
Westerbork Observatory	Netherlands
National Radio Astronomy Observatory	USA

Products

The VLBI technique contributes uniquely to

- Definition and realization of the International Celestial Reference Frame (ICRF)
- Monitoring of Universal Time (UT1) and length of day (LOD)
- Monitoring the coordinates of the celestial pole (nutation and precession)

Further significant products are

- All components of Earth Orientation Parameters at regular intervals
- Station coordinates and velocity vectors for the realization and maintenance of the International Terrestrial Reference Frame (ITRF)

All VLBI data and results in appropriate formats are archived in data centers and publicly available for research in related areas of geodesy, geophysics and astrometry.

IVS Component Map

IVS Components by Country

Country	Qty.
Australia	3
Austria	1
Brazil	1
Canada	1
Chile	1
China	4
Finland	1
France	3
Germany	10
Italy	7
Japan	12
New Zealand	1
Norway	2
Russia	9
South Africa	1
South Korea	2
Spain	2
Sweden	3
Turkey	1
Ukraine	2
USA	16
Total	83

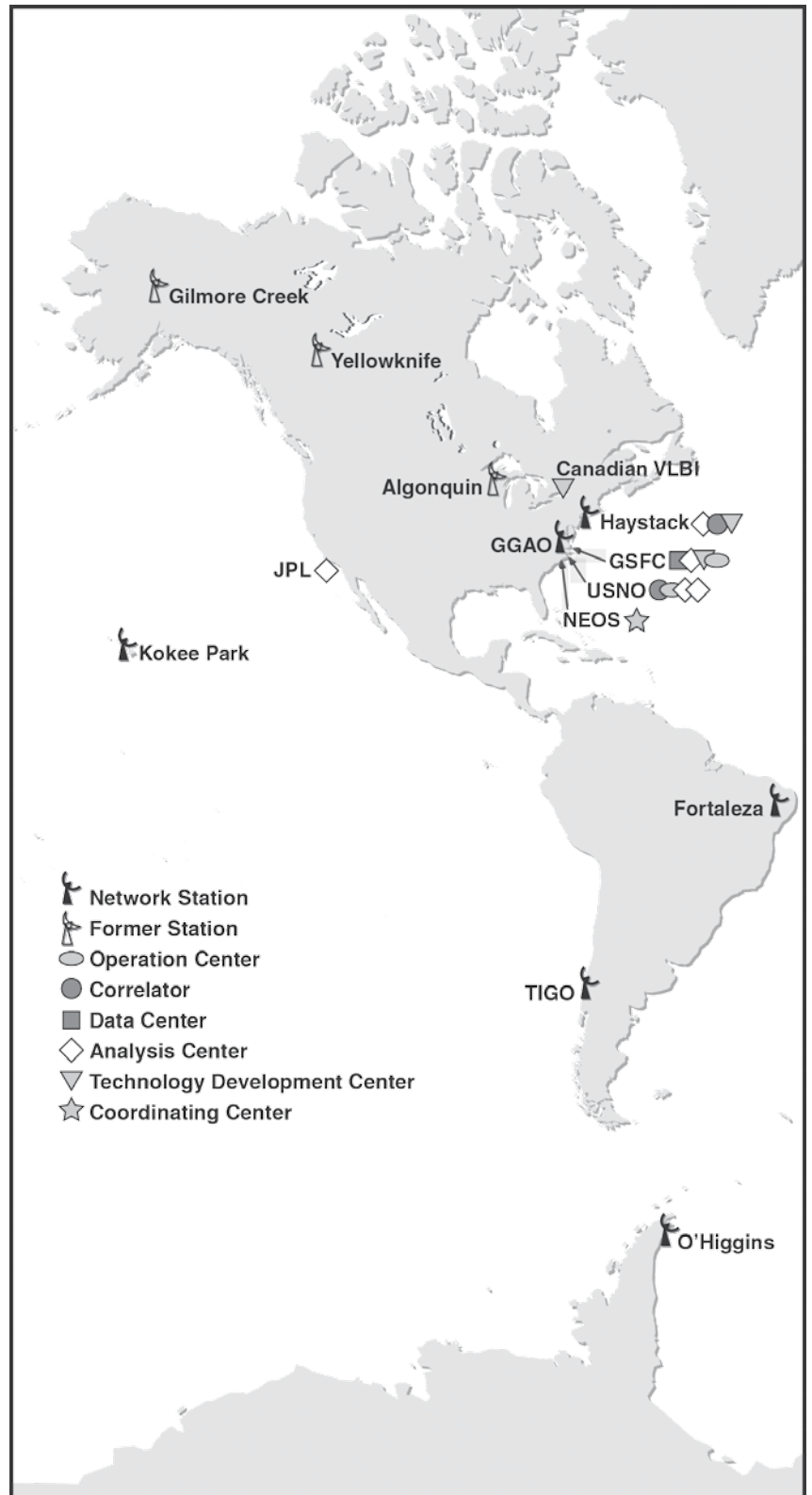



IVS Directing Board

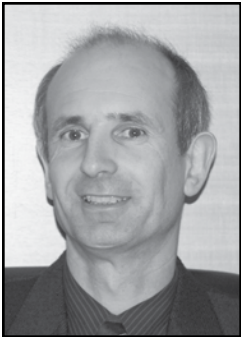

NAME: Axel Nothnagel
AFFILIATION: University of Bonn, Germany
POSITION: Chair, Analysis and Data Centers Representative
TERM: Feb 2013 to Feb 2017



NAME: John Gipson
AFFILIATION: NVI, Inc./Goddard Space Flight Center, USA
POSITION: Analysis Coordinator
TERM: permanent



NAME: Dirk Behrend
AFFILIATION: NVI, Inc./Goddard Space Flight Center, USA
POSITION: Coordinating Center Director
TERM: ex officio



NAME: Rüdiger Haas
AFFILIATION: Chalmers University of Technology, Sweden
POSITION: Technology Development Centers Representative
TERM: Feb 2013 to Feb 2017



NAME: Alessandra Bertarini
AFFILIATION: University of Bonn, Germany
POSITION: Correlators and Operation Centers Representative
TERM: Feb 2011 to Feb 2015



NAME: Hayo Hase
AFFILIATION: Bundesamt für Kartographie und Geodäsie/TIGO, Germany/Chile
POSITION: Networks Representative
TERM: Feb 2011 to Feb 2015



NAME: Patrick Charlot
AFFILIATION: Laboratoire d'Astrophysique de Bordeaux, France
POSITION: IAU Representative
TERM: ex officio



NAME: Ed Himwich
AFFILIATION: NVI, Inc./Goddard Space Flight Center, USA
POSITION: Network Coordinator
TERM: permanent



NAME: Alexander Ipatov
 AFFILIATION: Institute of Applied Astronomy, Russia
 POSITION: At Large Member
 TERM: Feb 2013 to Feb 2015



NAME: Arthur Niell
 AFFILIATION: MIT Haystack Observatory, USA
 POSITION: Analysis and Data Centers Representative
 TERM: Feb 2013 to Feb 2015



NAME: Shinobu Kurihara
 AFFILIATION: Geospatial Information Authority, Japan
 POSITION: At Large Member
 TERM: Feb 2013 to Feb 2015



NAME: William Petrachenko
 AFFILIATION: Natural Resources Canada, Canada
 POSITION: Technology Coordinator
 TERM: permanent



NAME: James Lovell
 AFFILIATION: University of Tasmania, Australia
 POSITION: Networks Representative
 TERM: Feb 2013 to Feb 2017



NAME: Harald Schuh
 AFFILIATION: GFZ German Research Center for Geosciences, Germany
 POSITION: IAG Representative
 TERM: ex officio



NAME: Chopo Ma
 AFFILIATION: NASA Goddard Space Flight Center, USA
 POSITION: IERS Representative
 TERM: ex officio



NAME: Fengchun Shu
 AFFILIATION: Shanghai Astronomical Observatory, China
 POSITION: At Large Member
 TERM: Feb 2013 to Feb 2015

IVS Chair's Report

Axel Nothnagel

Institute of Geodesy and Geoinformation of the University of Bonn

The IVS Annual Report 2014 is again a vital means of documenting the success of the IVS in both its operational capacities and its progress in development. I would like to thank all contributors for their efforts in writing down their activities. This is sometimes considered a futile and superfluous endeavor; however, just the opposite is the case. The IVS Annual Report is a valuable document and a good reference of what everyone is doing for and within the IVS. One of the key reasons for the high level of acceptance of the IVS Annual Reports has always been that they have a very low latency of publication and guarantee a high level of actuality. But where would our timely contributions end up if we hadn't our diligent team of editors, Karen Bayer, Dirk Behrend, and Kyla Armstrong, who take care of all the nitty-gritty details of queries, formatting, type-setting, and administrative hurdle-jumping before we have the printed issues in our hands? A special thanks to the three of them.

Still talking of the IVS Annual Report and its importance, let me mention that one of our parent organizations, the International Association of Geodesy (IAG), has launched a review campaign of its services starting with a very detailed questionnaire. Having the continuous series of annual reports at hand largely simplified the task of answering the request for information and giving a presentation at one of the IAG review meetings in Vienna in April 2014.

In 2014, the IVS and its components continued to operate at the best of their capacities making everything possible that was needed for the specific task at hand. One of the key activities to name here certainly is CONT14, which was observed in May 2014, with its tremendous load on (wo)manpower and hardware. CONT14 was the first Continuous VLBI Campaign that was processed in its entirety at the Bonn MPIfR¹/BKG² Correlator by the staff of IGG³ with a DiFX software correlator. Due to the dedication of the correlator staff and help from many other places, the task was completed as planned, and I expect that some fine publications will result from this endeavor in 2015.

In March 2014, the 8th IVS General Meeting was hosted by our colleagues of the Shanghai Astronomical Observatory with a wealth of presentations and plenty of time for discussions at splinter meetings and other pleasant side events. Thank you once again for this unique experience. The proceedings of the meeting were printed at the end of last year, and participants should have received a copy

long before they read these lines. The timeliness of publishing the IVS General Meeting Proceedings is another proof of the very good functionality of the IVS, which remains unrivalled among the IAG services.

The IVS Directing Board (DB) met twice in 2014, once in Shanghai, China, in March in connection with the 8th General Meeting and once in Tsukuba, Japan, in October where the DB had the pleasure to witness the formal inauguration ceremony of the Iishioka VGOS telescope. We congratulate our colleagues at the Geospatial Information Authority of Japan (GSI) on their nice new instrument and look forward to receiving the first real VLBI data soon. We are also glad to report that the IGN Yebes Observatory was accepted as an IVS Technology Development Center and that the Korean Sejong radio telescope produced its first usable data in 2014.

Another noteworthy item is that the VGOS Project Executive Group, with approval of the IVS Directing Board, finalized both the *VGOS Observation Plan* and the *VGOS Data Transfer and Correlation Plan*. The two documents describe the path of VGOS into the future and are a valuable reference for IVS colleagues and decision makers alike. They are available on the IVS Web site.

Once again we can look back on a very successful year for the IVS. I trust that you will have an interesting and informative read while going through the individual reports of this volume.

¹Max Planck Institute for Radio Astronomy, Bonn, Germany

²Federal Agency of Cartography and Geodesy, Frankfurt am Main, Germany

³Institute of Geodesy and Geoinformation of the University of Bonn, Germany

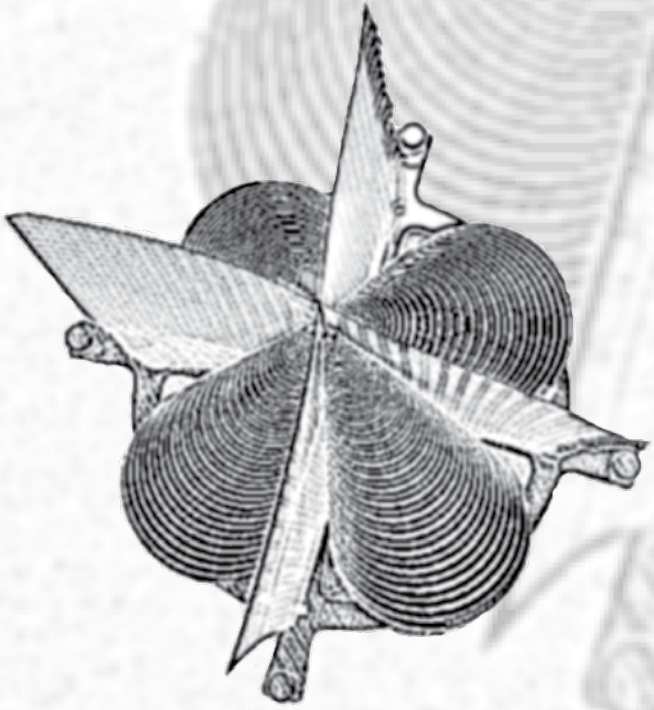

Special Reports

VGOS Data Transmission and Correlation Plan

Version: November 18, 2014

Bill Petrachenko, Alessandra Bertarini, Walter Alef, Dirk Behrend, Roger Cappallo, Hayo Hase, Chopo Ma, Arthur Niell, Axel Nothnagel, Xiuzhong Zhang

Abstract. The establishment of the VLBI Global Observing System (VGOS) requires a projection of the needs for data transmission as well as for correlation to achieve the best possible results and a smooth implementation phase from the very beginning. In this document we outline the requirements and possible developments, which are related to (a) the transport of the raw VLBI data from the stations to the correlators and (b) the correlation and fringe fitting process itself.

1. Introduction

The implementation of the VLBI Global Observing System (VGOS) is being guided by the VGOS Program Executive Group (VPEG), which documents its discussions and considerations in a series of VGOS plans. Following the *VGOS Observation Plan* (Petrachenko et al. 2014), this document now addresses the requirements for VGOS data transmission and correlation. In technical terms, a fundamental assumption for this plan is that the observation cycle of one source has a duration of 30s including a typical on-source integration time of 7.5 s. Data is acquired at 16 Gbps. Assuming that the sequence of observations can be realized as set forth in the *VGOS Observation Plan*, the VGOS data production rates increase from 58 TeraByte (TB) per day in the year 2015 to 1037 TB/day in 2020 (Tab. 1). The last column, “data/day at correlator”, assumes that there is only one monolithic correlator in use. With more than one correlator, sessions would be distributed such that, on average, the total correlator load would be divided in proportion to the available capacity at each correlator. Although interesting from the point of view of data transmission and cost sharing, a highly distributed correlator is not discussed here.

Year	# of sites	hours of obs/day	data/day/site (TB)	data/day at correlator (TB)
2015	8	4	7.2	58
2016	10	8	14.4	144
2017	16	8	14.4	230
2018	20	10	18.0	360
2019	24	12	21.6	518
2020	24	24	43.2	1037

Table 1. Estimates of VGOS data production rates for the years 2015 to 2020.

This document will attempt to predict VGOS requirements for e-transfer, disk pack shipping, media requirements per station, number of playback units at the correlator, correlator cores, internal correlator network, and on-line correlator memory for the years 2015 to 2020. In this version of the document, the increased data transmission and correlation load related to multi-antenna sites has not been taken into account. For twin (VGOS) telescope sites this could lead to as much as a doubling of the data production rate if the most aggressive observing scenarios are assumed for both antennas. For sites that will continue to operate a legacy antenna along with the new VGOS antenna(s), the added data production rate will typically be significantly less severe than for twin telescope sites due to the slower slew speed of the legacy antenna. Furthermore no attempt will be made here to estimate power requirements for the correlator although this could become an important aspect of correlator operational costs; hence it may be considered in a later version of this document. It is assumed that the correlator will be a software correlator and that its architecture will be similar to existing software correlators.

2. e-Transfer Rates

Based on the information in Table 1 it is possible to calculate requirements for sustained data transmission rate from each site and for a cumulative sustained reception rate at the correlator. These are calculated simply as the total daily data production divided by the number of seconds in a day. The cumulative sustained reception rate at the correlator in column five of the table assumes that all stations transmit data to the correlator via e-transfer and hence is the maximum value expected. When specifying a requirement for network data rate it is common to account for network overhead by applying about a 40% margin above the sustained data rate to arrive at the required network data rate. Stations planning to transfer data over the Internet have to increase their capacity from 1.0 Gigabit per second (Gbps) in 2015 to 5.6 Gbps in 2020 (Tab. 2). If the data of all stations would be transferred over the Internet, the correlator(s) need an increase in network capacity from 8 Gbps to 134 Gbps. For some stations and correlators where direct inexpensive access to a high speed network is not practical, it may be cost effective and efficient to physically transport modules to or from a nearby node on a network trunk and then e-transfer from that point onward.

Year	data rate at each site (Gbps)	network data rate at each site (Gbps)	data rate at correlator (Gbps)	network data rate at correlator (Gbps)
2015	0.7	1.0	5	8
2016	1.3	1.9	13	19
2017	1.3	1.9	21	30
2018	1.7	2.4	34	48
2019	2.0	2.8	48	68
2020	4.0	5.6	96	134

Table 2. Estimates of sustained e-transfer rates and network data rates.

3. Record Media Shipment

The other alternative for data transmission is to physically ship record media. By 2015 it is expected that new 8-pack recording modules will be based on 6 TB disks (i.e. 48 TB total for each 8-pack module). In Table 3, the data production rates from Table 1 are re-expressed in terms of the number of 8-pack record modules required per day. In most cases disk packs will be significantly less than full at the end of 24 hours.

Year	8-pack module capacity (TB)	data produced per day (# of 8-pack modules)
2015	48	0.15
2016	48	0.30
2017	48	0.30
2018	48	0.37
2019	48	0.45
2020	48	0.90

Table 3. Estimates of the number of 8-pack record modules required per day at each station.

4. Media Requirements per Station

There are three cases that need to be considered for estimating a stations media requirements:

- *All stations ship disk packs.* Any station that ships disk packs needs enough media to handle about eight weeks of recording (one week for shipping to the station, one week for shipping to the correlator, two weeks for correlator schedule slippages and post-processing, and four weeks to reduce costs at the correlator through bulk monthly shipment of media to the stations);
- *Some stations ship disk packs and some stations e-transfers data.* In this case, the stations that ship disk packs still need eight weeks of media; but the stations that e-transfer data only need enough media to handle three weeks of recording before modules can be erased for re-use (one week while the shipped disks travel to the correlator and two weeks for correlator schedule slippages and post-processing) [An alternative for stations that e-transfer is to have enough on-line RAID storage to store the raw data for three weeks.];
- *All stations e-transfer data.* For a network where all stations e-transfer data there are two cases:
 - *Non real time.* In this case each station needs two weeks of media to account for correlator schedule and data transmission slippages, and to allow for completion of post-processing

- *Real time.* In this case correlator schedule slippages are not tolerated and only limited buffering is required to account for network overhead and unexpected network outages.

In Table 4, the media requirements per station are shown. As in the previous section, it is assumed that 48 TB modules will be used. Even though some stations will have more than adequate network capability, it is recommended that they still maintain a capability for removable data recording media since correlators may not be able to handle the required network traffic especially during early operations. It is further recommended that the IVS decide on a compatibility standard for record media so that correlators will not need to support more than one type of media.

Year	module size (Tbytes)	Data per day (# of modules)	Days/module (modules/year 1-way shipped)	Sites that ship data (modules needed/site)	Sites that e-transfer in a mixed network (RAID TB)	All sites e-transfer - not real time (RAID TB)
2015	48	0.15	6 (21)	7	4 (151)	3 (101)
2016	48	0.30	3 (122)	19	7 (302)	5 (202)
2017	48	0.30	3 (122)	19	7 (302)	5 (202)
2018	48	0.37	2 (183)	28	11 (373)	7 (249)
2019	48	0.45	2 (183)	28	11 (453)	7 (303)
2020	48	0.90	1 (365)	56	21 (907)	14 (605)

Table 4. Media requirements per station assuming the case where data are shipped only when media is nearly full. As an alternative to removable disk modules for e-transfer data, the numbers in brackets in the last two columns of the table represent the amount of on-line RAID storage (TB) that would be needed to store all e-transferred data from a single station until it can be released.

5. Playback systems at the correlator

It is assumed that the number of playback units at the correlator will be large enough to make possible a semi-automated operating mode where recorded modules never need to be exchanged more often than once per day. In this section, Mk6 units are used as examples although other types of compatible and competitive playback units may also be developed in the course of time. It is assumed that a data acquisition duty cycle of less than 25% will be used so that no more than a single disk pack at a time needs to be mounted at a station and that each Mk6 playback unit at the correlator will be able to mount up to four recorded modules. There are three cases that need to be considered:

- *All stations ship data.* In this case three criteria need to be met:

- There needs to be a place for a recorded module from each station to be loaded. For example, since each Mk6 can handle four recorded modules, an eight station network would require at least two Mk6s.
- The cumulative sustained data rate of the correlator needs to be met. For example, since each Mk6 can play back at 16 Gbps (or somewhat more) when four disk packs are loaded, a sustained data rate of 21 Gbps would require at least two Mk6s.
- It must be possible to store the total volume of data acquired in 24 hours. For example, since each Mk6 fully loaded with four 48-TB record modules can store 192-TB of data, a 230 TB session would require at least two Mk6s.
- *All stations e-transfer data.* In this case only the latter two criteria need to be met but now an equal number of Mk6s is required to record data from the network and to play it back to the correlator so that the number of units is doubled. For example, for a sustained data rate of 21 Gbps and a total volume of 230 Tbytes, two Mk6s would be required to record from the network and two to play back to the correlator, for a total of 4 Mk6s.
- *Some stations ship data and some stations e-transfer data.* In this case, the number of Mk6s required will lie somewhere between the cases where all stations ship and all stations e-transfer. The final number will depend on the ratio of stations shipping and e-transferring.

See Table 5 for an estimate of the number of Mk6s required at the correlator.

Year	# of sites	Data rate at correlator (Gbps)	Data volume (TB)	# of Mk6s (all sites ship data)	# of Mk6s (all sites e-transfer data)
2015	8	5	58	2	2
2016	10	13	144	3	4
2017	16	21	230	4	4
2018	20	33	360	5	6
2019	24	48	518	6	8
2020	24	96	1037	6	16

Table 5. Estimate of number of Mk6s required at correlator.

6. Correlator Cores

In principle, it should be easy to estimate the VGOS correlator CPU requirements since the processing load of a DiFX correlator (or any software correlator with a similar architecture) increases more or less linearly with the number of stations in a scan. [With a typical DiFX correlator this linear relation is valid up to about 15 stations which is in line with the vast majority of scans expected for the VGOS network even up to 2020 and

beyond.] As a result, the number of CPU operations required to keep up with data acquisition should simply be proportional to the cumulative sustained input data rate of the correlator. (See Table 2.) Unfortunately, performance benchmarks that relate correlator input data rate to required number of correlator cores are often misleading when used to extrapolate to other correlator architectures, generations of technology, and observing scenarios. This is largely due to the fact that complex real time interactions amongst various hardware components and software processes lead to bottlenecks that move from location to location in the system and change in severity depending on correlator size, architecture, technology, and observing configuration. In the absence of something better to do, a universal scaling factor of about 40 correlator cores per Gbps was derived based on the processing of a single broadband session at the Haystack DiFX correlator and that scaling factor was then used to extrapolate to the VGOS correlator configurations shown in Table 6. For the reasons described above it is not expected that the estimates in the table will be accurate to better than about a factor of three in either direction.

Year	# of correlator cores
2015	200
2016	600
2017	900
2018	1400
2019	2000
2020	3900

Table 6. *Estimates of correlator cores required. It is expected that these values are not accurate to better than a factor of about three.*

7. Internal data rate at the correlator

As a lower limit, the internal data rate of the correlator needs to handle the sustained data acquisition rate. However, since data may at times need to be transmitted more than once before they arrive at their final destination for correlation, an efficiency factor needs to be applied to arrive at a realistic recommendation for internal data rate. It is difficult to be exact about the size of this factor since it will change both with correlator architecture and session configuration. However, for the purpose of this document, a factor of 40% is considered reasonable. If data is e-transferred, then double that rate is required so that transfers from the network to storage and storage to the correlator cores can be handled simultaneously (Tab. 7). Although current correlators are built around 10 Gbps network technology, modern equipment is increasingly able to handle higher data rates. It is recommended that a move to higher rate (e.g., 40 Gbps) technology be considered.

Year	Data rate at correlator (Gbps)	Internal data rate (all sites ship data) (Gbps)	Internal data rate (all sites e-transfer data) (Gbps)
2015	5	7	14
2016	13	19	37
2017	21	30	59
2018	34	48	96
2019	48	68	135
2020	96	135	269

Table 7. Estimates of required internal data rates at correlator.

8. Local storage at the correlator

In addition to the correlation playback units, each correlator needs sufficient local storage capacity for buffering data. Taking into account the data streams coming in by e-transfer and a correlation backlog of two observing days, correlators need local storage capacity of at least 500 TB. For this, either commercial RAID systems or dedicated VLBI units are available. For the dedicated VLBI units, the current MK6 units are used as examples. Along with high storage density and data rates they also have the advantage of removable media.

9. Current and Planned IVS Correlator Resources

Location	Correlator Cores		Mk6s		External Network (Gbps)	
	Now	Planned	Now	Planned	Now	Planned
Bonn	488	1000-1500	2	6 (2 slot)	1	no plan
USNO	512	1024	0	?	1	10
Haystack	100	~300	3	6	20	no plan
Shanghai	64	1000	2	?	1	no plan
Tsukuba	92	256	(24.9 TB)	(513 TB)	10	no plan

Table 8. Current (2014) and planned correlator resources.

Table 8 shows the current and planned resources available for IVS processing at existing software correlators. In most cases these correlators will be shared with other astronomical and/or space programs so only a fraction of the capability will be available for geodesy. Although other aspects of the correlator are important, e.g. internal network resources and internal storage, the table only considers correlator cores, Mk6s and the external network connection. In the case of the Tsukuba correlator, there are no plans for

Mk6s so internal storage is displayed and it should be noted that their planned upgrade has in fact recently been implemented. Correlators that might be of interest but are not included in the table are the VLBA correlator which is used for processing RDV sessions, the Curtin correlator used for AUSTRAL sessions, the Kashima correlator and the Russian correlator. Their use for VGOS sessions will have to be discussed. Available correlator resources in Table 8 can be compared with projected correlator requirements in Tables 6, 5 and 2 respectively.

Station	Network Data Rate(Gbps)
Noto	10
Kokee	0.1
Westford	20
GGAO	1
Ishioka	10
Sheshan	1
Wettzell	1
Yebe	10

Table 9. Network data rates at sites most likely to be ready for broadband observing in 2015.

Table 9 shows network data rates currently available at the VGOS stations most likely to be ready for the broadband test campaigns in 2015. In general data rates vary considerably from site to site. These values should be compared with the projected requirements in Table 2.

10. Recommendations

- Correlator Cores.** Within the next year or two there could be significantly more than 3000 correlator cores available at IVS correlators. According to Table 6 this would satisfy VGOS correlator core requirements up to about 2019. However, this takes into consideration neither the fact that most IVS correlators are shared with other applications (including legacy S/X observing) nor the fact that the estimates in Table 6 are only reliable to within a factor of about three. Furthermore, since most correlators are currently being upgraded with respect to correlator cores it is unlikely that sponsors will fund further upgrades in the near future. As a result it is recommended that the current set of upgrades be completed and that the situation with respect to correlator cores be reviewed in about two years. Over that time, broadband data will have routinely been processed using modern correlator cores so that better estimates of the relation between data throughput and correlator cores can be made. At the same time, more accurate schedules for the roll out of VGOS stations and 24/7 operation will be known making predictions of correlator core requirements more realistic.

- **Dedicated VLBI disk units.** At the moment, no VLBI disk unit with competing capacity to the MK6 units is available. For this reason, MK6 units are used as examples. At present only a few Mk6s units are deployed at observing sites and at correlators. It is recommended that correlators aim to have at least four Mk6s (or equivalent) on the short term and as many as eight on the longer term.
- **External network connections at correlator.** To achieve high precision low latency results, network connections at correlators should be upgraded to at least 10 Gbps on the short term with significantly higher rates (40 Gbps) required in the future to support 24/7 operations with the full network.
- **Network connections at stations.** If real time processing is a priority, network VGOS stations should be upgraded to handle at least 2 Gbps on the short term with 5.6 Gbps required for full 24/7 operations.
- Even though some stations will have more than adequate network capability, it is recommended that they still maintain a capability for removable data recording media since correlators may not be able to handle the required network traffic during early operations.
- It is recommended that the IVS decide on a compatibility standard for record media so that correlators will not need to support more than one type of media.
- **Internal network technology at the correlator.** Although current correlators are built around 10 Gbps network technology, modern equipment is increasingly able to handle higher data rates. It is recommended that a move to higher rate (e.g., 40 Gbps) technology be considered.

References

Petrachenko B, Behrend D, Hase H, Ma C, Niell A, Nothnagel A, Zhang X (2014): **VGOS Observing Plan** (February 13, 2014) http://ivscc.gsfc.nasa.gov/technology/vgos-docs/vgos_observing_plan_140213.pdf

Foundation of the Asia-Oceania VLBI Group for Geodesy and Astrometry

Shinobu Kurihara ¹, Jim Lovell ², Jungho Cho ³, Sergei Gulyaev ⁴, Fengchun Shu ⁵, Ryoji Kawabata ¹

Abstract The Asia-Oceania VLBI Group for Geodesy and Astrometry (AOV), which is a group of scientists in the Asia-Oceania region supporting geodetic and astrometric Very Long Baseline Interferometry (VLBI), was newly established in 2014. Like the European VLBI Group for Geodesy and Astrometry (EVGA), it is a subgroup of the International VLBI Service for Geodesy and Astrometry (IVS). This article traces the beginning and progress toward the inauguration of the AOV.

1 Background

The International VLBI Service for Geodesy and Astrometry (IVS) is an international collaboration of organizations which operate or support Very Long Baseline Interferometry (VLBI) components. Since its foundation in 1999, the IVS has provided a service to support geodetic and astrometric research and operational activities, promoted technology development for VLBI and facilitated interaction between individuals in the VLBI community.

However two decades before the establishment of the IVS, European countries had organized the European VLBI Group for Geodesy and Astrometry (EVGA) and held the first European VLBI meeting in April 1980 in Bonn, Germany [1]. The EVGA was

mainly devoted to geodetic, or rather geodynamic, and astrometric research, but was open also to subjects of general interest that were relevant to VLBI. It is safe to say that the EVGA was the prototype of today's IVS. The EVGA has implemented regional VLBI observations on a regular basis with a permanent network of fixed stations (now called EUROPE session) and encouraged cooperation and personnel exchanges among member organizations through holding a biennial meeting. Their approach has paid off and they continue to play a leading role in the international VLBI community.

In the Asia-Oceania region, there has been cooperation between relevant VLBI organizations in each country, but less international collaboration. Up until the early days of the IVS, there were few VLBI telescopes devoted to geodetic observations in this region. According to the 1999 IVS Annual Report, only five organizations from the region (one from China and four from Japan) were listed as the IVS Member Organizations. In the last ten years or so, several organizations from Australia, New Zealand, and South Korea became IVS Member Organizations and many telescopes for geodesy such as the AuScope array, Warkworth, and Sejong were newly erected. Today, the IVS Member Organizations in Asia-Oceania play a crucial part in geodetic and astrometric VLBI activities in the world. In 2013 we proposed that Asia-Oceania should also establish a regional community for geodetic and astrometric VLBI along the lines of the EVGA.

1. Geospatial Information Authority of Japan, Japan

2. University of Tasmania, Australia

3. Korea Astronomy and Space Science Institute, South Korea

4. Auckland University of Technology, New Zealand

5. Shanghai Astronomical Observatory, CAS, China

2 Progress

In March 2013, several researchers from East Asian countries participated in the 21st EVGA Meeting held at Aalto University in Finland. Junggho Cho, Fengchun Shu, and Shinobu Kurihara discussed the idea of regional collaboration on geodetic VLBI among South Korea, China, and Japan sitting at the same table in the dinner of the meeting (Figure 1). We concurred on the need for establishing a new regional community for VLBI and discussed what action should be taken to fulfill the idea. We three brought it back home and encouraged VLBI colleagues in each country to agree with the plan and to be involved in the community. In subsequent further discussions, we came to the conclusion that the involvement of VLBI institutions in Oceanian countries was also necessary for more effective cooperation in this region.

We solicited colleagues in Australia and New Zealand to take part in the regional VLBI community. They already have started a series of VLBI sessions called AUSTRAL with a network including AuScope, Warkworth, and HartRAO and organized a cooperative framework in the Southern Hemisphere. Oceanian colleagues were interested in the plan and favored being involved in the new regional community with East Asian countries.

In September 2013, colleagues from several VLBI institutions in Australia, New Zealand, and Japan met after the IAG Scientific Assembly held at Potsdam, Germany. We agreed on the foundation of a regional VLBI community and confirmed that it should be a subgroup of the IVS in the same way that the EVGA is. The community was named the Asia-Oceania VLBI Group for Geodesy and Astrometry, and its acronym was tentatively called AOV. Jim Lovell undertook to draft the Terms of Reference. In the IVS Directing Board Meeting on September 7th, Shinobu Kurihara reported that Asian and Oceanian countries intended to establish a regional VLBI group similar to the EVGA, and the Board fully approved this notion.

Though the Terms of Reference are similar to those of the EVGA, they focus on issues particular to the region. In particular, the Terms of Reference stipulate that the AOV plays an important role through measurement of tectonic plate motion, atmospheric variation and the determination of the Geodetic Reference Frame for the region in order to better understand the risks and

reduce the effect of destructive earthquakes, tsunamis, typhoons and cyclones which frequently cause serious damage to the region.

We continued to work toward establishing the AOV and held our inaugural meeting in conjunction with the 8th IVS General Meeting in Shanghai, China in March 2014. As of the end of 2013, while the draft of the Terms of Reference were almost completed, we determined the need for strong leadership from a publicly elected Chair and Secretary so as to formally inaugurate the group. Since the election took a couple of months, we decided to hold the election after the Shanghai meeting. The announcement of the Shanghai meeting was sent out to all the IVS Associated Members in the Asia-Oceania region (more than 80 individuals) at the beginning of January, and many researchers and engineers expressed their interest. At the Shanghai meeting on March 1st, more than 30 participants discussed the draft of the Terms of Reference, the process to appoint the Chair and Secretary and their duties, and plans for initial AOV activities (Figure 2).

At the opening of the IVS General Meeting on March 2nd, Dr. Axel Nothnagel, the Chair of the IVS Directing Board, introduced the foundation of the AOV to the IVS community in general as one of the three important activities with GGOS, together with the UN Global Geospatial Information Management (UN-GGIM) and data referencing through Digital Object Identifiers (DOI) initiatives.

In September 2014, the election of the first AOV Chair was held, led by five members of the Election Committee (Shinobu Kurihara, Stas Shabala, Fengchun Shu, Sergei Gulyaev, and Junggho Cho). The call for nomination was sent out to all AOV members, and a special web site for the election was set up at the Shanghai Astronomical Observatory. There were two candidates for the Chair position, and 12 institutions (Table 1) cast one vote each. But it ended in a tie, thus the final decision went to the vote by the Election Committee. As a result, Jim Lovell from the University of Tasmania was elected as the first Chair of AOV. According to the Terms of Reference approved on September 1st, the Chair is to appoint the Secretary, and considering geographical balance, if the Chair is from Oceania, the Secretary must be appointed from Asia – and vice versa. Jim appointed Ryoji Kawabata from the Geospatial Information Authority of Japan (GSI).

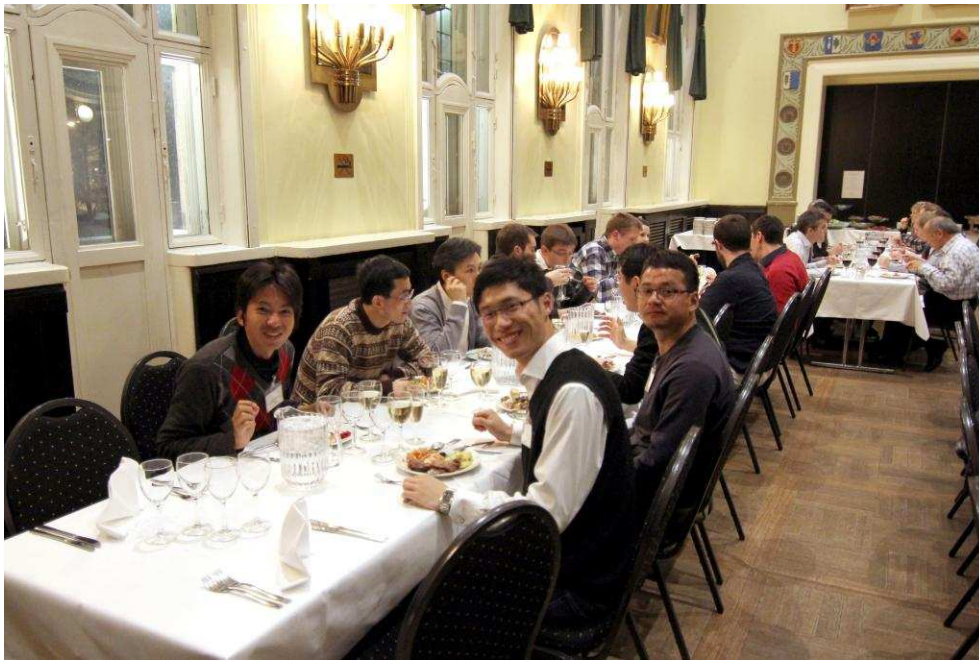

Fig. 1 The dinner time discussion in Finland on March 6th, 2013.



Fig. 2 The meeting at Shanghai Astronomical Observatory on March 1st, 2014.

The Chair and Secretary held a face-to-face meeting at Tsukuba, Japan just after the inauguration ceremony of the Ishioka VGOS Station and discussed how to organize and coordinate regional VLBI obser-

Table 1 Member Organizations of the Asia-Oceania VLBI Group for Geodesy and Astrometry. Shanghai and Xinjiang are registered as CAS in the list of IVS Member organizations, but in consideration of balance of population they are counted as two institutes in AOV.

Name of Member Organizations	Country
Geoscience Australia	Australia
University of Tasmania	Australia
Commonwealth Scientific and Industrial Research Organisation	Australia
Shanghai Astronomical Observatory	China
Xinjiang Astronomical Observatory	China
Geospatial Information Authority of Japan	Japan
National Astronomical Observatory of Japan	Japan
National Institute of Information and Communications Technology	Japan
National Institute of Polar Research	Japan
Auckland University of Technology	New Zealand
Korea Astronomy and Space Science Institute	South Korea
National Geographic Information Institute	South Korea

vations. It was decided that a survey to grasp resources of telescopes, correlators, and analysis centers in the Member Organizations would be carried out.

As a result of the survey sent in December, the representatives of the AOV Member Organizations offered their resources including three schedulers, 16 network stations, three correlators, and two analysis centers to the observations for AOV. The first regional VLBI observations by the Asia-Oceania VLBI network will commence early in 2015.

3 Expected Activities of the AOV

Here we describe the expected activities of the AOV that have been discussed in past meetings and in some email discussion.

3.1 Regular Regional VLBI Observations

Regional VLBI observations in Asia-Oceania on a regular basis will produce the most tangible and practical results in the initial activities of the AOV. Until now, the international VLBI sessions have been implemented under the IVS. However the Asia-Pacific Space Geodynamics program (APSG), which has two sessions in a year, is the only VLBI series optimized to Asia-Oceania region. We will conduct six 24-hour sessions in a year. A large number of AUSTRAL sessions have

already been planned for 2015 and so our strategy is to expand six of these to include as many Northern Hemisphere Asia-Oceania telescopes as possible. These sessions should be renamed AOV sessions. Details such as frequency sequence, bandwidth, rate of sampling, and time of the session start are to be determined as soon as possible. The observed data should be correlated at one of the correlators in this region. The Shanghai VLBI Correlator, the Tsukuba VLBI Correlator, and the National Geographic Information Institute have offered to process the AOV data. The observed data will be e-transferred to the correlator via network, not media shipping. For the baseline between Hobart and Tsukuba, the real-time data transferring and near real-time data processing are available at the Tsukuba Correlator [2].

The correlated data in these AOV sessions will be analyzed and compared by more than two analysis centers and these results will be fed back to the schedulers to improve the quality of data products in following AOV sessions. The results will also contribute to the construction of the regional reference frames in this area.

3.2 Scientific Meeting

It is essential to hold a plenary scientific meeting on VLBI like the EVGA meeting and the IVS General Meeting for sharing and discussing technical matters and giving researchers a chance to get to know each

other. A new inter-agency and international project might happen from such an opportunity. In many cases, meetings connected to VLBI and other related areas have been held in Europe and America. If we can hold such a meeting in Asia-Oceania, we expect many researchers from the region will be able to participate given the relatively smaller travel budgets and given the fact that they will not be exhausted by long flights or suffer from jet lag.

3.3 Regular Working Meeting

Additionally, more frequent regular working meetings by the Chair, Secretary, and representatives from each Member Organization will be required. A teleconference might be convenient because of less time difference. The progress of VGOS projects in each country should also be shared in these meetings.

Acknowledgements

The AOV has now formally started a year and a half after initial discussion. This would not have been possible without contributions from all individuals and institutions in Asia-Oceania, and its future growth will not be possible without their further contributions. We wish to extend many thanks to them and hope that the AOV can contribute to the promotion of VLBI operations, research, and technology development in this region.

References

1. Campbell, J., EVGA — Looking back at the early beginnings, Proceedings of the 20th Meeting of the European VLBI Group for Geodesy and Astronomy, edited by W. Alef, S. Bernhart, and A. Nothnagel, 1-8, 2011.
2. Kurihara, S., K. Nozawa, R. Haas, J. Lovell, J. McCallum, J. Quick, and T. Hobiger, 4-station Ultra-rapid EOP Experiment with e-VLBI Technique and Automated Correlation/Analysis, Proceedings of the 21st Meeting of the European VLBI Group for Geodesy and Astronomy, edited by N. Zubko and M. Poutanen, 233-236, 2013.

Terms of Reference for the Asia-Oceania VLBI Group for Geodesy and Astrometry (AOV)

The AOV is a group of scientists in the Asia-Oceania region supporting geodetic and astrometric Very Long Baseline Interferometry (VLBI). It is a subgroup of the International VLBI Service for Geodesy and Astrometry (IVS).

The Asia-Oceania region is highly dynamic in geophysics and climate, with a large number of destructive earthquakes, tsunamis, typhoons and cyclones. Many countries in the region will experience the effects of climate change much sooner or to a greater degree than other regions, due to more frequent extreme weather events and rising sea levels for example. In order to better understand the risks and reduce the effects of these phenomena, the AOV has an important role to play through measurement of tectonic plate motions, atmospheric variations and determination of the Geodetic Reference Frame for the region. The AOV seeks to:

1. foster the use of VLBI, with a particular focus on producing high quality data and science results in geodesy and astrometry from the Asia-Oceania region.
2. form and strengthen links between the different Asia-Oceania VLBI components in technology development and from observations to data analysis.
3. promote and represent Asia-Oceania geodetic and astrometric VLBI within the broader international scientific communities.
4. provide and archive information and scientific results of Asia-Oceania geodetic and astrometric VLBI.
5. organize regular working meetings to improve communication and cooperation between members of the AOV.

6. support and promote education and training in geodetic and astrometric VLBI and related technology in the region.

Membership of the AOV is naturally comprised of IVS Member Organizations and IVS Associate Members in the Asia-Oceania region.

The AOV also accepts applications for (non-voting) Corresponding Membership from individuals working on geodetic and/or astrometric VLBI at non-IVS Member Organizations in the Asia-Oceania region.

Membership is institution-based with each institution carrying one vote in the election of a Chair. Upon election, the Chair will appoint a Secretary of their choice. If the Chair is from Asia, the Secretary must be from Oceania and if the Chair is from Oceania, the Secretary must be from Asia. The Chair and Secretary must be from AOV Member Organizations or be Corresponding Members. These appointments are for a term of 4 years each. There is no cost for membership.

Roles of AOV Chair and Secretary

The Chair will:

- Set agendas and chair AOV meetings
- Arrange face-to-face meetings and regular telecons
- In consultation with Members, set the science goals of the AOV
- Seek funding for AOV activities
- Represent the AOV within other related groups (IVS, EVGA etc)
- Organize regional observations

The Secretary will be responsible for management and coordination, including:

- Collating and maintaining information on the range of expertise and people within the AOV for purposes of collaboration.
- Management of the AOV website

Approved 1 September 2014

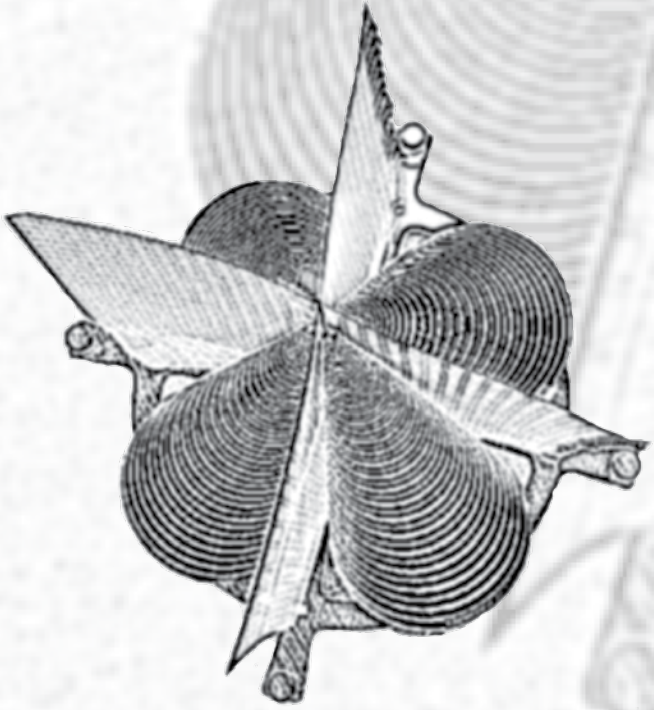

IVS Coordination

Coordinating Center Report

Dirk Behrend

Abstract This report summarizes the activities of the IVS Coordinating Center during the year 2014 and forecasts activities planned for the year 2015.

1 Coordinating Center Operation

The IVS Coordinating Center is based at the Goddard Space Flight Center and is operated by NEOS (National Earth Orientation Service), a joint effort for VLBI by the U.S. Naval Observatory and the NASA Goddard Space Flight Center.

The mission of the Coordinating Center is to provide communications and information for the IVS community and the greater scientific community and to coordinate the day-to-day and long-term activities of IVS.

The Web server for the Coordinating Center is provided by Goddard. The address is

<http://ivscc.gsfc.nasa.gov>.

2 Activities during 2014

During the period from January through December 2014, the Coordinating Center supported the following IVS activities:

- **Directing Board support:** Coordinated, with local committees, two IVS Directing Board meetings,

NVI, Inc.

Coordinating Center

IVS 2014 Annual Report

in Shanghai, China (March 2014) and Tsukuba, Japan (October 2014). Notes from each meeting were published on the IVS Web site.

- **VGOS:** Supported the activities for establishing the VLBI Global Observing System (VGOS) through participation in the VGOS Technical Committee (VTC) and the VGOS Project Executive Group (VPEG).
- **Communications support:** Maintained the Web pages, e-mail lists, and Web-based mail archive files. Maintained the 24-hour and Intensive session Web pages including the data acquisition, correlation, analysis, and performance summaries.
- **Meetings:** Coordinated, with the Local Committee, the eighth IVS General Meeting, held in Shanghai, China in March 2014. Chaired the Program Committee for the meeting and prepared the program booklet.



Fig. 1 Participants of the eighth IVS General Meeting.

- **Publications:** Published the 2013 Annual Report in summer 2014. Published three editions of the IVS Newsletter in April, August, and December 2014. Published the Proceedings volume of the eighth IVS General Meeting in cooperation with the Chinese publishing house Science Press in December

2014. All publications are available electronically as well as in print form.

- **Observing Program Committee (OPC):** Coordinated meetings of the OPC to monitor the observing program, review problems and issues, and discuss changes.
- **2014 Master Schedule:** Generated and maintained the Master Observing Schedule for 2014. Coordinated VLBI resources for observing time, correlator usage, and disk modules. Coordinated the usage of Mark 5 systems at IVS stations and efficient deployment of disk modules.
- **2015 Master Schedule:** Generated the proposed Master Schedule for 2015 and received approval from the Observing Program Committee.

3 CONT14 Campaign

The Continuous VLBI Campaign 2014 (CONT14) was successfully observed in early May 2014. Seventeen IVS stations at sixteen sites (see Figure 2) observed for fifteen consecutive days at a rate of 512 Mbps from 6–20 May 2014. The observing was done on the basis of UT days with each CONT14 day running from 0 UT to 24 UT. UT day observing allows for the most accurate combination and comparison of results with other techniques.

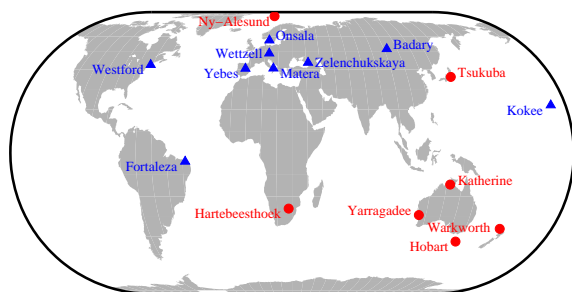

Fig. 2 Geographical distribution of the sixteen CONT14 sites. The sites in red (circles) mostly e-transferred their data to the correlator, whereas the blue sites (triangles) physically shipped their recording modules.

All CONT14 data were correlated at the Bonn Correlator, easing the logistics involved with module handling at the correlators and the stations, and ensuring the creation of a homogeneous data set.

The Coordinating Center, in collaboration with the OPC, was responsible for:

- the overall planning and coordination of the campaign,
- the media usage and shipment schedule, and
- the preparation of the detailed observing schedules and notes.

More information about the CONT14 campaign can be found on the IVS Web site under the URL <http://ivscc.gsfc.nasa.gov/program/cont14>.

4 Staff

The staff of the Coordinating Center is drawn from individuals who work at Goddard. The staff and their responsibilities are listed in Table 1.

Table 1 IVS Coordinating Center staff.

Name	Title	Responsibilities
Dirk Behrend	Director	Web site and e-mail system maintenance, Directing Board support, meetings, publications, session Web page monitoring
Cynthia Thomas	Operation Manager	Master schedules (current year), resource management and monitoring, meeting and travel support, special sessions
Frank Gomez	Web Manager	Web server administration, mail system maintenance, Data Center support, session processing scripts, mirror site liaison
Karen Baver	General Programmer and Editor	Publication processing programs, LaTeX support and editing, session Web page support and scripts, Data Center support
Kyla Armstrong	Data Technician and Editor	Publications support and Web site support

5 Plans for 2015

The Coordinating Center plans for 2015 include the following:

- Maintain IVS Web site and e-mail system.
- Publish the 2014 Annual Report (this volume).
- Coordinate, with the local committee, the eighth IVS Technical Operations Workshop to be held at

the MIT Haystack Observatory, MA, USA in May 2015.

- Support Directing Board meetings in 2015.
- Coordinate the 2015 Master Observing Schedules and IVS resources.
- Publish Newsletter issues in April, August, and December.
- Support the VGOS activities within the VTC and the VPEG.

Analysis Coordinator Report

John Gipson

Abstract I present the IVS analysis coordination issues of 2014. The IVS Analysis Coordinator is responsible for generating and disseminating the official IVS products. This requires consistency of the input data by strict adherence to models and conventions.

are responsible for particular sessions take over the task of writing the Analyst Comments for their sessions. USNO agreed to serve as a test case and expects to start submitting the comments for the R4s in early 2015. I look forward to other Analysis Centers which are responsible for specific sessions taking part in this effort.

1 IVS Analysis Workshop and Software Demonstration

The IVS Analysis Workshop was held on March 7, 2014 in Shanghai, China in conjunction with the IVS General Meeting. As usual, the Workshop provided a useful forum for analysts to discuss various issues. Space limitations preclude a full discussion, but it is worthwhile mentioning a few ‘action items’ and what subsequently happened.

1.1 Analyst Comments

The Goddard VLBI group has been producing session reports for all IVS sessions since 2000. These reports summarize what was discovered in the process of analyzing the sessions, and they contain information about clock breaks, station performance, etc. I have heard that other IVS analysts use these reports, particularly if they notice something ‘funny’ with the data. David Gordon of GSFC suggested that the other ACs which

NVI, Inc.

IVS Analysis Coordinator

IVS 2014 Annual Report

1.2 Multi-tone Phase Cal

Arthur Niell suggested that the correlators should begin using Multi-tone Phase Cal. Alessandra Bertarini from the Bonn Correlator agreed to process a set of sessions using Multi-tone. These sessions would be compared to sessions processed ‘normally’. In the summer and fall of 2014 Alessandra processed the CONT14 sessions using both single-tone and multi-tone phase-cal. David Gordon edited and analyzed these sessions. I compared the results of the two data sets. The multi-tone results tended to be better from several criteria. The number of observations was larger in the multi-tone databases, indicating that the correlator was able to recover more observations. The average session fit was lower, indicating that the data was more consistent within a session. The baseline scatter over CONT14 was lower with multi-tone, indicating that the data was more consistent across the sessions. But it turned out that the vertical position for Zelenchukskaya changed by about 1 cm in the multi-tone sessions compared to the single-tone. This shift was consistent across all of the sessions.

1.3 UT1 at Finer Intervals

At short time scales UT1 exhibits stochastic variation. The error in extrapolated UT1 given an initial offset and rate grows as $35 \mu s T^{(3/2)}$, where T is measured in days. For 24-hour sessions, current VLBI software produces either A) an overall offset and rate for UT1 for each session or B) UT1 at 24-hour tabular points surrounding and including the session. The UT1 formal errors for the best sessions is on the order of $2 \mu s$. This suggests that we could accurately measure UT1 at intervals of six hours. It was decided to pursue this on a trial basis although no results are in yet.

2 IAG/GGOS/IERS Unified Analysis Workshop

The Unified Analysis Workshop was held at Caltech in June 2014 and chaired by Tom Herring. There were representatives from all of the Geometric Techniques and talks about many subjects. I will restrict myself here to two issues of the most relevance to VLBI. First there was an extended discussion of the scale of the TRF. The scale is important because GPS, which provides densification of the ITRF, is relatively insensitive to scale. Hence the scale must be set by other techniques, and in practice it is set by VLBI and SLR. John Ries who works in SLR gave an overview of this issue. The scale determined by VLBI and SLR differs by about 1 ppb, which translates to a difference in local up of 6 mm. This result has been more or less consistent over the last 15 years. As we strive for millimeter level accuracy it is important that we resolve this issue. One possible explanation advanced by Ries is that this may be due to differences in how the techniques model the effects of General Relativity. This should certainly be re-examined. Dan MacMillan of GSFC gave a talk about various things that can affect the scale of the TRF as measured by VLBI, for example the effect of not modeling gravitational deformation in VLBI antennas. Neglecting this effect will change the estimate of local up which will go directly into the scale. But the sign and magnitude of this effect depend on the characteristics of the antenna, and there is no compelling reason why the effect would be positive for all or most of the antennas. One can determine the effect of gravita-

tional deformation either through direct measurement or structural modeling of the antenna. (See the references which list papers by Artz, Nothnagel, Sarti, and Abbondanza discussing this issue.) Neither approach is inexpensive. But I encourage groups that have resources to make these measurements on the antennas for which they are responsible. Johannes Böhm gave a talk about the effect of Glacial Isostatic Adjustment (GIA) models on the difference in scale between VLBI and SLR. If all of the VLBI and SLR sites were collocated with each other, these models would affect both techniques identically. But because this is not the case, changing the models will affect the techniques differently and could in principle result in scale differences. But the magnitude of the effect seems too small. Another issue that affects all of the techniques is modeling of High Frequency Earth Orientation Parameters (HF-EOP). The importance of this effect was predicted in the early 1990s, [Herring and Dong], and the first models were adapted in the mid 1990s (see for example [Gipson 1996]). I gave a talk comparing empirical HF-EOP models derived from Space Geodesy [Artz 2011, Bockmann 2010, Gipson 2009, Steigenberger 2006] to Tidal models derived from satellite altimetry data [Ray 1994, Ray 1996, Egbert 1994]. Once the effects of Libration are included, both the Space Geodesy models and the Tidal models generally agree with each other. But if you look at the models in more detail, it is clear that the Space Geodesy models cluster together, with the RMS difference being $\sim 2 \mu s$, as do the Tidal models, also with an RMS difference of $2 \mu s$. The RMS difference between the Space Geodesy and the Tidal Models is $\sim 4 \mu s$, suggesting there is room for improvement. Harald Schuh gave a talk “Combined short period EOP model” that reported on a collaboration that plans to derive a new and improved High Frequency Earth Orientation (HF-EOP) model based on better tidal modeling. It is possible that this model will agree better with the empirical data.

3 ITRF2013 Becomes ITRF2014

In March 2013, Zuheir Altamimi issued a call for participation in ITRF2013. This was to include data from the geometric techniques through December 2013. Because of some quality control issues, the IGS had not submitted a solution as of early December 2014. Zuheir

asked the Analysis Coordinators of the different techniques if they would be willing to extend their data by submitting a contribution through December 2014. The end product would be not ITRF2013 but ITRF2014. The hard deadline for the submission would be February 28, 2015. I contacted Sabine Bachmann of the IVS Combination Center to see if this was feasible on her end. When she replied in the affirmative I polled the various IVS Analysis Centers that had submitted VLBI solutions to ITRF2013 to see if they were willing and able to process another year of data with a deadline of January 31, 2015. All of the ACs agreed to do this. Ten IVS Analysis Centers submitted solutions for ITRF2013 and ITRF2014 using five software packages. The software and the number of ACs were, in order of popularity: A) Calc/Solve, five ; B) VieVS, two; C) Geosat, one; D) Occam, one; E) Quasar, one. Calc/Solve continues to be the most widely used software package, but it is good to have other packages to which to compare results. As a side-effect of doing the combination, in the course of comparing the results from different ACs with each other, many discrepancies were found. Sabine Bachmann notified the respective ACs about this, and many bugs and setup errors were found and corrected. This sort of feedback is crucial to making the VLBI products better.

References

1. Artz T., Springer A., and Nothnagel A. (2014). *A complete VLBI delay model for deforming radio telescopes: the Efeldsberg case*, J. Geod. 88:1145-1161. doi 10.1007/s00190-014-0749-1.
2. Artz, T., S. Tesmer née Böckmann, A. Nothnagel (2011) "Assessment of periodic sub-diurnal Earth rotation variations at tidal frequencies through transformation of VLBI normal equation system", Journal of Geodesy, 85 (9). p. 565-584. doi: 10.1007/s00190-011-0457-z.
3. Nothnagel A., Springer A., Heinz E., Artz T., and de Vicente P. (2014), *Gravitational deformation effects: The Yebes 40-m telescope*. IVS 2014 General Meeting Proceedings. D. Behrend, K. Baver, K. Armstrong (eds). 158-162.
4. Sarti P., Abbondanza C., Vittuari L. (2009), *Gravity-dependent signal path variation in a large VLBI telescope modelled with a combination of surveying methods*. J. Geod. 83(11):1115-1126. doi 10.1007/s00190-009-0331-4
5. Abbondanza C., Sarti P. (2010), *Effects of illumination functions on the computation of gravity-dependent signal path variation models in primary focus and Cassegrainian VLBI telescopes*. J Geod 84(8):515-525. doi:10.1007/s00190-010-0389-z.
6. Herring T. A., Dong D. (1994) *Measurement of diurnal and semidiurnal rotational variations and tidal parameters of Earth*. J Geophys Res 99(B9):18051-18071. doi:10.1029/94JB00341
7. Gipson J. M. (1996) *Very long baseline interferometry determination of neglected tidal terms in high-frequency earth orientation variation*. J Geophys Res 101(B12):28051-28064. doi:10.1029/96JB02292
8. Böckmann S., Artz T., Nothnagel A., Tesmer V. (2010) *International VLBI service for geodesy and astrometry: Earth orientation parameter combination methodology and quality of the combined products*. J Geophys Res 115:B04404. doi:10.1029/2009JB006465
9. Steigenberger P., Rothacher M., Dietrich R., Fritsche M., Rülke A., Vey S. (2006), *Reprocessing of a global GPS network*. J Geophys Res 111:B05402. doi:10.1029/2005JB003747
10. Gipson J. M., Ray R. D. (2009) A new model of tidal EOP variations from VLBI data spanning 30 years. In: EGU General Assembly 2009, 19–24 April 2009, Vienna, vol 11, p 13096. <http://meetingorganizer.copernicus.org/EGU2009/EGU2009-13096.pdf>
11. Ray J. R. (1996) Measurements of length of day using the Global Positioning System. J Geophys Res 101(B9):20141–20149. doi:10.1029/96JB01889
12. Ray R. D., Steinberg D. J., Chao B. F., Cartwright D. E. (1994) Diurnal and semidiurnal variations in the Earth's rotation rate induced by oceanic tides. Science 264(5160): 830–832. doi:10.1126/science.264.5160.830
13. Egbert G. D., Bennett A. F., Foreman M. G. G. (1994) TOPEX/POSEIDON tides estimated using a global inverse model. J Geophys Res 99(C12):24821–24852. doi:10.1029/94JC01894

Network Coordinator Report

Ed Himwich, Rich Strand

Abstract This report includes an assessment of the network performance in terms of lost observing time for calendar year 2014. Overall, the observing time loss was about 12%, which is an improvement of about 4% over the previous year due primarily to fewer antenna issues at the observatories and less data loss assigned to the DAS terminal. A table of relative incidence of problems with various subsystems is presented. The most significant identified causes of loss were the scheduled VGOS testing, which accounted for 28 IVS sessions being missed, and bad weather (accounting for about 35% of the loss assigned and reported as miscellaneous problems). After miscellaneous, antenna issues were next at about 15% of data loss, followed by receiver problems at 14%. RFI was 13%, which is 6.6% higher than in 2013. Problems with the electronics rack amounted to 12%. Less than 1.5% of the losses occurred for unknown reasons.

1 Network Performance

The overall network performance was for the most part very good. RFI in S-Band continues to be a source of loss and increased by 6.6%. Bad weather in the Pacific Rim caused wind stows. Antennas with moving parts fail or require system maintenance. The Mark 5 recording system accounted for 4% of data loss, and most of that can be assigned to failed disk modules. Overall, operator performance was very good with gener-

ally quick responses to system errors reported by the Field System or local station equipment such as their antenna control units.

This network performance report is based on correlator reports for experiments in calendar year 2014. The report includes results for the 154 24-hour sessions that had detailed correlator reports available as of January 27, 2015. The data set examined includes approximately 632,594 dual frequency observations. Results for 94 experiments were omitted because either they were correlated at the VLBA, they were not correlated yet by CRTN, or correlation reports were not available on the IVS data centers. Experiments processed at the VLBA correlator were omitted because the information provided for them is not as detailed as that from Mark IV correlators. The experiments that were not correlated or did not have correlator reports available yet include some JADE, CRF, APSG, AUST14, OHIG, R&D, T2, RV, CRDS, EUR, and all the A14 sessions. In summary, roughly 70% of the data from scheduled 24-hour sessions for 2014 are included in this report. That is similar to the coverage of reports for many previous years.

An important point to understand is that in this report, the network performance is expressed in terms of lost observing time. This is straightforward in cases where the loss occurred because operations were interrupted or missed. However, in other cases, it is more complicated to calculate. To handle this, a non-observing time loss is typically converted into an equivalent lost observing time by expressing it as an approximate equivalent number of recorded bits lost. As an example, a warm receiver will greatly reduce the sensitivity of a telescope. The resulting performance will be in some sense equivalent to the station having a cold receiver but observing for (typically) only one-

NASA Goddard Space Flight Center

IVS Network Coordinator

IVS 2014 Annual Report

third of the nominal time and therefore recording the equivalent of only one-third of the expected bits. In a similar fashion, poor pointing can be converted into an equivalent lost sensitivity and then equivalent fraction of lost bits. Poor recordings are simply expressed as the fraction of total recorded bits lost.

Using correlator reports, an attempt was made to determine how much observing time was lost at each station and why. This was not always straightforward to do. Sometimes the correlator notes do not indicate that a station had a particular problem, while the quality code summary indicates a significant loss. Reconstructing which station or stations had problems—and why—in these circumstances does not always yield accurate results. Another problem was that it is hard to determine how much RFI affected the data, unless one or more channels were removed and that eliminated the problem. It can also be difficult to distinguish between BBC and RFI problems. For individual station days, the results should probably not be assumed to be accurate at better than the 5% level.

The results here should not be viewed as an absolute evaluation of the quality of each station's performance. As mentioned above, the results themselves are only approximate. In addition, some problems such as weather and power failures are beyond the control of the station. Instead the results should be viewed in aggregate as an overall evaluation of what percentage of the observing time the network is collecting data successfully. Development of the overall result is organized around individual station performance, but the results for individual stations do not necessarily reflect the quality of operations at that station.

Because stations typically observe with more than one other station at a time, the average lost observing time per station is not equal to the overall average loss of VLBI data. Under some simplifying assumptions, the average loss of VLBI data is roughly twice the average loss of station observing time. This approximation is described in the Network Coordinator's section of the IVS 2001 Annual Report. For 2014, this agrees very roughly with the number of (single frequency: S or X) single baseline observations on which the correlator reported failure, approximately 17%, but other factors, particularly the dual frequency nature of useful geodetic observations, complicate the picture. One significant issue this year was that the correlators did not report losses for some stations (notably Westford) that did not observe in experiments they were scheduled

for. If we omit those losses from the observing time loss, the overall observing time loss is reduced (artificially) to about 10%. Twice that is closer to 17% than doubling 12% is, but the 17% value is still about 25% less than expected. A similar but somewhat smaller discrepancy also occurred for 2012. Some work would no doubt find the issues that caused this, but the factor of two is just a rough approximation, so not getting agreement is not too large an issue of concern.

For 2014, the actual percentage of data (dual frequency) that was not included by the analysts was approximately 23%. This is even larger (by approximately 7%) than the single baseline observations reported lost by the correlator. It is expected that this number should be higher both because of the dual frequency nature of the final observable and the fact that analysts use additional criteria beyond what is discussed here to decide when to exclude observations. However, it means in effect that only about 77% of the observations we attempted to collect were useful.

For the 154 experiments from 2014 examined here, there were 1,404 station days or approximately 8.2 stations per experiment on average. This compares to 159 experiments considered in the report for 2013, which included 1,432 station days with nine stations per experiment. The number of analyzed experiments and the average number of stations per experiment has remained about the same for 2014. Of the station days for 2014, approximately 12% (or approximately 168 days) of the observing time was lost, which is about 4% lower than last year. Removing VGOS testing from this assessment the overall observing time loss for 2014 was 10%. This is 6% lower than in 2013, but 2013 included many sessions lost to scheduled antenna maintenance. Removing antenna maintenance as a loss reduces the year 2013 value by 3% to 13% overall loss. By this measure 2014 is about 3% lower than 2013. For comparison to reports from earlier years, please see Table 1.

The lost observing time for 2014 is in line with results from 2013 and years before 2009. The results for 2009 may be artificially high due to a change in the way the results were tabulated for that year. We believe this year's calculations are more in line with how they were made before 2009.

An assessment of each station's performance is not provided in this report. While individual station information was presented in some previous years, this practice seemed to be counter-productive. Although

Table 1 Lost observing time. The percentage applies to a subset of the 1999-2000 experiments. Percentages for 2010 and 2011 are omitted but should be 10-20%.

Year	Percentage
1999-2000*	11.8
2001	11.6
2002	12.2
2003	14.4
2004	12.5
2005	14.4
2006	13.6
2007	11.4
2008	15.1
2009	21.5
2012	12.3
2013	16.2
2014	11.9

many caveats were provided to discourage people from assigning too much significance to the results, there was feedback that suggested that the results were being over-interpreted. Additionally, some stations reported that their funding could be placed in jeopardy if their performance appeared bad, even if it was for reasons beyond their control. Last and not least, there seemed to be some interest in attempting to “game” the analysis methods to apparently improve individual station results. Consequently, only summary results are presented here. Detailed results are presented to the IVS Directing Board. Each station can receive its own results by contacting the Network Coordinator (Ed.Himwich@nasa.gov).

For the purposes of this report, the stations were divided into two categories: **large N**: those that were included in 24 or more network experiments among those analyzed here and **small N**: those in 17 or fewer (no stations were in the 18-23 experiment range). The distinction between these two groups was made on the assumption that the results would be more meaningful for the stations with more experiments. The average observing time loss from the large N group was much smaller than the average from the small N group, 11.9% versus 22.1%. There are many more station days in the large N group than the small N group, 1,025 versus 122, so the large N group is dominant in determining the overall performance.

There are 17 stations in the large N group. Ten stations observed in 49 or more experiments. Of the

17 stations, 13 successfully collected data for approximately 92% or more of their expected observing time. The four other stations collected 70%, 68%, 65%, and 42% or more of the time. These results are not significantly different from previous years.

There are 21 stations in the small N group. The range of lost observing time for stations in this category was 0%—100%. The median loss rate was approximately 22%, a little worse than last year.

The losses were also analyzed by sub-system for each station. Individual stations can contact the Network Coordinator (Ed.Himwich@nasa.gov) for the sub-system breakdown (and overall loss) for their station. A summary of the losses by sub-system (category) for the entire network is presented in Table 2. This table includes results since 2003 sorted by decreasing loss in 2014.

The categories in Table 2 are rather broad and require some explanation, which is given below.

Antenna This category includes all antenna problems, including mis-pointing, antenna control computer failures, non-operation due to wind through 2013, and mechanical breakdowns of the antenna. It also includes scheduled antenna maintenance. Wind stows have been moved to Miscellaneous for 2014.

Clock This category includes situations in which correlation was impossible because the clock offset either was not provided or was wrong, leading to “no fringes”. Maser problems and coherence problems that could be attributed to the Maser are also included in this category. Phase instabilities reported for Kokee are included in this category. DBBC clock errors are included in this category.

Miscellaneous This category includes problems that do not fit into other categories, mostly problems beyond the control of the stations, such as power (only prior to 2012), (non-wind) weather through 2013, wind stows (moved here from the Antenna category starting in 2014), cables, scheduling conflicts at the stations, and errors in the observing schedule provided by the Operation Centers. For 2006 and 2007, this category also includes errors due to tape operations at the stations that were forced to use tape because either they did not have a disk recording system or they did not have enough media. All tape operations have since ceased. This category is dominated by weather and scheduling conflict issues.

Table 2 Percentages of observing time lost by sub-system. Percentages for 2010 and 2011 were not calculated.

Sub-System	2014	2013	2012	2009	2008	2007	2006	2005	2004	2003
Miscellaneous	35.11	9.4	6.9	15.3	12.8	7.6	18.0	8.0	8.0	6.0
Antenna	14.81	39.6	18.1	29.4	19.2	34.6	19.0	24.4	32.9	17.8
Receiver	13.89	7.7	11.7	18.6	13.8	14.9	20.8	24.2	18.0	25.2
RFI	13.24	6.4	11.8	5.9	14.8	10.4	11.6	6.2	5.0	9.3
Rack	12.02	19.5	21.8	6.6	8.7	11.4	16.3	5.1	6.8	5.0
Recorder	4.10	3.3	5.7	2.9	4.1	4.6	3.3	8.9	11.1	10.9
Operations	4.08	2.5	2.0	1.2	2.3	0.0	2.0	4.7	6.1	3.6
Unknown	1.3	5.7	14.2	14.2	17.7	14.9	4.0	3.3	10.1	12.6
Power	0.4	2.1								
Clock	0.2	3.5	1.8	1.9	0.5	0.3	4.9	14.5	0.5	3.4
Software	0.17	1.0	0.3	0.1	0.1	0.4	0.1	0.5	0.1	0.1
Shipping	0.0	0.9	3.6	4.0	5.4	1.0	0.0	0.2	1.4	6.1

Westford VGOS testing, 28 station days, has been assigned to Miscellaneous for this year, 2014.

Operations This category includes all operational errors, such as DRUDG-ing the wrong schedule, starting late because of shift problems, operator (as opposed to equipment) problems changing recording media, and other problems.

Power This category includes data lost due to power failures at the sites. Prior to 2012, losses due to power failures were included in the Miscellaneous category.

Rack This category includes all failures that could be attributed to the rack (DAS), including the formatter and BBCs. There is some difficulty in distinguishing BBC and RFI problems in the correlator reports, so some losses are probably mis-assigned between the Rack category and the RFI category.

Receiver This category includes all problems related to the receiver, including outright failure, loss of sensitivity because the cryogenics failed, design problems that impact the sensitivity, LO failure, and loss of coherence that was due to LO problems. In addition, for lack of a more clearly accurate choice, loss of sensitivity due to upper X-band Tsys and roll-off problems are assigned to this category.

Recorder This category includes problems associated with data recording systems. Starting with 2006, no problems associated with tape operations are included in this category.

RFI This category includes all losses directly attributable to interference, including all cases of amplitude variations in individual channels, particularly at S-band. There is some difficulty in distinguishing BBC and RFI problems in the

correlator reports, so some losses are probably mis-assigned between the Rack category and the RFI category.

Shipping This category includes all observing time lost because the media were lost in shipping or held up in customs or because problems with electronic transfer prevented the data from being correlated with the rest of the experiment's data.

Software This category includes all instances of software problems causing observing time to be lost. This includes crashes of the Field System, crashes of the local station software, and errors in files generated by DRUDG.

Unknown This category is a special category for cases where the correlator did not state the cause of the loss and it was not possible to determine the cause with a reasonable amount of effort.

Some detailed comments on the most significant issues for this year's data loss are given below.

- The largest source of data loss for 2014 was Miscellaneous at 35% which was due to moving wind stows and weather related issues into this category. VGOS testing at Westford was also assigned to Miscellaneous as that station did not participate in 28 previously scheduled R1 sessions.
- The Antenna was the next largest source of loss at 14.8%, and the Receiver was next at 13.9%, with Fortaleza observing warm for 28 scheduled days.
- RFI contributed about 13%, almost all in S-band due to commercial systems. The stations with the most significant RFI losses are Fortaleza, Medicina, and Matera.

- The data rack was the next largest source of loss at 12%, about 7.5% lower than in 2013. This improvement is the result of bringing all stations up to 14 working converters and what seems like a better operational handle on digital back-ends and better grounding at the sites.
- The proportion of losses attributed to Unknown, 1.3%, decreased this year, primarily because of improvements in classifying the cause of losses. Assigned maintenance for this year was 22 station days, 14%, with about half for repair of the antenna across the network.

Overall, while the network operated well for the most part, there are a few notable issues (in alphabetical order of station), for stations that lost more than 120 total observing hours regardless of the number of scheduled sessions for 2014.

- Fortaleza had a significant cryogenic problem again this year, and a new compressor was shipped to the station in 2015.
- Hobart12 and Hobart26 have a new and serious RFI issue. Hobart12 had multiple wind stows, and Hobart26 had DAS issues.
- Katherine12 had wind stows and DBBC issues since repaired.
- Matera had serious RFI and DAS issues since repaired.
- Medicina had required antenna maintenance and weather issues.
- Warkworth had multiple antenna controller issues and antenna repair.
- Westford lost scheduled R1 sessions due to VGOS testing.
- Yarragadee had Mark 5 module and timing issues.
- Yebes40 lost data due to their data rack until repaired.

2 CONT14

The CONT14 session ran from May 6—20, 2014. There were 15 sessions using 17 stations for a total of 114,522 scans in 255 station days. 18 station days were lost, 7% overall. RFI accounted for 3%, and the weather caused 2.5% data loss, usually due to wind stows.

3 New Stations

There are prospects for new stations on several fronts. These include (in approximate order of how soon they will start regular observations):

- At Wettzell in Germany, the new Twin Telescope Wettzell (TTW) for VGOS has been commissioned.
- At GSFC in the USA, a new 12-m antenna is undergoing testing. While this antenna is primarily for use in the development of the VGOS system, it is expected that it will eventually join the network for regular observing.
- South Korea has a new antenna for geodesy at Sejong, built by the National Geographic Information Institute (NGII). This antenna is now used for normal operations. There is also interest in geodetic use of the Korean VLBI Network (KVN), which consists of three stations intended primarily for astronomy.
- In Spain/Portugal, the RAEGE (Atlantic Network of Geodynamical and Space Stations) project aims to establish a network of four fundamental geodetic stations including radio telescopes that will fulfill the VGOS specifications: Yebes (1), Canary Islands (1), and Azores (2).
- In Norway, the Norwegian Mapping Authority (NMA) is in the civic construction phase for a twin telescope system.
- In Sweden, Onsala Space Observatory has ordered a twin telescope system.
- In Russia, VGOS antennas have been built at the QUASAR sites Badary and Zelenchukskaya.
- There is interest in India in building a network of four telescopes that would be useful for geodesy.
- Saudi Arabia is investigating having a combined geodetic observatory, which would presumably include a VLBI antenna.
- Colombia is investigating having a combined geodetic observatory, which would presumably include a VLBI antenna.

Many of these antennas will become available for use in the next few years. Efforts are being made to ensure that these antennas will be compatible with VGOS.

4 Network Coordination Activities

Network coordination involved dealing with various network and data issues. These included:

- Reviewing all experiment “ops” messages, correlator reports, and analysis reports for problems and working with stations to resolve them.
- Responding to requests from stations for assistance.
- Identifying network station issues and working with the IVS Coordinating Center and the stations to resolve them. This year these included:
 - Encouraging timely delivery of log files
 - Validating DBBCs replacing existing systems
 - Maintaining the FS PC kernel
- Participating in development of the new VEX2 schedule file standard.
- Providing catalog update information for station equipment and track lay-outs.
- Recognizing and reporting DBBC issues to station observing staff.
- Reviewing Mark 5 recording error checks for problems and informing correlator staff and station staff.
- Resolving Kokee GPS/NTP timing issues.
- Troubleshooting power supplies and identifying the correct parts for shipping.
- Troubleshooting video converters and organizing shipments to stations.
- Providing telescope pointing analysis and advice.
- Support, including software development, for the 12-m antenna at GSFC and the VGOS observing system.

- Updating Network Station configuration files.
- Helping to coordinate a Mark 5A/5B firmware update for large module directories and bigger disks.
- Providing support, including software development, for the 12-m antenna at GSFC and the VGOS observing system.
- Other activities as needed.

5 Future Activities

Network coordination activities are expected to continue next year. The activities will largely be a continuation of the previous year’s activities:

- Reviewing all experiment “ops” messages, correlator reports, and analysis reports for problems and working with stations to resolve them.
- Responding to requests from stations for assistance.
- Identifying network station issues and working with the IVS Coordinating Center and the stations to resolve them.

IVS Technology Coordinator Report

Bill Petrachenko

Abstract The main focus of IVS technology development over the past year was to achieve operational readiness for broadband observing. This includes not only the development and proliferation of broadband systems but also the development of software and processes to enable efficient, and eventually automatic, operation of the VGOS stations and correlators. Already, a number of fully compliant (or nearly compliant) VGOS antennas have been constructed (many of these having already achieved first light and first fringes) with several more expected to come on line in the next year or two. The looming challenge is to ensure: that signal chains are available for these antennas; that operating modes of the various systems are VGOS compliant, interoperable, and sufficiently robust against RFI, and that systems can be controlled and thoroughly monitored remotely.

1 VGOS Compliant Signal Chain

Although the definition of the official VGOS signal chain has never been formalized in a single document, it has been discussed in some detail in the collection of talks presented at the IVS VLBI2010 Workshop on Technical Specifications held at Bad Koetzing/Wetzell on March 1-2, 2012. Earlier discussions can also be found in the talks presented at the IVS VLBI2010 Workshop on Future Radio Frequencies and Feeds held at Wetzell/Hollenstein on March

Canadian Geodetic Survey, Natural Resources Canada

IVS Technology Development Coordinator

IVS 2014 Annual Report

18-20, 2009 and in the reports “Design Aspects of the VLBI2010 System: Progress Report of the IVS VLBI2010 Committee”, June 2009, and “VLBI2010: A Vision for Geodetic VLBI”, 2005. Links to all of these talks and reports can be found on the IVS Web site.

So that there is no confusion about the expectations for a VGOS system, the most important system parameters are summarized below:

- The input frequency range is 2.2—14 GHz. But because it is expected that there will be stations that have RFI in the 2.2—3 GHz range that is strong enough to saturate their front ends, VGOS frequency sequences will typically use only the 3—14 GHz range. Use of the full 2.2—14 GHz range will however be important to allow interoperability with legacy S/X systems and stations with S/X/Ka-band receivers.
- There will be four 1024 MHz bands in a system, each of which can be situated anywhere within the input frequency range. [Resolution for setting the frequency will be 400 KHz or a sub-multiple.] Because most systems will operate in an RFI environment, a digitizer with at least 8-bit resolution should be used to provide adequate dynamic range.
- Each of the four 1024 MHz bands will be divided into channels. This is required to protect against RFI within the band. Although there has been no formal discussion of acceptable channel bandwidths, all channelized systems incorporate a 32 MHz option making this, in practice, the standard. VDIF output format is expected with 2-bit requantization of either real or complex data. It will be possible to select any subset of the channels for output.

- The instantaneous output data rate will be 16 Gbps. But because VGOS observing involves short integrations (less than about 15 s) and frequent slewing between sources, the sustained data rate is not expected to be greater than about 4 Gbps. Provided that a RAM buffer of at least 30s at 16 Gbps is available, sustained record or e-transfer rates greater than about 4 Gbps will not be required.
- To minimize systematic effects, calibration systems are required:
 - A phase calibration (Pcal) signal needs to be injected into the receiver frontend so that interferometric phases between bands can be aligned. The same signal is also be used to calibrate the downlink delay through the signal chain and transmission lines. For optimal performance the Pcal signal should be a series of very narrow pulses with pulse repetition rate of 5 or 10 MHz.
 - The delay of the cable carrying the maser reference signal to the Pcal generator needs to be calibrated because that delay is reflected directly in the measured interferometric delay once Pcal has been applied. This is referred to as cable cal. It needs to achieve a stability roughly equal to that of the maser in order to avoid degradation of the time scale.
 - The total power of the receiver needs to be accurately measured in order to support investigations into source structure. This is done by measuring the change in receiver power as a calibrated noise signal is coupled into and out of the signal chain. In order for this to be done simultaneously with observing, it is necessary that the noise signal be relatively weak, and in order to track rapid changes in power, it is necessary that the switching be done several times per second. A switching rate of 80 Hz is common in astronomy.

Although there are many other detailed recommendations, systems that include these basic characteristics have a very good chance of working successfully together.

2 Automation and Remote Control

Automation and remote control are very important aspects of VGOS. With the expectation of 24/7 operations and a sharp rise in the number of observations per day, it is necessary (to keep operating costs at a reasonable level) to make all processes (including schedule generation, station operation, correlation, fringe processing, and analysis) as automated as possible.

A necessary step to achieve automation and remote control is to have a language to concisely and completely describe the instrumentation, operating modes, and schedule for a session. This has been the role of the VEX language over the past decades. But, with the advent of VGOS and the new broadband systems, instrumentation and operating modes which had not been conceived of when the original version of VEX was developed now need to be handled. As a result, over the past few years, a new version of VEX, VEX2, was developed. VEX2 was completed this year; it went through a brief period of community consultation, and it is now being used to write software to control instrumentation and processes in the complete VGOS operational chain.

The real workhorse for monitor and control at the stations has always been the Field System. This will continue to be true in the future, but, with the growing emphasis on automation and remote control, a significantly larger amount of data will need to be collected continuously at the stations. This is needed to evaluate remotely whether or not all systems are working optimally or perhaps to even indicate when systems are just beginning to show signs of failure. As a result, processes are being put in place to monitor continuously and store locally a wide variety of parameters including such things as temperatures throughout the site, motor currents, Pcal, total power, stream stats, raw data captures, plus much more. These data can be accessed remotely to get a detailed view of the state of all station equipment.

Although this additional data will be invaluable for evaluating the health of stations, the volume of data will be too large for a remote operator to continuously scan it. As a result, intelligent software and display processes will be required to study the data and inform the operator through warnings, alarms, and displays when significant performance deficiencies or dangerous conditions are detected.

3 VGOS Innovation

As the operational phase of VGOS approaches, focus is shifting to the deployment of signal chains at stations. But significant VGOS related innovation continues at IVS Technology Development Centers. A few significant highlights are listed below:

- Circular polarized conical feeds are being developed at Yebes. Up until this year, all broadband feeds considered for use in VGOS have used dual linear polarization. This is in spite of the fact that linear polarization has complications for VLBI due to inhomogeneity of parallactic angles caused by the wide separation of antennas in the network. Although a solution to the parallactic angle problem has been found, there continues to be interest in circular polarized feeds because they are a more natural fit for VLBI. If the conical feeds being developed at Yebes can achieve low noise, high efficiency, and good polarization separation, they may become a preferred solution for the VGOS community.
- Progress continues to be made at Noto on the DBBC3L. The DBBC3L is a data acquisition system that, due to its digitizers with wide bandwidth and high clock frequency, can direct sample 4 GHz chunks of data. Although each sampler of the DBBC3L is not capable of directly sampling the entire 2–14 GHz VGOS bandwidth (as was the intention with the DBBCH), when eight of these are combined with fixed frequency down converters, the full 2–14 GHz band can be sampled in both polarizations. This enables optimal placement of each channel anywhere within the full VGOS range, which is an added capability beyond currently used band-constrained systems.
- The Mark 6 data systems developed at Haystack are entering operational service. These data systems are ideally suited for use in VGOS observing. Their large input RAM buffers allow data to be input at the full VGOS data acquisition rate of 16 Gbps and then recorded at a slower rate as the antenna slews to the next source. This capability along with the advent of disk packs based on 4 Tbyte or larger individual disks opens the possibility of efficiently recording a complete VGOS 24-hour session onto a single disk pack.
- A new cooled broadband front end based on a Sterling cycle refrigerator is the joint project of Auscope and Callisto. Sterling cycle refrigerators are small and light; they require very little maintenance and have long times between failures. Although these systems cannot achieve as low physical temperatures as the usual GM-refrigerators, calculations indicate that T_{sys} for the new front end system meets the VGOS recommendation while at the same time being less expensive, lighter, and more operationally efficient. Collaborative funding strategies have left sufficient funds to also acquire a full VGOS back end for Auscope.
- A new cable delay measurement system was developed at Haystack to replace the old Mark III cable cal units. Although based on similar principles, the new units are in detail very different and perform with significantly better stability, matching roughly the performance of a maser. Initially it had been thought that an ultra-stable Pcal uplink cable could be found, but experience has shown that a back-up monitoring system is prudent to guarantee the specified VGOS temporal performance.
- Significant work was done in the past year to move the DiFX correlator and fringing software towards an operational configuration for VGOS. In the correlator itself several compatibility features have been implemented to allow correlation of data streams with incompatible characteristics, e.g. different bandwidths, different LO settings, real vs. complex encoding, etc. In addition, the fringing software has been extended to combine multiple bands (including the use of a TEC search to handle the phase curvature of the ionosphere) and polarizations. With these capabilities in place, the focus has moved to improving the operational efficiency of the correlator so that correlator runs become easier to set up and extraction of data from Mark 6 units into native correlator storage is less time consuming. When this development phase is complete, it will be important to export the VGOS enhancements to other correlators so that experience can be gained with processing VGOS sessions.
- A cost effective direct sampling digital back end is being developed at NICT. This system uses a broadband sampler along with a lower rate sample clock. Using aliasing, a number of bands can be overlapped onto the same frequency region. Al-

though very cost effective, this system does not currently support channelization and hence is incompatible with the VGOS recommendation. It has been used successfully on the baseline between Kashima and Ishioka for broadband tests but is mainly intended for internal use with the NICT time transfer project.

4 VGOS Observing Plan

During 2013, the VGOS Project Executive Group (VPEG) developed an observing plan to guide the transition from current S/X to future VGOS broadband operations. The plan spans five years and begins with a series of test campaigns in 2015. In 2014, the plan was accepted by the IVS Directing Board and presented to the IVS membership at the IVS GM in Shanghai. In the meantime the plan was augmented by a Data Transmission and Correlation Plan.

Two main initiatives are underway to support the test campaigns of 2015.

First, a number of VGOS antennas have now been constructed and have achieved first light and first interferometric fringes. Westford and GGAO have implemented front and back end receivers that are very nearly VGOS compliant. At the same time, a number of other international sites are working hard to put in place VGOS signal chains, with Wettzell, Yebes, and Kokee expected to be ready before the end of the year.

Second, a series of bi-weekly VGOS sessions have been initiated between Westford and GGAO, the goal being to establish a fully operational VGOS methodology. To support this, a so-called “parallel universe” has been put in place at Goddard that completely imitates the Master Schedules, ops mailing list, etc. that have been used for years for the legacy S/X-band operations. In addition, processes are being put in place to automate as much as possible the full operational chain from schedule generation to analysis. The importance of this effort cannot be overemphasized in the quest to move from a VGOS test footing to a full VGOS operational capability.

With these two initiatives underway, the IVS can be optimistic that it will be ready for the VGOS Pilot Project planned for 2016.

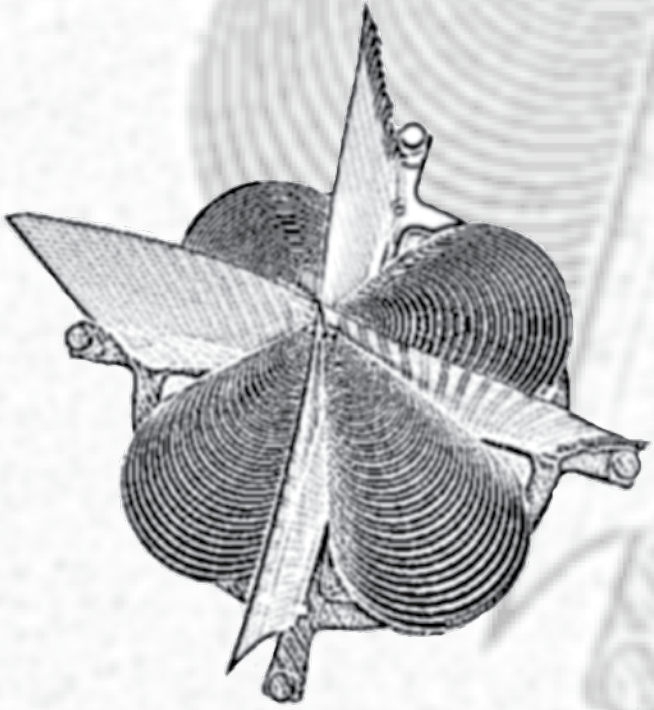

Network Stations



Badary Radio Astronomical Observatory 2014 IVS Annual Report

Sergey Smolentsev, Valery Olifirov, Dmitry Ivanov

Abstract This report provides information about the Badary network station: general information, facilities, staff, present status, activities during 2014, and outlook.

1 General Information

The Badary Radio Astronomical Observatory (Figure 1) was founded by the Institute of Applied Astronomy (IAA) as one of three stations of the Russian VLBI network QUASAR. The sponsoring organization of the project is the Russian Academy of Sciences (RAS). The Badary Radio Astronomical Observatory is situated in the Republic Buryatia (East Siberia) about 130 km east of Baikal Lake (see Table 1). The geographic location of the observatory is shown on the IAA RAS Web site (<http://www.ipa.nw.ru/PAGE/rusipa.htm>). The basic instruments of the observatory are a 32-m radio telescope equipped with special technical systems for VLBI observations and a 13.2-m VGOS antenna. The observatory is also equipped with co-location instruments such as GPS/GLONASS/Galileo receivers, a “DORIS” beacon, and an SLR system. In 2014 a WVR was installed.

Institute of Applied Astronomy of RAS

Badary Network Station

IVS 2014 Annual Report

Table 1 Badary Observatory location and address.

Longitude	102°14'
Latitude	51°46'
Republic Buryatia	
671021, Russia	
oper@badary.ipa.stbur.ru	

2 Technical Staff

Table 2 Staff related to VLBI operations at Badary.

Valery Olifirov	observatory chief
Alex Maklakov	chief engineer, FS, pointing system control
Roman Kuptsov	engineer
Andrey Mikhailov	FS, pointing system control

3 Component Description

3.1 Technical and Scientific Information

Characteristics of the radio telescope are presented in Table 3.

3.2 Co-location of VLBI, GPS/GLONASS, DORIS, and SLR System

Badary observatory is equipped with the Javad GPS/GLONASS/Galileo receiver, The SLR system “Sazhen-TM” (Figure 3), “DORIS” beacon, and



Fig. 1 Badary observatory.

Table 3 Technical parameters of the radio telescope.

Year of construction	2005
Mount	AZEL
Azimuth range	$\pm 270^\circ$ (from south)
Elevation range	from -5° to 95°
Maximum azimuth	
- velocity	$0.83^\circ/\text{s}$
- tracking velocity	$2.5'/\text{s}$
- acceleration	$12.0''/\text{s}^2$
Maximum elevation	
- velocity	$0.5^\circ/\text{s}$
- tracking velocity	$0.8'/\text{s}$
- acceleration	$12.0''/\text{s}^2$
Pointing accuracy	better than $10''$
Configuration	Cassegrain (with asymmetrical subreflector)
Main reflector diameter	32 m
Subreflector diameter	4 m
Focal length	11.4 m
Main reflector shape	quasi-paraboloid
Subreflector shape	quasi-hyperboloid
Main reflector surface accuracy	± 0.5 mm
Frequency range	1.4–22 GHz
Axis offset	3.7 ± 2.0 mm

automatic meteorological station WXT-510 are in operation (Figure 2).

4 Current Status and Activities during 2014

Badary observatory participates in IVS and domestic VLBI observing programs. During 2014, Badary sta-

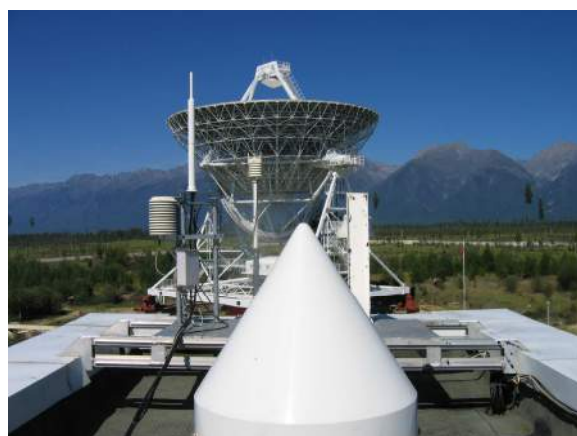

Fig. 2 Javad GPS/GLONASS/Galileo receiver and “DORIS” beacon at the Badary observatory.

tion participated in 49 24-hour IVS sessions — 25 IVS-R4, two IVS-T2, two EUROPE, five R&D, and 15 IVS-CONT.

Badary participated in 48 24-hour sessions in the framework of the domestic Ru-E program for determination of all Earth orientation parameters and in 361 one-hour Ru-U sessions for obtaining Universal Time using e-VLBI data transfer. e-VLBI data transfer is used for Badary observation data for Ru-E sessions too.

Finally, the installation of the 13.2-m antenna system and all necessary equipment is finished. RT-13 (Figure 4) saw “first light” (Figure 5).

In 2014 a WVR was installed and successfully worked (Figure 6).



Fig. 3 “Sazhen-TM” SLR system at Badary observatory observed 2,803 passes of LAGEOS, GLONASS et al. and obtained 22,834 normal points during 2014.



Fig. 4 RT-13 antenna at Badary observatory.

5 Future Plans

Our plans for the coming year are the following:

- To participate in IVS sessions,

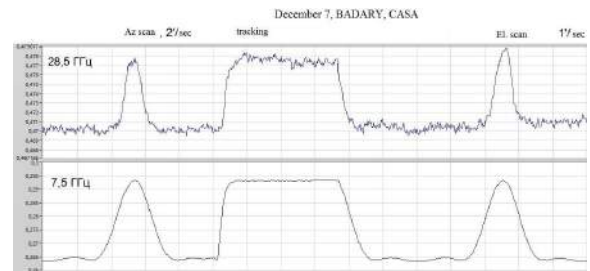

Fig. 5 “First light” of RT-13 antenna at Badary observatory.



Fig. 6 WVR at Badary observatory.

- To carry out domestic observing programs for obtaining Universal Time daily and for obtaining Earth orientation parameters with e-VLBI data transfer weekly,
- To carry out SLR observations of geodetic and navigation satellites,
- To participate in EVN and RADIOASTRON observing sessions,
- To continue geodetic monitoring of the RT-32 parameters,
- To perform WVR measurements on a regular basis,
- To commission RT-13,
- To begin regular observations with RT-13 in 2015.

References

1. Finkelstein A., Ipatov A., Smolentsev S. The Network “Quasar”: 2008-2011 // “Measuring the future”, Proc. of the Fifth IVS General Meeting, A. Finkelstein, D. Behrend (eds.), St. Petersburg, “Nauka”, 2008. pp. 39–46.

Effelsberg Radio Observatory 2014 Annual Report

Uwe Bach, Alex Kraus

Abstract The 100-m radio telescope of the Max-Planck-Institut für Radioastronomie (MPIfR) is one of the largest fully steerable single-dish radio telescopes in the world and a unique high-frequency radio telescope in Europe. The telescope can be used to observe radio emissions from celestial objects in a wavelength range from 90 cm (300 MHz) down to 3.5 mm (90 GHz).

1 General Information

The Effelsberg radio telescope was inaugurated in 1971 and was (for almost 30 years) the largest fully steerable single-dish radio telescope in the world. It is situated in a protected valley near Bad Münstereifel (about 40 km southwest of Bonn) and operated by the Max-Planck-Institut für Radioastronomie (MPIfR) on behalf of the Max-Planck-Society (MPG). To this day, it is the largest radio telescope in Europe and is mostly used for astronomical observations.

This extremely versatile and flexible instrument can be used to observe radio emissions from celestial objects in a wavelength range from about 1 m (corresponding to a frequency of 300 MHz) down to 3.5 mm (90 GHz). The combination of the high surface accuracy of the reflector (the mean deviation from the ideal parabolic form is ~ 0.5 mm rms) and the construction principle of ‘homologous distortion’ (i.e., the reflector in any tilted position has a parabolic shape with a

Max-Planck-Institut für Radioastronomie, Bonn, Germany

Effelsberg Network Station

IVS 2014 Annual Report

well-defined, but shifted, focal point) enables very sensitive observations to be made at high frequencies (i.e., $\nu > 10$ GHz).

The wide variety of observations with the 100-m radio telescope is made possible by the good angular resolution, the high sensitivity, and a large number of receivers which are located either in the primary or in the secondary focus. Together with a number of distinct backends dedicated to different observing modes, this provides excellent observing conditions for spectroscopic observations (atomic and molecular transitions in a wide frequency range), high time-resolution (pulsar observations), mapping of extended areas of the sky, and participation in a number of interferometric networks (IVS, mm-VLBI, EVN, and Global VLBI etc.).

Table 1 Telescope properties.

Name	Effelsberg
Coordinates	6:53:01.0 E,+50:31:29.4 N
Mount	azimuthal
Telescope type	Gregorian (receivers in primary and secondary focus)
Diameter of main reflector	100 m
Focal length of prime focus	30 m
Focal length of secondary focus	387.7 m
Surface accuracy	0.55mm rms
Slew rates	Azi: 25 deg/min, Elv: 16 deg/min
Receivers for Geodetic observations	3.6 cm/13 cm secondary-focus (coaxial)
T_{sys} (3.6 cm/13 cm)	25 K, 200 K
Sensitivity (3.6 cm/13 cm)	1.4 K/Jy, 0.5 K/Jy
HPBW (3.6 cm/13 cm)	81 arcsec, 350 arcsec
Tracking accuracy	~ 2 arcsec

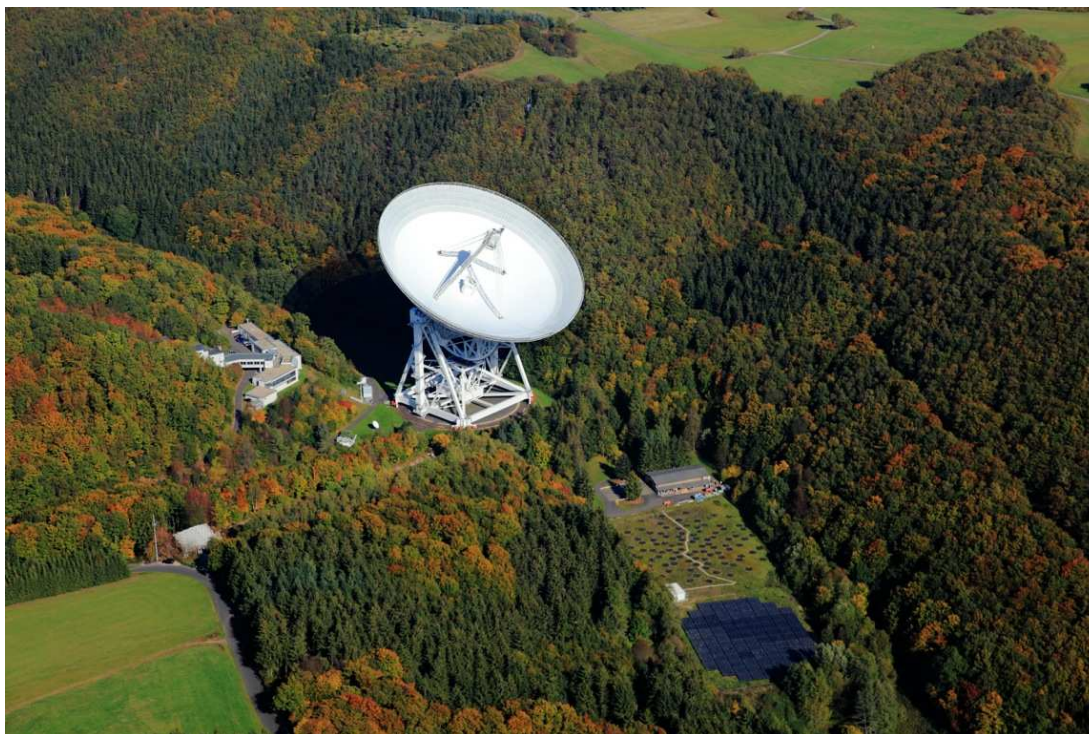

Fig. 1 Aerial image of the Effelsberg radio observatory. Shown are the 100-m Effelsberg antenna and the institute's building (left of the antenna). Effelsberg hosts also a station of the European Low Frequency Array (LOFAR), seen in the lower part of the picture.

2 Staff

The staff at Effelsberg consists of about 40 people, including telescope operators, technical personnel for receivers, electronics, and mechanics, scientists, and administrative personnel. Involved in IVS activities are, beside the telescope operators, **Dr. Alexander Kraus** as station manager and scheduler for the 100-m Effelsberg telescope, **Dr. Uwe Bach** as support scientist and VLBI friend, and **Thomas Georgi** for VLBI support.

3 Activities during the Past Year

Effelsberg has participated regularly in the EUROPE IVS sessions since 1991. In 2014, the experiments EUR129 and EUR132 were observed. About 30% of the observing time of the Effelsberg antenna is used for VLBI observations. Most of them are astronomical observations for the European VLBI Network (EVN), High Sensitivity Array (HSA), Global MM

VLBI Array (GMVA) or other global networks, but also geodetic VLBI observations within the IVS are performed. Since 2011, the Russian Astro Space Center has been operating a 10-m space radio antenna on board the satellite SPEKTR-R (RadioAstron) to perform VLBI observations. Effelsberg is highly involved in the ground based support of this mission, and 262 of a total of 455 VLBI observations in 2014 were connected to RadioAstron observations.

To reduce the gain elevation dependence for secondary focus observations, the 6.5-m diameter sub-reflector of the Effelsberg antenna consists of 96 individual panels with actuators. The panels are adjusted for each elevation via a look-up table based on the finite element model that describes the gravitational deformations of the main dish. To further improve the look-up table, a holography technique which can produce low resolution maps of the wavefront-errors in an antenna surface using astronomical observations was tested at Effelsberg. This “out-of-focus (OOF)” holography requires — in contrast to traditional holography measurements — only several focused and out of focus

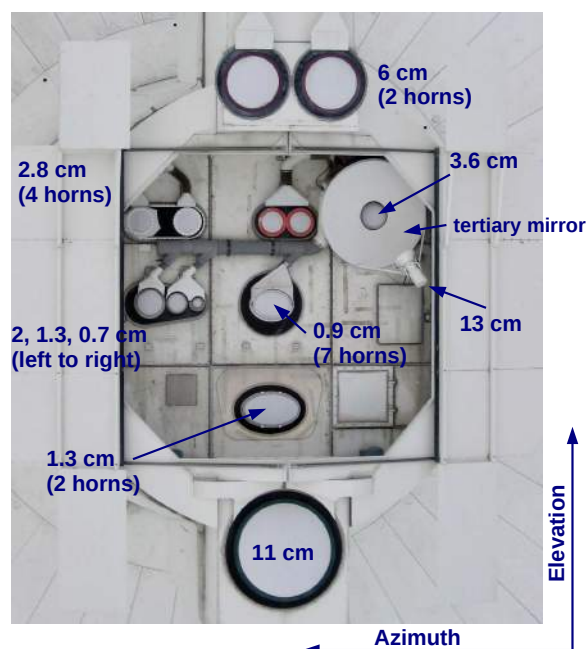

Fig. 2 Picture of the secondary focus cabin with several astronomical receivers, e.g. the new K-band with two horns and the geodetic SX system with the 3.6-cm horn and the tertiary mirror for the 13-cm horn.

images of a compact source at a good signal to noise ratio. The study is still in progress, but some promising measurements were obtained and were reported at the EVN Symposium (Bach U., 2014, PoS (12th EVN Symposium) 036, in press).

A new K-band receiver (18 to 26 GHz) was installed in the secondary focus in 2014 (see Figure 2). The commissioning is in progress, and first VLBI fringes were obtained in the second EVN Session in June 2014. The system will soon replace the old K-band VLBI receiver.

4 Current Status

Effelsberg uses the DBBC2 and a Mark 5B+ recorder for all EVN, global, and geodetic VLBI observations. In addition there are two NRAO RDBEs and a Mark 5C recorder that are used for observations with the VLBA, HSA, and GMVA. Both VLBI backends and their recorders are controlled by the Field System (current release FS-9.11.6). The observatory is connected via a 10 GE optical fiber to the e-VLBI

network and can do real time e-VLBI observations and e-transfer of data to Bonn and JIVE.

5 Future Plans

Upgrades for several receiving systems are planned for 2015. A new C-band system (4-8/9.3 GHz) for wideband observations has been constructed and will be installed in the secondary focus within the next month. The installation of a new Q-band receiver (38 to 50 GHz) is planned for autumn 2015. The new receivers will provide wideband IF signals of 2.5 GHz and 4 GHz bandwidth which can be used with the next generation of digital VLBI backends and recorders (e.g. DBBC3 and Mark 6) to record data at recording rates of up to 32 Gbps.

Two Mark 6 recorders are currently tested in the lab in Bonn and will be installed in Effelsberg soon. The installation of a DBBC3 is planned for summer 2015. It is planned to replace the shipment of modules for all EVN observations to JIVE by e-transfers via the e-VLBI network using a Mark 6 recorder in raid mode.

Fortaleza Station 2014 Annual Report

Pierre Kaufmann¹, A. Macilio Pereira de Lucena², Adeildo Sombra da Silva¹

Abstract This is a brief report about the activities carried out at the Fortaleza geodetic VLBI station (ROEN: Rádio Observatório Espacial do Nordeste), located in Eusébio, CE, Brazil, during the period from January until December 2014. The total observed experiments consisted of 118 VLBI sessions and continuous GPS monitoring recordings. About 90% of VLBI recorded data was transmitted through the high speed network.

1 General Information

The Rádio Observatório Espacial do Nordeste, ROEN, located at INPE facilities in Eusébio, nearly 30 km east of Fortaleza, Ceará State, Brazil, began operations in 1993. Geodetic VLBI and GPS observations are carried out regularly, as contributions to international programs and networks. ROEN is part of the Brazilian space geodesy program, which was initially conducted by CRAAE (a consortium of the Brazilian institutions Mackenzie, INPE, USP, and UNICAMP) in the early 1990s. The program began with antenna and instrumental facilities erected, with activities sponsored by the U.S. agency NOAA and the Brazilian Ministry of Science and Technology's FINEP agency.

ROEN is currently coordinated by CRAAM, Center of Radio Astronomy and Astrophysics, Engineering School, Mackenzie Presbyterian University, São Paulo, in agreement with the Brazilian National Space

1. Universidade Presbiteriana Mackenzie, CRAAM and INPE, Rádio Observatório Espacial do Nordeste, ROEN

2. Instituto Nacional de Pesquisas Espaciais, INPE

Fortaleza Network Station

IVS 2014 Annual Report

Research Institute, INPE. The activities are currently carried out under an Agreement of Cooperation which was signed between NASA—representing research interests of NOAA and USNO—and the Brazilian Space Agency, AEB and which was extended until 2021. Under the auspices of the NASA-AEB Agreement, a contract was signed between NASA and CRAAM, Mackenzie Presbyterian Institute and University to partially support the activities at ROEN. In 2014, the contract was renewed for four more years.

The counterpart of the operational costs, staff, and support of infrastructure are provided by INPE and by Mackenzie.

2 Main Instruments

The largest instrument at ROEN is the 14.2-m radio telescope on an alt-azimuth positioner. It is operated at S- and X-bands, using cryogenic radiometers. The system is controlled by the Field System, Version 9.11.6. Observations are recorded with a Mark 5A system and transmitted through a high speed network either to the U.S. (WACO and Haystack correlators) or to the Bonn correlator in Germany at rates about 220 Mbps. The 1 Gbps link was accomplished in 2007. It integrates and is sponsored by the Brazilian Research Network — RNP. One Sigma-Tau hydrogen maser clock standard is operated at ROEN. GPS monitoring is performed within a cooperative program with NOAA (USA). There is a Leica System 1200 installed at the station that operates continuously. The collected data are provided to the NOAA/IGS center and to the Brazilian IBGE center. ROEN has all basic infrastruc-



Fig. 1 14.2-m radio telescope.

tures for mechanical, electrical, and electronic maintenance of the facilities.

3 Staff

The Brazilian space geodesy program is coordinated by one of the authors (Pierre Kaufmann), who is Brazil's AEB representative in the NASA-AEB Agreement. The coordination receives support from the São Paulo office at CRAAM/Instituto and Universidade Presbiteriana Mackenzie, with administrative support from Valdomiro M. S. Pereira and Lucíola Melissa Russi. The Fortaleza Station facilities and geodetic VLBI and GPS operations are managed on site by Dr. Antonio Macilio Pereira de Lucena (INPE), assisted by Eng. Adeildo Sombra da Silva (Mackenzie), and the technicians Avicena Filho (INPE) and Francisco Renato Holanda de Abreu (Mackenzie).

4 Current Status and Activities

4.1 VLBI Observations

In addition to the regular experiments, Fortaleza participated in the CONT14 campaign during 2014. It consisted of 15 days of continuous observations whose main goal was to acquire state-of-the-art VLBI data over a time period of about two weeks to demonstrate the highest accuracy of which the current VLBI system is capable. All sessions of geodetic VLBI are described in Table 1.

Table 1 2014 session participation.

Experiment	Number of Sessions
IVS-R1	37
IVS-R4	50
IVS-T2	03
R&D	04
CONT14	15
CRF	03
OHIG	06

4.2 Operational and Maintenance Activities

The summary of activities performed in the period is listed below:

1. Repair and maintenance of the following equipment: cryogenic system, Mark IV video converters, Mark 5A recorder, antenna control electronic system, angle encoder system.
2. Adjustment in cavity control system of SigmaTau maser.
3. Field system updating.
4. Mark 5A recorder operational system and software restoration.
5. Installation of a new UPS system.
6. Operation and maintenance of geodetic GPS (NOAA within the scope of NASA contract).
7. Operation and maintenance of power supply equipment at the observatory (main and diesel driven standby).

8. Transferring of recorded data through high speed network part of and sponsored by the Brazilian Research Network — RNP.

4.3 GPS Operations

The IGS network GPS receiver operated regularly at all times during 2014. Data were collected and uploaded to an IGS/NOAA computer.

Goddard Geophysical and Astronomical Observatory

Ricardo Figueroa, Jay Redmond, Katherine Pazamickas

Abstract This report summarizes the technical parameters and the technical staff of the VLBI system at the fundamental station GGAO. It also gives an overview about the VLBI activities during the 2014 report year. The outlook lists the outstanding tasks to improve the performance of GGAO.

1 GGAO at Goddard

The Goddard Geophysical and Astronomical Observatory (GGAO) consists of a 5-meter radio telescope for VLBI, a new 12-meter radio telescope for VLBI2010 development, a 1-meter reference antenna for microwave holography development, an SLR site that includes MOBLAS-7, the NGSLR development system, a 48'' telescope for developmental two-color Satellite Laser Ranging, a GPS timing and development lab, a DORIS system, meteorological sensors, and a hydrogen maser. In addition, we are a fiducial IGS site with several IGS/IGSX receivers.

GGAO is located on the east coast of the United States in Maryland. It is approximately 15 miles NNE of Washington, D. C. in Greenbelt, Maryland (Table 1).

NASA Goddard Space Flight Center

GGAO Network Station

IVS 2014 Annual Report

Table 1 Location and addresses of GGAO at Goddard.

Longitude	76.4935° W
Latitude	39.0118° N
MV3 Code 299.0 Goddard Space Flight Center (GSFC) Greenbelt, Maryland 20771	
http://cddisa.gsfc.nasa.gov/ggao/vlbi.html	

2 Technical Parameters of the VLBI Radio Telescopes at GGAO

The 5-m radio telescope for VLBI at MV3 was originally built as a transportable station, but it was moved to GGAO in 1991 and has been used as a fixed station. In the winter of 2002 the antenna was taken off its trailer and permanently installed at GGAO.

In October of 2010, construction of the new 12-meter VLBI2010 developmental antenna was completed. This antenna features all-electric drives and a Cassegrain feed system. Integration of the broadband receiver and the associated sub-systems is underway as a joint effort between Exelis and the MIT Haystack Observatory.

The technical parameters of the radio telescopes are summarized in Table 2.

3 Technical Staff of the VLBI Facility at GGAO

GGAO is a NASA R&D and data collection facility and is operated under the Space Communication Network Services (SCNS) contract by Exelis Inc. The staff

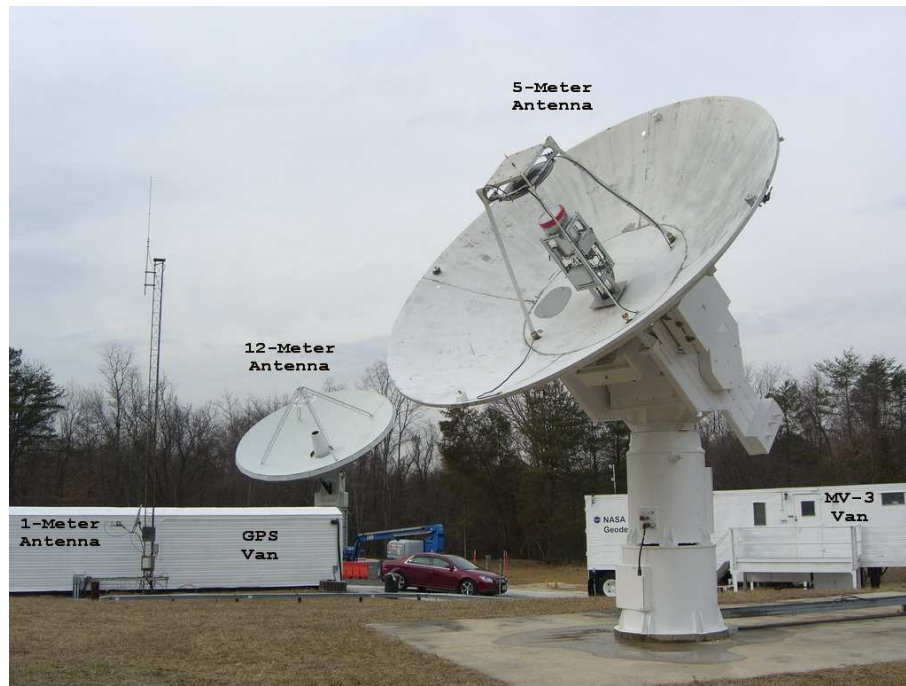

Fig. 1 Goddard Geophysical and Astronomical Observatory.

Table 2 Technical parameters of the radio telescopes at GGAO.

Parameter	5-m	12-m
Owner and operating agency	NASA	NASA
Year of construction	1982	2010
Diameter of main reflector d	5m	12m
Azimuth range	$\pm 270^\circ$	$\pm 270^\circ$
Azimuth velocity	$3^\circ/s$	$5^\circ/s$
Azimuth acceleration	$1^\circ/s^2$	$1^\circ/s^2$
Elevation range	$\pm 90^\circ$	$5 - 88^\circ$
Elevation velocity	$3^\circ/s$	$1.25^\circ/s(\text{Avg.})$
Elevation acceleration	$1^\circ/s^2$	$1^\circ/s^2$
Receiver System		
Focus	Cassegrain	Cassegrain
Receive Frequency	2 – 14GHz	2 – 14GHz
T_{sys}	100K	50K(Theoretical)
Bandwidth	512MHz, four bands	512MHz, four bands
G/T	26dB/K	43dB/K
VLBI terminal type	CDP	VLBI2010
Recording media	Mark IV	Mark 5C

at GGAO consists mainly of two operators and one backup engineer. The Exelis staff includes Jay Redmond and Katherine Pazamickas conducting VLBI operations and maintenance at GGAO with the support of Ricardo Figueroa.

4 Status of MV3 and VLBI2010 at GGAO

Having ceased VLBI operations in May 2007, MV3 continues on a full time basis to be a major component in the program to demonstrate the feasibility of the VLBI2010 broadband delay concept. Under the guid-

ance of the Exelis team, the majority of MV3's S/X components were upgraded, and antenna refurbishing should be completed by early 2015 to provide additional support to the VLBI2010 System. Tasks started in 2013 and finished in 2014 for the 5-m antenna included the following:

- The 017 Electronic Box was refurbished, and new wiring and upgraded components were installed.
- The Cryogenic Dewar and its components were restored for X-band operations. Also, the cryogenic thermometer, vacuum gauge, and bias voltage box were installed and tested.
- The FSS Subreflector and Feed assembly, including the FSS, was recoated with a highly reflective surface, repaired, and placed back on the antenna.
- The ACU and control panel are in the process of upgrade and troubleshooting.
- Two of the Sargent Welch Director Model 8816-Bs were refurbished using a repair kit. One was mounted and tested in the antenna.

Much of the 2014 activities at GGAO focused on performance testing and upgrading of the VLBI2010 12-m antenna. But some other activities worth noting included:

- Continued wideband system testing and characterization of the 12-m antenna.
- Procurement of new test equipment for characterization of the wideband RF hardware.
- Continued broadband phase cal and cable cal performance testing.
- Integration of RDBEs, Mark 6 recorder, UDC, and Field System computer software.
- Installation of RDBE-G hardware.
- VLBI observations between Westford and GGAO with RDBE-G hardware/software and the Mark 6 recorder.
- Upgrade of timing distribution and standardization of broadband rack cables.
- Additional testing of 16 Gbps VLBI recording, demonstrated using the Mark 6 recorder.
- Refurbishing of the 5-meter antenna control unit and vacuum system.

5 Outlook

GGAO will continue to support VLBI2010, e-VLBI, and other developmental activities during the upcoming year. Tentative plans for 2015 include plans to:

- Continue to upgrade the VLBI2010 broadband receiver system on the 12-m antenna.
- Conduct IVS observations using the Mark 6 recorders to demonstrate the VLBI2010 capabilities on a regular twice a month schedule.
- Continue testing of the new broadband phase calibrator for the VLBI2010 system.
- Continue the upgrade of the 5-m antenna and initiate testing in S/X band.
- Continue to measure the baseline between the 5-m and the 12-m antennas for position ties to the reference frame.
- Try to understand the source of the azimuth and elevation gearboxes' oil contamination.
- Try to understand why the antenna will not move in elevation under computer control when first started up on cold mornings.

Hartebeesthoek Radio Astronomy Observatory (HartRAO)

Marisa Nickola, Jonathan Quick, Ludwig Combrinck

Abstract HartRAO provides the only fiducial geodetic site in Africa and participates in global networks for VLBI, GNSS, SLR, and DORIS. This report provides an overview of geodetic VLBI activities at HartRAO during 2014, including the 15-m radio telescope taking over from the 26-m for the majority of sessions, progress with the VGOS project, and preparations for hosting the 9th IVS General Meeting in 2016.

1 Geodetic VLBI at HartRAO

Hartebeesthoek is located 65 km northwest of Johannesburg, just inside the provincial boundary of Gauteng, South Africa. HartRAO is located 32 km away from the nearest town, Krugersdorp. The telescopes are situated in an isolated valley which affords protection from terrestrial radio frequency interference. HartRAO currently operates both a 15-m and a 26-m radio telescope. The 26 m is an equatorially mounted Cassegrain radio telescope built by Blaw Knox in 1961. The telescope was part of the NASA deep space tracking network until 1974 when the facility was converted to an astronomical observatory. The 15 m is an alt-az radio telescope built as a Square Kilometre Array (SKA) prototype during 2007 and converted to an operational geodetic VLBI antenna during 2012. The telescopes are co-located with an ILRS SLR station (MOBLAS-6), an IGS GNSS station (HRAO), a seismic vault, and an IDS DORIS station (HBMB) at the

HartRAO

HartRAO Network Station

IVS 2014 Annual Report

adjoining South African National Space Agency Earth Observation (SANSA EO) site. HartRAO is also a full member of the EVN.



Fig. 1 Please join us for the 9th IVS General Meeting to be held in South Africa in March 2016!

2 Technical Parameters of the 15-m and 26-m Telescopes of HartRAO

Table 1 contains the technical parameters of the HartRAO 15-m and 26-m radio telescopes, while Table 2 and Table 3 contain technical parameters of the HartRAO 15-m and 26-m receivers, respectively. The current data acquisition systems consist of a DBBC terminal and a Mark 5B+ recorder for both the 15-m and the 26-m antennas. A Mark 5B and a Mark 5C recorder are used for e-transfer of data and conditioning and testing of disk packs. Three hydrogen masers are available for use, namely the EFOS-28,

which is currently employed for VLBI on the 15-m antenna, as well as two spares – iMaser 72, currently employed on the 26-m antenna, and the resuscitated EFOS-6.

Table 1 Antenna parameters.

Parameter	Hart15M	HartRAO
Owner and operating agency	HartRAO	HartRAO
Year of construction	2007	1961
Radio telescope mount	Az-El	Offset equatorial
Receiving feed	Prime focus	Cassegrain
Diameter of main reflector d	15 m	25.914 m
Focal length f	7.5 m	10.886 m
Focal ratio f/d	0.5	0.42
Surface error of reflector (RMS)	1.6 mm	0.5 mm
Short wavelength limit	2 cm	1.3 cm
Pointing resolution	0.001°	0.001°
Pointing repeatability	0.004°	0.004°
Slew rate on each axis	Az: 2° s ⁻¹ El: 1° s ⁻¹	HA: 0.5° s ⁻¹ Dec: 0.5° s ⁻¹

Table 2 Parameters of the 15-m co-axial receiver.

Parameter	X-band	S-band
Feeds	stepped horn	wide-angle corrugated horn
Amplifier type	cryo HEMT	cryo HEMT
T_{sys} (K)	40	42
S_{SEFD} (Jy)	1400	1050
PSS (Jy/K)	35	25
3 dB beamwidth (°)	0.16	0.57

Table 3 Parameters of the 26-m receiver (degraded performance due to dichroic reflector being used for simultaneous S-X VLBI).

Parameter	X-band	S-band
Feeds	dual CP conical	dual CP conical
Amplifier type	cryo HEMT	cryo HEMT
T_{sys} (K)	52	40
S_{SEFD} (Jy)	849	1190
PSS (Jy/K)	16.3	29.8
3 dB beamwidth (°)	0.096	0.418

3 Current Status

During 2014, the 15-m antenna took over much of the 26 m's workload with the number of sessions in-

volving HART15M more than doubling the previous year's number. The 15-m antenna joined in its first OHIG sessions in February and successfully participated in its first CONT campaign during May 2014, taking over from the 26-m antenna, which was involved in previous CONT02, CONT05, CONT08, and CONT11 campaigns. During September 2014, the 15-m antenna also participated in its second AUSTRAL-CONT campaign. In contrast to the increased number of sessions run on the 15-m antenna, the 26 m's workload nearly halved compared to that of 2013. Eight dual experiments, four R1s, and four AUSTs, with both the 15-m and 26-m antennas observing, were performed during the year. On the 4th of August 2014 at 10:22:33 UT during one of these dual sessions, R1647, the Orkney earthquake occurred approximately 100 km from HartRAO, registering a magnitude of 5.5 on the Richter scale. The 15-m and 26-m antennas each also participated in two Chinese Lunar Lander Chang'E-3 RD/OCEL sessions during 2014. Geodetic VLBI data for all but the RDV sessions were e-transferred to the correlators. Telescope time allocation for geodetic VLBI in 2014 consisted of 122 sessions for the 15-m and 31 sessions for the 26-m antenna (Table 4). On the 23rd of April 2014 the 22 GHz receiver was installed on the 26-m antenna. It will be used for astrometric VLBI to help improve the ICRF. During observation of the bright AGN J1427-4206 with the HartRAO 26-m, Hobart 26-m, and Tidbinbilla 70-m antennas during a 24-hour astrometric VLBI on 4-5 May, interference fringes were detected. The process of procuring the VGOS antenna started in 2014 with the granting of exemption from an EIA, the completion of a DC resistivity ground survey, and an RFI study showing no activity in the requisite bands. During April 2014, Ludwig Combrinck installed a seismometer and accelerometer on Marion Island, repaired the DORIS system, surveyed it in and tied it to the GNSS receiver with GPS. As part of the development of the new Lunar Laser Ranger, the laser systems from Ekspla were commissioned from 18-22 November 2014.

4 Personnel

On the 14th of August 2014 our director, Dr. Mike Gaylard, passed away. Space geodesy program leader, Professor Ludwig Combrinck, is

Table 4 Geodetic VLBI experiments in which HartRAO participated during 2014.

Experiment	No. of sessions on 15 m	No. of sessions on 26 m
R1	36	5
AUST	26	7
AUST14	17	0
CONT14	15	0
R4	15	0
RD	7	5
OHIG	4	2
RDV	2	1
CRDS	0	6
CRF	0	3
T2	0	2
Total	122	31

currently HartRAO's acting director. Table 5 lists the HartRAO station staff involved in geodetic VLBI. Jonathan Quick (VLBI friend) provides technical support for the Field System as well as for hardware problems. Philip Mey, project manager of the VGOS radio telescope, has joined the geodetic VLBI team as a trainee operator at the end of 2014. Ludwig Combrinck, Aletha de Witt, Denise Dale, Sayan Basu, Glenda Coetzer, and Marisa Nickola attended the 8th IVS General Meeting in Shanghai, China held 2-7 May 2014, and all contributed with presentations or posters. Ludwig invited the IVS family to join us under African skies for the 9th IVS General Meeting to be held in South Africa in March 2016. Alet represented HartRAO in the IAU's ICRF-3 working group during this meeting and the subsequent 'REFAG, Symposium 2014 on Reference Frames for Applications in Geosciences' held in Luxembourg in October 2014. Philip and Ludwig visited the Wettzell Observatory in Germany during September 2014 to learn about the VGOS Twin Telescope and discuss antenna design.

5 Future Plans

200 sessions are scheduled for 2015, 30 of those on the 26-m antenna with the remainder having been allocated to the 15 m. Hart15M will participate in AUSTRAL-CONT campaigns during February and June 2015. VGOS activities planned for 2015 include core drilling to determine the depth to bedrock, digging of trenches and laying of cables, award of tender for construction and laying of foundation, and the

Table 5 Staff supporting geodetic VLBI at HartRAO.

Name	Function	Program
L. Combrinck	Program Leader	Geodesy
J. Quick	Hardware/Software	Astronomy
R. Botha	Operator	Geodesy
J. Grobler	Operator	Technical
P. Mey	Operator	Geodesy
R. Myataza	Operator	Technical
M. Nickola	Logistics/Operations	Geodesy
P. Stronkhorst	Operator	Technical
C. Zondi	Operator	Technical

subsequent construction of the VGOS antenna. Work on the Lunar Laser Ranger (LLR) project will continue during 2015. Alet will attend the 22nd Working Meeting of the European VLBI Group for Geodesy and Astrometry in Saõ Miguel, Azores in May 2015 as well as the 2015 IAU General Assembly in Honolulu, Hawaii in August 2015, representing HartRAO at the IAU's ICRF-3 working group meetings. Preparations for hosting the 9th IVS General Meeting in March 2016 will also be a priority during 2015.

Acknowledgements

HartRAO is a National facility operating under the auspices of the National Research Foundation (NRF), South Africa. The Space Geodesy Programme is an integrated program, combining VLBI, SLR, and GNSS, and it is active in several collaborative projects with GSFC, JPL, and GFZ (Potsdam) as well as numerous local institutes. Collaboration also includes CNES/GRGS/OCA and the ILRS community in a Lunar Laser Ranger (LLR) project with local support from the University of Pretoria and the National Laser Centre (CSIR), among others. General information as well as news and progress on geodesy and related activities can be found at <http://geodesy.hartrao.ac.za/>.



Fig. 2 Hamba kahle, Mike.



Fig. 5 Pieter, Alet, Jon and Keith getting ready for K-band's welcoming celebration — Hello Kitty!



Fig. 3 The 15 m antenna in action during CONT14.



Fig. 6 Philip's rig for measuring RFI at the proposed VGOS site.



Fig. 4 The 22 GHz receiver, installed on the 26 m on 23 April 2014.



Fig. 7 Seismometer installation on Marion Island with DORIS hut in background.

AuScope VLBI Project and Hobart 26-m Antenna

Jim Lovell¹, John Dickey¹, Brett Reid¹, Jamie McCallum¹, Stas Shabala¹, Lucia Plank¹, Elizaveta Rastorgueva-Foi¹, Imogen Jones¹, Christopher Watson², Simon Ellingsen¹, Anthony Memin¹

Abstract This is a report on the activities carried out at the University of Tasmania in support of the three AuScope VLBI observatories and the Hobart 26-m antenna. In 2014 the antennas participated in 185 IVS sessions for a total of 551 antenna days of observing, 289 more than in 2013. An increase in operations funding in 2013 enabled us to increase our observing load, including 73 days per year for AUSTRAL, which is focused on high priority geodetic and astrometric programs in the southern hemisphere. All four antennas participated in the 15-day CONT14 campaign as well as a similar AUSTRAL 15-day session in September. In this report we also briefly highlight our research activities during 2014 and our plans for 2015.

1 General Information

As part of AuScope (www.auscope.org.au), the University of Tasmania (UTAS) operates the AuScope VLBI Array (Lovell et al., 2013), three 12-m diameter radio telescopes on the Australian continent (Figure 1), located near Hobart (Tasmania), Yarragadee (Western Australia), and Katherine (Northern Territory).

The Hobart telescope (Hb) is co-located with the existing 26-m telescope (Ho) to preserve the more than 20 year VLBI time series at the site. Midway between the 26-m and 12-m telescopes is the HOB2 GNSS installation which has been a core site of the International GNSS Service (IGS) since its conception. A hut capa-

ble of housing a mobile gravimeter is also co-located on the site. The Yarragadee telescope (Yg) provides a far western point on the continent and is co-located with multiple existing geodetic techniques including SLR, GNSS, DORIS, and gravity. The Katherine site (Ke) is new and provides a central longitude, northern site. The telescope at Katherine is co-located with a new GNSS site that forms part of the AuScope GNSS network.

Each AuScope VLBI observatory is equipped with a 12.1-m diameter main reflector. The telescope specifications include: 0.3 mm of surface precision (RMS), fast slewing rates (5 deg/s in azimuth and 1.25 deg/s in elevation), and acceleration of 1.3 deg/s/s. All three sites are equipped with dual polarization S- and X-band feeds with room temperature receivers covering 2.2 to 2.4 GHz at S-band and 8.1 to 9.1 GHz at X-band. System Equivalent Flux Densities (SEFDs) are 3500 Jy in both bands. Data digitization and formatting is managed by the Digital Base Band Converter (DBBC) system, and data are recorded using the Mark 5B+ system. Each site is equipped with a Hydrogen maser time and frequency standard.

All three observatories were designed and constructed to be remotely controlled and monitored to keep operating costs at a minimum. The operation of the AuScope VLBI array is being carried out from a dedicated operations room on the Sandy Bay campus of the University of Tasmania.

2 Staff

The staff at UTAS consist of academics, Prof. John Dickey (director), Dr. Simon Ellingsen, Dr. Christo-

1. School of Mathematics and Physics, University of Tasmania

2. School of Land and Food, University of Tasmania

Hobart 12 m and 26 m, Katherine, and Yarragadee

IVS 2014 Annual Report



Fig. 1 The AuScope VLBI array and Hobart 26 m.

pher Watson, and Prof. Peter McCulloch. Dr. Jim Lovell is Project Manager for the AuScope VLBI project. Dr. Jamie McCallum, Dr. Stas Shabala, Dr. Lucia Plank, Dr. Elizaveta Rastorgueva-Foi, and Dr. Anthony Memin are post-doctoral fellows who are carrying out research aimed at improving geodetic solutions in the southern hemisphere. Mr. Brett Reid is the Observatory Manager whose position is funded by the university, and Ms. Imogen Jones is employed to assist in operations and media logistics in particular. In addition we have an electronics technical officer, Mr. Eric Baynes. For the operation of the observatories during geodetic observations we rely heavily on support from the astronomy PhD and post graduate students. Logistical and maintenance support at Katherine is provided by Mr. Martin Ephgrave and at Yarragadee by Mr. Randall Carman and team at the MOBLAS5 SLR station.

3 Geodetic VLBI Observations

In 2014 the AuScope and Hobart 26-m antennas participated in 185 IVS sessions (up from 111 in 2013 and 72 in 2012) for a total of 551 antenna days of observing, 289 more than in 2013 and 404 more than in 2012. All antennas participated in the 15-day CONT14 campaign. A summary of the observations is presented in Table 1

Table 1 AuScope and Hobart 26-m antenna participation (number of days) in IVS sessions in 2014. The AUST14 series of observations was a 15-day CONT-like session as part of the AUSTRAL program, divided into 17 sessions (some lasted less than 24 hours).

Session	Antenna			
	Ho	Hb	Ke	Yg
APSG		2	2	2
AUST14		17	17	17
AUSTRAL	3	55	56	54
CONT14	15	15	15	15
CRDS	6	6	6	6
CRF		3	3	3
OHIG		5	6	6
R&D	9	2	2	2
R1		31	29	30
R4		36	34	35
T2		1	2	2
Total	33	173	172	172

3.1 The AUSTRAL Program

The ~ 60 day per year AUSTRAL Program commenced in July 2013. Observations are being made with the three AuScope antennas as well as the Warkworth 12 m and Hartebeesthoek 15 m. The Hobart 26 m and Hartebeesthoek 26 m also participate for some AUSTRAL observations. Scheduling is carried out in VieVS, and data are correlated at the Curtin University software correlator.

The AUSTRAL observing program is divided into three streams focused on high priority geodetic and astrometric aims in the southern hemisphere:

1. astrometric observations to monitor and enhance the southern hemisphere reference frame in preparation for ICRF3;
2. regular observations to improve the density of the geodetic time series for the southern antennas and to measure and monitor the motion and deformation of the Australian plate;
3. four 15-day CONT-like sessions over two years to demonstrate the full capabilities of the array, characterize the level of systematic errors caused by the troposphere and source structure and develop and trial error mitigation strategies. One session was held in 2013 and another in 2014, and two are scheduled for 2015.

The AUSTRAL sessions are subject to steady improvements. Thanks to improved scheduling (in cooperation with the Vienna University of Technology), more frequent observations with four and five station networks and improved observations, results in terms of baseline length repeatabilities have been improved significantly. Figure 2 shows the dramatic improvement in baseline repeatability in AUSTRAL sessions following a change in scheduling strategy after AUST30 in July 2014.

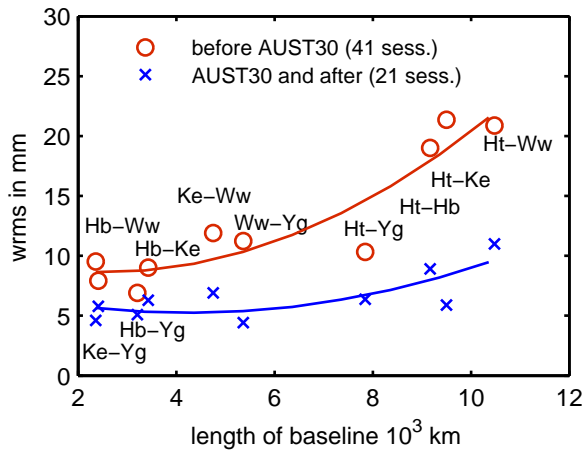

Fig. 2 Baseline length repeatabilities of the AUSTRAL sessions before and after a change in the scheduling strategy.

3.1.1 Post-correlation Data Processing

Starting in late 2012, the University of Tasmania began handling the post-correlation processing of the AUSTRAL experiments correlated at Curtin University. All AUSTRAL data are now post-processed at UTAS and submitted to the IVS as version 1 databases.

4 Research Activities

We have made further progress in investigation of the effects of quasar structure on geodetic solutions. Using the VieVS source structure simulator (Shabala et al. 2015) developed in close collaboration with the TU Wien group led by Johannes Böhm, we have performed simulations to confirm that source structure contributes at the millimeter level to present-day station position determination. Hence the accuracy of present-day measurements is dominated by the stochastic wet troposphere, but quasar structure will become important in the VGOS era. We have also investigated via simulations the possibility of modifying scheduling strategies to include source structure information. This approach appears promising once tropospheric noise is reduced from being the single dominant component in geodetic solutions.

An active area of current investigation is the impact of structure on the CRF, where this effect appears to be much stronger than on the TRF. We have run a number of simulations for various levels of structure, and a paper (Plank et al.) is currently in preparation. Observationally, the thesis work of Rob Schaap (2014) found a strong relationship between the quasar structure index, flux density, and astrometric stability: for a given variable quasar, its astrometric position is most stable and its structure minimized when its flux density is at a maximum. This may be a useful tool for selecting suitable quasars for IVS observations.

A new area of research started last year is the use of sibling telescopes, i.e. the 26-m and the 12-m antennas at Hobart, to determine the local baseline (tie) as measured by VLBI. Several sessions including the 12-m and the 26-m telescopes were observed in 2014, with the analysis ongoing at the moment.

5 References

1. Lovell, J. E. J. et al., 2013, *J. Geod.* 87, 527.
2. Schaap et al. 2014, *J. Geod.* 88, 575.
3. Shabala et al. 2015, *J. Geod.* in press.

Kashima 34-m VLBI Station

M. Sekido, E. Kawai

Abstract The Kashima 34-m diameter radio telescope is maintained by Space Time Standards Laboratory of NICT. Development of its broadband VLBI system has been conducted in the frequency transfer project. Its narrow beam width broadband feed was originally developed for a Cassegrain type 34-m antenna, and the first light observation was performed successfully in January 2014. In addition to the R&D VLBI experiments for frequency transfer and astronomical observations, the 34-m radio telescope has been regularly participating in IVS sessions.

1 General Information



Fig. 1 The Kashima 34-m radio telescope.

NICT Space-Time Standards Laboratory/Kashima Space Technology Center

NICT Kashima Network Station

IVS 2014 Annual Report

The 34-m diameter radio telescope has been maintained and operated by the VLBI group of Space Time Standards Laboratory (STSL) in the National Institute of Information and Communications Technology (NICT). It is located in the Kashima Space Technology Center (KSTC), which is at the east coast of the main island of Japan. Development of VLBI technology for distant frequency transfer (project name: GALA-V) is the current main mission of the VLBI project in NICT. Development of a broadband VLBI observation system is conducted in the GALA-V project. The observation frequency range and data acquisition system (DAS) of the GALA-V project are designed in the scope of joint VLBI observations with a VGOS system.

2 Component Description

2.1 Receivers

The Kashima 34-m antenna has multiple receiver systems from L-band up to Q-band. The performance parameters for each frequency are listed in Table 1. Receiving bands are changed by exchanging receiver systems at the focal point of the antenna. Each receiver is mounted on one of four trolleys, and only one trolley can be at the focal position. The focal point is adjusted by the altitude of the sub-reflector via motion of five axes actuators. When a feed system is newly mounted, the sub-reflector position is adjusted for that. The detail of each receiver status is as follows:

L-band: Influence of Radio Frequency Interference (RFI) caused by a cell phone base station was reduced by installation of a superconductor filter in

Table 1 Antenna performance parameters of the Kashima 34-m telescope.

Receiver	Pol.	Frequency	SEFD [Jy]
L-band	RHCP/LHCP	1405-1440MHz, 1600-1720MHz	~ 500
S-band	RHCP/LHCP	2210-2350MHz	~ 250
X-band	RHCP/LHCP	8180-9080MHz	~ 370
Wideband	V-Linear Pol.	6.4-15GHz	~ 1000 – 2000
K-band	LHCP	22 - 24 GHz	~ 1300
Ka-band	RHCP	31.7-33.7GHz	NA
Q-band		42.3-44.9GHz	~4500

front of the LNA by the end of 2013. The L-band receiver performance almost recovered and has been used for pulsar observations.

S-band: Although there are some RFI signals in S-band, that is not so strong to saturate the LNA at the first stage. Thus the signal at an unnecessary frequency is suppressed by bandpass filter after the LNA. This bandpass filter was exchanged from a superconductor filter, which has been used for ten years, to a standard one in the end of 2013. Consequently, its observation frequency range was slightly changed to 2,210—2,350 MHz.

Wideband: One of the important components of the GALA-V project is the development of a broadband receiver for a large diameter antenna. Because the well-known Eleven-feed [1] and QRFH [2] broadband feeds have broad beamwidths (90-120 degrees), thus they cannot be used for the 34-m antenna, whose viewing size of subreflector from the focal point is 34 degrees. Thus, a new broadband

feed with a narrow beam width has been originally developed. A prototype of the new broadband feed (code name: IGUANA) was mounted on the trolley of the C-band receiver with a room temperature LNA. The receiver has one linear (V) polarization property, and its system equivalent flux density (SEFD) is 1000—2000 Jy at the 6.5—15 GHz frequency range. A more improved feed with a broader frequency range and higher efficiency is under development.

22 GHz: This receiver has one Left Hand Circular Polarization (LHCP). The receiver performance is stable and the receiver has been used for astronomical observations.

43 GHz: Re-adjustment of the subreflector position was performed at the end of 2014, and this receiver system was re-activated.

2.2 Data Acquisition System

Several VLBI data acquisition systems have been developed and installed at the Kashima 34-m station.

K5/VSSP32: is a multi-channel data acquisition system [3] and is compatible with a Mark 5 system via data format conversion. Thus most of geodetic VLBI observations are performed with this DAS.

K5/VSI: is a data recording system composed of a PC-VSI data capture card (PCI-X interface) and a PC with RAID disk systems. This system is used in combination with samplers (ADS1000, ADS2000, ADS3000, and ADS3000+) with a VSI-H interface. The ADS3000+ sampler is capable of broadband observations (1024 Msps/1ch/1bit, 128 Msps/1ch/8bit) and multi-channel digital BBC function. Thus combination use of ADS3000+ and



Fig. 2 Broadband (IGUANA) feed installed in the receiver room of the Kashima 34-m telescope.

K5/VSI is essentially compatible with K5/VSSP32 and Mark 5 DAS.

K6/OCTAD-G (code name GALAS): is the newly developed sampler for the GALA-V project [4]. Output data streams come out from 10 Gbit-Ether, and are recorded by a PC system composed of 10 Gbit-Ether and RAID disk system. A new design aspect of GALAS is so called direct sampling, which directly captures the data without frequency conversion. The sampling rate of GALAS is selectable from 16.384 GHz and 16.0 GHz. The former sampling rate is used for capturing a signal with 1024 MHz bandwidth at an arbitrary frequency via a digital filter. The latter sampling rate is designed for an experimental data acquisition mode, which captures four pre-filtered RF frequency signals with 1.6 GHz bandwidth at 3.2, 4.8, 9.6 and 12.8 at once. More details are discussed in “NICT Technology Development Center 2014 Annual Report” in this volume.

K4/VSOP terminal: has been used in domestic astronomical observations.

10 Gbps Network Connections and Data Server

A local area network (LAN) connecting data acquisition systems and software correlator PCs inside NICT (Kashima and Koganei) has been upgraded to 10Gbit-Ethernet. The outgoing network for IVS e-transfer was upgraded from 1 Gbps to 10 Gbps through JGN-X¹ and APAN² network. The data servers operated for e-VLBI data exchanges are listed in Table 2. Currently only k51c.jp.apan.net has 10 Gbps NIC (Network Interface Card), but others have 1 Gbps. This situation will be improved in 2015.

Table 2 Data servers at Kashima Station and its capacity.

Hostname	Path	Disk Size	Network Speed
vlbi2.jp.apan.net	/vlbi2/	12 T Bytes	1 Gbps
k51b.jp.apan.net	/vlbi3/	26 T Bytes	1 Gbps
k51c.jp.apan.net	/vlbi4/	24 T Bytes	10 Gbps

¹ Next generation Network Testbed <http://www.jgn.nict.go.jp/>

² Asia-Pacific Advanced Network <http://www.apan.net/>

3 Staff

KAWAI Eiji: is the main engineer in charge of the hardware maintenance and the operation of the Kashima 11-m and 34-m antennas. He is responsible for routine geodetic VLBI observations for IVS.

HASEGAWA Shingo: is the supporting engineer for IVS observation preparation and maintenance of file servers for e-VLBI data transfer.

TSUTSUMI Masanori: is the supporting engineer for maintenance of data acquisition PCs and computer network.

TAKEFUJI Kazuhiro: is a researcher using the 34-m antenna for the GALA-V project and the Pulsar observations. He performed startup work of the broadband IGUANA receiver including adjusting the sub-reflector position and measurement of the SEFD of the new receiver.

UJIHARA Hideki: designed the new broadband IGUANA feed.

ICHIKAWA Ryuichi: is in charge of keeping GNSS stations and routine GNSS observations.

TAKIGUCHI Hiroshi: is a researcher for analysis of T&F transfer and geodesy with GNSS observations and VLBI data.

SEKIDO Mamoru: is responsible for the Kashima 34-m antenna as the group leader. He maintains FS9 software for this station and operates the Kashima and Koganei 11-m antennas [6] for IVS sessions.

4 Current Status and Activities

The main mission of the VLBI project of NICT is the development of VLBI systems for distant frequency transfer. In that project, named GALA-V [4], upgrading the receiver of the 34-m telescope to enable broadband observation in frequency range 3.2 — 15 GHz is being conducted. Because the beamwidths of known broadband feeds [1, 2] are too wide to be used in the 34-m radio telescopes, where the beamwidth has to be 34 degrees in diameter, we have developed our original broadband feed with narrow beamwidth property. The first prototype of the IGUANA feed, which has sensitivity at the 6.5 — 15GHz frequency range, was installed in the 34-m antenna. Its first light observation was made in January 2014. Simultaneous observation

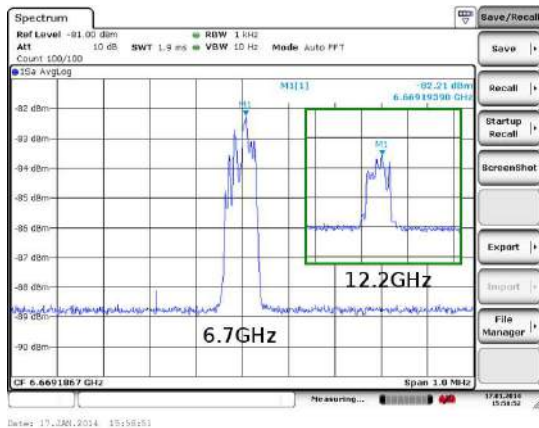

Fig. 3 Frequency spectrum of methanol maser line at 6.7 GHz and 12.2 GHz from radio source W3OH. The two spectral lines are simultaneously observed in the first light observation with broadband feed mounted on the 34-m antenna.

of spectral lines at 6.7 GHz and 12.2 GHz (Figure 3) demonstrated the impact of the broadband feed in astronomical observation. This new feed enables upgrading of the existing Cassegrain type antenna for broadband observation.

The broadband system is of course intended to make joint observations with VGOS [7] systems. Joint observations and compatibility with the VGOS system developed by Haystack Observatory is being discussed.

5 Future Plans

International test observations with the broadband feed is being planned under collaboration among Haystack, NASA/GSFC, and NICT. The first test observing was successfully finished in January 2015.

T&F observations with broadband VLBI will be conducted in 2015 as the main mission of the GALA-V project. In 2014, small diameter antennas were installed at NICT Koganei and NMIJ (National Metrology Institute of Japan) Tsukuba, where optical frequency standards are being developed. VLBI experiments for frequency comparison between UTC[NICT] and UTC[NMIJ] will be conducted with the 34-m antenna for boosting the sensitivity.

Acknowledgements

The development of the broadband feed was supported by the “Joint Development Research” fund provided from the National Astronomical Observatory of Japan in 2013–2014. We acknowledge Professor K. Fujisawa of Yamaguchi University and M. Honma and M. Matsumoto of NAOJ for supporting this development. We thank the research network JGN-X and the Information System Section of NICT for supporting the network environment in this project.

References

1. Yang, J., et al, “Cryogenic 2–13 GHz Eleven Feed for Reflector Antennas in Future Wideband Radio Telescopes”, *IEEE Trans. on Ant. & Prop.*, Vol.59, No.6, pp.1918-1934, 2011.
2. Akgiray, A., et al., “Circular Quadruple-Ridged Flared Horn Achieving Near-Constant Beamwidth Over Multi-octave Bandwidth: Design and Measurements”, *IEEE Trans. on Ant. & Prop.*, Vol.61, No.3, pp.1099-1108, 2013.
3. Kondo, T., Y. Koyama, R. Ichikawa, M. Sekido, E. Kawai, and M. Kimura, Development of the K5/VSSP System, *J. Geod. Soc. Japan*, Vol. 54, No 4, pp. 233-248, 2008.
4. Sekido M., et al., Development of Wide-band VLBI system (GALA-V), *IVS NICT-TDC News No 33*, pp.11-14, 2013.
5. Takefuji, K., et al., “NICT Technology Development Center 2014 Annual Report”, this volume, 2015.
6. Sekido, M., E. Kawai, “Kashima and Koganei 11-m VLBI Stations”, this volume, 2015.
7. Petrachenko, B.: VLBI2010: Progress and Challenges, *IVS 2012 General Meeting Proceedings*, edited by D. Behrend and K. D. Baver, NASA/CP-2012-217504, p.42-46, 2012.

Kokee Park Geophysical Observatory

Ron Curtis

Abstract This report summarizes the technical parameters of the VLBI system at the Kokee Park Geophysical Observatory and provides an overview of the activities that occurred in 2014.

1 Location

The Kokee Park Geophysical Observatory (KPGO) is located in Kokee State Park on the island of Kauai in Hawaii at an elevation of 1,100 meters near the Waimea Canyon, often referred to as the Grand Canyon of the Pacific. KPGO is located on the map at longitude 159.665° W and latitude 22.126° N.

2 Technical Parameters

The receiver is of NRAO (Green Bank) design (a dual polarization feed using cooled 15 K HEMT amplifiers). The antenna is of the same design and manufacture as those used at Green Bank and Ny-Ålesund. A Mark 5B+ recorder is currently used for all data recording.

Timing and frequency is provided by a Sigma Tau Maser with a NASA NR Maser providing backup. Monitoring of the station frequency standard performance is provided by a CNS (GPS) Receiver/Computer

1. USNO
2. NASA GSFC

Kokee Park Network Station

IVS 2014 Annual Report

system. The Sigma Tau performance is also monitored via the IGS Network.

3 Staff

The staff at Kokee Park consists of six full time people employed by ITT Exelis under the SCNS contract to NASA for the operation and maintenance of the observatory. Chris Coughlin, Lawrence Chang, Kiah Imai, and Ron Curtis conduct VLBI operations and maintenance. Ben Domingo is responsible for antenna maintenance, and Amorita Apilado provides administrative, logistical, and numerous other support functions. Kelly Kim also supports VLBI operations and maintenance during 24-hour experiments and as backup support.

4 Mission Support

Kokee Park has participated in many VLBI experiments including IVS R4 and R1. KPGO also participates in the RDV, CRF, and OHIG experiments. KPGO averaged two experiments of 24 hour duration each week, with weekday Intensive experiments in 2014.

Kokee Park hosts other systems, including the following: a Doppler Orbitography and Radiopositioning Integrated by Satellite (DORIS) beacon and remote control, a Quasi-Zenith Satellite System (QZSS) monitoring station, a Two-Way Satellite Time and Frequency Transfer (TWSTFT) relay station, and a Turbo-Rogue GPS receiver. Kokee Park is an IGS station.

5 Recent Activities

The KPGO 20-m antenna has been in service for 22 years and continues to show signs of its age. The frequency of the maintenance activities for monitoring, lubricating, and greasing antenna components was increased to minimize wear and tear on the aging antenna. One of the major signs of wear on the 20-m antenna is axial play in the azimuth bearing. This puts additional strain on the azimuth drive components, especially in high wind conditions. In April 2014, KPGO technicians lowered the south azimuth motor/brake assembly to replace the leaking seals between the gearbox and the brake housing to prevent the oil leak from compromising the brake and/or the motor performance. Plans are in progress to repair and upgrade many of the 20-m antenna components. The plans to upgrade the KPGO 20-m telescope for broadband observation are on hold until after the installation of the new 12-m high-precision VLBI2010-style radio antenna. The new 20-m antenna broadband receiver box built by MIT is in storage in the KPGO operations building. The digital backend has been rack mounted until future use with four RDBEs, four UP/DOWN Converters, one of four Mark 5C recorders, and an Optical ReCeiver/splitter/Amplifier (ORCA). New timing and frequency distribution equipment was installed at KPGO in advance to support the new 20-m digital backend.

The installation of the InterTronic Solutions 12-m high-precision VLBI2010-style radio antenna at KPGO passed the Preliminary Design Review and Critical Design review in 2014. The MIT-designed broadband feed to be used on this 12-m telescope has completed its System Requirement Review in 2014. The project is on schedule for completion by the end of 2015. The e-transfers of the INT1 sessions from KPGO to USNO were being transmitted over the microwave infrastructure provided by the Pacific Missile Range Facility (PMRF) connecting KPGO to DREN. In June 2014, there was an upgrade to the DREN network which requires an upgrade at KPGO to utilize the DREN connectivity. MIT and USNO were working on the required KPGO upgrades and the INT1 sessions were sent via FedEx to USNO beginning in June 2014 through the end of 2014. MIT and USNO will continue to work on the KPGO network upgrades and the plans to migrate to a dedicated fiber connection

for KPGO. MIT is working with the Hawaii Internet Consortium (HIC) and DREN to improve the KPGO e-transfer rate. Long term plans are still to make real-time VLBI data transfers from KPGO a reality.

6 Outlook

KPGO will continue with efforts to upgrade the 20-m antenna signal path to VLBI2010 specifications. KPGO staff, Exelis personnel at GSFC, USNO personnel, and MIT personnel are in the process of planning the 20-m antenna modifications and the installation of a new broadband frontend for the KPGO 20-m antenna after 2015. USNO, NASA, InterTronic Solutions, MIT, and Exelis will continue to work throughout 2015 on the construction process for the high precision VLBI2010-style 12-m radio telescope at KPGO. Facility upgrades and construction of a new antenna pad for the 12-m telescope are planned for the first half of 2015. The installation of the new 12-m antenna and signal path is planned for the second half of 2015. The internal network architecture at KPGO will be upgraded to support the network requirements of the new 12-m telescope.



Fig. 1 The KPGO 20-m radio telescope (foreground) with the KPGO 9-m radio telescope in the background.

Table 1 Technical parameters of the radio telescope at KPGO.

Parameter	Kokee Park
owner and operating agency	USNO-NASA
year of construction	1993
radio telescope system	Az-El
receiving feed	primary focus
diameter of main reflector d	20m
focal length f	8.58m
f/d	0.43
surface contour of reflector	0.020inchesrms
azimuth range	0...540°
azimuth velocity	2°/s
azimuth acceleration	1°/s ²
elevation range	0...90°
elevation velocity	2°/s
elevation acceleration	1°/s ²
X-band (reference $\nu = 8.4\text{GHz}$, $\lambda = 0.0357\text{m}$)	8.1 – 8.9GHz
T_{sys}	40K
$S_{\text{SEFD}}(\text{CASA})$	900Jy
G/T	45.05 dB/K
η	0.406
S-band (reference $\nu = 2.3\text{GHz}$, $\lambda = 0.1304\text{m}$)	2.2 – 2.4GHz
T_{sys}	40K
$S_{\text{SEFD}}(\text{CASA})$	665Jy
G/T	35.15 dB/K
η	0.539
VLBI terminal type	VLBA/VLBA4-Mark 5
Field System version	9.11.1

Kashima and Koganei 11-m VLBI Stations

M. Sekido, E. Kawai

Abstract The Kashima and Koganei 11-m stations are used for geodetic and astronomical monitoring observations and for an R&D test bed of VLBI technology.

1 General Information

A pair of 11-m diameter antennas are operated by the VLBI group of the Space-Time Standard Laboratory (STSL) of the National Institute of Information and Communications Technology (NICT). The Kashima 11-m antenna is located in Kashima Space Technology Center (KSTC), on the east coast of the Japanese main island. The Koganei 11-m antenna is located in the headquarters of the NICT in Tokyo (Figure 1). The 11-m VLBI antennas at Kashima and Koganei (Figure 2) were established and have been operating for the monitoring of crustal deformation of the Tokyo metropolitan area (Key Stone Project) since 1995 [1]. After regular VLBI observations, the KSP VLBI Network terminated in 2001. Since then, the 11-m VLBI stations at Kashima and Koganei have mainly been used for research and technology developments. After the “Tohoku earthquake” that occurred in March 2011, the Kashima and Koganei 11-m stations participated in IVS-R1, T2, and APSG sessions.

NICT Space-Time Standards Laboratory/Kashima Space Technology Center

NICT KSP Network Station

IVS 2014 Annual Report

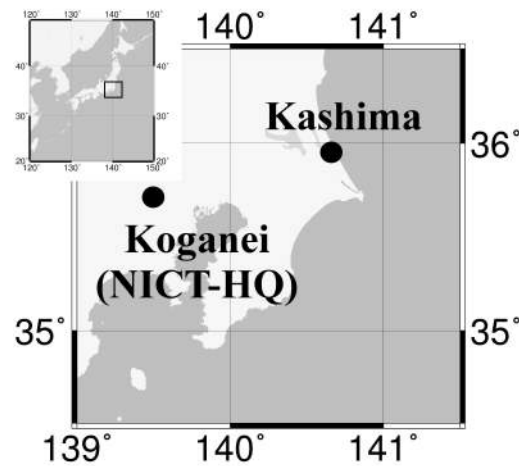

Fig. 1 Location of NICT-Koganei Headquarters and Kashima.

2 Component Description

2.1 Antenna

The antenna parameters of Kashima-11 and Koganei-11 are summarized in Table 1. The band-pass filters for S-band (2212-2360 MHz) were installed in 2010 at both stations for mitigation of radio frequency interference from cell phone stations. The local oscillator frequency of XH-band at the Kashima 11-m station has been changed from 7600 MHz to 7680 MHz since 2008, and since then, the observation bands of the Kashima and Koganei stations have been different by 80 MHz.



Fig. 2 11-m VLBI antennas at Kashima (left panel) and Koganei (right panel).

Table 1 The antenna parameters of the 11-m antennas.

		Kashima	Koganei
Antenna Type		Cassegrain type	
Diameter		11-m	
Mount Style		Az El mount	
Latitude		N 35° 57' 19.46"	N 35° 42' 37".89
Longitude		E 140° 39' 26.86"	E 139° 29' 17".06
Altitude		62.4 m	125.4 m
Rx Freq. [MHz]	S band	2212 ~ 2360	2212 ~ 2360
	X Low band	7700 ~ 8200	7700 ~ 8200
	X High band	8180 ~ 8680	8100 ~ 8600
Local Freq. [MHz]	S band	3000	3000
	X Low band	7200	7200
	X High band	7680	7600
SEFD [Jy]	X-band	5700	9500
	S-band	3300	5500

2.2 Data Acquisition Systems

Two kinds of samplers are available at both stations as summarized in Table 2. The K5/VSSP32 [2] has four channels of video band signal input per unit. Four units of K5/VSSP32 constitute one geodetic VLBI terminal with 16 inputs. This system is constantly used for geodetic VLBI observations including IVS sessions. This sampler has digital filter functionality in it. The input video signal is digitized with 8-bit quantization with 64 MHz sampling. Then the frequency bandwidth is shaped by digital filter and output by specified data rate. The output data is written to a standard Linux file

system in K5/VSSP32 format¹. Data format conversion from K5/VSSP32 to Mark IV, VLBA, and Mark 5B are available with conversion tools².

Another sampler, ADS3000+ [3], has digital base-band conversion (DBBC) function. Several kinds of data acquisition modes (personalities) are switched by exchanging an FPGA program. The DBBC mode enables flexible selection of 16 video frequency channels with any of 4/8/16/32 MHz bandwidth. Therefore this can be compatible with conventional 16 channels of geodetic VLBI observations. Another data acquisition mode (8bit-128MHz-1ch) was used for astronomical observations requiring higher dynamic range observations. Other modes (1bit-1024MHz-1ch, 2bit-1024MHz-1ch, and 1bit-2048MHz-1ch) were used for broadband VLBI observations for geodesy and time and frequency transfer. Figure 3 shows the data acquisition terminal of K5/VSSP32 and K5/VS1.

2.3 Upgrading Network Speed

The local area network (LAN) connection speed connecting the Kashima 34-m antenna site, the Kashima 11-m, and the Koganei 11-m stations were upgraded

¹ Please see http://ryuu.nict.go.jp/stmg/K5/VSSP/vsspALL_header_format-e.pdf

² Observation and data conversion software for K5/VSSP are freely available from <http://www2.nict.go.jp/aeri/sts/stmg/K5/VSSP/index-e.html>

Table 2 VLBI data sampler/DAS systems equipped at the Kashima 11-m and Koganei 11-m stations.

System	K5/VSSP32 (4 units)	ADS3000+(K5/VSI)
Video Converter	K4/KSP 16ch	not necessary
# of Input Channels	4 /unit x 4 units	1 or 2
# of Output Channels	16	1, 2, 16
Input Freq. Range	0 - 300 MHz	0 - 2 GHz
Sampling Rate [Msps]	0.04,0.1,0.2,0.5,1, 2,4,8,16,32,64	128, 256, 1024, 2048,4096
Quantization bit	1,2,4,8 bit	
Max. data rate [Mbps]	256 /unit x 4	4096
Output Interface	USB 2.0	VSI-H

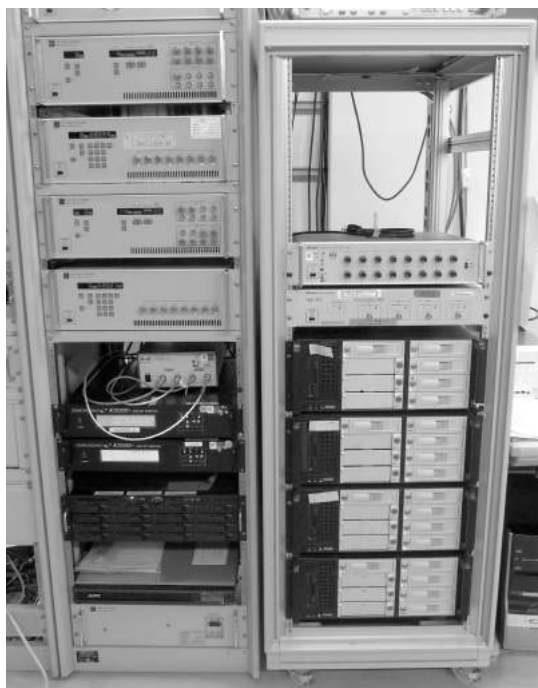

Fig. 3 Data acquisition terminal (K5/VSSP and K5/VSI) at the Kashima 11-m station.

to 10 Gbps in 2014. The high speed network connection is provided by collaboration with the JGN-X (Next generation Network Testbed). The 10G-LAN connection is used for sharing the data and correlation processing. In the case of IVS sessions, the VLBI data of these stations are collected, format converted, and put on external servers for e-transfer to correlators.

Not only the internal LAN, but also the outreach network, were upgraded to 10 Gbps by the support of JGN-X in this year. Then data transfers (e-transfer)

speed up to 10 Gbps became available through the JGN-X and APAN network.

2.4 GNSS Site

Both Kashima 11 m and Koganei 11 m have GNSS observation sites — named KSMV and KGNI, respectively. Their data is regularly uploaded to an International GNSS Service (IGS) Data Center. Figure 4 shows the KSMV station at the Kashima 11-m antenna site. A local survey was performed in 2014 at Koganei. The survey results may be used for a local tie at Koganei between VLBI and GPS.



Fig. 4 GNSS receiver pillar at the Kashima 11-m site registered as KSMV of the IGS tracking station.

3 Staff

Kawai Eiji: In charge of station maintenance and IVS observations.

Hasegawa Shingo: Supporting staff for IVS observation, operation of data conversion and maintenance of file servers for e-transfer.

Ichikawa Ryuuchi: In charge of GNSS station care and GNSS observations.

Sekido Mamoru: In charge of overall activities of the Kashima and Koganei VLBI stations.

4 Current Status

The Kashima and the Koganei 11-m stations are participating in geodetic VLBI sessions IVS-T2, APSG, and JADE, 14 sessions a year in total. In addition, these two stations are used as a test bed for R&D experiments including time and frequency transfer.

The problem of tearing of cables (coaxial cables and status-control lines), which happened at the Kashima 11-m antenna in October 2013, was fixed in March 2014. Both stations have been normally operating since April.

The Koganei 11-m antenna is jointly operated by two groups in the NICT: the STSL and the Space Weather and Environment Informatics Laboratory (SWEIL). When the antenna is not used for VLBI observations by STSL, down linked observations from the STEREO satellite³ have been provided by the SWEIL until October 2014. This STEREO satellite downlink has been suspended since October 10, 2014.

Pointing (antenna axis parameter) observation was made in January 2015 in order to monitor the antenna status. The last update of the axis parameters was made in April 2014 for Kashima 11 m, and in April 2013 for Koganei 11 m. The drift of the mean azimuth and elevation offsets were (0.004, 0.001) and (-0.006, -0.004) in degrees for the Kashima 11-m and Koganei 11-m antennas. The root mean square (RMS) scatter of the deviation for the azimuth and elevation angles were (0.006, 0.009) and (0.014, 0.011) for Kashima 11 m and Koganei 11 m. The degradation of the parameters was within the RMS deviation of the offset; thus the parameters were retained.

Acknowledgements

We thank the research network JGN-X and the Information System Section of NICT for supporting the high speed network environment.

References

1. Special issue for the Key Stone Project, J. Commun. Res. Lab., Vol. 46, No. 1, pp.1-221, 1999.
2. Kondo, T., Y. Koyama, R. Ichikawa, M. Sekido, E. Kawai, and M. Kimura, Development of the K5/VSSP System, J. Geod. Soc. Japan, Vol. 54, No 4, pp. 233-248, 2008.
3. Takefuji, et al., "Next-generation A/D Sampler ADS3000+ for VLBI2010", in VLBI2010: From Vision to Reality, Proceedings from the Sixth IVS General Meeting, edited by D. Behrend and K.D. Baver. NASA/CP-2010-215864, p.378-382, 2010.

³ http://www.nasa.gov/mission_pages/stereo/main/index.html

Matera CGS VLBI Station 2014 Annual Report

Giuseppe Bianco¹, Giuseppe Colucci², Francesco Schiavone²

Abstract This report presents the status of the Matera VLBI station. An overview of the station, some technical characteristics of the system, and staff addresses are also given.

1 General Information

The Matera VLBI station is located at the Italian Space Agency's 'Centro di Geodesia Spaziale G. Colombo' (CGS) near Matera, a small town in the south of Italy. The CGS came into operation in 1983 when the Satellite Laser Ranging SAO-1 System was installed. Fully integrated into the worldwide network, SAO-1 was in continuous operation from 1983 up to 2000, providing high precision ranging observations of several satellites. The new Matera Laser Ranging Observatory (MLRO), one of the most advanced Satellite and Lunar Laser Ranging facilities in the world, was installed in 2002, replacing the old SLR system. CGS also hosted mobile SLR systems MTLRS (Holland/Germany) and TLRS-1 (NASA).

In May 1990, the CGS extended its capabilities to Very Long Baseline Interferometry (VLBI), installing a 20-m radio telescope. Since then, Matera has observed in 982 sessions up through December 2014.

In 1991 we started GPS activities, participating in the GIG 91 experiment and installing at Matera a permanent GPS Rogue receiver. In 1994, six TurboRogue SNR 8100 receivers were purchased in

order to create the Italian Space Agency GPS fiducial network (IGFN). At the moment 12 stations are part of the IGFN, and all data from these stations, together with 24 other stations in Italy, are archived and made available by the CGS Web server GeoDAF (<http://geodaf.mt.asi.it>).

In 2000, we started activities with an Absolute Gravimeter (FG5 Micro-G Solutions). The gravimeter operates routinely at CGS and is available for external campaigns on request.

Thanks to the co-location of all precise positioning space-based techniques (VLBI, SLR, LLR, and GPS) and the Absolute Gravimeter, CGS is one of the few "fundamental" stations in the world. With the objective of exploiting the maximum integration in the field of Earth observations, in the late 1980s, ASI extended CGS' involvement to include remote sensing activities for present and future missions (ERS-1, ERS-2, X-SAR/SIR-C, SRTM, ENVISAT, and COSMO-SkyMed).

The Matera VLBI antenna is a 20-meter dish with a Cassegrain configuration and an AZ-EL mount. The AZ axis has ± 270 degrees of available motion. The slewing velocity is 2 deg/sec for both the AZ and the EL axes.

The technical parameters of the Matera VLBI antenna are summarized in Table 1.

The Matera time and frequency system consists of three frequency sources (two Cesium beam and one H-maser standard) and three independent clock chains. The iMaser 3000 H-maser from Oscilloquartz is used as a frequency source for VLBI.

1. Agenzia Spaziale Italiana

2. e-geos - an ASI/Telespazio company



Fig. 1 VLBI antenna.

Table 1 Matera antenna technical specification.

Parameter name	Values (S/X)
Input frequencies	2210–2450 MHz / 8180–8980 MHz
Noise temperature at dewar flange	<20 K
IF output frequencies	190–430 MHz 100–900 MHz
IF Output Power (300 K at inp. flange)	0.0 dBm to +8.0 dBm
Gain compression	<1 dB at +8 dBm output level
Image rejection	>45 dB within the IF passband
Inter modulation products	At least 30 dB below each of two carriers at an IF output level of 0 dBm per carrier
T_{sys}	55/65 K
SEFD	800/900 Jy

2 Activities during the Past Year

The VLBI frequency standard is a T4SCIENCE iMaser 3000 installed in 2013.

Specifications for this new maser can be found here: http://www.t4science.com/product/imaser_3000.

3 Current Status

In 2014, 53 sessions were observed. Figure 2 shows a summary of the total acquisitions per year, starting in 1990.

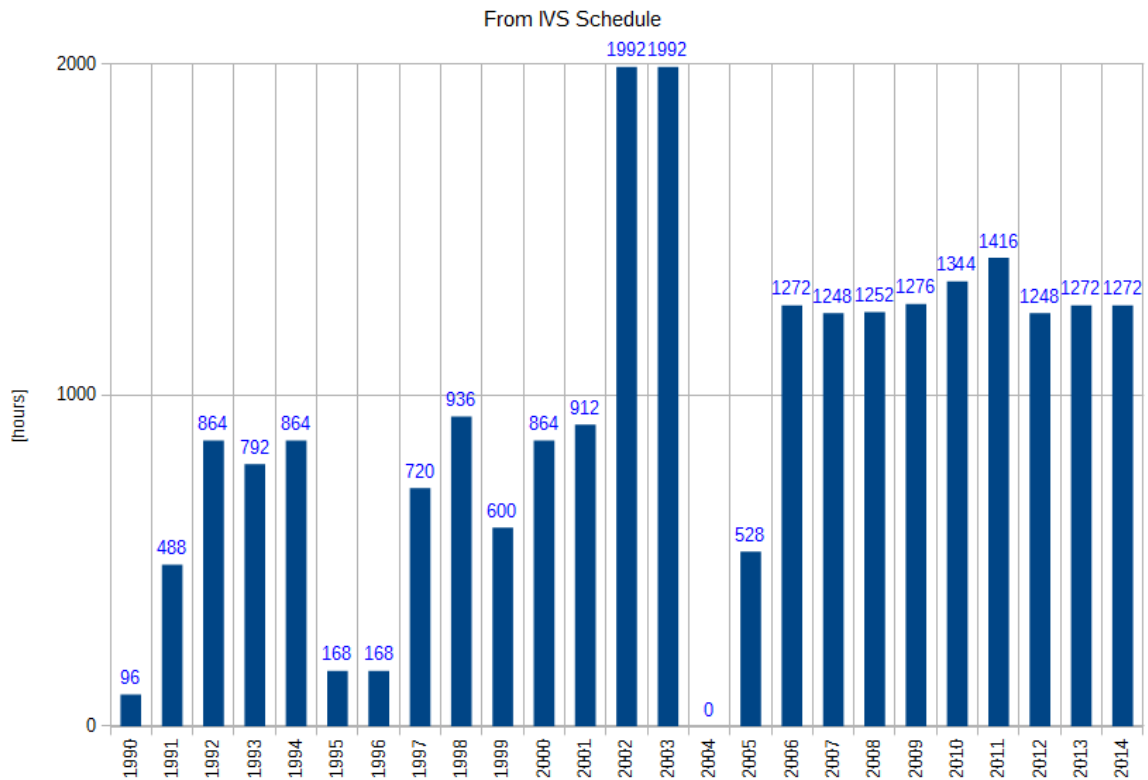

Fig. 2 Observation time.

In 2004, in order to fix the existing rail problems, a complete rail replacement was planned. In 2005, due to financial difficulties, it was instead decided that only the concrete pedestal under the existing rail would be repaired. From then on, no rail movements have been noted [1]-[3].

4 Future Plans

In order to plan the eventual building of a VLBI2010 system, the fund raising investigation process has begun. At this moment it is not clear when the budget for starting the project will be ready.

References

1. M. Mannarella "Relazione sulle misure effettuate sulla rotaia dell'antenna VLBI", Telespazio doc. OT-SPA-SM_REL_180010_1140_0222, 21/01/2004.
2. M. Mannarella "Misure sugli spostamenti indotti sulle piastre e sulla rotaia dell'antenna VLBI", Telespazio doc. OT-SPA-SM_REL_180010_1320_0661, 06/04/2005.
3. M. Mannarella "Relazione sull'esito dei lavori di ripristino delle parti ammalorate della fondazione dell'antenna VLBI", Telespazio Doc. OT-SPA-SM_REL_180010_1320_0732, 27/06/2005.

Medicina Station Status Report

Giuseppe Maccaferri, Andrea Orlati, Alessandro Orfei

Abstract General information about the Medicina Radio Astronomy Station, the 32-m antenna status, and the staff in charge of VLBI observations are provided. Updates to the hardware were performed and are briefly described.

1 The Medicina 32-m Antenna: General Information

The Medicina 32-m antenna is located at the Medicina Radio Astronomy Station. The station is run by the Istituto di Radioastronomia and is located approximately 33 km east of Bologna. The Consiglio Nazionale delle Ricerche was the funding agency of the Istituto di Radioastronomia until the end of 2004. Since January 1, 2005, the funding agency has been the Istituto Nazionale di Astrofisica (INAF). The antenna, which was inaugurated in 1983, has regularly taken part in IVS observations since 1985 and is an element of the European VLBI network.

A permanent GPS station (MEDI), which is a part of the IGS network, is installed in the vicinity. Another GPS system (MSEL) is installed near the VLBI telescope and is part of the EUREF network.

Istituto di Radioastronomia INAF, Medicina

Medicina Network Station

IVS 2014 Annual Report

2 Current Status and Activities

- Antenna - A long period of maintenance started on April 2014 and was completed on January 2015. One antenna wheel was repaired; the elevation rack and gear was completely replaced; a new lift system for the antenna was installed; the subreflector and the primary focus receiver box has now a new driving system, and mechanical maintenance at the primary focus equipment was completed.
- DBBC + FILA10G - Medicina has completed the tests (including the Mark 5C, see below) to qualify this module for observing. The incoming astronomical VLBI session will be performed using it, while we are on the way to verify the proper functioning of the acquisition system in the geodetic observations.
- Mark 5C - All the known problems at this date have been fixed.
- Field System - Release 9.11.7 was installed and tested.

3 Geodetic VLBI Observations

In 2014, due to the long period of maintenance, Medicina took part in five 24-hour routine geodetic sessions, only (namely three IVS-R4 and two EUROPE experiments).

Metsähovi Radio Observatory Network Station 2014 Annual Report

Minttu Uunila ¹, Nataliya Zubko ², Markku Poutanen ², Juha Kallunki ¹, Ulla Kallio ²

Abstract In 2014, Metsähovi Radio Observatory, together with the Finnish Geodetic Institute, have observed six IVS sessions: three T2 and three EUROPE sessions.

1 General Information

Aalto University Metsähovi Radio Observatory and Finnish Geodetic Institute (FGI) are two separate institutes which together form the Metsähovi IVS Network Station. Metsähovi Radio Observatory operates a 13.7-meter radio telescope on the premises of Aalto University at Metsähovi, Kylmälä, Finland about 35 km from the university campus. The Metsähovi Fundamental Geodetic Station of FGI is in the same area, near Metsähovi Radio Observatory.

2 Component Description

The Metsähovi Radio Observatory has been operational since 1974. The telescope was upgraded in 1992-1994. The radome was replaced with a new one, and new surface panels were installed. Metsähovi, together with FGI, began observing IVS T2 and EUROPE sessions in 2004. Approximately six to eight sessions are observed per year. The surface accuracy of the present

telescope is 0.1 mm (rms). The speed of the Metsähovi antenna is 1.2 degrees per second.

Metsähovi is known for its long-term quasar monitoring. Astronomical VLBI observations are carried out with the 22 and 43 GHz receivers. The geodetic VLBI receiver of Metsähovi uses right circular polarization and 8.15—8.65 and 2.21—2.35 GHz frequency bands.

2.1 Metsähovi Fundamental Station

FGI is running the Metsähovi Fundamental Station. It is a part of the IAG GGOS Core station network. The instrumentation includes geodetic VLBI (in cooperation with Aalto University), Satellite Laser Ranging (SLR), DORIS, and GNSS equipment and absolute and superconducting gravimeters.

Currently, instrumentation is being renewed based on special funding from the Ministry of Agriculture and Forestry. During this year, a new dome for SLR was constructed. The installation of a new SLR telescope and other equipment is expected to be installed within the next year.

At the start of 2015, the Finnish Geodetic Institute will become a part of the National Land Survey of Finland (NLS) as the Finnish Geospatial Research Institute (the abbreviation remaining FGI). The construction of a new radio telescope for GeoVLBI observations will be realized, if the project is funded by NLS.

1. Aalto University Metsähovi Radio Observatory

2. Finnish Geodetic Institute



Fig. 1 Metsähovi Radio Observatory (photo by Merja Tornikoski).

Table 1 Staff at Metsähovi Radio Observatory and at FGI involved in geodetic observations during 2014.

Staff at Metsähovi Radio Observatory		
Name	Title	Responsibility
Ph.D., Lic.(tech.) Juha Kallunki	Technical staff manager	VLBI equipment
M.Sc.(tech.) Ari Mujunen	Laboratory engineer	VLBI equipment
D.Sc.(tech.) Minttu Uunila	Post-doctoral researcher, IVS on-site technical contact	VLBI observations, VLBI equipment
M.Sc.(tech.) Petri Kirves	Operations engineer	Receivers
Staff at Finnish Geodetic Institute		
Name	Title	Responsibility
Prof. Markku Poutanen	Head of the Department of Geodesy and Geodynamics	Metsähovi research station
Ph.D. Nataliya Zubko	Senior research scientist	IVS observations, analysis
M.Sc. Veikko Saaranen	Special research scientist	IVS observations operations
M.Sc. Ulla Kallio	Senior research scientist	Local ties measurements
Ph.D. Diego Meschini	Research scientist	Correlation research
Ph.D. Jyri Näränen	Special research scientist	Metsähovi infrastructure

3 Staff

FGI is responsible for the geodetic VLBI observations and is the owner of the S/X receiver. The radio telescope is owned and operated by the Aalto University, and an annual agreement is made on its use for geodetic VLBI sessions. It is not possible to increase the number of annual geodetic sessions (currently six to eight) because the telescope is mainly used for astronomical observations. Operation during the geo-VLBI sessions and technical questions are handled jointly; all other technical work, telescope maintenance, and maintenance of instrumentation are done by the personnel of the radio telescope.

Metsähovi Radio Observatory personnel working with IVS observations are listed in Table 1. Dr. Uunila is in charge of all (IVS, EVN, and GMVA) VLBI observations at Metsähovi. The preparation, operation of IVS observations, and submission of data are provided by staff from FGI. The personnel engaged in the work are listed in Table 1.

4 Current Status and Activities

4.1 IVS Sessions

Metsähovi, together with FGI, has observed six IVS sessions (three T2 and three EUROPE sessions) in 2014. In EUR127 there was RFI on X-band channels. This might have been caused by the fact that we had to use a signal generator to produce the LO, which was broken in the receiver. The Mark 5B also had to be rebooted, and there were some non-detections. In EUR128 there were no problems. In EUR130 there were antenna slewing problems during the scan recording (see also the Technical Activities Section). The T2 sessions (T2097, T2098, and T2099) are not yet correlated, and there were no known problems.

4.2 Research Visits

Dr. Uunila visited the Goddard Space Flight Center (GSFC) VLBI group in order to collaborate with local group members on a comparison of the VieVS analysis software package developed by the Vienna University of Technology and the Solve package developed by the GSFC VLBI group.

4.3 Technical Activities

DBBC boards were repaired in Bonn in January by M. Wunderlich. The LO of the X-band receiver was repaired in January at Metsähovi. A new 8 TB disk-module was assembled and tested in October.

Throughout the year we experienced slewing problems with the antenna. These will be fixed in January 2015, when the old antenna control software version will be replaced with a new one and the azimuth limits will be changed from 0—360 to -90—450 degrees.

4.4 Data Analysis

Geodetic data analysis at Metsähovi is done by Dr. Uunila. The analysis focuses on the IVS-INT01 sessions.

Data analysis at FGI is performed by Dr. Zubko. The project of source structure study and its influence on estimated geodetic VLBI parameters has been continued in cooperation with Dr. Rastorgueva-Foi from University of Tasmania. The latest results on this research were presented at the EGU meeting this year. Dr. Meschini is responsible for correlation.

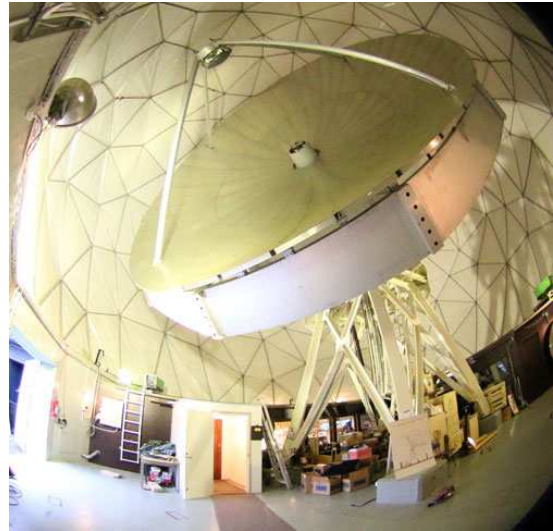

Fig. 2 Metsähovi radio telescope (Photo by Merja Tornikoski).

4.5 Local Tie Measurements

The local tie measurements between the co-located instruments at Metsähovi are provided by Ulla Kallio. A local tie between IGS station METS and the VLBI antenna reference point was regularly performed with kinematic GPS measurements during the geo-VLBI campaigns beginning in 2008. Testing shows that a millimeter level accuracy can be achieved in local tie vector determination with the kinematic GPS method.

4.6 Laser Scanning of Telescope Dish

During the summer, the telescope dish was scanned with a FARO Focus 3D terrestrial laser scanner established on the position of the secondary mirror to study dish deformation (Figure 3). This experimental work



Fig. 3 Laser scanning of antenna dish. The scanner is in place of the secondary mirror.

was performed by Antero Kukko, Harri Kaartinen, Ulla Kallio, and Henry Rönnerberg. The preliminary results show that the data is suitable for the focal length estimation, but not accurate enough for a detailed surface deformation analysis. To get more precise results the scanning will be repeated next year with another scanner.

5 Future Plans

In 2015 Metsähovi is scheduled to participate in seven IVS sessions: three EUROPE sessions and four T2 sessions. The antenna control software will be updated in January 2015.

VERA 2014 Geodetic Activities

Takaaki Jike, Yoshiaki Tamura, Makoto Shizugami

Abstract The geodetic activities of VERA in the year 2014 are briefly described. The regular geodetic observations are carried out both in K- and S/X-bands. The frequency of regular observations are three times a month—twice for the VERA internal observations in K-band. The networks of the S/X sessions are JADE of GSI and IVS-T2. The raw data of the T2 and JADE sessions are electronically transferred to the Bonn, Haystack, and GSI correlators via Internet. Gravimetric observations are carried out at the VERA stations. SGs are installed at Mizusawa and Ishigakijima in order to monitor precise gravity changes, and the observations continued throughout this year. The crustal movements generated by the 11-Mar-2011 earthquake off the Pacific coast of Tohoku continued during 2014, and displacement of VERA-Mizusawa's position by post-seismic creeping continued.

1 General Information

VERA is a Japanese domestic VLBI network consisting of the Mizusawa, Iriki, Ogasawara, and Ishigakijima stations. Each station is equipped with a 20-m radio telescope and a VLBI back-end. The VERA Ishigakijima 20-m antenna is shown in Figure 1. The VERA array is controlled from the Array Operation Center (AOC) at Mizusawa via Internet.

The primary scientific goal of VERA is to reveal the structure and the dynamics of our galaxy by determin-

Mizusawa VLBI Observatory, National Astronomical Observatory of Japan

VERA Network Station

IVS 2014 Annual Report

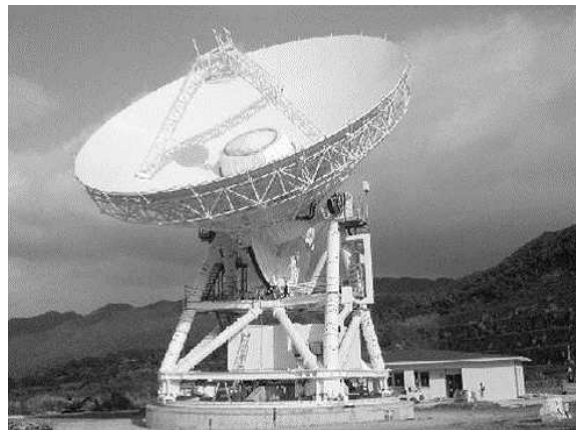

Fig. 1 Complete view of the VERA Ishigakijima 20-m antenna.

ing three-dimensional force field and mass distribution. Galactic maser sources are used as dynamical probes, the positions and velocities of which can be precisely determined by phase referenced VLBI relative to extragalactic radio sources. The distance is measured as a classical annual trigonometric parallax. The observing frequency bands of VERA are S and X, C (6.4 GHz), K (22 GHz), and Q (43 GHz). Geodetic observations are made in S/X- and K-bands. Q-band is currently not used for geodesy. Only a single beam is used even in K-band in geodetic observations, although VERA can observe two closely separated ($0.2^\circ < \text{separation angle} < 2.2^\circ$) radio sources simultaneously by using the dual beam platforms.

General information about the VERA stations is summarized in Table 1, and the geographic locations are shown in Figure 2. The lengths of the baselines range from 1,000 km to 2,272 km. The skyline at Ogasawara station ranges from 7° to 18° because it is lo-

cated at the bottom of an old volcanic crater. The northeast sky at Ishigakijima station is blocked by a nearby high mountain. However, the majority of the skyline is below 9° . The skylines at Mizusawa and Iriki are low enough to observe sources with low elevation. Because Ogasawara and Ishigakijima are small islands in the open sea and their climate is subtropical, the humidity in the summer is very high. This brings about high system temperatures in the summer, in particular in K- and Q-bands. Iriki station as well as these stations are frequently hit by strong typhoons. The wind speed sometimes reaches up to 60–70 m/s.

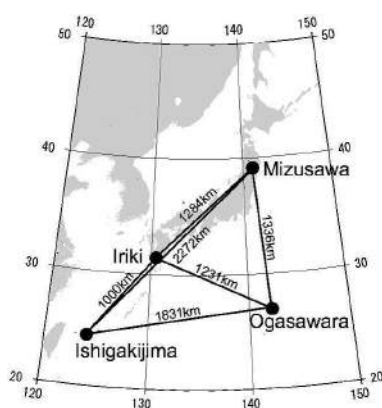

Fig. 2 Distribution of the stations in the VERA Network.

Table 1 Location.

Site name	Longitude	Latitude	Altitude
Mizusawa	141° 07' 57".199 E	39° 08' 00".726 N	75.7 m
Iriki	130° 26' 23".593 E	31° 44' 52".437 N	541.6 m
Ogasawara	142° 12' 59".809 E	27° 05' 30".487 N	223.0 m
Ishigakijima	124° 10' 15".578 E	24° 24' 43".834 N	38.5 m

2 Current Status

The parameters of the antennas and front- and back-ends are summarized in Tables 2 and 3, respectively. Two observing modes are used for geodetic observations. One is the VERA internal observation in K-band with the recording rate of 1 Gbps. The other is the conventional S/X-band observation with K5-VSSP. JADE,

which is GSI's domestic observation project, and IVS-T2 sessions belong to this class. Only Mizusawa and Ishigakijima participated in these sessions.

Table 2 Antenna parameters.

Diameter of main reflector	20m		
Mount type	AZ-EL		
Surface accuracy	0.2mm (rms)		
Pointing accuracy	<12"(rms)		
	Azimuth	Elevation	
Slew range	-90° – 450°	5° – 85°	
Slew speed	2.1°/sec	2.1°/sec	
Acceleration	2.1°/sec ²	2.1°/sec ²	
	S	X	K
HPBW	1550"	400"	150"
Aperture efficiency	0.25	0.4	0.47

Table 3 Front-end and back-end parameters.

Front-end parameters			
Frequency band	S	X	K
Frequency range (GHz)	2.18–2.36	8.18–8.60	21.5–24.5
Receiver temperature	>100 °K	100 °K	39±8 °K
Polarization	RHC	RHC	LHC
Receiver type	HEMT	HEMT	cooled HEMT
Feed type	Helical array		Horn
Back-end parameters			
Observation type	VERA	T2 and JADE	
channels	16	16	
Bandwidth/channel	16 MHz	4 MHz	
Filter	Digital	Analog video band	
Recorder	DIR2000	K5VSSP	
Recording rate	1 Gbps	128 Mbps	
Deployed station	4 VERA	Mizusawa, Ishigakijima	

3 Staff

Noriyuki Kawaguchi is director of Mizusawa VLBI Observatory. The geodesy group consists of Yoshiaki Tamura (scientist), Takaaki Jike (scientist), and Makoto Shizugami (engineer).

4 Activities during the Past Year

VERA observes seven days a week, except for during a maintenance period in June and July. The 24-hour geodetic sessions are allocated two or three times in a month. Among these geodetic sessions, VERA internal geodetic observations in K-band are performed once or twice in a month, and Mizusawa and Ishigakijima participate in JADE by GSI or IVS-T2 sessions in S/X-band on a once-a-month basis. The main purpose of the VERA internal geodetic observations is to determine relative positions of the VERA antennas accurate enough for astrometric requirements. The purpose of the S/X sessions is to link the VERA coordinates into the IVS reference frame.

In the VERA internal geodetic sessions, the regularly-used frequency changed from S/X-band to K-band in 2007. The reason for the shift of the observing frequency band from S/X-band to K-band is to avoid the strong radio interference by mobile phones in S-band, particularly at Mizusawa. The interfering signal which has line spectra is filtered out. But this filtering considerably degrades the system noise temperature. The interference zone is increasing, so it is likely that S-band observing will become impossible in the near future. On the other hand, VERA has the highest sensitivity in K-band as shown in Table 3. Thanks to the high sensitivity in this band the maximum number of scans in K-band is 800/station/24-hours while that in S/X-band is 500 at most. It has been confirmed that the K-band observations are far more precise. In fact, standard deviations of the individual determinations of the antenna positions in K-band are less than half of those in S/X-band.

In 2014, a long maintenance period from the beginning of June to the middle of August was allocated. Except for this period, VERA carried out regular VLBI observations. We participated in six T2 sessions and in four JADE sessions. VERA internal geodetic observations were carried out 17 times. The final estimation of the geodetic parameters are derived by using the software developed by the VERA team.

Continuous GPS observations were carried out at each VERA station throughout the year. The superconducting gravimeter (SG) installed within the enclosure of the Mizusawa VLBI observatory, in order to accurately monitor gravity change for the purpose of mon-

itoring height change at the VERA Mizusawa station, continued acquisition of gravity data. Four water level gauges surrounding the SG were used for monitoring the groundwater level. The preliminary results show that gravity variation due to the variation of the water table can be corrected as accurately as the 1 microgal level. An SG was newly installed also at the VERA Ishigakijima station, and observing started in January 2012. The observing continued also during 2014. The observing aims at solving the cause of the slow slip event which occurs frequently around the Ishigaki island.

5 State of the Crustal Movement after the 11-Mar-2011 Earthquake at Mizusawa

After the 2011 earthquake off the Pacific coast of Tohoku (Mw=9.0) [Epoch=11 March 2011, 14:16:18 JST], VERA-Mizusawa was displaced by co-seismic crustal movement and post-seismic creeping. Also in 2014, the creeping continued, although the speed declined. According to the newest analysis, the co-seismic steps are X= -2.013 m, Y= -1.380 m, and Z= -1.072 m, and the displacement by creeping during 2014 is X= -0.091 m, Y= -0.061 m, and Z= -0.031 m.

6 Future Plans

Now, the examination of increasing a recording rate to 4 Gbps from 1 Gbps with direct sampling (OCTAD) is being carried out. The reconstruction accompanying this specification change is planned also for the S/X system. The received frequency of X-band will be widened to 8-9 GHz. Furthermore, the examination for changing the recording system from tape recorder to HDD (OCTADISK) is also under enforcement. With these changes, the operation of a new software correlation system (OCTACOR2) is due to become regular. The participation of the Ishigakijima station in IVS sessions will stop after the T2 session in February, 2015. The VERA Network operation office and correlation office will be merged, and the headquarters of the VERA operation team will be assigned to Mizusawa in the 2015 fiscal year.

Noto Station Status Report

Gino Tuccari

Abstract The Noto VLBI station was fully operational in 2014. A great effort was made to install the frequency agility mechanics and to develop a new SXLP receiver and the VGOS compatible front- and back-end systems.

1 Antenna and Receivers

Frequency agility installation in the antenna has been done after summer with the help of a specialized company. The modification of the single receiver to be adapted to the new environment will be progressively realized, in order to avoid stopping any observational run. A new SXLP receiver has been completed and is under test. Both polarizations for each band are available and X band is expanded up to 1 GHz.

Development of the new VGOS broadband DBBR receiver operating in the range of 1-16 GHz continued. The feed and cryogenic sections were completed. Two new front-end LNAs from Caltech were purchased. This receiver has been developed to operate on a typical 12-m VGOS antenna and will be adapted to the Noto 32-m radio telescope, making use of a tertiary mirror operating in the vertex room. Initially, the DBBC3-L system will be used as a backend, capable of covering the entire range up to 16 GHz with the new developed GCoMo units. A Faraday cage was developed and placed in the vertex room. Its mechanical behavior allows the maintenance of

Istituto di Radioastronomia INAF, Noto

Noto Network Station

IVS 2014 Annual Report

the DBBC3-L system orientation always independent of the antenna elevation position, to eliminate any possible mechanical stress to the internal contacts and electronic parts.

2 H-maser

Whereas the old EFOS-5 has been modified to be kept still active in parallel with the new one, two masers are now available. Additional pieces of equipment were installed in order to have a continuous comparison between the two atomic clocks and to optimize the clock and timing distribution.

3 e-VLBI

The connection at 10 Gbps was activated in October 2013. Nowadays at the station, e-VLBI observations at 1 Gbps are routine operations.

4 DBBC

The DBBC3 project, a collaboration between IRA (Italy) — MPI (Germany) — (OSO) Sweden, is progressing as expected in the scheduled time. First observations are planned for March 2015 for the Event Horizon Telescope. Two double polarization back-ends are going to be completed, including the FILA40G unit. Its functionality is to receive multiple 10 G connections coming from the output of the

CORE3 boards and handling the data Ethernet packets for different functionality. One of them is the recording capability at 32 Gbps. Two pictures of the DBBC3 with the internal and external views are shown.



Fig. 1 DBBC3-L: internal view



Fig. 2 DBBC3-L: external view

5 Observations

During 2014, seven geodetic experiments were observed: EUR127, T2096, CRF83, EUR129, T2100, EUR132, and CRF85.

Ny-Ålesund Geodetic Observatory 2014 Annual Report

Moritz Sieber

Abstract In 2014, the 20-m telescope at Ny-Ålesund, Svalbard, operated by the Norwegian Mapping Authority (NMA), took part in 136 out of the 138 IVS 24-hour sessions for which Ny-Ålesund was scheduled, including the 15 sessions of CONT14.

1 General Information

The Geodetic Observatory of the Norwegian Mapping Authority (NMA) is situated at 78.9° N and 11.9° E in Ny-Ålesund, in Kings Bay, at the west side of the island of Spitsbergen. This is the biggest island in the Svalbard archipelago. In 2014, Ny-Ålesund was scheduled for 138 24-hour VLBI sessions, including R1, R4, EURO, RD, T2, and RDV sessions and CONT14, and 47 one-hour sessions within the Intensives program.

In addition to the 20-meter VLBI antenna, the Geodetic Observatory has two GNSS antennas in the IGS system and a Super Conducting Gravimeter in the Global Geodynamics Project (GGP) installed at the site.

The French-German AWIPEV research base in Ny-Ålesund operates a DORIS station. In October 2004, a GISTM (GPS Ionospheric Scintillation and TEC Monitor) receiver was installed at the Mapping Authority's structure in the frame of ISACCO, an Italian research project on ionospheric scintillation observations, led by Giorgiana De Franceschi of the Italian Institute of Volcanology and Geophysics (INGV). Another Real-Time

Ionospheric Scintillation (RTIS) Monitor was set up by the NMA in November 2012.

1.1 Component Description

The antenna with a 20-m diameter is intended for geodetic use and receives in S- and X-band. Its design and construction are similar to those at Green Bank and Kokee Park. A rack with 14 video-converters, a Mark IV decoder, and a Mark 5 sampler streams the data to a Mark 5B+ recorder. Another Mark 5 unit is used to transfer data via network to the correlators. Timing and frequency is provided by a NASA NR maser, which is monitored by a CNS system.

1.2 Staff

The staff at Ny-Ålesund consists of four people employed at 75%, which means that three full-time positions are covered (see Table 1 for an overview). Each position goes with a three-year contract that can be extended up to 12 years, but people stay an average of three to four years. The observatory is part of the Geodetic Division of the Norwegian Mapping Authority with a main office at Hønefoss (near Oslo).

During 2014, Susana got the unique opportunity to start working at the new observatory in the Azores — together with her boyfriend, so there was no point in even trying to convince her to stay. Geir took half a year of leave to swap Svalbard for living on the small, remote island of Jan Mayen in the Arctic Ocean. To cover the temporary low manning until his return in April

Norwegian Mapping Authority, Geodetic Institute

NYALES20 Network Station

IVS 2014 Annual Report



Fig. 1 Station staff in October (image: Bjørn-Owe Holmberg).

2015 and until a new employee is found, Alex Burns (MIT Haystack Observatory, Westford) and Anita Titmarsh (University of Tasmania, AuScope) agreed to help out for some months, so our team became even more international.

Table 1 Staff related to VLBI operations at Ny-Ålesund.

Hønefoss	Section Manager	Reidun Kittelsrud
	Assisting Section Manager	Frode Koppang
	Technical Manager	Leif Morten Tangen
Ny-Ålesund	Station Manager	Moritz Sieber
	Engineer	Alex Burns (\geq Sept.)
	Engineer	Susana García Espada (\leq Sept.)
	Engineer	Geir Mathiassen (\leq Aug.)
	Engineer	Kent Roskifte
	Engineer	Anita Titmarsh (\geq Oct.)

2 Current Status and Activities

2.1 Maintenance

The antenna structure and gears show clear signs of wear, so regular maintenance is becoming more crucial. In March, the receiver dewar had to be replaced, one of the O-ring seals became defective, and the vacuum couldn't be held. The work took longer than expected, and the maintenance period had to be extended a bit. As a consequence, some Int3 and R1 sessions could not be observed.

2.2 Monitoring

The monitoring system was extended and now checks the main receiver parameters regularly, even when there is no observation. Data is collected from several logfiles throughout the last 24 hours and various plots (see Figure 2) are generated and displayed online on the station's documentation-wiki. This way a good overview over receiver- and recorder-performance, and environment-parameters can be maintained.

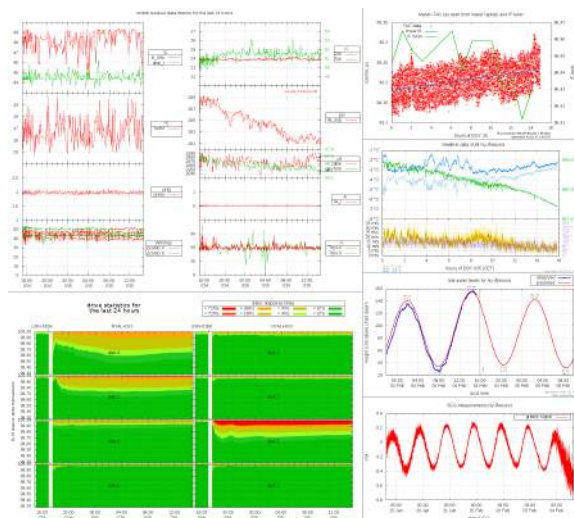

Fig. 2 Monitor-plots: receiver parameters with phase-cal/Tsys-data, drive statistics, maser-timing, meteorological data, and tide-water and gravity-measurements.

2.3 Session Performance

By end of 2013, Ny-Ålesund was scheduled for 15 CONT14, 119 24-hour, and 44 one-hour sessions. At the end of the year (2014), all of the CONT, 121 of 123 24-hour, and 45 one-hour sessions had been observed. One R1-session had to be cancelled due to extended maintenance work, and another session could not be observed due to high windspeeds throughout the scheduled period. Until mid-March there were several shorter outages during observations, mainly due to a poor receiver dewar that got replaced in the end. After that there were only four sessions with a completion of

98% or less; a more extensive summary can be found in Table 2.

Table 2 Sessions with trouble (recorded 98% or less).

Session	Comments
R4621, R4623, R1624, RV103, R4624, R1625, R1626, R4627, R4628	Receiver dewar pressure increased, interrupted the schedule, and evacuated the dewar to prevent further warmup; lost roughly one hour of observations each time.
R1628	Decoder timeout caused delays in schedule.
R1630	Not observed due to extended maintenance (replacing receiver dewar).
R1631	Decoder timeout caused delays in schedule.
R4631	Azimuth motor outage.
R1637	Tested emergency power supply during session (bad idea; lost half an hour).
R1662	Late start due to pointing problems.
R1664	Not observed due to high windspeed during the entire schedule.

2.4 New Observatory

The road construction to the new observatory site was completed during summer 2014, and the work on the foundations began with an official inauguration in October. During winter and most of the next year, the station building and all infrastructure will be established. MT Mechatronics is the contractor for the two new telescopes. They will be pre-assembled and tested during 2015 and arrive in Ny-Ålesund the year after.



Fig. 3 Sketch of the new observatory site (image: LPO arkitektør)

2.5 New Instrumentation

The station is in the transition towards a DBBC digital backend. To be able to perform parallel observations with the existing Mark IV rack, the second Mark 5 recorder had to be upgraded from Mark 5A to Mark 5B+. Thanks go to David Hall and WACO, who provided us with some of the necessary parts. The DBBC itself proved to be not really plug-and-play, but with help from Gino Tuccari, Michael Wunderlich, Jamie McCallum, Ed Himwich, and others, we managed to record some data by November. There is still some calibration and tuning missing, so we looked through AuScope's wiki and all other documentation we could find and hope to be operative by mid-2015. The demand for storage capacity during CONT14 enabled us to justify a purchase of ten 8-TB modules. All of Ny-Ålesund's data is transferred via network, and with this extended buffer we are able to keep all data until it is correlated (in case of bad transfers). We still have a little backup in case of bad connectivity. The last hundred-or-so miles between Ny-Ålesund and Longyearbyen were connected by fiber cable in September. But the line will not be operational before April 2015.

3 Future Plans

Getting the DBBC operational is just a first step to try out and get training for the new equipment. There is no intention to increase the manning even during the period of parallel observations (estimated to be 2018–2020), so good routines need to be developed.

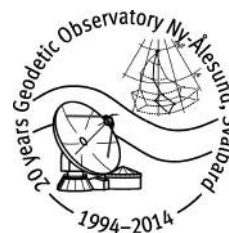

Fig. 4 20 years of the Geodetic Observatory in Ny-Ålesund!

German Antarctic Receiving Station (GARS) O’Higgins

Alexander Neidhardt ¹, Christian Plötz ², Thomas Klügel ², Torben Schüler ²

Abstract In 2014, the German Antarctic Receiving Station (GARS) O’Higgins did not contribute to the IVS observing program, due to extended maintenance work on the receiver front-end. The receiver with the dewar was dismantled and updated at the IVS Centro de Desarrollos Tecnológicos de Yebes in Spain. It will be installed in the coming 2015 campaign.

1 General Information

The German Antarctic Receiving Station (GARS) is jointly operated by the German Aerospace Center (DLR) and the Federal Agency for Cartography and Geodesy (BKG, belonging to the duties of the Geodetic Observatory Wettzell (GOW)). The Institute for Antarctic Research Chile (INACH) coordinates the logistics. The 9-m radio telescope at O’Higgins is mainly used for downloading remote sensing data from satellites such as TanDEM-X and for the commanding and monitoring of spacecraft telemetry. It is also used for geodetic VLBI during dedicated campaigns in the Antarctic summer. In 2014, the station was again manned by DLR staff and by a team for the maintenance of the infrastructure (e.g. the power and freshwater generation), lasting an entire year. BKG staff was on site from January to the beginning of March. No IVS sessions were run during this time period. The transport of the new maser EFOS-50 from

Concepción, Chile to Punta Arenas and on board the “Aguiles” to O’Higgins was one of the main tasks. The installation of the maser was done on location by T4Science. The complete replacement of both tide gauges was also one of the tasks during this campaign besides the installation of a new operator desk and the setup of the network infrastructure. There was no campaign between November—December 2014.

Over the last few years, special flights using “Hercules C-130” aircrafts and small “Twin Otter DHC-6” aircrafts, as well as transportation by ship, were organized by INACH in close collaboration with the Chilean Army, Navy, and Airforce, and with the Brazilian and Uruguayan Airforce in order to transport staff, technical material, and food for the entire stay from Punta Arenas via Base Frei on King George Island to O’Higgins on the Antarctic Peninsula. The conditions for landing on the glacier are strongly weather dependent and involve an increasing risk; in general, transport of personnel and cargo is always a challenging task. Arrival and departure times strongly depend on the climate conditions and on the logistic circumstances.

After each Antarctic winter, the VLBI equipment at the station must be initialized again. Damages resulting from the winter conditions or strong storms have to be identified and repaired. Shipment of each kind of material, such as spare parts or upgrade kits, has to be carefully prepared in advance.

Besides the 9-m VLBI antenna, which is used for the dual purposes of receiving data from and sending commands to remote sensing satellites and performing geodetic VLBI, the following are other geodetic-relevant instruments also operated on site:

- currently two H-masers (EFOS-10 and EFOS-50), an atomic Cs-clock, a GPS time receiver, and a To-

1. Forschungseinrichtung Satellitengeodäsie (FESG), Technische Universität München

2. Bundesamt für Kartographie und Geodäsie (BKG)



Fig. 1 The Webcam image of the VLBI antenna.

tal Accurate Clock (TAC), offering time and frequency.

- two GNSS receivers (OHI2 and OHI3), operating in the framework of the IGS network while both are Galileo enabled. The receivers worked without failure.
- a meteorological station providing pressure, temperature, humidity, and wind information, as long as the temporarily extreme conditions did not disturb the sensors.
- a radar tide gauge, which was established in 2012 and reinstalled in 2014. The radar sensor itself is space referenced by a GPS-antenna mounted on top and Earth referenced via the local survey network. The radar gauge is operated only during the Antarctic summer.
- an underwater sea level gauge for permanent monitoring of water pressure, temperature, and salinity (also updated in 2014).
- two SAR corner reflectors, which were installed in March 2013 as part of a network to evaluate the localization of the accuracy of the TerraSAR-X mission.

2 Staff

The members of staff for operation, maintenance, and upgrade of the VLBI system and other geodetic devices are summarized in Table 1.

Table 1 Staff members.

Name	Affiliation	Function	Mainly working for
Torben Schüler	BKG	head of the GOW	GOW
Christian Plötz	BKG	electronic engineer (chief engineer RTW)	O'Higgins, RTW, TTW
Christian Schade	BKG	geodesist	O'Higgins operator, SLR
Reiner Wojdziak	BKG	software engineer	O'Higgins, IVS Data Center Leipzig
Andreas Reinhold	BKG	geodesist	O'Higgins operator
Thomas Klügel	BKG	geologist	administration laser gyro/ local systems Wettzell
Rudolf Stoeger	BKG	geodesist	logistics for O'Higgins, GNSS
Alexander Neidhardt	FESG	head of the VLBI group and VLBI station chief	RTW, TTW
Gerhard Kronschnabl	BKG	electronic engineer (chief engineer TTW)	TTW, RTW, TIGO

3 Observations in 2014

GARS did not participate in any IVS sessions in 2014 due to extended maintenance work on the receiver front-end.

4 Technical Improvements and Maintenance

The extreme environment conditions in the Antarctic require special attention to the GARS telescope and the infrastructure. Corrosion frequently results in problems with connectors and capacitors. Defective equipment needs to be detected and replaced. The antenna, the S/X-band receiver, the cooling system, and the data acquisition system have to be activated properly. A problem is the low transfer rates on the communication line, which reduces Internet and phone access. Also, the Web cams are regularly maintained.

An extended maintenance was performed on the dismantled receiver front-end. The maintenance included a complete redesign and rearrangement of the receiver hardware at the IVS Centro de Desarrollos Tecnológicos de Yebes in Spain. The down converter unit and the receiver monitoring were replaced by a completely newly developed 19" mountable system, which was installed in the original frame structure. It

is connected to a modular power supply. New local oscillators, a new noise calibration unit, and new front and back plates were also part of the redesign of the receiver front-end. The dewar, which was revised in the labs at Yeves in 2013, is also installed now into the existing frame structure. The dewar should fulfill the specification to hold 20 K in a vacuum of 5×10^{-7} mbar for more than one year without maintenance. For the new hardware, new monitoring software is also available and must be integrated into the NASA Field System setup for O'Higgins. The new hardware will be installed during the first campaign of 2015. The goal is the realization of an almost remotely controllable, autonomous, stable, and service-reduced system for the future challenges.

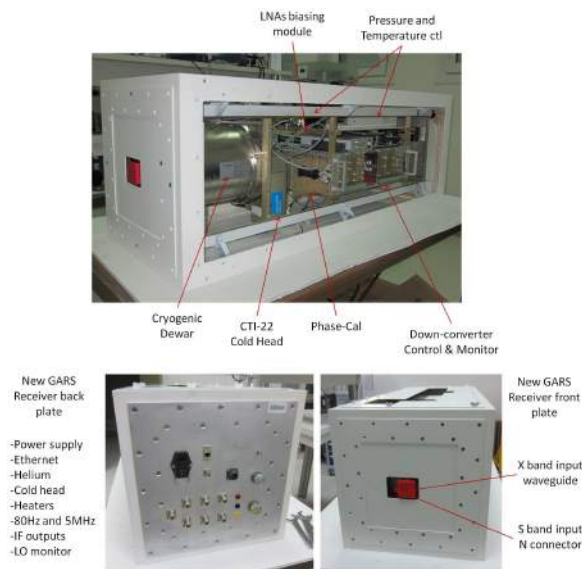

Fig. 2 The new receiver front-end at O'Higgins, which was maintained at the IVS Centro de Desarrollos Tecnológicos de Yeves, Spain.

Additionally, the new maser EFOS-50 from T4Science was shipped from TIGO Concepción to O'Higgins, where it has been running parallel to the old EFOS-10 since February 2014. All existing GNSS receivers were upgraded with a Galileo-enabled system. The tide gauges were completely reinstalled during the 2014 campaign. A new control room with a new operator desk was also installed and built-up during this campaign so that additional equipment, such as a digital baseband converter and a new Mark 5B+, can be installed before the first campaign of 2015.

The operator room is jointly used by DLR and BKG. The goal is to extend the autonomous and remote operability of the site to enable the requirements for more observation sessions over the whole year. It is a key feature to extend the operation periods in GARS O'Higgins without increasing the presence of staff on site.



Fig. 3 The new control room with the operator desk for VLBI work of the BKG and satellite tracking of the DLR.

It is further planned to use the gaps between the satellite downlinks and commanding periods for geodetic VLBI. This requires a suitable communication with the scheduling and control software of the DLR, which still has to be done.

In 2014, a common paper with the title "Earth and space observation at the German Antarctic Receiving Station O'Higgins" was published in *Polar Record*.

5 Future Plans

The plan is to install a new Field System PC, a new Mark 5B+, and a new digital baseband converter ADS3000+ in the first campaign of 2015. After the installation of the receiver, the system must be brought back into operation again. A dedicated plan should offer a shared and interleaved observation of satellites (DLR) and VLBI sources (BKG) during the whole year.

Onsala Space Observatory – IVS Network Station Activities during 2014

Rüdiger Haas, Gunnar Elgered, Johan Löfgren, Tong Ning, Hans-Georg Scherneck, Thomas Hobiger

Abstract We participated in 39 IVS sessions, including CONT14. Eleven out of the initially planned sessions could not be observed due to the installation of a new radome for the 20-m radio telescope. As in the previous six years, we used several of the sessions that involved both Onsala and Tsukuba to perform ultra-rapid UT1-UTC sessions together with our colleagues in Tsukuba. This included the complete CONT14 campaign where near real-time UT1-UTC on the baseline Onsala—Tsukuba could be determined. The procurement of the telescopes for the Onsala Twin Telescopes was started in the summer of 2014. The contract to buy two VGOS radio telescopes was signed at the end of the year.

1 General Information

The Onsala Space Observatory is the national facility for radio astronomy in Sweden with the mission to support high-quality research in radio astronomy and geosciences. The geoscience instrumentation at Onsala includes equipment for geodetic VLBI, GNSS, a superconducting gravimeter with a platform for visiting absolute gravimeters, several microwave radiometers for atmospheric measurements, both GNSS based and pressure based tide gauges, and a seismometer. The Onsala Space Observatory can thus be regarded as a fundamental geodetic station. Figure 1 shows an aerial photo taken during the replacement of the radome en-

Chalmers University of Technology, Department of Earth and Space Sciences, Onsala Space Observatory

Onsala IVS Network Station

IVS 2014 Annual Report



Fig. 1 The replacement of the upper part of the radome enclosing the 20-m radio telescope on 15 September 2014.

closing the 20-m radio telescope that is currently the instrument that is used for geodetic VLBI observations. In the next two years the Onsala Twin Telescopes (OTT) will be installed at the observatory, consisting of a pair of two new antennas following VLBI2010 recommendations.

The staff members associated with the IVS Network Station at Onsala are listed in Table 1.

2 Geodetic VLBI Observations

In total, 50 IVS sessions including Onsala were planned for 2014, including the CONT14 campaign. But because the radome of the 20-m radio telescope had to be replaced and the telescope could not be used during this time, we could not participate in 11 of the planned sessions. For the majority of the 39 sessions that we observed, including the complete CONT14 campaign, we performed parallel recordings with the old Mark IV/Mark 5A and the new DBBC/Mark 5B+

Table 1 Staff members associated with the IVS Network Station at Onsala. All e-mail addresses have the ending @chalmers.se, and the complete telephone numbers start with the prefix +46-31-772.

Function	Name	e-mail	telephone
Responsible P.I.s for geodetic VLBI observations	Rüdiger Haas	rudiger.haas	5530
	Thomas Hobiger (2014.08.01–)	thomas.hobiger	5549
Observatory director	John Conway	john.conway	5503
Head of department	Gunnar Elgered	gunnar.elgered	5565
Ph.D. students and postdocs involved in geodetic VLBI	Niko Kareinen	niko.kareinen	5566
	Johan Löfgren (–2014.06.30)	johan.lofgren	5566
	Tong Ning (–2014.06.30)	tong.ning	5578
Responsible for the VLBI Field System	Michael Lindqvist	michael.lindqvist	5508
	Rüdiger Haas	rudiger.haas	5530
Responsible for the VLBI equipment	Karl-Åke Johansson	karl-ake.johansson	5571
	Leif Helldner	leif.helldner	5576
Responsible for the VLBI operators	Roger Hammargren	roger.hammargren	5551
Telescope scientist	Henrik Olofsson	henrik.olofsson	5564
Software engineer	Mikael Lerner	mikael.lerner	5581
Responsible for gravimetry	Hans-Georg Scherneck	hans-georg.scherneck	5556

data acquisition systems, see Table 2. Zero-baseline tests with the two types of recording systems were done both at Onsala and the Bonn correlator. The Bonn correlator also produced several databases with two Onsala stations, using both recording types. These databases were systematically analyzed, and no significant differences in the derived geodetic results were found. Finally, in the summer of 2014, the old Mark IV rack was removed and placed in the observatories' museum. Since then, the DBBC/Mark 5B+ system has been the primary data acquisition system.

In the fall of 2014 a second data acquisition system was installed, including a second DBBC and a Mark 5C recorder. Several tests with parallel recordings of the two systems were performed and are still under investigation. Also tests with a Fila10G/FlexBuff system were done and are under investigation.

Three observing sessions failed, see Table 2, because the wrong polarization for X-band was connected.

In addition to the IVS sessions, we observed test experiments together with Wettzell to observe signals from several GLONASS satellites.

3 Monitoring Activities

We continued with the monitoring activities as described in previous annual reports:

Local tie vector at Onsala.

During CONT14 an automated classical geodetic survey of the reference point of the 20-m radio telescope was performed. Together with additional measurements in the local network, thus the local tie vector between the VLBI and GNSS reference points could be determined in a local system. This was followed by a several week long GNSS campaign in the local network. Finally, the combination of the classical survey results and the results from the analysis of the GNSS campaign gave a new realization of the local tie vector which will be used for ITRF2014.

Additionally, data observed with two gimbal-mounted GNSS antennas on the dish of the 20-m radio telescope were used to determine a purely GPS-based local tie vector. A manuscript on this topic has been submitted and is under revision.

Vertical height changes of the telescope tower.

We continued to monitor the vertical height changes of the telescope tower using the invar rod system at the 20-m telescope. The measurements are available at <http://wx.oso.chalmers.se/pisa/>.

Calibration of pressure sensor.

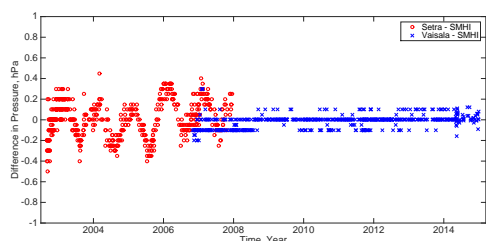

Fig. 2 Time series of pressure differences between the VLBI pressure sensors and the calibrated pressure sensor from SMHI.

We continued to calibrate the Onsala pressure sensor using a Vaisala barometer borrowed from the Swedish Meteorological and Hydrological Institute (SMHI). This instrument was installed at Onsala in late 2002. It has been calibrated regularly at the SMHI main facility in Norrköping since then. The latest calibration was on October 11, 2011.

Since the installation of a new VLBI pressure sensor in 2008, the agreement between the Onsala VLBI pressure and the pressure read by the calibrated sensor is on the level of ± 0.1 hPa. Unfortunately, this VLBI pressure sensor failed on Christmas evening 2014 and needs to be replaced by a new sensor.

Microwave radiometry.

The water vapor radiometer Astrid was operating continuously during the year, although it was suffering from a failure of the 31 GHz channel until September 2014. Hence, its data until then are only useful during atmospheric conditions with no significant amount of liquid water. Konrad was operating continuously during the first six months of 2014. During the second half of the year Konrad had a failure of the mechanical waveguide switch used for calibrations.

Sea-level monitoring.

The GNSS-R based tide gauge was operated continuously. Additionally, a tide gauge based on pressure sensors was operated next to it throughout the year.

The construction of the new tide gauge, a collaboration project with SMHI, was completed (see Figure 3). It is equipped with a radar sensor and a bubbler sensor inside the tide gauge well, and another bubble sensor outside nearby. The first test measurements were started in the autumn of 2014.

Superconducting gravimetry.

The superconducting gravimeter operated continuously and produced a highly precise record of gravity variations. The data loss in 2014 was 0.52% in the



Fig. 3 The new tide gauge station at the Onsala Space Observatory, operated together with SMHI.

one-second record, confined to one single event at the end of February, a failing Flash Card memory in the data buffer of the ADC converter. Since September 2014, tide solutions have been prepared on a weekly basis and results made available on the SCG homepage (<http://holt.oso.chalmers.se/hgs/SCG/toe/toe.html>).

Absolute gravimetry.

We supported a visiting absolute gravity measurement campaign with two gravimeters operating in parallel, one from Lantmäteriet, the Swedish mapping, cadastral and land registration authority, and one from Leibniz University, Hannover, Germany.

Seismological observations.

The seismometer owned by Uppsala University and the Swedish National Seismic Network (SNSN) was operated throughout the year.

4 Future Plans

- For 2015 we plan to observe a total of 44 IVS sessions. Additionally, we plan for further sessions during EVN observing campaigns.
- We strive to restart operating ultra-rapid UT1-UTC sessions with our colleagues at GSI in Japan.
- In parallel to the regular DBBC/Mark 5B+ operations, we will do tests with the DBBC/Fila10G/FlexBuff system.
- We will continue the usual monitoring activities at the observatory.

Table 2 Geodetic VLBI observations at Onsala during 2014. Information is given on which VLBI backend was used, whether data were e-transferred in real-time (RT) and/or off-line (OL) and to which correlator, whether modules were shipped to a correlator, and whether Ultra-rapid UT1-UTC results were produced. The last column gives some general remarks and information on the percentage of the scheduled Onsala (On) observations that were used in the analysis (as reported on the Web pages for the IVS session analyses), compared to the station average (StAv) percentage per experiment. Three sessions were unsuccessful (R1-642, R1-657, and RV-107) because unfortunately, the wrong polarization for X-band was connected. The Mark 5B+ module for C14-02 failed at the correlator, so the production had to be done with the Mark 5A data. During C14-03 the FS terminated during the night, and this was not discovered in time because no operator was at the site, so two hours of data were lost.

Exper.	Date	VLBI-backend	E-transfer	Module	Ultra-rapid	General remarks and % of scheduled observations used in the
		Mark IV DBBC	RT OL	shipment	UT1-UTC	analysis as reported in the IVS Web pages' analysis reports.
R1-619	01.06	yes	yes	– Bonn	–	Mark IV/Mark 5A in production, On: 93.3% (StAv: 89.9%)
R1-621	02.21	yes	yes	– Bonn	–	Mark IV/Mark 5A in production, On: 94.6% (StAv: 89.2%)
R1-624	02.10	yes	yes	Tsuk Bonn	–	Mark IV/Mark 5A in production, On: 85.7% (StAv: 81.9%)
RV-103	02.12	yes	–	– Socc	yes	Mark IV/Mark 5A in production, On: 84.8% (StAv: 88.3%)
RD-14-02	03.26	yes	yes	Tsuk Hays	–	Mark IV/Mark 5A in production, not correlated / analyzed yet
R1-631	03.31	yes	yes	Tsuk Bonn	–	Mark IV/Mark 5A in production, On: 85.4% (StAv: 77.0%)
RV-104	04.01	yes	yes	– Socc	yes	Mark IV/Mark 5A in production, On: 38.2% (StAv: 48.9%)
R1-632	04.07	yes	yes	– Bonn	–	Mark IV/Mark 5A in production, On: 83.0% (StAv: 71.5%)
RD-14-03	04.23	yes	yes	– Hays	–	Mark IV/Mark 5A in production, not correlated / analyzed yet
C14-01	05.06	yes	yes	Tsuk Bonn	yes	DBBC/Mark 5B+ in production, On: 86.7% (StAv: 83.7%)
C14-02	05.07	yes	yes	Tsuk Bonn	yes	Mark IV/Mark 5A in production, On: 76.7% (StAv: 83.4%)
C14-03	05.08	yes	yes	Tsuk Bonn	yes	DBBC/Mark 5B+ in prod., 2 h lost, On: 82.5% (StAv: 86.9%)
C14-04	05.09	yes	yes	Tsuk Bonn	yes	DBBC/Mark 5B+ in production, On: 88.8% (StAv: 85.3%)
C14-05	05.10	yes	yes	Tsuk Bonn	yes	DBBC/Mark 5B+ in production, On: 90.8% (StAv: 86.2%)
C14-06	05.11	yes	yes	Tsuk Bonn	yes	DBBC/Mark 5B+ in production, On: 80.7% (StAv: 74.5%)
C14-07	05.12	yes	yes	Tsuk Bonn	yes	DBBC/Mark 5B+ in production, On: 86.2% (StAv: 83.3%)
C14-08	05.13	yes	yes	Tsuk Bonn	yes	DBBC/Mark 5B+ in production, On: 91.7% (StAv: 87.5%)
C14-09	05.14	yes	yes	Tsuk Bonn	yes	DBBC/Mark 5B+ in production, On: 91.7% (StAv: 87.2%)
C14-10	05.15	yes	yes	Tsuk Bonn	yes	DBBC/Mark 5B+ in production, On: 91.9% (StAv: 91.1%)
C14-11	05.16	yes	yes	Tsuk Bonn	yes	DBBC/Mark 5B+ in production, On: 90.3% (StAv: 84.9%)
C14-12	05.17	yes	yes	Tsuk Bonn	yes	DBBC/Mark 5B+ in production, On: 89.0% (StAv: 83.5%)
C14-13	05.18	yes	yes	Tsuk Bonn	yes	DBBC/Mark 5B+ in production, On: 88.9% (StAv: 85.3%)
C14-14	05.19	yes	yes	Tsuk Bonn	yes	DBBC/Mark 5B+ in production, On: 87.1% (StAv: 80.8%)
C14-15	05.20	yes	yes	Tsuk Bonn	yes	DBBC/Mark 5B+ in production, On: 88.1% (StAv: 82.3%)
RV-105	06.25	yes	yes	– Socc	–	DBBC/Mark 5B+ in production, On: 86.2% (StAv: 78.1%)
R1-642	06.30	yes	yes	– Bonn	–	failed, X-band wrong polarization
R1-643	07.07	yes	yes	– Bonn	–	DBBC/Mark 5B+ in production, On: 91.9% (StAv: 90.1%)
RD-1405	07.08	yes	yes	– Hays	–	DBBC/Mark 5B+ in production, not correlated / analyzed yet
R1-656	10.06	–	yes	– Bonn	–	DBBC/Mark 5B+ in production, On: 75.8% (StAv: 64.9%)
R1-657	10.13	–	yes	– Bonn	–	failed, X-band wrong polarization
RV-107	10.14	–	yes	– Socc	–	failed, X-band wrong polarization
R1-661	11.10	–	yes	– Bonn	–	DBBC/Mark 5B+ in production, On: 84.8% (StAv: 73.6%)
R1-663	11.24	–	yes	– Bonn	–	DBBC/Mark 5B+ in production, On: 77.0% (StAv: 64.5%)
RV-108	12.03	–	yes	– Socc	–	DBBC/Mark 5B+ in production, On: 95.5% (StAv: 91.2%)
R1-665	12.09	–	yes	– Bonn	–	DBBC/Mark 5B+ in production, On: 82.3% (StAv: 72.9%)
R1-666	12.15	–	yes	– Bonn	–	DBBC/Mark 5B+ in production, On: 82.3% (StAv: 73.9%)
T2-101	12.16	–	yes	– Hays	–	DBBC/Mark 5B+ in production, not correlated / analyzed yet
RD-14-12	12.17	–	yes	– Hays	–	DBBC/Mark 5B+ in production, not correlated / analyzed yet
R1-667	12.22	–	yes	– Bonn	–	DBBC/Mark 5B+ in production, On: 92.4% (StAv: 87.3%)

- The new tide gauge station in collaboration with SMHI will be inaugurated.
- We will begin construction work for the Onsala Twin Telescopes.

Parkes 2014 IVS Report

John Reynolds

Abstract This report presents the status of the Parkes station in 2014.

1 Status

Parkes did not participate in any IVS experiments during 2014. Recent budgetary constraints and operational changes within CSIRO/CASS have resulted in stringent self-imposed limits on the interchange of receiver packages on the Parkes 64-meter antenna. As a consequence, it proved impossible to schedule the S/X receiver required for these experiments.

We are working with our colleagues at the University of Tasmania to redress this unfortunate state of affairs and to facilitate at least one installation of the S/X receiver on the Parkes 64 m during 2015, with the aim of participating in several back-to-back 24-hour sessions.

CSIRO

Parkes Network Station

IVS 2014 Annual Report

Korea Geodetic VLBI Station, Sejong

Yunmo Sung, Kiduk Ahn, Sangoh Yi, Hongjong Oh, Sangcheol Han, Eunjin Kim

Abstract This report briefly introduces the activities carried out at the Sejong VLBI station during 2014. The Sejong antenna can only perform S/X VLBI observing in Korea. Sejong station began to participate in IVS VLBI IVS-R1 sessions in the latter half of 2014. The geodesy division in NGII (National Geographic Information Institute) manages the Sejong station, and NGII has a plan to use the K- and Q-bands for geodetic VLBI observations with the KVN (Korean VLBI Network of KASI) in the future.

1 General Information

The Sejong station is the first geodetic VLBI station in the Republic of Korea which is dedicated to geodetic purposes. The station is located about 120 km south of Seoul at longitude $127^{\circ}18'12''E$, latitude $36^{\circ}31'12''N$, and 153 meters in height in the middle of Sejong city, which serves as a new administrative capital. The Sejong antenna is 22 meters in diameter, and multi frequency bands (S, X, K, and Q) are available at the same time.

The staff at Sejong station consists of six people including a new site director, Ahn Ki Duk, who began work in December 2014. Mr. Yi Sang Oh is responsible for planning of annual VLBI observing, both international and domestic. Mr. Oh Hong Jong is responsible for RFI monitoring and co-location for space geodetic techniques. Mr. Han Sang Cheol is responsi-

National Geographic Information Institute

Sejong Network Station

IVS 2014 Annual Report



Fig. 1 Layout of Sejong station: 1. VLBI antenna 2. pillar for co-location 3. UTP(Unified control Point) 4. IGS station (SEJN) 5. (Under construction) SLR site of KASI 6. (Under installation) MR(Microwave Radiometer) of KASI.

ble for antenna maintenance. The Sejong station has a VLBI antenna, an IGS station (SEJN), four pillars for co-location, and a mobile SLR system (40 cm in diameter) which is already developed by KASI and will be relocated. Three space techniques (VLBI, GNSS, and SLR) are directly measurable by electric survey instrument. And an MR (Microwave Radiometer) will be installed on the roof of the main observation building. Dr. Jung Ho Cho of KASI is the person in charge of the MR, and NGII and KASI are expecting to use it to calibrate for the water vapor effect on VLBI and GNSS.

Table 1 Staff members of the Sejong station.

Name	Responsibility	e-mail
Ki Duk Ahn	Site Director	akd8@korea.kr
Sangoh Yi	Analysis	sangoh.yi@korea.kr
Hongjong Oh	Analysis	stockoh11@korea.kr
Sangcheol Han	VLBI maintenance	hsc4907@korea.kr
Eunjin Kim	Operator	vikisio1015@gmail.com
Sangwon Lee	Operator	lsw860210@gmail.com

2 Sejong VLBI System

The Sejong VLBI configuration is listed in Table 2.

The S and X SEFDs were about 2,000 — 3,000 Jy. The reason why they have high SEFDs is that we used coaxial cable (length is about 30 cm) to connect from the feed to the cryogenic chamber. We have a plan to improve it in the future. The K- and Q-band receiver systems are still not ready to be operated. Because Sejong antenna was designed to use the multi-frequency receiving system, in order to work it properly, the lower frequency system (that is S/X) must be completed in the first place. S/X system was completed in the middle of 2014. We expect that the K and Q systems will be completed within 2015. The Sejong site uses the Field system (FS 9.10.4) and the K5 data recorder. To send VLBI data to a correlator, we use data format converter (k5tom5b) software developed by NICT.

Table 2 Sejong Antenna parameters.

Parameters	Sejong VLBI
IVS letter codes	Sejong (Kv)
CDP number	7368
DOMES number	23907S001
Location	Lat.: 36°31'N, Long.: 127°18'E
Elevation	177m
Diameter of main reflector	22m
Antenna type	Shaped Cassegrain
Aperture efficiency	about 60%
Pointing accuracy	0.0131°
Reflector surface accuracy	100 μm
Operation range	AZ: ±270° EL: 0 ~ 90°
Slew speed	5°/sec (AZ and EL)
FS Version	9.10.4
Data acquisition Recorder	K5

Table 3 Receiving system of the Sejong VLBI system.

Bands	S	X	K	Q
Freq. [GHz]	2.1–2.6	8.0–9.0	21–23	42–44
Receiver noise temp.	< 20K	< 30K	< 50K	< 80K
Polarization	R,L	R,L	R,L	R,L
SEFD	3,000	3,000	–	–
Aperture efficiency	0.6	0.6	0.6	0.6

3 Activities in 2014

3.1 VLBI Observations

In early 2014, we prepared to join IVS regular sessions by doing several fringe tests with the Tsukuba (GSI) and Kashima (NICT) antennas. We appreciate their help. In August, the IVS managed the fringe test for the Sejong antenna to verify its performance. Thankfully, three antennas (Sejong, Shanghai, and Hobart) were involved in the fringe tests. Finally, the IVS finally accepted Sejong to join the IVS regular sessions. Beginning with session IVS-R1655, we are consistently participating in IVS-R1 observations. In December, we successfully obtained the first light at Q-band. The Sejong staff and the KVN members managed this fringe test together. We used single dish observations and used auto correlation modules to find fringes.

**Fig. 2** Facilities for local-ties in the Sejong station.

Table 4 Activities for VLBI observations. [NGII: National Geographic Information Institute, KVN: Korean VLBI Network, KJCC: Korea-Japan Correlation Center, GSI: Geospatial Information Authority of Japan, NICT: National Institute of Information and Communications Technology.]

No.	session	SKED	Corr.	Freq.	Remarks
1	t2095	GSI	NGII	S/X	ant. performance test
2	f14071	KVN	KJCC	X	ant. performance test
3	s14073	GSI	NGII	S/X	ant. performance test
4	r1633	GSI	NGII	S/X	ant. performance test
5	s14108	GSI	NGII	S/X	ant. performance test
6	c1415	NICT	NGII	S/X	ant. performance test
7	f14141	NICT	NGII	S/X	ant. performance test
8	jd1405	GSI	NGII	S/X	ant. performance test
9	a14147a	KVN	KJCC	X	ant. performance test
10	kvnfrg	IVS	HAYSTACK	S/X	ant. performance test
11	kvwfrg	IVS	HAYSTACK	S/X	ant. performance test
12	r1655	IVS	NGII-KASI	X	regular observing
13	f14293a	KVN	NGII-KASI	X	fringe test
14	r1658	IVS	NGII-KASI	X	regular observing
15	-	KVN	KJCC	Q	fringe test
16	r1666	IVS	KJCC	S/X	regular observing
17	f4c18a	CVN	CVN	X	fringe test
18	f14352a	KVN	KJCC	X	fringe test
19	r1667	IVS	KJCC	S/X	regular observing
20	f14358a	KVN	KJCC	X	fringe test
21	r1668	IVS	KJCC	S/X	regular observing

3.2 S/X Receiving System Improvement Work

In early 2013, the S/X SEFDs showed ranges between 30,000 Jy and 80,000 Jy which is higher than we expected. The main problem was an S/X dual feed. We separated the two feeds to improve the SEFDs to 1,500 — 2,000 Jy. We obtained these SEFD results by using standard sources such as Cas A, Taurus A, and Cygnus A. We will keep working on the improvement of the antenna performances.

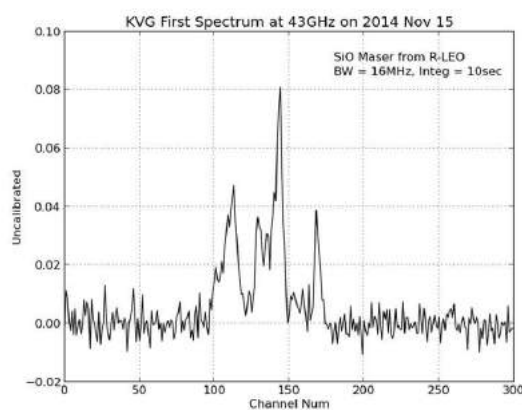
3.3 Joining the AOV (Asia-Oceania VLBI Group)

The Sejong station joined the AOV group that was discussed at the IVS 8th GM in Shanghai, China. In 2015, Sejong will participate in AOV VLBI observations about less than ten times due to the installation of

the K- and Q-band system. But we will actively work with them as far as possible.

3.4 SLR Site Construction

KASI began constructing the mobile SLR site in October. The diameter of the SLR is 40 cm, and the construction will be completed in the middle of 2015. The Sejong station is providing support for construction.

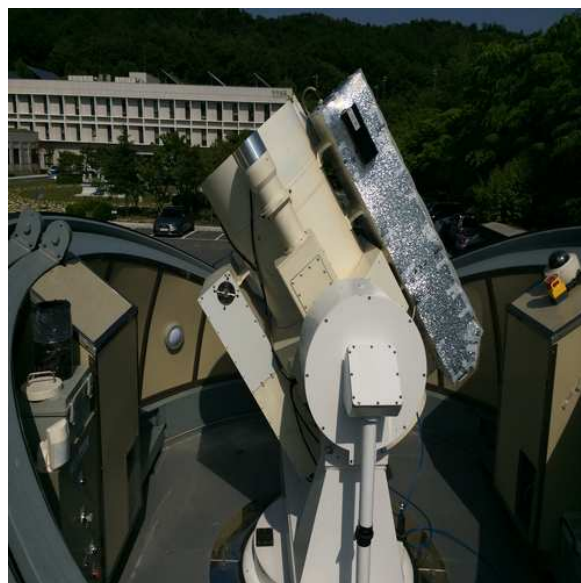

Fig. 3 Mobile SLR system developed by KASI.

4 Future Plans

We will take on the following activities in 2015: 1) participating in IVS-R1 sessions and the AOV, 2) improvement of S/X performance, 3) Korean VLBI observations (X, K, and Q) with KVN, 4) completion of SLR site and installation of Microwave Radiometer, 5) five local tie surveys, and 6) maintenance of VLBI system.

Shanghai Station Report for 2014

Bo Xia, Zhiqiang Shen, Qinghui Liu

Abstract This report summarizes the observing activities at the Sheshan station (SESHAN25) and the Tianma station (TIANMA65) in 2014. It includes the international VLBI observations for astrometry, geodesy, and astrophysics and domestic observations for satellite tracking. We will also report on the updates and the development of the facilities at the two stations.

1 General Information

The Sheshan station (SESHAN25) is located at Sheshan, 30 km west of Shanghai. It is hosted by Shanghai Astronomical Observatory (SHAO), Chinese Academy of Sciences (CAS). A 25-meter radio telescope is in operation at 1.3, 3.6/13, 5, 6, and 18 cm wavelengths. The Sheshan station is a member of the IVS and EVN.

The Tianma station (TIANMA65) is located in the western suburbs of Shanghai, Sheshan town, Songjiang district. It is jointly funded by the Chinese Academy of Sciences (CAS), Shanghai Municipality, and the Chinese Lunar Exploration Program. The telescope construction started in the early 2009, and the majority of the mechanical system was completed in October 2012. On December 2, 2013, the Tianma 65-m telescope passed the acceptance evaluation. The Tianma 65-m radio telescope, one of the largest steerable radio telescopes in the world, is a multifunction facility for astrophysics, geodesy, and astrometry as well

Shanghai Astronomical Observatory, CAS

Shanghai Network Station

IVS 2014 Annual Report

as space science. By the end of 2014, TIANMA65 was equipped with four cryogenic receiver systems (L, C, S/X, and Ku). It is expected that another three high-frequency cryogenic receiver systems (K, X/Ka, and Q) will be finished in 2015. A CDAS and DBBC2 were installed at the Tianma telescope for VLBI data acquisition.



Fig. 1 Tianma 65-m radio telescope.

The SESHAN25 and TIANMA65 telescopes take part in international VLBI experiments for astrometry, geodesy, and astrophysics researches including RadioAstron Space VLBI observations. Apart from its international VLBI activities, the telescope spent a large amount of time on the Chinese Lunar Exploration Project, including the testing before the launch of the Chang'E-5T1 satellite and the tracking campaign after the launch.

2 VLBI Observations in 2014

In 2014, the SESHAN25 telescope participated in 16 IVS regular sessions and 11 INT3 Intensive sessions. In addition, there were two Chinese domestic geodetic sessions. SESHAN25 also participated in the three regular EVN sessions in February, June, and October. We did not participate in the session R1645 due to the analog VLBI terminal VSI-C card problem. We missed the session R1657 due to the antenna motor problem. In 2014, TIANMA65 participated in two IVS sessions. The low amplitude in SR6U, XR7U and XR8U/L occasionally happened. In order to track the Chinese Chang'E-5T1 satellite, SESHAN25 or TIANMA65 have observed the Chang'E-5T1 satellite for two days per week.

3 Development and Maintenance of the Sheshan Telescope in 2014

We have upgraded the FS version from 10.04 to 11.10. We have also upgraded the antenna control software to measure the antenna pointing errors with the Gaussian fitting method.

4 The Staff of the Shanghai VLBI Station

Table 1 lists the group members of the Sheshan VLBI station. The staff are involved in the VLBI program at the station with various responsibilities.

5 Outlook

In 2015, the Sheshan radio telescope will take part in thirty-five IVS sessions and three EVN sessions. The Tianma radio telescope will take part in six IVS sessions. The telescopes will also regularly track the Chang'E-5T1 satellite in its lunar orbit.

Table 1 The staff of the Sheshan VLBI station.

Name	Background	Position and Duty	Contact
Xiaoyu Hong	Astrophysics	Director	xhong@shao.ac.cn
Zhiqiang Shen	Astrophysics	Vice Director	zshen@shao.ac.cn
Qinghui Liu	Radio technique	Chief Engineer	liuqh@shao.ac.cn
Qingyuan Fan	Ant. control	Professor, Antenna	qyfan@shao.ac.cn
Zhuhe Xue	Software	Professor, FS	zhxue@shao.ac.cn
Quanbao Ling	Electronics	Professor, Hardware	qling@shao.ac.cn
Bin Li	Microwave	Technical friend, Receiver	bing@shao.ac.cn
Tao An	Astrophysics	Astrophysics	antao@shao.ac.cn
Bo Xia	Electronics	VLBI friend, VLBI terminal	bxia@shao.ac.cn
Shiguang Liang	Microwave	Professor, Receiver	sgliang@shao.ac.cn
Li Fu	Ant. mechanics	Engineer, Antenna	fuli@shao.ac.cn
Jinqing Wang	Electronics	Engineer, Antenna	jqwang@shao.ac.cn
Lingling Wang	Software	Engineer, Timing system	llwang@shao.ac.cn
Rongbing Zhao	Software	Engineer, Antenna software	rbzhao@shao.ac.cn
Weiy Zhong	Microwave	Engineer, Receiver	wyzhong@shao.ac.cn
Wei Gou	Electronics	Engineer	gouwei@shao.ac.cn
Linfeng Yu	Electronics	Engineer	lfyu@shao.ac.cn
Yongbin Jiang	Electronics	Engineer	jyb@shao.ac.cn
Yunxia Sun	HVAC	Engineer, Refrigeration	sunyunxia@shao.ac.cn
Xiaocong Wu	Electronics	Engineer	wuxc@shao.ac.cn
Wen Guo	Electronics	Engineer	gw@shao.ac.cn
Jian Dong	Ant. Control	Engineer	dongjian@shao.ac.cn
Xiuting Zuo	Software	Engineer, Antenna	zxt@shao.ac.cn
Yongchen Jiang	Electronics	Engineer, Disk Shipping	yongchen@shao.ac.cn
Ying Chen	Microwave	Engineer, Receiver	cying@shao.ac.cn

Simeiz 22-m Radio Telescope as an IVS Network Station

A. E. Volvach, G. S. Kurbasova, L. N. Volvach

Abstract We briefly summarize the status of the 22-m radio telescope as an IVS Network Station. We also summarize the analysis of the ground and satellite measurements of local insolation in Crimea using NASA SSE observations.

1 General Information

The 22-m radio telescope RT-22 of the Radio Astronomy Laboratory is located at the foot of mount Koshka (“The Cat”) at the shore of the Black Sea, 25 kilometers west from the city of Yalta (Figure 1). RT-22, the 22-meter radio telescope, which was set in operation in 1966, is among the five most efficient telescopes in the world.

The Simeiz geodynamics area consists of the radio telescope RT-22, two satellite laser ranging stations, a permanent GPS receiver, and a sea level gauge. The radio astronomical station Simeiz was founded in 1965. The first single dish observation was made in 1966. The first VLBI observation was made in 1969. The radioastronomical station Simeiz was included in international VLBI networks in 1980.

The parameters of the 22-meter radio telescope are presented in Table 1.

Radio Astronomy Lab of Crimean Astrophysical Observatory

Simeiz Network Station

IVS 2014 Annual Report

2 Activities during the Past Year and Current Status

During 2014, the Space Geodesy and Geodynamics stations regularly participated in the International Network programs — IVS, the International GPS Service (IGS), and the International Laser Ranging Service (ILRS).

During the period 2014 January 1 through 2014 December 31, the Simeiz VLBI station participated in ten 24-hour geodetic sessions. Simeiz regularly participated in the EUROPE and T2 series of geodetic sessions.

2.1 Solar Energy in the Crimea on the SSE Observations.

NASA’s Earth science research program has supported satellite systems and research providing data important to the study of climate and climate processes. These data include long-term estimates of meteorological quantities and surface solar energy fluxes [1].

These satellite and model-based products have been shown to be accurate enough to provide reliable solar and meteorological resource data over regions where surface measurements are sparse or nonexistent, and they offer two unique features — the data is global and, in general, contiguous in time.

Crimea is located near the Euroasian tectonic zone of high seismic activity. This results in special local climatic and geophysical conditions [2, 3]. Base ground measurements needed to learn the features of local cli-



Fig. 1 The Simeiz VLBI station.

Table 1 The antenna parameters of the Simeiz station.

Diameter D, m	22
Surface tolerance, mm (root mean square)	0.25
Wavelength limit, mm	2
Feed System	Cassegrain system or primary focus
Focal length F, m	9.525
Focal ratio F/D	0.43
Effective focal length for Cassegrain system, m	134.5
Mounting	Azimuth-Elevation
Pointing accuracy, arc sec.	10
Maximum rotation rate, degree/sec	1.5
Maximum tracking rate, arcsec/sec	150
Working range in Azimuth, degrees (0 to South)	-270 ± 270
in Elevation, degrees	0 - 85

matic and geophysical parameters are insufficient. We use SSE-parameters for analysis of the distribution of the energy (solar radiation) incident on the surface of the Earth in Crimea in 2014. A summary of the estimated uncertainty associated with the basic solar and meteorological data (i.e. solar radiation, temperature, surface pressure, relative humidity, and wind speed) underlying the parameters available through SSE 6.0 is given in [1]. The uncertainty estimates were derived through comparisons with ground measurements. Quality ground-measured data are generally considered more accurate than satellite-derived values. But measurement uncertainties from calibration drift, operational uncertainties, or data gaps are often unknown or unreported for many ground site data sets [4].

The average insolation ($kWh/m^2/day$) is the amount of electromagnetic energy (solar radiation)

incident on the surface of the Earth. The fraction of insolation at the top of the atmosphere which reaches the surface of the Earth depends on the local conditions.

The insolation clearness index (dimensionless) is a quantitative characteristic — the fraction of insolation of electromagnetic energy (solar radiation) at the top of the atmosphere that is incident at the surface of the Earth. The parameters of SSE for Sizing and Pointing of Solar Panels and for Solar Thermal Applications contain information about the insolation clearness index for any region of the Earth's surface. The distribution of the insolation clearness index over the surface of the Earth in Crimea is shown in Figure 2.

The graph in Figure 2 shows that the fraction of insolation at the top of the atmosphere which reaches the

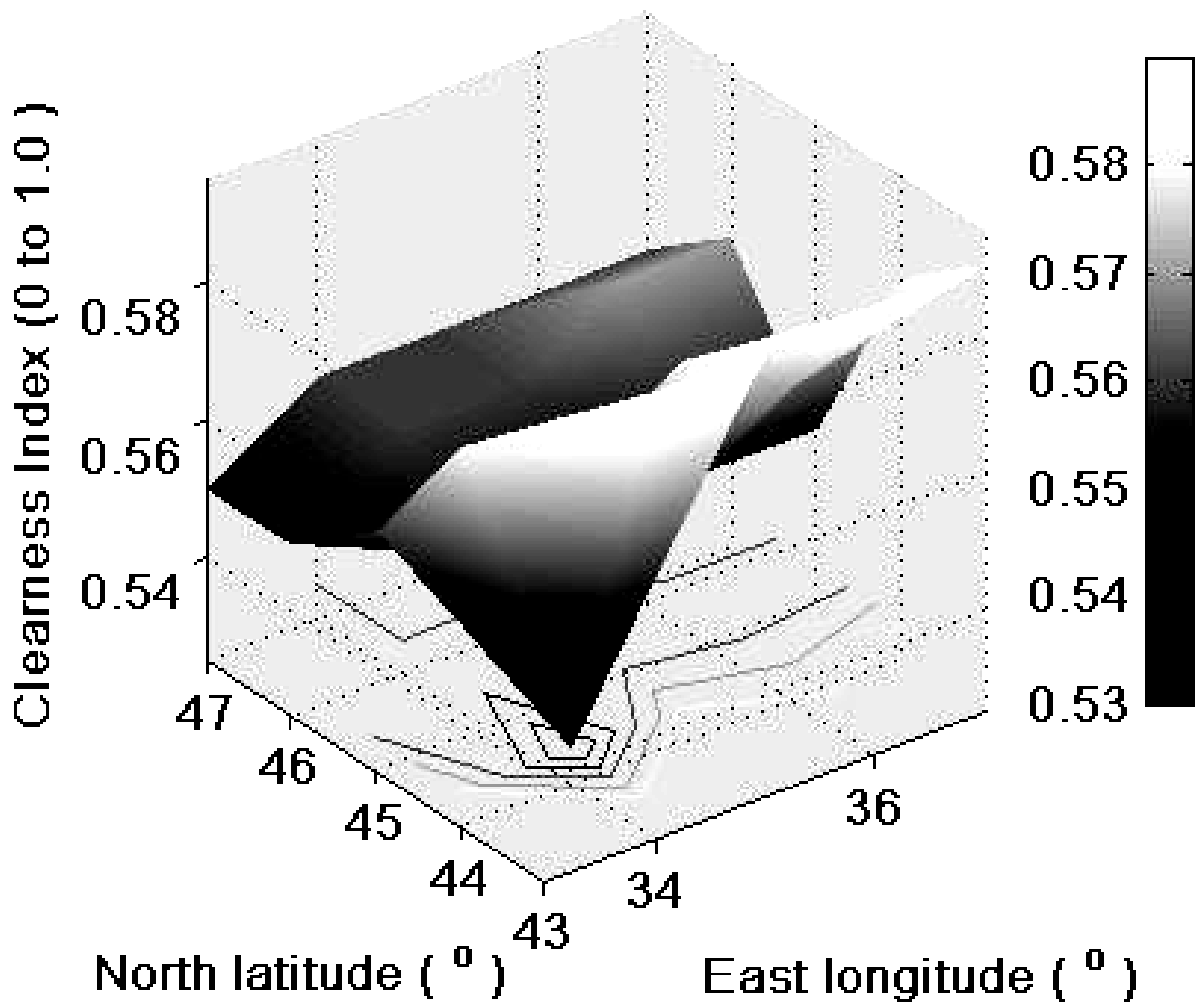

Fig. 2 The 2014 Annual Monthly Averaged Insolation Clearness Index (0 to 1.0) in Crimea.

surface of the Earth in Crimea increases in the south-east.

The incoming solar radiation raises the temperature of the Earth's surface. Analysis of variations of the Earth's surface temperature is useful for the study of local meteorological, geographical, and geophysical conditions.

Figure 3 is a graph of the 2014 Annual Monthly Averaged Earth Skin Temperature ($^{\circ}\text{C}$) in Crimea. The Maximum Monthly Averaged Earth Skin Temperature is shown in Figure 3.

3 Future Plans

Our plans for the coming year are the following: to put into operation the VLBI Data Acquisition System DBBC, to upgrade the laser of SLR Simeiz-1873 station, and to set up a new GPS station near the Simeiz VLBI station.

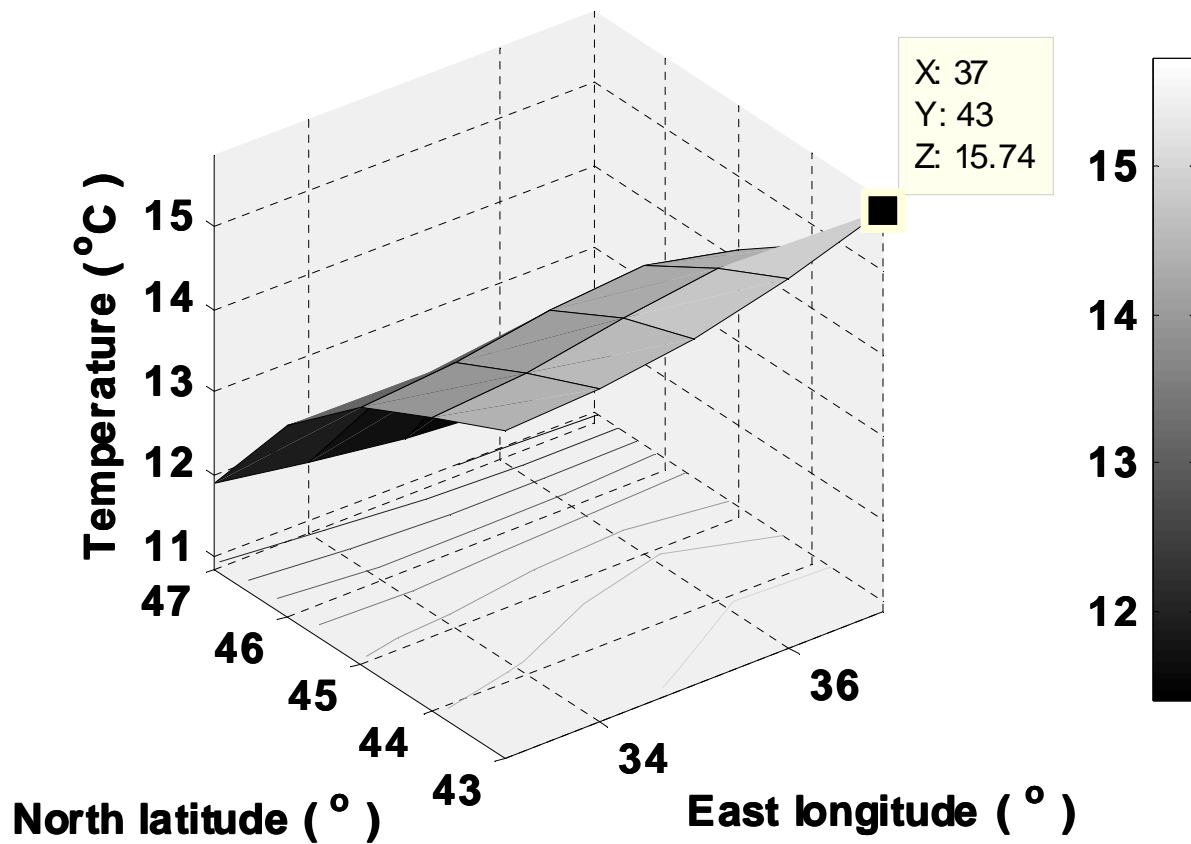

Fig. 3 The 2014 Annual Monthly Averaged Earth Skin Temperature ($^{\circ}$ C) in Crimea.

References

1. NASA Surface meteorology and Solar Energy. URL: <https://eosweb.larc.nasa.gov/>
2. Kurbasova G.S., Volvach A.E. *Space Science and Technology*, 20, pp.42-49, 2014.
3. Kurbasova G.S., Volvach A.E. CriMiCo2014 - 2014 24rd International Crimean Conference Microwave and Telecommunication Technology, *Conference Proceedings* Weber Publishing, 2014. Vol.2. P.1085-1086.
4. Volvach A.E., Kurbasova G.S. *International VLBI Service for Geodesy and Astrometry*, edited by K. D. Baver, D. Behrend, and K. L. Armstrong, NASA/TP-2014-217522, 2014. p.160-163.

Svetloe Radio Astronomical Observatory 2014 IVS Annual Report

Sergey Smolentsev, Ismail Rahimov, Dmitry Ivanov

Abstract This report provides information about the Svetloe Radio Astronomical Observatory during 2014. The report also provides an overview of current geodetic VLBI activities and gives an outlook for the next year.

1 General Information

Svetloe Radio Astronomical Observatory (Figure 1) was founded by the Institute of Applied Astronomy (IAA) as the first station of the Russian VLBI network QUASAR. The sponsoring organization of the project is the Russian Academy of Sciences (RAS). Svetloe Radio Astronomical Observatory is located near Svet-



Fig. 1 Svetloe observatory.

Institute of Applied Astronomy of RAS

Network Station Svetloe

IVS 2014 Annual Report

loe village in the Priozersky district of the Leningrad region <http://www.ipa.nw.ru/PAGE/rusipa.htm>. The basic instrument of the observatory is a 32-m radio telescope equipped with special technical systems for VLBI observations co-located with GPS/GLONASS/Galileo receivers and an SLR system. A Water Vapor Radiometer (WVR) has operated since 2013.

2 Technical Staff

Table 1 Staff related to VLBI operations at Svetloe.

Prof. Ismail Rahimov	observatory chief
Vladimir Tarasov	chief engineer
Tatiana Andreeva	engineer
Alexander Isaenko	engineer
Andrey Mikhailov	FS, pointing system control

3 Component Description

3.1 Technical and Scientific Information

The main instrument at Svetloe observatory is a 32-m radio telescope (RT-32), equipped with L , C , S/X , and K cryogenic receivers with circular polarization, a Mark 5B+ recorder, and a DAS P1002M. Main technical characteristics of the radio telescope are presented in Table 2. Observations can be carried out both in radiometric mode and in radio interferometric mode.

All IAA observatories are equipped with the identical time standards and meteorological stations which are used when carrying out all types of observations. Automatic digital Weather Transmitter “Vaisala” is used to obtain meteorological data in real time. A Water Vapor Radiometer designed at the Institute of Applied Astronomy is currently working at the Svetloe observatory on a regular basis.

Table 2 Technical parameters of the radio telescope.

Year of construction	2000
Mount	AZEL
Azimuth range	$\pm 270^\circ$ (from south)
Elevation range	from -5° to 95°
Maximum azimuth	
- velocity	$0.83^\circ/\text{s}$
- tracking velocity	$2.5'/\text{s}$
- acceleration	$12.0''/\text{s}^2$
Maximum elevation	
- velocity	$0.5^\circ/\text{s}$
- tracking velocity	$0.8'/\text{s}$
- acceleration	$12.0''/\text{s}^2$
Pointing accuracy	better than $10''$
Configuration	Cassegrain (with asymmetrical subreflector)
Main reflector diameter	32 m
Subreflector diameter	4 m
Focal length	11.4 m
Main reflector shape	quasi-paraboloid
Subreflector shape	quasi-hyperboloid
Main reflector surface accuracy	± 0.5 mm
Frequency range	1.4–22 GHz
Axis offset	3.7 ± 2.0 mm

3.2 Co-location of VLBI, GPS/GLONASS, and SLR System

The Topcon GPS/GLONASS/Galileo receiver with meteo station WXT-510 is in operation (Figure 2).

The SLR system “Sazhen-TM” (Figure 3) at Svetloe observatory observed 3,089 passes of LAGEOS, GLONASS, and other satellites and obtained 3,959 normal points during 2014.



Fig. 2 Topcon GPS/GLONASS/Galileo receiver at the Svetloe observatory.



Fig. 3 “Sazhen-TM” SLR system at Svetloe observatory.



Fig. 4 WVR and RT-32 at Svetloe observatory.

4 Current Status and Activities during 2014

Svetloe actively participates in both international (IVS and EVN) and domestic (Ru) observation programs. During 2014, Svetloe station participated in 29 24-hour IVS sessions — 24 IVS-R4 sessions, three IVS-T2 sessions, and two EUROPE sessions – and in 21 IVS-Intensive sessions.

Svetloe participated in 48 24-hour sessions in the framework of the domestic Ru-E program for determination of all Earth orientation parameters and in 13 one-hour Ru-U sessions for obtaining Universal Time using e-VLBI data transfer.

During 2014 a WVR was installed and successfully worked (Figure 5).



Fig. 5 WVR at Svetloe observatory.

5 Future Plans

Our plans for the coming year are the following:

- To participate in IVS sessions,
- To carry out domestic observational programs for obtaining Universal Time daily and for obtaining Earth orientation parameters weekly with e-VLBI data transfer,
- To carry out SLR observations of geodetic and navigation satellites,
- To participate in EVN and RADIOASTRON observational sessions,
- To continue geodetic monitoring of the RT-32 parameters,
- To continue WVR observations on a regular basis.

JARE Syowa Station 11-m Antenna, Antarctica

Yuichi Aoyama, Koichiro Doi

Abstract In 2014, the 54th and the 55th Japanese Antarctic Research Expeditions (hereinafter, referred to as JARE-54 and JARE-55, respectively) participated in six OHIG sessions — OHIG88, 89, 90, 91, 92, and 93. These data were recorded on hard disks through the K5 terminal. The hard disks storing the OHIG83–87 sessions' data were brought back from Syowa Station to Japan in April 2014 by the icebreaker Shirase, while those storing the OHIG88–93 sessions data are scheduled to arrive in April 2015. The data obtained from the five sessions — OHIG83–87 — by JARE-54 were transferred to the Bonn Correlator via the servers of National Institute of Information and Communications Technology (NICT). At Syowa Station, JARE-56 will participate in six OHIG sessions and in one Asia-Oceania VLBI (AOV) session in 2015.

1 General Information

To investigate polar science, the National Institute of Polar Research (NIPR) is managing Japanese Antarctic Research Expeditions (JAREs). The 26 members of JARE-55 overwintered at Syowa Station, East Ongul Island, East Antarctica in 2014.

Syowa Station has become one of the key observation sites in the Southern Hemisphere's geodetic and geophysical networks (as shown in Figure 1, see [1] for details). As a part of these geodetic measurements, the JAREs have been operating the 11-m S/X-band an-

National Institute of Polar Research

JARE Syowa Station 11-m antenna

IVS 2014 Annual Report

tenna at Syowa Station (69.0°S, 39.6°E) for geodetic VLBI experiments since February 1998. A cumulative total of 114 quasi-regular geodetic VLBI experiments were performed by the end of 2014.

2 Component Description

For VLBI, the Syowa Station 11-m antenna is registered as IERS Domes Number 66006S004 and as CDP Number 7342. The basic configuration of the Syowa Station VLBI frontend system has not changed from the description in [2].

The Syowa Station's K4 recording terminal was fully replaced by K5 simultaneously with the termination of the SYW session at the end of 2004. Syowa Sta-

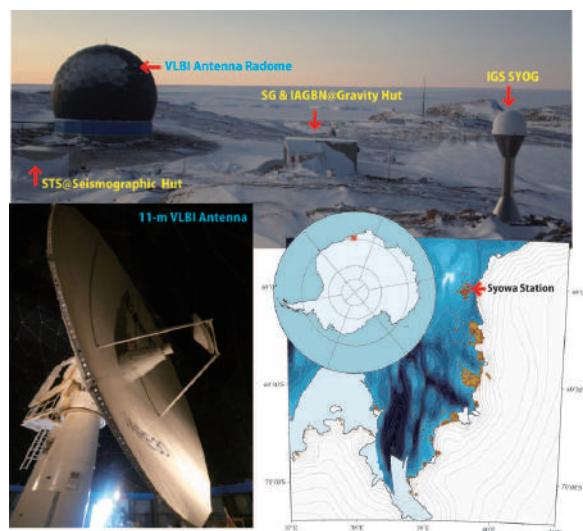

Fig. 1 Syowa VLBI antenna.

Table 1 Staff members. JARE-54: February 2013 – January 2014 JARE-55: February 2014 – January 2015.

Name	Affiliation	Function
Koichiro DOI	NIPR	Project coordinator
Yuichi AOYAMA	NIPR	Liaison officer
Noriaki OBARA	NIPR	Chief operator of JARE-54
Hiroshi TANAKA	NEC	Antenna engineer for JARE-54
Takuya MASUNAGA	NIPR	Chief operator of JARE-55
Yasufumi YOSHIKAWA	NIPR	Operator of JARE-55
Hirofumi MIZUTA	NEC	Antenna engineer for JARE-55

tion has participated in the OHIG sessions in the austral summer season since 1999. Data transfer through an Intelsat satellite link from Syowa Station to NIPR has been available since 2004. But its recent bandwidth is about 3 Mbps and its effective speed of FTP transfer is 100–250 kB/sec, which is too slow to practically transfer the huge VLBI data.

3 Staff of the JARE Syowa Station 11-m Antenna

The Syowa Station 11-m antenna is operated and maintained by JARE and NIPR. The staff members are listed in Table 1. OHIG sessions in 2014 were performed primarily by the staff of JARE-55 as shown in Figure 2. The first session of 2014, OHIG88, was scheduled to be observed after the icebreaker Shirase left Syowa Station on February 8, and so the staff of JARE-54 could not use OHIG88 to instruct the staff of JARE-55 in the operation and maintenance of the 11-m antenna. Instead, the staff of JARE-54 used a simulation of a VLBI experiment to instruct the staff of JARE-55 by the end of January 2014.

4 Current Status and Activities

4.1 Notes on System Maintenance

There had been two hydrogen masers, Anritsu RH401A HM-1001C and HM-1002C, at Syowa Station until HM-1002C was brought back to Japan in January 2011 for an overhaul. Because the icebreaker Shirase could not approach Syowa Station in the 2011/2012 and 2012/2013 austral summer seasons



Fig. 2 Syowa Station VLBI staff of JARE-55, Y. Yoshikara (left), T. Masunaga (center) and H. Mizuta (right).

due to dense and thick sea ice, we could not return HM-1002C to Syowa Station. During this period, the unfavorable situation in which there was only one hydrogen maser at Syowa Station lasted.

In addition, the ion pump of this hydrogen maser, HM-1001C, began to abnormally stop on occasion after instability of the generator for power supplies occurred on March 11, 2011. Such trouble became sometimes an obstacle to VLBI observation. For example, the ion pump of HM-1001C stopped suddenly at 00:00 UTC, November 21, 2013 just before the 36th scan of the OHIG87 session. This abnormal stop caused about two hours of unavailable data for the OHIG87 session.

To avoid such critical situations, we purchased a new hydrogen maser, SD1T03B, in 2013. SD1T03B was miniaturized in order to load it into a helicopter. Therefore we succeeded in transporting it to Syowa Station on December 16, 2013. SD1T03B was connected to the UPS for HM-1002C, and its startup was accomplished on December 20, 2013. Since SD1T03B has been used as the primary hydrogen maser from the OHIG88 session, there was no clock trouble in 2014. In

Table 2 Status of the OHIG sessions as of December 2014.

Code	Date	Station	Hour	Correlation	Solution	Notes
OHIG82	2013/Feb/11	Sy, Hh, Kk, Oh, Tc	24 h	Yes	Yes	J54
OHIG83	2013/Feb/13	Sy, Hh, Kk, Oh, Tc	24 h	Yes	Yes	
OHIG84	2013/Feb/20	Sy, Ft, Kk, Oh, Tc	24 h	Yes	Yes	
OHIG85	2013/Nov/11	Sy, Ft, Hb, Ke, Kk, Tc, Ww, Yg	24 h	Yes	Yes	
OHIG86	2013/Nov/13	Sy, Ft, Hb, Ke, Kk, Tc, Ww, Yg	24 h	Yes	Yes	
OHIG87	2013/Nov/20	Sy, Ft, Hb, Hh, Ke, Kk, Tc, Ww, Yg	24 h	Yes	Yes	†1, †2
OHIG88	2014/Feb/19	Sy, Ft, Ht, Ke, Kk, Tc, Ww, Yg -Hb, Oh	24 h	-	-	J55
OHIG89	2014/Feb/25	Sy, Ft, Hb, Ht, Ke, Kk, Tc, Ww, Yg -Oh	24 h	-	-	
OHIG90	2014/Feb/26	Sy, Ft, Hb, Ht, Ke, Kk, Tc, Ww, Yg -Oh	24 h	-	-	
OHIG91	2014/Nov/12	Sy, Ft, Hb, Hh, Ke, Kk, Ww, Yg -Oh	24 h	-	-	
OHIG92	2014/Nov/18	Sy, Ft, Hb, Ht, Ke, Kk, Ww, Yg -Oh	24 h	-	-	
OHIG93	2014/Nov/19	Sy, Ft, Hb, Hh, Ke, Kk, Ww, Yg -Oh	24 h	-	-	

J54: JARE-54, op. N. Obara, eng. H. Tanaka J55: JARE-55, op. T. Masunaga and Y. Yoshikawa, eng. H. Mizuta

†1 : No fringes occurred during 0000–0055UT because the ion pump of HM-1001C stopped.

†2 : T. Masunaga joined the JARE-54 team.

January 2015, HM-1001C, which was operated as the secondary hydrogen maser in 2014, was replaced with HM-1002C and brought back to Japan for an overhaul.

During the OHIG88 session, failures occurred in the tracking system of the Syowa Station 11-m antenna. Consequently the 50th – 61st scans were missed.

4.2 Session Status

Table 2 summarizes the status of processing as of December 2014 for the sessions starting in 2013. The OHIG sessions involved Fortaleza (Ft), O'Higgins (Oh), Kokee Park (Kk), TIGO Concepción (Tc), Hobart 12-m antenna (Hb), HartRAO 26-m antenna (Hh), HartRAO 15-m antenna (Ht), Warkworth (Ww), Katherine (Ke), Yarragadee (Yg), and Syowa Station (Sy). In 2005, Syowa Station joined the CRD sessions, but after 2006, Syowa Station participated only in OHIG sessions. Syowa Station took part in six OHIG sessions in 2014.

K5 hard disks storing the OHIG 83–87 sessions' data were sent from Syowa Station to Shirase in early February, 2014. Shirase ran aground at 700 meters from the shore at the Molodezhnaya base in the return journey on February 16. Although Shirase was able to leave the sunken rock after a few days, it bilged and was flooded. But Shirase was able to return to Japan somehow, and we obtained the K5 hard disks in April, 2014.

The OHIG83–87 sessions' data were transferred to NICT servers immediately and converted to the Mark 5 format data there. The converted data were transferred from the NICT servers to the Bonn Correlator by FTP by the end of April. The OHIG 83–86 sessions' data have been correlated without any problem. In the OHIG87 session data, there appears to be a clock jump of about 22 μ s due to the abnormal stop of the HM-1001C ion pump.

4.3 Analysis Results

As of December 2014, Syowa Station had contributed 114 sessions from May 1999. According to the results analyzed by the BKG IVS Analysis Center, the accuracy of the position and the velocity of the Syowa Station 11-m antenna are 1 mm and 0.2 mm/yr, respectively. In addition, the length of the Syowa Station–Hobart 12-m antenna baseline is increasing with a rate of 66.8 ± 7.0 mm/yr. The Syowa Station–HartRAO baseline shows a slight increase in its length with a rate of 12.2 ± 0.8 mm/yr. The Syowa Station–O'Higgins baseline also shows a slight increase, although its rate is only 1.2 ± 0.8 mm/yr.

Detailed results from the data until the end of 2003 as well as comparisons with those from other space geodetic techniques were reported in [3].

5 Future Plans

Dismantling of the current Syowa Station antenna was scheduled for the 2015/2016 austral summer season. For this schedule, we presented a budget proposal for replacing the current antenna with either a VGOS antenna or a small geodetic VLBI antenna. In parallel, the project to develop the small geodetic VLBI antenna and its cryogenic system for feed and LNA was advanced in collaboration with Tsukuba University, NICT and Geospatial Information Authority of Japan. The project team concluded that the small antenna without the broadband receiving system could hardly realize precise VLBI observations, even if the cryogenic system would be installed. Although there was possibility that the budget for the small antenna might be approved in 2015, we gave up installing the small antenna.

Instead, we tried to prolong the available period of the current VLBI antenna. As a consequence, the importance of VLBI international observing was accepted within NIPR, and NIPR decided to postpone the dismantling schedule until the 2019/2020 austral summer season. We continue to present the budget proposal for construction of the VGOS antenna after 2021 and to make every effort until this proposal is approved.

Acknowledgements

This work is a part of the Science Program of JARE supported by NIPR under the Ministry of Education, Culture, Sports, Science, and Technology. Part of this work was also supported by the NIPR through General Collaboration Projects no. 25—20.

References

1. Shibuya, K., Doi, K., and Aoki, S. (2003): Ten years' progress of Syowa Station, Antarctica, as a global geodesy network site. *Polar Geoscience*, 16, 29-52.
2. Shibuya, K., Doi, K., and Aoki, S. (2003): JARE Syowa Station 11-m Antenna, Antarctica, in *International VLBI Service for Geodesy and Astrometry 2002 Annual Report*, 149-152, NASA/TP-2003-211619, ed. by N. R. Vandenberg and K. D. Baver.
3. Fukuzaki, Y., Shibuya, K., Doi, K., Ozawa, T., Nothnagel, A., Jike, T., Iwano, S., Jauncey, D. L., Nicolson, G. D., and McCulloch, P. M. (2005): Results of the VLBI experiments conducted with Syowa Station, Antarctica. *J. Geod.*, 79, 379-388.

Last Year of Operation of the TIGO VLBI Station in Concepción

Hayo Hase ¹, Cristian Herrera ², Felipe Pedreros ², Luis Feres ², Sabina Rayo ², Pablo Figueroa ²

Abstract After more than 12 years of continuous operation, the TIGO VLBI station at Concepción, Chile came to an end due to the termination of the scientific-technical cooperation in the TIGO-project between Germany and Chile. 36 scheduled VLBI sessions were successfully recorded during the first semester. In parallel the preparation of the disassembling of the observatory for its transportation to La Plata in Argentina determined the main activities. During the second semester the entire observatory was packed to be moved. Besides that, the reflector was surveyed, future Argentinean colleagues were trained in TIGO by the Chilean staff, an inventory software for an observatory was developed, and a study on VGOS/GGOS network expansion was published.

1 General Information

The TIGO-project is based on a bilateral agreement between the Federal Republic of Germany and the Republic of Chile. Since 2002, TIGO has been located in the terrain of the Universidad de Concepción (long. 73.025 degrees West, lat. 36.843 degrees South), in Concepción Chile, and has served the IVS, ILRS, IGS, IGFS, BIPM, and IERS with observational data. Between the main project partners BKG and Universidad de Concepción the cooperation was officially closed by the end of 2014. The reason to do so was the lack of interest to support a non-profit geodetic observatory by

1. Bundesamt für Kartographie und Geodäsie (BKG)
2. Universidad de Concepción (UdeC)

TIGOCONC Network Station

IVS 2014 Annual Report

the Chilean government after the earthquake on February 27, 2010. The German government looked for other partners and made an agreement with the Argentinean National Research Council (CONICET) about the creation of an Argentinean-German Geodetic Observatory (AGGO) in 2012. 2014, the last year of the TIGO-project, was full of activities to prepare the instruments for the transport to the new AGGO site near La Plata, Argentina. The acronym TIGO will stay in Chile, while the new station will be called AGGO.

For more than ten years, TIGOCONC was among the three most productive IVS-sites (Figure 1).

TIGOCONC Projected Baselines 2002–2014

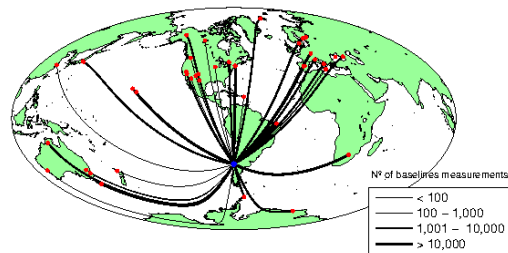

Fig. 1 TIGOCONC as the ‘center’ of the VLBI world. The baselines measured with Concepción are projected to the Earth’s surface. The line width indicates the number of repetitions of baseline determinations during 2002–2014, demonstrating a solid Southern hemisphere reference point which is very well connected to six continents by its continuous measurements.

TIGOCONC has been the VLBI reference point in South America with most observations during 2003–2013. It participated in total in 1,269 IVS sessions with a total of 247,723 successful quasar observations. In

Table 1 TIGO VLBI support staff in 2014.

Staff	Function	Email	Remark
Hayo Hase	Head	hayo.hase@tigo.cl	
Cristian Herrera	Informatic Engineer	cristian.herrera@tigo.cl	
Felipe Pedreros	Telecommunications Engineer	felipe.pedreros@tigo.cl	
Sabina Rayo	student of mechanical engineering	sabina.rayo@tigo.cl	until May 2014
Pablo Figueroa	student of telecommunications	pablo.figueroa@tigo.cl	until May 2014
Luis Feres	student of aerospace engineering	luis.fuentes@tigo.cl	until May 2014
all VLBI operators		vlbistaff@tigo.cl	

addition, a few astronomical sessions were conducted for the TANAMI project.

2 Component Description

The IVS network station TIGOCONC constitutes the VLBI-part of the Geodetic Observatory TIGO, which was designed to be a fundamental station for geodesy. Hence, the VLBI radio telescope is co-located to an SLR telescope (ILRS site), a GPS/Glonass permanent receiver (IGS site), and other instruments such as a seismometer and a superconducting and an absolute gravity meter.

The atomic clock ensemble of TIGO consists of two hydrogen masers, three cesium clocks, and four GPS time receivers realizing the Chilean contribution to the Universal Time scale (Circular T, BIPM).

The technical parameters of the TIGO radio telescope as published in [1] have not been changed.

3 Staff

The 2014 VLBI staff consisted of six persons, as listed in Table 1. The team (Figure 2) was complemented by students Luis Feres, Pablo Figueroa, and Dr. Sabina Rayo performing night shifts until the closure of operations by the end of May 2014.



Fig. 2 The TIGO VLBI staff on top of the geodetic platform, and the 6-meter telescope ready for shipment in the background. The remaining geodetic reference marker is still visible at the bottom edge (student operators absent).

4 Current Status and Activities

4.1 IVS Operation

During 2014 TIGO was scheduled to participate in 36 regular IVS experiments. Table 2 gives an overview about the participation of TIGOCONC in 2014. Out of 36 requested observation days, 33 could be observed successfully, reaching an efficiency of 91.6%. The main reason for data loss have been related to technical problems in the refrigerating system of the receiver, recording problems on bad data carriers, and unexpected delays in the customs liberation procedure of data carriers. According to previous schedules of moving TIGO to Argentina, the CONT14 scheduling was made without TIGO. Due to delays in the execution of the move, the possibility of including TIGO again in



Fig. 3 (Left) The VLBI telescope primary mirror covered with reflecting targets for photogrammetry measurements. (Right) Pictures taken at different angles with the telescope pointing at 110 degrees of elevation. Credits: Rolando Dünner/AIUC.

CONT14 was not considered, as the preparations were at an advanced stage.

Table 2 TIGO's IVS observation statistics for 2014. The operation was closed on May 31, 2014.

Name	R1xxx	R4xxx	OHIGxx	Total IVS
# of Exp.	16	17	3	36
Correlated	13	17	3	33
No result	3	0	0	3

4.2 Reflector Surface Survey

A photogrammetry measurements campaign was performed on January 25 and 26, 2014, in order to measure the primary mirror surface accuracy. This work was requested to the Centro de Astro-Ingeniería of the Pontificia Universidad Católica de Chile (AIUC) [2].

The surface of the primary mirror was covered with 112 reflecting targets, and measurements were done by using a VSTARS camera and software from Geodetic Systems Inc.. Measurements were performed with the telescope pointing at 2 degrees, 38 degrees, and 110 degrees of elevation to estimate gravity deformations on the reflector's surface. Subsequent analysis of the pictures taken at different locations and angles around the telescope allowed estimation of the mirror surface RMS error of 0.25 [mm] at an elevation of 2 degrees,

0.26 [mm] at 38 degrees, and 0.28 [mm] at 110 degrees. Results showed a surface RMS error 70 μm greater than the design goal of 200 μm , meaning a 35% degradation for the last 12 years of operation. However, this implies a loss of antenna gain less than 1% at 10 GHz. Figure 3 shows the telescope primary mirror with the reflecting targets attached to its surface, as well as the photogrammetry measurements being performed.

4.3 Training of AGGO Staff

Federico Salguero, José Vera, and Augusto Cassino from CONICET, Argentina, visited TIGO in order to gain a first introduction into the operation of VLBI and later of the disassembling of the radio telescope.

4.4 Telescope Decommissioning

After 12 years of continuous operations and the preparations for the upcoming move to the new site in La Plata (Argentina), an overhaul of the telescope was required. This major task was assigned to the company MT-Mecatrónica, who performed tests, parts replacement, lubrication, repainting, and the disassembly of the telescope. Once in La Plata, MT-Mecatrónica will be responsible for the re-commissioning of the telescope.

In addition, the cryogenic dewar was shipped to the laboratories at the Wettzell Observatory for major maintenance due to previous leakage problems.



Fig. 4 The staff of the TIGO, Wettzell, and AGGO observatories and the contracted MT-Mecatrónica company preparing the transport to Argentina in front of the disassembled radio telescope, before storing it in its 40 ft. shipping container.

4.5 Observatory Inventory System

For the purpose of crossing the border between Chile and Argentina, an inventory list of the Observatory had to be made. Cristian Herrera developed a tailor made software solution for the data acquisition by tablets, storage in a database and creation of reports with filters. In order to not confuse already inventoried parts, a barcode label was introduced for any registered part. Each part of the observatory is registered in a database with the following fields: name, part no., serial no., provenience, value, currency, manufacture date, place, responsibility, auxiliary information, and photo. The text information is barcoded and the photo, making the identification easy, is also part of the database. It is not made for VLBI only but for any part used in an observatory.

This system contains all the information for custom purposes and can be used later on as the inventory system for AGGO.

Finally, the more than 2,000 items of TIGO were registered with this system during February and December 2014.

4.6 Study of the VGOS/GGOS Network

Felipe Pedreros and Hayo Hase finished a study of densifying the global VGOS network with additional new radio telescope sites to create a homogeneous site distribution of VGOS sites. As backbone for GGOS the obtained configuration was extended with co-located SLR sites in order to obtain an optimal GGOS network site distribution under the constraints of continental surface. This study was published in the Journal of Geodesy [3].

5 Future Plans

The VLBI activities in 2015 will be focused on:

- Transporting TIGO to La Plata in Argentina.
- Setting up the new site in La Plata, Argentina.
- Educating new operators in VLBI operations.
- Resuming the execution of the 2015 IVS observation program.

References

1. Vandenberg, N. R. (editor): International VLBI Service for Geodesy and Astrometry 1999 Annual Report, NASA/TP-1999-209243, 1999.
2. R. Dünner, *Photogrammetry Measurements of TIGO*, Internal Report, Centro de Astro-Ingeniería UC, Santiago, April 2014.
3. H. Hase, F. Pedreros, *The most remote point method for the site selection of the future GGOS network*, J Geod (2014) 88:989–1006, DOI 10.1007/s00190-014-0731-y.

Tsukuba 32-m VLBI Station

Takahiro Wakasugi¹, Ryoji Kawabata¹, Shinobu Kurihara¹, Yoshihiro Fukuzaki¹, Jiro Kuroda¹, Kojin Wada¹, Syota Mizuno^{1,2}, Takafumi Ishida^{1,2}

Abstract The Tsukuba 32-m VLBI station is operated by the Geospatial Information Authority of Japan. This report summarizes activities of the Tsukuba 32-m VLBI station and other stations operated by GSI in 2014. 75 24-hour sessions including CONT14 and 148 Intensive sessions were observed using Tsukuba 32-m and other GSI antennas in accordance with the IVS Master Schedule of 2014. We have been constructing a new observing facility that will be fully compliant with the VGOS concept for the first time in Japan. The construction of the antenna was completed in March, and the inauguration of the new Ishioka VGOS antenna was held in October.



Fig. 1 The Tsukuba 32-m VLBI station.

1. Geospatial Information Authority of Japan
2. Advanced Engineering Service Co., Ltd.

Tsukuba Network Station

IVS 2014 Annual Report

1 General Information

The Tsukuba 32-m VLBI station (Figure 1) is located at the Geospatial Information Authority of Japan (hereafter GSI) in Tsukuba science city, which is about 50 km to the northeast of Tokyo. GSI has two regional stations besides Tsukuba: Chichijima and Aira, which form a geodetic VLBI network in Japan (Figure 2).

GSI has observed the domestic VLBI session series called JADE (Japanese Dynamic Earth observation by VLBI) since 1996. The main purposes of the JADE series are to maintain the reference frame of Japan and to monitor plate motions for the advanced study of crustal deformations around Japan. Additionally, most JADE



Fig. 2 Geodetic VLBI network in Japan.

sessions include Mizusawa and Ishigakijima, which are part of the VERA network of the National Astronomical Observatory of Japan (NAOJ), the two antennas in Kashima (11-m and 34-m), and the Koganei 11-m station, which belong to the National Institute of Information and Communications Technology (NICT).

2 Component Description

The specifications of the Tsukuba 32-m antenna are summarized in Table 1.

Table 1 Tsukuba 32-m antenna specifications.

Owner and operating agency	Geospatial Information Authority of Japan
Year of construction	1998
Radio telescope mount type	Az-El
Antenna optics	Cassegrain
Diameter of main reflector	32 m
Azimuth range	10 – 710°
Elevation range	5 – 88°
Az/El drive velocity	3°/sec
Tsys at zenith (X/S)	50 K / 65 K
SEFD (X/S)	320 Jy / 360 Jy
RF range (X1)	7780 – 8280 MHz
RF range (X2)	8180 – 8680 MHz
RF range (X3)	8580 – 8980 MHz
RF range (S with BPF)	2215 – 2369 MHz
Recording terminal	K5/VSSP32 ADS3000+ with DDC

3 Staff

Table 2 lists the regular members belonging to the GSI VLBI observation group. Kojin Wada replaced Tadashi Tanabe from April as the supervisor. There is no major change in other aspects. Routine operations were primarily performed under contract with Advanced Engineering Service Co., Ltd. (AES).

Table 2 Member list of the GSI VLBI group.

Name	Main Function
Kojin WADA	Supervisor
Jiro KURODA	Management, Co-location
Yoshihiro FUKUZAKI	Installation of VGOS
Shinobu KURIHARA	Correlation, Analysis, IVS Directing Board member
Ryoji KAWABATA	Operation, Co-location The secretary of AOV
Takahiro WAKASUGI	Operation
Syota MIZUNO	Operation (AES, Co., Ltd)
Takafumi ISHIDA	Operation (AES, Co., Ltd)
Toshio NAKAJIMA	System engineer (NTT-ATC)

4 Current Status

4.1 Geodetic VLBI Observations

The regular sessions in the IVS Master Schedule that were conducted by using the GSI's antennas are shown in Table 3. Tsukuba 32 m participated in 75 international and domestic 24-hour VLBI sessions, and in 148 Intensive one-hour sessions for dUT1 measurement in 2014. The other GSI antennas, Chichijima and Aira, participated in not only domestic but also some international sessions such as IVS-T2 and APSG.

We observed the CONT14 campaign, which lasted fifteen days from 6 to 20 May, by using Tsukuba 32 m. Although we faced a small problem concerning a data recording server, most scans were recorded successfully. During the campaign, Tsukuba also observed regular Intensive sessions four times. Switching between CONT and Intensive sessions was done fully automatically. The obtained data were transferred via the Internet to the Bonn correlator.

Table 3 The number of regular sessions observed by using the GSI's antennas in 2014.

Sessions	Tsukuba	Aira	Chichijima
IVS-R1	44	10	–
IVS-T2	7	7	7
APSG	2	2	2
IVS-R&D	1	–	–
CONT14	15	–	–
JADE	5	5	5
JAXA	1	1	1
IVS-INT2	101	–	–
IVS-INT3	47	–	–
Total	223	25	15

4.2 VGOS Project by GSI

In 2012, we started a new project for constructing a VGOS station in Japan. The construction of the antenna has been completed (Figure 3) and the necessary equipment (Front-end, Back-end, H-maser, and so on) has also been delivered. In order to achieve broadband receiving, Eleven feed and Quadruple Ridged Flared Horn (QRFH) systems have been purchased. In addition, a tri-band feed system developed by Spanish IGN (Yebes observatory) has also been purchased for compatibility with the legacy S/X band receiving. After installing the Eleven feed and tri-band feed systems on the antenna, the performance of the new antenna was measured. As a preliminary result, we obtained SEFD 1250 Jy and 1700 Jy for X-band and S-band, respectively.

We held the inauguration ceremony of the new antenna in October (Figure 4). The Ishioka VGOS station will start to observe in regular IVS sessions in the legacy S/X mode for two years as a first step in order to establish a strong tie relation with Tsukuba and other legacy antennas. The full VGOS mode of observation will start after this S/X mode session series. The technical development for broadband receiving will also be performed during this period.

4.3 Influence of the Repair on the Tsukuba 32-m Antenna

As reported in the previous IVS Annual Report [1], the Tsukuba 32-m antenna was forced to suspend all IVS sessions from May to November in 2013 due to damage to the antenna basement [2], and R1 sessions in the last quarter were observed by using AIRA instead of Tsukuba. In the first quarter in 2014, AIRA continued to participate in R1 sessions after Tsukuba rejoined them [3]. Tsukuba showed a satisfactory performance as before the repair. Furthermore, the result of the local tie survey conducted after the repair was very close to that before the repair. In conclusion, the repair finished well, and the Tsukuba 32 m is still in good condition. Additionally, we showed the usefulness of a high speed A/D sampler ADS3000+ with a K5/VSI data recording and transferring system for regular VLBI experiments

by the result of AIRA's performance in many R1 sessions.

5 Future Plans

The Asia-Oceania VLBI Group for Geodesy and Astrometry (AOV) was newly established in 2014 as a subgroup of IVS in cooperation with twelve organizations in the Asia and Oceania region. Ryoji Kawabata was appointed secretary and will engage himself in processing and managing the AOV project with the chair, Jim Lovell (University of Tasmania). GSI will also make a substantial contribution to developing new technologies, obtaining new scientific knowledge that will lead to the decrease of damage caused by natural disasters, and establishing a regional reference frame by using the Tsukuba and Ishioka antennas. On the other hand, we will terminate the operation of the other regional antennas, Aira and Chichijima, by March 2015, because it has been a long time since they



Fig. 3 The Ishioka 13.2-m antenna.



Fig. 4 Inauguration ceremony in October.

were constructed, and GNSS has become able to play the role that had been implemented by the domestic VLBI network. Consequently, the year 2015 will be a major milestone for us. We will concentrate on the new VGOS project and AOV sessions with Tsukuba and Ishioka instead of the domestic JADE sessions including Chichijima and Aira so far.

References

1. Wakasugi, T., R. Kawabata, S. Kurihara, Y. Fukuzaki, J. Kuroda, T. Tanabe, S. Mizuno, T. Ishida, Tsukuba 32-m VLBI Station, in International VLBI Service for Geodesy and Astrometry 2013 Annual Report, edited by K. D. Baver, D. Behrend, and K. L. Armstrong, NASA/TP-2014-217522, pages 173-176, 2014.
2. Wakasugi, T., Status report of the Tsukuba VLBI Station - damage of the antenna basement due to over loading -, TDC News, IVS NICT-TDC News, No.33, pp.8-10, 2013.
3. Wakasugi, T., R. Kawabata, Regular Geodetic VLBI Observation with a Wide-band Recording System, TDC News, IVS NICT-TDC News, No.34, pp.11-13, 2014.

Nanshan VLBI Station Report 2014

Ming Zhang

Abstract The Nanshan VLBI station was upgraded significantly during 2014. A lot of technical work still needs to be done in 2015, although it is already back online for IVS observations.

1 General Information



Fig. 1 The dismantling of the 25-m dish in April.

Built in 1997, the Nanshan 25-m telescope has reached its design life. It has been under reconstruction since 20 March 2014. The climate-restricted construction period on the mountain plateau of Tianshan is only about a half year, so the reconstruction comes in two stages. At stage I, all parts above the elevation wheel will be

Xinjiang Astronomical Observatory, Chinese Academy of Sciences

XAO-CAS Urumqi Network Station

IVS 2014 Annual Report



Fig. 2 The aura of the rebuilt 26-m dish in November.

rebuilt this year; at stage II, the lower parts will be refurbished, including adjustment of the azimuthal track next year. The alidade and all the receivers and terminals remain the same. We expect a significant improvement of the reflector's surface accuracy after the reconstruction, so in the feed cabin we have reserved a room for a future 7-mm receiver. The second focal room is designed to be fitted with fixed multi-band feeds and a movable sub-reflector. To fully utilize the height of the elevation bearing, as well as to compensate for the new big feed hole, we will increase the antenna diameter to 26 m. Stage I is planned to be finished before this October in order to serve the coming lunar exploration mission.

2 Activities during the Past Year

Because the major restoration work is being carried out this year, many VLBI observations are being hindered. We joined few EAVN and EVN observations be-

fore the dismantling of the old 25-m telescope. We also joined IVS observing soon after the restoration of the new 26-m telescope. But because many antenna parameters need to be re-measured, we haven't started VLBI observations for astrophysical purposes as EVN and EAVN have required. But we have managed to observe ten scheduled IVS sessions outside the reconstruction time range in 2014.

Table 1 The observed IVS sessions.

Session	Date	Remarks
R4618	JAN 02	Normal
R1621	JAN 21	Normal
T2095	FEB 18	Normal
RD1407	SEP 10	Normal
RD1409	OCT 07	Normal
RD1411	NOV 04	Normal
R1661	NOV 10	Normal
APSG35	DEC 08	Normal
R4665	DEC 11	Normal
R4668	DEC 30	Normal

3 Current Status

3.1 Antenna Restoration

The newly built 26-m dish has made its debut in IVS observing, but time is still needed to completely restore this antenna and to make known its capabilities to the astronomical community. Currently only S/X and L bands are restored at a workable level. The new station center needs to be calculated from recent IVS observations. The antenna parameters such as pointing, gain curve, and beam map also need to be re-measured.

3.2 Backend and Recording System

Bundled with antenna upgrading, an RDBE is planned to be purchased this year. A DBBC and Mark 5b+ and Mark 6 will be purchased later on. The restored system with the new antenna will have separate VLBI terminals for EVN besides the CVN one which allows more remote accessibility. The Streamstor SDK for Mark 5

will be upgraded to version 9.2, and the FS will be upgraded to version 9.11.4 before joining the next EVN session.

4 Future Plans

There is a program in progress to build a fully steerable 110-m radio telescope (QTT) in Qitai county which is about 200 km east to Urumqi. Being less heavily engaged with astrophysical observations, Nanshan 26-m antenna could be a specialized VLBI telescope in the future. But the 26-m telescope will be a preliminary experiment platform for new techniques such as ultra-wideband digital receivers, which will be incorporated in accordance with the new VGOS goals. There are also plans to build dedicated VGOS antennas nearby.

New Zealand VLBI Station, Warkworth

Stuart Weston, Tim Natusch, Lewis Woodburn, Ben Hart, Sergei Gulyaev

Abstract The Warkworth Radio Astronomical Observatory is operated by the Institute for Radio Astronomy and Space Research (IRASR), AUT University, Auckland, New Zealand. Here we review the characteristics of the VLBI station facilities and report on a number of activities and technical developments in 2014.

1 General Information

The Warkworth Radio Astronomical Observatory for which a panorama photo is shown in Figure 1 is located some 60 km north of the city of Auckland, near the township of Warkworth. Specifications of the Warkworth 12-m and 30-m antennas are provided in Table 1. The 12-m radio telescope is equipped with an S/X dual-band dual-circular polarization feed at the secondary focus and an L-band feed at the prime focus. Backend data digitizing is handled by a digital base band converter (DBBC) manufactured by the HAT-Lab, Catania, Italy. The 30-m radio telescope is currently equipped with an uncooled C-band dual-circular polarization receiver. The station frequency standard is a Symmetricom Active Hydrogen Maser MHM-2010 (75001-114). Mark 5B+ and Mark 5C data recorders are used for data storage and streaming of recorded data off site. The observatory network is directly connected to the national network provided by Research and Education Advanced Network New Zealand Ltd (REANNZ) via a 10 Gbps fiber link to the site [1].

Institute for Radio Astronomy and Space Research, AUT University

Warkworth Network Station

IVS 2014 Annual Report

2 Component Description

2.1 The 12-m Antenna: Progress and Issues

In the beginning of 2014, a problem with slippage of the elevation axis encoder occurred. Initially, this issue could be dealt with by regenerating a pointing model on a fortnightly basis, but eventually it progressed to the point where a new model was required on an almost daily basis. It was determined that, as been the case at several other Patriot/Cobham 12-m antennas, the problem was caused by rotational slippage of the elevation axis pin connected to the encoder in the housing. As supplied by the manufacturer, this pin was intended to be locked to the main structure of the dish by an interface fit and to convey rotational motion to the elevation encoder. A permanent solution that locks the pin to the structure of the dish through bolts drilled into the axis bearing pin appears to have been successful; we have not experienced any more drift, and the elevation encoder offset has since been stable.

A new DBBC was received in April 2014 and was used to replace the original one purchased for the 12 m. This allowed the original DBBC to be returned to Bonn for repair and upgrade. Following its return, it has been installed as the digitizer for the 30-m antenna. Since the installation of the new DBBC on the 12 m we have seen a significant improvement in our SEFD figures. Previously they were of the order of 6000 Jy; now they are regularly ~ 3800 Jy, comparable with the AuScope 12-m antennas.

Having upgraded the Streamstor SDK for CONT14 and being able to address more than 1,024 scans and



Fig. 1 Photo of the two radio antennas at Warkworth on a frosty winter's morning: on the left the 30 m and on the right the 12 m. In the background on the left hand side are the antennas belonging to Spark (formerly Telecom New Zealand). (Image courtesy of Stuart Weston)

Table 1 Specifications of the Warkworth 12-m and 30-m antennas.

	12-m	30-m
Antenna type	Dual-shaped Cassegrain	wheel-and-track, Cassegrain beam-waveguide
Manufacturer	Cobham/Patriot, USA	NEC, Japan
Main dish Diam.	12.1 m	30.48 m
Secondary refl. Diam.	1.8 m	2.715 m
Focal length	4.538 m	
Surface accuracy	0.35 mm	1.2 mm
Mount	alt-azimuth	alt-azimuth
Azimuth axis range	$90^\circ \pm 270^\circ$	-179° to $+354^\circ$
Elevation axis range	7.2° to 88°	6.0° to 90.1°
Azimuth axis max speed	$5^\circ/\text{s}$	$0.37^\circ/\text{s}$
Elevation axis max speed	$1^\circ/\text{s}$	$0.36^\circ/\text{s}$

greater than 16 TB, we are in the process of upgrading our station diskpacs to 32 TB.

2.2 The 30-m Antenna: Progress and Issues

By mid 2014, the conversion of the 30-m antenna had progressed to a stage where it was fully steerable and equipped with an uncooled 6 GHz receiver (donated by Jodrell Bank Observatory), and a First Light ceremony was held where a 6.7 GHz Methanol maser spectral line was received and displayed on a spectrum analyzer as shown in Figure 2. More details of the conversion can be found in [2].

With the return of the observatory's original DBBC, installation of the Mark 5B recorder and of a Symmetricon Universal Time and Frequency Distribution Sys-

tem to distribute signals from the observatory maser to the 30-m site, the antenna became capable of interferometry. The first VLBI fringe was detected on the baseline to the 26-m antenna at Hobart (Figure 3). We gratefully acknowledge the generous assistance of the University of Tasmania observatory in this accomplishment.

2.3 Warkworth Network

In April 2014, the network link between Warkworth and the New Zealand research network (REANNZ) was upgraded to 10 Gbps. The international circuits from New Zealand provided by REANNZ are now 42 Gbps bi-directional to LA and 40 Gbps along SX-Transport ScienceWave (which REANNZ shares with AARNet) that handles all the research and education

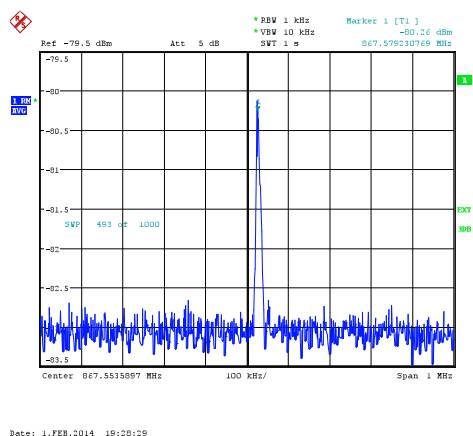

Fig. 2 First light methanol maser spectral line at 6.7 GHz. Credit: Tim Natusch

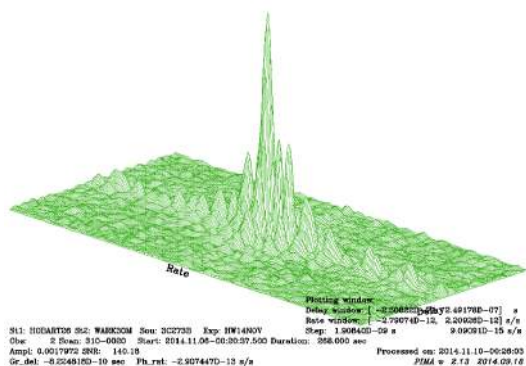

Fig. 3 The first VLBI fringe between Warkworth 30 m and Hobart 26 m at C-Band 6.7 GHz. Credit: Leonid Petrov

routes. In October 2014 we installed 10 Gbps fiber network interface cards in our e-transfer Mark 5. The bottle neck for us is now the receiving site. For example, we can sustain 800 Mbps to the new data store in Perth run by iVEC; speeds to Bonn and USNO are of the order of 100–200 Mbps.

3 Current Status and Activities

2014 has seen a significant increase in the number of IVS sessions in which the 12 m has participated, due in large part to the extra AUST sessions in which we are now able to participate. A break down of session types

(i.e. OHIG, CRDS, APSG, R, and AUST) observed in 2014 is presented in Table 2, showing our much higher utilization/participation in IVS this year versus 2013.

Table 2 The 12 m IVS 2014 Session Participation.

Experiment	Number of sessions	
	2013	2014
APSG	2	2
OHIG	3	6
R1	8	0
R4	8	11
CRDS	6	6
CONT	0	14
AUSTRAL	6	57
AUST	15	15

The first geodetic observing with the Warkworth 30 m in C-Band with the Ceduna 30 m and Hobart26 (University of Tasmania) was conducted in December 2014. The schedule and analysis was undertaken by Leonid Petrov (NASA Goddard Space Flight Center), providing a preliminary solution for the 30-m antenna presented in Table 3 (Petrov et al, 2015, in preparation).

Table 3 The 30 m preliminary solution components, Credit: Leonid Petrov.

Epoch	X, mm	Y, mm	Z, mm
2000.01.01-12:00:00	-5115425635.06	477880304.86	-3767042837.73
2014.12.11-12:59:43	-5115425608.47	477880352.69	-3767042708.48

This observing will be repeated in 2015, it is hoped with additional stations in Japan (Tsukuba and Kashima) and South Africa (Hartebeesthoek) able to participate.

Foundations have been laid for the future hosting of a gravimeter when in transit here in New Zealand from Antarctica. The site is just outside the 12 m antenna control facility so as to easily access utilities, and it is also close to one of the LINZ (Land Information New Zealand) GNSS stations hosted at the Warkworth Observatory. In March 2015, a site survey of the observatory will be undertaken with the assistance of LINZ. This will provide a useful check of the initial local tie survey of the 12-m antenna and GNSS station conducted at the end of 2012 [3] and also provide a tie to the 30-m radio telescope for the first time.

References

1. Weston, S., Natusch, T., Gulyaev, S., Radio Astronomy and e-VLBI using KAREN. In *Proceedings of the 17th Electronics New Zealand Conference*, 2010. Preprint arXiv:1011.0227.
2. Woodburn, L., Natusch, T., Weston, S., Thomasson, P., Godwin, M., Granet, C., Gulyaev, S., Conversion of a New Zealand 30 metre Telecommunications antenna into a Radio Telescope, Publications of the Astronomical Society of Australia, Accepted, 2015.
3. Gentle, P., Dawson, J., & Woods, A., The 2012 Warkworth Observatory Local Tie Survey, 2013, Tie Survey, Land Information New Zealand.

Westford Antenna 2014 Annual Report

Mike Poirier

Abstract Technical information is provided about the antenna and VLBI equipment at the Westford site of the Haystack Observatory, and about changes to the systems since the IVS 2013 Annual Report.

1 Westford Antenna at Haystack Observatory

Since 1981, the Westford antenna has been one of the primary geodetic VLBI sites in the world. Located ~70 km northwest of Boston, Massachusetts, the antenna is part of the MIT Haystack Observatory complex.

The Westford antenna was constructed in 1961 as part of the Lincoln Laboratory Project Westford that demonstrated the feasibility of long-distance communication by bouncing radio signals off a spacecraft-deployed belt of copper dipoles at an altitude of 3,600 km. In 1981, the antenna was converted to geodetic use as one of the first two VLBI stations of the National Geodetic Survey Project POLARIS. Westford has continued to perform geodetic VLBI observations on a regular basis since 1981. Westford has also served as a testbed in the development of new equipment and techniques now employed in geodetic VLBI worldwide.

MIT Haystack Observatory

Westford Antenna

IVS 2014 Annual Report



Fig. 1 Aerial view of the radome and facilities of the Westford antenna. (For scale the diameter of the radome is 28 m.)

Table 1 Location and addresses of the Westford antenna.

Longitude	71.49° W
Latitude	42.61° N
Height above m.s.l.	116 m
MIT Haystack Observatory Off Route 40 Westford, MA 01886-1299 U.S.A. http://www.haystack.mit.edu	

2 Technical Parameters of the Westford Antenna and Equipment

The antenna is enclosed in a 28-meter diameter air-inflated radome made of 1.2 mm thick Teflon-coated fiberglass (see Figure 1). System temperatures are 10—20 degrees higher at X-band when the radome is wet than when it is dry. The effect is smaller at S-band. The major components of the VLBI data acquisition system

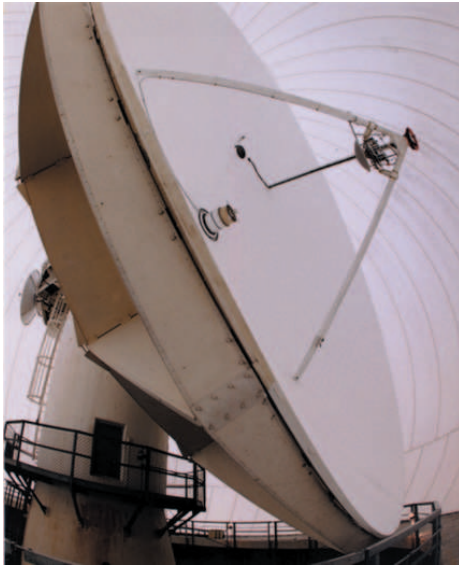

Fig. 2 Wide-angle view of the Westford antenna inside the radome. The VLBI S/X receiver is located at the prime focus. The subreflector in front of the receiver is installed when observing with the TAL receiver (see Section 4), which is located at the Cassegrain focus.

Table 2 Technical parameters of the Westford antenna for geodetic VLBI.

Parameter	Westford	
primary reflector shape	symmetric paraboloid	
primary reflector diameter	18.3 meters	
primary reflector material	aluminum honeycomb	
S/X feed location	primary focus	
focal length	5.5 meters	
antenna mount	elevation over azimuth	
antenna drives	electric (DC) motors	
azimuth range	90° – 470°	
elevation range	4° – 87°	
azimuth slew speed	3° s ⁻¹	
elevation slew speed	2° s ⁻¹	
	<i>X-band system</i>	<i>S-band system</i>
frequency range	8180-8980 MHz	2210-2450 MHz
T_{sys} at zenith	50–55 K	70–75 K
aperture efficiency	0.40	0.55
SEFD at zenith	1400 Jy	1400 Jy

are a Mark IV electronics rack, a Mark 5B recording system, and a Pentium-class PC running PC Field System version 9.10.2. The primary frequency and time standard is the NR-4 hydrogen maser. A CNS Clock GPS receiver system provides a 1 pps reference clock to which the maser 1 pps is compared.

Westford also hosts the WES2 GPS site of the IGS network. A Dorne-Margolin choking antenna is located on top of a tower at about 60 meters from the VLBI antenna. A LEICA GRX1200 Reference Station receiver completes the WES2 GPS site.

3 Westford Staff

The personnel associated with the geodetic VLBI program at Westford, and their primary responsibilities, are:

- Chris Beaudoin: broadband development
- Alex Burns: technician, observer
- Joe Carter: antenna servo support
- Brian Corey: VLBI technical support
- Kevin Dudevior: pointing system software
- Dave Fields: technician, observer
- Colin Lonsdale: site director
- Glenn Millson: observer
- Arthur Niell: principal investigator
- Michael Poirier: site manager

4 Standard Operations

From January 1, 2014 through December 31, 2014, Westford participated in 24 standard 24-hour sessions along with a 15-day continuous CONT14 session.

Westford reduced its regularly scheduled 54 sessions to support developmental and operational testing of the VGOS system.

Use of the Westford antenna is shared with the Terrestrial Air Link (TAL) Program operated by the MIT Lincoln Laboratory. In this project, Westford serves as the receiving end on a 42-km long terrestrial air link designed to study atmospheric effects on the propagation of wideband communication signals at 20 GHz.

5 Research and Development

The Westford antenna, in its role as a testbed for VLBI development, has been fitted with the VGOS broadband frontend and backend, MCI, and Mark 6 recorder systems. Presently, we are running bi-weekly 1-hour operational tests between Westford and the GGAO 12-m antenna, exercising the equipment and test procedures while providing quality VLBI geodetic observations.

6 Outlook

Westford is expected to participate in 54 24-hour sessions starting in March 2015. These sessions will include R1, R&D, and several VGOS sessions, along with the occasional fringe test and support of special VGOS broadband development testing.

Westford has purchased a replacement PC Field System (PCFS), and it is presently being configured by NVI, Inc. The pointing system upgrade will be implemented early in 2015 with the new PCFS, which will improve the compatibility with the new VGOS system and more easily support the Lincoln Laboratory (LL) program at Westford.

The Westford broadband system continues to be operated successfully at Westford. Operational testing continues, and we expect to become fully operational supporting all of our NASA sessions during 2015.

Acknowledgements

I would like to thank Arthur Niell, Christopher Beaudoin, and Chester Ruzczyk for their contributions to this report.

Funding for geodetic VLBI at Westford is provided by the NASA Space Geodesy Program.

Geodetic Observatory Wettzell - 20-m Radio Telescope and Twin Telescopes

Alexander Neidhardt ¹, Christian Plötz ², Gerhard Kronschnabl ², Torben Schüler ²

Abstract In 2014, the 20-m radio telescope at the Geodetic Observatory Wettzell in Germany, contributed again very successfully to the IVS observing program. Technical changes, developments, improvements, and upgrades were made to increase the reliability of the entire VLBI observing system. A new controller for the reflector heating was installed, and updates were made in some gears to avoid an oil leakage. In parallel, the new Twin radio Telescope Wettzell (TTW) was brought to operation so that it could observe the INT3 sessions as a tagged-along site. Local analysis shows a very good performance in X-band and a very good repeatability.

1 General Information

The 20-m Radio Telescope in Wettzell (RTW) is an essential component of the Geodetic Observatory Wettzell (GOW) and is jointly operated by Bundesamt für Kartographie und Geodäsie (BKG) and Forschungseinrichtung Satellitengeodäsie (FESG) of the Technische Universität München (Technical University Munich). In addition to the RTW, an ILRS laser ranging system, several IGS GPS permanent stations, a large laser gyroscope G (ringlaser), and the corresponding local techniques (e.g. time and frequency, meteorology and super conducting gravity meters, etc.) are also operated. Currently, the first

1. Forschungseinrichtung Satellitengeodäsie (FESG), Technische Universität München

2. Bundesamt für Kartographie und Geodäsie (BKG)

RTW/TWIN Wettzell Network Station

IVS 2014 Annual Report

antenna of the fully VGOS-compliant Twin radio Telescope is in an operational test phase.

Within the responsibility of the GOW are the TIGO system in Concepción, Chile, operated mainly together with the Universidad de Concepción (see separate report about TIGO), and the German Antarctic Receiving Station (GARS) O'Higgins on the Antarctic peninsula, operated together with the German Space Center (DLR) and the Institute for Antarctic Research Chile (INACH) (see separate report about O'Higgins).

2 Staff

The staff of the GOW consists in total of 31 members (plus 14 student operators) for operations, maintenance, and repair issues and for improvement and development of the systems. The staff operating VLBI is summarized in Table 1.

3 Observations in 2014

The 20-m RTW has been supporting the geodetic VLBI activities of the IVS and partly other partners, such as the EVN, for over 30 years now. All successfully observed sessions in the year 2014 are summarized in Figure 1. The telescope is in a very good and stable state. The main priority in operations was the participation in all daily one-hour INTENSIVE-sessions (INT) in order to determine UT1-UTC. Using the Field System extension for remote control, weekend INTENSIVES were partly done in the new observation modes by remote attendance. According to new safety regula-

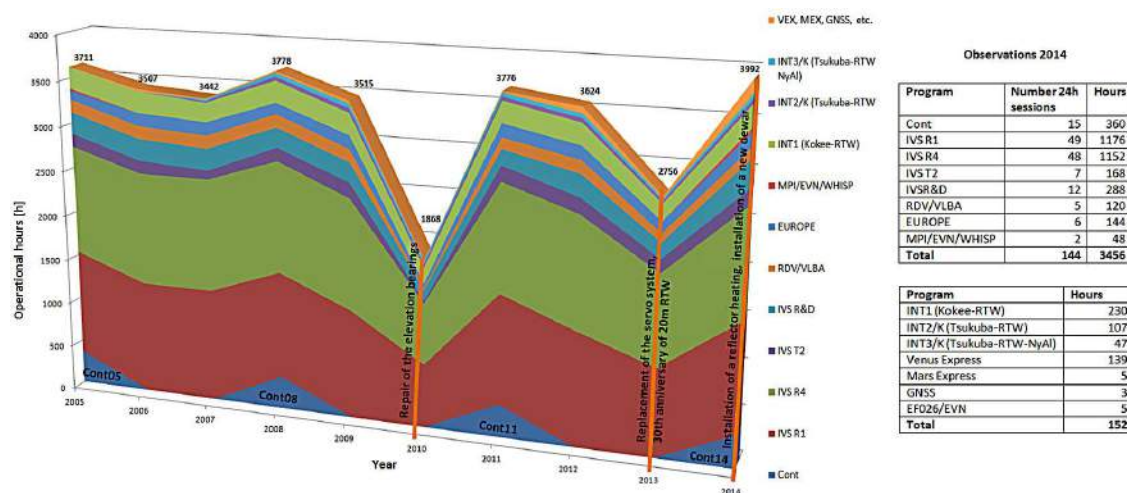

Fig. 1 Observation statistics of the last years and observations in the year 2015.

Table 1 Staff - members of RTW.

Name	Affiliation	Function	Mainly working for
Torben Schüller	BKG	head of the GOW	GOW
Alexander Neidhardt	FESG	head of the VLBI group and VLBI station chief	RTW, TTW
Erhard Bauernfeind	FESG	mechanical engineer	RTW
Ewald Bielmeier	FESG	technician	RTW
Gerhard Kronschnabl	BKG	electronic engineer (chief engineer TTW)	TTW, RTW, TIGO
Christian Plötz	BKG	electronic engineer (chief engineer RTW)	O'Higgins, RTW, TTW
Raimund Schatz	FESG	software engineer	RTW
Walter Schwarz	BKG	electronic engineer	RTW, WVR
Reinhard Zeitlhöfler	FESG	electronic engineer	RTW
Armin Böer	BKG	electronic engineer	Infrastruct., RTW
Jan Kodet	FESG	appl. phys. engineer	DFG FOR1503 GNSS, time ref.
Katharina Kirschbauer	FESG	student	Development monitoring
Gordon Klingl	FESG/BKG	student	Operator RTW/SLR
Yvonne Klingl	FESG/BKG	student	Operator RTW/SLR
Matthias Kronschnabl	FESG	student	Development TWIN
Julia Weber	FESG/BKG	student	Operator RTW/SLR

tions, unattended observations are not done until additional safety equipment is installed, such as wind sensors to move the antenna automatically into its stow position. Meanwhile, all data are transferred with e-VLBI techniques (except VLBA-sessions together with Socorro, New Mexico, USA). RTW now routinely uses the Internet connection capacities of 1 Gbit/sec for the

e-Transfers with the Tsunami protocol to the correlators in Bonn, Tsukuba, Haystack, and Washington.

In addition to the standard sessions, RTW was active for other special observations such as the tracking of the ESA Venus Express (VEX) spacecraft, the Mars Express (MEX) spacecraft, and the RadioAstron satellite for the EVN. More progress was possible for the tracking of Glonass and GPS satellites. Additional developments of an L-band receiver and a permanent satellite tracking mechanism enabled observations of these GNSS satellites. GNSS observations could be scheduled, commonly observed, correlated, and analyzed in cooperation with the Technical University in Vienna, Austria and the observatory in Onsala, Sweden.

4 Technical Improvements and Maintenance

Regularly, one maintenance day (obtaining replacements for the hardware, eight-pack repair, gear and bearing maintenance, NASA Field System updates, cryo-system maintenance, and repairs of the Mark IV rack) was scheduled for the usual maintenance work per month.

A new controller for the reflector heating was installed to enable the cleaning of the reflector from snow and ice during the winter month (de-icing). The heating rods had already been installed during the maintenance



Fig. 2 A panorama view of the observatory with the 20-m RTW on the right and the two TWIN telescopes in the back.

of the servo system in 2013. Additionally, one azimuth and one elevation gear required a maintenance update within the warranty period, because of an oil leakage problem.

The existing dewar was replaced by a new one to increase the maintenance intervals of the cryo system. The new dewar is an upgraded version of the replaced dewar. The upgrades were done at the IVS Centro de Desarrollos Tecnológicos de Yebes, Spain. The software for the dewar monitoring is also updated to an Ethernet-based realization. The last month of 2014 showed that the pressure stability of the dewar is quite good and keeps a pressure of lower than 10^{-8} mbar, which kept the temperature stable around 20K.

The NASA Field System is updated to the latest available version, 9.11.6, to enable the DBBC connectivity. The upgrade of the station specific software is still under progress. The goal is the homogenization with the TWIN control software. Additionally, the Mark 5 systems were tested with the new “jive5ab” from JIVE in Dwingeloo, The Netherlands. The software should become the basis for transferring the data to the new TWIN control room in real-time while the scans are recorded.

The usage of the new Digital Baseband Converters (DBBC) was forced, so that the 20-m RTW is in principle DBBC-ready. Additionally a preferred solution with the ADS3000+ from Japan was established and tested (also in preparation for the O’Higgins upgrades). Several test data were correlated at the Bonn Corre-

lator to check functionality and quality (especially in combination with the Twin operation tests). An additional correlator class was held in Wetzell by Alessandra Bertarini from the Bonn Correlator, to enable quality checks and analysis of local baselines with its own correlator-PC (with four (plus four virtual) CPU-cores) with a DiFX installation.

The remote control software “e-RemoteCtrl” was also extended, mainly by the TUM. New features were established in close cooperation with the developers of the NASA Field System and with other test sites at Australia (e.g. Hobart, Katherine, and Yarragadee). The AuScope network and the Wetzell site already use the software routinely. Therefore, a development and research stay was paid by AuScope to extend the software with required utilities in November 2014.

Another new field is the preparation for tracking of global navigation satellites. Therefore, new amplifier and receiver boards were permanently installed. These can be used after the waveguides for S-band to receive the L-band of the satellite. Test experiments were operated together with the TU Vienna, Austria and the Onsala Observatory, Sweden.

Because of new safety regulations, maintenance manuals were established, and risk assessments were started. A main focus is the reestablishment of the unattended observations, which were limited. Therefore Vertex realized additional safety features, such as oscillation detection and a minimum safety elevation. Additionally, the system monitoring software SysMon

was extended with additional features to support the monitoring tool Zabbix. This should enable a realization of a general system status display during unattended observations.

According to the experiences from the AuScope network, the saving of all documents, introductions, and manuals in a central, digital document archive has now begun.

5 The TWIN Radio Telescope Wettzell (TTW)

The Twin Telescope Wettzell project is Wettzell's realization of a complete VGOS conformity. The mechanical system is completely functional on both antennas. The controlling system was updated with the same safety features as the 20-m RTW. The receiving and the data acquisition systems for the northern antenna (TTW1) is finished for first VGOS tests with S-/X-/Ka setups. (There is only a cooling problem of one S-band LNA in the receiver chain of the left-hand-circular-polarized signal; it will be exchanged after TTW2 is operative.) The dewar and the cooler have been operating for over nine months now. The new control room is completely set up to control both the Twin telescopes and the old 20-m antenna.

The Twin telescope TTW1 (northern antenna, Wn) started its operational test phase with regular Monday INTENSIVE observations. These operational test sessions were performed together with the 20-m antenna, using DBBCs and also a Japanese ADS3000+ system. Approximately 190 observation hours were recorded in 2014. The scans were correlated in Bonn and analyzed by the analysis group in Bonn and with separate software in Wettzell. The X-band performance is excellent with an efficiency of over 80 percent at a system temperature of 30 K over the bandwidth of 6.4 to 9.6 GHz. The position repeatability after the analysis is also quite good for X-band. S-band suffers from RFI, so that it is not ideal for usage in the analysis. Filters should reduce this problem. The Ka-band performance was tested with a spectrum analyzer and a calibration source and shows suitable results, which need to be verified again after the new tri-band-receiver and up-down converter hardware have been installed in 2015.

The broadband feed horn (Eleven feed) for the second telescope TTW2 (south tower, Ws) arrived

in Wettzell and was tested here. The feed is built by Omnisys in Göteborg, Sweden. It was finished in August 2014 after some updates of the gold coating, which originally led to worse system temperatures in higher frequencies. In September 2014, the factory approval in Sweden showed that the results of the test measurements completely meet the specifications now. After the feed was delivered to Wettzell, the system temperatures could be verified, so that the shipment to Mirad in Switzerland could be arranged. There it will be tested again and mounted into the feed cone. The already available feed patterns look quite promising. But a mismatch in the conversion of the digital 3D-drawings caused a mechanical misalignment between feed mounting and cone. This error shifts the final delivery in the timeline to a later date. It should then be used with another broadband up-down-converter rack in combination with a DBBC3 and a FILA10G connection to a Mark 6 or a FlexBuf-system.

In the meantime the permanent survey of the reference point of the TTW2 was continued using total stations on different pillars and 20 to 30 reflectors in the back structure of the antenna. The goal is a continuous monitoring of the reference point over one year.

6 Future Plans

Dedicated plans for 2015 are:

- Update of the safety conformity papers for the 20-m RTW,
- Complete change to the new digital baseband converters for the 20-m RTW,
- Establishment of first real broadband experiments with S/X/Ka with TTW1,
- Development of a new receiver and system monitoring software for TTW2, and
- Installation of the Elevenfeed at TTW2 and first test observations.

Instituto Geográfico Nacional of Spain

Jesús Gómez-González ¹, Francisco Colomer ¹, José Antonio López-Fernández ², Luis Santos ³, Pablo de Vicente ²

Abstract The National Geographic Institute (IGN) of Spain has been involved in space geodesy activities since 1995. The 40-m radio telescope at Yebes Observatory has been a network station for IVS since 2008 and participates regularly in IVS campaigns. IGN is developing an Atlantic Network of Geodynamical and Space Stations (project RAEGE). The first antenna saw its first light in 2014 at Yebes Observatory. The construction of a second antenna of RAEGE (in Santa Maria, Azores islands, Portugal) is complete, and commissioning is ongoing. Since March 2014, IGN Yebes Observatory has been a Technology Development Center for IVS; therefore many such developments are being described in the appropriate report in this Annual Report.

1 General Information

The National Geographic Institute of Spain (Instituto Geográfico Nacional, Ministerio de Fomento), has run geodetic VLBI programs at Yebes Observatory since 1995 and nowadays operates a 40-m radio telescope which is a network station for IVS. Yebes Observatory is also the reference station for the Spanish GNSS network and holds permanent facilities for gravimetry. A new VGOS-type antenna has been built at Yebes as part of the RAEGE project (the acronym RAEGE stands

1. Instituto Geográfico Nacional (IGN)

2. IGN Yebes Observatory

3. Secretaria Regional da Ciência, Tecnologia e Equipamentos (Azores, Portugal)

IGN-Yebes Network Station

IVS 2014 Annual Report

for “Red Atlántica hispano-portuguesa de Estaciones Geodinámicas y Espaciales”).

Since 2014, IGN Yebes Observatory has been a Technology Development Center for IVS. Activities are described in the corresponding report in this Annual Report.

2 Current Status and Activities

In 2014, the 40-m radio telescope has participated in 53 sessions (17 R1, 15 R4, two T2, and two EUROPE, two RD, and 15 in CONT14). All the data is being routinely transferred by Internet to the IVS correlators.

2.1 RAEGE

IGN, together with Portuguese colleagues in DSCIG (Azores Islands), continues the construction of a network of four new Fundamental Geodynamical and Space Stations. The RAEGE project was described in previous IVS Annual Reports. The Spanish-Portuguese VGOS network RAEGE will cover three continental plates, with sites in Spain at Yebes (Eurasian Plate) and Tenerife (African Plate), and in Portugal on the Azorean islands of Santa Maria (Eurasian Plate) and Flores (North American Plate).

First interferometric fringes of the RAEGE “Jorge Juan” radio telescope were obtained on November 26, 2014, in an observation together with the 40-m radio telescope at Yebes at X-band (see Figure 1).

The construction of a second antenna, in Santa María (Azores), is complete, and commissioning is

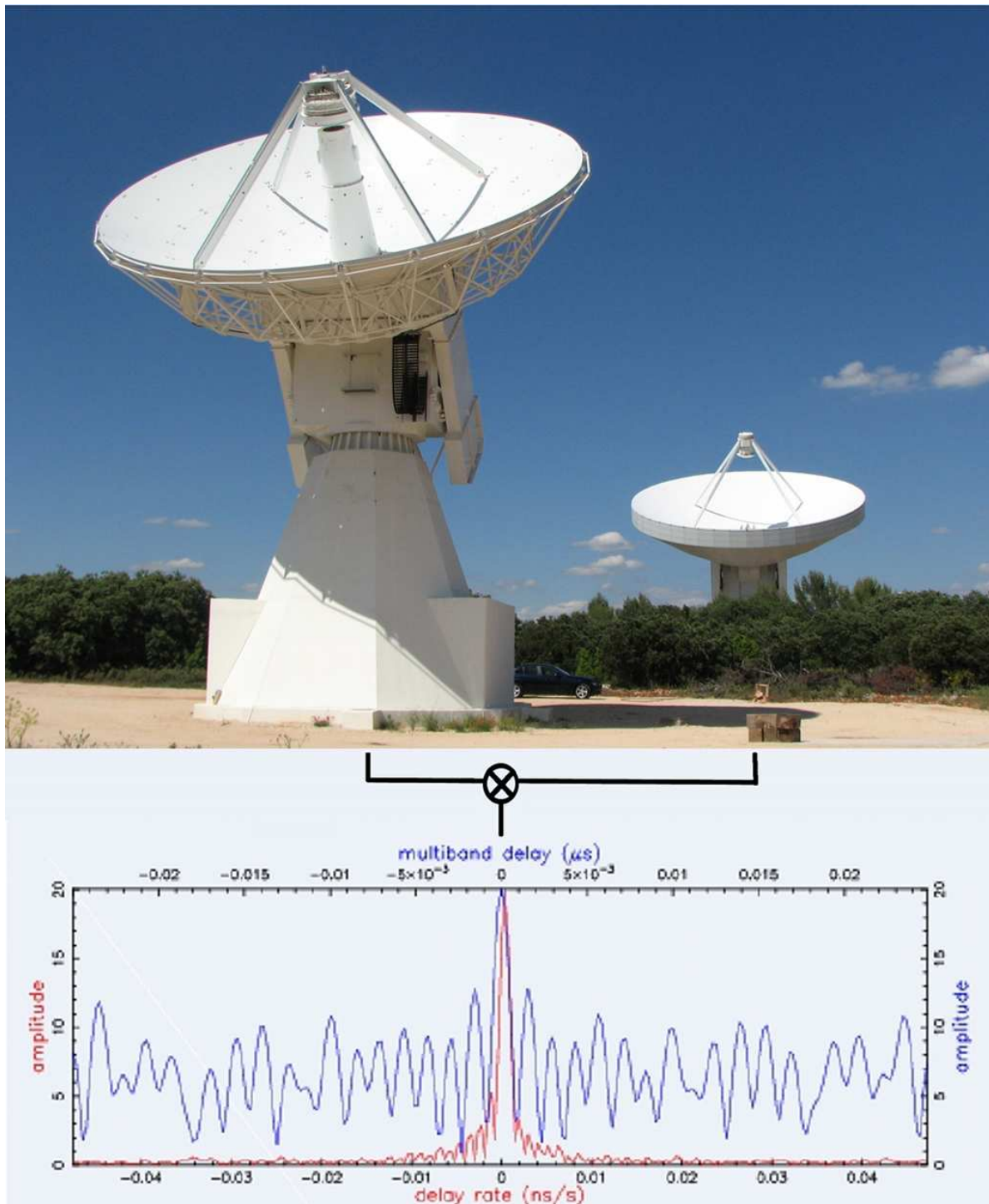

Fig. 1 First fringes of the RAEGE “Jorge Juan” radio telescope, obtained with the 40-m telescope also at Yebes Observatory.

ongoing. Also the construction of a control building is very advanced (see Figure 2). The official inauguration is scheduled on May 20, 2015, as a follow up of the 22nd meeting of the European VLBI

Table 1 Staff in the IGN VLBI group (e-mail: vlbitech@oan.es).

Name	Background	Role	Address*
Francisco Colomer	Astronomer	VLBI Project coordinator	IGN, Yebes
Jesús Gómez-González	Astronomer	Deputy Director for Astronomy, Geophysics, and Space Applications	IGN
José Antonio López-Fdez	Engineer	RAEGE Director	Yebes
Pablo de Vicente	Astronomer	VLBI technical coordinator	Yebes
José Antonio López-Pérez	Engineer	Receivers	Yebes
Félix Tercero	Engineer	Antennas	Yebes
Susana García-Espada*	Engineer	geoVLBI expert	Yebes
Javier López-Ramasco	Geodesist	Geodesist	Yebes

* At Azores since November 2014.

Group for Astrometry and Geodesy (EVGA, see <http://evga2015.raege.net/>).

Detailed information on RAEGE is available on the Web at <http://www.raege.net/>

2.2 Local Tie

A network of 24 monuments (concrete pillars) have been built in 2014 in the area of Yebes Observatory in order to relate the measurements taken by our two VLBI radio telescopes (40-m and 13-m) and two GNSS antennas (IGS code “YEBE”, on the roof of the office building, and “YEB1”, on the roof of the gravimeter building).

We have also investigated the possibility to measure the invariant reference point (IRP) of the 13-m radio telescope with a robotic total station, installed on the central pillar of the concrete tower. A tripod with an optical plummet is placed on the marked centered screw of the pillar. Then it is possible to measure the position of a corner cube reflector with a manufacturing precision of 0.0001 mm, which is attached magnetically to the inner sides of both antenna counterweights (see Figure 3). Measures of the reflector (CCR) can be taken every 30 seconds for both counterweights by moving the antenna around the elevation and azimuth axis. This operation can be done even when a regular VLBI session is occurring.

A detailed description, measured values, and modeling results are shown in the proceedings of the 8th IVS General Meeting (Gómez-González et al., Shanghai 2014).

3 IGN Staff Working on VLBI Projects

Table 1 lists the IGN staff who are involved in space geodesy studies and operations. The VLBI activities are also supported by other staff members such as receiver engineers, computer managers, telescope operators, secretaries, and students.

4 Future Plans

In order to comply with the VGOS specifications, a new broadband receiver is being developed at Yebes and should be available for observations in 2015. See the report of the IGN Yebes Observatory Technology Development Center for details. We look forward to participating in the early VGOS tests starting in 2015 with the new RAEGE 13.2-m “Jorge Juan” antenna.

The infrastructure works for the RAEGE station near the city of Tegueste (Tenerife, Canary Islands) will be deployed in 2015, followed by the erection of the antenna, built by MT Mechatronics GmbH.

Regarding the RAEGE station in Santa María, the official inauguration is scheduled on May 20, 2015 during the events of the EVGA meeting. Commissioning will be performed for an expected start of observations in 2016.

Preliminary work in Flores is being conducted to characterize the presence of radio frequency interference at the selected site for the RAEGE station there.



Fig. 2 Status of construction of the control building at the RAEGE station in Santa María (Azores).



Fig. 3 Left: Vertex monument in Yebes. Middle: Reflector RRR attached magnetically to the inner side of one counterweight. Right: Robotic Total Station Leica TS-30 set up above the central pillar.

Zelenchukskaya Radio Astronomical Observatory 2014 IVS Annual Report

Sergey Smolentsev, Andrei Dyakov, Dmitry Ivanov

Abstract This report summarizes information on activities at the Zelenchukskaya Radio Astronomical Observatory in 2014. The report provides an overview of current geodetic VLBI activities and gives an outlook for the next year.

1 General Information

Zelenchukskaya Radio Astronomical Observatory (Figure 1) was founded by the Institute of Applied Astronomy (IAA) as one of three stations of the Russian VLBI network QUASAR. The sponsoring organization of the project is the Russian Academy of Sciences (RAS). The Zelenchukskaya Radio Astronomical Observatory is situated in Karachaevo-Cherkesskaya Republic (the North Caucasus) about 70 km south of Cherkessk, near Zelenchukskaya village (Table 1). The geographic location of the observatory is shown on the IAA RAS Web site: <http://www.ipa.nw.ru/PAGE/rusipa.htm>. The basic instruments of the observatory are a 32-m radio telescope equipped with special technical systems for VLBI observations and a 13.2-m VGOS antenna. The observatory is also equipped with co-location instruments such as GPS/GLONASS/Galileo receivers and an SLR system. In 2014 a WVR was installed.

Institute of Applied Astronomy of RAS

Network Station Zelenchukskaya

IVS 2014 Annual Report

Table 1 Zelenchukskaya Observatory location and address.

Longitude	41°34'
Latitude	43°47'
Karachaevo-Cherkesskaya Republic	
369140, Russia	
ipazel@mail.svkchr.ru	

2 Technical Staff

Table 2 Staff related to VLBI operations at Zelenchukskaya.

Andrei Dyakov	observatory chief
Dmitry Dzuba	FS, pointing system control
Anatoly Mishurinsky	front end and receiver support
Andrey Mikhailov	FS, pointing system control

3 Component Description

3.1 Technical and Scientific Information

Characteristics of RT-32 are presented in Table 3.

3.2 Co-location of VLBI, GPS/GLONASS and SLR System

The Javad GPS/GLONASS/Galileo receiver with meteo station WXT-510 is in operation (Figure 2). During 2014 “Sazhen-TM” SLR system at Zelenchukskaya observatory observed 1,767 passes of LAGEOS,



Fig. 1 Zelenchukskaya observatory.

Table 3 Technical parameters of the radio telescope.

Year of construction	2005
Mount	AZEL
Azimuth range	$\pm 270^\circ$ (from south)
Elevation range	from -5° to 95°
Maximum azimuth	
- velocity	$0.83^\circ/\text{s}$
- tracking velocity	$2.5'/\text{s}$
- acceleration	$12.0''/\text{s}^2$
Maximum elevation	
- velocity	$0.5^\circ/\text{s}$
- tracking velocity	$0.8'/\text{s}$
- acceleration	$12.0''/\text{s}^2$
Pointing accuracy	better than $10''$
Configuration	Cassegrain (with asymmetrical subreflector)
Main reflector diameter	32 m
Subreflector diameter	4 m
Focal length	11.4 m
Main reflector shape	quasi-paraboloid
Subreflector shape	quasi-hyperboloid
Main reflector surface accuracy	± 0.5 mm
Frequency range	1.4–22 GHz
Axis offset	3.7 ± 2.0 mm

normal points. The technical parameters of the system are presented in Table 3.



Fig. 2 Javad GPS/GLONASS/Galileo receiver at the Zelenchukskaya observatory.

In 2014 a WVR was installed at Zelenchukskaya, and it successfully works.

GLONASS, and other satellites and obtained 8,768



Fig. 3 “Sazhen-TM” SLR system at Zelenchukskaya observatory.



Fig. 4 13.2 m at Zelenchukskaya observatory.

4 Current Status and Activities during 2014

Zelenchukskaya observatory participates in IVS and domestic VLBI observational programs. During 2014 Zelenchukskaya station participated in 50 24-hour IVS sessions — 25 IVS-R4 sessions, three IVS-T2 sessions, two EUROPE, five R&D, and 15 IVS-CONT sessions.

Zelenchukskaya participated in 48 24-hour sessions in the framework of the domestic Ru-E program for determination of all Earth orientation parameters and in 364 one-hour Ru-U sessions for obtaining Universal Time using e-VLBI real time data transfer. e-VLBI data transfer is used for Zelenchukskaya observational data for the Ru-E 24-hour sessions, too.

Mounting of the 13.2-m antenna on its pedestal (Figure 4) is finished.

In 2014 a WVR was installed and successfully worked (Figure 5).



Fig. 5 WVR at Zelenchukskaya observatory.

- To carry out SLR observations of geodetic and navigation satellites,
- To participate in EVN and RADIOASTRON observational sessions,
- To continue geodetic monitoring of the RT-32 parameters,
- To perform regular WVR observations,
- To install receiver and other equipment of RT-13 and commission RT-13 in 2015.

5 Future Plans

Our plans for the coming year are the following:

- To participate in IVS sessions,
- To carry out domestic observational programs for obtaining Universal Time daily and for obtaining Earth orientation parameters weekly with e-VLBI data transfer,

References

1. Finkelstein A., Ipatov A., Smolentsev S. The Network “Quasar”: 2008-2011 // “Measuring the future”, Proc. of the Fifth IVS General Meeting, A. Finkelstein, D. Behrend (eds.), St. Petersburg, “Nauka”, 2008. pp. 39–46.

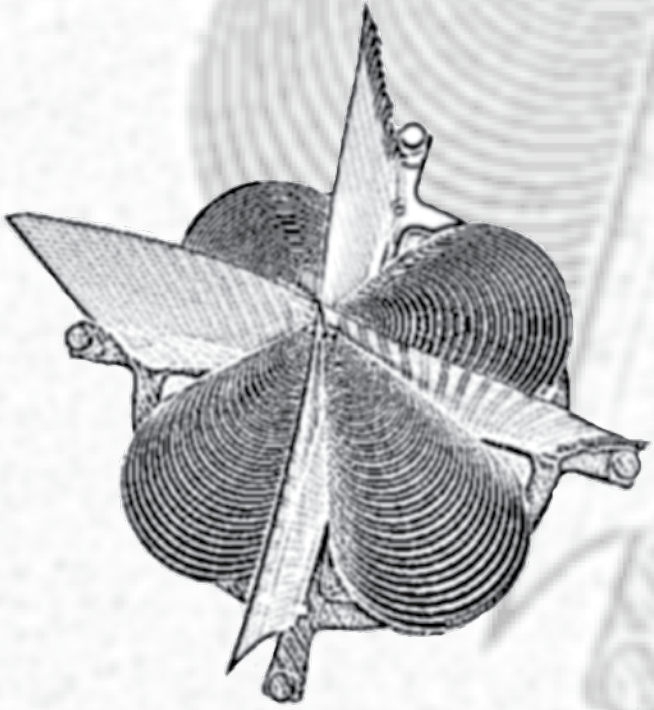

Operation Centers

Bonn Geodetic VLBI Operation Center

A. Müssens, A. Nothnagel

Abstract The IGGB Operation Center has continued to carry out its tasks of organizing and scheduling various observing sessions of the IVS-T2, IVS-OHIG, IVS-INT3, and EUROPE series.

1 Center Activities

The IGGB VLBI Operation Center is part of the Institute of Geodesy and Geoinformation of the University of Bonn, Nußallee 17, D-53115 Bonn, Germany. It has been organizing and scheduling VLBI observing sessions for more than thirty years. The work of the Operation Center is closely related to the Bonn Correlator. For this reason, distribution of media (Mark 5 disk units) to the stations after correlation is still the most costly part of the operations since network capacity has remained constant at 1 Gb/s for financial reasons.

- **IVS-T2 Series**

This series has been observed roughly every second month (seven sessions in 2014) primarily for maintenance and stabilization of the VLBI terrestrial reference frame as well as for Earth rotation monitoring as a by-product. Each station of the global geodetic VLBI network is planned to participate in the T2 sessions at least once per year. In view of the limitations in station days, priority was given to strong and robust networks with many sites over more observing sessions. Therefore, generally 15 to

21 stations have been scheduled in each session in 2014.

By the way, on November 11, 2014, the 100th T2 was scheduled and observed. Figure 1 shows the increase in number of participating telescopes over the years. The scheduling of these sessions has to take into account that a sufficient number of observations is planned for each baseline of these global networks. The recording frequency setup is 16 channels and 4 MHz channel bandwidth.

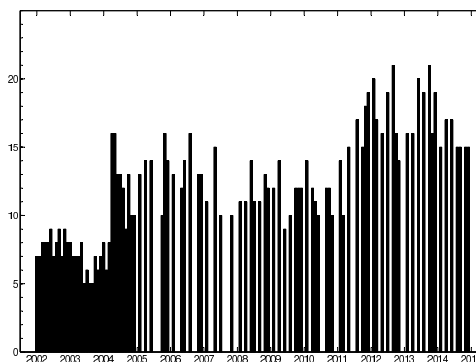

Fig. 1 Number of stations in T2 sessions since 2002.

- **Measurement of Vertical Crustal Motion in Europe by VLBI (EUROPE)**

Since the late 1980s, a series of special sessions has been regularly scheduled in Europe for precise determination of station coordinates and for long term stability monitoring. This year, six network observing sessions with Ny-Ålesund (six sessions), Metsähovi (three), DSS65a (four), Svetloe (two),

Institut für Geodäsie und Geoinformation der Universität Bonn

Bonn Operation Center

IVS 2014 Annual Report

Zelenchukskaya (two), Badary (two), Effelsberg (one), Wettzell (six), Simeiz (three), Medicina (two), Matera (one), Noto (three), and Yebes (YEBES40M) (two) were scheduled employing the frequency setup of 16 channels and 4 MHz bandwidth (identical to the setup of the IVS-T2 sessions).

- **Southern Hemisphere and Antarctica Series (OHIG):**

In February 2014, three sessions of the Southern Hemisphere and Antarctica Series with the Antarctic stations Syowa (Japanese), Katherine (North Australia), Yarragadee (West Australia), TIGO (Concepción), Warkworth (New Zealand), Hobart12 (Tasmania), HartRAO12 (South Africa), Kokee, and Fortaleza have been organized. O’Higgins (Germany) was omitted due to special technical receiver and dewar upgrades. The (southern) winter O’Higgins burst (OHIG91-93) was scheduled with all of the stations named above, but it had to be observed without O’Higgins for the same reason. The purpose of these sessions is the maintenance of the VLBI terrestrial reference frame (TRF) and monitoring of Earth rotation as a by-product. The recording frequency setup is 16 channels and 4 MHz channel bandwidth. Due to the fact that Syowa is not able to deliver the recorded data for nearly one year after the observations, the correlation and the generation of the databases is always delayed considerably.

- **UT1 determination with near-real-time e-VLBI (INT3):**

The so-called INT3 sessions were originally set up for the telescopes of Ny-Ålesund, Tsukuba, and Wettzell for weekly UT1 determinations aiming at very quick delivery of results. The sessions are always scheduled to start on Monday morning at 7:00 a.m. UT. From the beginning of 2014 Seshan has taken part in the INT3 sessions on a monthly basis. The operations part of the INT3 sessions also includes rapid data transmission and correlation. The raw VLBI observation data of four sites is transferred to the Bonn Correlator by Internet connections directly after the session is completed to speed up delivery of the results. The transmission rate is about 400-600 Mb/s from Tsukuba and

Wettzell, 300 Mb/s from Seshan, and 100 Mb/s for Ny-Ålesund. For the latter, the data rate is limited due to the use of a radio link for the first part of the distance. All transmissions share the “last mile” which is limited to 1 Gb/s due to financial limitations.

Altogether, 47 INT3 sessions were observed and transmitted successfully in 2014. 96% of the sessions were correlated and the databases delivered within the first four hours after the end of the observations. A further 2% were completed within the next 48 hours due to difficulties with networking hardware and/or station and processor problems.

2 Staff

Table 1 Personnel at IGGB Operation Center.

Arno Müskens	+49-228-525264	mueskens@mpifr.de
Axel Nothnagel	+49-228-733574	nothnagel@uni-bonn.de

CORE Operation Center 2014 Annual Report

Cynthia C. Thomas, Daniel S. MacMillan

Abstract This report gives a synopsis of the activities of the CORE Operation Center from January 2014 to December 2014. The report forecasts activities planned for the year 2015.

1 Changes to the CORE Operation Center's Program

The Earth orientation parameter goal of the IVS program is to attain precision at least as good as $3.5 \mu\text{s}$ for UT1 and $100 \mu\text{as}$ for pole position.

The IVS program, which started in 2002, used the Mark IV recording mode for each session. The IVS program began using the Mark 5 recording mode in mid-2003. By the end of 2007, all stations were upgraded to Mark 5. Due to the efficient Mark 5 correlator, the program continues to be dependent on station time and media. The following are the network configurations for the sessions for which the CORE Operation Center was responsible in 2014:

- IVS-R1: 49 sessions, scheduled weekly and mainly on Mondays, six to 13 station networks
- RDV: Six sessions, scheduled evenly throughout the year, 14 to 16 station networks
- IVS-R&D: 12 sessions, scheduled monthly, six to 14 station networks
- CONT14: 15 sessions, scheduled continuously during a two week period, 17 station networks

NVI, Inc.

CORE Operation Center

IVS 2014 Annual Report

2 IVS Sessions from January 2014 to December 2014

This section describes the purpose of the IVS sessions for which the CORE Operation Center is responsible.

- IVS-R1: In 2014, the IVS-R1s were scheduled weekly with six to 13 station networks. During the year, 20 different stations participated in the IVS-R1 network, but there were only eight stations that participated in at least half of the scheduled sessions—Wetzell (49), Tsukuba (44), Ny-Ålesund (43), Fortaleza (37), Hart15m (36), Hobart12 (31), Yarragadee (30), and Katherine (29). Sejong and Tianma65 participated in the IVS-R1 sessions for the first time during 2014.

The purpose of the IVS-R1 sessions is to provide weekly EOP results on a timely basis. These sessions provide continuity with the previous CORE series. The “R” stands for rapid turnaround because the stations, correlators, and analysts have a commitment to make the time delay from the end of data recording to the analysis results as short as possible. The time delay goal is a maximum of 15 days from the end of data recording to the end of correlation. Sixty-two percent of the IVS-R1 sessions were completed in 15 or fewer days. The remaining 38% were completed in 16 to 42 days [16 days (five), 17 days (four), 22 days (two), 23 days (one), 26 days (one), 27 days (three), 28 days (one), and 42 days (one)]. Participating stations are requested to ship disks to the correlator as rapidly as possible or to transfer the data electronically to the correlator using e-VLBI. The “1” indicates that the sessions are mainly on Mondays.

- **RDV:** There are six bi-monthly coordinated astrometric/geodetic experiments each year that use the full ten-station VLBA plus up to six geodetic stations.

These sessions are being coordinated by the geodetic VLBI programs of three agencies: 1. USNO performs repeated imaging and correction for source structure; 2. NASA analyzes this data to determine a high accuracy terrestrial reference frame, and 3. NRAO uses these sessions to provide a service to users who require high quality positions for a small number of sources. NASA (the CORE Operation Center) prepares the schedules for the RDV sessions.

- **R&D:** The purpose of the twelve R&D sessions in 2014, as decided by the IVS Observing Program Committee, was to test the 512 Mbps recording mode for the CONT14 Campaign (RD1401 and RD1402); vet sources for GAIA proposal (RD1403, RD1404, RD1406, RD1408, RD1410, and RD1412), and observe the Chang'E-3 Lander with VLBI (RD1405, RD1407, RD1409, and RD1411). Two extra R&Ds were added during 2014 to support the four requested Chang'E-3 Lander sessions.

3 Current Analysis of the CORE Operation Center's IVS Sessions

Table 1 provides the average formal errors for the R1, R4, RDV, and CONT14 sessions from 2014. The R1 session formal uncertainties are not significantly different from the 2012-2013 errors. The R1 and R4 polar motion and nutation uncertainties for 2014 sessions are 10-20% better than for 2012-2013. R1 and R4 UT1 uncertainties were comparable to those in 2012-2013. R1 uncertainties could be further reduced if we used a GPS a priori model to obtain the post-earthquake behavior at Tsukuba or if we estimated global spline parameters for the post-seismic displacement at Tsukuba instead of estimating the TSUKUB32 position for each session after the earthquake, thereby weakening its contribution to EOP.

It is not clear why RDV polar motion uncertainties are about 10% larger for 2014 than 2013. The RDV formal errors are not significantly different than for R1 and R4 experiments. This is due to the increasing num-

ber of stations in R1 and R4 sessions as well as better global geometry. For comparison, we also included the formal uncertainties for the CONT11 and CONT14, which are much better than for any of the networks discussed above that observed in 2014.

Table 2 shows EOP differences with respect to the IGS series for the R1, R4, RDV, CONT11, and CONT14 series. The WRMS differences were computed after removing a bias, but estimating rates does not affect the residual WRMS significantly. Both the R1 and R4 series for 2014 have better WRMS agreement in X-pole, Y-pole, and LOD for 2014 than for the corresponding full series from 2000 to 2014. Adopting the improved GPS a priori model strategy mentioned above improves the R1 agreement with IGS by 20%. The X-pole and Y-pole biases of the R1 and R4 sessions relative to IGS are significant and are likely due to reference frame bias. In 2014, there appear to be some performance issues regarding the RDV sessions given that the WRMS agreement for polar motion and LOD are significantly worse than for the full period of observing since 2000. Over that full period 2000-2014, the RDVs have the best agreement with IGS of all the series. For comparison with the 2014 operational sessions discussed here, we included the statistics for both the CONT11 and CONT14 sessions, which have the best WRMS agreement with IGS most likely because the CONT networks were unchanged over the respective periods of continuous observing. The X-Pole agreement with IGS for CONT14 is significantly better than for CONT11. This is expected because the CONT14 network has better geometry than CONT11.

4 The CORE Operations Staff

Table 3 lists the key technical personnel and their responsibilities so that everyone reading this report will know whom to contact about their particular question.

5 Planned Activities during 2015

The CORE Operation Center will continue to be responsible for the following IVS sessions during 2015:

- The IVS-R1 sessions will be observed weekly and recorded in Mark 5 mode.

- The IVS-R&D sessions will be observed ten times during the year.
- The RDV sessions will be observed six times during the year.

Table 1 Average EOP Formal Uncertainties for 2014.

Session Type	Num	X-pole (μ as)	Y-pole (μ as)	UT1 (μ s)	DPSI (μ as)	DEPS (μ as)
R1	49	60(67,73)	55(66,63)	3.2(3.1,3.4)	86(105,110)	33(42,44)
R4	51	59(68,70)	57(66,67)	2.7(2.9,2.8)	112(120,124)	45(49,49)
RDV	6	59(54,48)	57(54,48)	2.7(2.8,2.5)	82(82,68)	34(33,28)
CONT11	15	38	37	1.7	42	17
CONT14	15	40	41	1.8	41	14

Values in parentheses are for 2013 and then 2012.

Table 2 Offset and WRMS Differences (2014) Relative to the IGS Combined Series.

Session Type	Num	X-pole		Y-pole		LOD	
		Offset (μ as)	WRMS (μ as)	Offset (μ as)	WRMS (μ as)	Offset (μ s/d)	WRMS (μ s/d)
R1	49(664)	-45(15)	84(93)	55(47)	86(87)	3.4(1.3)	15(17)
R4	51(656)	7(-7)	73(106)	63(50)	82(108)	2.9(1.9)	13(17)
RDV	6(90)	40(60)	91(83)	58(46)	78(69)	5.3(0.1)	19(14)
CONT11	15	43	35	27	30	6.5	6
CONT14	15	10	25	89	33	1.0	5

Values in parentheses are for the entire series (since 2000) for each session type.

Table 3 Key Technical Staff of the CORE Operations Center.

Name	Responsibility	Agency
Dirk Behrend	Organizer of CORE program	NVI, Inc./GSFC
Brian Corey	Analysis	Haystack
Ricky Figueroa	Receiver maintenance	ITT Exelis
John Gipson	SKED program support and development	NVI, Inc./GSFC
Frank Gomez	Software engineer for the Web site	Raytheon/GSFC
David Gordon	Analysis	NVI, Inc./GSFC
Ed Himwich	Network Coordinator	NVI, Inc./GSFC
Dan MacMillan	Analysis	NVI, Inc./GSFC
Katie Pazamickas	Maser maintenance	ITT Exelis
David Rubincam	Procurement of materials necessary for CORE operations	GSFC/NASA
Braulio Sanchez	Procurement of materials necessary for CORE operations	GSFC/NASA
Dan Smythe	Tape recorder maintenance	Haystack
Cynthia Thomas	Coordination of master observing schedule and preparation of observing schedules	NVI, Inc./GSFC

NEOS Operation Center

David M. Hall, Merri Sue Carter

Abstract This report covers the activities of the NEOS Operation Center at USNO for 2014. The Operation Center schedules IVS-R4 and the INT1 Intensive experiments.

The Operation Center updated the version of sked as updates became available.

All sessions are correlated at the Washington Correlator, which is located at USNO and is run by NEOS.

1 VLBI Operations

NEOS operations in the period covered consisted, each week, of one 24-hour duration IVS-R4 observing session, on Thursday-Friday, for Earth Orientation, together with five daily one-hour duration “Intensives” for UT1 determination, Monday through Friday. In 2014, the operational IVS-R4 network included VLBI stations at Kokee Park (Hawaii), Wettzell (Germany), Ny-Ålesund (Norway), TIGO (Chile), Fortaleza (Brazil), Tsukuba (Japan), Svetloe, Badary and Zelenchukskaya (Russia), Hobart, Katherine and Yarragadee (Australia), Yebes (Spain), and Matera and Medicina (Italy). A typical R4 consisted of eight to 12 stations.

The regular stations for the weekday IVS Intensives were Kokee Park and Wettzell. Intensives including Kokee Park, Wettzell, and Svetloe were occasionally scheduled in order to characterize the Kokee Park — Svetloe baseline so that Svetloe can be used as an alternate for Wettzell should it be needed. Odd-day Intensives were scheduled with the scheduling technique used since 2000; even-day Intensives were scheduled with a newer, experimental scheduling technique.

Table 1 Experiments scheduled during 2014.

52	IVS-R4 experiments
222	Intensives

2 Staff

D. M. Hall and M. S. Carter are the only staff members of the NEOS Operation Center. Mr. Hall is responsible for the overall management, and Carter makes the schedules. M. S. Carter is located at the USNO Flagstaff Station (NOFS).

U.S. Naval Observatory

NEOS Operation Center at USNO

IVS 2014 Annual Report

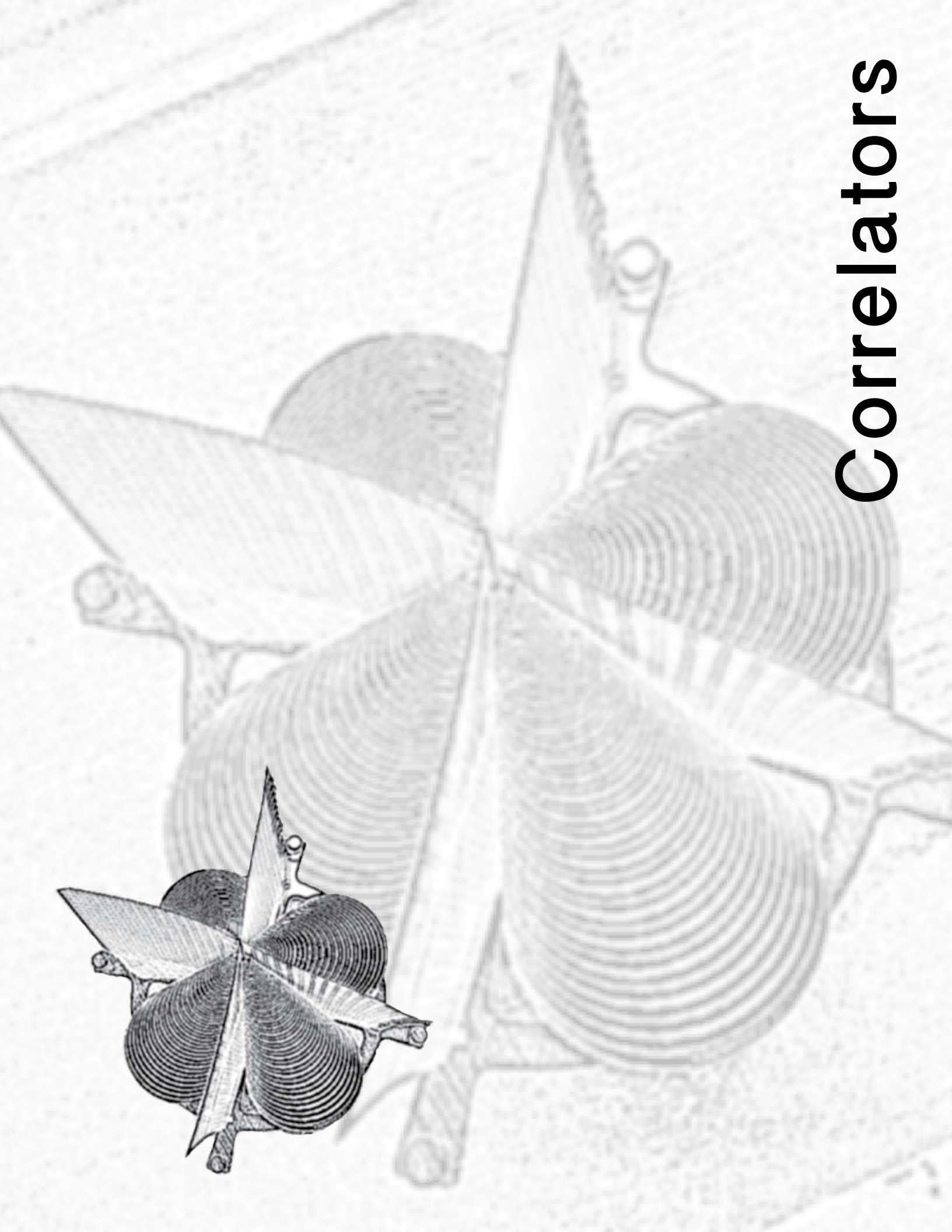
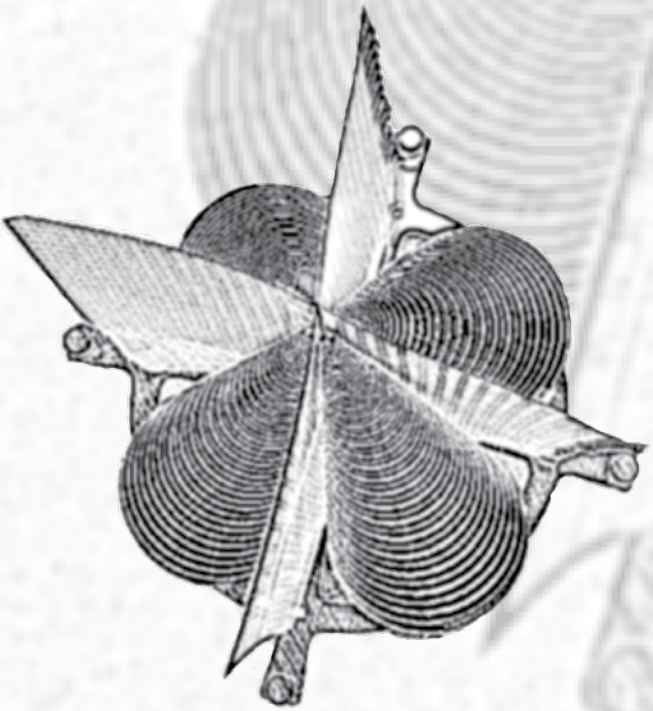

Correlators

The Bonn Astro/Geo Correlator

Simone Bernhart¹, Walter Alef², Alessandra Bertarini^{1,2}, Gabriele Bruni², Laura La Porta¹, Arno Müskens¹, Helge Rottmann², Alan Roy², Gino Tuccari^{2,3}

Abstract The Bonn Distributed FX (DiFX) correlator is a software correlator operated jointly by the Max-Planck-Institut für Radioastronomie (MPIfR), the Institut für Geodäsie und Geoinformation der Universität Bonn (IGG), and the Bundesamt für Kartographie und Geodäsie (BKG) in Frankfurt, Germany.

1 Introduction

The Bonn correlator is hosted at the MPIfR¹ VLBI correlator center in Bonn, Germany. It is operated jointly by the MPIfR and the BKG² in cooperation with the IGG³. It is a major correlator for geodetic observations and astronomical projects such as VLBI at millimeter wavelengths, astrometry, RadioAstron⁴ VLBI observations, and pulsar VLBI.

1. Institut für Geodäsie und Geoinformation der Universität Bonn
2. Max-Planck-Institut für Radioastronomie
3. Istituto di Radioastronomia - INAF

Bonn Correlator

IVS 2014 Annual Report

¹ <http://www.mpifr-bonn.mpg.de/>

² <http://www.bkg.bund.de/>

³ <http://www.gib.uni-bonn.de/>

⁴ <http://www.asc.rssi.ru/radioastron/>

2 Present Correlator Capabilities

The DiFX correlator⁵ was developed at Swinburne University in Melbourne by Adam Deller and other collaborators. It was adapted to the VLBA operational environment by Walter Brisken and the NRAO staff, and it is constantly updated by the worldwide DiFX developer group. In Bonn, the DiFX is running on a High Performance Compute Cluster (HPC cluster). Its technical specifications can be gathered from last year's annual report.

In preparation for the CONT14 correlation in spring/summer 2014, the Software Development Kit (SDK) of all 14 Mark 5 units was upgraded to version 9.3a.

Furthermore, in autumn the storage capacity was enlarged by an additional geodetic RAID to a total of about 610 TiB.

3 Staff

The people in the Geodesy VLBI group at the Bonn correlator are:

Arno Müskens - group leader and scheduler of T2, OHIG, EURO, and INT3 sessions.

Simone Bernhart - support scientist, e-transfer supervision and operations, experiment setup and evaluation of correlated data for geodesy, media shipping, and Web site maintenance.

Alessandra Bertarini - Friend of the correlator, experiment setup and evaluation of correlated data for

⁵ DiFX: A Software Correlator for Very Long Baseline Interferometry using Multiprocessor Computing Environments, 2007, PASP, 119, 318

both astronomy (e.g. APEX) and geodesy, and digital baseband converter (DBBC) testing.

Laura La Porta - support scientist, e-transfer supervision and operations, geodetic experiment setup and evaluation of correlated data, and DBBC testing.

The people in the astronomical group at the Bonn correlator are:

Walter Alef - head of the VLBI technical department, computer systems, and cluster administration.

Alan Roy - deputy group leader, support scientist (water vapor radiometer, technical assistance, development of linear to circular polarization conversion software for phased ALMA, and project manager for equipping APEX for millimeter VLBI).

Gabriele Bruni - support scientist for RadioAstron, experiment setup and evaluation of correlated data, and e-transfer supervision and operations.

Armin Felke - FPGA programming for DBBC.

Heinz Fuchs - correlator operator, responsible for the correlator operator schedule, daily operations, and media shipping.

David Graham - consultant (technical development, DBBC development, and testing).

Rolf Märtens - technician maintaining cluster hardware and Mark 5 playbacks.

Helge Rottmann - software engineer for correlator development and operation, cluster administration, developer for the ALMA Phasing Project, and Field System.

Hermann Sturm - correlator operator, correlator support software, media shipping, and Web page development.

Gino Tuccari - guest scientist from INAF, DBBC development, and DBBC project leader.

Michael Wunderlich - engineer, development and testing of DBBC components.

4 Status

Experiments: In 2014 the Bonn group correlated 42 R1, six EURO, three T2, five OHIG, 47 INT3 experiments, and astronomical sessions (including 1 mm, 3 mm, RadioAstron and astrometric projects).

Moreover, the correlation of the 15 CONT14 observations was carried out in Bonn. The routine activities

of the Bonn correlator were suspended for about two months to process the CONT14. All other data transfers to Bonn had been suspended during the CONT campaign to allow the nine e-VLBI stations to transfer their data without interruption. A total of 192.5 TB of data have been e-transferred to Bonn. Thanks to the cooperation of the astronomy cluster users and in collaboration with the institute's computer division, it was possible to obtain a temporary buffer of 230 TB additional storage space for emergency cases (e.g., playback problems with disk packs) for the duration of the processing.

e-VLBI: The total disk space available for geodetic e-transfer data storage at the correlator is about 170 TB.

On average $\geq 90\%$ of the stations do e-transfer. The average amount of e-transferred data per week is about 10 TB, considering only the regular INT3 and R1 experiments. Most transfers are done using the UDP-based Tsunami protocol, and the achieved data rates range from 100 Mb/s to 800 Mb/s. The upgrade of the 1 Gbps Internet connection to meet the requirements of VLBI2010 Global Observing System (VGOS) has not been realized yet — still due to funding issues and apparently bureaucratic obstacles.

DiFX software correlator: The DiFX software correlator has been operated in Bonn since 2009 and is updated regularly. The stable DiFX release 2.3 was installed in 2014. The Mark 5A/B/C control software “jive5ab”, which was developed at the Joint Institute for VLBI in Europe (JIVE), was installed on the cluster and the Mark 5 units in preparation for future more automated e-transfers. Jive5ab can be used as a full replacement of MIT Haystack's control programs Mark 5A, DiMino, and drs. The installation on the Mark 5 units was tested initially by copying data from RAID onto modules in order to free up storage space in preparation for the CONT14.

Two other branch versions of the DiFX software correlator are available in Bonn: a DiFX version for RFI mitigation, developed by J. Wagner, now at KASI, and a DiFX version dedicated to RadioAstron, developed by J. Anderson, now at GFZ Potsdam.

DBBC: The Bonn group is involved in the development and testing of the DBBC VLBI backends and ancillary parts (ex. FILA10G) for the European VLBI Network (EVN) and geodesy. The DBBC2 is designed as a full replacement for the existing VLBI terminals and includes additional features. Stations such as for instance APEX, Pico Veleta, AuScope (Australia),

HartRAO (Africa), and a large part of EVN have ordered one or more DBBC2s. The FILA10G, VLBI to 10GE interfaces have also been exported to Haystack and Korean stations.

The next generation DBBC (DBBC3-L) is being developed, and two prototypes are being integrated and tested. The BBC3-L can handle a larger bandwidth of 4 GHz for each IF/polarization. A maximum of eight IFs can be processed by a single DBBC3-L, so a dedicated variant of the modular system can also be used as a complete VGOS backend at 32 or 64 Gbps, covering the full RF range up to 16 GHz.

APEX: The Bonn VLBI group has equipped the APEX telescope for VLBI observations at 1 mm. In 2013, APEX conducted its first scientific observations by taking part in the Event Horizon Telescope (EHT) campaign. Observations were carried out at 4 Gbps, lasted about 50 hours, and provided good detections for several sources including Sgr A* and M87.

In late 2014, upgrades were prepared and were installed in January 2015: two Mark 6 recorders, a temporary R2DBE on loan (2 GHz sampled bandwidth, 8 Gbps output), and a DBBC firmware upgrade for sampling 2x 1 GHz bandwidth (8 Gbps output) with 62.5 MHz-wide polyphase filter channels to match ALMA. APEX was the partner station for first-fringe tests with the phased ALMA and the South Pole Telescope in January 2015.

RadioAstron: Data from 13 global+RadioAstron experiments were transferred to Bonn until July 2014, the end of the AO-1 observing period. Since January 2015, two other experiments are being e-transferred to Bonn for the AO-2 observations. The correlation of the three key science projects based in Bonn is on-going, and six experiments were finalized in 2014. Raw data are routinely transferred to ASC (Moscow) via the Internet or HDD for backup purposes.

5 Outlook for 2015

DiFX Correlator: The present cluster used for correlation is now about seven years old. A proposal to the Max Planck Society for a new cluster was awarded for about 500 k€ and a new cluster with more than 1000 compute cores will be installed in the second quarter of 2015. Six full Mark 6 units (32 Gbps) have been procured for the correlator and will be mounted in racks

after refurbishment of the present location of the Mark 5 units.

DiFX for RadioAstron: Merging of the RadioAstron DiFX branch version with the current trunk version of the DiFX is ongoing.

e-VLBI: Another 80 TB RAID will be purchased for geodetic e-transfers.

The jive5ab software will be tested for e-transfers, as we are planning to cooperate with JIVE in developing an automatic e-VLBI data transfer controlled by software at the correlator. In addition to enhanced computer security this will allow us to optimize the usage of our Internet connection. This is absolutely essential in cases where more than ten e-transfer stations take part in the weekly R1 experiments and when observations will be performed with higher data rates in the future.

DBBC: We will continue our support for the DBBC2 in the field. New wide bandwidth modes for the DBBC2 are under test. The development work on the DBBC3 will continue, and new wideband modes will be implemented.

Phasing up ALMA: The group is involved in an international project to add array phasing capability to ALMA. ALMA will record with a data rate of up to 64 Gbps, thus being an extremely sensitive station for participation in VLBI experiments at the 3 mm and 1 mm wavelengths. The correlation of 3 mm data will be done in Bonn. Correlation of 1 mm experiments will be handled in a shared effort between Bonn and the Haystack group.

The group made contributions in the phasing algorithm and in linear-to-circular polarization conversion. The first VLBI fringe test experiment was observed January 2015 on the baseline APEX-ALMA with up to 40 antennas phased.

Haystack Observatory VLBI Correlator

Mike Titus, Roger Cappallo, Brian Corey, Kevin Dudevoir, Arthur Niell, Jason SooHoo, Alan Whitney

Abstract This report summarizes the activities at the Haystack Correlator during 2014. Highlights include significant improvements in smoothing of operations through testing for best performance, fixing of operational bugs or problems, and the addition of new machines. Many broadband tests were also conducted, and the processing of the EHT March 2013 run continued, along with testing to prepare for new EHT observations in March 2015. Non-real-time e-VLBI transfers and DiFX and HOPS software support for other correlators continued.

1 Introduction

The DiFX VLBI correlator of the MIT Haystack Observatory, located in Westford, Massachusetts, is supported by the NASA Space Geodesy Program and the National Science Foundation. It is dedicated mainly to the pursuits of the IVS, with a smaller fraction of time allocated to processing radio astronomy observations for the Event Horizon Telescope (EHT) project. The Haystack correlator serves as a development system for testing new correlation modes, such as those needed for the VGOS observations, and for recorder developments, such as the Mark 6 system. Some software support is provided to similar DiFX installations at the U.S. Naval Observatory, to the Max Planck Institute for Radioastronomy in Bonn, Germany, and to the

MIT Haystack Observatory

Haystack Correlator

IVS 2014 Annual Report

general IVS community for DiFX processing of IVS experiments.

2 Summary of Activities

2.1 DiFX Cluster Developments

Another data server with 60 TB of storage space was added to the available pool for storing incoming e-VLBI-transferred data, raising the total to ~ 200 TB. Another compute server was added as well with the intention for it to become the master node. Over the last year, equipment that was used exclusively by the Mark IV was removed. Consolidation of Mark 5B Playback units (PBUs) and re-arrangement of equipment in racks has been an ongoing effort.

2.2 DiFX Production Improvements and Fixes

Efficiency has greatly improved over the last year through the smoothing of operations. This can be attributed to software development, such as modifying DiFX programs, e.g. 'startdifx', for more effective use with Haystack's particular installation, and studying and optimizing maximum throughput methods given our cluster setup. One example is distributing station file data to separate file servers and playing back some stations from modules in order to spread the I/O load. As a result, the correlator runs with virtually no backlog attributable to throughput limitations. Also, some seriously debilitating bugs were identified and

either fixed or patched around. Examples include problems processing Mark 5B data from modules (mark5bfix -1 problem discovered in DiFX version 2.3 and the trunk) and a problem with difx2fits handling polarization data coming from the EHT processing.

2.3 Broadband Delay

Numerous tests have been performed. In April the first test using RDBE firmware version 3.0 and complex format data was conducted. It was a success. Following that were two GGAO phase calibration tests, then a hiatus until October when an explosion of GGAO—Westford broadband tests began. Tests in October—November, which were designed to study different aspects of the broadband system, included setting all four UDCs at both stations to the same frequency to see how well the VLBI results compared between systems; stepping the UDCs in frequency to measure fringe amplitudes over 2.2—11.5 GHz; varying the power level into the RDBEs to test for level sensitivity in the VLBI results; and observing 4C39.25 using the channel select mode with minimum redundancy spacing and bands spanning 3.0—10.7 GHz. Then finally, two one-hour geodetic mode schedules were run using the setup described in the previous test. Mixed mode development for experiment RD1301 also continued.

2.4 DBE Testing

Testing of RDBE firmware version 3.0 and complex/VDIF format occurred as mentioned above. This configuration is now used in all broadband sessions. A newly designed ROACH-2 digital back end (R2DBE) and ancillary equipment, developed at the Harvard-Smithsonian Center for Astrophysics for the EHT project, were tested on the GGAO—Westford baseline in September. These equipment tests produced good fringes between the RDBE system recording 512 MHz of bandwidth vs. the R2DBE recording 2 GHz bandwidth. The recordings were cross-correlated using zoom mode in DiFX.

2.5 Mark 6

Another Mark 6 playback unit was added to the cluster, and use of Mark 6 has begun in the VGOS and EHT projects. In particular, all VGOS tests since January 2014 have used the Mark 6 recording system, as did the R2DBE tests described above.

2.6 Galactic Center Observations

Re-processing of the March 2013 EHT campaign on DiFX continues in order to compare it with the Mark IV correlator and to add the APEX station for which fringes were found much later. Also 3 mm tests of the LMT antenna and lab tests of R2DBEs and other South Pole telescope equipment were conducted as mentioned above.

2.7 Sejong Fringe Test

A fringe test was conducted using Hobart, Sheshan, and Sejong in order to commission the new antenna at Sejong, Korea, for routine IVS use. Results were good, and Sejong now participates in regular IVS sessions.

2.8 DSS-13 DVP Data Decoding

JPL designed and observed with a new digital back end, called the DVP, which recorded data in a different format than other DBE systems. DSS-13 used this system in the T2 experiments. Extensive effort was put into deciphering the setup of the station, which had configuration problems, and as a result good fringes were obtained.

2.9 DiFX Software Support

Support for the community continues for difx2mark4, fourfit, and HOPS. This support includes addition of features requested by users, other enhancements, and bug fixes.

2.10 e-VLBI

Non-real-time transfers have continued. Data from twenty sessions were transferred to Haystack this year from twenty-six stations: eight in Japan (Kashima34, Kashima11, Koganei, Tsukuba, Chichijima, Ishigaki, Aira, and Mizusawa), one in central Asia (Badary), eight in Europe (Simeiz, Svetloe, Zelenchukskaya, Onsala, Ny-Ålesund, Yebes, Wettzell, and Noto), three in Australia (Hobart, Yarragadee, and Katherine), one in New Zealand (Warkworth) two in South America (Fortaleza and Concepción (via Bonn)), two in South Africa (Hart15M and HartRAO) and one in Korea (Sejong). The number of e-VLBI transfer stations increased by six this year due to the addition of Yebes, Sejong, Simeiz, Badary, Svetloe, and Zelenchukskaya.

3 Experiments Correlated

In 2014, thirty-seven geodetic VLBI sessions were processed, at least in part, consisting of fourteen R&Ds, six T2s, and seventeen tests of various types. The test sessions included the broadband sessions and fringe tests and an assortment of other projects, some of which were touched on in the summary above. As usual, smaller tests were not included in the above count because they were too small to warrant individual experiment numbers. All production and test experiments were done on the DiFX cluster.

4 Current/Future Hardware and Capabilities

The DiFX cluster currently consists of six PCs, each with dual hex core 2.66 GHz Intel Xeon processors. Three file storage servers, which can also act as DiFX compute nodes, provide 200 TB of file storage. These are all connected through a 40 Gb/sec infiniband network fabric using a Qlogic switch. Currently six Mark 5B and two Mark 6 playback units with DiFX fully installed are connected to the infiniband fabric. We have processed up to 18 stations in one pass with this setup through a combination of playback units and files.

A large expansion of hardware capability is imminent. The addition of 16 computer servers, 40GigE eth-

ernet fabric and more Mark 6 PBUs is planned, with all mentioned equipment either already in-house or their purchases pending.

5 Staff

Staff who participated in aspects of Mark IV, DiFX, Mark 5/6, and e-VLBI development and operations include:

5.1 Software Development Team

- Roger Cappallo - post processing; Mark 5B and 6; correlator software integration and troubleshooting; DiFX correlator development
- Geoff Crew - DiFX correlator development, post processing software; Mark 6
- Kevin Dudevoir - correlation; maintenance/support; Mark 5A/5B/5C; e-VLBI; computer system support/development; DiFX correlator development
- Jason SooHoo - e-VLBI; Mark 5A/5B/5C/6; computer system support
- Chester Ruszczyk - e-VLBI; Mark 5A/5B/5C/6
- Alan Whitney - system architecture; Mark 5A/5B/5C/6; e-VLBI

5.2 Operations Team

- Peter Bolis - correlator maintenance
- Alex Burns - playback drive maintenance; Mark 5/6 installation and maintenance; general technical support
- Brian Corey - experiment correlation oversight; station evaluation; technique development
- Dave Fields - filling in for Alex Burns while he takes a leave of absence at Ny-Ålesund (previously retired)
- Glenn Millson - correlator operator
- Arthur Niell - technique development
- Don Sousa - correlator operator; experiment setup; tape library and shipping

- Mike Titus - correlator operations oversight; experiment setup; computer services; software and hardware testing
- Ken Wilson - correlator maintenance; playback drive maintenance; general technical support

6 Conclusion/Outlook

A large expansion in compute servers and Mark 6 recorders is already underway. Broadband geodetic sessions at more regular intervals will be scheduled and processed in the near future and beyond that will include the addition of the new Kokee 12-m antenna with a new broadband system. EHT observations in March 2015 will also be a large processing load. Routine geodetic processing will continue as well.

IAA Correlator Center 2014 Annual Report

Igor Surkis, Voytsekh Ken, Yana Kurdubova, Alexey Melnikov, Vladimir Mishin, Nadezda Mishina, Violet Shantyr, Vladimir Zimovsky

Abstract The activities of the six-station IAA RAS correlator include the regular processing of national geodetic VLBI programs Ru-E, Ru-U (R-I), and Ru-F. The Ru-U (R-I) sessions have been transferred to the IAA Correlator Center automatically in e-VLBI mode and correlated there since 2011. The new six-station FX correlator's HPC was developed and mounted at IAA.

1 Introduction

The IAA Correlator Center is situated at St.-Petersburg, Russia and maintained by the Institute of Applied Astronomy in Russia.

The main goal of the IAA Correlator Center is processing geodetic, astrometric, and astrophysical observations made with the Russian national VLBI network Quasar.

2 Component Description

The ARC (Astrometric Radiointerferometric Correlator) (Figure 1) was the main data processing instrument at the IAA Correlator Center in 2014. The ARC was designed and built at the IAA RAS in 2007 - 2009. The correlator is XF-type and is based on FPGA technology.

Institute of Applied Astronomy RAS

Institute of Applied Astronomy Correlator

IVS 2014 Annual Report

The ARC is a six-station 15-baseline correlator. It is able to process up to 16 frequency channels on each baseline for a total of 240 channels. The correlator is able to handle two-bit VLBI signals with 32 MHz maximum clock frequency. The maximum data rate from each station is 1 Gbit per second. The correlator uses VSI-H input signals, and it is equipped with Mark 5B playback systems.

Since 2011, the DiFX software correlator has been used in some astrophysical experiments. DiFX is installed at the IAA on a Sun Fire X4450 Server as a virtual machine under the VMware.

Since 2012 the six-station software FX VGOS GPU-based near-real time correlator has been under design. First fringes were obtained.



Fig. 1 View of the six-station ARC correlator, showing four racks containing (left to right) signal distribution and synchronization system (SDSS) and three Mark 5B playback units, two correlator crates and a KVM, three correlator crates, and one more cabinet with an SDSS and three Mark 5B playback units.

3 Current Status and Activities

The ARC correlator was used for processing of all the national geodetic VLBI observations at the IAA Correlator Center in 2014. The RUE and RUU (R-I) geodetic VLBI sessions were observed at IAA RAS.

The three-station 24-hour RUE sessions for EOP determination were observed one time per week, as in 2013.

The two-station one-hour sessions for UT1-UTC determination in e-VLBI mode were observed once a day. The RUU (R-I) sessions setup was the following: frequency channel bandwidth of 8 MHz and total bitrate of 256 Mbps. The data transfer rate from stations to correlator was increased in 2012, and near-realtime correlation processing with a data bitrate of 256 Mbps was achieved.

The DiFX software correlator continued to be the main tool for processing spectral line sources for VLBI in 2014. Several 2-Gbps tests with new broadband acquisition system BRAS were done, and data were processed with DiFX. Twenty-seven Ru-P low data rate experiments were scheduled, observed, and processed with high spectral resolution. The HartRao station joined the Ru-P Orion KL observations, and data were transferred from South Africa to Saint-Petersburg using the Tsunami protocol. During 2014, several wideband test experiments were carried out. DiFX was used to get first fringes in these experiments. DiFX copies are installed on three GNU/Linux VMware virtual machines at a Sun Fire X4450 Server and at a new hybrid-blade cluster. Wideband experiments were processed using cluster DiFX installation. Running at 60 cluster cores, DiFX is more than 50 times faster than DiFX on a four-core virtual machine.

4 FX Correlator Design

The design of a new FX software correlator intended for the new small antenna VLBI network was started in 2012. The correlator design is supposed to process a data stream of up to 16 Gbps from each observatory. VLBI data are recorded from four frequency bands with bandwidths of up to 1024 MHz in one circular polarization or up to 512 MHz in two linear polarizations using 2-bit sampling. The input data format is VDIF.

The correlator computes cross-spectra with a resolution of up to 4,096 spectral channels and extracts up to 32 phase calibration tones in each frequency band of each station in near-real time.

We have developed six-station correlator software in 2014. In cooperation with the company “T-Platforms”, the high-performance computing cluster (Figure 2) was mounted at IAA.



Fig. 2 View of the high-performance computing cluster based on the hybrid blade servers.

The correlator’s hardware is based on hybrid blade server technology. Each blade server contains two Intel CPU and two Nvidia Tesla K20 GPUs and 64 GB RAM. The present hardware contains 32 blade servers, which are mounted into seven chassis. These servers are used for FX data processing algorithms (doppler tracking, FFT, and spectra multiplication) computing. Also the HPC contains eight 19-inch servers; each of them provides data receiving operation, pcal extraction, delay tracking, and bit repacking. These servers are equipped with two GPUs, 256 GB RAM and 2x10 Gb fiber optic input. Data storage is based on Panasas with 80 TB capacity. The interblock data communication is provided by infiniband network. Cluster components are mounted on four racks.

In the end of 2014, the two-station Ru0108 series was processed. All fringes were obtained.

The six-station benchmark tests with a 96 Gbps input data stream were performed. The 16 Gbps data stream from each station consisted of four bands and two polarizations. 312 spectra total (78 spectra in each band) with 4,096 frequency points each were calculated in near to real time. The results showed that our algorithms require 80 Tesla K20 GPUs for near-real time processing.

The next year will be devoted to upgrading our GPU software according to new CUDA specifications, developing post-processing software, and developing GUI software.

5 Staff

- Igor Surkis — leading investigator, software developer;
- Voytsekh Ken — GPU software developer;
- Alexey Melnikov — DiFX processing, scheduler of the Ru-sessions;
- Vladimir Mishin — software developer, data processing;
- Nadezhda Mishina — software developer;
- Yana Kurdubova — software developer;
- Dmitry Pavlov — software developer;
- Violet Shantyr — software developer, post processing;
- Vladimir Zimovsky — leading data processing;
- Ekaterina Medvedeva — data processing;
- Alexander Salnikov — leading e-VLBI data transferring; and
- Ilya Bezrukov — e-VLBI data transferring.

Shanghai VLBI Correlator

Fengchun Shu, Weimin Zheng, Wu Jiang, Zhong Chen, Renjie Zhu

Abstract This report summarizes the activities of the Shanghai VLBI Correlator during 2014. Highlights include the commissioning of DiFX correlation, fringe tests for Tianma65, e-VLBI connection with international stations, and validation of 512 MHz bandwidth observations.

1 Introduction

The Shanghai VLBI Correlator is hosted and operated by the Shanghai Astronomical Observatory (SHAO), Chinese Academy of Sciences. It is located on the She-shan campus, about 40 kilometers from the Xujiahui headquarters of SHAO. The Shanghai correlator plays a leading role in the data processing of the Chinese domestic VLBI observing programs, inclusive of the CMONOC project for monitoring the Chinese regional crustal movement, and the Chinese deep space exploration project for spacecraft tracking.

As shown in Figure 1, Shanghai (including She-shan25 and Tianma65), Kunming, and Urumqi participate in some domestic geodetic and astronomical sessions, while the Beijing station is mainly used for spacecraft data downlink and VLBI tracking. A few joint observations with the Chinese deep space stations Kashi and Jiamus were also performed.

In order to contribute more to the international VLBI community and to meet the requirements of more domestic astronomical VLBI experiments, we

imported the DiFX correlator in recent years. The Shanghai correlator was accepted as an IVS correlator in March 2012. It will become operational for IVS data correlation in 2015.

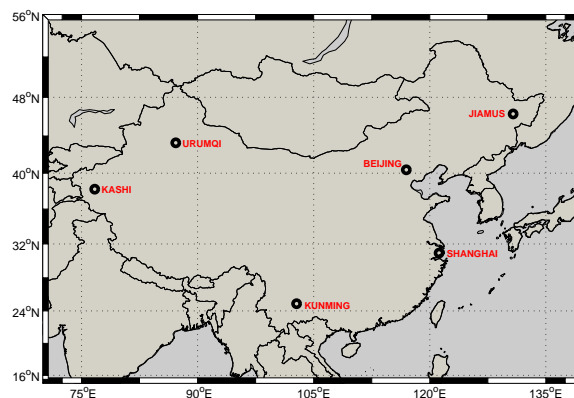

Fig. 1 Distribution of the VLBI stations in China.

2 Component Description

We are operating two types of correlators. The correlator developed by our own staff has been operational since 2006. It is mainly used for spacecraft VLBI tracking in the Chang'E lunar exploration project by producing differential VLBI observables. The data latency is less than one minute in real time mode, and the typical accuracy is better than 1 ns. It is also used to correlate a few tens of CMONOC geodetic sessions by producing NGS card files which will be made public very soon. The other correlator is the DiFX correlator, which is

Shanghai Astronomical Observatory

Shanghai Correlator

IVS 2014 Annual Report

dedicated to astrophysical and geodetic data correlation.

By the end of 2014, the former 60 core DiFX platform was expanded to a 420 core cluster system (Figure 2). The storage space was also increased to 430 TB. The new platform is very important for IVS data correlation. In the routine operations, half of the computing and the storage sources are assigned to the geodetic correlation tasks. Features of the DiFX cluster system are listed as follows:

- DiFX 2.2/2.3/trunk, HOPS 3.9/3.10
- Head nodes: DELL R820 (E5-4610 CPU, 2.4 GHz, 2*6 cores), 64 GB Memory, DELL R730 (E5-2623 CPU, 3.0 GHz, 2*4 cores), 64 GB Memory.
- Computing nodes: 20 DELL R630 nodes, two socket Intel E5-2660 CPU (2.6 GHz, ten cores), 64 GB Memory, 400 cores in total
- I/O nodes: RAID6, 432 TB raw storage capacity
- Mark 5 units: three Mark 5A and three Mark 5B.
- 56 G Infiniband for internal computing network connection
- 1/10 G Ethernet for internal and external network connection

- Weimin Zheng: group head, software correlator development
- Xiuzhong Zhang: CDAS and other technique development
- Fengchun Shu: scheduler, experiment oversight, CDAS evaluation
- Zhong Chen: e-VLBI, cluster administration
- Wu Jiang: DiFX operation, experiment support
- Tianyu Jiang: DiFX operation, experiment support
- Weihua Wang: lead correlator operator, automatic correlation process development
- Wenbin Wang: operator, experiment support
- Zhaobao Jiang: media library, computer services
- Renjie Zhu: CDAS development
- Zhijun Xu: FPGA programming, hardware correlator development
- Yajun Wu: FPGA programming
- Juan Zhang: correlator software development and maintenance
- Li Tong: correlator software development and maintenance
- Lei Liu: post-doctoral fellow, correlator software development



Fig. 2 DiFX cluster system and Mark 5A/B units.

3 Staff

The people involved in the development and operation of the Shanghai Correlator are listed below.

4 Summary of Activities

4.1 DiFX Correlation

With the help of the Bonn Correlator and the GSFC group, we have obtained some experience in using DiFX, HOPS, and Ddebit to generate Mark IV database files. As mentioned above, a new DiFX cluster system was installed and tested in December 2014 in preparation for IVS data correlation.

In order to make the correlation results reliable, we also made a comparison with Bonn on the four-station (NyShTsWz) INT3 session K14349. Although the two correlators used different parameter configurations, the total delay observables can be used for comparisons. The database generated by the Shanghai Correlator has been analyzed with nuSolve by Minghui Xu. Some data solution statistics for comparison against the IVS result¹ can be found in Table 1. Our results have an additional bad point 2014-12-15 UT 7h12m49s on

¹ Please see <http://lupus.gsfc.nasa.gov/data10/sessions/2014/k14349/k14349-analyst.txt>

NYALES20-SESHAN25. We suspect we lost a little data from Seshan25 when copying from the original Mark 5 module. We compared 141 common points used in the solutions. The mean value of the X-band group delay differences is 0.9 ps, and the RMS is 9 ps, while the mean value of the S-band group delay differences is 10.7 ps, and the RMS is 58 ps. The comparison shows that there are two points with group delay differences greater than 20 ps at X-band and five points with differences greater than 100 ps at S-band. As shown in Figure 3, we plotted the histogram after the removal of the seven points with big differences mentioned above.

Table 1 Statistics on UT1 solutions with data from the Bonn and the Shanghai correlators.

	Bonn	Shanghai
Number of observations scheduled	180	180
Number of observations correlated	169	169
Number of observations used	142	141
WRMS delay residual (ps)	42.7	41.6
UT1 formal error (μ s)	8.87	8.99

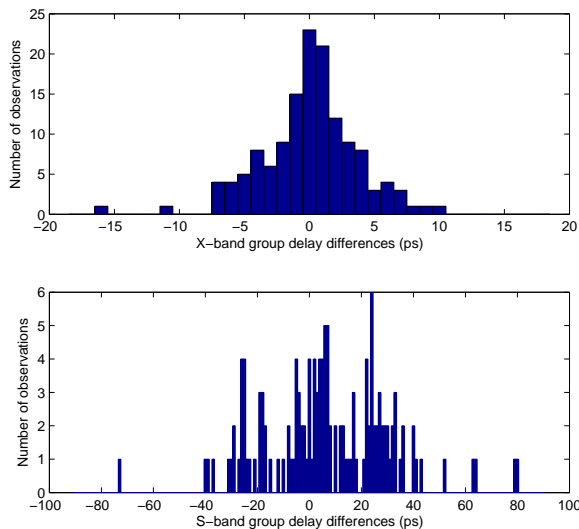

Fig. 3 Histogram for group delay differences produced by the Bonn and the Shanghai correlators.

4.2 Fringe Tests for Tianma65

In order to bring Tianma65 online for VLBI astrometry, we have been conducting a series of fringe tests since 2013. We finally received good fringes for a standard wideband S/X sequence on the Tianma65-Seshan25 baseline on March 24. As a result, Tianma65 participated in R1637 in May and in RD1404 in June. With its high sensitivity, Tianma65 is able to improve the total observations of an array and the detection of weak sources, which is important for radio-optical frame connection and densification of the ICRF.

4.3 e-VLBI

The network link to Seshan25 and Tianma65 is 10 Gbps. The network link to the Urumqi, Kunming, and Beijing stations is 155 Mbps for domestic e-VLBI observations. In the Chang'E-5T1 lunar mission beginning in October 2014, the data transfer performed well at 64 Mbps for each station.

In order to process IVS global sessions in 2015, we established the network link to Kashima, Sejong, Hobart, Noto, HartRAO, Fortaleza, and the Bonn Correlator. The maximum data rate is 1 Gbps. More stations involved in the CRF and APSG sessions will be connected to Shanghai.

4.4 Performance of CDAS

The Chinese VLBI Data Acquisition System (CDAS) is a type of digital backend designed to replace the traditional analog BBCs. The new digital system has better bandpass and wider bandwidth. In 2014, we successfully upgraded the CDAS at Kunming, so it can now observe standard wideband S/X sequences such as in CRF and R&D sessions.

In addition to the DDC version currently being used, we are also developing a PFB version of CDAS with much more of a compact design. It contains two Xilinx K7 FPGAs for data processing. The input signals are from two IFs with 512 MHz bandwidth each or one IF with 1024 MHz bandwidth. Compared with the previous platform, which consists of four Xilinx V4 FPGAs, the new one not only updated the key chips for

DSP but also added two TenGiga Ethernet SFP+ ports for data transmission. For the application, the PFB version can be configured with 32 MHz bandwidth x 16 channels and 64 MHz bandwidth x 16 channels.

4.5 Development of Correlator Technique

Aimed at the parallel data processing of two spacecraft in the Chang'E-5 mission, which was scheduled to be launched in 2017, our own real time correlator systems are undergoing a major upgrade.

4.6 VEPS

The VEPS (VLBI Ecliptic Plane Survey) project submitted to the NSFC (Natural Science Foundation of China) has been funded with a four-year term from 2014 to 2017. In the first phase we planned to observe approximately 2,000 radio sources along the ecliptic with the total flux greater than 0.1 Jy by VLBI for the first time. The 512 MHz bandwidth observing mode with 32 MHz bandwidth x 16 channels at wide X-band can be provided by CDAS and K5 backend. The fringes have been obtained with Sheshan25, Kunming, Urumqi, Tianma65, and Sejong. The last two stations will be backup stations for VEPS.

4.7 Experiments Correlated

In 2014, only two domestic geodetic VLBI experiments were carried out due to limited available time of Urumqi and the launch of the Chang'E-5T1 mission. After the Mark 5 modules were shipped to Shanghai, the data correlations were done by both the domestic correlator and the DiFX correlator. The output of the DiFX correlator was further processed with HOPS.

The differential VLBI observations were conducted frequently to support the navigation of the Chang'E-5T1 spacecraft from October 24. The signals transmitted from the spacecraft were received by four Chinese stations and then transferred to Shanghai in e-VLBI mode for data correlation and the extraction of differential VLBI observables within one minute.

4.8 Phase-referencing of Spacecrafts

We have developed offline software to convert our own correlator output into FITS-IDI format since 2013. Based on this type of data, we try to do relative positioning between the rover and lander of Chang'E-3 on the surface of the Moon by using the phase-referencing method, and we get accuracy at the level of a meter. Now, we are trying to do spacecraft positioning (CE-5T1, MEX, et al.) with respect to the extragalactic radio sources by using the phase-referencing method, and we have gotten some preliminary results.

4.9 IVS GM2014

The eighth IVS General Meeting was held March 2-7, 2014 in Shanghai, China. The keynote of the eighth General Meeting is the establishment of the VGOS (VLBI Global Observing System) network under the theme "VGOS: The New VLBI Network". Fengchun Shu served as a member of the program committee, and Weimin Zheng served as the chair of the local organizing committee. During the meeting, an excursion was arranged to visit the VLBI data processing center equipped with the correlator, the Tianma Radio Telescope, the Sheshan 25-m antenna, and the Shanghai Astronomical Museum. The local organizing work was basically done by our group.

5 Future Plans

We will begin to correlate a few international VLBI sessions coordinated by the IVS in 2015 and we will ensure that the final results are reliable and convinced by making comparisons with other IVS correlators. We will continue to support the data correlation of the Chinese domestic VLBI observations. Considering that we have already submitted a correlator upgrade proposal for VGOS correlation, we are also interested in getting some real VGOS data for trial correlation.

Tsukuba VLBI Correlator

Shinobu Kurihara ¹, Tetsuya Hara ^{1,2}

Abstract This report summarizes the activities of the Tsukuba VLBI Correlator during 2014. The weekend IVS Intensive (INT2) and the Japanese domestic VLBI observations (JADE) were regularly processed using the K5/VSSP correlation software.

1 Introduction

The Tsukuba VLBI Correlator, located in Tsukuba, Japan, is hosted and operated by the Geospatial Information Authority of Japan (GSI). It is fully devoted to processing geodetic VLBI observations of the International VLBI Service for Geodesy and Astrometry (IVS). All of the weekend IVS Intensive (INT2) for UT1-UTC (= dUT1) determination and the Japanese domestic VLBI observations for geodesy called JADE organized by GSI were processed at the Tsukuba VLBI Correlator. The K5/VSSP correlation software developed by the National Institute of Information and Communications Technology (NICT) is used for all processing.

1. Geospatial Information Authority of Japan

2. Advanced Engineering Service Co., Ltd.

Tsukuba VLBI Correlator

IVS 2014 Annual Report

2 Component Description

2.1 e-VLBI

The Tsukuba VLBI Correlator has been connected to a broadband network, and most of observed VLBI data is delivered via the network. The Tsukuba VLBI Correlator has a 10 Gbps dedicated link to the SINET4 operated by the National Institute of Informatics (NII), which is connected to some research networks in the world such as Internet2 in the U.S., GÉANT2 in Europe, and TEIN4 at Singapore. It enabled us to transfer massive amounts of data between the Tsukuba VLBI Correlator and the overseas IVS Components. In March, the Ishioka VGOS Station was also connected to the Tsukuba VLBI Correlator and SINET4 with a 10 Gbps dedicated cable.

2.2 K5/VSSP Correlation Software

The K5/VSSP correlation software consists of several programs for the calculation of a priori values of delay and delay rate (*apri_calc*), for the correlation processing for all observations (*fx_cor* or *cor*), and for monitoring the results of the correlation processing by performing a so-called “coarse search” (*sdelay*), following several utilities such as *Komb* for bandwidth synthesis [1]. All of these programs were developed and have been maintained by NICT. The K5/VSSP correlation software can be used not only for K5 data processing but also for the Mark 5 data processing by using the data format conversion program (*m5tok5*).

Table 1 Correlator Hardware Capabilities.

	Main system	Second System
Number of servers	16 - 14 for correlation processing - two for controlling correlation processing	44 - 16 for correlation processing - two for controlling correlation processing - 26 for data storage
Operating System	Red Hat Enterprise Linux 6.3	CentOS version 5.5
CPU	Intel Xeon X5687 @3.60GHz quad CPU x 2	Intel Xeon X3360 @2.83 GHz quad CPU Intel Xeon 5160 @3.00 GHz dual CPU x 2 Intel Xeon X3480 @3.07 GHz quad CPU Intel Xeon @3.80 GHz CPU x 2
Total storage capacity	Data Direct Networks storage: 513 Tbytes	Lustre File System: 30 Tbytes
Network	10 Gbps dedicated line connected to SINET4 by NII	

The following are processes of the K5 correlation and programs used in each process:

1. Transferring data from network stations to the correlator (*tsunami* and *tsunamid*).
2. Data format conversion from Mark 5 to K5 (*m5tok5* or *m5btok5*).
3. Preparation of a priori parameter files (*apri_calc*).
4. Fringe search to find a clock offset at each pair of stations (*fx_cor* or *cor*).
5. Running correlation processing for all observations (*fx_cor* or *cor*).
6. Coarse search for estimating residual delay and delay rate, and plotting them on a 3-D diagram (*sdelay*).
7. Bandwidth synthesis to derive a multi-band delay (*komb*), and making Mark III databases by *MK3TOOLS* to be submitted to the IVS Data Center.

The correlation and analysis management programs developed by GSI can run the above processes consecutively and ultra-rapidly. The program for the management of data transfer *rapid_transfer* accesses a data server in an observing station, executes *tsunamid* there, and then executes *tsunami* to transfer data automatically at the correlator side when an observation starts. The data is converted from Mark 5 to K5 format by a program *rapid_conv* as necessary. *Rapid_cor* is a program to search for a fringe for each baseline according to the clock information of each station written in the FS log. Once the fringe is detected, the main correlation processing is run sequentially with the clock offset and rate found in the fringe search until the last observation. *Rapid_komb* executes *komb* one after another for bandwidth synthesis process. The fully automated VLBI analysis software *c5++* developed by NICT can

read the *komb* output files directly and derives a VLBI solution [2]. *Rapid_c5pp*, which gives a *c5++* interface, makes a configuration file for *c5++* automatically and executes analysis.

2.3 Correlator Hardware Capabilities

The hardware supporting the activities of the Tsukuba VLBI Correlator is summarized in Table 1. All of these pieces of equipment are general purpose and commercially available products. It means that no dedicated hardware is required in the K5 correlation processing. In 2014, IBM System X3650 servers and a Data Direct Networks storage system with a capacity of 513 TB were incorporated into the main correlation processing (Figure 1). It shortens correlation time by half. The existing system is also available as the second processing system (Figure 2). There was no other hardware modification in this year.

3 Staff

The technical staff at the Tsukuba VLBI Correlator are:

- **Shinobu Kurihara** — correlator/analysis chief, management.
- **Tetsuya Hara** (AES) — correlator/analysis operator, software development.



Fig. 1 View of the data processing servers and storage system at the Tsukuba VLBI Correlator.

4 Correlator Operations

4.1 IVS Intensives for UT1-UTC

In 2014, 106 Intensive sessions that were observed on weekends in total were processed at the Tsukuba Correlator. The details are described in Table 2. The observed data at Wettzell is transferred to the Tsukuba Correlator in near real-time with the Tsunami UDP protocol and is converted to the K5 format immediately. The observed data at the Tsukuba station is also transferred to the correlator at once. The whole process from data transfer through analysis is implemented by the *rapid_* programs (see Section 2.2), and a dUT1 solution of the Tsukuba–Wettzell baseline can be derived within a few minutes after the end of the last scan of the session.

Table 2 Intensive sessions processed at the Tsukuba Correlator. One session K14040 on February 9 was canceled and not processed due to heavy snow at the Tsukuba Station.

	Baseline	Period	# of sessions
Intensive 2	TsWz	Jan 04 – Dec 28	101
	KkWz	Jan 05 – Jan 19	3
	KbWz	Oct 25 – Oct 26	2
Total			106

4.2 JADE and JAXA

JADE is the domestic geodetic VLBI series involving three GSI stations (Tsukuba, Aira, and Chichijima), three NICT stations (Kashima 34-m, Kashima 11-m, and Koganei 11-m), and two VERA stations of the National Astronomical Observatory of Japan (NAOJ) located in Mizusawa and Ishigakijima. Five JADE sessions were correlated in 2014. The JAXA session is separately conducted from JADE including JAXA stations, such as Usuda, in order to determine the global positions of the stations in the ITRF. One JAXA session was processed in this year.



Fig. 2 View of the existing data processing servers.

4.3 Ultra-Rapid dUT1 Experiment

This experiment is the joint project with Sweden, Australia, and South Africa continued since 2007. During five regular IVS 24-hour sessions and CONT14 sessions, the ultra-rapid dUT1 experiments were implemented and processed at Tsukuba Correlator. For details, refer to the report “Tsukuba VLBI Analysis Center” in this volume.

References

1. Kondo, T., et al.: Development of the K5/VSSP System, *Journal of the Geodetic Society of Japan*, **54**(4), 233-248, 2008.
2. Hobiger, T., et al.: Fully automated VLBI analysis with c5++ for ultra-rapid determination of UT1, *Earth Planets Space*, **62**, 933-937, 2010.

5 Outlook

We will continue to process the IVS Intensive sessions. For more stable operation, we will make further improvements to the *rapid_* programs and maintain hardware and network. When the Asia-Oceania VLBI Group for the Geodesy and Astrometry (AOV) coordinates and conducts regional VLBI observations, we will process the observed data and play a major role of a correlator in the Asia-Oceania region.

Washington Correlator

David M Hall, Daniel Veillette

Abstract This report summarizes the activities of the Washington Correlator for the year 2014. The Washington Correlator provides up to 80 hours of attended processing per week plus up to 40 hours of unattended operation, primarily supporting Earth Orientation and astrometric observations.

1 General Information

The Washington Correlator (WACO) is located at and staffed by the U.S. Naval Observatory (USNO) in Washington, DC, USA. The correlator is sponsored and funded by the National Earth Orientation Service (NEOS), which is a joint effort of the USNO and NASA. Dedicated to processing geodetic and astrometric VLBI observations, the facility spent 100 percent of its time on these sessions. All of the weekly IVS-R4 sessions, all of the IVS-INT01 Intensives, and the APSG and CRF sessions were processed at WACO. The facility houses the WACO DiFX correlator.

2 Activities during the Past Year

- The Washington Correlator made the transition from the ageing Mark IV correlator to the new DiFX software correlator. Work to achieve the final configuration of the DiFX correlator, its associated servers, and its network is ongoing.

U. S. Naval Observatory

WACO Correlator

IVS 2014 Annual Report

- The correlator staff continues the testing and repair of Mark 5 modules.
- Intensive observations from Kokee Park and Wettzell were routinely transferred via e-VLBI during 2014. 24-hour sessions from both Hobart antennas, Katherine, Yarragadee, Warkworth, Ny-Ålesund, Fortaleza, Yebes, Noto, HartRAO, Wettzell, Tsukuba, Aira, Kashima, Chichijima, and Sintotu were also transferred by high-speed networks.
- Table 1 lists the experiments processed during 2014.

Table 1 Experiments processed during 2014.

57 IVS-R4 or R1 sessions
9 CRF (Celestial Reference Frame)
222 Intensives

3 Staff

The Washington Correlator is under the management and scientific direction of the Earth Orientation Department of the U.S. Naval Observatory. Table 2 lists staff and their duties.

4 Future Plans

Transition to the DiFX Software correlator took place in October of 2014. Additional work to achieve the fi-

Table 2 Staff.

Staff	Duties
David Hall	Chief VLBI Operations Division
Daniel Veillette	VLBI Correlator Project Manager
Bruce Thornton	Lead Physical Science Technician
Roxanne Inniss	Media Librarian
Maria Davis	Physical Science Technician

nal planned configuration of the DiFX correlator and its associated servers and network is ongoing.

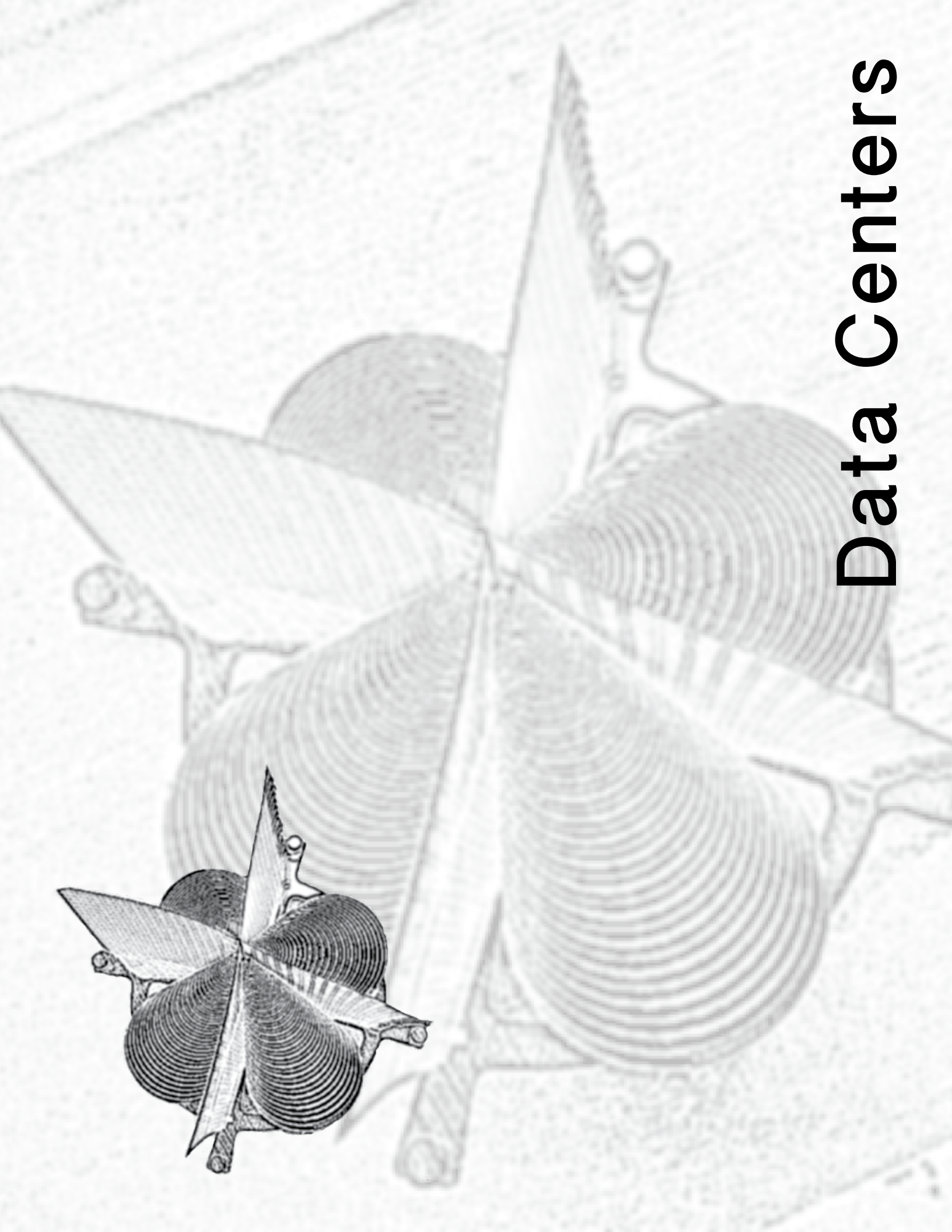
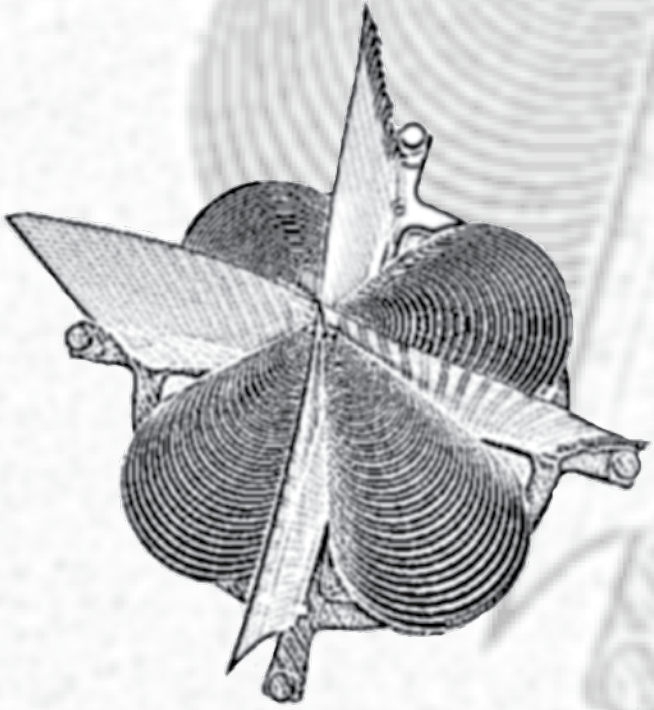

Data Centers

BKG Data Center

Volkmar Thorandt, Reiner Wojdziak

Abstract This report summarizes the activities and background information of the IVS Data Center for the year 2014. Included are information about functions, structure, technical equipment, and staff members of the BKG Data Center.

1 BKG Data Center Functions

The BKG (Federal Agency for Cartography and Geodesy) Data Center is one of the three IVS Primary Data Centers. It archives all VLBI related data of IVS components and provides public access for the community. The BKG Data Center is connected to the OPAR and GSFC CDDIS Data Centers by mirroring the OPAR and the CDDIS file stocks several times per day. The sketch in Figure 1 shows the principle of mirroring.

IVS components can choose one of these Data Centers to put their data into the IVS archives by using its incoming area, which each Data Center has at its disposal. The BKG incoming area is protected, and users need to obtain a username and password to get access.

An incoming script watches the incoming area and checks the syntax of the files sent by IVS components. If it is okay, the script moves the files into the Data Center directories. Otherwise the files will be sent to a bad-file area. Furthermore, the incoming script informs the responsible staff at the Data Center by sending e-mails about its activities. The incoming script is part of the

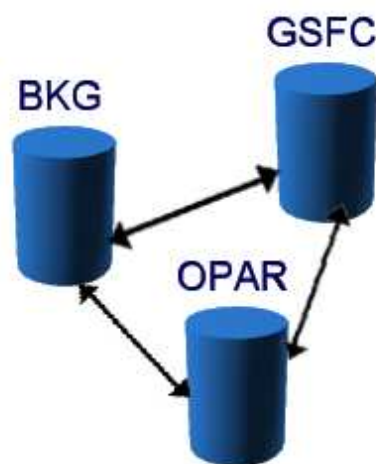

Fig. 1 Principle of mirroring.

technological unit which is responsible for managing the IVS and the Operational Data Center and for carrying out the first analysis steps in an automatic manner. All activities are monitored to guarantee data consistency and to control all analysis steps from data arrival to delivery of analysis products to IVS.

Public access to the BKG Data Center is available through FTP and HTTP:

`ftp://ivs.bkg.bund.de/pub/vlbi/`

`http://ivs.bkg.bund.de/vlbi/`

BKG

BKG Data Center

IVS 2014 Annual Report

Structure of BKG IVS Data Center:

```
vlbi/           : root directory
ITRF2013/       : VLBI solutions for ITRF2013
ivscontrol/     : controlfiles for the data center
ivsdata/        : VLBI observation files
ivsdocuments/   : IVS documents
ivsproducts/    : analysis products
  crf/           : celestial frames
  trf/           : terrestrial frames
  eops/          : earth orientation (24h sessions)
  eopi/          : earth orientation (Intensive sessions)
  daily_sinex/  : daily sinex files (24h sessions)
  int_sinex/    : daily sinex files (Intensive sessions)
trop/           : troposphere
```

2 Technical Equipment

The BKG IVS Data Center is based on a DELL Server (SUSE Linux operating system), disk space of 500 GBytes (Raid system), and a backup system operated by an automatic tape library.

3 Staff Members

- Volkmar Thorandt (coordination, data analysis, data center, volkmar.thorandt@bkg.bund.de)
- Reiner Wojdziak (data center, Web design, reiner.wojdzak@bkg.bund.de)
- Dieter Ullrich (data analysis, data center, dieter.ullrich@bkg.bund.de)
- Gerald Engelhardt (data analysis, gerald.engelhardt@bkg.bund.de)

CDDIS Data Center Summary for the IVS 2014 Annual Report

Carey Noll

Abstract This report summarizes activities during the year 2014 and the future plans of the Crustal Dynamics Data Information System (CDDIS) with respect to the International VLBI Service for Geodesy and Astrometry (IVS). Included in this report are background information about the CDDIS, the computer architecture, archive contents, and future plans for the CDDIS within the IVS.

1 General Information

The Crustal Dynamics Data Information System (CDDIS) has supported the archiving and distribution of Very Long Baseline Interferometry (VLBI) data since its inception in 1982. The CDDIS is a central facility that provides users access to data and derived products to facilitate scientific investigation. The CDDIS archive of GNSS (GPS, GLONASS, etc.), laser ranging, VLBI, and DORIS data is stored online for remote access. Information about the system is available via the Web at the URL <http://cddis.gsfc.nasa.gov>. In addition to the IVS, the CDDIS actively supports other IAG services including the International GNSS Service (IGS), the International Laser Ranging Service (ILRS), and the International DORIS Service (IDS), as well as the International Earth Rotation and Reference Systems Service (IERS), and the IAG's observing system, the Global Geodetic Observing System (GGOS). The

NASA Goddard Space Flight Center

CDDIS Data Center

IVS 2014 Annual Report

current and future plans for the system's support of the IVS are discussed below.

2 System Description

The CDDIS archive of VLBI data and products is accessible to the public through anonymous ftp (<ftp://cddis.gsfc.nasa.gov>) and the Web (<http://cddis.gsfc.nasa.gov/archive>).

2.1 Computer Architecture

The CDDIS is operational on a dedicated server, cddis.gsfc.nasa.gov. The system has over 32 Tbytes of online disk storage; at this time, over 200 Gbytes are devoted to VLBI activities. The CDDIS is located at NASA GSFC and is accessible to users 24 hours per day, seven days per week.

3 Archive Content

The CDDIS has supported GSFC VLBI and IVS archiving requirements since 1979 and 1999, respectively.

The IVS Data Center content and structure is shown in Table 1 (a figure illustrating the flow of information, data, and products between the various IVS components was presented in the CDDIS submission to the IVS 2000 Annual Report). In brief, dedicated ftp-only accounts have been established on the CDDIS

Table 1 IVS data and product directory structure.

Directory	Description
Data Directories	
vlbi/ivsdata/db/yyyy	VLBI database files for year yyyy
vlbi/ivsdata/ngs/yyyy	VLBI data files in NGS card image format for year yyyy
vlbi/ivsdata/aux/yyyy/ssssss	Auxiliary files for year yyyy and session ssssss; these files include: log files, wx files, cable files, schedule files, correlator notes
Product Directories	
vlbi/ivsproducts/crf	CRF solutions
vlbi/ivsproducts/eopi	EOP-I solutions
vlbi/ivsproducts/eops	EOP-S solutions
vlbi/ivsproducts/daily.sinex	Daily SINEX solutions
vlbi/ivsproducts/int.sinex	Intensive SINEX solutions
vlbi/ivsproducts/trf	TRF solutions
vlbi/ivsproducts/trop	Troposphere solutions
Project Directories	
vlbi/ivs-iers	IVS contributions to the IERS
vlbi/ivs-pilotbl	IVS Analysis Center pilot project (baseline)
Other Directories	
vlbi/ivscontrol	IVS control files (master schedule, etc.)
vlbi/ivsdocuments	IVS document files (solution descriptions, etc.)
vlbi/raw	Raw VLBI data
vlbi/dserver	dserver software and incoming files

incoming computer, cddis.gsfc.nasa.gov. Using specified filenames, Operation and Analysis Centers deposit data files and analyzed results to appropriate directories within their ftp-only accounts. Automated archiving routines, developed by GSFC VLBI staff, peruse the directories and move any new data to the appropriate public disk area. These routines migrate the data based on the filename to the appropriate directory as described in Table 1. Index files in the main sub-directories under ftp://cddis.gsfc.nasa.gov/pub/vlbi are updated to reflect data archived in the filesystem. Furthermore, mirroring software was installed on the CDDIS host computer, as well as all other IVS Data Centers, to facilitate equalization of data and product holdings among these Data Centers. At this time, mirroring is performed between the IVS Data Centers located at the CDDIS, the Bundesamt für Kartographie und Geodäsie in Leipzig, and the Observatoire de Paris.

The public file system in Table 1 on the CDDIS computer, accessible via anonymous ftp, consists of a data area, which includes auxiliary files (e.g., experiment schedule information, session logs, etc.) and VLBI data (in both database and NGS card image formats). A products disk area was also established to house analysis products from the individual IVS Anal-

ysis Centers as well as the official combined IVS products. A documents disk area contains format, software, and other descriptive files.

4 Data Access

During 2014, an average of 250 distinct hosts accessed the CDDIS on a monthly basis to retrieve VLBI related files. These users, which include other IVS Data Centers, downloaded over 3.6 Tbytes (1.7 M files) of data and products from the CDDIS VLBI archive last year.

Work on an update of the CDDIS website was completed in early 2014. In addition to a refresh of the appearance of the website, the content was reviewed and updated.

5 Future Plans

The CDDIS staff will continue to work closely with the IVS Coordinating Center staff to ensure that our system is an active and successful participant in the IVS archiving effort.

In 2013, the CDDIS systems engineer assessed the requirements for the next generation computer system. The new server, storage, and network hardware were procured in 2014; staff members are installing the system in a new computer facility at GSFC to provide more reliable power and network connectivity. CDDIS operations will transition to the new system by mid-2015. These system improvements are being made to allow for growth, improved reliability, and disaster recovery.

Italy INAF Data Center Report

Monia Negusini, Pierguido Sarti

Abstract This report summarizes the activities of the Italian INAF VLBI Data Center. Our Data Center is located in Bologna, Italy, and it belongs to the Institute of Radioastronomy, which is part of the National Institute of Astrophysics.

1 Introduction

The main analysis activity and storage is concentrated in Bologna, where we store and analyze single databases using CALC/SOLVE software.

The IRA began storing geodetic VLBI databases in 1989, but the databases archived in Bologna mostly contain data including European antennas from 1987 onward. In particular, most of the databases available here have VLBI data with at least three European stations. But we also store all the databases with the Ny-Ålesund antenna observations. In 2002, we decided to store the complete set of databases available on the IVS Data Centers, although we limited the time span to the observations performed from 1999 onwards. All the databases were processed and saved with the best selection of parameters for the final arc solutions. In order to perform global solutions, we have computed and stored the superfiles for all the databases.

In some cases we have introduced GPS-derived wet delays into the European databases (1998 and 1999 EUROPE experiments, for the time being), as if they were produced by a WVR. These databases are avail-

able and stored with a different code from the original databases. In order to produce these databases, we have modified DBCAL, and this new version is available to external users.

2 Computer Availability and Routing Access

To date, the main computer is a Linux workstation, on which Mark 5 Calc/Solve version 11 was installed and to which all VLBI data analysis was migrated. The Internet address of this computer is sarip.ira.inaf.it. Since 2011, a new server with a storage capacity of 5 TB has been available, and therefore all experiments performed in the previous years were downloaded and archived, thus completing the catalog. The older experiments will be analyzed in order to perform global long term analysis. At present, the databases are stored in the following directories:

- 1 = /data2/dbase2
- 2 = /geo1/dbase1
- 3 = /geo1/dbase
- 4 = /geo1/dbase3

The superfiles are stored in:

/data1/super1

The list of superfiles is stored in the file /data2/mk5/save_files/SUPCAT. The username for accessing the databases is geo. The password may be requested by sending an e-mail to negusini@ira.inaf.it.

Istituto di Radioastronomia INAF, Bologna

INAF Data Center

IVS 2014 Annual Report

Data Center at NICT

Ryuichi Ichikawa¹, Mamoru Sekido²

Abstract The Data Center at the National Institute of Information and Communications Technology (NICT) archives and releases the databases and analysis results processed at the correlator and the Analysis Center at NICT. Regular VLBI sessions of the Key Stone Project VLBI Network were the primary objective of the Data Center. These regular sessions continued until the end of November 2001. In addition to the Key Stone Project VLBI sessions, NICT has been conducting geodetic VLBI sessions for various purposes, and these data are also archived and released by the Data Center.

1 General Information

The IVS Data Center at National Institute of Information and Communications Technology (NICT) archives and releases the databases and analysis results processed by the correlator and the Analysis Center at NICT. Major parts of the data are from the Key Stone Project (KSP) VLBI sessions [1], but other regional and international VLBI sessions conducted by NICT are also archived and released. Because routine observations of the KSP network terminated at the end of November 2001, there have been no additional data from the KSP regular sessions since 2002.

On March 11, 2011 the devastating megaquake (M_w 9.0) hit our antennas. The azimuth track and one azimuth wheel of the Kashima 34 m were damaged as

a consequence of the megaquake. The antenna repair had already been finished in March 2013. On the other hand, the 11-m antennas at Kashima and Koganei were not damaged by the earthquake. We have observed 20 VLBI experiments using the 11-m antennas including time and frequency transfer experiments, international and domestic geodetic experiments, and astronomical experiments during the repair of the 34-m antenna.

The analysis results in SINEX (Solution INdependent EXchange) format as well as in other formats are available on the WWW server. Database files of non-KSP sessions, i.e. other domestic and international geodetic VLBI sessions, are also available on the WWW server. Table 1 lists the WWW server locations maintained by the NICT Data Center. In the past, an FTP server was used to provide data files, but it was decided to terminate the FTP service because of the security risks of maintaining an anonymous FTP server. Instead, the www3.nict.go.jp WWW server was prepared to provide large size data files.

The responsibility for the maintenance of these server machines was moved from the VLBI research group in 2001 to a common division which handles all institutional network service of the laboratory in order to improve the network security of these systems.

2 Activities during the Past Year

2.1 KSP VLBI Sessions

The KSP VLBI sessions were performed with four KSP IVS Network Stations at Kashima, Koganei, Miura, and Tateyama on a daily or bi-daily basis until May 1999. The high-speed ATM (Asynchronous

1. National Institute of Information and Communications Technology (NICT)

2. Kashima Space Research Center, NICT

Table 1 URL of the WWW server systems.

Service	URL
KSP WWW pages	http://ksp.nict.go.jp/
IVS WWW mirror pages	http://ivs.nict.go.jp/mirror/
Database files	http://www3.nict.go.jp/aeri/sts/stmg/database/
e-VLBI Sessions	http://www2.nict.go.jp/aeri/sts/stmg/research/e-VLBI/UT1/

Transfer Mode) network line to the Miura station became unavailable in May 1999, and real-time VLBI observations with the Miura station became impossible. Thereafter, the real-time VLBI sessions were performed with the three other stations. Once every six days (every third session), the observed data were recorded to the K4 data recorders at three stations, and the Miura station participated in the sessions with the tape-based VLBI technique. In this case, the observed data at the three stations other than the Miura station were processed in real-time, and the analysis results were released promptly after the observations completed. A day later, the observed tapes were transported from the Kashima, Miura, and Tateyama stations to the Koganei station for tape-based correlation processing with all six baselines. After the tape-based correlation processing was completed, the data set produced with the real-time VLBI data processing was replaced by the new data set.

In July 2000, unusual site motion of the Tateyama station was detected from the KSP VLBI data series, and the frequency of the sessions was increased from bi-daily to daily on July 22, 2000. The daily sessions were continued until November 11, 2000, and the site motions of the Tateyama and Miura stations were monitored in detail. During the period, it was found that the Tateyama station moved approximately 5 cm to the northeast direction. The Miura station also moved approximately 3 cm to the north. The unusual site motions of these two stations gradually settled, and the current site velocities seem to be almost the same as the site velocities before June 2000. According to the investigations of the time series of the site positions, the unusual site motion started sometime between the end of June 2000 and the beginning of July 2000. At the same time, volcanic and seismic activities near the Miyakejima and Kozushima Islands began. These activities are believed to have caused the regional crustal deformation in the area, explaining the unusual site motions at Tateyama and Miura.

2.2 Other VLBI Sessions

In recent years, we have carried out time and frequency transfer experiments using VLBI. In addition, domestic and international geodetic and astronomical VLBI sessions were conducted by NICT in cooperation with the Geospatial Information Authority of Japan (GSI), the National Astronomical Observatory (NAO), and other organizations. These sessions are listed in Table 2. The recent observed data of these sessions were mainly processed by the K5 software correlator at NICT either at Koganei or at Kashima or by using a real-time hardware correlator developed by NAO.

3 Current Status

The repair of the Kashima 34-m antenna was finished in March 2013. In 2014, the Kashima 34-m and 11-m antennas participated in various experiments. Especially, we have concentrated our effort on testing for developments of broadband receiving systems.

4 Future Plans

The IVS Data Center at NICT will continue its service and will archive and release the analysis results accumulated by the correlator and the Analysis Center at NICT. In addition, a number of VLBI sessions will be conducted for the purposes of various technology developments.

References

1. Special issue for the Key Stone Project, J. Commun. Res. Lab., Vol. 46, No. 1, March 1999.

Table 2 VLBI sessions conducted by NICT (since 2005). In 2012, all experiments were observed using 11-m antennas at Kashima and Koganei because the 34-m antenna was under repair to recover from the earthquake damage. At the end of March 2013, the repair of the 34-m antenna was finished.

Year	exp. names	sessions
2005	Geodetic	c0505 (CONT05, partial participation), GEX13
	Hayabusa	14 sessions
2006	Geodetic	GEX14, viepr2, CARAVAN (three sessions)
	Spacecraft	Geotail: one session
	Pulsar	one session
2007	Ultra Rapid e-VLBI	15 times, 29 sessions
	Time Transfer	four sessions, 12 days in total
	Cs-Gas-Cell	one session
	Spacecraft	Hayabusa: one session
2008	Ultra Rapid e-VLBI	eight times, 33 sessions
	Time Transfer	26 sessions
	Variable Star e-VLBI	31 sessions
2009	e-VLBI	15 sessions, 90.5 hours in total
	IVS	12 sessions, 332 hours in total
	Time Transfer	nine sessions, 72 hours in total
	VERA	16 sessions, 149 hours in total
	Survey	26 sessions, 276 hours in total
2010	IVS	38 sessions, 442 hours in total
	Radio astronomy	34 sessions, 324 hours in total
	Spacecraft (IKAROS, UNITEC-1, QZSS)	33 sessions, 259 hours in total
	Domestic geodetic	13 sessions, 94 hours in total
	Time Transfer	nine sessions, 86 hours in total
	e-VLBI	nine sessions, 27 hours in total
2011	IVS	two sessions, 48 hours in total
	Radio astronomy	100 hours in total
	earthquake damage investigation	216 hours in total
2012	IVS	nine sessions, 216 hours in total
	Radio astronomy (Sgr-A*)	13 sessions, 28 hours in total
	Domestic geodetic	three sessions, 72 hours in total
	International fringe test (New Zealand and Korea)	two sessions, 16 hours in total
	International geodetic (New Zealand)	one session, 24 hours in total
	Time transfer	11 sessions, 264 hours in total
2013	IVS	five sessions, 120 hours in total
	Radio astronomy (including Sgr-A* obs.)	71 sessions, 266 hours in total
	Domestic geodetic	14 sessions, 213 hours in total
	Time transfer	two sessions, 46 hours in total
	International fringe test (New Zealand and Korea)	two sessions, 16 hours in total
	Pulsar	39 sessions, 274 hours in total
2014	IVS	13 sessions, 332 hours in total
	Radio astronomy (including Sgr-A* obs.)	95 sessions, 632 hours in total
	Domestic geodetic	five sessions, 130 hours in total
	Time transfer	five sessions, 288 hours in total
	Pulsar	three sessions, 24.5 hours in total

Paris Observatory (OPAR) Data Center

Christophe Barache, Sebastien Lambert, Teddy Carlucci

Abstract This report summarizes the OPAR Data Center activities in 2014. Included is information about functions, architecture, status, future plans, and staff members of the OPAR Data Center.

1 General Information

The Paris Observatory (OPAR) has provided a Data Center for the International VLBI Service for Geodesy and Astrometry (IVS) since 1999. The OPAR, as well as CDDIS and BKG, is one of the three IVS primary Data Centers. Their activities are done in close collaboration for collecting files (data and analysis files) and making them available to the community as soon as they are submitted. The three Data Centers have a common protocol and each of them:

- has the same directory structure (with the same control file),
- has the same script,
- is able to receive all IVS files (auxiliary, database, products, and documents),
- mirrors the other ones every three hours, and
- gives free FTP access to the files.

This protocol gives the IVS community a transparent access to a Data Center through the same directory, and a permanent access to files in case of a Data Center breakdown.

Observatoire de Paris/SYRTE – CNRS – UMPC – GRGS

OPAR Data Center

IVS 2014 Annual Report

2 Architecture

To be able to put a file in a Data Center, Operational and Analysis Centers have to be registered by the IVS Coordinating Center. The file names have to conform to the name conventions. A script checks the file and puts it in the right directory. The script undergoes permanent improvement and takes into account the IVS components' requests. The structure of the IVS Data Centers is detailed in Table 1.

3 Current Status

The OPAR Data Center is operated on a PC server (PowerEdge 2800 - Xeron 3.0 GHz) located at the Paris Observatory and running the Fedora Linux operating system. To make all IVS products available online, the disk storage capacity was significantly increased, and the server is equipped now with a RAID 3 TB disk extensible up to 4.7 TB.

The OPAR server is accessible 24 hours a day, seven days per week through Internet connection with 2 Mbit/s rate. Users can get the IVS products by using the FTP protocol. Access to this server is free for users.

FTP access: ftp ivsopar.obspm.fr
username : anonymous
password : your e-mail
cd vlbi (IVS directory)

The OPAR Web statistics increased in 2014 — more than 5,000 different visitors reached the server.

Table 1 Directories of the IVS Data Center.

RECENT		used for the new mirroring method
ivscontrol		control files needed by the Data Center (session code, station code, solution code...)
ivsdocuments		documents about IVS products
ivsdata		files related to the observations
	aux	auxiliary files (schedule, log...)
	db	observation files in database CALC format
	ngs	observation files in NGS format
	sinex	observation files in SINEX format
ivsproducts		results from Analysis Centers
	eopi	Earth orientation parameters, Intensive sessions
	eops	Earth orientation parameters, 24-h sessions
	crf	celestial reference frames
	trf	terrestrial reference frames
	daily_sinex	24-hour time series solutions of Earth orientation and site positions in SINEX FORMAT
	int_sinex	daily Intensive solution in SINEX format, mainly designed for combination
	trop	tropospheric time series (starting July 2003)

They viewed approximately 50,000 pages and downloaded five Go. The OPAR staff will continue to work with the IVS community and in close collaboration with the two other primary Data Centers in order to provide public access to all VLBI related data. To obtain information about the OPAR Data Center please e-mail ivs.opa@obspm.fr.

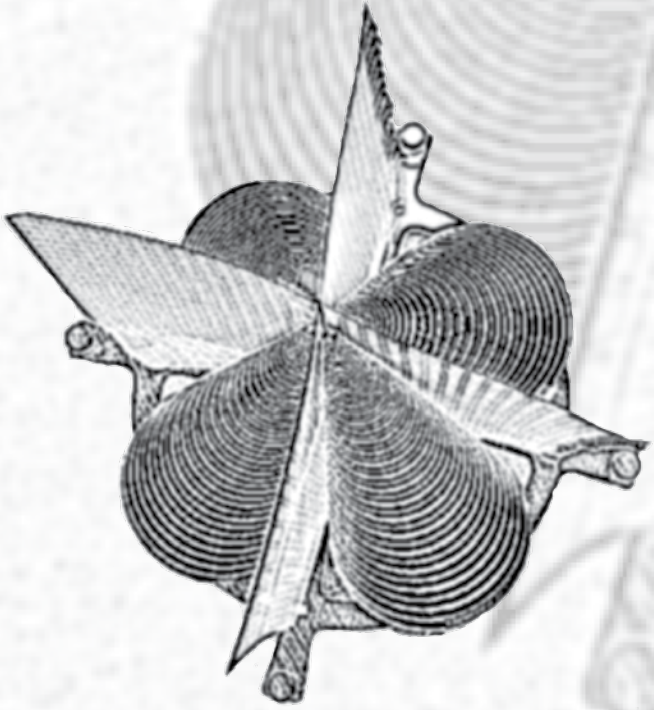

Analysis Centers

Analysis Center of Saint Petersburg University

Dmitriy Trofimov, Veniamin Vityazev

Abstract This report briefly summarizes the activities of the Analysis Center of Saint Petersburg University during 2014. The current status, as well as our future plans, are described.

1 General Information

The Analysis Center of Saint Petersburg University (SPU AC) was established at the Sobolev Astronomical Institute of the SPb University in 1998. The main activity of the SPU AC for the International VLBI Service before 2007 consisted of routine processing of 24-hour and one-hour observational sessions for obtaining Earth Orientation Parameters (EOP) and rapid UT1-UTC values, respectively. In 2008 we began submitting the results of 24-hour session processing.

2 Activities during the Past Year

- In 2014, the routine estimation of the five Earth Orientation Parameters was performed. The OCCAM software package (version 6_2) was used for current processing of VLBI data [1]. The time series is named spu00004.eops. It includes data obtained by the IRIS-A, NEOS-A, R1, R4, RDV, and R&D observing programs, and it covers 26 years of observations (from January 2, 1989 until the end of 2014). The total number of experiments processed

at the SPU AC is about 2,070, of which about 110 VLBI sessions were processed in 2014. Our experience and the equipment of the Analysis Center was used for giving lectures and practical work on the basics of radio interferometry to university students. We use our original manual on the training in modern astrometry and in particular VLBI [2]. In 2014, the work of the SPU AC was performed within the project “Acquisition and analysis of time-series in astronomy and study of astronomical catalogs” (SPU grant for fundamental research 6.0.161.2010).

- All parameters were adjusted using the Kalman filter technique. For all stations (except the reference station), the wet delay, clock offsets, clock rates, and troposphere gradients were estimated. Troposphere wet delay and clock offsets were modeled as a stochastic process such as a random walk. The clock rates and the troposphere gradients were considered to be the constant parameters.
- The main details of the preparation of the EOP time series spu00004.eops are summarized below:
 - Data span: 1989.01–2014.12
 - CRF: fixed to ICRF-Ext.2
 - TRF: VTRF2005 was used as an a priori TRF
 - Estimated parameters:
 1. EOP: $x, y, UT1 - UTC, d\psi, d\epsilon$;
 2. Troposphere: troposphere gradients were estimated as constant parameters, and wet troposphere delays were modeled as a random walk process;
 3. Station clocks were treated as follows: offset as a random walk process, rate as a constant.
 - nutation model: IAU 1980
 - mapping function: VMF1

Sobolev Astronomical Institute of Saint Petersburg University

AI SPbU Analysis Center

IVS 2014 Annual Report

- technique: Kalman filter
- software: OCCAM v.6.2

3 Current Status

The assistant professor of Saint Petersburg University, Dmitriy Trofimov, was in charge of the routine processing of the VLBI observations. General coordination and support for the activities of the SPU AC at the Astronomical Institute were performed by Professor Veniamin Vityazev.

4 Future Plans

In 2015, we are going to continue our regular processing of the VLBI sessions as well as giving lectures and practical training for students in a special course on radio astrometry. This course is a part of the systematic curriculum of astronomical education at SPb University.

References

1. O. Titov, V. Tesmer, J. Boehm. OCCAM v. 6. 0 Software for VLBI Data Analysis, In International VLBI Service for Geodesy and Astrometry 2004 General Meeting Proceedings, N. R. Vandenberg and K. D. Baver (eds.), NASA/CP-2004-212255, pp. 267-271, 2004.
2. V. Vityazev, I. Guseva, V. Kiyayev, M. Mishchenko, O. Titov, A. Tsvetkov. Celestial and Terrestrial Coordinates (In Russian), Manual on Astrometry, p. 301, SPb University, 2011.

Geoscience Australia Analysis Center 2014 Annual Report

Oleg Titov

Abstract This report gives an overview of the activities of the Geoscience Australia IVS Analysis Center during 2014.

1 General Information

The Geoscience Australia (GA) IVS Analysis Center is located in Canberra within the Geodesy Section, Geodesy and Seismic Monitoring Group, Community Safety and Earth Monitoring Division (CSEMD).

2 Activities during the Past Year

Several celestial reference frame (CRF) solutions have been prepared using the OCCAM 6.3 software. The latest solution was uploaded in March 2014. VLBI data comprising 3,325 daily sessions from January 1991 to March 2014 were used to compute several global solutions with different sets of reference radio sources. This includes 5,567,029 observational delays from 2,949 radio sources having three or more observations.

Station coordinates were also estimated using No-Net-Rotation (NNR) and No-Net-Translation (NNT) constraints. The long-term time series of the station coordinates have been used to estimate the corresponding velocities for each station. The tectonic motion for the Gilcreek VLBI site after the Denali earthquake was

modeled using an exponential function typical of post-seismic deformation.

The adjustment was made by least squares collocation, which considers the clock offsets, wet troposphere delays, and tropospheric gradients as stochastic parameters with a priori covariance functions. The gradient covariance functions were estimated from GPS hourly values.

The solution, `aus2014a.crf`, was imposed by the NNR constraints, and it is consistent with the CRF solutions submitted by other Analysis Centers.

The GA Analysis Center has submitted SINEX files for ITRF2013 and ITRF2014 solutions covering the time period from 1979 to the end of 2014.

In 2014, all three new AuScope 12-meter radio telescopes were actively working in different IVS geodetic and astrometric programs. Another radio telescope, Hobart26, operated by the University of Tasmania (UTAS), participated in the geodetic VLBI programs occasionally.

A program for optical identification and spectroscopy of the reference radio sources continued in collaboration with the Australian Telescope National Facility, University of Sydney, and Nordic Optical Telescope. More observing runs at Gemini North and Gemini South (service mode) were done in 2014. A new paper on the reference radio source redshift determination is under preparation.

Acknowledgements

This report has been published with the permission of the CEO, Geoscience Australia. ©Commonwealth of Australia (Geoscience Australia) 2015.

Geoscience Australia

GA Analysis Center

IVS 2014 Annual Report

Report for 2014 from the Bordeaux IVS Analysis Center

Patrick Charlot, Antoine Bellanger, Romuald Bouffet, Géraldine Bourda, Arnaud Collioud, Alain Baudry

Abstract This report summarizes the activities of the Bordeaux IVS Analysis Center during the year 2014. The work focused on (i) the regular analysis of the IVS-R1 and IVS-R4 sessions with the GINS software package, also producing a 12-year long solution (2002—2013); (ii) the systematic VLBI imaging of the RDV sessions and calculation of the corresponding source structure index and compactness values; (iii) the investigation of the correlation between astrometric position instabilities and source structure variations, and (iv) the continuation of activities to identify and monitor optically-bright radio sources suitable as transfer sources to align the International Celestial Reference Frame (ICRF) and the future Gaia frame. Also to be mentioned is the organization of a workshop on gravitation, reference systems, astronomy, and metrology, and participation in the IAU Working Group Meeting on the next ICRF realization.

1 General Information

The *Laboratoire d'Astrophysique de Bordeaux (LAB)*, formerly Bordeaux Observatory, is located in Floirac, near Bordeaux, in the southwest of France. It is funded by the University of Bordeaux and the *Centre National de la Recherche Scientifique (CNRS)*. VLBI activities are primarily developed within the *Métrologie de l'espace, Astrodynamique, Astrophysique (M2A)* team.

Laboratoire d'Astrophysique de Bordeaux

Bordeaux Analysis Center

IVS 2014 Annual Report

The contribution of the Bordeaux group to the IVS has been mostly concerned with the maintenance, extension, and improvement of the International Celestial Reference Frame (ICRF). This includes regular imaging of the ICRF sources and evaluation of their astrometric suitability, as well as developing specific VLBI observing programs for enhancing the celestial frame.

In addition, the group is in charge of the VLBI component in the multi-technique GINS software package [1] as part of a collaborative effort within the French *Groupe de Recherches de Géodésie Spatiale (GRGS)* to combine VLBI and space geodetic data (SLR, GPS, and DORIS) at the observation level. This effort involves institutes in Toulouse, Nice, and Paris.

2 Description of Analysis Center

The Bordeaux IVS group routinely analyzes the weekly IVS-R1 and IVS-R4 sessions with the GINS software package. During the past year, weekly normal equations for all such sessions in 2014 (with six-hour EOP resolution) were produced and integrated in the multi-technique solutions derived by the GRGS. In addition, we produced a solution that includes all IVS-R1 and IVS-R4 sessions from 2002 to 2013. The motivation for setting up this 12-year long VLBI solution was to obtain multi-technique results derived from combining all space geodetic data at the observation level in the framework of the ITRF2013 preparation.

The group is also focused on imaging the ICRF sources on a regular basis by systematic analysis of the data from the RDV sessions which are conducted six times a year. This analysis is carried out with the AIPS and DIFMAP software packages. The aim of such reg-

ular imaging is to characterize the astrometric suitability of the sources based on the so-called “structure index” and to compare source structural evolution and positional instabilities. Such studies are essential for identifying sources of high astrometric quality, which is required, e.g., for the future Gaia link.

3 Scientific Staff

During the past year, there were no changes in the IVS staff. In all, six individuals contributed to one or more of our IVS analysis and research activities during 2014. A description of what each person worked on, along with the time spent on it, is given below.

- Patrick Charlot (20%): researcher with overall responsibility for Analysis Center work and data processing. His interests include the ICRF densification, extension, and link to the Gaia frame, studies of radio source structure effects in astrometric VLBI data, and astrophysical interpretation.
- Antoine Bellanger (100%): engineer with a background in statistics and computer science. He is tasked to process VLBI data with GINS and to develop procedures and analysis tools to automate such processing. He is also the M2A Web master.
- Romuald Bouff  t (30%): Ph. D. student from the University of Bordeaux whose thesis is focused on the study of the relationship between radio source structure and position instabilities. He is using astrometric data and VLBI images from IVS sessions.
- G  raldine Bourda (50%): astronomer in charge of developing the VLBI part of GINS and responsible for the analysis results derived from GINS. She is also leading a VLBI observational program for linking the ICRF and the future Gaia optical frame.
- Arnaud Collioud (100%): engineer with a background in astronomy and interferometry. His tasks are to image the sources in the RDV sessions using AIPS and DIFMAP, to develop the Bordeaux VLBI Image Database and *IVS Live* tool, and to conduct simulations for the next generation VLBI system.
- Alain Baudry (10%): radioastronomy expert with specific interest in radio source imaging and astrometric VLBI. He is a Professor Emeritus and is working part time as a co-investigator for developing upgrades of the ALMA mm/submm array.

4 Analysis and Research Activities in 2014

As noted above, a major part of our activity consists of imaging the sources observed during the RDV sessions on a systematic basis. During 2014, two such sessions were processed (RDV92 and RDV94), resulting in 337 VLBI images at either X- or S-band for 150 different sources. The imaging work load has been shared with USNO since 2007 (starting with RDV61); the USNO group processes the odd-numbered RDV sessions while the Bordeaux group processes the even-numbered ones. The VLBI images are used in a second stage to derive structure correction maps and visibility maps along with values for structure indices and source compactness (see [2, 3] for a definition of these quantities) in order to assess astrometric source quality. All such information is made available through the Bordeaux VLBI Image Database (BVID)¹. At present, the BVID comprises a total of 4,007 VLBI images for 1,170 different sources (with links to an additional 6,775 VLBI images from the Radio Reference Frame Image Database of USNO) along with 10,572 structure correction maps and as many visibility maps.

In addition to such regular imaging, studies aimed at characterizing correlations between astrometric position instabilities and source structural variations have been pursued. As indicated in our 2013 IVS report, although a link between the two phenomena was found, a fraction of the sources shows a negative correlation. Investigating further such discrepancies, a number of explanations have been put forward: (i) misidentification of the core component over the epochs in the successive VLBI maps, (ii) imprecision in the VLBI core location (e.g. due to blended VLBI components in the inner part of the jet), (iii) effects of the S-band data, not considered in this study, (iv) inadequacy of the brightness centroid motion to match astrometric instabilities, (v) opacity variations affecting the VLBI core position along the jet, and (vi) precession effects (due to the rotation of the central black hole) or orbital motion (due to the presence of a binary black hole system) causing true VLBI core displacement. Focusing on the latter and taking an additional step, we developed simulations of jets affected by such physical phenomena (precession and the presence of a binary black hole). Preliminary results indicate that the resulting trajec-

¹ The Bordeaux VLBI Image Database may be accessed at <http://www.obs.u-bordeaux1.fr/BVID>.

ries on the sky show oscillations whose amplitude and time scale are in agreement with those observed in actual sources, hence giving credence to these considerations.

Another major activity of the group is the identification and characterization of appropriate radio sources to align the ICRF and the future Gaia optical frame. To this end, two complementary directions are being followed: (i) the identification and monitoring of such sources within ICRF2 and (ii) the search for additional sources (outside of ICRF2) to increase the pool of transfer sources. As noted in our 2012 IVS report, the examination of ICRF2 led to the identification of 195 transfer sources. Following our proposal, most of these sources were inserted into IVS programs and are now observed on a regular basis. During the past year, the work has consisted of assessing the time coverage of these sources, in collaboration with the IVS Coordinating Center, with the aim of getting one epoch per month, similar to the overall Gaia time coverage. Additionally, some of the transfer sources from the other set (the non-ICRF2 sources) were inserted into Deep Space Network sessions through a collaboration with the Jet Propulsion Laboratory. These sources are much weaker and require large antennas for detection. Observations to characterize potential transfer sources in the southern hemisphere are also soon to be initiated following acceptance of a proposal by the Australian Long Baseline Array.

Most of this work (source imaging, assessment of structural effects, identification of Gaia transfer sources, etc.) naturally fits within the tasks of the IAU Working Group on the next ICRF realization which was set up at the 2012 IAU General Assembly. Both G. Bourda and P. Charlot are members of this Working Group and as such contributed to the two meetings of the Working Group held during the past year (7 March 2014 in Shanghai and 14 October 2014 in Luxembourg).

5 Dissemination and Outreach

A workshop on gravitation, reference systems, astronomy, and metrology was hosted by the Bordeaux group on 3-4 April 2014 as part of the five-year planning exercise for French astronomy. During the workshop, P. Charlot gave a talk on the next generation VLBI sys-

tem, putting emphasis on the need to set up a VGOS antenna in Tahiti. The planning exercise concluded with a one-week long meeting covering all fields of astronomy that took place in the fall of the 2014.

The *IVS Live* Web site [4], dedicated to monitoring IVS sessions and viewing VLBI images of the observed sources, was updated on a regular basis during 2014. It now includes 6,335 IVS sessions (with 71 stations participating) and 1,799 sources. Monitoring of the connections indicates that there were 1,017 visits from around the world (47 countries, 277 locations) during 2014, with 70% originating from different individuals. On the other hand, the Bordeaux VLBI Image Database was accessed from 77 different locations in 27 countries. In all, there were 629 connections, with about one-third originating from different individuals.

6 Outlook

Our plans for the coming year are focused on moving towards operational analysis of the IVS-R1 and IVS-R4 sessions with the GINS software package. Imaging of the RDV sessions and evaluation of the astrometric suitability of the sources will continue along the lines described in this report. Dissemination activities include upgrading the BVID by implementation of a new user interface. Of the most importance are our observing programs in cooperation with IVS and other groups to search and monitor Gaia transfer sources both in the northern hemisphere and in the southern hemisphere. The aim is to finalize the source list by 2016, in time for the first release of the Gaia catalog. Finally, we expect to contribute to the work towards the next realization of the ICRF in accordance with the plans of the IAU Working Group in charge of this task. This includes participation in the upcoming meetings of the Working Group, among which is the one to be held during the IAU General Assembly this summer in Hawaii.

Acknowledgements

We would like to thank the *Observatoire Aquitain des Sciences de l'Univers (OASU)* for supporting IVS activities in Bordeaux.

References

1. Bourda, G., Charlot, P., Biancale, R.: 2007, GINS: A New Tool for VLBI Geodesy and Astrometry, 18th EVGA Working Meeting, Eds. J. Böhm, A. Pany, and H. Schuh, IGG Vienna, p. 59–63.
2. Fey, A. L., Charlot, P.: 1997, VLBA Observations of Radio Reference Frame Sources. II. Astrometric Suitability Based on Observed Structure, *ApJS*, 111, 95–142.
3. Charlot, P.: 2008, Astrophysical Stability of Radio Sources and Implication for the Realization of the Next ICRF, 5th IVS General Meeting, St Petersburg, Eds. A. Finkelstein and D. Behrend, p. 345–354.
4. Collioud, A.: 2011, IVS Live: All IVS on your desktop, Proceedings of the 20th Meeting of the European VLBI Group for Geodesy and Astronomy, Eds. W. Alef, S. Bernhart, and A. Nothnagel, Universität Bonn, Institut für Geodäsie und Geoinformation, Schriftenreihe 22, p. 14–18.

BKG/DGFI Combination Center Annual Report 2014

Sabine Bachmann¹, Linda Messerschmitt¹, Ralf Schmid², Mathis Bloßfeld², Daniela Thaller¹

Abstract This report summarizes the activities of the BKG/DGFI Combination Center in 2014 and outlines the planned activities for 2015. The main focus in 2014 was on the generation of the IVS contribution to the next ITRF, the inclusion of additional Analysis Centers into the combined solution, and the design and set-up of a new Combination Center website.

1 General Information

The BKG/DGFI Combination Center was established in October 2008 as a joint effort of the Federal Agency for Cartography and Geodesy (Bundesamt für Kartographie und Geodäsie, or BKG) and the German Geodetic Research Institute (Deutsches Geodätisches Forschungsinstitut, or DGFI). The participating institutions, as well as the tasks and the structure of the IVS Combination Center, are described in [1]. The tasks comprise quality control and a timely combination of the session-based intermediate results of the IVS Analysis Centers into a final combination product (e.g., Earth orientation parameters, or EOP). In coordination with the IVS Analysis Coordinator, the combination results are released as official IVS products. The Combination Center is also expected to contribute to the generation of the official IVS input to any ITRF activities.

1. Federal Agency for Cartography and Geodesy (BKG)

2. Technische Universität München, Deutsches Geodätisches Forschungsinstitut (DGFI-TUM)

BKG/DGFI Combination Center

IVS 2014 Annual Report

The BKG/DGFI Combination Center performs a combination of session-based results of the IVS Analysis Centers on an operational basis. The strategy for the combination is based on the combination of normal equations and was adopted from the combination process as developed and performed by the IVS Analysis Coordinator (cf. [2], [3]). At BKG, the following tasks are performed:

- Quality control of the Analysis Center results: checking the format of the results and their suitability for combination, identification and reduction of outliers, comparison of the Analysis Centers' results with each other, and comparison of the results with external time series provided by the IERS or IGS.
- Feedback to the Analysis Centers: quality control results are available at the BKG IVS Combination Center web pages [5].
- Generation of high-quality combination products and timely archiving and distribution: combination products are created by using the combination part DOGS-CS of DGFI's software package DOGS (DGFI orbit and geodetic parameter estimation software) [4].
- Submission of official IVS combination products to the IERS: the products are submitted to the responsible IERS components to be used for IERS product generation (e.g., EOP rapid products and the EOP series IERS C04).
- Generation of the official IVS input to the ITRF: the combined session products (from 1984 to present) are submitted for ITRF computation in the form of normal equations in SINEX format. This work is also supported by the staff of the IERS Central Bureau, hosted by BKG.

- Final results are archived in the BKG Data Center and mirrored to the IVS Data Centers at Observatoire de Paris (OPAR) and Goddard Space Flight Center (GSFC). This work is assisted by the staff of the BKG Data Center in Leipzig.

DGFI is in charge of the following Combination Center functions:

- DGFI is developing state-of-the-art combination procedures. This work, as well as the following item, is related to the ITRS Combination Center at DGFI and DGFI's efforts within the IERS WG on Combination at the Observation Level (COL).
- The software DOGS-CS is updated by implementing and documenting the developed state-of-the-art combination procedures.
- Adhering to IERS Conventions: the DGFI DOGS software package is continuously updated to be in accordance with the IERS Conventions.

2 Activities during the Past Year

At BKG, the following activities were performed in 2014:

- Generation of a combined solution of IVS 24-h rapid sessions twice a week.
- Generation of a combined long-term solution of IVS 24-h sessions every three months.
- Validation and inclusion of 11 contributions to the IVS combined contribution to the ITRF.
- Ensuring that the combination process is in agreement with the IERS2010 Conventions.
- Generation of the IVS combined contribution to the next ITRF for the IERS ITRS Center.
- Inclusion of new Analysis Centers (GFZ, Germany and CGS, Italy) into the routine rapid combination.
- Design and set-up of the new IVS Combination Center website [5].
- Refinements of the combination procedure and implementation of source parameter combination.
- Development of an alternative combination procedure using the Bernese GNSS Software; implementation of the basic VLBI combination functions and preprocessing routines in cooperation with the University of Bonn.
- Participation in a pilot project on digital object identifiers (DOI) for data in cooperation with

R. Heinkelmann (Deutsches GeoForschungsZentrum, Germany); feasibility investigation for providing data and meta data.

An initial set of SINEX files for the ITRF generation was submitted to the IERS ITRS Center at the beginning of December 2014. Ten institutions had submitted their SINEX files in order to contribute to the combined solution. One of the main tasks in 2014 was to gather the SINEX contributions and to make sure that all contributions meet the IVS analysis specifications for ITRF contributions. In the course of the year, it turned out that the ITRF could be extended by another year, including sessions until the end of 2014 (instead of 2013 as foreseen in the original ITRF call for participation). With one year of additional data, an eleventh institution announced its participation. The challenge in 2014 was to ensure a consistent data quality, homogeneous data contributions, and the set-up of a combination procedure meeting the IVS specifications, e.g. meeting the IERS2010 standards.

In Figure 1, the data contribution to the next ITRF is shown. Comparing the institutions contributing to the ITRF with those contributing to the routine combination listed in Section 4 illustrates the effort coming along with the ITRF contribution compared to the routine rapid combination. The final deadline for all IERS Technique Services for the (extended) ITRF contribution is now February 28, 2015.

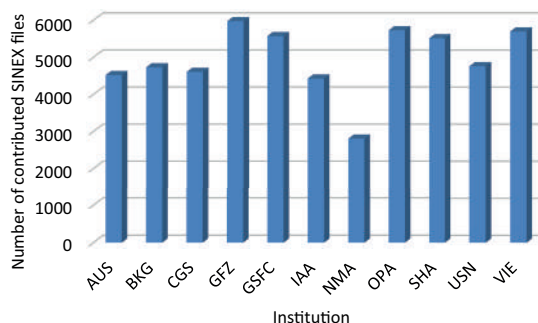

Fig. 1 AC SINEX files provided for the IVS combined solution for the next ITRF.

Within the past year, the IVS Combination Center website has been newly designed and set up [5]. The IVS Combination Center manages a stand-alone website to inform IVS users about VLBI combination de-

tails such as structure, basics, organization, and the current combination results. The content of these pages is regularly updated. To best use the technical progress we did some scale and structure changes. The basis is now a professional Content Management System (CMS), which was developed for this purpose. Many functions and extensions are already disposed in the CMS and will simplify the future administration. Now, users are able to fill in an evaluation form about the Web page content, to search for keywords, to look at glossary entries, or to print out all information. An automatic view of the recent combination status and many other tools were added. Due to these changes and the new design we will increase the benefit of the IVS. A screenshot of the newly designed Web site is shown in Figure 2. The new Web site is planned to go online within the first half of 2015.

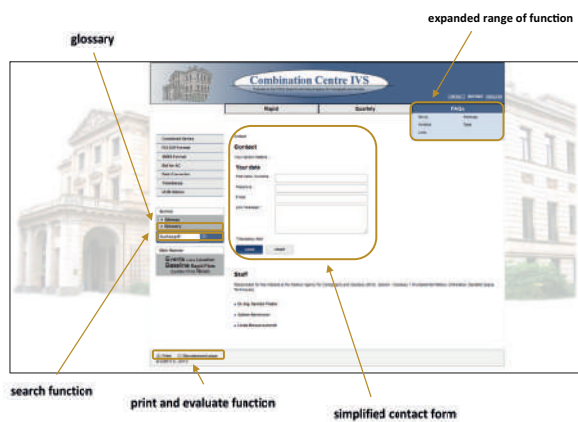

Fig. 2 Screenshot of the newly designed BKG Combination Center website.

At DGFI, the following activities were performed in 2014:

- Update of similarity transformation program.
- Handling of radio source position parameters with DOGS-CS.
- Validation of input files for ITRF contribution and evaluation of the weighting procedure within the combination in cooperation with BKG.

3 Staff

The list of the staff members of the BKG/DGFI Combination Center in 2014 is given in Table 1.

More details on the IVS Combination Center at BKG can be found in an interview for the IVS Newsletter [6].

4 Current Status

In 2014, six IVS Analysis Centers (BKG, DGFI, GSFC, IAA, OPA, and USNO) contributed to the IVS combined rapid and quarterly product (see [5]). The GFZ (German Research Center for Geosciences) and CGS (Centro di Geodesia Spaziale, Italy) Analysis Centers are currently under review and will become IVS Operational ACs in the near future. The rapid solutions contain only R1 and R4 sessions, and new data points are added twice a week as soon as the SINEX files of at least four IVS Analysis Centers are available. Long-term series are generated quarterly and include all 24-h sessions since 1984. The quarterly series include long-term EOP, station positions, and velocities. Furthermore, a VLBI TRF is generated and published. The preprocessing to read and write source positions was implemented, and the software was extended to process source parameters. The results of the combination process are archived by the BKG Data Center in Leipzig. The combined rapid EOP series, as well as the results of the quality control of the Analysis Center results, are also available directly at the BKG/DGFI Combination Center website [5] or via the IVS Analysis Coordinator website.

5 Future Plans

In 2015, the work of the BKG/DGFI Combination Center will focus on the following aspects:

- Finishing the extended IVS contribution to the next ITRF realization: inclusion of the IVS sessions of one additional year (2014).
- Inclusion of new Analysis Centers (CGS and GFZ) into the routine rapid and quarterly combination.

Table 1 Staff members of the BKG/DGFI Combination Center.

Name	Affiliation	Function	E-Mail
Sabine Bachmann	BKG	Combination procedure development	sabine.bachmann@bkg.bund.de
Linda Messerschmitt	BKG	Operational combination /Web site maintenance	linda.messerschmitt@bkg.bund.de
Mathis Bloßfeld	DGFI	Combination strategies	mathis.blossfeld@tum.de
Michael Gerstl	DGFI	Software maintenance	michael.gerstl@tum.de
Ralf Schmid	DGFI	Combination strategies	schmid@tum.de

- Investigation of the combination of source coordinates for time series of source coordinates and generation of a combined celestial reference frame based on VLBI intra-technique combination.
- Establishing the digital object identifier (DOI) for combined VLBI products in cooperation with GFZ.

References

1. Schwegmann, W., Gerstl, M., Heinkelmann, R., BKG/DGFI Combination Center Annual Report 2008, in: *International VLBI Service for Geodesy and Astrometry 2008 Annual Report*, NASA/TP-2009-214183, D. Behrend and K. D. Baver (eds.), 250–252, 2009.
2. Nothnagel, A., Böckmann, S., Artz, T., *Analysis Coordinator Report*, in: *International VLBI Service for Geodesy and Astrometry 2007 Annual Report*, NASA/TP-2008-214162, D. Behrend and K. D. Baver (eds.), 16-17, 2008.
3. Nothnagel, A., Böckmann, S., Artz, T., *Analysis Coordinator Report*, in: *International VLBI Service for Geodesy and Astrometry 2009 Annual Report*, NASA/TP-2010-215860, D. Behrend and K. D. Baver (eds.), 45–47, 2010.
4. http://ilrs.dgfi.badw.de/fileadmin/dogs/cs_manual.ps
DOGS-CS software manual (German version only).
5. <http://ccivs.bkg.bund.de/> BKG Combination Center website.
6. Hase, H., BKG/DGFI Combination Center at Frankfurt, IVS Newsletter 36, 2-3, 2013. <http://ivscc.gsfc.nasa.gov/publications/newsletter/issue36.pdf>.

Matera CGS VLBI Analysis Center

Giuseppe Bianco ¹, Roberto Lanotte ²

Abstract In this document G. Bianco as primary contact and R. Lanotte as associate member, both for the IVS Analysis Center at the Space Geodesy Center (CGS) of the Italian Space Agency (ASI), report the VLBI data analysis activities performed from January 2014 through December 2014 and the contributions that the CGS intends to provide in the future as an IVS Analysis Center.

1 General Information

The CGS VLBI Analysis Center is located at the Matera VLBI station close to the town of Matera in the middle south of Italy. The Matera VLBI station became operational at the CGS/ASI in May 1990. Since then, it has been active in the framework of the most important international programs. The CGS, operated by E-GEOS S.p.A. (an ASI/Telespazio company) under an ASI contract, provides full scientific and operational support using the main space geodetic techniques: VLBI, SLR, and GPS. The work presented in this report is carried out by the E-GEOS staff consisting of Roberto Lanotte and Simona Di Tomaso.

1. Italian Space Agency, Centro di Geodesia Spaziale

2. E-GEOS S.p.A., Centro di Geodesia Spaziale

CGS Analysis Center

IVS 2014 Annual Report

2 Activities during the Past Year

During 2014, the following activities were performed at CGS:

- Global VLBI Solution cgs2014a.
In the year 2014 we continued the annual realization of a global VLBI solution. This year's solution is named cgs2014a and was realized using the CALC/SOLVE software developed at NASA/GSFC. The main and final characteristics of the cgs2014a solution are:
 - Data span: 1984.01.04 — 2013.12.26 for a total of 4,356 sessions
 - Estimated Parameters:
 - Celestial Frame: Right ascension and declination as global parameters for 969 sources,
 - Terrestrial Frame: Coordinates and velocities for 99 stations as global parameters, and
 - Earth Orientation: X pole, Y pole, UT1, Xp rate, Yp rate, UT1 rate, dpsi, and deps.
- IVS Tropospheric Products.
Regular submission of tropospheric parameters (wet and total zenith path delays, east and north horizontal gradients) for all VLBI stations observing in the IVS R1 and R4 sessions continued during 2014. Currently, 1,390 sessions have been analyzed and submitted, covering the period from 2002 to 2014. The results are available at the IVS products ftp site.
- Daily Solution Files (DSNX).
This year we started to provide daily sinex files for the IVS project “Daily EOP + station-coordinates solutions”. At the present about 5000 sessions have been analyzed and submitted to IVS.

- CGS contribution to IVS combination for ITRF2013.
About 4,500 VLBI sessions from 1984 to the end of 2013 have been analyzed following the instructions provided by the IVS Analysis Coordinator, John Gipson. The produced sinex files have been submitted to be included in the IVS contribution to ITRF2013.
- CGS contribution to IERS EOP Operational Series.
Since 2008, CGS has been delivering IERS R1 and R4 session EOP estimates as a regular contribution to the IERS EOP operational series.
- Software development.
We started the realization of the software “*resolve*”. The main goal of this software is the visual editing of a VLBI database. One of the reasons that led us to the development of this software was to have the capability of work on the output obtained from a run of SOLVE in BATCH mode. At the present we have used *resolve* to edit approximately 5% of the databases of the daily sinex production.

2.1 Staff at CGS Contributing to the IVS Analysis Center

- Dr. Giuseppe Bianco, responsible for CGS/ASI (primary scientific/technical contact).
- Dr. Rosa Pacione, responsible for scientific activities, E-GEOS.
- Dr. Roberto Lanotte, geodynamics data analyst, E-GEOS.
- Dr. Simona Di Tomaso, geodynamics data analyst, E-GEOS.

3 Future Plans

- Continue and improve the realization of our global VLBI solution, providing its regular update on time.
- Continue to participate in the IVS analysis projects.

DGFI Analysis Center Annual Report 2014

Ralf Schmid, Michael Gerstl, Manuela Seitz, Detlef Angermann

Abstract This report presents the activities of the DGFI Analysis Center during 2014. Besides the regular IVS submissions, DGFI continued to reprocess 24-hour sessions including the estimation of source positions. DOGS-RI, the new VLBI analysis software to be used at DGFI, is near completion.

1 General Information and Component Description

The DGFI Analysis Center (AC) is located at the German Geodetic Research Institute (Deutsches Geodätisches Forschungsinstitut, or DGFI) in the city center of Munich in Germany. In 2014, DGFI was still an autonomous and independent research institution affiliated with the Bavarian Academy of Sciences and Humanities (BAdW) and funded by the Free State of Bavaria. In January 2015, DGFI became an institute of the Technische Universität München (TUM), and it is now called “DGFI-TUM”.

Research performed at DGFI covers many different fields of geodesy (geometric techniques, gravity field, Earth system modeling, etc.) and includes the contribution to national and international scientific services and research projects as well as various functions in scientific organizations (see <http://www.dgfi.tum.de>). DGFI closely cooperates with other TUM institutions (including personnel at the Geodetic Observatory

Deutsches Geodätisches Forschungsinstitut der Technischen Universität München (DGFI-TUM)

DGFI Analysis Center

IVS 2014 Annual Report

Wetzell) and with BAdW within the framework of the Center of Geodetic Earth System Research (CGE).

DGFI has been acting as an IVS AC since the establishment of the IVS in 1999. Since November 2008, DGFI has been an operational AC regularly submitting constraint-free normal equations for 24-hour sessions in the SINEX format. Since 2008, DGFI has also been involved in the BKG/DGFI Combination Center.

2 Staff

In 2014, the DGFI AC had to cope with a rather low number of personnel again, as Manuela Seitz was still on maternity leave.

Table 1 Staff members and their main areas of activity.

Dr. Detlef Angermann	Group leader
Dr. Michael Gerstl	Development of the analysis software DOGS-RI
Dr. Ralf Schmid	Routine data analysis, combination of different space geodetic techniques
Dr. Manuela Seitz (currently on maternity leave)	CRF/TRF combination, ICRF3, combination of different space geodetic techniques

The activities of the DGFI AC were more or less limited to the routine analysis of 24-hour sessions which have been performed by Ralf Schmid since the end of May 2013. In addition, Michael Gerstl is engaged in the development of new VLBI analysis software called DOGS-RI (DGFI Orbit and Geodetic Parameter Estimation Software - Radio Interferom-

etry). Table 1 lists the staff members and their main areas of activity.

3 Current Status and Activities

Analysis Activities

In 2014, the DGFI AC continued to re-analyze 24-hour sessions including the estimation of source positions. Still using the analysis software OCCAM, the period from April 2008 to June 2011 could be covered. This means that, at the end of December 2014, consistent DGFI SINEX files were available from April 2008 to December 2014.

If operational and reprocessed solutions are summed up, DGFI analyzed 576 sessions altogether from seven consecutive years and submitted the corresponding daily SINEX files to the IVS. Among them were 212 IVS-R1, 210 IVS-R4, 29 VLBA, 26 EUROPE, 26 IVS-T2, 25 IVS-R&D, 15 CONT14, 13 IVS-OHIG, ten CONT08, seven APSG, and three CRF sessions (see Table 2).

Table 2 Sessions analyzed in 2014.

Session type	2008	2009	2010	2011	2012	2013	2014	Total
APSG	2	2	2	1	–	–	–	7
CONT08	10	–	–	–	–	–	–	10
CONT14	–	–	–	–	–	–	15	15
CRF	2	1	–	–	–	–	–	3
EUROPE	4	6	6	4	–	1	5	26
IVS-OHIG	3	3	2	2	–	3	–	13
IVS-R1	33	51	52	26	–	4	46	212
IVS-R4	36	50	52	26	–	3	43	210
IVS-R&D	6	9	3	4	–	2	1	25
IVS-T2	5	7	7	3	–	4	–	26
VLBA	4	6	6	3	3	2	5	29
Total	105	135	130	69	3	19	115	576

When reprocessing VLBI sessions from former years, it turned out that some of the databases available at the IVS Data Centers were incomplete. Table 3 shows the stations whose data were missing. Usually, the absence of a station was connected to a recorelation of the session.

In the meantime, all databases were resubmitted by the responsible agencies and, except for R4498, reanalyzed by the DGFI AC. All solutions could benefit significantly from the additional data.

Table 3 Missing stations in IVS databases prior to reprocessing.

Session	Database	Missing station(s)
R4498	11SEP01XE	Zc
R1471	11FEB21XA	Sh, Tc
R4454	10OCT28XE	Ma
R4444	10AUG19XE	Bd
R4428	10APR29XE	Ma, Zc
R4407	09DEC03XE	Bd, Zc
R4400	09OCT15XE	Wz
R4395	09SEP10XE	Tc
R4390	09AUG06XE	Ma
R4380	09MAY28XE	Bd
R4367	09FEB26XE	Ny
R4337	08JUL17XE	Zc
R4335	08JUL02XE	Kk
R4331	08JUN05XE	Ny
R4330	08MAY29XE	Bd
R4327	08MAY07XE	Sv

In addition, a newly combined multi-year solution based on VLBI and GNSS observations was set up to demonstrate the simultaneous realization of ICRS and ITRS. While the standard deviations of all parameters improve, the combination of LOD seems to shift the positions of certain VCS-only sources and some sources observed in RDV sessions, which has to be further investigated.

Software Development

The development of DOGS-RI is still in progress. Detailed comparisons with OCCAM have helped to debug the new software, and also to detect deficiencies in the operational OCCAM processing (e.g., files with a priori information were not up-to-date, etc.).

With DOGS-RI, the DGFI AC will have a software available that follows IERS 2010 Conventions and that can provide the new nutation parameters (dX , dY). A lot of time was spent on the proper relativistic calculation of the partial derivatives w.r.t. the parameters. In many places, difference quotients could be replaced by time derivatives.

The handling of station coordinates and discontinuities was facilitated, and DOGS-RI will allow a common adjustment of multiple sessions.

4 Future Plans

In 2015, we would like to continue reprocessing 24-hour sessions backward from April 2008. Further detailed comparisons between DOGS-RI and OCCAM will be necessary before we can switch to the new software.

GFZ Analysis Center 2014 Annual Report

Robert Heinkelmann¹, Tobias Nilsson¹, James M. Anderson¹, Kyriakos Balidakis¹, Susanne Glaser², Maria Karbon¹, Li Liu^{1,3}, Cuixian Lu¹, Julian A. Mora-Diaz¹, Virginia Raposo-Pulido^{1,4}, Benedikt Soja¹, Minghui Xu^{1,3}, Harald Schuh^{1,2}

Abstract This report briefly provides general information and the component description of the IVS Analysis Center at GFZ. Recent results are mentioned, and the planned future activities are outlined.

The overarching research aim of the GFZ is one of developing strategies and demonstrating practical options, e.g. to preserve natural resources and to exploit them in an environmentally friendly way, to guard against natural catastrophes, to assess changes in the climate and the environment and man's impact on these, and to research and utilise our world below ground, all based on a comprehensive understanding of systems and processes.

1 General Information

Helmholtz Centre Potsdam, GFZ German Research Centre for Geosciences is the national research center for Earth sciences in Germany. Main tasks of GFZ according to its website¹ are:

System Earth — Research Focus of the GFZ German Research Center for Geosciences

The Earth is a dynamic planet. Under the influence of external and internal forces, it is continuously changing. The solid Earth, the atmosphere, the hydrosphere and the things living within them are always interacting. In short, the Earth is a complex system, with forces and interactions between many different partners. To understand the world in which we live, from our regional environment to the entire planet, it is necessary to understand how the System Earth works in all details. In the analysis, we have to include the activities of mankind and their influence on the natural processes in this complex, nonlinear system, which in turn affects the environment we live in.

1. Helmholtz Centre Potsdam, GFZ German Research Centre for Geosciences, Germany
2. Technische Universität Berlin, Institute of Geodesy and Geoinformation Science, Chair of Satellite Geodesy, Germany
3. Shanghai Astronomical Observatory, Chinese Academy of Sciences, China
4. Instituto Geográfico Nacional, Madrid, Spain

GFZ Analysis Center

IVS 2014 Annual Report

¹ <http://www.gfz-potsdam.de>

At this research facility within Department 1 ‘Geodesy and Remote Sensing’ and Section 1.1 ‘GPS/GALILEO Earth Observation’ a VLBI group that is an associate Analysis Center (AC) of IVS has been established since the end of 2012.

2 Component Description

GFZ is an associate AC of IVS. We are installing and automatizing our VLBI analysis process in preparation for becoming an operational AC. We analyze all incoming geodetic and astrometric types of sessions and provide interim results in the SINEX format within 24 hours after the provision of database files of version 4 or higher at IVS Data Centers. In 2013 and 2014 we re-processed all available IVS databases and submitted these for inclusion in the IVS contribution to the ITRF2014 (formerly ITRF2013). We are also performing as an IVS Combination Center for tropospheric products [6]².

² http://kg6-dmz.gfz-potsdam.de/ivs/php/tropospheric_combination.php

3 Staff

The members of the VLBI group and their functions are listed in Table 1, and a picture of us is displayed as Figure 1. In 2014, Virginia Raposo-Pulido visited the Observatoire de Paris, Paris, France, for several months to cooperate with Nicole Capitaine and Sébastien Lambert on the determination of systematic effects of the CRF. Julian Mora-Diaz visited the Max Planck Institute for Radio Astronomy, Bonn, Germany, for a few weeks to determine radio source structure maps together with Alessandra Bertarini.

Since last year (Annual Report 2013) two more scientists and one PhD student joined our VLBI group (in alphabetical order):

- James M. Anderson, PhD, is a radio astronomer, who studied at NRAO, USA, and who has been in the past working e.g. at JIVE, The Netherlands, and at MPI Bonn, Germany,
- Kyriakos Balidakis, MSc, is a geodesist from Aristotle University in Thessaloniki, Greece, who will be working on atmospheric modelling for space geodetic techniques for his PhD, and
- Susanne Glaser, Dr.-Ing., a geodesist from Technische Universität Dresden, Germany, focussed in the past on ITRF computation and combination strategies.

Table 1 Members of the VLBI group at GFZ without MSc students.

Name	Main activity
Harald Schuh	Head of Department 1 at GFZ
Robert Heinkelmann	Head of VLBI group
Tobias Nilsson	Head of software development
James Anderson	Satellite observations, D-VLBI
Kyriakos Balidakis	Atmospheric effects
Susanne Glaser	Simulations w.r.t. GGOS
Maria Karbon	Kalman filtering, EOP
Li Liu	Satellite observations
Cuixian Lu	Atmospheric effects
Julian Mora-Diaz	CRF, source structure
Virginia Raposo-Pulido	CRF, systematic effects
Benedikt Soja	Kalman filtering, atmosphere
Minghui Xu	CRF

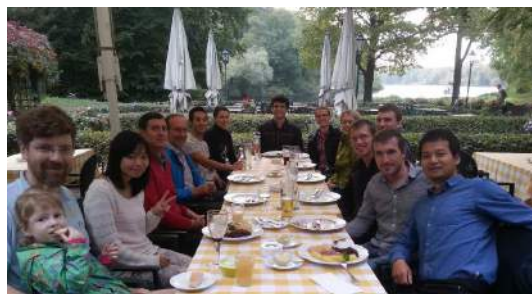

Fig. 1 The GFZ VLBI group and guests in September 2014 for the farewell of our guest Santiago Belda-Palazón (University of Alicante, Spain) and the welcome of Dr. Alexei Lapshin (Moscow State University of Geodesy and Cartography) at Wirtshaus Moorlake, Berlin-Wannsee. Missing colleagues: Cuixian Lu and Virginia Raposo-Pulido.

4 Current Status and Activities

• IVS Operational Analysis Center at GFZ

At GFZ we are preparing to become an operational AC of the IVS. Therefore, starting in mid 2014 we entered into the test phase. In accordance with the test phase, we are now analyzing all new rapid turnaround sessions, and we submit our SINEX files within one day after the version 4 (or higher) databases become available. Until the end of the test phase the GFZ contribution is being used for the official products but with a very small weight compared to operational ACs. During 2014, routines have been established and have been continuously improved in order to run the complete analysis chain as smoothly as possible, and several steps (such as downloading files necessary for analysis) have been completely automated. Doing so, wherever possible we already consider the future VGOS situation, where many routines applied today will have to be revised or have to deal with significantly more data and different data formats. In 2015 we will continue optimizing these routines, as well as improving our analysis setup including the valuable feedback we get from the IVS Combination Center at BKG. Hopefully we will be accepted as an operational AC in the near future.

• Contribution to ITRF2014

We made a complete reanalysis of all VLBI data available from IVS servers from 1979 until now. A part of the results of the reanalysis has been submitted for inclusion in the IVS contribution to the

ITRF2014. Statistics of the solution and first results are presented in [3].

- **VLBI Data Analysis using Kalman Filtering**

At GFZ we are developing our own version of the Vienna VLBI Software (VieVS, [1]), named VieVS@GFZ. Currently, a main part of this work is the implementation of a Kalman filter as an alternative to the single session least squares solver. The developments are funded by the research project *VLBI analysis in real-time (VLBI-ART)* (Austrian Science Fund FWF, project no. 24187). In 2014 a first version of the Kalman filter was completed that — as we believe — provides results of the same quality or better than those obtained with the least squares [4].

- **Space Applications**

The main research topic of the VLBI group at GFZ is the analysis of VLBI observations to spacecraft. Here, in the project *Ties between kinematic and dynamic reference frames (D-VLBI)* (Deutsche Forschungsgemeinschaft DFG, project no. SCHU 1103/4-1) we have been extending our VLBI analysis software VieVS@GFZ for group delay and differential VLBI observations to spacecraft, e.g. GNSS satellites [5], and to extragalactic radio sources. In 2015, we plan to perform differential VLBI observations towards various satellites and interplanetary spacecraft, such as RadioAstron, Gaia, and GNSS.

- **Simulation of the Global Geodetic Observing System**

Within the project *GGOS-SIM: Simulation of the Global Geodetic Observing System*³ (DFG, project no. SCHU 1103/8-1), Dr.-Ing. Susanne Glaser, our guest scientist from TU Berlin, will perform simulations of all four space geodetic techniques involved in ITRF computation: DORIS, GNSS, SLR, and VLBI together with colleagues from GFZ at Oberpfaffenhofen, Germany. The main goal of the project is to assess to what extent the ITRF can be improved by involving additional terrestrial collocation stations or by having several techniques co-located in space, e.g. onboard GRASP (Geodetic Reference Antenna in Space), a planned NASA mission.

- **Twin Telescope Simulations**

³ <http://www.earth.tu-berlin.de/menue/forschung/projekte/ggos-sim>

We have tested advanced analysis methods by performing simulations for the future VGOS network in cases where stations operate more than one antenna, e.g. so-called twin telescopes. More specifically, we investigated to what extent it is possible to combine the tropospheric parameters of these antennas in order to improve the data analysis. We found that this approach improves the estimated station coordinates as long as the separation between the antennas is smaller than about 1 km [8, 9].

- **Homogenization of Pressure Data**

In 2014, we started a process of calibration and homogenization of the long time series of pressure measurements (and other meteorological parameters) recorded at the IVS stations. This will be achieved involving pressure from numerical weather prediction models as well as measurements from surrounding WMO meteorological stations. At the end of the process we will have identified and removed biases, jumps, and other inhomogeneities in the long pressure time series, and at the same time we will have calibrated the mean value which will improve the accuracy. It is very important to have high quality pressure measurements for the VLBI data analysis for obtaining accurate zenith wet delay estimates because these parameters correlate with other parameters such as station coordinates [2].

- **Celestial Reference Frame**

Several studies related to improving the celestial reference frame (CRF) were performed. For example, we have studied the apparent proper motion of the ICRF2 special handling and other radio sources [7] and obtained source structure maps. Other subjects in this context were considerations about the datum definition [10, 11] and about the CRF systematics, such as the aberration caused by the acceleration of the ICRS origin [13]. Part of the work done here was funded by the project *ECORAS - extension of the coordinate parameterization of radio sources observed by VLBI* (DFG, project no. HE 5937/2-1).

- **Solar Corona Modeling**

In 2014 we continued studies related to measuring the electron density of the solar corona by VLBI observations angularly close to the Sun. The innovative approach and results are highlighted in [12].

5 Future Plans

The following activities are planned for 2015:

- Continuing our current investigations.
- Furthering the development of the software VieVS@GFZ. In particular we want to implement the bandwidth synthesis ambiguities and ionospheric delay determination as part of our VieVS@GFZ version. Development is also foreseen for preparing the software for VGOS.

Acknowledgements

We are grateful to the Austrian Science Fund (FWF) and to the German Research Foundation (DFG) for funding our projects, and we acknowledge the invaluable contributions of the other IVS components that enable our work.

References

1. J. Böhm, S. Böhm, T. Nilsson, A. Pany, L. Plank, H. Spicakova, K. Teke, and H. Schuh. The new Vienna VLBI software. In S. Kenyon, M. C. Pacino, and U. Marti, editors, *IAG Scientific Assembly 2009*, number 136 in International Association of Geodesy Symposia, pages 1007–1011, Buenos Aires, Argentina, 2012. Springer. doi:10.1007/978-3-642-20338-1_126.
2. R. Heinkelmann, J. Böhm, H. Schuh, and V. Tesmer. The effect of meteorological input data on the VLBI reference frames. In H. Drewes, editor, *Geodetic Reference Frames*, number 134 in International Association of Geodesy Symposia, pages 245–251, Munich, Germany, 2009. Springer. doi:10.1007/978-3-642-00860-3_38.
3. R. Heinkelmann, T. Nilsson, M. Karbon, L. Liu, C. Lu, J. A. Mora-Diaz, E. Parselia, V. Raposo-Pulido, B. Soja, M. Xu, and H. Schuh. The GFZ VLBI solution - characteristics and first results. In D. Behrend, K. D. Baver, and K. Armstrong, editors, *Proceedings of the Eighth IVS General Meeting: VGOS: The New VLBI Network*, pp. 330–334, 2014. ISBN 978-7-03-042974-2.
4. M. Karbon, B. Soja, T. Nilsson, R. Heinkelmann, L. Liu, C. Lu, J.A. Mora-Diaz, V. Raposo-Pulido, M. Xu, and H. Schuh. ERP estimation using a Kalman filter in VLBI. In D. Behrend, K. D. Baver, and K. Armstrong, editors, *Proceedings of the Eighth IVS General Meeting: VGOS: The New VLBI Network*, pp. 298–301 2014. ISBN 978-7-03-042974-2.
5. L. Liu, R. Heinkelmann, V. Tornatore, R. Haas, A. Neidhardt, D. Duev, J. Kodet, J. Li, T. Nilsson, M. Xu, C. Plötz, U. Schreiber, S. Pogrebenko, G. Kronschnabl, J.A. Mora-Diaz, B. Soja, M. Karbon, C. Lu, V. Raposo-Pulido, and H. Schuh. New progress in VLBI tracking of GNSS satellites at GFZ. In D. Behrend, K. D. Baver, and K. Armstrong, editors, *Proceedings of the Eighth IVS General Meeting: VGOS: The New VLBI Network*, pp. 456–460, 2014. ISBN 978-7-03-042974-2.
6. C. Lu, R. Heinkelmann, J. A. Mora-Diaz, C. Schwatke, T. Nilsson, L. Liu, M. Karbon, V. Raposo-Pulido, B. Soja, and H. Schuh. IVS rapid tropospheric parameter recombination and comparison with GNSS products. In D. Behrend, K. D. Baver, and K. Armstrong, editors, *Proceedings of the Eighth IVS General Meeting: VGOS: The New VLBI Network*, pp. 354–358, 2014. ISBN 978-7-03-042974-2.
7. J. A. Mora-Diaz, V. Raposo-Pulido, R. Heinkelmann, M. Xu, T. Nilsson, M. Karbon, L. Liu, B. Soja, C. Lu, and H. Schuh. Modeling special handling source positions in the GFZ VLBI solution. In D. Behrend, K. D. Baver, and K. Armstrong, editors, *Proceedings of the Eighth IVS General Meeting: VGOS: The New VLBI Network*, pp. 402–406, 2014. ISBN 978-7-042974-2.
8. T. Nilsson, B. Soja, M. Karbon, R. Heinkelmann, L. Liu, C. Lu, J. A. Mora-Diaz, V. Raposo-Pulido, M. Xu, and H. Schuh. Atmospheric modeling in the data analysis of twin telescope observations. In D. Behrend, K. D. Baver, and K. Armstrong, editors, *Proceedings of the Eighth IVS General Meeting: VGOS: The New VLBI Network*, pp. 36–39, 2014. ISBN 978-7-042974-2.
9. T. Nilsson, M. Karbon, B. Soja, R. Heinkelmann, C. Lu, and H. Schuh. Atmospheric modeling for co-located VLBI antennas and twin telescope. *J. Geodesy*, 2014. submitted.
10. V. Raposo-Pulido, R. Heinkelmann, T. Nilsson, M. Karbon, B. Soja, E. Tanır Kayıkcı, C. Lu, J. Mora-Diaz, H. Schuh, and J. Gómez-González. Effects of the datum configuration of radio sources on EOP determined by VLBI. In N. Capitaine, editor, *Proceedings of the Journées 2013 "Systèmes de Référence Spatio-Temporels"*, pages 105–106, Observatoire de Paris, France, 2014.
11. V. Raposo-Pulido, R. Heinkelmann, J. A. Mora-Diaz, M. Xu, T. Nilsson, M. Karbon, L. Liu, C. Lu, B. Soja, and H. Schuh. Datum effects on the stability of the celestial reference frame determined by VLBI. In D. Behrend, K. D. Baver, and K. Armstrong, editors, *Proceedings of the Eighth IVS General Meeting: VGOS: The New VLBI Network*, pp. 407–411, 2014. ISBN 978-7-042974-2.
12. B. Soja, R. Heinkelmann, and H. Schuh. Probing the solar corona with very long baseline interferometry. *Nature Comm.*, 5, 2014. doi:10.1038/ncomms5166.
13. M. Xu, R. Heinkelmann, H. Schuh, M. Zhao, and G. Wang. The acceleration of the origin of the ICRF. In D. Behrend, K. D. Baver, and K. Armstrong, editors, *Proceedings of the Eighth IVS General Meeting: VGOS: The New VLBI Network*, pp. 412–416, 2014. ISBN 978-7-042974-2.

BKG/IGGB VLBI Analysis Center

Volkmar Thorandt¹, Thomas Artz², Gerald Engelhardt¹, Dieter Ullrich¹, Sebastian Halsig², Christoph Holst², Andreas Iddink², Judith Leek², Axel Nothnagel²

Abstract In 2014, the activities of the BKG/IGGB VLBI Analysis Center, as in previous years, consisted of routine computations of Earth orientation parameter (EOP) time series and of a number of research topics in geodetic VLBI. The VLBI group at BKG continued its regular submissions of time series of tropospheric parameters and the generation of daily SINEX (Solution INdependent EXchange format) files. Quarterly updated solutions were computed to produce terrestrial reference frame (TRF) and celestial reference frame (CRF) realizations. The analysis of all *Intensive* sessions for UT1–UTC estimation was continued. Additionally, the BKG Analysis Center has generated input in the form of daily SINEX files for the ITRF2014 VLBI combination solution. All solutions are based on the new Calc/Solve software, release 2014.02.21 [1], following the IERS2010 conventions. At IGGB, the emphasis has been placed on individual research topics.

1 General Information

The BKG/IGGB VLBI Analysis Center was established jointly by the analysis groups of the Federal Agency for Cartography and Geodesy (BKG), Leipzig, and the Institute of Geodesy and Geoinformation of the University of Bonn (IGGB). Both institutions cooperate intensely in the field of geodetic VLBI. The responsibilities include both data analysis for generating

1. BKG
2. IGGB

BKG/IGGB Analysis Center

IVS 2014 Annual Report

IVS products and special investigations with the goal of increasing accuracy and reliability. BKG is responsible for the computation of time series of EOP and tropospheric parameters, for the generation of SINEX files for 24-hour VLBI sessions and one-hour *Intensive* sessions, and for the generation of quarterly updated global solutions for TRF and CRF realizations. Besides data analysis, the BKG group is also responsible for writing schedules for the Int2 UT1–UTC observing sessions. Details of the research topics of IGGB are listed in Section 3.

2 Data Analysis at BKG

At BKG, the Mark 5 VLBI data analysis software system Calc/Solve, release 2014.02.21 [1], has been used for VLBI data processing. It is running on a Linux operating system. Calc/Solve allows generation of so-called TRP files derived from the Vienna Mapping Function (VMF1) data. They contain external information about the troposphere on a scan-by-scan basis, specifically the a priori delay, dry and wet mapping functions, and gradient mapping functions. The BKG VLBI group uses TRP files to input data related to VMF1. The VMF1 data were downloaded daily from the server of the Vienna University of Technology. Additionally, the technological software environment for Calc/Solve was refined to link the Data Center management with the pre- and post-interactive parts of the EOP series production and to monitor all Analysis and Data Center activities.

- **Processing of correlator output**

The BKG group continued the generation of calibrated databases for the sessions correlated at the

MPIfR/BKG Astro/Geo Correlator at Bonn (e.g., EURO, OHIG, and T2) and submitted them to the IVS Data Centers.

- **Scheduling**

BKG continued scheduling the Int2 *Intensive* sessions, which are observed on the TSUKUBA-WETTZELL baseline. Altogether, 102 schedule files for this baseline were created in 2014. Due to maintenance of the TSUKUBA antenna, two schedule files for baseline KASHIM34-WETTZELL were also made available.

- **BKG EOP time series**

The BKG EOP time series bkg00013 was replaced by a new one, bkg00014. One main difference to the former solution was the use of the IERS2010 conventions. Further, two new VLBI stations (SEJONG in Korea and TIANMA65 in China) could be included successfully in data processing.

Each time after the preprocessing of any new VLBI session (correlator output database version 1), a new global solution with 24-hour sessions since 1984 was computed, and the EOP time series bkg00014 was extracted. Altogether, 4,728 sessions were processed. The main parameter types in this solution are globally estimated station coordinates and velocities together with radio source positions. The datum definition was realized by applying no-net-rotation and no-net-translation conditions for 25 selected station positions and velocities with respect to VTRF2008a and a no-net-rotation condition for 295 defining sources with respect to ICRF2. The station coordinates of the telescopes AIRA (Japan), CHICHI10 (Japan), CTVASTJ (Canada), DSS13 (USA), HART15M (South Africa), KASHIM11 (Japan), KASHIM34 (Japan), KOGANEI (Japan), KUNMING (China), PT_REYES (USA), SEJONG (Korea), SEST (Chile), SINTOTU3 (Japan), TIANMA65 (China), TIGOCONC (Chile), TSUKUB32 (Japan), UCHINOUR (Japan), VERAISGK (Japan), VERAMZSW (Japan), WIDE85_3 (USA), and YEBES40M (Spain) were estimated as local parameters in each session.

- **BKG UT1 *Intensive* time series**

The UT1-UTC *Intensive* time series bkgint09 was replaced by bkgint14 in consideration of the IERS2010 conventions. The series bkgint14 was generated with fixed TRF (VTRF2008a) and fixed ICRF2. The a priori EOP were taken from final

USNO series [2]. The estimated parameter types were only UT1-TAI, station clock, and zenith troposphere.

The algorithms of the semi-automatic process for handling the *Intensive* sessions Int2/3 with station TSUKUBA after the Japan earthquake [3] were further used; i.e. before the regular analysis can be started, the most probable station positions of TSUKUBA for the epochs of the Int2/3 sessions have to be estimated.

A total of 4,963 UT1 *Intensive* sessions were analyzed for the period from 1999.01.01 to 2014.12.31.

- **Quarterly updated solutions for submission to IVS**

In 2014, one quarterly updated solution was computed for the IVS products TRF and CRF. There are no differences in the solution strategy compared to the continuously computed EOP time series bkg00014. The results of the radio source positions were submitted to IVS in IERS format. The TRF solution is available in SINEX format, version 2.1, and includes station coordinates, station velocities, and radio source coordinates together with the covariance matrix, information about constraints, and the decomposed normal matrix and vector.

- **Tropospheric parameters**

The VLBI group of BKG continued regular submissions of long time series of tropospheric parameters to the IVS (wet and total zenith delays and horizontal gradients) for all VLBI sessions since 1984. The tropospheric parameters were extracted from the standard global solution bkg00014 and transformed into SINEX format.

- **Daily SINEX files**

The VLBI group of BKG also continued regular submissions of daily SINEX files for all available 24-hour sessions for the IVS combined products and for the IVS time series of baseline lengths. In addition to the global solutions, independent session solutions (bkg2014a) with the new models mentioned above were computed for the station coordinates, radio source coordinates except for 295 defining sources of ICRF2, and EOP parameters including the X,Y-nutation parameters. The a priori datum for TRF is defined by the VTRF2008a, and ICRF2 is used for the a priori CRF information.

- **SINEX files for *Intensive* sessions**

By using IERS2010 conventions, a new set of SINEX files for all *Intensive* sessions (bkg2014a)

was generated. The parameter types are station coordinates, pole coordinates and their rates, and UT1-TAI and its rate. But only the normal equations stored in the SINEX files are important for further intra-technique combination or combination with other space geodetic techniques.

- **Contribution to ITRF2014**

The BKG Analysis Center submitted 4,728 SINEX files for 24-hour sessions (bkg2014a.sn timerf2013) to IVS as input to a combined VLBI solution for ITRF2014.

3 Research Topics at IGGB

- **Development of automatic scheduling**

In the last years, an automatic scheduling method which is based on the so-called impact factors of the observations was developed at IGGB. These factors are closely related to the covariance matrix of the observations. Although 24-hour multi-baseline sessions can be scheduled, the main focus of the investigations is given to *Intensive* sessions with two or three telescopes and observing durations of only one hour. The procedure has been optimized further, and first schedules have actually been observed in 2014 showing promising results. At first glance, all standard deviations of the UT1-TAI estimates from observations scheduled with impact factors are small with no outliers compared to those from the standard approach. Further work has to be done to successfully apply the procedure to 24-hour sessions.

- **Application of inequality constraints**

When estimating zenith wet delays (ZWD) using the zenith hydrostatic delays (ZHD) as a priori information in a VLBI estimation process, sometimes negative values are present. But negative values do not correspond to actual meteorological conditions and physical properties. An Inequality Constrained Least Squares adjustment from the field of convex optimization has been applied to the VLBI data analysis to constrain these parameters to be non-negative. But deficiencies in the a priori ZHDs, for example due to missing or incomplete pressure data, are compensated by the ZWD estimates to close to 100%. For this purpose, different strategies to improve the a priori information have been in-

vestigated and adapted to the VLBI data analysis. First results are shown in [4].

- **Modifying the stochastic model**

Routinely, the stochastic model in VLBI data analysis only includes uncertainties from the VLBI correlation process. But dynamic processes in the atmosphere also lead to elevation-dependent uncertainties and induce physical correlations between the observations. Thus, the formal errors for the derived VLBI parameters are too optimistic. For this purpose, the standard stochastic information is augmented by a variance-covariance matrix derived from an atmospheric turbulence model [10], which is based on the Kolmogorov turbulence theory. Several solution setups with regard to different turbulence parametrizations have been applied to the CONT11 VLBI campaign. First results have shown that the WRMS post-fit residuals decrease and the baseline length repeatabilities improve slightly. But only minor variations between the different solution setups could be observed [5].

- **Determination of an ICRF combination approach including Ka-band catalogs**

The ICRF1 and ICRF2 were computed as monolithic dual frequency S/X-band (2.3/8.4 GHz) solutions from a single Analysis Center using a single analysis software package. In addition to an improved precision one of the main objectives for the upcoming realization of the ICRF3 is enhanced frequency coverage compared to the ICRF2. By including solutions with full variance-covariance information based on X/Ka-band (8.4/32 GHz) observations in a rigorous VLBI intra-technique combination, an improved frequency coverage can be realized. A method to mix the combination on the level of datum free normal equation systems and on the solution level with full covariance information has been developed and implemented in the existing combination software BonnSolutionCombination (BoSC) developed at IGGB [6]. Preliminary results of a combined S/X- and X/Ka-band catalog verify the correct functionality.

- **Studies on VLBI observations of satellites**

Observing moving targets, such as e.g., Earth orbiting satellites, with radio telescopes is not new. But for the future, important investigations have to be done to observe artificial sources routinely. At IGGB, the scheduling procedure described above was extended to handle artificial sources. In this

way, schedules for geostationary satellites [7] as well as global navigation satellite system (GNSS) satellites were created. To assess the various schedules, observations were simulated based on clock noise and atmospheric noise as well as baseline dependent noise terms. From these observations, orbit shifts were estimated and compared.

- **Improved deformation analysis of the Effelsberg 100-m radio telescope**

In 2013, an improved measurement concept was built up to scan the main reflector of the Effelsberg 100-m radio telescope in seven different elevation angles between 90° and 7.5° [8]. During the scan procedure, the scanner was mounted directly below the subreflector. This position enabled sampling of the main reflector in a single scan with almost no shadowing effects. Based on these measurements, an upgraded data processing containing object segmentation, point cloud reduction, and laser scanner self-calibration has been implemented. This improves the accuracy and the reliability of the derived estimates representing focal length variations as well as local, area-based, and elevation dependent deformations on the main reflector's surface. As a result, the focal length of the 100-m radio telescope Effelsberg decreases by 22.7 mm when tilting the telescope from 90° to 7.5° . Area-based deformations of ± 2 mm have been detected as well at certain areas. Furthermore, the misalignment of several surface panels has been revealed.

- **Delay corrections for deforming radio telescopes**

Gravitational deformation of radio telescopes is another source of uncertainty of geodetic and astrometric VLBI. In a study, which also includes the development of a ray tracing program, a complete model of gravitationally induced path length deviations was developed. It includes delay correction components for all deformable parts of a radio telescope. Using information of the improved deformation analysis reported above and other auxiliary measurements, a complete delay model was published for the Effelsberg 100-m radio telescope [9].

4 Personnel

Table 1 Personnel at the BKG/IGGB Analysis Center

Thomas Artz	IGGB	+49-228-733563	artz@igg.uni-bonn.de
Gerald Engelhardt	BKG	+49-341-5634438	gerald.engelhardt@bkg.bund.de
Sebastian Halsig	IGGB	+49-228-732623	halsig@igg.uni-bonn.de
Christoph Holst	IGGB	+49-228-733570	holst@igg.uni-bonn.de
Andreas Iddink	IGGB	+49-228-732623	iddink@igg.uni-bonn.de
Judith Leek	IGGB	+49-228-733565	judith.leek@igg.uni-bonn.de
Axel Nothnagel	IGGB	+49-228-733574	nothnagel@uni-bonn.de
Volkmar Thorandt	BKG	+49-341-5634285	volkmar.thorandt@bkg.bund.de
Dieter Ullrich	BKG	+49-341-5634328	dieter.ullrich@bkg.bund.de
Reiner Wojdziak	BKG	+49-341-5634286	reiner.wojdziaak@bkg.bund.de

References

1. GSFC, NASA (2014): Release of Mark 5 VLBI Analysis Software Calc/Solve from February 21, 2014 (Web reference: <http://gemini.gsfc.nasa.gov/solve>).
2. USNO (2014): Earth orientation parameters series from finals USNO series 2014, (Web reference: http://gemini.gsfc.nasa.gov/500/oper/solve.apriori_files/usno_finals.erp).
3. Engelhardt G, Thorandt V, Ullrich D (2013): Rapid UT1 Estimation Derived from Tsukuba VLBI Measurements after 2011 Earthquake. In: Proceedings of the 21st Meeting of the European VLBI Group for Geodesy and Astronomy 2013, edited by N Zubko and M Poutanen, pages 85-87, Kirkkonummi 2013, Finland
4. Halsig S, Artz T, Nothnagel A (2015): Improved Parameter Estimation of Zenith Wet Delay Using an Inequality Constrained Least Squares Method. In: IAG Symposia Series, vol. 43, in press
5. Halsig S, Artz T, Leek J, Nothnagel A (2014): VLBI analyses using covariance information from turbulence models. In: Proceedings of the IVS General Meeting 2014, edited by D Behrend, KD Bayer, and KL Armstrong, pages 272-276, Science Press 2014, China
6. Iddink A, Artz T, Nothnagel A (2015): Development of a Combination Procedure for Celestial Reference Frame Determination. In: IAG Symposia Series, vol. 43, in press
7. Artz T, Leek J, La Porta L, Nothnagel A (2015): Scheduling Scenarios for VLBI Observations of Satellites. In: IAG Symposia Series, vol. 43, in press
8. Holst Ch, Nothnagel A, Blome M, Becker P, Eichborn M, Kuhlmann H (2015): Improved area-based deformation analysis of a radio telescope's main reflector based on terrestrial laser scanning. J. Appl. Geodesy, in press
9. Artz T, Springer A, Nothnagel A (2014) A complete VLBI delay model for deforming radio telescopes: the Effelsberg case. J Geod, 88(12):1145—1161, DOI 10.1007/s00190-014-0749-1
10. Brunner FK, Schön S (2008): Atmospheric turbulence theory applied to GPS carrier-phase data. J Geod, 82:47-57, DOI: 10.1007/s00190-007-0156-y

GSFC VLBI Analysis Center Report

David Gordon ², Chopo Ma ¹, Dan MacMillan ², John Gipson ², Sergei Bolotin ², Karine Le Bail ², Karen Baver ²

Abstract This report presents the activities of the GSFC VLBI Analysis Center during 2014. The GSFC VLBI Analysis Center analyzes all IVS sessions, makes regular IVS submissions of data and analysis products, and performs research and software development aimed at improving the VLBI technique.

1 Introduction

The GSFC VLBI Analysis Center is located at NASA's Goddard Space Flight Center in Greenbelt, Maryland. It is part of a larger VLBI group which also includes the IVS Coordinating Center, the CORE Operation Center, a Technology Development Center, and a VGOS Station. The Analysis Center participates in all phases of geodetic and astrometric VLBI analysis, software development, and research. We maintain a Web site at <http://lupus.gsfc.nasa.gov>. We provide a pressure loading service to the geodetic community, a ray tracing service, and additional services for hydrology loading, nontidal ocean loading, and meteorological data. These services can be found by following the links on the GSFC VLBI group Web site: http://lupus.gsfc.nasa.gov/dataresults_main.htm.

1. NASA Goddard Space Flight Center

2. NVI, Inc./NASA Goddard Space Flight Center

GSFC Analysis Center

IVS 2014 Annual Report

2 Analysis Activities

The GSFC VLBI Analysis Center analyzes all IVS sessions using the *Calc/Solve/vSolve* systems, and performs the *fourfit* fringing and *Calc/Solve* analysis of the VLBA-correlated RDV sessions. The group submitted the analyzed databases to IVS for all R1, RDV, R&D, CONT14, AUST, INT01, and INT03 sessions. During 2014, GSFC analyzed 198 24-hour sessions (51 R1, 51 R4, seven RDV, three R&D, 15 CONT14, 48 AUST, six EURO, four T2, five OHIG, three CRF, and five CRDS) and 376 one-hour UT1 sessions (229 INT01, 99 INT02, and 48 INT03), and we submitted updated EOP and daily Sinex files to IVS immediately following analysis. We also generated a solution for the ITRF2013 IVS combination solution.

3 Research Activities

- **Source Monitoring:** We continued monitoring sources observed in different categories: ICRF2, geodetic, ICRF2 non-geodetic, special handling, and Gaia link sources (categories 1 to 4). The geodetic sources have a target of 12 sessions per year, the ICRF2 sources five per year, the special handling six per year, and the Gaia link sources 12 per year.
- **Gaia Transfer Sources:** In 2014, we continued to monitor the 195 Gaia link sources proposed by Bordeaux Observatory, setting a target of 12 observations per year. Thirty-three of these can only be detected in R&D and RDV sessions because they are weak sources. The Gaia link source position uncertainties were all improved, and most are now better

than 100 μas . But seven of the weakest category 4 sources still have large position uncertainties. We also updated the *sked* flux catalog with more realistic values from recent observations.

- Source Name Translation Table: A source name translation table was compiled from different files: IERS TN35, the *Calc/Solve* blokq file, the latest GSFC source catalog, the NRAO *SCHED* catalog, the RFC catalog, and the JPL X/Ka catalog. This table specifies IVS, J2000 (long and short), IERS/B1950, and JPL names, as well as coordinates in J2000 and first date of observation. More information and access to the file can be found following this link: http://lupus.gsfc.nasa.gov/IVS-AC_data_information.htm, under the name “official IVS source name and translation table”.
- Stability of ICRF2: In 2010, we presented a method to analyze source position time series and evaluate the statistical time stability of sources, and we generated stability index functions. At the IVS 2014 General Meeting, we presented a re-evaluation of this work, using the latest GSFC source time series, and compared it to the solution computed in 2009. We showed how five more years of data can strengthen statistical studies. For 3C418, for example, the Allan variance showed a threshold of 50 μas for the noise level (flicker noise) for both coordinates in 2010. With five more years of data, the threshold is passed, and the declination white noise reaches a level of 10 μas . We also showed that the ICRF2 defining sources realize a more stable frame, suggesting that the solutions are getting more consistent, and the latest solution shows better statistical stability.
- Second Epoch VCS Observations: A proposal to re-observe up to 2,400 VCS (VLBA Calibrator Survey) sources on the VLBA was begun. The investigators are D. Gordon (PI), C. Ma, six other IVS members, and two NRAO astronomers. Six of the eight 24-hour sessions were run in 2014. Of 1,800 sources observed, 1,556 sources were re-observed, and 231 new sources were detected. For the re-observed sources, position formal errors were reduced by a factor of ~ 3.2 in both RA and Declination.
- Galactic aberration: The aberration acceleration vector estimated from VLBI has a large component in the direction of the Galactic center due to the rotation of the Solar System barycenter around the

Galactic center. Our estimate of this component is $5.3 \pm 0.3 \mu\text{as/year}$, which is close to estimates from parallax measurements (Reid et al., [Ap J, 783:130, 2014] estimated $4.9 \pm 0.4 \mu\text{as/year}$). Our estimated aberration vector has a significant component, $1.7 \pm 0.4 \mu\text{as/year}$, perpendicular to this direction, which at this point is unexplained.

- Intensive Scheduling: Since mid-2010, two alternating strategies have been used to schedule the IVS-INT01 sessions: the original strategy (‘STN’) and the Maximal Source Strategy or MSS. The STN emphasizes source strength over sky coverage, using a catalog with a small number of strong sources, while the MSS emphasizes sky coverage over source strength, using a catalog of all the geodetic sources. In 2014, we investigated the use of catalogs with intermediate numbers of sources and different balances of source strength and sky coverage. We also used two different approaches to generating source catalogs: using a certain number of sources best for observing throughout the year and a certain number of sources best for observing at specific times of the year. We conducted two studies. The first one determined that smaller numbers of sources tend to be better in each approach, and the second one indicated the best number of sources in each approach. We plan to examine the cases identified in the second study in more detail during 2015.
- High Frequency EOP: We estimated an empirical model of diurnal and semi-diurnal Earth Rotation (‘HF-EOP’) derived from 35 years of VLBI data, and we compared the results against other models derived from Space Geodesy (SG) using GPS and/or VLBI, as well as results derived from various satellite altimetry tidal models (‘tidal models’). Overall there was good agreement among the empirical SG HF-EOP models, as well as HF-EOP models derived from altimetry data. A difference between the two classes of models is that the SG HF-EOP models are generally given in terms of the amplitudes and phases of 71 terms in the tidal potential. In contrast the altimetry derived models are given in terms of 12 ortho-tides. We directly estimated the ortho-tide coefficients from VLBI data. Comparing a time series generated using these two approaches, we found that the orthotide formalism does not capture all of the signal. Increasing the

number of ortho-tide terms to 20 reduces but does not eliminate the residual signal.

- **Troposphere Raytracing:** We investigated the calculation of troposphere ray trace delays along the signal path through the troposphere for each VLBI observation and their application in VLBI analysis. Tropospheric refractivity fields were determined from the pressure, temperature, specific humidity, and geopotential height fields of the NASA GSFC GEOS-5 numerical weather model. Compared with VMF1, baseline length and vertical site repeatabilities were improved for 72% of baselines and 11 of 13 sites for the CONT11 data set as well as for a larger data set (2011-2013). A ray tracing service provides ray trace delays for all VLBI sessions since 2000 at <http://lacerta.gsfc.nasa.gov/tropodelays>.
- **Hydrology Loading:** We found that VLBI analysis results are improved if hydrology loading is modeled. Hydrology loading series were calculated from 1) the GSFC GLDAS hydrology model data or 2) GRACE (Gravity Recovery and Climate Experiment) mascon data. Applying either series in VLBI analysis yielded a reduction in 1) baseline length repeatabilities for 80% of baselines, 2) site vertical repeatabilities for 80% of sites, and 3) annual site vertical amplitudes for 90% of sites. The GLDAS loading series for VLBI sites are available at <http://lacerta.gsfc.nasa.gov/hydro>.
- **Update of Meteorological Data Web Service:** We continued updating the meteorological data Web service (<http://lacerta.gsfc.nasa.gov/met>) with the latest data from ECMWF. The last data processed is December 31, 2014. This website contains time series (1979 to end of 2014) of pressure and temperature for 171 VLBI stations.
- **Network Connectivity:** We investigated network connectivity to see if this could provide us with insight into past performance or future scheduling of networks. We looked at several questions, such as how the VLBI networks have evolved; what stations observe most frequently with other stations; whether there are stations that are relatively isolated from the rest of the VLBI networks and what effect this has, and whether or not the relative number of successful observations between two sites can be computed. Although this work has not yet led to any conclusions, a by-product has been

the development of tools to display networks and to interactively rotate figures of them on the screen.

- **SGP Future Network Simulations:** We have continued collaborating with Erricos Pavlis and Magda Kuzmich-Cieslak (UMBC) to optimize the choice of a global network of co-located technique sites and specifically to decide where NASA should establish new sites. The VLBI observation and solution setup input was provided to the *Geodyn* software for SLR+VLBI+GPS combination solutions. The simulation input is for a broadband-only network and several mixed broadband/legacy station networks, which we consider a reasonable expectation of observing in five years. We are working on the simulation input for the future network in ten years, which is expected to have about 30 broadband antennas.

4 Software Development

The GSFC VLBI Analysis Center develops and maintains the *Calc/Solve* analysis system, a package of ~120 programs and 1.2 million lines of code. During 2014, we switched over to version 11 of *Calc*, which complies with the IERS 2010 Conventions.

vSolve is a part of the next generation VLBI data analysis software. It is being developed as a replacement for interactive *SOLVE*. *vSolve* is now the standard tool for initial processing of routine VLBI sessions at GSFC, and it was used to analyze the first experimental broadband (VGOS) VLBI observations. Also, an automated processing mode for Intensive sessions was developed and is being tested. A User Guide was also written. The first public release of *vSolve* was made in 2014. It is available at: <ftp://gemini.gsfc.nasa.gov/pub/misc/slb/>.

5 Staff

During 2014, the Analysis Center staff consisted of one GSFC civil servant, Dr. Chopo Ma, and six NVI, Inc. employees who work under contract to GSFC. We also had two temporary student interns from Chalmers University of Technology (Sweden). Dr. Ma oversees the GSFC VLBI project for GSFC and is also the IVS

co-representative to the IERS. Dr. John Gipson is the GSFC VLBI Project Manager as well as the IVS Analysis Coordinator. Table 1 lists the staff members and their main areas of activity.

Table 1 Staff members and their main areas of activity.

Ms. Karen Bayer	Intensive analysis, monitoring, and improvement; software development; Web site development; quarterly Nuvel updates.
Dr. Sergei Bolotin	Database analysis, <i>vSolve</i> development, vgosDB development, ICRF3.
Dr. John Gipson	High frequency EOP, parameter estimation, vgosDB development, station dependent noise.
Dr. David Gordon	Database analysis, RDV analysis, ICRF3, astronomical source catalogs, VCS-II observations, <i>calc/difxcalc</i> development, quarterly ITRF updates.
Dr. Karine Le Bail	Source monitoring, time series statistical analysis (EOP, nutation, source positions), database meteorological data analysis.
Dr. Chopo Ma	ICRF3, CRF/TRF/EOP, VGOS development.
Dr. Daniel MacMillan	CRF/TRF/EOP, mass loading, antenna deformation, aberration, VGOS and SGP simulations, VLBI/SLR/GPS combinations.
Ms. Linnea Hesslow (Intern)	High frequency EOP, network connectivity.
Ms. Emma Woxlin (Intern)	Station stabilities, vgosDB development.

6 Future Plans

Plans for the next year include ICRF2 maintenance, second epoch VCS observations and analysis, preparations for ICRF3, participation in VGOS development, continued development of *vSolve* and the new vgosDB data format, and further research aimed at improving the VLBI technique.

7 Publications

‘Tropospheric Delay Raytracing Applied in VLBI Analysis’, David Eriksson, D.S. MacMillan, John M. Gipson, *J. Geophys. Res. Solid Earth*, 119, doi:10.1002/2014JB011552, 2014.

‘Continental Hydrology Loading Observed by VLBI Measurements’, David Eriksson and D.S. MacMillan, *J. Geod.*, 88:675-690, doi:10.1007/s00190-014-0713-0, 2014.

‘IVS Working Group IV and the New Open Format Database’, John Gipson, *IVS 2014 General Meeting Proceedings*; D. Behrend, K. D. Bayer, K. L. Armstrong (editors); p. 248-252, 2014.

‘The VLBI Analysis Software *vSolve*: Development Progress and Plans for the Future’, S. Bolotin, K. Bayer, J. Gipson, D. Gordon, D. MacMillan, *IVS 2014 General Meeting Proceedings*; D. Behrend, K. D. Bayer, K. L. Armstrong (editors); p. 253-257, 2014.

‘Balancing Sky Coverage and Source Strength in the Improvement of the IVS-INT01 Sessions’, Karen Bayer, John Gipson, *IVS 2014 General Meeting Proceedings*; D. Behrend, K. D. Bayer, K. L. Armstrong (editors); p. 267-271, 2014.

‘Troposphere Delay Raytracing Applied in VLBI Analysis’, David Eriksson, Daniel MacMillan, John Gipson, *IVS 2014 General Meeting Proceedings*; D. Behrend, K. D. Bayer, K. L. Armstrong (editors); p. 279-282, 2014.

‘Revisiting the VLBA Calibrator Surveys for ICRF3’, David Gordon, *IVS 2014 General Meeting Proceedings*; D. Behrend, K. D. Bayer, K. L. Armstrong (editors); p. 386-389, 2014.

‘The NASA Goddard Group’s Source Monitoring Database and Program’, John Gipson, Karine Le Bail, Chopo Ma, *IVS 2014 General Meeting Proceedings*; D. Behrend, K. D. Bayer, K. L. Armstrong (editors); p. 390-394, 2014.

‘Evaluation of the Stability of ICRF2 in the Past Five Years Using the Allan Variance’, Karine Le Bail, David Gordon, John Gipson, *IVS 2014 General Meeting Proceedings*; D. Behrend, K. D. Bayer, K. L. Armstrong (editors); p. 395-398, 2014.

Haystack Observatory Analysis Center

Arthur Niell, Roger Cappallo, Brian Corey, Mike Titus

Abstract Analysis activities at Haystack Observatory are directed at improving the accuracy of geodetic measurements, whether these are from VLBI, GNSS, SLR, or any other technique. Those analysis activities that are related specifically to technology development are reported elsewhere in this volume for the Haystack IVS Technology Development Center, although sometimes the distinction is not clear. In this article we describe upgrades to the VGOS signal chain instrumentation at GGAO12M and Westford, present a preliminary analysis of the one-hour VGOS session held in December 2014, and discuss the results and potential impact of measurements of apparent cable delays for both the GGAO12M and Westford broadband systems

1 Introduction

The broadband instrumentation for the next generation geodetic VLBI system, previously called VLBI2010 but now referred to as VGOS (for VLBI2010 Global Observing System), was implemented on a new 12-m antenna at Goddard Space Flight Center near Washington, D.C. and on the Westford 18-m antenna at Haystack Observatory near Boston, Massachusetts, USA. In October 2012, the first geodetic observing sessions were conducted using the broadband system, and in May 2013 a 24-hour session yielded measurements of correlated flux densities as well as estimation

MIT Haystack Observatory

Haystack Analysis Center

IVS 2014 Annual Report

of geodetic parameters. Results from these sessions were described in previous IVS publications [1] [2].

Most of 2014 was an upgrade period for the Westford 18-m antenna broadband system. The only session with reportable geodetic VLBI results was observed on December 19, 2014.

In the area of analysis of measurements related to geodetic accuracy, several single-antenna sessions were used to determine the instrumental effects which might degrade the accuracy of the VLBI observations, such as sensitivity of cable electrical length to antenna position or motion.

In this report we highlight changes in the instrumentation that have been implemented since the previously reported results, summarize the geodetic analysis of the December session, and describe some results of the measurements made to determine the extent of uncalibrated orientation-dependent and motion-induced variations in cable electrical length.

While these activities are being reported as part of the Analysis Center activity at Haystack, the division between technology development and technique development is fuzzy. The activities that are reported here are related to analysis of the VGOS observations and validation of the technique.

The features of the VGOS system as implemented on the GGAO12M and Westford antennas are repeated here for reference:

- four bands of 512 MHz each, rather than the two (S and X) for the Mark IV systems
- dual linear polarization in all bands
- multitone phase cal delay for every channel in both polarizations
- group delay estimation from the full spanned bandwidth, which in recent sessions extends from 3.0 GHz to approximately 10.7 GHz

- simultaneous estimation of the total electron content difference (dTEC) between sites and the ionosphere-free group delay, using the phases across all four bands.

The features indicated in the last three bullets have required changes in analysis of the geodetic delays, and these have been implemented in the post-correlation software *difx2mark4* and *fourfit*.

2 Instrumentation Improvements and Observing Parameters

Several improvements were made to the instrumentation after the May 2013 session. In the Westford front end (Dewar and post-Dewar electronics), the Monitor and Control Instrumentation was rebuilt to provide more reliable and versatile functionality. But the most significant changes were the upgrades of the digital backends from RDBE-H (real samples, Mark 5B format) to the RDBE-G (complex samples, VDIF format). Internally the RDBEs were improved by the replacement of both the NRAO synthesizer and the attenuator assembly with, respectively, a much simpler Haystack-designed synthesizer and commercial attenuators. The RDBE-G also has a new personality (fpga3.0) that incorporates noise diode control; internal time-comparison of the GPS, maser 1pps, and RDBE pulse; and pulse cal extraction. Equally significant, recording is now on a single Mark 6 instead of four Mark 5Cs.

The frequencies of the four 512 MHz bands were chosen to span the range 3 GHz to 10.7 GHz with lower edges of approximately 3.0 GHz, 5.2 GHz, 6.4 GHz, and 10.2 GHz. The lower limit was chosen to avoid the effect of RFI at S-band for these initial VGOS sessions, and the high frequency limit was chosen to make use of the upper end of the available frequency range of the UpDown Converter, but to be below the frequency where the sensitivity begins to decrease significantly. The frequencies of the two intervening bands were proposed by Bill Petrachenko (private communication) to provide the best delay precision when the TEC difference between antennas is also estimated.

The frequency sequence, or ‘frequency’, within a band was changed to a minimum redundancy sequence,

thus improving the delay sensitivity and reducing the sidelobes in the delay resolution function [3].

3 The Observing Session of December 19, 2014

This one-hour session, denoted X141219, was initially planned to be the first of a series of sessions for which the only objective was to develop observing procedures for the two stations, but interest evolved, and the goal was expanded to encompass all activities associated with a VGOS observing session.

The schedule was generated using *sked*. As reported last year, because *sked* does not yet have the capability to account for the antenna performance at all four bands, the SEFDs at both S-band and X-band as used in *sked* for the two antennas were adjusted to allow use of the R1 session parameters. The 100 strongest sources were selected from the catalog of good geodetic sources. The minimum elevation was set to 5° for both antennas (although it was subsequently discovered that the minimum usable elevation for GGAO12M is 6.25°). Furthermore, for GGAO a cone with half-angle of about 20° centered on the direction to the SLR site to the southwest was masked out to avoid potential damage to the LNAs by the SLR aircraft avoidance radar. A minimum scan length of 30 seconds was set, and the minimum SNR was set to 15 for both bands. As generated by *sked* the average observed scan length was 31 seconds, and the average number of scans per hour was 48. The observed SNRs for the coherent fit of all bands and both polarizations range from 38 to 375 with a median value of 83. From these numbers it is clear that for future sessions the minimum observation time can be significantly reduced if the goal is a minimum SNR of 20. Of course weaker sources can also be introduced to improve the sky coverage.

The process for the geodetic analysis of the session is described in the Haystack Observatory Analysis Center Annual Report for 2013 [4]. Briefly summarized, the correlator output from each of the four bands is processed with *fourfit* to determine that the same clock offset model can be used and that the data quality is acceptable; the four bands are combined in one file using *fourmer*; the delay and phase offsets between polarizations are obtained from one or more

strong sources using one polarization of GGAO12M as the reference; *fourfit* is run on the combined data from all four bands, including both polarizations, to determine a single delay observable; the *fourfit* output is converted to a database and meteorological data are added, and parameter estimation is done using *nuSolve*.

For the *nuSolve* analysis, because this is only a one-hour session, the model parameterization was relatively simple. The estimated parameters were the clock behavior at GGAO, the position of GGAO, and the atmosphere zenith delays and gradients at both stations. The clocks and atmospheres were modeled as piecewise-linear (PWL) functions using the default constraints from *nuSolve*. The post-fit delay residuals are shown in Figure 1. The WRMS is 5.6 psec.

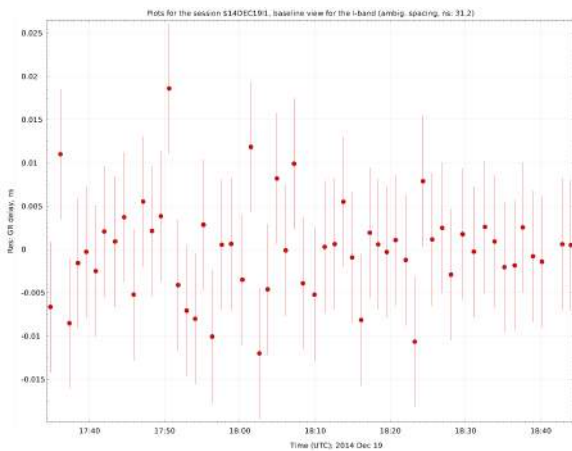

Fig. 1 Group delay post-fit residuals for X141219 after re-weighting. The weighted RMS value is 5.6 psec. The horizontal axis is time, spanning the 72 minutes of the session. The vertical axis is delay in nanoseconds, from -0.020 to +0.025.

The uncertainties for the position components of GGAO are sensitive to the length of the segments of the clocks, zenith wet delays, and gradients. The solution corresponding to Figure 1 used four segments for each of clocks and ZWDs and two segments of gradients in the one hour session. The resulting uncertainties for GGAO in Up, East, and North are 6.1, 2.5, and 1.6 mm.

4 Uncorrected Delays Due to Antenna Motion

As mentioned in last year's report, the two sites do not yet have delay measurement instrumentation for the cable carrying the 5 MHz reference signal from the maser to the phase calibration generator in the front end. Any variation of delay in this cable would thus produce an uncorrected variation in the observed delay. If this variation is correlated with antenna position, it may result in an error in the estimated position. The most common problem is for the delay to vary due to cable stretching with motion in elevation or in azimuth (or both), although change related to thermal variation as solar illumination varies might have a small effect.

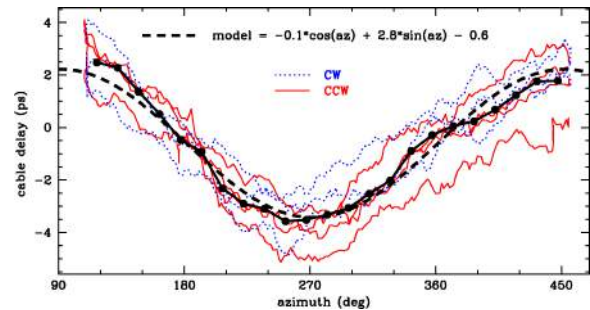

Fig. 2 Azimuthal variation of Westford 5 MHz one-way cable delay on June 20, 2014 measured with a Mark IV cable cal system. Each thin line represents the delays measured while the antenna slewed $\sim 345^\circ$ in one direction, with dotted lines = CW and solid lines = CCW; data have been smoothed with $\sim 20^\circ$ boxcar averaging. Heavy solid curve and points are medians of unsmoothed data in 15° bins, and heavy dotted line is a best-fit sinusoid. Azimuth limits at Westford are 90° and 470° .

In 2014, the 5 MHz cables at both sites were replaced because the old cables exhibited strong azimuthal delay dependence of 20-30 ps. Significant reduction in the azimuth variation was achieved at both sites, as shown in Figures 2 and 3. At Westford the azimuth dependence is well described by a sinusoid of amplitude ~ 3 ps. If VLBI data are left uncorrected for this effect, a shift in the local E-W position of ~ 1 mm will result. At GGAO the delay variation over azimuth is ~ 1 ps with the LMR-400UF cable and ~ 8 ps with the RG-214 cable. Hysteresis effects of order 2-3 ps are present with the RG-214 cable, as seen in the differences between the CW and CCW data; these

effects make it difficult to model the variations. A further complication to modeling is the fact that the GGAO delays are the sum of uplink and downlink delays, whereas corrections should only be made for the uplink delay. At present the LMR-400UF cable, with its smaller azimuth dependence and hysteresis, is used to carry the 5 MHz signal. The elevation delay dependence (not shown) is $< \sim 1$ ps at both sites.

It is clear from cable delay measurements conducted over the last few years that the 5 MHz cables can degrade over time scales of months to years, in the sense of developing stronger azimuth variations and hysteresis effects. Until permanent cable measurement systems are installed at both sites, periodic monitoring of the cable delays will be carried out to check for changes in the orientation dependence.

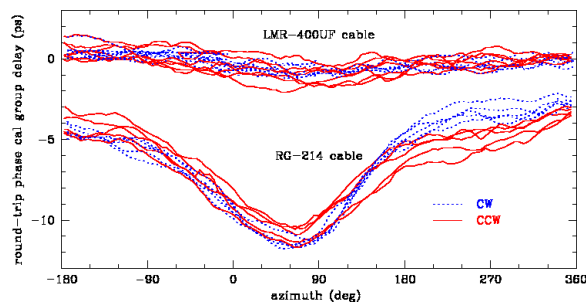

Fig. 3 Azimuthal variation of the GGAO 12-m round-trip cable delay on December 5, 2014 for two different 5 MHz cables. Delay is the group delay of the phase cal phases over a 500 MHz span and represents the sum of the delays in the uplink 5 MHz coax cable and the downlink RF optical fiber. Data have been smoothed with 20° boxcar averaging. Azimuth limits on the 12 m are -180° and 360° .

5 Outlook

Observations using the GGAO12M and Westford antennas are scheduled to become more frequent beginning in January 2015 with the initiation of the VGOS Demonstration Series. This series will initially be a set of six bi-weekly sessions of nominally one hour duration using the same observing configuration as was used for the X141219 session. The goal for the observations is to develop and demonstrate the full data path for a VGOS session, from schedule to analysis. Based

on the degree of success of those sessions, the duration of a session and the frequency of further observations may be increased. Other session parameters, such as length of scan and the band frequencies, will also be investigated. By mid-year, monthly twenty-four hour sessions are expected to be conducted.

Acknowledgements

We thank the Broadband Development group for their efforts in constructing, implementing, and operating the systems at GGAO and at Westford and for assisting in the testing and observations; John Gipson for guidance in getting sked to work; David Gordon for getting the broadband output into databases; and Sergei Bolotin for developing *nuSolve* and getting it to work with the new broadband observable.

References

1. Niell et al., First Broadband Results with a VLBI2010 System, IVS 2012 General Meeting Proceedings, NASA/CP-2012-217504, D. Behrend and K. D. Baver (eds.), 13-17, 2012. <http://ivscc.gsfc.nasa.gov/publications/gm2012>.
2. Niell et al., VGOS Operations and Geodetic Results, IVS 2014 General Meeting Proceedings “VGOS: The New VLBI Network”, D. Behrend, Karen D. Baver, and Kyla L. Armstrong (eds.), 97-101, Science Press (Beijing). ISBN 978-7-03-042974-2, 2014. <http://ivscc.gsfc.nasa.gov/publications/gm2014>.
3. Rogers, A. E. E., Effective Bandwidth for Phase Delay Measurements, *Radio Sci.*, 5, 1239-1247, 1970.
4. Niell et al., Haystack Observatory Analysis Center, in International VLBI Service for Geodesy and Astrometry 2013 Annual Report, edited by K. D. Baver, D. Behrend, and K. L. Armstrong, NASA/TP-2014-217522, 276-279, 2014. <http://ivscc.gsfc.nasa.gov/publications/ar2013/index.html>.

IAA VLBI Analysis Center Report 2014

Elena Skurikhina, Sergey Kurdubov, Vadim Gubanov, Daniil Shigaev

Abstract This report presents an overview of the IAA VLBI Analysis Center activities during 2014 and the plans for the coming year.

tensive VLBI sessions and submitted the results to the IERS and the IVS on a regular basis. Processing of the Intensive sessions is fully automated. The EOP series *iaa2007a.eops* and *iaa2005a.eopi* and troposphere parameters *iaa2007a.trl* were continued.

1 General Information

The IAA IVS Analysis Center (IAA AC) is located at the Institute of Applied Astronomy of the Russian Academy of Sciences in St. Petersburg, Russia. The IAA AC contributes to IVS products, such as daily SINEX files, TRF, CRF, rapid and long-term series of EOP, and tropospheric parameters. EOP, UT1, station positions, and tropospheric parameters were estimated from domestic observation programs Ru-E and Ru-U. The IAA AC generates NGS files.

2.2 Global Solution

iaa2014a.crf and *iaa2014a.trf* were submitted to IVS. A new global solution was calculated using all available data from 1980 until June 2014. A total of 6,912,198 delays were processed. The CRF was fixed by NNR constraints to 212 radio sources. The TRF was fixed by NNR and NNT constraints to the station positions and velocities of 15 stations: MATERA, KOKEE, WETTZELL, FORTALEZA, WESTFORD, ALGOPARK, NYALES20, ONSALA60, HARTRAO, BR-VLBA, FD-VLBA, HN-VLBA, KP-VLBA, LA-VLBA, and NL-VLBA. Stochastic signals were estimated by means of the least-squares collocation technique. The radio source coordinates, station coordinates, and corresponding velocities were estimated as global parameters. EOP, WZD, troposphere gradients, and station clocks were estimated as arc parameters for each session. 6,732 global parameters were estimated: 2,946 source positions, the positions and the velocities of 117 VLBI stations, and 23 position and velocity discontinuities.

2 Activities during the Past Year

2.1 Routine Analysis

During 2014, the IAA AC continued to submit daily SINEX files for the IVS-R1 and IVS-R4 sessions as rapid solution (*iaa2014a.snx*) and SINEX files based on all 24-hour experiments for the quarterly solution.

The routine data processing was performed with the OCCAM/GROSS software using a Kalman filter. The IAA AC operationally processed the 24-hour and In-

Institute of Applied Astronomy of RAS

IAA Analysis Center

IVS 2014 Annual Report

2.3 ITRF2014 Contribution

Daily SNX files for ITRF 2014 were calculated for the data until the end of 2014.

2.4 EOP Parameter Calculation from Domestic “Quasar” Network Observations

VLBI observations using the “Quasar” network for EOP monitoring are carried out in the framework of two domestic programs: Ru-E and Ru-U.

The purpose of the Ru-E program is to provide EOP results on a regular basis from 24-hour sessions using a three-station network: “Svetloe” – “Zelenchukskaya” – “Badary”.

The purpose of the Ru-U program is to provide UT1-UTC results on a regular basis from Intensive sessions using one baseline “Badary” – “Zelenchukskaya” (“Badary” – “Svetloe”).

Correlation is performed using the IAA ARC correlator.

Observational data from one-hour Ru-U (named as Ru-I since August 2014) sessions are transmitted to the correlator using e-VLBI data transfer. The calculation of UT1 time series is performed automatically. The result is a UT1-UTC time series available at <ftp://quasar.ipa.nw.ru/pub/EOS/IAA/eopi-ru.dat>.

We use e-VLBI data transfer for the data of 24-hour sessions from “Badary” and “Zelenchukskaya”. The data of 24-hour sessions are shipped to the IAA correlator on disk modules only from “Svetloe” observatory. The EOP time series is available at <ftp://quasar.ipa.nw.ru/pub/EOS/IAA/eops-ru.dat>.

During 2014, 48 Ru-E and 365 Ru-U sessions were observed. IAA AC performed analysis of these observations. The accuracy obtained in 2014 for EOPs in comparison to the IERS EOP 08 C04 series is presented in Table 1.

2.5 CONT14 Data Analysis

Processing of the CONT14 observations was carried out using software package OCCAM/GROSS. In

Table 1 RMS differences with EOP IERS 08 C04.

EOP	N_{sess}	Bias	RMS
X_p, mas	43	-0.59	0.73
Y_p, mas	43	0.13	1.08
UT1-UTC, μs	43	6	32
X_c, mas	43	0.02	0.27
Y_c, mas	43	0.04	0.38
UT1-UTC Int., μs	365	25	49

the calculation of diurnal EOP, 15 daily sessions were combined into one 15-day session (consisting of 16,430 scans and 145,214 delays), which was processed using the forward run of the Kalman filter to estimate the stochastic parameters. EOP (pole coordinates and universal time), WZD, and clock parameters are considered as stochastic.

Diurnal variations of X_p , Y_p , and $dUT1$ were compared with the model of diurnal variations from the EOP IERS Conventions (2003) model of subdaily EOP variations (designated here as “model”). The results are presented in Figure 1. RMS differences between EOP and the “model” are presented in Table 2.

Table 2 CONT14: RMS differences between EOP and “model”.

EOP	N_{point}	RMS
$X_p, \mu as$	22,792	188
$Y_p, \mu as$	22,792	159
$dUT1, \mu s$	22,792	19

The values of Tropospheric Total Zenith Delay (TZD) obtained during CONT14 from VLBI are in good agreement with data obtained from GPS observations. The results are presented in Figure 2.

2.6 Impact of Ocean Tides in the Diurnal and Semi-diurnal Variation of the Earth Rotation from VLBI Data Analysis

The aim of the study of V. Gubanov and S. Kurdubov presented to *Astronomical Letters* is to determine the parameters of the model of diurnal and semi-diurnal variations of terrestrial pole coordinates and Universal Time arising from lunar-solar tides in the World ocean. For this purpose, data processing of all avail-

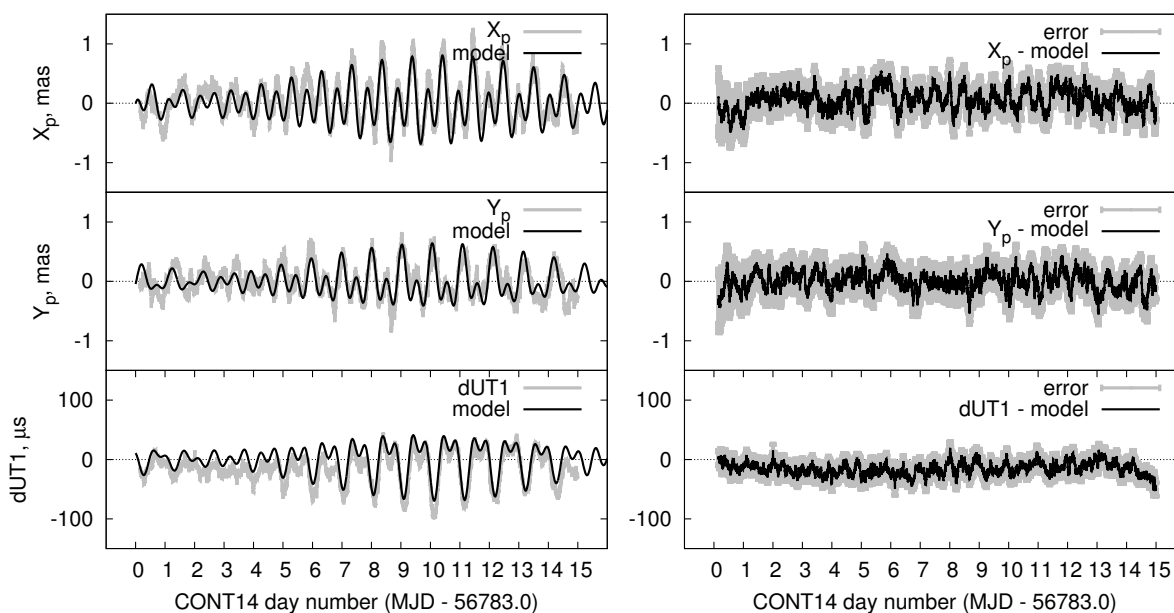

Fig. 1 EOP intra-day variations from CONT14.

able geodetic VLBI observations on a global network of stations in the past 35 years were performed using program package QUASAR IAA RAS. The complication of this problem is that the required corrections of the model parameters are within 1 mm and thus are at the limit of their detection using modern methods of ground positional measurements. This requires the analysis of long series of VLBI observations with high precision reduction and a developed control system for the processing of joint adjustments of observational data. The obtained results, in general, confirm the high accuracy of the basic model of IERS Conventions (2010), but for some harmonic variations of terrestrial pole coordinates and Universal Time, it is possible to detect statistically significant corrections that may be used to improve this model.

3 Current Status

The IAA AC performs data processing of all kinds of VLBI observation sessions. For VLBI data analysis we use the QUASAR and the OCCAM/GROSS software packages. All reductions are performed in agreement with IERS Conventions (2010). Both packages use NGS files as input data.

The IAA AC submits to the IVS Data Center all kinds of products: daily SINEX files for EOP and EOP-rates and station position estimates, SINEX files for ITRF2013, and also TRF, CRF, and tropospheric parameters.

The QUASAR and the OCCAM/GROSS software packages are supported and are being developed.

4 Future Plans

- Continue to submit all types of IVS product contributions.
- Continue investigations of EOP, station coordinates, and tropospheric parameter time series.
- Improve algorithms and software for processing VLBI observations.
- Contribute to ITRF2014.
- Contribute to ICRF3 Working Group study.

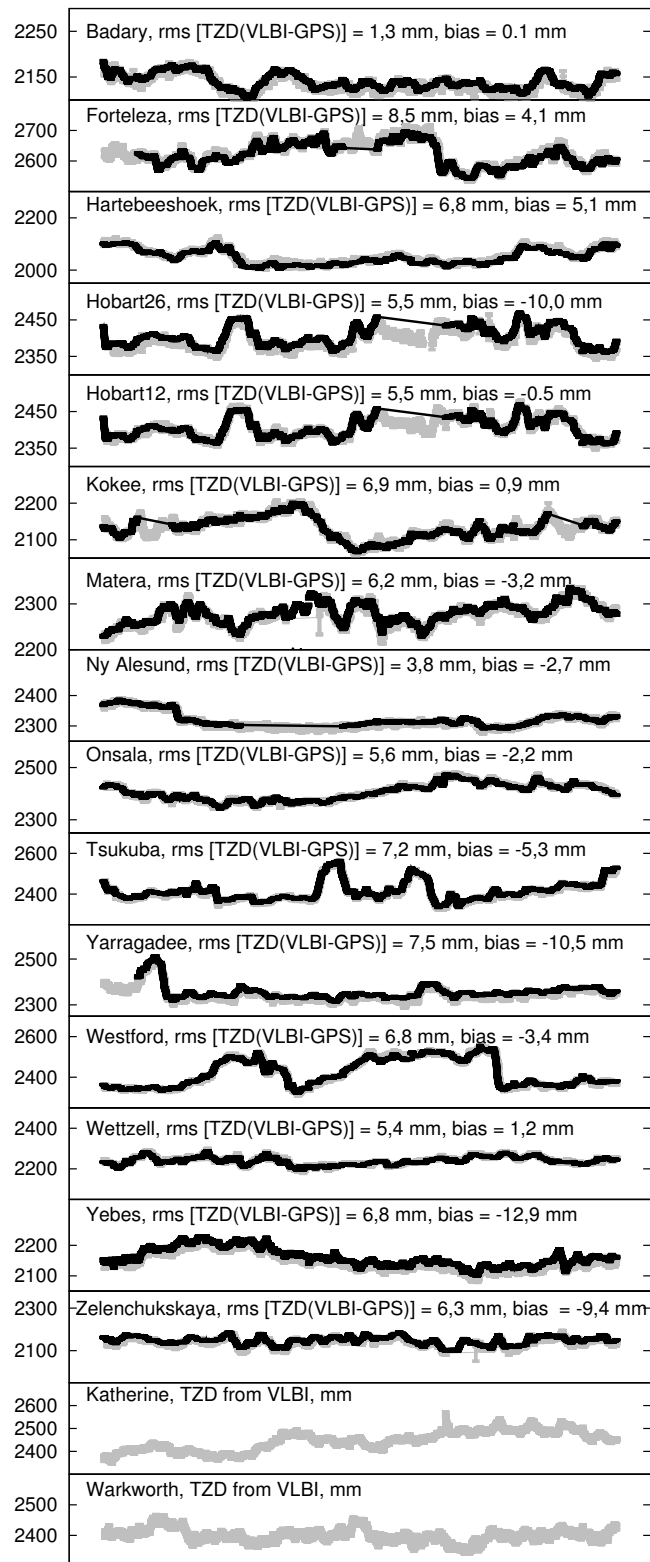

Fig. 2 TZD intra-day (VLBI compared with GPS) variations from CONT14.

Italy INAF Analysis Center

Monia Negusini, Pierguido Sarti

Abstract This report summarizes the activity of the Italian INAF VLBI Analysis Center. Our Analysis Center is located in Bologna, Italy and belongs to the Institute of Radio Astronomy (IRA), which is part of the National Institute of Astrophysics (INAF). The IRA runs the observatories of Medicina and Noto, where two 32-m twin VLBI AZ-EL telescopes are located. This report contains the AC's VLBI data analysis activities and illustrates the local surveys carried out in 2014 at IRA observatories.

1 Current Status and Activity

The activities related to local ties between different geodetic systems located at the observatories were carried out in 2014. At the Medicina and Noto sites, the local values of the Deflection of the Vertical (DoV) were determined using two different methods: a combination of GPS and geometric leveling on one side and gravity residuals on the other. The combination of Global Navigation Satellite System (GNSS) techniques, mostly GPS, and geometric leveling can be adopted for the computation and/or validation of geoid undulation, models, and DoV values. Additional methods that can be successfully employed to determine local DoV values are e.g. astro-geodetic measurements with total stations or zenith cameras.

During the surveys carried out in March 2014 at Medicina and in July 2014 at Noto, we employed GPS

and high precision spirit (geometric) leveling to compute local geoid undulation over the areas surrounding the radio astronomy observatories. At site Medicina, two crews measured along the $L \approx 4.8$ km loop in one day, using one Trimble DiNi12 and one Leica DNA03 digital level ($\sigma = 0.3$ mm/km), and two pairs of 2-m invar rods. In spite of the challenging road conditions, the leveling survey was a real success, with leveling errors on every line well below the $2\sqrt{L}$ tolerance and a global misclosure of 0.9 mm over the $L \approx 4.8$ km loop.

At Noto where only one measuring crew was available, two full working days were necessary to complete the back and forth observations along the lines, using the Leica DNA03 digital level and the 2-m invar rods. Due to local specific limitations, no feasible roads/paths were identified to connect the **N** and **E** endpoints of the lines, and no closed loop was realized. The total length of the lines resulted in $L \approx 2.4$ km, with a maximum misclosure of 0.6 mm on a 600 m line, i.e. $\approx 1/3$ of the $2\sqrt{L}$ tolerance. The geometric leveling data were analyzed with STAR*LEV.

Eight hour GPS observations were performed close to the endpoints of the leveling lines, employing Trimble 5700 receivers and LEIAT 504 Choke Ring antennas. The GPS data analysis was performed with Bernese v5.2 software, processing L1 carrier only using CODE troposphere parameters and global ionospheric maps. All models were expressed in IGS08 and the coordinates of MEDI (DOMES #12711M003), and NOT1 (DOMES #12717M004) were kept fixed to the ITRF2008 values at the relevant epochs: (2014:107) and (2014:207), respectively.

In addition, the *remove-restore* technique used for the computation of the gravimetric geoid undulation could also be implemented to estimate the DoV and to define its ξ and η DoV components.

Istituto di Radioastronomia INAF, Bologna

INAF Analysis Center

IVS 2014 Annual Report

Starting from the gravity residuals computed for the estimate of the Italian quasi-geoid *ITALGEO05*, the residual vertical deflection components were obtained using the Fast Collocation approach. The restore phase was performed adding the long-wavelength component in the term of deflection of the vertical and the high frequency due to the topography to the residual values of ξ and η .

The DoV results will be published in a paper currently under preparation.

2 Data Analysis and Results

The IRA began analyzing VLBI geodetic databases in 1989, using a CALC/SOLVE package on the HP1000 at the Medicina station. In subsequent years, the same software was installed first on an HP360 workstation and later on an HP715/50 workstation. In more recent years, two HP785/B2600 workstations and an HP282 workstation were used. In 2007, a new Linux workstation was set up for the migration of all the VLBI data analysis, and Mark 5 Calc/Solve was installed. During 2014, our Analysis Center had an internal problem, and we did not participate regularly in IVS activities. But we continued to update the catalog, and we installed and tested the latest release of CALC/SOLVE and the new geodetic software *vSolve*.

3 Outlook

In 2015, we will contribute again to IVS activities and submit INAF tropospheric parameters regularly to the IVS Data Center. We will also produce an updated long term geodetic solution.

JPL VLBI Analysis Center Report for 2014

Christopher S. Jacobs

Abstract This report describes the activities of the JPL VLBI Analysis Center for the year 2014. Highlights for the year include tracking the Maven Mars mission, the commissioning of a new 34-m antenna in Australia, DSS 35, and continued operation for the combined NASA-ESA Ka-band network. In addition, our DVP backend was successfully interfaced to the JIVE and DiFX correlators. We continue to support VLBI-based navigation using our combined spacecraft, celestial reference frame, terrestrial reference frame, earth orientation, and planetary ephemeris VLBI systems.

1 General Information

The Jet Propulsion Laboratory (JPL) Analysis Center is in Pasadena, California. Like the rest of JPL, the center is operated by the California Institute of Technology under contract to NASA. JPL has done VLBI analysis since about 1970. We focus on spacecraft navigation, including:

1. The Celestial Reference Frame (CRF) and The Terrestrial Reference Frame (TRF) are efforts which provide infrastructure to support spacecraft navigation and Earth orientation measurements.
2. The Time and Earth Motion Precision Observations (TEMPO) measures Earth orientation parameters based on single baseline semi-monthly measurements. These VLBI measurements are then combined with daily GPS measurements as well as

Jet Propulsion Laboratory, California Institute of Technology

JPL Analysis Center

IVS 2014 Annual Report

other sources of Earth orientation information. The combined product provides Earth orientation for spacecraft navigation.

3. Delta differenced one-way range (Δ DOR) is a differential VLBI technique which measures the angle between a spacecraft and an angularly nearby extragalactic radio source. This technique thus complements the radial information from spacecraft doppler and range measurements by providing plane-of-sky information for the spacecraft trajectory.

2 Technical Capabilities

The JPL Analysis Center acquires its own data and supplements it with data from other centers. The data we acquire are taken using NASA's Deep Space Network (DSN).

1. Antennas: Most of our work uses 34-m antennas located near Goldstone (California, USA), Madrid (Spain), and Tidbinbilla (Australia). These include the following Deep Space Stations (DSS): the "High Efficiency" subnet comprised of DSS 15, DSS 45, and DSS 65, which has been the most often used set of JPL antennas for VLBI. More recently, we have been using the DSN's beam waveguide (BWG) antennas: DSS 13, DSS 24, DSS 25, DSS 26, DSS 34, DSS 35, DSS 54, and DSS 55. Less frequent use is made of the DSN's 70-m network (DSS 14, DSS 43, and DSS 63). Typical X-band system temperatures are 35K on the HEF antennas. The 70 m and BWGs are about 20K. Antenna efficiencies are typically well above 50% at X-band.

2. Data acquisition: We use ROACH-based Digital Back Ends with Mark 5C VLBI recorders. These units became fully operational in 2014. In addition, we have JPL-unique systems called the VLBI Science Recorder (VSR) and the Wideband VSRs (WVSR) which have digital baseband converters and record directly to hard disk. The data are later transferred via network to JPL for processing with our software correlator.
 3. Correlators: The JPL VLBI Correlator has been exclusively based on the SOFTC software which handles the Δ DOR, TEMPO, and CRF correlations as well as tests of antenna arraying.
 4. Solution types: We run several different types of solutions. For Δ DOR spacecraft tracking we make narrow field ($\approx 10^\circ$) differential solutions. The TEMPO solutions typically have a highly constrained terrestrial (TRF) and celestial frame (CRF) as a foundation for estimating Earth orientation parameters. These reference frames are produced from global solutions which then provide the framework needed for use by TEMPO and Δ DOR.
- Walid Majid: pulsars, Δ DOR, and VLBA phase referencing.
 - Chuck Naudet: NASA-ESA southern declination collaboration and source stability studies.
 - Andres Romero-Wolf: MODEST scripts.
 - Lawrence Snedeker: Goldstone data acquisition and NASA-ESA southern declination collaboration.
 - Ojars Sovers: S/X and X/Ka, and CRFs and TRF.
 - Alan Steppe: TEMPO and TRF.

3 Staff

Our staff are listed below along with areas of concentration. Note that not all of the staff listed work on VLBI exclusively, as our group is involved in a number of projects in addition to VLBI.

- Durgadas Bagri: TEMPO and Ka-band phase calibrators.
- Konstantin Belov: CRF global solutions.
- James Border: Δ DOR spacecraft tracking.
- Cristina García-Miró: Madrid data acquisition, NASA-ESA southern declination collaboration, and educational outreach.
- Shinji Horiuchi: Canberra data acquisition and NASA-ESA southern declination collaboration.
- Chris Jacobs: NASA-ESA southern declination collaboration, X/Ka CRF, TRF, and S/X CRF.
- Peter Kroger: Δ DOR spacecraft tracking.
- Gabor Lanyi: MODEST, fringe fitting and correlation support, Δ DOR, and TRF.
- Steve Lowe: Software correlator, fringe fitting software, and Δ DOR.

4 Current Status and Activities

The TEMPO task's EOP measurements continue. Our S/X CRF work is being downsized in favor of X/Ka-band (8.4/32 GHz) CRF which continues to make major strides forward. In particular, in 2014 with ESA's Malargüe, Argentina antenna adding much needed southern coverage and DSN operations at 2048 Mbps, our XKa median precision reached the level of the ICRF2 for 525 common sources.

VLBI spacecraft tracking continues to provide measurements of angular position in support of mission navigation and planetary ephemeris development. 2014 was a busy year for VLBI spacecraft tracking in the Deep Space Network. The ISRO Mars Orbiter Mission and the NASA MAVEN mission were supported by Delta-DOR for their cruise from Earth to Mars, achieving highly accurate orbit insertions in September. The ephemeris of Mars was maintained by Delta-DOR measurements of the MRO and 2001 Odyssey orbiters. Delta-DOR support for Rosetta was completed in June as the spacecraft started its approach to Comet 67P/Churyumov-Gerasimenko. A series of Delta-DOR measurements was completed with New Horizons in June–August to support a trajectory correction maneuver for targeting to Pluto. Regular measurements began in December for Pluto approach. Measurements continued in support of the Dawn low thrust cruise from Vesta to Ceres. Ceres is now in view, and the Delta-DOR support for Dawn is nearing completion. Finally, in December, Delta-DOR support began for the Hayabusa-2 (JAXA) mission. Also, a number of “mixed-baseline” Delta-DOR passes were completed between DSN antennas and antennas belonging to ESA, JAXA, and ISRO. These measurements are validating inter-agency operability

for current and planned cross-support agreements. Preparations are now underway to support future measurements with Akatsuki (JAXA), Juno, InSight, OSIRIS-REx, and Solar Probe Plus.

5 Future Plans

In 2015, we hope to deploy operational Ka-band phase calibrators at our overseas sites. We expect the combined NASA-ESA deep space network to reach sub-nanoradian ($200 \mu\text{as}$) Ka-band CRF results over the south polar cap ($-90^\circ < \delta < -45^\circ$). Collaborative work at K-band is expected to complete full sky coverage as well as improve spatial density through an approved VLBA proposal. At S/X-band the VCS-II collaboration should complete its re-survey of over 2,000 sources. On the spacecraft front, we plan to continue supporting a number of operational missions while further improving techniques for using VLBI for spacecraft tracking.

Acknowledgements

Research described herein done in part at the Jet Propulsion Laboratory, California Institute of Technology under contract with the National Aeronautics and Space Administration. Government sponsorship acknowledged. Copyright ©2015. All Rights Reserved.

References

1. C. S. Jacobs and ICRF-3 working group, 'ICRF3: Roadmap to the Next Generation ICRF,' 223rd AAS, session 251.25, National Harbor, MD, 5–9 Jan 2014.
<http://extras.aas.org/meeting/aas223/251/251.25>
2. C. S. Jacobs and ICRF-3 working group, 'The ICRF-3: Status, Plans, and Progress on the next generation CRF,' 8th IVS General Meeting, Shanghai, China, 2–7 March 2014.
3. C. S. Jacobs, J. E. Clark, C. García-Miró, C. E. Goodhart, S. Horiuchi, R. Madde, M. Mercolino, C. J. Naudet, L. G. Snedeker, I. Sotuela, L. A. White, 'The X/Ka-band (8.4/32 GHz) CRF: Results from combined NASA-ESA baselines including Malargüe, Argentina 8th IVS General Meeting Shanghai, China, 2–7 March 2014.
4. A. de Witt, A. Bertarini, C. Jacobs, J. McCallum, T. Jung, J. Quick, S. Horiuchi, J. Lovell, C. Phillips, B. W. Sohn, R. Ojha, 'Completing K-band CRF in South Hemisphere,' 8th IVS General Meeting, Shanghai, China, 2–7 March 2014
5. J. Boehm and ICRF-3 working group, 'The ICRF-3: Status, Plans, and Progress on the next generation CRF. EGU General Assembly, Vienna, Austria, 27 April 2014.
http://publik.tuwien.ac.at/files/PubDat_229493.pdf
6. S. Horiuchi, J. E. Clark, C. García-Miró, C. S. Jacobs, R. Madde, M. Mercolino, L. G. Snedeker, I. Sotuela, L. A. White, 'All Sky CRF at X/Ka-band (8.4/32 GHz),' XXXI URSI General Assembly, Beijing, China, 16 Aug 2014.
7. Z. Malkin, C. S. Jacobs, and ICRF-3 working group, 'ICRF-3: Status, Plans, Progress on Next Generation ICRF,' Journées 2014, Pulkovo Observatory, St. Petersburg, Russia, 22 Sep 2014.
<http://www.gao.spb.ru/english/as/j2014/presentations/malkin.pdf>
8. C. S. Jacobs and ICRF-3 working group, 'ICRF-3: Roadmap to the next generation ICRF,' poster, Astronomia Dinamica en Latino-America (ADeLA) 2014, ADeLA, Universidad de Santiago, Chile, 29 Sept–1 Oct 2014. adela2014.das.uchile.cl/talks/Posters/CJacobs_ADeLA2014@SCL.pdf
9. C. S. Jacobs, 'Celestial Reference Frames,' Astronomia Dinamica en Latino-America (ADeLA) 2014, workshop lectures, Universidad de Santiago, Chile, 2–3 Oct 2014. adela2014.das.uchile.cl/talks/Workshop_Classes/CJacobs_Santiago_ADeLA2014@SCL.pdf
10. C. S. Jacobs and P. Charlot, 'Radio Sources,' Astronomia Dinamica en Latino-America (ADeLA) 2014, workshop lecture, Universidad de Santiago, Chile, 2–3 Oct 2014. adela2014.das.uchile.cl/talks/Workshop_Classes/CJacobs_PCharlot_ADeLA2014@SCL.pdf
11. C. S. Jacobs, C. García-Miró, S. Horiuchi, J. E. Clark, J. de Vicente, M. Dugast, R. Madde, M. Mercolino, D. Pazos, C. J. Naudet, L. Snedeker, G. Bourda, P. Charlot, I. Sotuela, L. A. White, 'The X/Ka CRF with tie to GAIA's optical frame,' CNEA/ITeDA Seminar, Mendoza, Argentina, 8 Oct 2014.
12. C. S. Jacobs and B. Garcia, 'El físico de la NASA: Christopher Jacobs dio una charla en la CNEA,' Interview/news piece by Pedro Fernandez of Noticias Acequia, Mendoza, Argentina, regarding CONAE/ESA/NASA Collaboration, <https://www.youtube.com/watch?v=XWV9Mhu-TXQ>
13. C. García-Miró, C. S. Jacobs, S. Horiuchi, J. E. Clark, R. Madde, M. Mercolino, D. Pazos, C. J. Naudet, L. Snedeker, G. Bourda, P. Charlot, I. Sotuela, L. A. White, 'The X/Ka CRF: towards a GAIA frame tie,' 12th EVN Symposium, Cagliari, Italy, 7–10 Oct 2014
http://evn2014.oa-cagliari.inaf.it/EVN2014/Talks/03/WedMorning/GarciaMiro_EVN2014.pptx
14. C. García-Miró, J. E. Clark, C. S. Jacobs, R. M. Campbell, M. Kattenis, S. P. Rogstad, S. Horiuchi, L. Snedeker, 'The VLBI Digital Terminal at the NASA's DSN: First Results from non-JPL Correlators,' poster 14, 12th EVN Symposium, Cagliari, Italy, 7–10 Oct 2014
15. C. S. Jacobs and ICRF-3 working group, 'The ICRF-3: Proposed Roadmap to the Next Generation ICRF,' REFAG-2014, Luxembourg, 15 Oct 2014.

- http://geophy.uni.lu/users/tonie.vandam/REFAG2014/SESS_III.CRF.EOP/Jacobs_a.pdf
16. C. S. Jacobs, J. E. Clark, C. García-Miró, S. Horiuchi, R. Madde, M. Mercolino, C. J. Naudet, D. Pazos, P. Pope, L. Snedeker, I. Sotuela, L. A. White, 'The X/Ka CRF: Results from combined NASA-ESA baselines including Malargüe, Argentina,' REFAG-2014, Luxembourg, 15 October 2014.
http://geophy.uni.lu/users/tonie.vandam/REFAG2014/SESS_III.CRF.EOP/Jacobs_b.pdf
 17. A. Iddink, C. S. Jacobs, T. Artz, A. Nothnagel, 'A Proposed Combination Process for ICRF-3,' REFAG-2014, Luxembourg, 15 Oct 2014.
http://geophy.uni.lu/users/tonie.vandam/REFAG2014/SESS_III.CRF.EOP/Nothnagel.pdf
 18. C. S. Jacobs and ICRF-3 Working Group, 'The ICRF-3: Proposed Roadmap to the next generation ICRF,' Seminar, Max Planck Institute for Radio Astronomy, Bonn, Germany, 20 Oct 2014.
 19. C. S. Jacobs, C. García-Miró, S. Horiuchi, J. E. Clark, R. Madde, M. Mercolino, D. Pazos, C. J. Naudet, L. Snedeker, G. Bourda, P. Charlot, I. Sotuela, L. A. White, 'The X/Ka CRF: towards a GAIA frame tie,' Seminar, Centro Astronómico de Yebes, Yebes, Spain, 23 Oct 2014
 20. C. S. Jacobs, C. García-Miró, S. Horiuchi, L. Snedeker, D. Bagri, J. E. Clark, G. E. Lanyi, C. J. Naudet, L. A. White, R. Madde, M. Mercolino, D. Pazos, G. Bourda, P. Charlot 'VLBI in the DSN: Cat M&E, Clock Sync/TEMPO, Delta-DOR,' MDSCC Seminar, Robledo de Chavela, Spain, 24 Oct 2014.
 21. D. Shin, D. Bagri, J. Border, Advanced Calibration Technique for Accurate Three-Way Spacecraft Ranging Interplanetary Network Progress Report, vol. 42-199, p. 1-11
http://ipnpr.jpl.nasa.gov/progress_report/42-199/199C.pdf
 22. C. S. Jacobs and ICRF-3 working group, 'ICRF-3: Multi-wavelength progress,' Extra-galactic Science with Gaia, Observatoire de Meudon, France, 10-12 Dec 2014
<http://egsg2014.obspm.fr/cours/JACOBS.pdf>
 23. C. S. Jacobs, J. Souchay, R. Gaume, and ICRF-3 Working Group, ICRF-3 status report, IERS Directing Board, AGU splinter meeting, San Francisco, Dec 14 2014.

KASI Combination Center 2014 Annual Report

Jungho Cho, Younghee Kwak

Abstract This report briefly summarizes the activities of the combination center of Korea Astronomy and Space Science Institute (KASI) for the year 2014. The current status and the future plans are also described.

1 General Information

The KASI IVS Combination Center is located in Science Complex in Daejeon, South Korea. As a government-funded research institute, KASI operates the IVS Combination Center based on experiences of GNSS data processing using Bernese software (hereafter Bernese). Bernese with the subprogram ADDNEQ2 has been used for normal equation stacking and estimation of VTRF and EOPs [1]. In addition to playing the role of an IVS Combination Center, the KASI Space Geodesy Group is also in charge of geodetic applications of the KVN (Korean VLBI Network).

2 Activities during the Past Year

KASI is facing the phase of geodetic applications using the KVN. KVN Tamna among three KVN stations was first surveyed in terms of Invariant Point (IVP). For the task, a 3D Laser Scanner was introduced for visualizing the IVP variations. A GNSS survey was also carried out for the coordinate transformation from topocentric

Korea Astronomy and Space Science Institute
KASI Combination Center
IVS 2014 Annual Report

to geocentric. As a result of the test surveys, it is recognized that more dense measurements for both, with additional elevation and azimuth angles, are necessary.

3 Current Status

Dr. Younghee Kwak moved to the Advanced Geodesy Group of the Vienna University of Technology in late March and is working at the group as a project assistant. The Space Geodesy Group has been re-organized since June, and Dr. Jungho Cho has been appointed as head of the group. The Space Geodesy Group continuously handles IVS Combination Center tasks as well as KVN geodetic applications.

4 Future Plans

In 2015, VTRF which was determined by the modified Bernese in 2013 will be improved in terms of precision. In a couple of years, the three IVPs of the KVN telescopes will be determined and will be on a periodical survey schedule. In the next few years, KASI will contribute to the Asia-Oceania VLBI group for Geodesy and Astrometry (AOV) as an Analysis Center.

References

1. Kwak, Y. and J. Cho, *KASI Combination Center 2013 Annual Report*, IVS 2013 Annual Report, 288-291, NASA/TP-2014-217522, ed. by K. D. Baver, D. Behrend, and K. L. Armstrong, 2014.

KTU-GEOD IVS Analysis Center Annual Report 2014

Emine Tanır Kayıkçı¹, Kamil Teke²

Abstract This report summarizes the activities of the KTU-GEOD IVS Analysis Center (AC) in 2014 and outlines the planned activities for 2015. Determination of optimal weights of constraints on VLBI auxiliary parameters as well as estimation intervals is our specific interest in 2015.

Table 1 Staff.

Name	Working Location
Emine Tanır Kayıkçı	Karadeniz Technical University, Dept. of Geomatics Engineering, Trabzon, Turkey.
Kamil Teke	Hacettepe University, Dept. of Geomatics Engineering, Ankara, Turkey.

1 General Information

KTU-GEOD IVS Analysis Center (AC) is located at the Department of Geomatics Engineering, Karadeniz Technical University, Trabzon, Turkey.

2 Staff at KTU-GEOD Contributing to the IVS Analysis Center

The staff who contributed to the research at the KTU-GEOD IVS Analysis Center (AC) in 2014 are listed in Table 1 with their working location.

3 Current Status and Activities

During 2014, we focused on inter-technique comparisons of different parameters estimated from the

1. Karadeniz Technical University, Department of Geomatics Engineering

2. Hacettepe University, Department of Geomatics Engineering

observations of the space/satellite geodetic techniques i.e. VLBI (Very Long Baseline Interferometry), GNSS (Global Navigation and Satellite Systems), and DORIS (Doppler Orbitography and Radio Positioning Integrated by Satellite). The zenith tropospheric delays (ZTD) and horizontal total gradients derived from IGS [1] and IVS [2] of the co-located site Wettzell between 2002—2013 are shown in Figures 1 and 2 [3].

The GNSS-derived Zenith Tropospheric Delays (ZTDs) play an important role in meteorological studies by means of incorporating ZTDs at GNSS sites into numerical weather prediction models. The Trop-NET system (reference) developed at the Geodetic Observatory Pecny (GOP, RIGTC) in order to facilitate near real-time troposphere monitoring using ground-based GNSS data (based on the Bernese GNSS Software, [4]) was installed and has been routinely used at the KTU-GEOD IVS AC since September 2014. KTU-GEOD IVS AC established a cooperation with GOP within the COSTES1206 Action (GNSS4SWEC, WG1). Approximately 33 sites from IGS and EUREF permanent networks in entire Europe were selected for an initial setting and testing [5, 6]. These are ANKR Ankara (Turkey), ARG1 Thorshavn (Faroe Islands), AUT1 Thessaloniki (Greece), BRST Brest (France), BUCU Bucurest (Romania), GLSV Kiev

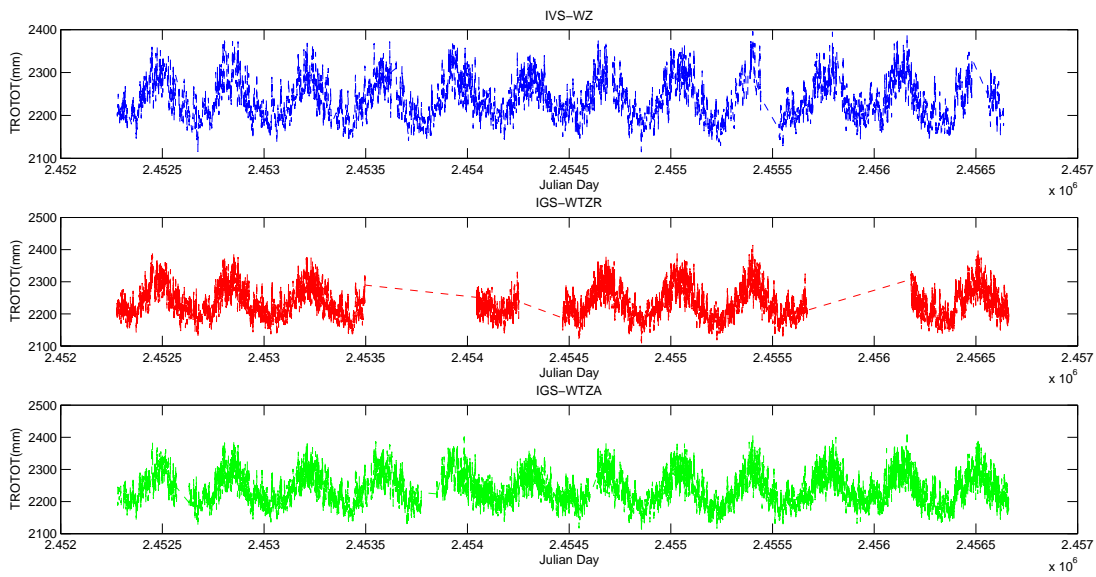

Fig. 1 Troposphere ZTD estimates derived from IVS and IGS intra-technique combined solutions at the co-located site Wettzell.

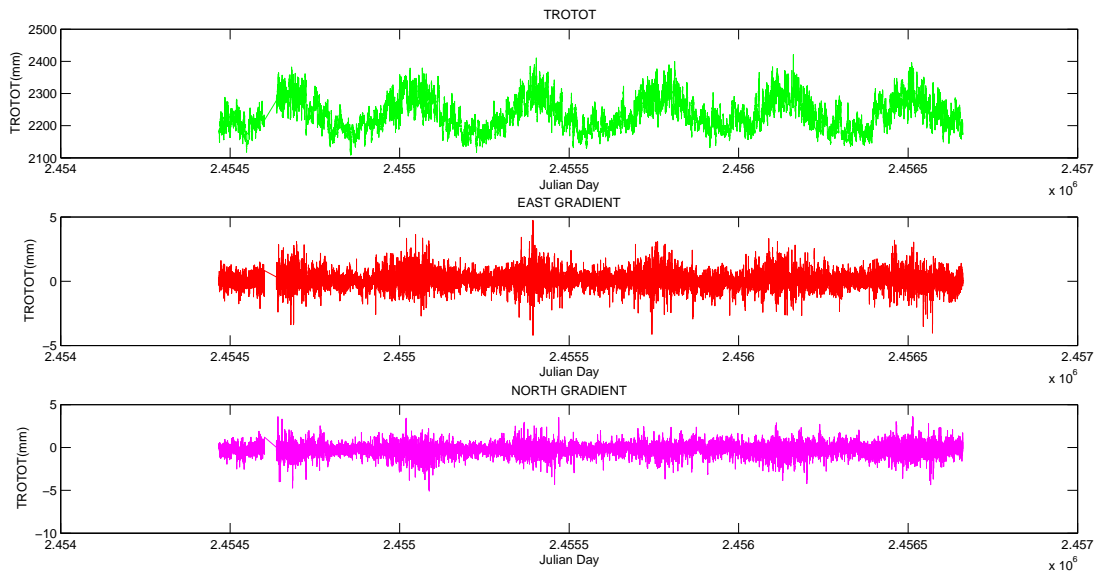

Fig. 2 Troposphere north and east gradients from IGS intra-technique combined solution at the co-located site Wettzell.

(Ukraine), GOPE Pecny (Czech Republic), HOFN Maspalomas (Spain), MATE Matera (Italy), MEDI Hoefn (Iceland) , ISTA Istanbul (Turkey), JOZE Medicina (Italy), METS Metsähovi (Finland), MORP Jozefoslaw (Poland), KIRU Kiruna (Sweden), KTVL Morpeth (UK), NICO Nicosia (Cyprus), ONSA Katzively (Ukraine), M0SE Roma (Italy), MASI Onsala (Sweden), ORID Ohrid (Macedonia), PDEL

Ponta Delgada (Portugal), PENC Penc Budapest (Hungary), POLV Poltava (Ukraine), POTS Potsdam (Germany), PUYV Le Puy en Velay (France), RIGA Riga (Latvia), SOFI Sofia (Bulgaria) VLNS Vilnius (Lithuania), WTZR Wetzell (Germany), YEBE Yebes (Spain), ZECK Zelenchukskaya (Russia), and ZIMM Zimmerwald (Switzerland). Because some of the GNSS core stations are selected as co-located with VLBI antennas and the two techniques mostly share similar models, inter-technique comparisons will be performed between the common parameters of VLBI and GNSS techniques that is one of the interests of the meteorology community.

4 Future Plans

Together with Dr. Vincenza Tornatore as PMD (Politecnico di Milano) AC's team coordinator, Dr. Tanır Kayıkçı plans to perform an inter-technique comparison of certain common parameters and a combination of TRF from the analyses of the DORIS and VLBI observations. The output of this study will be submitted as a paper for the DORIS special issue of the Journal of Advances in Space Research in 2015. One of the members, Kamil Teke, plans to investigate the possibility of improving the accuracy of certain types of VLBI parameters using Vienna VLBI Software, VieVS [7].

Acknowledgements

We are thankful to all the governing board of IVS. We are grateful to Karadeniz Technical University for their financial support of KTU-GEOD IVS AC research activities. Emine Tanır Kayıkçı acknowledges Turkish National Scientific and Research Council (TUBITAK) for the financial support of her research stay at Politecnico di Milano during July and August 2014. Kamil Teke is thankful to Hacettepe University for providing financial support for his participation in IVS meetings and the Vienna VLBI group for collaboration.

References

1. J.M. Dow, R.E. Neilan, C. Rizos, The International GNSS Service in a changing landscape of Global Navigation Satellite Systems, *J. Geod.*, 83, 3-4, 191-198, 2009.
2. H. Schuh, D. Behrend, VLBI: a fascinating technique for geodesy and astrometry, *J. Geodyn.*, 61, 68-80, 2012.
3. N. Mammadaliyev, Analysis of IVS and IGS Combined Tropospheric Time Series and Outlier Detection, Diploma Thesis, Karadeniz Technical University, Department of Geomatics Engineering, Supervisor: E. Tanır Kayıkçı, Trabzon, Turkey, 2014 (in Turkish).
4. R. Dach, U. Hugentobler, P. Fridez, M. Meindl (eds), Bernese GPS Software Version 5.0, Astronomical Institute, University of Bern, 2007.
5. J. Douša, Precise near real-time GNSS analyses at Geodetic observatory Pecný - precise orbit determination and water vapour monitoring, *Acta Geodyn Geomater.*, 7, 157, 1-11, 2010.
6. URL 1: GOP's Trop-NET system for near real-time troposphere monitoring, <http://www.pecny.cz/gop/index.php/trop-net/trop-net-intro>, Date of Access: December 2014.
7. J. Böhm, S. Böhm, T. Nilsson, A. Pany, L. Plank, H. Spicakova, K. Teke, H. Schuh, The new Vienna VLBI Software VieVS, in Proceedings of IAG Scientific Assembly 2009, International Association of Geodesy Symposia Series Vol. 136, edited by S. Kenyon, M. C. Pacino, and U. Marti, p. 1007-1011, 2012.

Analysis Center at the National Institute of Information and Communications Technology

Mamoru Sekido

Abstract This report summarizes the activities of VLBI data analysis at the National Institute of Information and Communications Technology (NICT) in 2014.

1 General Information

The VLBI Analysis Center is operated by the space-time standards group and is located at the Kashima Space Technology Center and its headquarters of NICT in Tokyo. This analysis report is focused on the processing of VLBI experiments related to NICT's research goals on Geodesy and time and frequency transfer with a compact VLBI system. Development of original software package "C5++" [1], which is for the analysis of Space Geodesy (SLR, VLBI, and GNSS), has been continued under multi-organization collaborations.

2 Staff

Members who are contributing to the Analysis Center at the NICT are listed below (in alphabetical order, with working locations in parentheses):

- HOBIGER Thomas (Koganei, Tokyo): analysis software development and atmospheric modeling.

NICT, Japan

NICT Analysis Center

IVS 2014 Annual Report

He moved to the Onsala Space Observatory in August 2014.

- ICHIKAWA Ryuichi (Koganei, Tokyo): coordination of activities
- KONDO Tetsuro (Kashima): Maintenance of correlation software K5VSSP and development of broadband synthesis software.
- SEKIDO Mamoru (Kashima): development of VLBI systems, coordination of activities
- TAKIGUCHI Hiroshi (Koganei, Tokyo): GPS analysis for time and frequency transfer.

3 Current Activities

3.1 Frequency Transfer by Means of VLBI

Space geodetic techniques such as GNSS have been proven to be a useful tool for time and frequency transfer purposes. VLBI could be another space geodetic technique that can be utilized for frequency transfer. In contrast to GNSS, VLBI does not require any orbital information as it directly refers to an inertial reference frame defined by the location of the quasi-stellar objects. Thus day boundary jumps, which are seen in GNSS analysis and are caused by discontinuities of satellite orbits, are avoidable. As summarized by [6], current VLBI systems can provide a frequency link stability of about 2×10^{-15} @ 1d (ADEV). NICT's Space-Time Standards Laboratory is working on the realization of a frequency transfer system based on the principles of VLBI, whereas developments from the upcoming geodetic VLBI2010 system are expected to help to reach these goals.

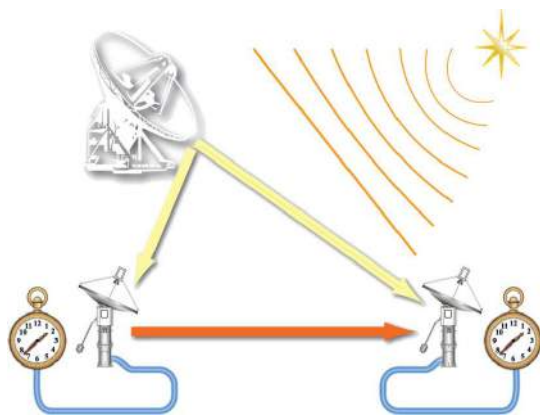

Fig. 1 The concept of the distant frequency comparison system composed of a pair of small-diameter antennas and a large-diameter antenna. Transportable small-diameter antennas are placed in laboratories, where the atomic frequency standards to be compared are being developed. The sensitivity of VLBI observation between a pair of small-diameter antennas is boosted by using a large-diameter antenna.

An overview of the project (Gala-V) is indicated in Figure 1. Transportable small-diameter antennas are placed in laboratories, where atomic frequency standards to be compared are located. By joint observation with small- and large-diameter antennas, the delay observable between a small-antenna pair is derived. Disadvantages of the small-diameter antennas (hereafter referred to as A and B) on sensitivity is compensated by joint observation with a large-diameter antenna (hereafter referred to as O) and expanded observation frequency range. The delay observable (τ_{AB}) between the small diameter antenna pair (AB) is computed by linear combination of those (τ_{OA} , τ_{OB}) of the small and large diameter baselines (OA,OB) as follows:

$$\begin{aligned} \tau_{AB}(t_{\text{prt}}) &= \tau_{OB}(t_{\text{prt}} - \tau_{OA}(t_{\text{prt}})) - \tau_{OA}(t_{\text{prt}} - \tau_{OA}(t_{\text{prt}})) \\ &\cong \tau_{OB}(t_{\text{prt}}) - \tau_{OA}(t_{\text{prt}}) - \frac{d}{dt} \tau_{AB}(t_{\text{prt}}) \times \tau_{OA}(t_{\text{prt}}), \end{aligned} \quad (1)$$

where t_{prt} is the reference epoch of the observation.

One of the small-diameter antennas equipped with a broadband feed and high speed data acquisition system was moved to the National Meteorology Institute of Japan (NMIJ) in Tsukuba by the end of March 2014. Another small antenna was installed at NICT Headquarters in Koganei, Tokyo. Both NMIJ and NICT are the national institutes engaged in the development of

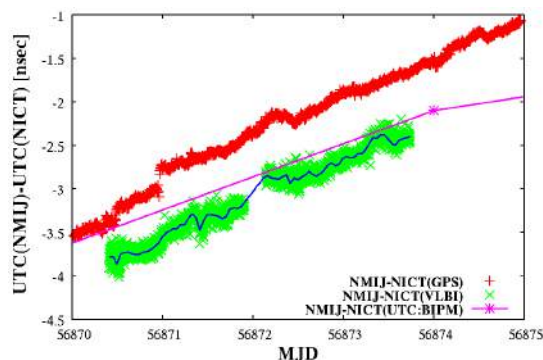

Fig. 2 The clock difference between NICT and NMIJ compared by VLBI('+') and GPS('x') observations. The difference between UTC[NMIJ] and UTC[NICT] reported by BIPM is superimposed with a solid line and '*'.

atomic frequency standards and are keeping the time series of UTC[NMIJ] and UTC[NICT], respectively. Therefore, the NMIJ and NICT baseline is a good test bed for developing the frequency comparison system. An example of the result of a clock comparison experiment conducted in August 2014 is displayed in Figure 2. Observations were made 1-3 August 2014 with two small antennas at NMIJ and NICT and with the Kashima 34-m antenna with X-band. Clock difference behaviors were estimated by GPS observation and VLBI observations. Because the clock behaviors of both institutes are regularly reported to the Bureau International des Poids et Mesures (BIPM), the clock difference deduced from BIPM publication is superimposed in the plot. All of these data are almost consistent.

Figure 3 shows the histogram of delay residual distribution of the VLBI analysis. Because the errors of the OA and OB baselines are added in linear combination of equation (1), the delay residual distribution of the AB baseline is increased by the root-sum-square of the two observables.

3.2 Broadband System

A prototype of a broadband feed (6.5 - 15 GHz) was originally developed by and at NICT and installed at the Kashima 34-m antenna at the end of 2013. Its first light observation was successful in January 2014. This achievement demonstrated that a broadband an-

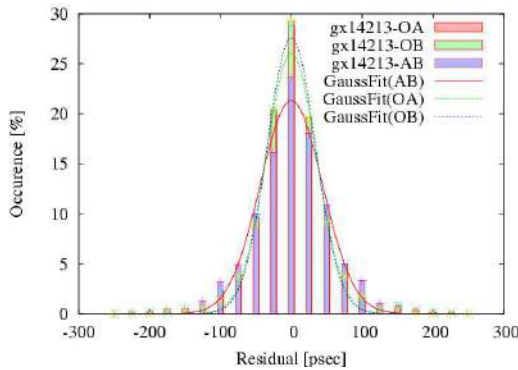

Fig. 3 Histograms of the VLBI analysis residual distribution of the OA, OB, and AB baselines are indicated. The residual distribution of the AB baseline increased by the root-sum-square of the residuals of the OA and OB baselines.

tenna can be realized without building a new telescope, and an existing Cassegrain antenna can be updated for broadband observation. The system equivalent flux density (SEFD) of the current broadband system is 1000 - 2000 Jy in a 6.5-15 GHz frequency range. Improvement of the receiver is planned by upgrading the broadband feed, so that the observation frequency range will become fully compatible with the VGOS system. VLBI experiments for fringe testing and broadband bandwidth delay measurements were conducted on the Kashima - Ishioka (GSI) baseline at the end of 2014.

3.3 Development of a Multi-technique Space-geodetic Analysis Software Package

Driven by the need to update the existing space geodetic analysis software and motivated by the demanding goals of GGOS, an analysis software package named “c5++” was developed. The software was designed to support the combination of space geodetic data of SLR, VLBI, and GNSS on the observation level, but it also enables processing of single-technique solutions. VLBI, GNSS, and SLR modules (see Figure 4) share the same library, which contains all geophysical models according to the latest IERS Conventions. In addition, local tie information can be included as virtual observations which relate between technique-specific reference points. The library also provides interfaces

to various space geodetic data formats, enables reading/writing of SINEX files, and supports all necessary mathematical functions for the parameter adjustment process. c5++ does not have a graphical user interface (GUI) but is called directly from the command line and controlled via a configuration file.

c5++ was compared against other software packages [2] and is currently being used by the Geospatial Information Authority of Japan (GSI) for ultra-rapid determination of UT1 [3] on a routine basis.

In contrast to a combination of space geodetic results where parameters are derived individually from each technique, the combination of all available space geodetic observations on the observation level is expected to obtain more robust parameters. Outliers are less likely to bias the solution as data from other techniques helps to identify such data artifacts. Moreover, weaknesses of one technique can be compensated by adding a second technique, improving geometrical coverage and stabilizing the estimation of parameters which otherwise would depend on observations from that single technique. In order to demonstrate the capability of the software to combine data at the observation level, SLR and VLBI observations were processed together, with the goal of studying site motions at TIGO and revealing the benefits of this approach [4].

In addition to local tie information, site-wise common parameters, i.e. troposphere and clocks, can be estimated when microwave-based techniques are combined on the observation level. Hobiger et al. [5] discusses how common parameters between GNSS and VLBI have to be estimated and where biases/offsets need to be taken into account. In order to test this concept, GPS and VLBI data from the CONT11 campaign

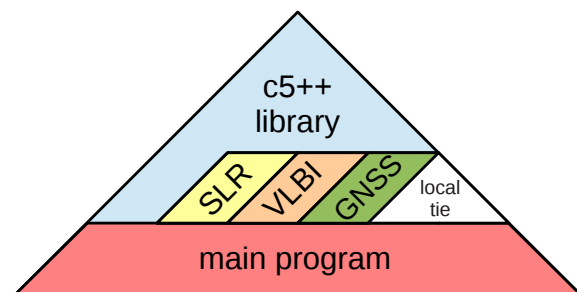

Fig. 4 The basic concept of c5++ allows processing of single- and multi-technique space geodetic observations by taking advantage of the usage of identical geophysical models (from [5]).

were utilized. Obtained results show that the combination of space geodetic data on the observation level leads to a consistent improvement of station position repeatability and Earth orientation parameters as well as nuisance parameters such as troposphere estimates. Furthermore, estimation of common parameters (troposphere or clocks) at co-located sites helps to improve the solution further and derive an utmost physically consistent model of the concerned parameters (see details in [5]).

4 Future Plans

Plans and tasks in 2015 are (1) the development of broadband phase synthesis technique, (2) conducting frequency transfer experiments with the broadband VLBI system, and (3) establishing its processing chain to analysis.

Acknowledgements

We thank Dr. Kennichi Watabe, Dr. Tomonari Suzuyama, and Dr. Masaki Amemiya of NMIJ for their support in the installation of the small-diameter antenna at NMIJ and the frequency transfer experiments of the Gala-V project.

References

1. Hobiger, T., et al., “c5++ - Multi-technique Analysis Software for Next Generation Geodetic Instruments”, IVS 2010 General Meeting Proceedings - VLBI2010: From Vision to Reality, NASA/CP-2010-215864, pp. 212-216, 2010
2. L. Plank, J. Boehm, and H. Schuh (2011), DeDeCC - Comparison of VLBI data analysis software - results; *12th IVS Analysis Workshop, March 31, 2011, Bonn, Germany*, 2011.
3. T. Hobiger, T. Otsubo, M. Sekido, T. Gotoh, T. Kubooka, and H. Takiguchi, Fully automated VLBI analysis with c5++ for ultra-rapid determination of UT1, *Earth, Planets, Space*, 45, 2, 75–79, 2010.
4. T. Hobiger, T. Otsubo, and M. Sekido, Combination of space geodetic observations from SLR and VLBI on the observation level with c5++, *Adv. in Space Research*, 53(1), 119–129, doi:10.1016/j.asr.2013.10.004, 2014.
5. T. Hobiger and T. Otsubo, Combination of GPS and VLBI on the observation level during CONT11 - common parameters, ties and inter-technique biases, *under review*, 2014.
6. C. Rieck, R. Haas, R.T.K. Jaldehag, and J.M. Johansson, VLBI and GPS-based Time-transfer Using CONT08 Data, IVS 2010 General Meeting Proceedings, NASA/CP-2010-215864, 365-369, 2010.

NMA Analysis Center 2014 Annual Report

Ann-Silje Kirkvik

Abstract The Norwegian Mapping Authority (NMA) has been an Associate Analysis Center within the IVS since 2010. In 2014, NMA delivered its first official product to IVS. This was the contribution to ITRF2014 with 22 years of 24-hour sessions processed. In the future, NMA will continue to work towards becoming a fully Operational Analysis Center

1 General Information

NMA has been an Associate Analysis Center within the IVS since 2010. The analysis center is operated by the Geodetic Institute at NMA with main offices in Hønefoss, Norway. NMA is a governmental agency and the IVS activities at NMA are completely funded by the Norwegian government.

NMA aims to become a fully Operational Analysis Center and to contribute with timely session-by-session unconstrained normal equations. NMA is using the analysis software GEOSAT. GEOSAT was originally developed by Per Helge Andersen at the Norwegian Defense Research Establishment (NDRE). In the recent years, a lot of effort has been put into training a team at NMA to continue the development of GEOSAT.

Norwegian Mapping Authority (NMA)

NMA Analysis Center

IVS 2014 Annual Report

2 Component Description

GEOSAT was originally designed to combine information from VLBI, GNSS, and multi-satellite DORIS and SLR, one epoch at a time with the use of a Kalman filter and models that are common across the techniques. As a result, the different data types can complement each other at each epoch in the determination of all common parameters. To validate GEOSAT, a large number of VLBI sessions were processed and submitted to the IVS Combination Center at BKG for review. The main focus has been to process R1 and R4 sessions, but several other 24-hour sessions have also been tested. GEOSAT is not, in its current condition, able to process Intensive sessions.

3 Staff

The current team involved in the development, maintenance, and usage of GEOSAT is:

- Ann-Silje Kirkvik - VLBI
- Halfdan Pascal Kierulf - VLBI
- Åsmund Skjæveland - VLBI
- Ingrid Fausk - SLR
- Geir Arne Hjelle - DORIS, miscellaneous
- Micheal Dähnn - GNSS
- Eirik Mysen - Combination technique
- Per Helge Andersen - GEOSAT founder
- Laila Løvhøiden - Project manager

The team was considerably strengthened in 2014. Geir Arne Hjelle was employed in the beginning of 2014 and has been helping out in different parts of the project. Micheal Dähnn and Eirik Mysen have also

been assigned to the project, and the project has gotten a new project manager. In addition, Åsmund Skjæveland has been assigned to help with the routine processing of R1 and R4 sessions as NMA progresses towards becoming a fully Operational Analysis Center. Per Helge Andersen was originally planning to retire in June 2015 but has agreed to stay on until the end of 2015.

4 Current Status and Activities

At the General Meeting in Shanghai in March 2014, it was shown that GEOSAT was able to produce EOP estimates comparable to the other Analysis Centers'. The test data were the R1 and R4 sessions from 2006. The results were promising and it was decided that NMA should try to contribute to ITRF2013. Later tests on 11 years (2003-2013) of R1 and R4 sessions revealed several problems that had to be fixed. In particular, the station coordinates were bad.

With all the new antennas being built there are some sites that now have two operational antennas observing in the same session. This situation had never been tested in GEOSAT before, and it turned out that the software was mixing the different monuments at the same site. The station coordinate could be off by hundreds of meters. Hobart and Hartebeesthoek were the sites that revealed this problem. Once this was fixed, there were still problems with the solution.

The station coordinates were still off by half a meter in some cases, but after some investigation it turned out that the eccentricities were not applied at all due to a software bug. This was easily fixed and the solution started to look good from NMA's point of view.

But a thorough review of the data set by Sabine Bachmann at BKG revealed that the station coordinates still were off by up to 1.5 cm for some stations. This problem was a lot harder to solve. All the station displacement models were checked and updated, but nothing improved the result. Finally, it turned out that a pre-processing algorithm was throwing away almost all the cable calibration data and the remaining cable calibration data was applied with the wrong sign. Fixing this problem finally gave comparable station coordinates.

With these fixes, most 24-hour sessions from 1994 until 2013 were analyzed and submitted to the ITRF2013 solution. Late in 2014 it was decided that

ITRF2013 should become ITRF2014, and processing of sessions from 2014 was also started.

5 Future Plans

The main focus for the team members at NMA is still to learn as much as possible from Per Helge Andersen in order to have the necessary competence to sustain and develop GEOSAT themselves after his retirement. This includes both the software design and the theoretical aspects of the models and estimation technique.

After finishing the work on ITRF2014 the next step is to prepare the software and production chain in order to try submitting timely unconstrained normal equations to the IVS Combination Center. In addition, the software must be updated so that it can estimate earth orientation parameters with higher frequency than one day.

Paris Observatory (OPAR) Analysis Center

Sébastien Lambert, César Gattano, Christophe Barache, Jean Souchay, François Taris, Christian Bizouard, Olivier Becker

Abstract We report on the operational and research activities at the Paris Observatory VLBI Analysis Center (OPAR) for 2014. Our achievements include the re-analysis of opa2014a and research related to celestial reference frames.

1 Analysis Service

1.1 Operational Solutions

A reanalysis of the complete 24-hour session database was done (identified as opa2014a), and the resulting EOP series and radio source catalogs were sent to the IVS. This solution estimated EOP and rates as session parameters, most of the station coordinates and the velocities as global parameters, and most of the sources' coordinates as global parameters. Stations undergoing strong nonlinear displacements were estimated as session parameters (TIGOCONC, TSUKUB32, KASHIM11, KASHIM34, VERAMZSW, KOGANEI, and USUDA64). Troposphere and clock parameters were estimated every 20 minutes and 60 minutes, respectively, and gradients were estimated every six hours (at all sites). Axis offsets were estimated as global parameters for a list of 80 stations. We used up-to-date geophysical and astronomical modeling to compute the theoretical delay and partials, including the IAU 2006 nutation and precession, the Vienna mapping functions 1, the FES 2004 ocean loading

model, and the antenna thermal deformations as provided by A. Nothnagel (2009, *J. Geod.*, 83, 787). Constraints were applied to the 295 ICRF2 defining sources (no-net rotation) and to 27 stations (no-net rotation and no-net translation of positions and velocities). We used the latest version of the Calc/Solve geodetic VLBI analysis software package.

24-hour sessions were analyzed routinely within 24 hours after version 4 of the observation database file was submitted to the IVS. The operational solution is aligned to the opa2014a global solution. Unconstrained normal equations relevant to EOP, rates, and station and source coordinates were sent to the IVS in SINEX format for combination in the framework of the IVS Analysis Coordinator's task.

An operational solution analyzing Intensive sessions after 2002 was started (opa2014i). The solution opa2014i included Intensive sessions in order to produce UT1 consistent with VTRF 2013D, ICRF2, and the IERS EOP 08 C04 Earth orientation data. To account for the nonlinear displacement of TSUKUB32, we modeled the antenna displacement by a transient decay model fitted to the station coordinate time series (see next section).

All the above products, except SINEX files, were published on the OPAR Web site at

<http://ivsopar.obspm.fr>

together with exhaustive explanations and plots. SINEX files were only sent to the Data Centers.

Observatoire de Paris/SYRTE – CNRS – UMPC – GRGS

OPAR Analysis Center

IVS 2014 Annual Report

1.2 Other Contributions

Station and radio source coordinate time series are updated as new observations arrive. For each source, a page displays the time series and provides links to source information at various external databases (e.g., the French Virtual Observatory software package Aladin that permits a user to get the optical counterpart of the VLBI quasars, or the Bordeaux VLBI Image Database that gives the VLBI structure).

As for past years, the Earth's free core nutation (FCN) is regularly monitored at OPAR: we maintain an FCN model directly fitted to routinely estimated nutation offsets (Figure 1). It is worth noting that the FCN amplitude seems to be approaching a maximum. The follow-up of this variation in the next years will certainly improve our knowledge of the FCN phenomenon.

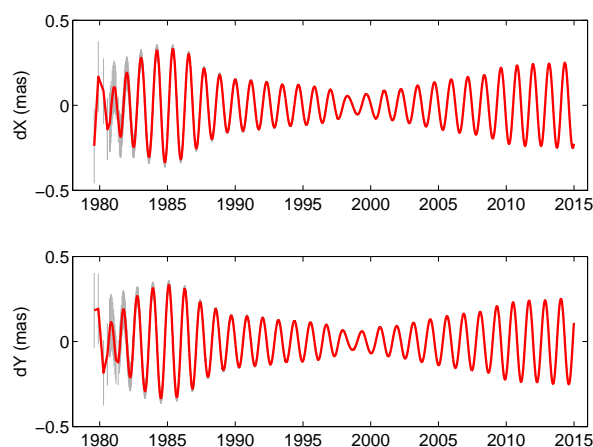

Fig. 1 The amplitude of the free core nutation.

OPAR also contributed to the ITRF 2013 (now ITRF 2014) solution. Late in 2014, the Analysis Center continued to submit SINEX files for sessions up to the end of the year.

2 Research

2.1 VLBI Astrometry and Geodesy

In Lambert (2014, A&A 570, 108), astrometric catalogs obtained by several IVS Analysis Centers and sub-

mitted to the IVS in 2012 and 2013 were compared to the ICRF2 in terms of radio source coordinates, global second-degree deformations, and error distribution. All catalogs were found to be consistent with the ICRF2 within $20 \mu\text{as}$. But at high observational rates, the formal error is limited to the level of $\sim 10 \mu\text{as}$ likely by correlated-noise errors. Comparison of differences to ICRF2 against formal errors raised noise floors of the differences between $50 \mu\text{as}$ and $100 \mu\text{as}$, and hence no improvement occurred with respect to the ICRF2. The inconsistencies between catalogs result in differences significantly larger than the accuracy expected for the future ICRF realizations. These inconsistencies have to be clarified in the near future in view of the ICRF3 and accurate linking to reference frames at other frequencies.

In parallel, C. Gattano (PhD student at SYRTE under the supervision of C. Bizouard and S. Lambert) is currently studying the link between precise VLBI astrometry and estimation of nutation, as well as the possibility of increasing the accuracy of both products for benefits in astronomy and geophysics.

2.2 Optical Counterpart

The astrometry team of the SYRTE has also been contributing to improving the Large Quasar Astrometry Catalog (LQAC; Souchay et al. 2009, A&A 494, 799), which contains accurate positions and optical information of more than 300,000 extragalactic objects including geodetic VLBI sources.

F. Taris is the principal investigator of a quasar monitoring program in the optical frequencies (Taris et al. 2013, A&A 552, 98) using large telescopes (e.g., ESO) for monitoring of morphology and small robotic telescopes for measuring magnitude variability. The work aims at a better understanding of the link between radio and optical positions. Targets are both ICRF sources and sources designed for the link with Gaia.

The team will soon release a database gathering radio (VLBI) and optical (LQAC, morphology imaging and magnitude records) information.

More recently, the team also worked on dynamical modeling of AGN core from VLBI observations (Roland et al. 2014, A&A, accepted for publication). This work, devoted to 1926+738, indicates the possi-

ble presence of systems of black holes separated by more than 0.1 mas, and even multiple systems separated by more than 1 mas. Such configurations could have strong implications in the radio-to-optical link, depending on whether the various black holes are emitting in optical and/or radio frequencies.

Onsala Space Observatory – IVS Analysis Center Activities during 2014

Rüdiger Haas, Thomas Hobiger, Hans-Georg Scherneck, Johan Löfgren, Tong Ning, Niko Kareinen

Abstract This report briefly summarizes the activities of the IVS Analysis Center at the Onsala Space Observatory during 2014 and gives examples of results of ongoing work.

1 General Information

We concentrate on research topics that are relevant for space geodesy and geosciences. These research topics are related to data observed with geodetic VLBI and complementing techniques.

2 Activities during the Past Year

We worked primarily on the following topics:

- Automated reference point determination
- A local tie vector based on classical survey and GPS measurements
- A purely GPS-based local tie vector
- Evaluation of DBBC vs. Mark IV
- VLBI with GLONASS signals
- Coastal sea level observations with GNSS
- Ocean Tide Loading
- Gravimetry observations

Chalmers University of Technology, Department of Earth and Space Sciences, Onsala Space Observatory

Onsala Analysis Center

IVS 2014 Annual Report

3 Automated Reference Point Determination

The approach to determine the reference point of a radio telescope in an automated fashion during ongoing VLBI observations [1] was applied to the CONT14 campaign. Several retro-reflectors were mounted on the elevation cabin of the 20-m radio telescope and then observed from various survey pillars with total stations while the telescope was observing CONT14. A manuscript describing the experiment and its results is in preparation.

4 A Local Tie Vector Based on Classical Survey and GPS Measurements

In connection to the above described automated determination of the reference point of the 20-m radio telescope, a classical survey of the complete local site network was also performed, including the reference point of the IGS station ONSA. This allowed us to determine a new realization of the local tie vector between the VLBI and GNSS reference points at the observatory in the local coordinate system. After the classical survey, a several week long GPS campaign was performed in the local network. The corresponding data analysis gave the coordinates of the markers of the local survey network in a global cartesian coordinate system. Thus, by combining the local survey results and the results from the GPS campaign, a new realization of the local tie vector expressed in a global cartesian coordinate system could be determined. The results were submitted to IERS to be used for the preparation of ITRF2014.

5 A Purely GPS-based Local Tie Vector

GPS data observed with the receivers connected to two gimbal-mounted GPS antennas on the 20-m radio telescope were analyzed for several observing sessions, both kinematic ones during real VLBI sessions, and dedicated semi-kinematic stop-and-go sessions. The data were analyzed together with the data from the IGS station ONSA and successively the reference point of the radio telescope, the axis offset, and the local tie vector between the VLBI and GNSS reference points were determined. The analysis shows that both types of sessions, i.e. kinematic and semi-kinematic, give consistent results, for both the local tie vector and the telescope axis offset. The repeatability of the local tie vector from the different sessions is on the order of 1.5 to 3 mm for the different components. The agreement with the ITRF2008 local tie vector is on the level of 1 to 5 mm in the different components. The study shows that this approach is suitable to continually monitor the local tie vector at co-location sites with accuracies on the order of a few millimeters [2].

6 Evaluation of DBBC vs. Mark IV

During 2013 and 2014, a large number of geodetic VLBI sessions performed at Onsala were observed both with the old Mark IV/Mark 5A data acquisition system and with the new DBBC/Mark 5B+ data acquisition system. Zero-baseline tests were performed using the DiFX software correlator at Onsala and at the Bonn correlator. The Bonn correlator also produced several VLBI databases that include two Onsala stations, one with the Mark IV/Mark 5A data acquisition system and one with the DBBC/Mark 5B+ data acquisition system. Several of these databases were analyzed and investigated for systematic differences in both the raw observations and also the geodetic parameters derived from the analysis [3]. No significant differences were found, and as a result of this study we decided to retire the old Mark IV rack in the summer of 2014 and to completely switch over to an operational use of the DBBC/Mark 5B+ data acquisition system.

7 VLBI with GLONASS Signals

We continued test experiments to perform VLBI observations with signals of GLONASS satellites. These tests were done on the Onsala-Wetzell baseline, involving the L-band system on the Onsala 25-m telescope and the L-band receiver on the Wetzell 20-m telescope. The data were successfully correlated with the DiFX software correlator installed at Onsala [4]. Different a priori delay models were tested. The correlation results were post-processed with both AIPS and Fourfit.

From the AIPS post-processing we could successfully determine group delays, integrated delay rates, and phase delays. The RMS-scatter of the phase delays was on the level of 10 ps for solution intervals of 2 s, while group delays reached an RMS-scatter below 1.5 ns for solution intervals not shorter than 30 s. Total delay values, i.e. a priori delay models plus fringe-fitted delay residuals from AIPS, agreed on a level of 0.8–0.9 ns for group delays and 0.2–0.4 ns for phase delays (approximated by integrated delay rates) [4].

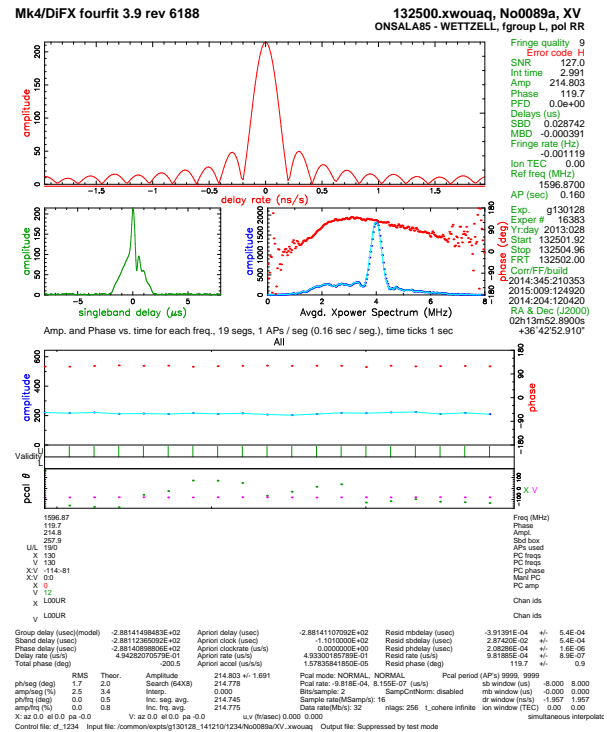

Fig. 1 Fringe plot for one scan of the GLONASS-VLBI experiment G130128, observed on the baseline Onsala–Wetzell.

An example for post-correlation analysis with Fourfit is presented in Figure 1, which depicts the fringe plot for one scan of the experiment G130128. A high quality fringe with SNR 127 and stable phase is achieved from an integration time of just 3 s.

8 Coastal Sea Level Observations with GNSS

We used the GNSS-R tide gauge at Onsala to study reflected signals from multiple GNSS, i.e. from GPS and GLONASS. The recorded data were analyzed with two different strategies, using only data from the upward-looking antenna and applying the SNR analysis, and using data from both antennas and applying geodetic phase delay analysis. The analysis shows that multi-GNSS signals give consistent results for sea level derived from reflectometry [5]. The agreement with respect to sea level observed by a co-located traditional tide gauge is better for the phase-delay analysis than for the SNR analysis. Figure 2 depicts results from the analysis of multi-GNSS observations collected during 20 days in 2012. The root-mean-square (RMS) differences were on the level of 32 to 35 millimeters for GPS and GLONASS phase-delay solutions, while the SNR solutions gave RMS differences on the order of 40 to 90 millimeters. The worst RMS agreement was achieved with SNR analysis on the L2 frequency.

The SNR approach was applied also to other coastal stations worldwide that are only equipped with one upward-looking GNSS antenna [6]. The chosen stations were located in different regions around the world, in both hemispheres and exposed to different multi-path environments, as well as different tidal ranges. All stations had co-located traditional tide gauges that could be used for comparison to the derived sea level results. The analysis shows that the relative accuracy of the SNR technique, defined as the ratio of RMS and tidal range, is between 2.4% and 10.0% for all stations.

A new reflectometry instrument that focuses specifically on GLONASS signals was compared to the Onsala GNSS-R tide gauge. The new system is based on rather inexpensive commercially off-the-shelf equipment. It could be shown that the precision and accuracy of the GLONASS-R system is comparable to the existing GNSS-R [7].

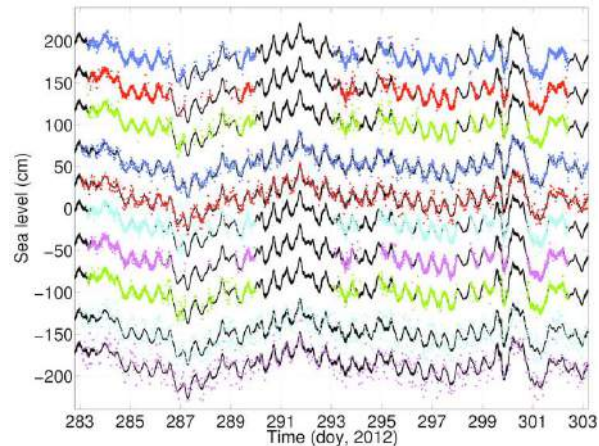

Fig. 2 Sea level derived from the GNSS tide gauge at the Onsala site during 20 days in 2012 (October 9 to 29). From top to bottom the sea level time series are derived from: GPS phase (L1), GLONASS phase (L1), GPS and GLONASS phase (L1), GPS SNR (L1), GLONASS SNR (L1), GPS phase (L2), GLONASS phase (L2), GPS and GLONASS phase (L2), GPS SNR (L2), and GLONASS SNR (L2). Each time series is paired with the independent sea level observations from the co-located tide gauge (black line). A mean is removed from each time series, and the pairs are displayed with an offset of 40 cm to improve visibility.

9 Ocean Tide Loading

The Automatic Ocean Tide Loading service was operated throughout the year. It is heavily used by the international scientific community.

10 Gravimetry Observations

The superconducting gravimeter in the gravity laboratory was operated throughout the year. The data loss in 2014 was 0.52% in the one-second record, confined to one event at the end of February, a failing Flash Card memory in the data buffer of the ADCconverter. Since September 2014, tide solutions have been prepared on a weekly basis and results made available on the SCG homepage (<http://holt.oso.chalmers.se/hgs/SCG/toe/toe.html>).

The analysis includes the sea-level sensors at the Onsala Space Observatory as ancillary data in the regression. The RMS of the residual is typically below 8 nm/s^2 .

11 Future Plans

The IVS Analysis Center at the Onsala Space Observatory will continue its efforts to work on specific topics relevant to space geodesy and geosciences. For the future we plan to intensify our activities, in particular concerning tropospheric parameters, e.g. horizontal gradients in the atmosphere using VLBI, GNSS and radiometers. A special focus for the coming years will be work related to the Onsala Twin Telescope project. Furthermore, we will work on an automated near real-time analysis of the IVS INT-sessions. We will also continue our efforts concerning VLBI observations of GNSS signals.

References

1. Lösler M, Haas R, Eschelbach C. Automated and continual determination of radio telescope reference points with sub-mm accuracy: results from a campaign at the Onsala Space Observatory. *Journal of Geodesy*, 87(8), 791–804, doi: 10.1007/s00190-013-0647-y.
2. Ning T, Haas R, Elgered G (2014). Determination of the Telescope Invariant Point and the local tie vector at Onsala using GPS measurements. In: IVS 2014 General Meeting Proceedings “VGOS: The New VLBI Network”, Edited by Dirk Behrend, Karen D. Bayer, and Kyla L. Armstrong, Science Press (Beijing). 163–167. ISBN/ISSN: 978-7-03-042974-2.
3. Kareinen N, Haas R, La Porta L, Bertarini A (2014). Going digital – the transition from Mark IV to DBC at Onsala. In: IVS 2014 General Meeting Proceedings “VGOS: The New VLBI Network”, Edited by Dirk Behrend, Karen D. Bayer, and Kyla L. Armstrong, Science Press (Beijing). 178–182. ISBN/ISSN: 978-7-03-042974-2.
4. Haas R, Neidhardt A, Kodet J, Plötz C, Schreiber U, Kronsnabl G, Pogrebenko S, Duev D, Casey S, Marti-Vidal I, Yang J, Plank L (2014). The Wettzell—Onsala G130128 Experiment — VLBI Observations of a GLONASS Satellite. In: IVS 2014 General Meeting Proceedings “VGOS: The New VLBI Network”, Edited by Dirk Behrend, Karen D. Bayer, and Kyla L. Armstrong, Science Press (Beijing). 451–455. ISBN/ISSN: 978-7-03-042974-2.
5. Löfgren J, Haas R (2014). Sea level measurements using multi-frequency GPS and GLONASS observations. *EURASIP Journal on Advances in Signal Processing*, 2014(1), doi: 10.1186/1687-6180-2014-50.
6. Löfgren J, Haas R, Scherneck H-G (2014). Sea level time series and ocean tide analysis from multipath signals at five GPS sites in different parts of the world. *Journal of Geodynamics*, 80, 66–80, doi: 10.1016/j.jog.2014.02.012.
7. Hobiger T, Haas R, Löfgren J (2014). GLONASS-R: GNSS reflectometry with an FDMA based satellite navigation system. *Radio Science*, 49(4), 271–282, doi: 10.1002/2013RS005359.

PMD Analysis Center 2014 Annual Report

Vincenza Tornatore

Abstract Research activities carried out at the (PMD) IVS Analysis Center during 2014 are briefly highlighted, and future plans for 2015 projects are outlined in this report. The main topics tackled during 2014 concern so called space ties and consistency of Celestial and Terrestrial Reference Systems materializations. Comparisons with other geodetic techniques have been performed for parameter estimates related to tropospheric and ionospheric effects.

1 General Information and Staff

Milan University of Technology (Politecnico di Milano), Department of Civil and Environmental Engineering (DICA) [1] hosts and supports activities of the PMD (Politecnico di Milano DICA) Analysis Center. In particular the Geodesy and Geomatic research area of DICA supplies hardware equipment, software licenses and assistance, and the personnel necessary to manage it.

The following collaborators gave their contribution to the development of PMD activity during 2014:

- Vincenza Tornatore — team coordinator, responsible for AC projects and data analysis;
- Giovanna Venuti — GNSS troposphere parameter estimation;
- Cinzia Vajani — software maintenance;
- Daniele Passoni — data processing.

Politecnico di Milano, Department of Civil and Environmental Engineering (DICA), Geodesy and Geomatic area

PMD Analysis Center

IVS 2014 Annual Report

2 Current Status and Activities

Research topics investigated during 2014 mainly addressed problems related to reference frame stability and inter-technique comparisons of different parameters estimated using data from geodetic space techniques such as GNSS (Global Navigation and Satellite Systems), VLBI (Very Long Baseline Interferometry), and Doppler Orbitography and Radio Positioning Integrated by Satellite (DORIS). The activities can be summed up in the following main research lines:

1. space ties: post-processing of VLBI correlated data of GNSS observations
2. ICRF stability
3. estimate of atmospheric parameters using space geodetic techniques.

2.1 Data Processing of VLBI Observations of Satellites

A number of observing tests of GNSS satellites by the VLBI technique were performed with some VLBI stations able to receive GNSS frequencies during past years [12]. The efforts were dedicated to a deeper analysis of the correlation output to investigate possible indications to improve observations or correlation of the artificial satellite signals. For this analysis, software that is widespread in the radio astronomy community for processing natural radio source data was used. The software is the Astronomical Image Processing System (AIPS) developed and maintained by NRAO [2].

The data were stored in files of FITS-IDI (Flexible Image Transport System-Interferometry Data Inter-

change) [8] format with 0.5 s integration time. To calculate the delays and rates necessary for geodetic parameter estimation, first fringe-fitting [5], had to be applied. Here, as an example, we report on the analysis of one experiment which gave some useful information.

As the first step the amplitude and phases of the visibility fringes were plotted as they were collected in the FITS file (every 0.5 s) without any summation or averaging. Some insights of plots at two epochs, differing by only 0.5 s, showed that the phase often changed by about 160 deg. This big change of the phase during only 0.5 s, corresponding to a variation of about 10 cm in the correlator model, seems to be very high and requires some improvements of the model.

Fringe fitting was attempted with different integration times, but solutions became worse with increasing of integration time. The best solution was that with integration time equal to observation time, i.e. 0.5 s. The fringe fitting was done on a full first scan average of four minutes, beginning on channel BCHA 235 to ECHA 275, selecting only the strongest peaks. Then solutions were applied to all of the 512 channels. This result, obtained by taking correlation integration time equal to observing time interval, prevents the calculation of rates during the fringe fitting, because during 0.5 s integration time we have only one point in the plot of the phase with time. To make possible a good estimate of rates (the slope of phases with time) we should have in each integration time a good number of points (e.g. 20 points, one every eight degrees). This corresponds to a request of correlation, for the data of this example, not every 0.5 s but e.g. every 0.025 s (0.5/20). In this experiment only delays and phases could be corrected during fringe fitting; in Figure 1 DELAYS of antenna 2 with respect to antenna 1 are represented for each of the observed four IFs, and in Figure 2 PHASES are shown. Rates could be not determined on the basis of a single integration.

During inspection of the correlated data it was also noticed that the amplitude of the signals progressively decreases as long as the scan proceeds. One possible explanation could be that during the four minutes of observations, the satellite travels out of the antenna primary beam. In fact, because of the lack of proper antenna software (continuous tracking) it was possible to track the satellite only stepwise.

After this work, the following suggestions for satellite signal correlation and observation can be gathered to obtain better results:

- recorrelate each scan of four minutes with an integration time of 0.025 sec;
- make a Doppler tracking as good as possible;
- check the correlator model (10 cm is really a large number);
- use continuous tracking during observations.

2.2 ICRF Stability

Baselines, site coordinates, and CPO were estimated in ICRF1 and ICRF2 [7], using the software VieVS [4] and following the IERS (International Earth Rotation and Reference Systems Service) Recommendations [10] and the IVS (International VLBI Service for Geodesy and Astrometry) Conventions on VLBI data processing [9]. Time series of estimated parameters have been deeply analyzed, using standard Allan deviation methods, in tight collaboration with the VIE IVS Analysis Center (AC) and the PUL IVS AC. A thorough description of the analysis and discussion of the results have been submitted for publication.

2.3 Estimation of Atmospheric Parameters using VLBI and GNSS Data

The Geodesy and Geomatics area of the DICA (Department of Civil and Environmental Engineering) is developing algorithms to process and analyze GNSS and VLBI data, not only for positioning purposes but also for estimation of tropospheric parameters, that today have an increasing interest for meteorological applications. More specifically these parameters are tropospheric and VTEC estimation parameters by GNSS and VLBI techniques carried out during 2014 for inter-technique comparisons and for real time modelling of troposphere parameters by national GNSS networks. We dispose in Italy a national GNSS network: Rete Dinamica Nazionale (RDN) and of several regional real time GNSS networks [3]; then three sites are collocated with GNSS and VLBI equipment [11]. Some tests have been performed in collaboration with the IVS KTU AC for the use of the Scientific GNSS software Bernese version 5.2 [6], to estimate atmospheric parameters.

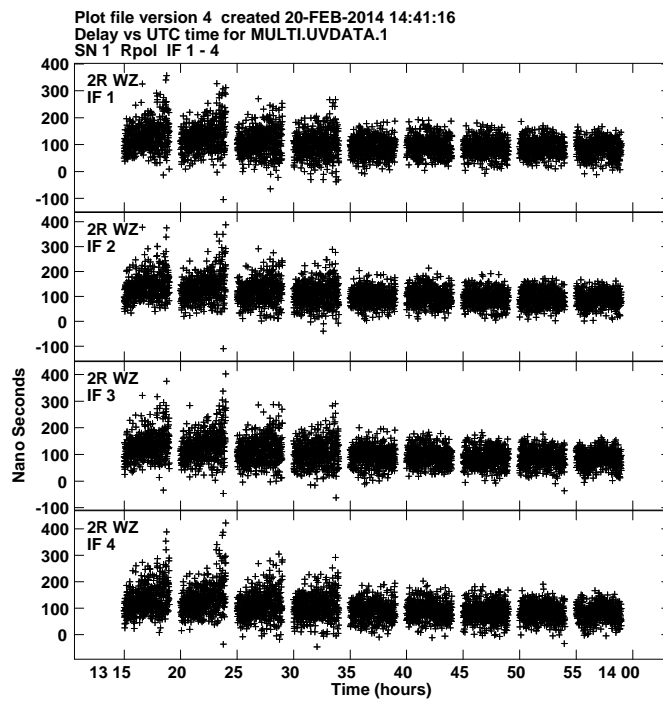

Fig. 1 Solutions from fringe fitting, delays of antenna 2 with respect to antenna 1.

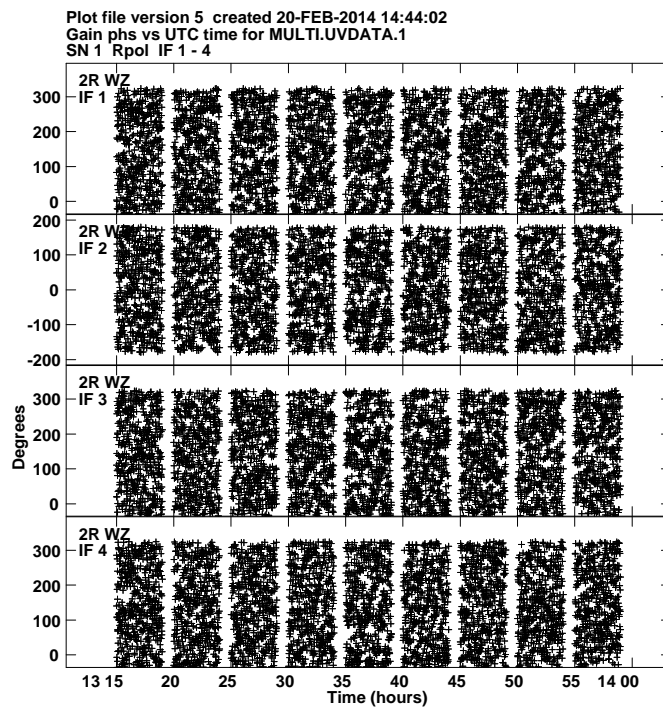

Fig. 2 Solutions from fringe fitting, phases of antenna 2 with respect to antenna 1.

3 Future Plans

The PMD Analysis Center plans to tackle the following topics during 2015: co-location on Earth and in Space for improved reference frames, investigation into dedicated algorithms for improvement of tropospheric parameter estimation and comparisons among atmospheric parameter estimates that come from the space geodetic techniques of VLBI and GNSS and that are particularly addressed to a not very broad region. Then in collaboration with IVS KTU AC an inter-technique comparison between VLBI and DORIS for a combination of TRF common parameters is being set up.

References

1. <http://www.dica.polimi.it/en/> Politecnico di Milano (DICA) website
2. <http://www.aips.nrao.edu/cook.html> AIPS Cookbook
3. Benciolini, B., Biagi, L., Crespi, M., Manzino, A. and Roggero, M., *Reference frames for GNSS positioning services: some problems and proposals* in *Journal of Applied Geodesy*, 53-62, 2008.
4. Böhm J., Böhm S., Nilsson T., Pany A., Plank L., Spicakova H., Teke K., Schuh H., *The new Vienna VLBI Software VieVS* in *IAG Symposium 139*, Kenyon S., Pacino M.C., Marti U. (eds), 1007-1012, 2012.
5. Cotton, W. D., *Fringe fitting*. ASP Conference Series, 82, 1995.
6. R. Dach, P. Walser (eds), *Bernese GNSS Software Version 5.2*, Astronomical Institute, University of Bern, 2013.
7. Fey A. L., Gordon D., Jacobs C. S. (eds), IERS technical note 35, *The second realization of the international celestial reference frame by very long baseline interferometry*, Verlag des Bundesamt für Kartographie und Geodäsie, Frankfurt am Main, 2009 (<http://www.iers.org/TN35>).
8. Greisen, E., *The FITS Interferometry Data Interchange Convention*. AIPS Memo114r, 2011.
9. Nothnagel A. *Conventions on thermal expansion modeling of radio telescopes for geodetic and astrometric VLBI*, in *Journal of Geodesy*, 83, 787—792, 2008.
10. Petit G., Luzum B. (eds.), *IERS Conventions (2010)*, *IERS Technical Note 36*, Frankfurt am Main: Verlag des Bundesamt für Kartographie und Geodäsie, 2010.
11. Ray, J. and Z. Altamimi, *Evaluation of co-location ties relating the VLBI and GPS reference frames*, in *Journal of Geodesy*, 79(4-5), doi: 10.1007/s00190-005-0456-z 189-195. 2005.
12. Tornatore, V., R. Haas, S. Casey, D. Duev, S. Pogrebenko, G. Molera Calvés, *Direct VLBI Observations of Global Navigation Satellite System Signals*, *Earth on the Edge: Science for a Sustainable Planet. IAG Symposium 139*, doi: 10.1007/978-3-642-37222-3_32247-252, ISBN (online): 978-3-642-37221-3, 2014.

Pulkovo IVS Analysis Center (PUL) 2014 Annual Report

Zinovy Malkin, Yulia Lopez (née Sokolova)

Abstract This report briefly presents the PUL IVS Analysis Center activities during 2014 and plans for the coming year. The main topics of the investigations of the PUL staff in that period were ICRF-related studies, computation and analysis of EOP series, celestial pole offset (CPO) and free core nutation (FCN) modeling, and VLBI2010 related issues.

1 General Information

The PUL IVS Analysis Center was organized in September 2006. It is located at and sponsored by the Pulkovo Observatory of the Russian Academy of Sciences. It is a part of the Pulkovo EOP and Reference Systems Analysis Center (PERSAC) [1]. The main topics of our IVS related activity are:

- Improvement of the International Celestial Reference Frame (ICRF).
- Computation and analysis of the Earth orientation parameters (EOP) from Intensives and 24-hour IVS sessions.
- Analysis of EOP and source position time series.
- Modeling of the celestial pole offset (CPO) and free core nutation (FCN).
- Comparison of VLBI products, primarily EOP, with results of other space geodesy techniques.
- Computation and analysis of observation statistics.

The PUL Analysis Center Web page [2] is supported. It contains the following sections:

Pulkovo Observatory

Pulkovo Analysis Center (PUL)

IVS 2014 Annual Report

- *General information about the PUL Analysis Center.* Includes brief history, activity overview, and a scientific staff list.
- *VLBI data analysis.* Includes results of VLBI data analysis, such as UT1 Intensive series, CPO/FCN series, and mean Pole coordinates. These data are updated daily.
- *OCARS catalog.* Includes the latest version of the catalog OCARS (Optical Characteristics of Astrometric Radio Sources) [3]. The catalog is regularly updated as new information becomes available.
- *Approaches and occultations.* Includes tables for forthcoming mutual events of planets and astrometric radio sources, such as close angular approaches and occultations for the period until 2050 [4].
- *PUL members' publications and presentations.*
- *VLBI technology overview.*
- *Links to the VLBI World.* Includes links to (primarily geodetic and astrometric) VLBI coordinating bodies, stations, analysis centers, software, etc.
- *Contact information.*

2 Staff

In 2014 the following persons contributed to the PUL activity:

1. Zinovy Malkin (70%) — team coordinator, EOP and CRF analyst;
2. Yulia Lopez (née Sokolova) (100%) — CRF analyst.

3 Activities and Results

The main activities and results of the PUL IVS Analysis Center during 2014 included:

- *ICRF-related research.* The main directions of this activity were comparison and combination of radio source position catalogs and investigation of their stochastic and systematic errors. In 2014, the following results were obtained:
 - A new method of investigation of the stochastic errors of external radio source position catalogs (RSPCs) has been tested [5]. Using this method the stochastic errors of nine recently published RSPCs were evaluated. It has been shown that the result can be affected by the systematic differences between catalogs if the latter are not accounted for. It was also found that the formal uncertainties of the source positions in the RSPCs correlate with the external errors. We also investigated several topics related to the formal uncertainties and systematic errors of RSPCs.
 - We continued investigations of the impact of the correlation information on the orientation parameters between celestial reference frames [6]. We compared results of determination of the orientation angles between celestial reference frames realized by radio source position catalogs using three methods of accounting for correlation information: using the position errors only, using additionally the correlations between the right ascension and declination (RA/DE correlations) reported in radio source position catalogs published in the IERS format, and using the full covariance matrix. The computations were performed with nine catalogs computed at eight analysis centers. Our analysis has shown that using the RA/DE correlations only slightly influences the computed rotational angles, whereas using the full correlation matrices leads to substantial change in the orientation parameters between the compared catalogs.
 - *Studies related to modeling the Galactic aberration in source proper motions.*
 1. We analyzed all available determinations of the Galactic rotation parameters R_0 and Ω_0 made during the last ten years to derive the most probable value of the Galactic aberration constant $A = R_0\Omega_0^2/c$ [7]. We used several statistical methods to obtain reliable estimates of R_0 and Ω_0 and their realistic errors. As a result, we obtained the value of $A = 5.0 \pm 0.3 \mu\text{as/yr}$ as the current best estimate of the GA constant. We suggest that the proposed value of the GA constant can be safely used in practice during coming years.
 2. During recent years, much attention has been paid to the astrometric implications of the galactic aberration in proper motions (GA). This effect causes systematic errors in astrometric measurements at the μas level. Some authors consider it so serious that it requires redefinition of the celestial reference frame (CRF). We argue that such attention to the GA is too much exaggerated. It is just a small astrometric correction that must be taken into account during highly accurate astrometric and geodetic data processing. The accuracy of this correction depends on the accuracy of the Galactic rotation parameters and, for most applications, on the accuracy of the rotation matrix between Galactic and equatorial systems. Our analysis has shown that our knowledge today of these two factors is sufficient to compute the GA correction with accuracy of better than 10%. The remaining effect at a level of few tenths $\mu\text{as/yr}$ is negligible nowadays. Another consequence of introducing the GA correction is the necessity to return to classical astrometric modeling of the VLBI-derived extragalactic radio source positions by the linear trend model. Changing the current paradigm of VLBI-derived CRF based on the assumption of zero motion of radio sources to the classical one leads to bias in the radio source positions up to several tens of μas for catalogs at epoch J2000.0 [8].
 - The OCARS catalog [3] has been supported since 2008. The catalog provides redshift information, as well as visual and NIR magnitudes. The improvements made in 2014 include addition of new sources and new measurements of redshift and magnitude. A new file with detailed

photometric data, `ocars_m.txt`, is now supported in addition to the main OCARS catalog file, `ocars.txt`. The current basic statistics of the OCARS catalog are given in Table 1.

- *CPO and FCN related research.* The main activities and results in 2014 were the following:
 - Two CPO and two FCN series were updated daily and are available at the PERSAC Web page [1].
 - Several VLBI-derived CPO time series were analyzed with the goal of detecting the Free Inner Core Nutation (FICN) [9]. The series were investigated by means of spectral and wavelet analysis. It was shown that there are several periodic signals with close amplitude around the expected FICN period without a prevailing one, which can be associated with the FICN. So, it seems to be necessary to improve the theoretical estimates of the FICN period to make searching for it in the observational series more promising.
 - Corrections to the IAU 2000/2006 parameters of the theory of precession and nutation were calculated using five different series: two individual series and three combined series that have been used in the literature for this purpose. A comparison of the sets of corrections obtained using the different series indicates significant systematic differences between them, which often substantially exceed the corresponding random errors. At the same time, existing studies have usually used data obtained from one or two series chosen by the authors without special justification. When refining the theory of precession and nutation, it is necessary to consider and compare various available series of VLBI data if one wishes to reduce the systematic errors in an improved model [10].
- *Studies on investigation of the mutual impact of celestial and terrestrial reference frames, and impact of astronomical and geophysical modeling on ICRF.* Analysis of measurements of the space geodetic techniques requires the use of the best available models describing the deformation of the Earth's surface. The goal is to have a set of models which realistically describe changes in the station

positions on the Earth's surface during the time when the observations are carried out. We take advantage of a long time span of measurements (more than 29 years) gathered by the Very Long Baseline Interferometry (VLBI) technique, and we focus on the propagation of these unmodeled effects in all three station coordinates to the radio source positions building the celestial reference frame (CRF). Two treatment approaches of the unmodeled seasonal station displacement are introduced. As the first, we model the surface deformation as a periodic movement with annual and semi-annual periods, and in the second approach we create an average annual model [11].

- Operational data processing of IVS Intensive sessions in automated mode and submission of results to IVS was continued. The UT1 time series is available at IVS Data Centers and at the PERSAC Web page [1].
- The PUL archive of VLBI data and products obtained in the framework of IVS activity is supported. At present, all available databases and corresponding NGS cards for 1979—2014 are stored (about 9.4 million observations) along with the main IVS and IERS products. These archives are continually updated as new databases become available.
- Development of algorithms and software for data processing and analysis continued.
- PUL staff members participated in activities of several IERS, IAG, and IVS projects, committees, and working groups.

4 Future Plans

Plans for the coming year include:

- Continuing ICRF-related studies.
- Continuing CPO/FCN-related studies.
- Continuing UT1 Intensive data processing.
- Continuing OCARS catalog support.
- Continuing development of algorithms and software for data processing.
- Continuing support of the PUL archives of data and products.

Table 1 Current basic statistics of the OCARS catalog.

	All sources	ICRF2 sources	ICRF2 defining
Sources	9,049	3,414	295
Sources with redshift information	4,901 (54.2%)	2,332 (68.3%)	262 (88.8%)
Sources with photometric data	5,973 (66.0%)	2,643 (77.4%)	286 (96.9%)

References

1. <http://www.gao.spb.ru/english/as/persac/index.htm>
2. http://www.gao.spb.ru/english/as/ac_vlbi/
3. http://www.gao.spb.ru/english/as/ac_vlbi/ocars.txt
4. http://www.gao.spb.ru/english/as/ac_vlbi/occultations_approaches.pdf
5. Malkin Z., 2014, On errors of radio source position catalogs. In: Proc. Journées 2013 Systemes de Reference Spatio-temporels, Ed. N.Capitaine, Observatoire de Paris, 69–72.
6. Sokolova Y., Malkin Z., 2015, On impact of the correlation information on the orientation parameters between celestial reference frames. In: C. Rizos, P. Willis (eds.), IAG Symposia, v. 143, in print.
7. Malkin Z., 2014, On the Galactic aberration constant. In: Proc. Journées 2013 Systemes de Reference Spatio-temporels, Ed. N.Capitaine, Observatoire de Paris, 44–45.
8. Malkin Z., 2014, On the implications of the Galactic aberration in proper motions for the Celestial Reference Frame. MNRAS, 445(1), 845–849.
9. Malkin Z., 2014, On detection of the free inner core nutation from VLBI data. In: Proc. Journées 2013 Systemes de Reference Spatio-temporels, Ed. N.Capitaine, Observatoire de Paris, 224–225.
10. Malkin Z.M., 2014, On the Accuracy of the Theory of Precession and Nutation. Astronomy Reports, v. 58(6), 415–425.
11. Krásná H., Malkin Z., Böhm, J., 2014, Impact of seasonal station displacement models on radio source positions. In: Proc. Journées 2013 Systemes de Reference Spatio-temporels, Ed. N.Capitaine, Observatoire de Paris, 65–68.

SAI VLBI Analysis Center 2014 Annual Report

Vladimir Zharov

Abstract This report presents an overview of the SAI VLBI Analysis Center activities during 2014 and the plans for 2015. The AC SAI analyzes all IVS sessions for computations of the Earth orientation parameters (EOP) and time series of the ICRF source positions, and it performs research and software development aimed at improving the VLBI technique.

The package ARIADNA (v. 4) is the basis of software named as ORBITA installed on the correlator of the AstroSpace Center at the Lebedev Physical Institute. It is used for the correlation of the ground-space interferometer data during the Radioastron mission. A new modification of the software was developed to perform correlation in “Coherent” mode (see below).

1 General Information

The SAI VLBI Analysis Center is located at Sternberg State Astronomical Institute of Lomonosov Moscow State University in Moscow, Russia. The Analysis Center participates in geodetic and astrometric VLBI analysis, software development, and research aimed at improving the VLBI technique especially for support of the Radioastron mission.

2 Component Description

AC SAI performs data processing of all kinds of VLBI observation sessions. For VLBI data analysis we use the ARIADNA software package developed at SAI. Version 4 was finished and tested in 2012. All reductions are performed in agreement with the IERS Conventions (2010).

ARIADNA uses files in NGS format as input data.

Sternberg State Astronomical Institute (SAI) of Lomonosov Moscow State University

SAI Analysis Center

IVS 2014 Annual Report

3 Staff

- Vladimir Zharov, Prof.: development of the ARIADNA software, development of the methods of parameter estimation;
- Nikolay Voronkov, scientific researcher: global solution;
- Svetlana Nosova, engineer: VLBI data processing;
- Natalya Shmeleva, engineer: VLBI data processing.

4 Current Status and Activities

• Software development for VLBI processing

The ARIADNA software is being developed to provide contributions to IVS products. The software is used for calculating all types of IVS products. Version 4 was developed in 2012. The main features of this version are performing all reductions in agreement with the IERS Conventions (2010), generation of SINEX files, and the combination of some of the SINEX files to stabilize solutions.

The used version of this software was corrected in 2013: now it is possible to use the CIO-based trans-

formation matrix. New series of the EOP were obtained from observations that were made in 2013.

The method that uses the calculation of the equinox-based transformation matrix for precession-nutation was kept to compare new series with old ones. The equinox-based matrix $Q(t)$ that transforms from the true equinox and equator of date system to the GCRS is composed of the classical nutation matrix, the precession matrix including four rotations, and a separate rotation matrix for the frame biases. New series of the nutation angles will be used for the preparation of our suggestion to improve the nutation theory. Some corrections of the model of delay for the ground-space interferometer were made and realized in the ORBITA software, which is used for correlation and routine analysis of the Radioastron observations.

There is a so-called “Coherent” mode for correlation of the ground-space interferometer data during the Radioastron mission. It was developed to support an onboard reference frequency source by synchronizing it from the ground based master H-maser at a tracking station (TS). The phase stable signal of the ground based H-maser frequency is converted to RF, transmitted forward to Radioastron spacecraft and then, after coherent conversion, is transmitted back to the TS. At the TS, both signals (transmitted and received) can be compared to evaluate Doppler residuals and phases, and after that, the timing of the data flow can be corrected. The Coherent mode is the important procedure to keep efficiency of the ground-space interferometer in cases of outage events of the highly stable onboard H-maser. The Coherent mode processing algorithm is realized in the ASC FX correlator.

- **Routine analysis**

During 2014, routine data processing was performed with the ARIADNA software using the least-squares method with rigid constraints, and non-rigid constraints were used for generation of SINEX files.

AC SAI operationally processed the 24-hour and Intensive VLBI sessions. Forming the VLBI sessions’ databases and processing of all sessions is fully automated. The EOP series sai2014a.eops and sai2014a.eopi were calculated. These series were computed with the catalog VTRF2008 of station positions and velocities. Experimental series

sai2014c.eops was calculated for development of a new nutation theory.

SHAO Analysis Center 2014 Annual Report

Guangli Wang¹, Jinling Li¹, Minghui Xu^{1,2}, Li Guo¹, Fengchun Shu¹, Zhihan Qian¹, Liang Li¹

Abstract This report presents the routine work and the research carried out at the SHAO VLBI Analysis Center (AC) during 2014. The SHAO AC continues the routine VLBI data analysis of 24-hour geodetic/astrometric sessions to generate products, and it processes the CVN data, which will be submitted to the IVS starting in 2015. We also carry out the navigation for the Chang'E mission, using the VLBI technique as usual, and some basic research in astrometry, which are the systematical variations in the Celestial Reference Frame and the effect of aberration.

1 General Information

The SHAO VLBI Analysis Center is located at the Shanghai Astronomical Observatory, Chinese Academy of Sciences, Shanghai, China. It is a part of the astrometry research group in the department of astro-geodynamics. Some members are from the VLBI application in the Chinese deep space mission. Therefore, we are processing the Chinese VLBI Network (CVN) data, IVS 24-hr routine sessions, and 1-hr Intensive UT1 sessions.

1. SHAO, Chinese Academy of Sciences
2. GFZ

SHAO Analysis Center

IVS 2014 Annual Report

2 Activities during the Past Year

The SHAO Analysis Center analyzed all the IVS sessions and five CVN sessions (including resolving ambiguities and determining the ionospheric effect from dual band data) by using the Calc/Solve and the nuSolve software package. During 2014, we continued generating the ITRF2013 solution, which extends the VLBI observations from the end of 2013 to 2014. We provided VLBI products, i.e., EOP, CRF, and TRF, for the Chinese EOP Services.

3 Current Status

- Resolving ambiguities. We investigated the principle and the methods that were used to resolve the ambiguities of the VLBI group delay by using the single band delay. Even though the ambiguity issue was solved from the very beginning of the VLBI technique, the deep understanding of this procedure will facilitate both the data analysis and resolving sub-ambiguities. Some ambiguity points can be effectively identified by comparing the ionosphere effects from the single band delay. This work was partly carried out by using nuSolve, which is quite helpful software with a GUI.
- Ionosphere effect. The ionosphere effect correction is obtained from dual band data by using the ionosphere effect free combination. It is calculated based on the effective frequency, which is a weighted “mean” frequency depending on the amplitude of the cross correlation and the number of the accumulated period. Thus, it varies with respect to time and also baseline due to the loss of

data in some channels or lower amplitude at some sidebands. As a result, if there is a constant offset in a baseline between two bands after closing all the triangles in the big network, this constant offset can not be completely absorbed by the clock model because this offset is not a constant after correcting the ionosphere effect. There are other problems left; for instance, its second order, the signal paths not being totally the same for two bands, and the scintillation.

- High frequency variation in source position. CONT14 is a campaign of continuous VLBI sessions, which was scheduled for observation starting in early May 2014 (6-MAY-2014 00:00 UT through 20-MAY-2014 24:00 UT). With a network size of 17 stations (ten in the northern hemisphere and seven in the southern hemisphere), it continually obtained more than 500 observables per day for about eight radio sources (for example, 1739+522, 0016+731, and 0059+581). These data provide a good opportunity to get high frequency variation, two- or four-hour interval, in the position of these radio sources, and to investigate these variations.
- Different level of NNT and NNR constraints. There are degeneracies of the normal equation when one determines TRF, CRF, and EOP by using VLBI. The common way of circumventing these degeneracies is to apply in the least-square adjustment no-net-rotation (NNR) and no-net-translation (NNT) constraints of the station positions and velocities of a subset of stations with respect to the ITRF, and NNR constraints to the defining sources with respect to the ICRF. We investigate the influence on the EOP, CRF, and TRF of three different degrees of these constraints, 0.1 *m*, 1 *mm*, and 0.01 *mm*. The results show that different degrees of the NNR and NNT constraints on the TRF have no impact on the CRF and precession but cause significant change in the TRF and ERPs. When the constraints were reduced to 1.0 mm and smaller, the difference was less than 1 mm for the station coordinates. But when looser constraints, such as 0.1 m, were used, big differences in the station positions led to significant drifts in the ERP.
- Solar velocity. The motion of the barycenter with respect to the CMB, probably steadily constant over a few hundred years, can be reasonably taken as the same as the motion of the object with respect to the

CMB and modeled into the effect of proper motion. As we know, the motion of each individual object is random over the sky, but the motion of the barycenter is identical for all objects. Therefore, there are two systematic effects in those variations, which requires consideration for recently refined measurements in astrometry: the apparent proper motion caused by the acceleration of the barycenter with respect to the CMB (Xu et al., 2014), which has been determined and discussed in a series of papers, and the proper motion caused by the velocity of the barycenter with respect to the CMB, which is actually the variation in the parallax effect caused by this motion. Simulations and estimation from VLBI data are being made to get interesting results.

- Aberration. Special efforts are still being made to clarify this (Xu et al. 2014).
- CVN data. The CVN data analysis includes resolving ambiguities, determining the ionosphere effect, detecting clock breaks, identifying the outliers, and estimating the geodetic parameters. We are preparing to submit these data to the IVS so that they can be widely used.
- ITRF2013. Due to the ITRF2013 solution having been changed from 2013 to 2014 to include all the 2014 VLBI data available until February of 2015, we continued the data analysis to provide the complete solution to the IVS.

4 Staff

During 2014, the staff of SHAO AC contained one consultant, the group leader Dr. Wang, three employees, and two PhD students. Dr. Wang is also a member of the Observing Program Committee in the IVS. Post-doc, Zhibing Zhang joined us at the end of this year.

5 Future Plans

Plans for the future include contributing to the ICRF3, investigating the ionosphere effect, preparing the CVN data, and submitting to the IVS. We will also collect the resources and the staff to develop new VLBI data analysis software, with which we can contribute more to VLBI and VLBI2010.

Table 1 Staff members and the main tasks.

Dr. Guangli Wang	VLBI2010, observing, data analysis, and head leader
Dr. Jinling Li	Positioning, VLBI2010, and data analysis
MSc. Minghui Xu	Data analysis, ITRF solution, CRF and astrometry in VLBI
Dr. Li Guo	Positioning, data analysis
Dr. Fengchun Shu	Scheduling, correlation, and data analysis
Dr. Zhihan Qian	Consulting
MSc. Liang Li	Data analysis and CRF

References

1. M. Xu, R. Heinkelmann, H. Schuh, M. Zhao, and G. Wang. The acceleration of the origin of the ICRF. In D. Behrend, K. D. Baver, and K. Armstrong, editors, Proceedings of the Eighth IVS General Meeting: VGOS: The New VLBI Network, pp. 412-416, 2014.
2. M. Xu and G. Wang. On the definition of aberration. In D. Behrend, K. D. Baver, and K. Armstrong, editors, Proceedings of the Eighth IVS General Meeting: VGOS: The New VLBI Network, pp. 490-494, 2014.

Tsukuba VLBI Analysis Center

Shinobu Kurihara ¹, Tetsuya Hara ^{1,2}

Abstract This report summarizes the activities of the Tsukuba VLBI Analysis Center during 2014. The weekend IVS Intensive (INT2) sessions were regularly analyzed using *c5++* analysis software. Several ultra-rapid dUT1 experiments were implemented in association with Onsala, Hobart, and HartRAO.

1 Introduction

The Tsukuba VLBI Analysis Center, located in Tsukuba, Japan, is hosted and operated by the Geospatial Information Authority of Japan (GSI). One of our major roles as an operational Analysis Center is to regularly analyze the weekend IVS Intensive (INT2) sessions using the fully automated VLBI analysis software *c5++* developed by the National Institute of Information and Communications Technology (NICT) [1]. It should be noted that the UT1-UTC (= dUT1) solution becomes available within a few minutes after the end of the last scan of the session. A 10 Gbps dedicated link to the SINET4 operated by the National Institute of Informatics (NII) and several process management programs make it possible to derive a solution rapidly. The ultra-rapid dUT1 experiments after some regular IVS 24-hour sessions and CONT14 sessions were implemented in 2014.

1. Geospatial Information Authority of Japan

2. Advanced Engineering Service Co., Ltd.

Tsukuba VLBI Analysis Center

IVS 2014 Annual Report

2 Component Description

2.1 Analysis Softwares

c5++, which is analysis software for space geodesy including SLR, GNSS, and VLBI, is officially used to provide a dUT1 solution from a regular INT2 session.

Calc/Solve has been in continuous use since the early days of VLBI work at GSI. It is used for the analysis of JADE, which is the Japanese domestic observation for geodesy, in its interactive mode and for global analysis in the batch mode. In June, we installed *vSolve* released by the GSFC VLBI group. It has been working well as a substitute for the legacy user interface of the interactive mode of *Solve*.

VieVS, developed by the Institute of Geodesy and Geophysics (IGG) at the Vienna University of Technology, is also installed at the Tsukuba Analysis Center [2].

2.2 Analysis Center Hardware Capabilities

c5++, *Calc/Solve*, and *VieVS* are installed on several general-purpose and commercially-produced Linux computers (Table 1). Individual RAIDs are mounted on each computer for storing many VLBI data files such as Mark III databases.

3 Staff

The technical staff at the Tsukuba Analysis Center are:

Table 1 Analysis Center Hardware Capabilities.

Number of servers	six for VLBI analysis (<i>c5++</i> , <i>Calc/Solve</i> , and <i>ViEVS</i>)
Operating System	CentOS version 5.4, 5.5, 6.5, and Red Hat Enterprise Linux 6.3
CPU	Intel Xeon @3.80GHz CPU x 2, Intel Xeon 5160 @3.00GHz dual CPU x 2, Intel Xeon X3360 @2.83GHz quad CPU, Intel Xeon X5687 @3.60GHz quad CPU x 2 Intel Xeon E3-1270V2 @3.50GHz quad CPU
Total storage capacity	individual RAID5: 5.49 Tbytes in total

- **Shinobu Kurihara**: correlator/analysis chief, management.
- **Tetsuya Hara** (AES): correlator/analysis operator, software development.

4 Analysis Operations

4.1 IVS Intensive for UT1-UTC

106 IVS Intensive sessions were analyzed at the Tsukuba Analysis Center, and dUT1 results were submitted as `gsiint2b.eopi` to the IVS Data Center (Table 2). Only the dUT1 parameter was estimated, with station positions fixed to a-priori. For the Tsukuba station after the 2011 Tohoku Earthquake, the position correcting its non-linear post-seismic motion provided by NASA/GSFC was used. The Tsukuba–Wettzell baseline and several other baselines were analyzed. The observed data at Wettzell is e-transferred to the Tsukuba Correlator in near real-time with the Tsunami UDP protocol. The correlated data is rapidly analyzed by *c5++* as soon as all of the correlator output comes in, and then a dUT1 solution is derived and submitted. The dUT1 solution becomes available at the IVS Data Center just after the session. The processes from data transfer through the submission of the solution are fully automated and done by unmanned operation. Since 19 out of the 101 Tsukuba–Wettzell baseline

Table 2 Intensive sessions analyzed at the Tsukuba Analysis Center.

	Baseline	# of sessions	Average of dUT1 sigma
Intensive 2	TsWz	101	9.3 μ sec
	KkWz	3	12.7 μ sec
	KbWz	2	28.3 μ sec
Total		106	9.7 μ sec

analyses had some sort of problem in the observed data or trouble at the stations, the automated analyses for those sessions failed. In the other 82 sessions, we succeeded in the rapid analysis with low latency, and 90% of them completed analysis within ten minutes after the end of the last scan (Figure 1). The end time of the IVS-INT2 sessions is 8:30 UT on every Saturday and Sunday. Thus, the dUT1 solution is available at the latest before 9 a.m. for users as an IVS product. Our products are utilized for more accurate dUT1 prediction by the U.S. Naval Observatory (USNO) as the IERS Rapid Service/Prediction Centre, which is responsible for providing earth orientation parameters on a rapid turnaround basis, primarily for real-time users and others needing the highest quality EOP information sooner than that available in the final EOP series.

Figure 2 shows the differences between the dUT1 solutions of each Intensive baseline and IERS EOP 08 C04 from January 2013 through December 2014.

4.2 Ultra-Rapid dUT1 Experiment

This experiment started in 2007 as a joint project of Japan (Tsukuba and Kashima) and Fennoscandia (Onsala and Metsähovi). It aims to derive a consecutive time series of dUT1 (or full set of EOP) as soon as possible. The observed data is sent in real-time via the international optical fiber backbone to Tsukuba where the data is correlated and analyzed. *c5++* is used in the whole analysis. Nowadays four countries — Japan, Sweden, Australia, and South Africa — are involved in association with Onsala, Hobart, and HartRAO.

In 2014, four regular IVS-R1 sessions and one R&D session were processed with the ultra-rapid mode (Table 3). Additionally, we operated the CONT14

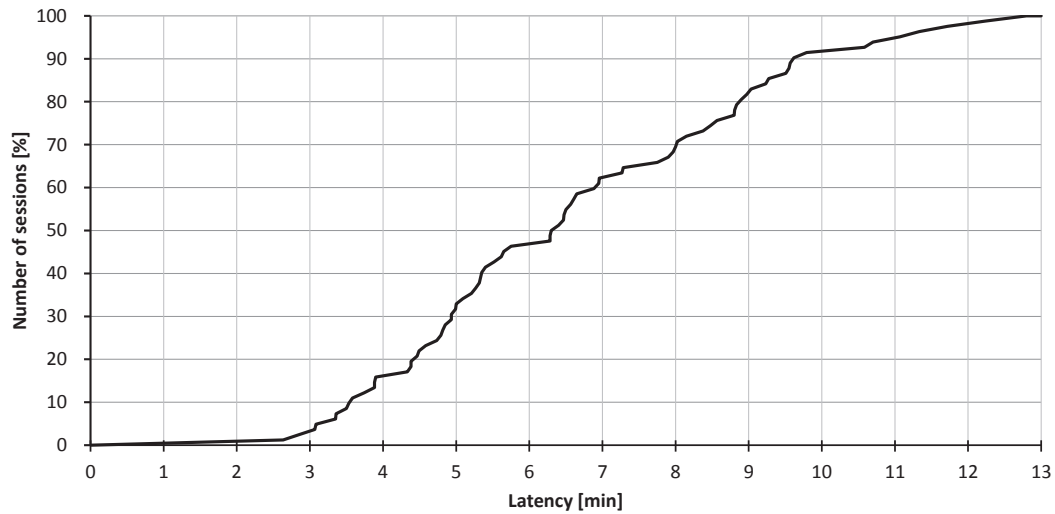

Fig. 1 Latency–number of sessions as % of 82 Tsukuba-Wetzell sessions. 19 sessions with some sort of trouble during the session are excluded.

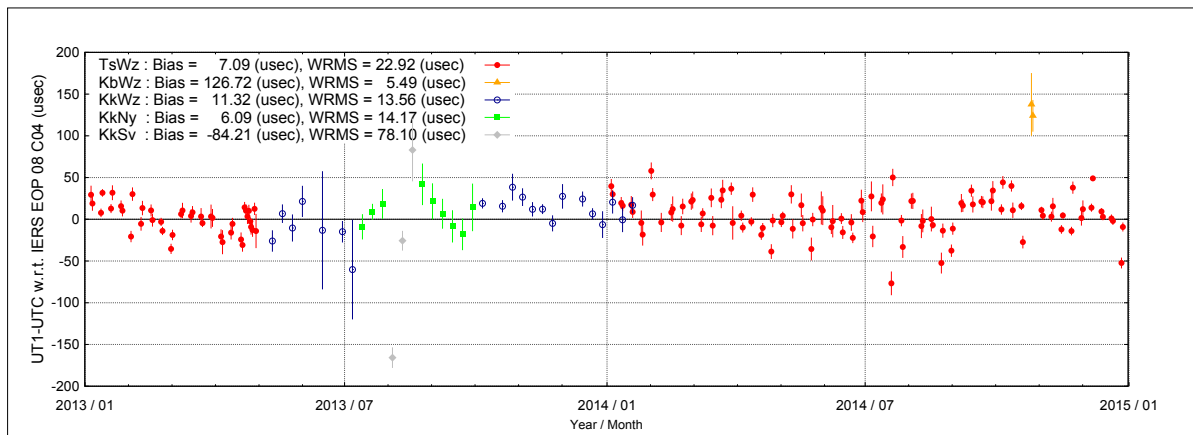

Fig. 2 The time series of UT1-UTC derived from IVS Intensive with respect to IERS EOP 08 C04. Error bars are 1σ formal uncertainties.

campaign with the ultra-rapid processing for the Onsala–Tsukuba baseline. The Onsala data were e-transferred in real-time to the Tsukuba correlator using the Tsunami protocol. The data were correlated with the corresponding data from the Tsukuba station in near real-time, followed by a near real-time analysis to determine dUT1. One dUT1 value was estimated from the dataset of correlator outputs in a three-hour period. When a new correlator output comes in, the three-hour analysis period shifts forward and the oldest data out of the period are left out, and then a new analysis is performed. The analysis strategy is called “sliding window” approach. As a result, we could

obtain a time series of dUT1 that is produced during the ongoing session with very low latency through 15 days. The average of the latency through 15 days was 6 min 18 sec. Figure 3 shows the estimated time series of dUT1, and Figure 4 shows differences between estimated dUT1 and IERS Rapid Prediction.

5 Outlook

We will continue to analyze the data of the IVS-INT2 sessions and submit dUT1 products with a low latency.

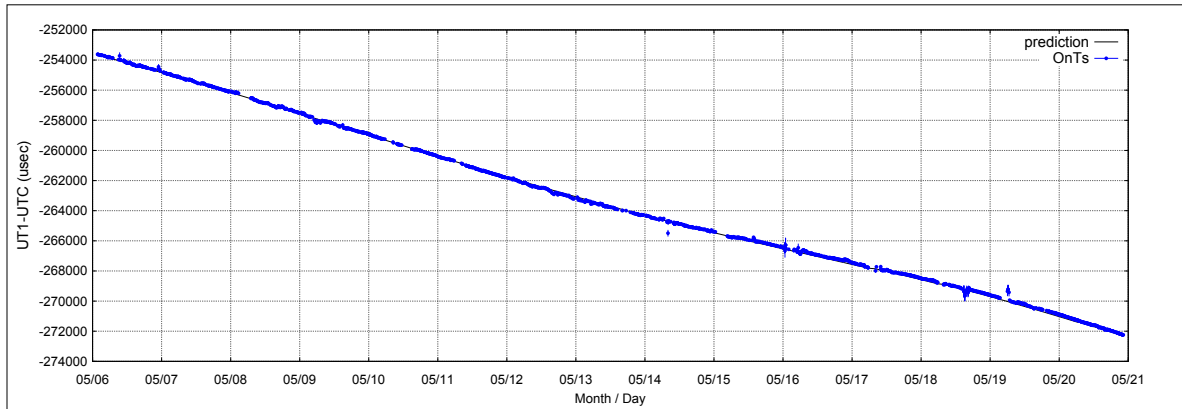

Fig. 3 The time series of UT1-UTC derived from the Onsala–Tsukuba baseline from IVS-CONT14 ultra-rapid processing with the prediction (Rapid Service/Prediction of Earth Orientation, finals2000A.daily).

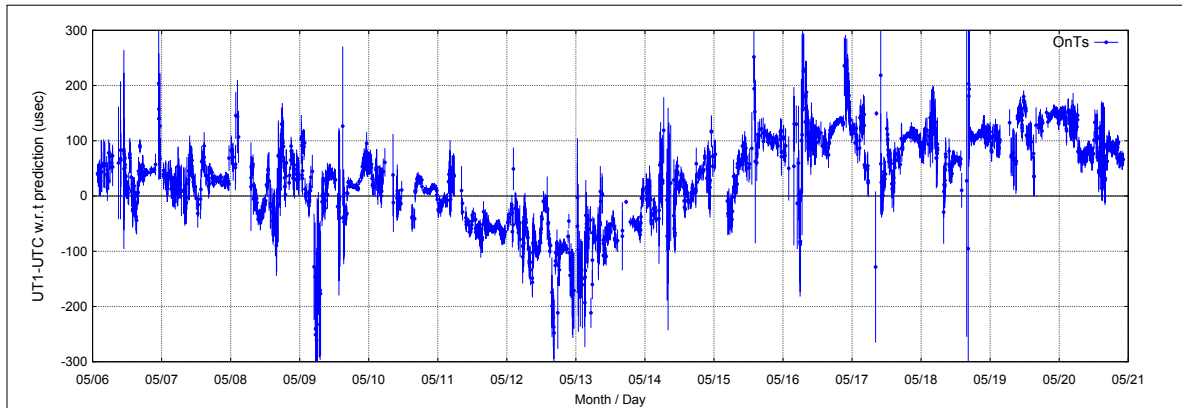

Fig. 4 Residuals of UT1-UTC with respect to the prediction (Rapid Service/Prediction of Earth Orientation, finals2000A.daily).

Table 3 The ultra-rapid experiments in 2014. All experiments were processed after the regular IVS sessions.

Exper.	Date	Time	Dur.	Stations	#obs.	
					(skd)	(cor)
R1624	Feb 10	17:00	24	HtOnTs	287	275
RD1402	Mar 26	18:00	24	HbHtOnTs	244	278
R1631	Mar 31	17:00	24	OnTs	201	201
R1632	Apr 07	17:00	24	OnTs	191	191
CONT14	May 06	00:00	360	OnTs	3262	3009
R1657	Oct 13	17:00	24	HbHtOnTs	328	86

Kenyon, M. C. Pacino, and U. Marti, doi: 10.1007/978-3-642-20338-1_126, 1007-1011, 2012.

References

- Hobiger, T., et al.: Fully automated VLBI analysis with c5++ for ultra-rapid determination of UT1, *Earth Planets Space*, **62**, 933-937, 2010.
- Böhm, J., et al.: The New Vienna VLBI Software VieVS, In Proceedings of IAG Scientific Assembly 2009, *International Association of Geodesy Symposia Series*, **136**, edited by S.

U.S. Naval Observatory VLBI Analysis Center

Alan Fey, Nicole Geiger, Christopher Dieck

Abstract This report summarizes the activities of the VLBI Analysis Center at the United States Naval Observatory for 2014. Over the course of the year, Analysis Center personnel continued analysis and timely submission of IVS-R4 databases for distribution to the IVS. During the 2014 calendar year, the USNO VLBI Analysis Center continued to use the VLBI global solution designated usn2014a. Earth orientation parameters (EOP) based on this solution and updated by the latest diurnal (IVS-R1 and IVS-R4) experiments, were routinely submitted to the IVS. Sinex format files based upon the bi-weekly 24-hour experiments were also submitted to the IVS. During the 2014 calendar year, Analysis Center personnel continued a program to use the Very Long Baseline Array (VLBA) operated by the NRAO for the purpose of measuring UT1–UTC. Routine daily one-hour duration Intensive observations continued using the VLBA antennas at Pie Town, NM and Mauna Kea, HI.

1 Introduction

The USNO VLBI Analysis Center is supported and operated by the United States Naval Observatory (USNO) in Washington, DC. The primary services provided by the Analysis Center are the analysis of diurnal experiments and the production of periodic VLBI global solutions for estimation of the Terrestrial

Reference Frame (TRF), the Celestial Reference Frame (CRF), and Earth Orientation Parameters (EOP). The Analysis Center continued the submission to the IVS of Intensive (EOP-I) and session-based (EOP-S) Earth orientation parameters based on USNO VLBI global solutions. Analysis Center personnel maintain the necessary software required to continue these services to the IVS including periodic updates of the GSFC CALC/SOLVE software package. In addition to operational VLBI analysis, Analysis Center personnel are actively engaged in research related to future reference frames, the electronic transfer of VLBI data, and software correlation.

2 Current Analysis Center Activities

2.1 IVS Experiment Analysis and Database Submission

During the 2014 calendar year, personnel at the USNO VLBI Analysis Center continued to be responsible for the timely analysis of the IVS-R4 experiments, with the resulting databases submitted within 24 hours of correlation for dissemination by the IVS. Analysis Center personnel continue to be responsible for the analysis and database submission for the periodic IVS-CRF experiments. Analysis Center personnel also continued analyzing IVS Intensive experiments for use in the USN-EOPI time series and continued a new series of Intensive sessions using the VLBA antennas at Pie Town, NM and Mauna Kea, HI.

U.S. Naval Observatory

USNO Analysis Center

IVS 2014 Annual Report

2.2 Global VLBI Solutions, EOP and Sinex Submission

USNO VLBI Analysis Center personnel continued to use the periodic global TRF/CRF/EOP solution usn2014a over the course of the 2014 calendar year. Analysis Center personnel continued to submit the USN-EOPS series, which is based upon the current global solution and updated with new IVS-R1/R4 experiments. The updated EOPS series is submitted to the IVS twice weekly within 24 hours of experiment correlation and is included in the IERS Bulletin A. Analysis Center personnel also continued routine submission of Sinex format files based upon the 24-hour VLBI sessions. In addition to EOPS and Sinex series, USNO VLBI Analysis Center personnel continued to produce and submit an EOPI series based upon the IVS Intensive experiments.

2.3 ITRF2014 Submission

The USNO VLBI Analysis Center generated and submitted Sinex format files based on its usn2014a global VLBI solution for use in the IVS combined VLBI solution that will be used for ITRF2014.

2.4 Software Correlator

Over the course of the 2014 calendar year, Analysis Center personnel continued the implementation, testing and evaluation of the DiFX software correlator. Phase I of the software correlator has two management nodes and 33 compute nodes (with each node having a 2.9 GHz dual-core processor with eight cores per processor for a total of 528 processing cores) and reached operational capability in October.

Hardware for Phase II of the software correlator was delivered in the second quarter of 2014 and will double the processing power of the Phase I correlator but has not yet been implemented. Post-correlation calibration and analysis of software correlated data is now routinely performed using the standard geodetic data reduction path including the use of the Haystack Observatory Post-processing System (HOPS) for data

calibration and the GSFC CALC/SOLVE package for data analysis.

2.5 VLBA Intensive Experiments

During the 2014 calendar year, Analysis Center personnel continued a program to use the Very Long Baseline Array (VLBA) operated by the NRAO for the purpose of measuring UT1–UTC. Routine daily 1-hour duration Intensive observations continued using the VLBA antennas at Pie Town, NM and Mauna Kea, HI. High-speed network connections to these two antennas are now routinely used for electronic transfer of VLBI data over the Internet to a USNO point of presence. Once fully operational, it is anticipated that these VLBA Intensive sessions will be scheduled as IVS-INT4 and that the data will be released to the IVS for community-wide distribution.

3 Staff

The staff of the VLBI Analysis Center is drawn from individuals in the Astrometry department at the U.S. Naval Observatory. The staff and their responsibilities are as follows:

Name	Responsibilities
Alan Fey	Periodic global CRF/TRF/EOP solutions and comparisons; CRF densification research; software correlator implementation; VLBI data analysis.
Nicole Geiger	software correlator implementation; VLBI data analysis; EOP, database, and Sinex submission.
Christopher Dieck	software correlator implementation; VLBI data analysis; EOP, database, and Sinex submission.

4 Future Activities

The following activities for 2015 are planned:

- Continue analysis and submission of IVS-R4 experiments for dissemination by the IVS.

- Transition to use of vSolve for interactive VLBI analysis.
- Continue the production of periodic global TRF/CRF/EOP solutions and the submission of EOP-S estimates to the IVS updated by the IVS-R1/R4 experiments.
- Continue submission of Sinex format files based on the 24-hour experiments.
- Continue the analysis of IVS Intensive experiments and submission of EOP-I estimates to the IVS.
- Continue the scheduling, analysis and database submission for IVS-CRF and IVS-CRDS experiments.
- Continue post-processing and analysis of VLBI Intensive data from the MK and PT VLBA stations.

USNO Analysis Center for Source Structure Report

Alan Fey, Ralph Gaume

Abstract This report summarizes the activities of the United States Naval Observatory Analysis Center for Source Structure for calendar year 2014 and the activities planned for the year 2015.

1 Analysis Center Operation

The Analysis Center for Source Structure is supported and operated by the United States Naval Observatory (USNO). The charter of the Analysis Center is to provide products directly related to the IVS determination of the “definition and maintenance of the celestial reference frame.” These include, primarily, radio frequency images of International Celestial Reference Frame (ICRF) sources, intrinsic structure models derived from the radio images, and an assessment of the astrometric quality of the ICRF sources based on their intrinsic structure.

The Web server for the Analysis Center is hosted by the USNO and can be accessed by pointing your browser to

http://rorf.usno.navy.mil/ivs_saac/

The primary service of the Analysis Center is the Radio Reference Frame Image Database (RRFID), a Web accessible database of radio frequency images of ICRF sources. The RRFID contains 7,279 Very Long Baseline Array (VLBA) images of 782 sources at radio frequencies of 2.3 GHz and 8.4 GHz. Additionally,

the RRFID contains 1,867 images of 285 sources at frequencies of 24 GHz and 43 GHz. The RRFID can be accessed from the Analysis Center Web page or directly at

<http://rorf.usno.navy.mil/rrfid.shtml>

The RRFID also contains 74 images of 69 Southern Hemisphere ICRF sources using the Australian Long Baseline Array (LBA) at a radio frequency of 8.4 GHz.

Images of ICRF sources can also be obtained from the Bordeaux VLBI Image Database (BVID) at

<http://www.obs.u-bordeaux1.fr/m2a/BVID/>

2 Current Activities

Our current activities are maintaining the Radio Reference Frame Image Database as a Web accessible database of radio frequency images of ICRF sources.

3 Staff

The staff of the Analysis Center is drawn from individuals who work at the USNO. The staff of the Analysis Center during 2014 consisted of Alan L. Fey and Ralph A. Gaume.

U.S. Naval Observatory

USNO Analysis Center for Source Structure

IVS 2014 Annual Report

4 Future Activities

The Analysis Center currently has a program of active research investigating the effects of intrinsic source structure on astrometric position determination. Results of this program are published in the scientific literature.

The following activities for 2015 are planned:

- Continue with the imaging and analysis of VLBA 2.3/8.4/24/43 GHz experiments.
- Maintain the Radio Reference Frame Image Database (RRFID) as a Web accessible database of radio frequency images of ICRF sources.
- Continue preparatory work for ICRF-3.

5 Relevant Publications

Publications of relevance to Analysis Center activities are:

- “The Second Realization of the International Celestial Reference Frame by Very Long Baseline Interferometry,” by Fey et. al. 2015, AJ, submitted.
- “Relativistic Jets in the Radio Reference Frame Image Database. II. Blazar Jet Accelerations from the First 10 Years of Data (1994-2003),” Piner, B. G., Pushkarev, A. B., Kovalev, Y. Y., Marvin, C. J., Arenson, J. G., Charlot, P., Fey, A. L., Collioud, A., and Voitsik, P. A. 2012, ApJ, 758, 84.
- “Characterization of long baseline calibrators at 2.3 GHz,” Hungwe, F., Ojha, R., Booth, R. S., Bietenholz, M. F., Collioud, A., Charlot, P., Boboltz, D., and Fey, A. L. 2011, MNRAS, 418, 2113.
- “The Position/Structure Stability of Four ICRF2 Sources,” Ed Fomalont, Kenneth Johnston, Alan Fey, Dave Boboltz, Tamoaki Oyama, and Mareki Honma, 2011, AJ, 141, 91.

Vienna Special Analysis Center Annual Report 2014

Johannes Böhm, Sigrid Böhm, Anastasia Girdiuk, Andreas Hellerschmied, Armin Hofmeister, Hana Krásná, Younghee Kwak, Daniel Landskron, Matthias Madzak, David Mayer, Caroline Schönberger

Abstract The main activities in 2014 of the VLBI group at the Department of Geodesy and Geoinformation of the Vienna University of Technology were related to the application and the further development of the Vienna VLBI Software (VieVS). For example, we scheduled VLBI observations of the AUSTRAL sessions as well as observations to satellites with radio telescopes. Furthermore, we contributed to the ITRF2014 by providing normal equations for more than 5,000 sessions, and we assessed the impact of various ways of troposphere delay modeling on geodetic parameters. The highlight from an organizational point of view was the fifth VieVS User Workshop in September 2014 in Vienna with the release of VieVS version 2.2.

1 General Information

The Department of Geodesy and Geoinformation (GEO) in the Faculty of Mathematics and Geoinformation of Technische Universität Wien (TU Wien) is divided into seven research groups. One of those, the research group Höhere Geodäsie (Advanced Geodesy) with about 15 members, is focusing on satellite geodesy, system Earth, and geodetic VLBI.

Vienna University of Technology

VIE Analysis Center

IVS 2014 Annual Report

2 Staff

Personnel at GEO associated with the IVS Special Analysis Center in Vienna (VIE) and their main research fields and activities are summarized in Table 1. The staff members are partly paid by TU Wien and partly they are funded by the Austrian Science Fund (FWF) within several projects.

3 Activities during the Past Year

3.1 Global Solutions and Reference Frames

Axis offset models have to be applied for VLBI telescopes if the pointing axes do not intersect. We estimated the axis offsets for VLBI antennas in a global adjustment of suitable IVS 24-hour sessions (1984.0 — 2014.0) with the Vienna VLBI Software (VieVS) (Krásná et al., 2015, [3]). In particular, we focused on the two radio telescopes of the Hartebeesthoek Radio Astronomy Observatory (HartRAO) in South Africa where a comparison with axis offset estimates from other geodetic techniques, such as GNSS and conventional local survey, was made. Furthermore, we assessed the influence of differences in the axis offsets on the estimated geodetic parameters, such as station coordinates or Earth orientation parameters.

VLBA Calibrator Survey (VCS) observing sessions with ten radio telescopes in North America were carried out with the primary goal of densifying the International Celestial Reference Frame. We investigated the impact of Earth orientation parameters



Fig. 1 Members of the Vienna VLBI group and participants at the 5th VieVS User Workshop in September 2014.

Table 1 Staff members ordered alphabetically.

Johannes Böhm	Reference frames, atmospheric effects
Sigrid Böhm (on maternity leave)	Earth orientation
Anastasia Girdiuk (since 12/2014)	Earth orientation
Andreas Hellerschmied	Satellite observations with radio telescopes, VieVS admin since 12/2014
Armin Hofmeister	Ray-traced delays in VLBI analysis
Hana Krásná (on maternity leave since 12/2014)	Global solutions, VieVS admin until 11/2014
Younghee Kwak (since 03/2014)	Hybrid GNSS-VLBI observations
Daniel Landskron (since 06/2014)	Troposphere delay models for VLBI
Matthias Madzak	GUIs and special files in VieVS, Earth rotation
David Mayer	Reference frames and scheduling, e.g. AUSTRAL sessions
Caroline Schönberger (since 12/2014)	Simulation of twin telescopes

on the estimated source positions. For that purpose we applied the combined IERS C04 08 series as well as Earth rotation parameters from GNSS observations alone and compared the source coordinates to those estimated in VLBI-only solutions.

We contributed more than 5,000 SINEX files to the IVS Combination Center at BKG (Frankfurt, Germany) for the International Terrestrial Reference Frame 2014 (ITRF2014).

3.2 Troposphere Delays

Within the project RADIATE VLBI, which is funded by the Austrian Science Fund (FWF), there is ongoing development and enhancement of our new ray-tracing program RADIATE (Hofmeister and Böhm, 2015, [2]). With the use of real meteorological data provided by the European Centre for Medium-Range Weather Fore-

casts (ECMWF) via numerical weather models with horizontal resolutions as high as 0.125° times 0.125° , our program RADIATE is able to determine slant path delays for VLBI observations. In 2014, after the successful validation of our first ray-traced delays from RADIATE against the delays from an international comparison campaign of ray-tracing software (Nafisi et al., 2012, [5]), we further enhanced our ray-tracing program. A major step in the past year was the application of the ray-traced delays in VLBI analysis and the validation of the results. For this task we used the CONT11 campaign and calculated our ray-traced slant delays. Using VieVS for the analysis, we investigated the impact of our ray-traced delays on the VLBI solution by assessing baseline length repeatabilities.

In terms of improving troposphere delay models, two aspects were considered in 2014: (1) an improvement of the coefficients of the Vienna Mapping Function 1 (VMF1) and (2) the development of a new horizontal gradient formula in order to better consider az-

imuthal asymmetries. The latter approach uses expansions of the gradient formula based on spherical harmonics in order to compensate for the impact on the delays which is caused by the non-spherical shape of the Earth's atmosphere, which is flatter at the poles and thicker at the equator.

3.3 Simulation of Twin Telescopes

The Vienna VLBI Software was used to schedule and simulate a global VLBI network following the example of the CONT11 campaign, with the existing ONSALA60 telescope or with a Twin Telescope in Onsala. Different scheduling approaches (e.g., source-based scheduling with two or four sources at a time, multidirectional or continuous mode) (Sun et al., 2014, [7]) were compared by evaluating the numbers of observations and scans as well as baseline length repeatabilities, station positions, Earth orientation parameters, atmospheric parameters, and clock estimates.

3.4 Scheduling VLBI Sessions

The VieVS scheduling module is used operationally to schedule sessions for the AuScope VLBI network. This is done in close cooperation with the University of Tasmania. The AuScope VLBI network consists of three almost identical small (12-m) antennas distributed over Australia. Other telescopes from New Zealand (12-m) and South Africa (15-m) contribute on a regular basis. For special experiments, the two big (26-m) telescopes in Australia and South Africa are used as well. In 2014 the number of sessions observed with the Australian telescopes increased tremendously with a continuous campaign over two weeks in September and 57 regular Australian sessions. The schedules are created on a relatively short notice, which allows us to adjust to the current conditions and apply changes fast. Furthermore, more features were built into the software to fit the specific needs, and the GUI was updated slightly for more user-friendliness.

3.5 VLBI Observations to Satellites

Observations of GNSS satellites with large VLBI radio antennas enable the realization of inter-technique ties and seem to be a promising approach to accomplish a vital interconnection between dynamical and kinematical reference frames (Plank et al., 2014 [6]). Although several satellite observation experiments have been carried out in recent years, this approach is still far away from being applied operationally. Limitations have already emerged at the observation planning level, because suitable scheduling software has not been available. On that account the current Vienna VLBI Software was upgraded by adding a module capable of creating satellite observation schedules (Hellerschmied et al., 2015 [1]). The generated VEX-formatted schedule files can be used directly to carry out satellite observations, where the satellites are tracked by repositioning the VLBI antennas stepwise to define celestial coordinates. The first successful observations to GLONASS satellites based on VieVS schedules were carried out in January 2014 on the baseline Onsala—Wetzell. The new VieVS satellite scheduling module provides a flexible tool to generate suitable schedule files for satellite observations, which is particularly important to promote further research and development in this specific field.

3.6 GPS-VLBI Hybrid Observation for Geodesy

We started project *GPS-VLBI Hybrid Observation for Geodesy (Hybrid GPS-VLBI)*, funded by the Austrian Science Fund (FWF), which combines GPS and VLBI at the observation level. In 2014, we developed and validated the delay model of GPS satellites according to the GPS-VLBI (GV) hybrid observation concept and implemented it in VieVS. As a test of VieVS for GPS delays, we set up a global GV hybrid network with several IVS CONT11 sites, which are stable and homogeneously distributed and moreover simultaneously acquire GPS data. GPS delays were created by differencing post-processed range measurements from a precise point positioning (PPP) GPS solution with the C5++ software because we currently do not have any real observation data. The data were successfully processed

in VieVS, and we found centimeter-level accuracy of the models (Kwak et al., 2015, [4]). Compared to GPS PPP solutions, the accuracy is still worse, which needs to be further investigated. In 2015, we will combine VLBI and GPS data, estimate common parameters at the sites, and assess the impact of the GV hybrid combination solution on the geodetic parameters.

3.7 Development of VieVS

We have set up and maintained a wiki for the Vienna VLBI Software. This wiki is accessible at <http://viewswiki.geo.tuwien.ac.at/> and contains a lot of useful information, not just for VieVS users. We organized the 5th VieVS User Workshop from 17 to 18 September 2014 in Vienna. Additionally, Hana Krásná held a VieVS training course at Hartebeesthoek Radio Astronomy Observatory (HartRAO), South Africa, from 15 to 17 April 2014.

4 Future Plans

In 2015, we will continue the development of VieVS, with special focus on satellite tracking, scheduling, and the estimation of terrestrial and celestial reference frames. We also plan to become an operational Analysis Center of the IVS. Moreover, we will organize the 6th VieVS User Workshop in September 2015.

Acknowledgements

We are very grateful to the Austrian Science Fund (FWF) for supporting our work by projects P23143 (Integrated VLBI), P25320 (RADIATE VLBI), P24813 (SPOT), M1592 (Hybrid GPS-VLBI), and I1479 (ASPIRE). We also acknowledge the German Research foundation (DFG) for funding project D-VLBI (SCHU 1103/4-1).

References

1. A. Hellerschmied, J. Böhm, A. Neidhardt, J. Kodet, R. Haas, L. Plank. Scheduling VLBI observations to satellites with VieVS. *Proceedings of the IAG Commission 1 Symposium 2014*, Kirchberg, Luxembourg, October 2014, submitted, 2015.
2. A. Hofmeister, J. Böhm. Ray-traced Delays in the Atmosphere for Geodetic VLBI. *IVS 2014 General Meeting Proceedings*, ed. by D. Behrend, K.D. Baver, and K. Armstrong, 2014.
3. H. Krásná, M. Nickola, J. Böhm. Axis offset estimation of VLBI telescopes. *IVS 2014 General Meeting Proceedings*, ed. by D. Behrend, K.D. Baver, and K. Armstrong, 2014.
4. Y. Kwak, J. Böhm, T. Hobiger, L. Plank. On the analysis of VLBI observations to GNSS satellites. *Proceedings of the IAG Commission 1 Symposium 2014*, Kirchberg, Luxembourg, October 2014, submitted, 2015.
5. V. Nafisi, L. Urquhart, M. Santos, F. Nievinski, J. Böhm, D. Wijaya, H. Schuh, A. Ardalan, T. Hobiger, R. Ichikawa, F. Zus, J. Wickert, P. Gegout. Comparison of Ray-Tracing Packages for Troposphere Delays. *IEEE Transactions on Geoscience and Remote Sensing*, Vol. 50, No. 2, pp. 469–481, 2012.
6. L. Plank, J. Böhm, H. Schuh. Precise station positions from VLBI observations to satellites: a simulation study. *Journal of Geodesy*, 88:659–673, 2014.
7. J. Sun, J. Böhm, T. Nilsson, H. Krásná, S. Böhm, H. Schuh. New VLBI2010 scheduling strategies and implications on the terrestrial reference frames. *Journal of Geodesy*, 88:449–461, 2014.

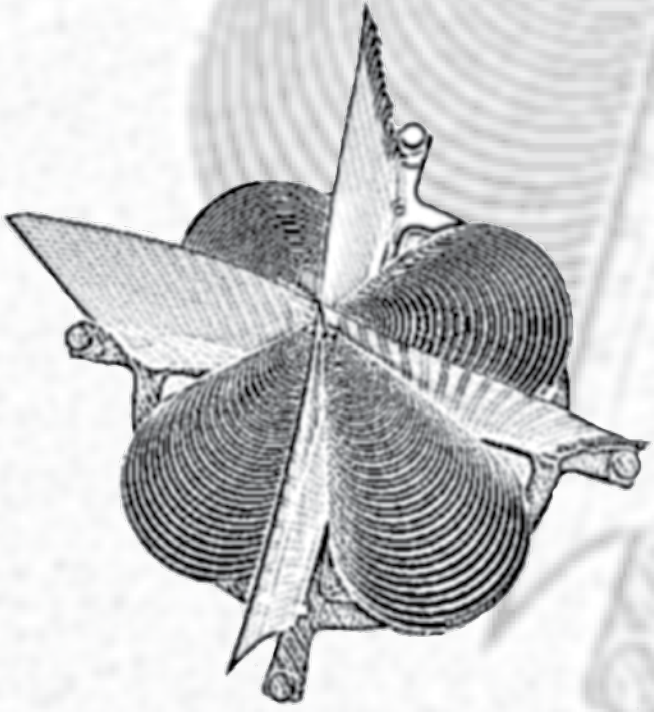

Technology Development Centers

Canadian VLBI Technology Development Center Report

Bill Petrachenko

Abstract The Canadian VLBI Technology Development Center (TDC) is involved in a number of activities contributing to the realization of the VLBI Global Observing System (VGOS).

1 General Information

The Canadian TDC is a collaborative effort of the National partners interested in the advancement of VLBI technology, namely the Canadian Geodetic Survey (CGS) of Natural Resources Canada (NRCan) and the Dominion Radio Astrophysical Observatory (DRAO) of the National Research Council of Canada (NRC).

2 Activities during the Past Year

The Canadian TDC is focused on encouraging the realization of VGOS. This is done by Bill Petrachenko of NRCan, who is the IVS Technology Development Coordinator, the chairman of the VGOS Technical Committee (VTC), and a member of the VGOS Project Executive Group (VPEG). In collaboration with others, this year's activities focused on the following areas:

- Completion and presentation of the VGOS Observing Plan.

- Compilation of comparisons of VGOS feeds, digital back ends (DBEs), and recorders.
- Collection of information regarding data acquisition equipment at VGOS sites. This is needed to help to determine compatible international VGOS observing modes.
- Study of more cost-effective broadband down-conversion schemes.
- Study of efficient and robust broadband frequency sequences.
- Development of FPGA code for VGOS digital back ends.

In addition, NRC is involved in a number of Square Kilometer Array (SKA) related activities that have potential applications to the IVS.

- Digital signal processing including development of correlators, beam formers, and systems for pulsar processing.
- Fabrication of a light, stiff, and cost effective 15-m off-axis Gregorian top-fed composite antenna.
- Development of focal plane arrays.

3 Future Plans

The Canadian TDC plans to continue to actively encourage the realization of VGOS.

Canadian Geodetic Survey, Natural Resources Canada

Canadian VLBI Technology Development Center

IVS 2014 Annual Report

GSFC Technology Development Center Report

Ed Himwich, John Gipson

Abstract This report summarizes the activities of the GSFC Technology Development Center (TDC) and describes plans for next year. The GSFC TDC develops station software including the Field System (FS), scheduling software (*sked*), hardware including tools for station timing and meteorology, scheduling algorithms, and operational procedures. It provides a pool of individuals to assist with station implementation, check-out, upgrades, and training.

1 Technology Center Activities

The GSFC IVS Technology Development Center (TDC) develops hardware, software, algorithms, and operational procedures. It provides manpower for station visits for training and upgrades. Other technology development areas at GSFC are covered by other IVS components such as the GSFC Analysis Center. The current staff of the GSFC TDC consists of John Gipson, Ed Himwich, and Rich Strand, all employed by NVI, Inc. The remainder of this report covers the status of the main areas supported by the TDC.

2 Field System

The GSFC TDC is responsible for development, maintenance, and documentation of the Field System (FS) software package. The FS provides equipment con-

trol at VLBI stations. It interprets the *.snp* schedule and *.prc* procedure files (both as prepared by *drudg* from the *.skd* schedule). The FS controls the antenna, data acquisition hardware, and related ancillary equipment needed for making VLBI measurements. All major VLBI data acquisition backends are supported. The FS is customizable to allow it to control station specific equipment. It is used at almost all of the IVS Network Stations (more than 35) and also at many stations that perform VLBI only for astronomical observations. The only major VLBI facilities not using it are the VLBA and VERA.

There were six minor releases of the FS (9.11.1-9.11.6) during this year. Full details can be found in the FS release notes, but most changes were fairly minor. The most significant changes were:

- The addition of the *bit_streams* command for specification of active channels for recording T_{sys} when no supported recorder is being controlled. This is typically used for e-VLBI.
- Support for DBBC version v104.
- Specification of the Mark 5B clock rate from a control file.
- A time-out feature for the ONSOURCE command to support local testing.
- Support for FSL9 kernel distribution, based on Debian *Wheezy*.
- Enhancements for support of *jive5ab* controlled Mark 5B recorders.

In addition several development projects were underway. These include:

- Patriot 12 m Interface. Development of the interface for the Patriot Antenna Control Unit (ACU) continued. Several improvements were

NASA Goddard Space Flight Center

GSFC Technology Development Center

IVS 2014 Annual Report

made, including the handling and the reporting of status-word-represented errors and improvements in cable-wrap handling to make it independent of the limits for any particular antenna.

- VEX2. Considerable effort has gone into defining the second version of VEX, which will provide schedule file format support for new “sampling-before-channelization” systems such as the RDBE.

2.1 Plans for Next Year

Several other improvements are expected in future releases, including:

- Support for parallel use of multiple RDBEG racks for VGOS observing modes.
- Support for parallel use of multiple Mark 6 recorders, using *cplane* for control, for VGOS observing modes.
- Support for single Mark 5C/Mark 6/Flexbuff recorders that are running the *jive5ab* control program.
- Support for DBBC PFB personality.
- Use of *idl2rpc* for remote operation.
- A complete update to the documentation and conversion to a more modern format that will be easier to use and maintain.
- Conversion of the FORTRAN source to use the *gfortran* compiler, which will enable use of the source level debugger, *gdb*, for development and field debugging.
- *Chekr* support for Mark 5A and Mark 5B systems.
- FS Linux 10, based on Debian *Jessie*.
- Support for periodic firing of the noise diode during observations.
- Support for NMEA standard wind sensors.
- Completion of the VEX2 standard and implementation of it.

3 *Sked* and *Drudg*

The GSFC TDC is responsible for the development, maintenance, and documentation of *sked* and *drudg*. These two programs are very closely related, and they operate as a pair for the preparation of the detailed ob-

serving schedule for a VLBI session and its proper execution in the field. In the normal data flow for geodesic schedules, first *sked* is run at the Operation Centers to generate the .skd file that contains the full network observing schedule. Then stations use the .skd file as input to *drudg* for making the control files and procedures for their station. Catalogs are used to define the equipment, stations, sources, and observing modes which are selected when writing a schedule with *sked*.

Changes to *sked* and *drudg* are driven by changes in equipment and by feedback from the users. The following summarizes some of the important changes to these programs this year and plans for next year.

3.1 *Sked* Changes

- The tagging along of a new station to a schedule without that station was improved. The issue is that internally *sked* uses one-letter codes as station identifiers, where the default one-letter codes come from the catalogs. There were problems if the new station had the same one-letter code as a station already in the schedule. *sked* was modified to use a new unused letter for the new station.
- *sked* was made more robust for observations near the cable wrap.
- *sked* previously used two different routines for calculating similar quantities, SNR and duration. This led to inconsistencies. Both pieces of code were modified to call a subroutine.
- *sked* was modified to write VEX files differently depending on whether the data was processed by the VLBA or by BONN. This reduced hand-editing of VEX files.
- Some cleanup was done in terms of removing tape-related parameters such as pass, footage, etc. This was necessitated because *sked* could not read in some VEX files that did not have this information. There is still a fair amount of vestigial code dealing with tapes, and this will be removed as time permits.
- The handling of the case in which *sked* does not recognize the rack or recorder was improved. Previously both the rack and recorder had to belong to a set list of valid types which was hard-coded. If this was not the case, *sked* would close with an error message. It will now continue running.

3.2 *Drudg* Changes

- Support for Mark 5C.
- Some cleanup was done in terms of removing tape-related parameters such as pass, footage, etc. This was done because *drudg* could not read in a VEX file that did not have pass information.
- Support for LSB first LOs. Previously this existed for Mark III '.skd' files, but not for VEX files.
- Support for new hardware at the VLBA.

3.3 *Plans for Next Year*

Plans for next year include the following:

- We will support VEX2 files for both *sked* and *drudg* if and when they become available.
- We plan to expand support for RDBEs and DBBCs. This will involve changes to *sked*, *drudg*, and the catalogs.
- If time permits we will convert *sked* to compile using a freely available compiler such as *gfortran*.

MIT Haystack Observatory Technology Development Center

Christopher Beaudoin, Roger Cappallo, Geoff Crew, Russ McWhirter, Arthur Niell, Chet Ruszczyk

Abstract Technology development at MIT Haystack Observatory was focused on the following three areas in 2014: (1) KPGO 12-m Signal Chain, (2) VLBI Data Acquisition Module, and (3) Mark 6. In this report, we outline the three main sub-systems comprising the KPGO signal chain and describe a new generic/open-source monitor and control module possessing a small, modular form factor. Lastly, we describe the latest refinements applied to the Mark 6 16 Gbps recorder software suite.

1 KPGO 12-m VGOS Signal Chain

MIT Haystack Observatory is responsible for the design, fabrication, and installation of the signal chain for the new KPGO 12-m VGOS system scheduled for installation at Kokee Park, HI, in September 2015. This signal chain is comprised of three separate sub-systems: (1.1) frontend, (1.2), backend, and (1.3) calibration.

1.1 Frontend Sub-system

The frontend subsystem contains the very sensitive low noise electronics and radio telescope feed necessary to achieve a system equivalent flux density of 2,500 Jy when integrated with the Intertronics Solutions Inc. 12-m antenna. The frontend also includes

MIT Haystack Observatory

Haystack Technology Development Center

IVS 2014 Annual Report

all supporting infrastructure (e.g. networking, power supply distribution, and monitor/control) necessary to operate the dual-linearly polarized cryogenic receiver frontend. Furthermore, a phase/noise calibration signal is injected directly into the frontend to provide a mechanism for instrumental delay/gain correction in post-correlation processing. Within the frontend, the power levels amplified are such that they are suitable to drive the high-band, microwave-over-fiber link that is used to downlink these signals to the backend sub-systems. To conserve dynamic range in the high-band link, the RFI afflicted S-band portion of the frontend frequency range is downlinked separately over a coaxial downlink which possesses significantly more dynamic range to support observing in this frequency band. A block diagram of the signal chain frontend sub-system is shown in Figure 1.

1.2 Backend Sub-system

The backend sub-system receives the microwave signals downlinked from the frontend sub-system for further processing. A block diagram of this backend sub-system is shown in Figure 2.

Both low and high band signals from the frontend subsystem can be distributed to four independently tunable 2–14 GHz UDCs. This UDC supports 2 GHz baseband output with fine LO tuning resolution (< 1 Hz) to accommodate compatibility with other VGOS frequency conversion schemes. These features are provided by the next generation UDC V2.0, which incorporates an additional downconversion stage not included in its predecessor. The fine tunability of this design is made possible by a custom LO that was de-

signed at Haystack and incorporates a finely tunable DDS. Figure 3 displays a layout of the custom LO circuitry.

In the KPGO implementation, 512 MHz Nyquist zone filters are incorporated in the UDCs to support the sample rate of the RDBE (1024 MHz). Following PFB processing by the RDBE, the digitized data are recorded onto hard disk by a single Mark 6 recorder capable of sustaining the 8 Gbps data rate onto a single disk module.

1.3 Calibration Sub-system

The calibration sub-system is physically split between the frontend (on the antenna) and backend (in the control room). This sub-system is responsible for generating phase and noise calibration signals in the frontend sub-system. In this frontend, these signals are injected into the receiver to facilitate correction of instrumental delay and gain variations in the radio source (e.g., quasar) signal path.

Accurate correction of the instrumental delay variations in this signal path is somewhat complicated by the need to uplink the timing reference (i.e., 5 MHz MASER reference) to the frontend. The complication arises because the delay in this timing reference is subject to variations that are independent of the variation in the quasar signal path downlink. A primary source of these variations is mechanical stress fluctuations imparted on the reference cable by the motion of the antenna. Hence, the calibration sub-system must monitor variations in this reference cable delay so that they may be removed from the phase variations extracted by the correlator.

The resultant instrumental phase estimate represents that imparted on the quasar signal as it propagates through the signal chain. A proof-of-concept cable delay measurement system has been developed and is currently being tested to address this requirement. The calibration signal generator (i.e., the antenna unit) is being redesigned to integrate this new capability. This effort is expected to be complete in the first quarter of 2015.

2 VLBI Data Acquisition Module

MIT Haystack Observatory has developed the VLBI Data Acquisition (VDAQ) module as an open source hardware development to address general purpose monitor and control requirements at the generic VLBI station. As a modular instrument, the VDAQ makes dual use of Ethernet infrastructure, using the Ethernet backbone to provide both communication and power interfaces into the module. This feature of the VDAQ serves to provide a small form factor (13x10x2.5 cm) and allows it to be deployed to space-limited locations where MCI is needed. Figure 4 presents a 3D CAD model rendering of the VDAQ module.

This modular concept also serves to minimize issues related to signal integrity because sensors and signal monitors can be placed in close proximity to the module which can also serve as a distributed power source. The following provides a breakdown of the interfaces that the VDAQ module will support:

- Digital Communications
 - RS232
 - I²C
 - SPI
 - Ethernet
- Isolated DC Power Sources
- 16 Analog Monitors
 - Single-ended or Differential
 - Isolated or Non-Isolated
 - Configurable signal conditioning
- 40 Digital Monitors or Controls
 - 10 Isolated Monitors
 - 10 Isolated Controls
 - 20 Non-isolated Monitors and/or Controls

3 Mark 6 Developments

In 2014, the software utility *vdifuse* was committed to the DiFX repository. *vdifuse* mounts the disk modules as local directories readable by the Mark 6 OS and performs the pointer mathematics necessary to navigate the scattered nature of the Mark 6 recording methodology. In this way, *vdifuse* allows the Mark 6 user to

interact with scans recorded on the Mark 6 disk module(s) as if they were contiguous files within the *vdifuse*-mounted directories. Using this utility, it is possible to copy entire (and partial) scans from the mounted disk modules to the OS (or external, e.g., USB) disk. It is also possible to read these virtual files using standard Linux commands such as *ls*, *more*, *head*, and *tail*. It is not possible to utilize *vdifuse* to perform write operations on these mounted directories (e.g., the Linux delete *rm* command).

Lastly, Mark 6 software v1.2d was developed to resolve an IRQ bug that was discovered through testing. This bug introduced a loss of data at 16 Gbps data rate due to a non-uniform distribution of record processing load across the available CPUs. This software release is available through the EHT wiki at the following address: <http://eht-wiki.haystack.mit.edu>. Login credentials are required to obtain the package and can be obtained by contacting the EHT wiki webmaster at the aforementioned Web link.

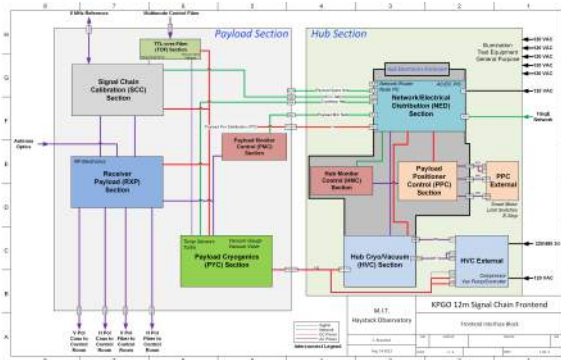

Fig. 1 Block diagram of the signal chain frontend sub-system. External connections into the frontend from the top/bottom represent those to the backend/calibration sub-systems. External connections into the frontend from the left/right represent those from the site’s general infrastructure (not provided by Haystack).

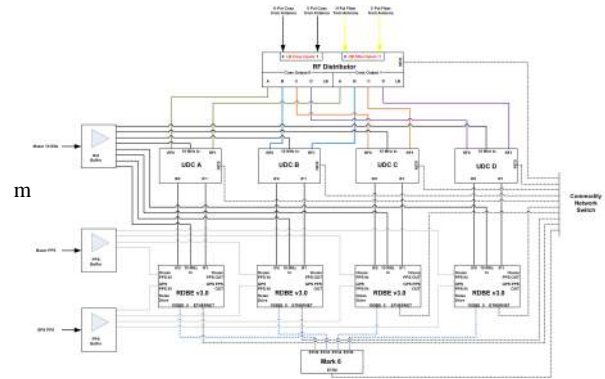

Fig. 2 Block diagram of the signal chain backend sub-system. External connections into the backend from the top represent those to the frontend sub-system. External connections into the frontend from the left/right represent those from the site’s general infrastructure (not provided by Haystack).

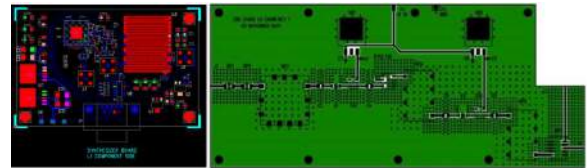

Fig. 3 PCB layouts of electronics designed for custom LO circuitry in UDC third downconversion stage.

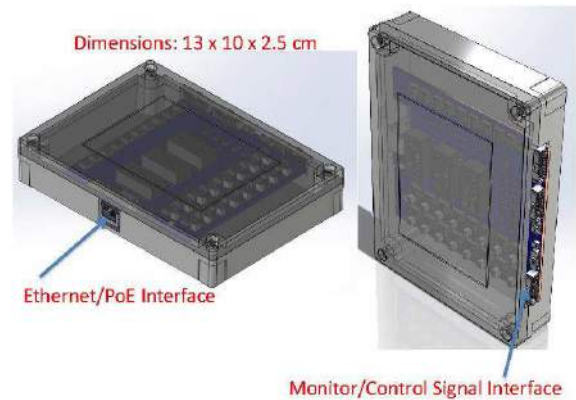

Fig. 4 3D CAD model rendering of the VDAQ module identifying its physical interfaces.

IAA Technology Development Center Report 2014

Alexander Ipatov, Irina Ipatova, Vyacheslav Mardyshkin, Alexander Evstigneev, Evgeniy Khvostov, Alexey Lavrov, Vitaliy Chernov, Dmitry Marshalov, Evgeny Nosov, Leonid Fedotov

Abstract This report discusses the aspects of the IAA RAS Technology Development Center in 2014.

1 Tri-band Receiving System for the Interferometer

The interferometer receiving system [1] is applied at the IAA RAS stations “Zelenchukskaya” and “Badary”. It operates in S-band (2.2-2.6 GHz), X-band (7.0-9.5 GHz) and Ka-band (28-34 GHz) with a multiband feed. The design of the feed gives the possibility for cooling and operating with dual circular polarization simultaneously. All receiver units are placed in the focal container (Figure 1) which is mounted at the secondary focus of the antenna. The container is specially designed for the 13.2-m dish and provides rigid airtight housing. The design of the focal container makes cool air circulation available inside.

The multiband feed and low noise amplifiers are placed in a special cryostated container (cryostat) (Figure 2) and are cooled by a cryogenic system of closed cycle to a temperature at the level of hydrogen. All the equipment of the cryostat for both polarizations of all three bands is tightly placed in the space between the feed and coldhead flange. The S- and X-band signal lines are coaxial, and Ka-band is fully waveguide. The equipment is screened with the metal heat shield. The infrared filter is placed between the feed and the vacuum window. It is made of 0.1 mm teflon film. Cooling

Institute of Applied Astronomy of Russian Academy of Sciences

IAA RAS Technology Development Center

IVS 2014 Annual Report



Fig. 1 Tri-band receiver focal container (without housing).

with the use of a Sumitomo closed cycle refrigerator takes seven hours. The measured feed physical temperature is about 26 K, and the temperature of the amplifiers is about 20 K.

The external vacuum window is closed with radio transparent covering, which consists of two parts. The external sealing surface is made of Mylar film 0.05 mm thick. The film is supported by the inner layer of solid foam polyester with 17 mm thick. The covering is blown with warm air through a special nozzle to protect from atmospheric precipitation.

It is then focused with antenna electromagnetic waves that get to the feed inside the cooled unit through



Fig. 2 Cryostat assembly: equipment, container with vacuum window, thermal screen.

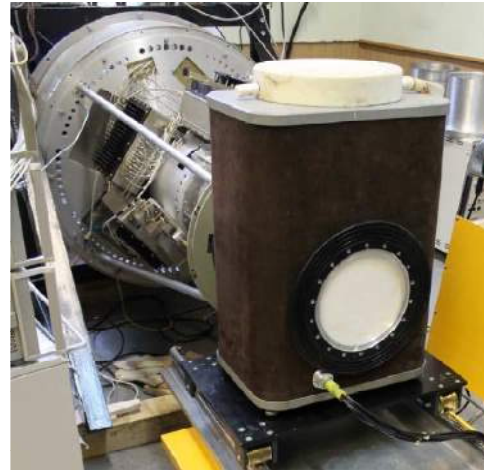

Fig. 3 Laboratory receiver calibration with load.

the radio-transparent cover. They are separated to three bands and two circular polarizations, mixed with the noise and phase calibration signals, and amplified with cooled LNAs. Almost all of the equipment located inside the cryostat is cooled to a temperature near 20 K, significantly reducing noise temperature of the “radio telescope-radiometer” system.

Amplified signals are directed to the intermediate frequency converter units. These units provide sub channel splitting and frequency conversion to the IF band of the digital acquisition system. Sub channels to record are selected by the commutator unit. The calibration unit contains an adjustable noise source for each band. External picoseconds pulses for the phase calibration are used, and the calibration unit has a special input for them.

For measuring the noise temperature of the cooled unit, special broadband-matched loads were applied. These wide-aperture loads are enclosed in a Dewar and can be filled with liquid nitrogen, providing “cold” reference points (“hot” points can be achieved with an empty Dewar). There are loads for lab tests (Figure 3) and loads for telescope measurements (Figure 4).

The first results of the total noise temperature measurements for the stand-alone receiving system and the complete radio telescope are the following. X-band has the best results — 15 K for the receiver, 25 for the radio telescope. Ka-band with improved LNAs has the noise temperature 50 K and 75 K accordingly; this is 40% lower than the results with the first samples of LNAs.



Fig. 4 Telescope receiver calibration with load.

The measurements of noise temperature in the S-band are obstructed by the RFI even in a far location. The approximate result is 20 K and 35 K. The difference between left and right circular polarization channels is insignificant.

2 Putting BRAS into Operation

The eight-channel digital Broadband Acquisition System (BRAS) was developed and manufactured by IAA RAS [2, 3]. Key features of BRAS are summarized in Table 1.

On September 4, 2014 the first test observations (Ru-TEST 108) with BRAS were carried out on radio telescopes RT-32 at the “Badary” and “Zelenchukskaya” observatories. BRAS was connected to the X-band receiver outputs at both stations. Mark 5C was

Table 1 Key features of BRAS.

Number of channels	8
IF inputs	1024 - 1536 MHz
Channel bandwidth	512 MHz
ADC	8 bits, $F_s=1024$ MHz
Output samples width	2/8 bits
Total data rate	16/64 Gbps
Data frames format	VDIF
VDIF payload size	1000, 1024, 1280, 1600, 2000, , 8000, 8192 bytes
Output interface	10G Ethernet, X2 transceiver, fiber/copper
Output headers modes	Pure Ethernet frame, Ethernet+IP, Ethernet+IP+UDP
Control interface	10/100 Ethernet
Sync signals	5/10/100 MHz, 1 PPSx2
Automatic gain control	For each channel, 31 dB
Analysis features	Signal power, 2-bit data statistics, PCAL extraction, Both 8 and 2-bit signal capture (1024 samples), Spectrum analysis of captured signal and extracted PCAL (implemented in software), 1 PPS int.-ext. delay monitoring
Telemetry	Power circuit current, temperature of PCBs and ADC
Power consumption	75 W
Size	19" case 483x314x242 mm (WxHxD)

used as the recording system. The recording was carried out in a single 512 MHz frequency band located from 8592.00 to 9104.00 MHz. All scans were transferred through the network to St. Petersburg and processed in the IAA correlator [4]. In this session, the 24 sources from the RFC 2012c catalog with a flux density from 0.6 Jy to 7.6 Jy were observed. Good fringes were received for each of the observed sources. The fringe quality is good enough for high-precision group delay measurement (see Figure 5).

The first BRAS sample was mounted on the 13-m radio telescope (RT-13) at the “Badary” observatory (see Figure 6). We are going to put BRAS into operation at the RT-13 “Badary” and “Zelenchukskaya” observatories in 2015.

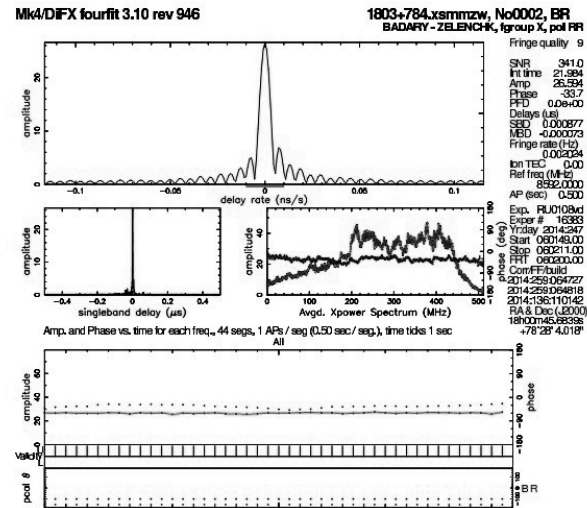
**Fig. 5** Fringe plot for scan of 1803+784 source, X-band, BRAS, and Mark 5C.**Fig. 6** The BRAS on the RT-13 radio telescope at the Badary observatory.

3 Multipurpose Digital Backend (MDBE)

The development of BRAS gave the required experience to design a more complex and advanced backend - Multipurpose Digital Backend (MDBE). MDBE is intended to upgrade the backends of “Quasar” network antennas and allow it to operate both in conventional downconverter mode for compatibility with existing data acquisition systems and in broadband channel mode. The MDBE has two 4-channels ADC with 1024 MHz sampling frequency giving overall eight channels

with 512 MHz bandwidth (Figure 7). By using ADC interleaving mode, the MDBE can combine adjacent channels and operate in 4-channel mode with 1024 MHz bandwidth per channel. The powerful FPGA with an embedded dual-core ARM processor used in the MDBE can perform quite complex digital signal processing. Along with remote firmware reloading supported by MDBE, it allows utilization of the device for many radio astronomical tasks besides conventional VLBI applications. For example, the spectrometer and radiometric backend modes are planned to be implemented. That is, the MDBE can combine all required backends in one device which can greatly simplify signal chain structure (Figure 8). The MDBE will be located in the focal cabin of the antenna which allows elimination of long coaxial cables and auxiliary equipment used for signal transmission from antenna to control room and replacement with fiber optics. Digital signals transmitted through fibers are insensitive to EMI, frequency response distortions, group delay variations, and so on. Using it can improve the quality of VLBA data.

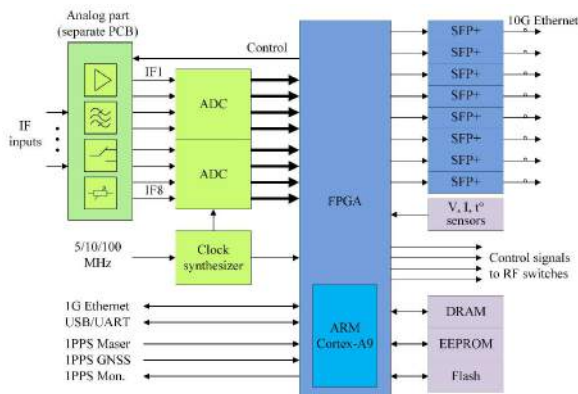

Fig. 7 Multipurpose Digital Backend structure.

The data recording system based on the COTS components will be used to buffer the data [5]. It is also possible to copy data from the data recording system to Mark 5B in the case that the e-VLBI mode is unavailable. MDBE is designed to be functionally compatible with existing VLBI equipment to support operations in international observations.

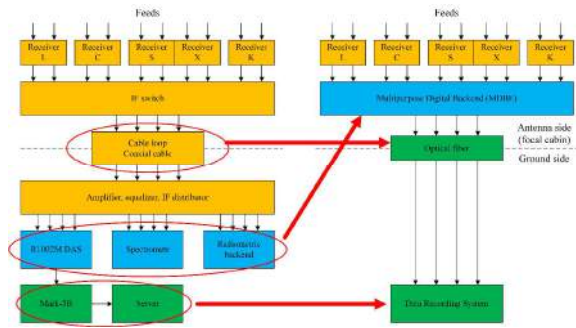

Fig. 8 Planned upgrade of signal chain for RT-32 antennas.

References

1. A. Ipatov, I. Ipatova, V. Mardyshev, A. Evstigneev, E. Khvostov, A. Lavrov, V. Chernov. Tri-band System for the Russian Interferometer, IVS 2014 General Meeting Proceedings, Science Press, Beijing, China, 2014, pp. 118-121.
2. D. Marshalov, E. Nosov, L. Fedotov. IAA Technology Development Center Report 2012. IVS 2012 Annual report. pp. 339 - 341. NASA/TP-2013-217511.
3. E. Nosov, A. Berdnikov, S. Grenkov, D. Marshalov, A. Melnikov, L. Fedotov. Current Development State of the Russian VLBI Broadband Acquisition System. IVS 2014 General Meeting Proceedings, Science Press, Beijing, China, 2014, pp. 82 - 85.
4. V. Ken, V. Mishin, D. Pavlov, N. Sokolova, I. Surkis. Design of a VGOS Software Correlator Based on GPUs. IVS 2014 General Meeting Proceedings, Science Press, Beijing, China, 2014, pp. 183 - 187.
5. I. Bezrukov, A. Salnikov, A. Vylegzhanin. Russian Data Recording System of New Generation. IVS 2014 General Meeting Proceedings, Science Press, Beijing, China, 2014, pp. 130 - 133.

NICT Technology Development Center 2014 Annual Report

Kazuhiro Takefuji, Hideki Ujihara

Abstract The National Institute of Information and Communications Technology (NICT) is developing and testing VLBI technologies and conducting observations with this new equipment. This report gives an overview of the Technology Development Center (TDC) at NICT and summarizes recent activities.

Table 1 Staff Members of NICT TDC as of January, 2015 (in alphabetical order).

Shingo Hasegawa	Eiji Kawai
Tetsuro Kondo	Yasuhiro Koyama
Yuka Miyauchi	Mamoru Sekido
Kazuhiro Takefuji	Hiroshi Takiguchi
Masanori Tsutsumi	Hideki Ujihara

1 NICT as IVS-TDC and Staff Members

The National Institute of Information and Communications Technology (NICT) publishes the newsletter “IVS NICT-TDC News (former IVS CRL-TDC News)” at least once a year in order to inform people about the development of VLBI-related technology as an IVS Technology Development Center. The newsletter is available at the following URL: <http://www2.nict.go.jp/aeri/sts/stmg/ivstdc/news-index.html>. Table 1 lists the staff members at NICT who are contributing to the Technology Development Center.

2 General Information

We have been developing a new broadband VLBI system called Gala-V, which not only meets the VGOS (VLBI2010 Global Observing System) requirements, but also includes upgrading the Cassegrain 34-m an-

tenna by replacing the feed horn. Distinguishing the features of Gala-V, we applied a direct sampler called the K6/OCTAD-G (code name Galas) and a broadband feed horn called Iguana. Here we report the current progress and activities.

First, the compact antenna (MARBLE1) was moved from GSI in Tsukuba to the National Metrology Institute of Japan (NMIJ) also in Tsukuba for the purpose of time and frequency (T&F) comparison between NICT and NMIJ. Both NICT and NMIJ keep the national time standard UTC(NICT) and UTC(NMIJ). Before the time and frequency comparison, the position of MARBLE1 was determined by geodetic VLBI sessions in X-band. Moreover we made a fringe test by broadband frequencies. Next, we made a VLBI experiment for broadband with the recently inaugurated GSI Ishioka 13-meter antenna in December 2014. We could successfully detect fringes in a 10 GHz and 13 GHz frequency range with 1024 MHz of bandwidth. It was also the memorial first fringe for the Ishioka station.

Kashima Space Technology Center, National Institute of Information and Communications Technology

NICT Technology Development Center

IVS 2014 Annual Report

3 Time Comparison between NICT and NMIJ by Compact Antennas

For the sake of the time and frequency transfer (T&F), we moved the MARBLE1 compact antenna to NMIJ in Tsukuba (Figure 1 shows MARBLE1 on the roof of NMIJ). Before the T&F, we carried out several VLBI sessions for determining the position of MARBLE1. Each backend of the compact antenna is a direct sampling system with no analog down-converters. Normally, 1024 MHz bandwidth of X-band single channel is recorded. Because we cannot obtain any fringes between MARBLE1 in Tsukuba and MARBLE2 at the NICT headquarters in Tokyo, a time difference between UTC(NICT) and UTC(NMIJ) is measured by calculating an epoch difference (baseline AB) between MARBLE1-Kashima34m (baseline AO) and MARBLE2-Kashima34m (baseline OB) via the large 34-m antenna. We take the Earth's rotation into account with epoch conversion, and the epoch difference is obtained by the following equation,

$$\tau_{AB} = \tau_{OB} - \tau_{OA} - \dot{\tau}_{AB} \times \tau_{OA} \quad (1)$$

where τ shows a delay and its subscript variable shows a station. Figure 2 shows a recent time comparison result including VLBI and GPS and UTC(NICT)—UTC(NMIJ) provided by BIPM on 1 and 3 August 2014. GPS has a day boundary caused by an uncertain satellite orbit, but VLBI had no day boundary and was also consistent with GPS and BIPM results.

4 Broadband Fringe Test between Gala-V of Kashima 34 m and MARBLE1

In the latest NICT TDC IVS annual report, we reported the simultaneously received 6.7 GHz and 12.2 GHz methanol maser lines with the Gala-V system [1]. We carried out a VLBI experiment of double maser lines. Each frequency down-converter was made for Gala-V for the purpose of the methanol maser lines. On the other hand, we set a DBBC frequency of the direct sampler (nickname Galas) for MARBLE1. Figure 3 shows the fringes in the frequency domain of the 6.7 GHz and 12.2 GHz methanol maser lines from the star-forming region of W3OH. The 12.2 GHz fringe of methanol maser was lighter than the 6.7 GHz one.



Fig. 1 The MARBLE1 compact station on the roof of the NMIJ building in Tsukuba.

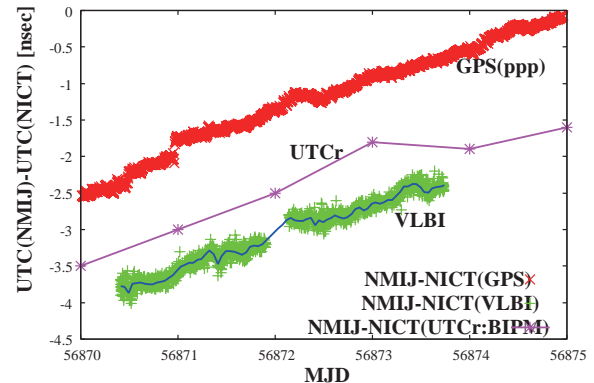

Fig. 2 A time comparison result between NICT and NMIJ. Plots include VLBI, GPS, and time difference provided by BIPM.

But we could identify the methanol line by checking the frequency. Kashima 34 m joined in cooperative observations of the Japanese VLBI network (JVN) for the methanol C-band session in October 2014. Because other JVN stations receive circular polarization, our linear polarization will make low SNR fringes. To make better fringes, we will install a linear-to-circular polarization converter.

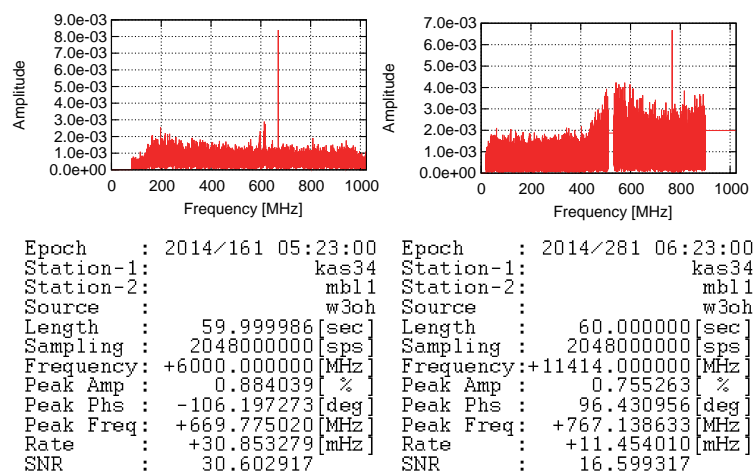

Fig. 3 Fringes of the 6.7 GHz and 12.2 GHz methanol maser lines from W3OH between the Gala-V system of Kashima 34 m and MARBLE1.

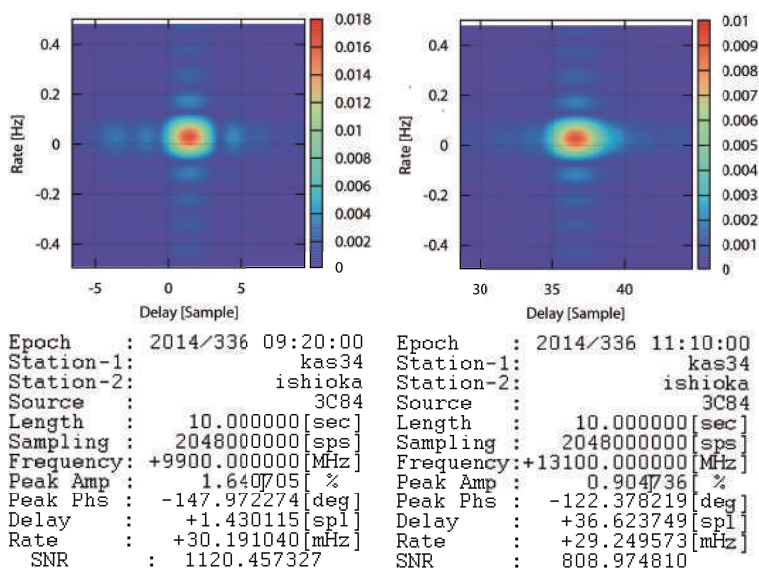

Fig. 4 First fringes between the Kashima 34-m and Ishioka 13-m antennas.

5 Broadband Fringe Test with a VGOS-type Ishioka 13 Meter

We made a VLBI observation for broadband with the recently inaugurated GSI Ishioka 13-meter antenna in December 2014. Ishioka is northwest of Kashima (about 60 km). A Field System and back-ends, including down-converters, digital samplers, and VSI-recorders were moved from Kashima and installed in Ishioka. We then carried out the broadband session in the 10 GHz and 13 GHz frequency ranges. A frontend cartridge of Ishioka consisted of an Eleven-feed system assembled by Omnisys. The cartridge can be replaced by other feed systems such as the Tri-band feed and the Quad-ridge flared feed horn (QRFH). Each frequency had a 1024 MHz bandwidth by 2048 MHz sampling speed and 1-bit quantization. Unfortunately, there was no Internet connection in Ishioka, and we had to send VLBI data classically, by car. Figure 4 shows the fringe map. They were memorial fringes for Ishioka. We will expand the bandwidth of the Gala-V system at Kashima 34 m from 3.2 GHz to 18 GHz, so that much wider VLBI observations are planned for next summer or autumn.

6 New Wideband Feed (NINJA)

Two types of the wideband feed NINJA have been undergoing development for the 34 m and MARBLE in the 3.2-14.4 GHz frequency range for Gala-V. First, the parabolic focus feed was initially designed for MARBLE which has a -10dB beam width of 50-60 degrees opposite of the parabolic mirror. But for getting a better SNR, we decided to replace the main mirror of the MARBLE from 1.6 m to 2.4 m, from prime focus to Cassegrain focus. The NINJA feed was also redesigned for a sharper 20-30 degree beam width. Figure 5 shows the initial version of the NINJA feed under the far field measurement of the Kyoto University METLAB. Next, the Iguana daughter feed #2 that was deployed in 2014 will be left at the 34 m. The NINJA feed, which is newly developed for the 34 m, will be installed beside the Iguana in this spring. Figure 6 shows the NINJA feed and Iguana prototype #1. The near side feed shows prototype, which is currently used for initial checking

such as aperture efficiency in early 2014. The far side feed will be for the 34 m without a beam-shaping lens.

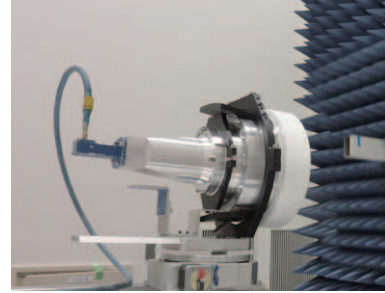

Fig. 5 Initially designed wideband NINJA feed equipped beam-shaping lens.



Fig. 6 The NINJA feeds displayed at the Micro Wave Exhibition 2014 in Yokohama, Japan.

7 Future Plans

The Kashima 34-m antenna is being upgraded for wider bandwidth such as 3.2-18 GHz. The NINJA feed will be installed in Spring 2015. We also have a plan to install cryogenic receivers hopefully during the next fiscal year.

References

1. Kazuhiro Takefuji, Hideki Ujihara, NICT Technology Development Center 2013 Annual Report, in International VLBI Service for Geodesy and Astrometry 2013 Annual Report, edited by K. D. Baver, D. Behrend, and K. L. Armstrong, NASA/TP-2014-217522, 2014.

Onsala Space Observatory – IVS Technology Development Center Activities during 2014

Miroslav Pantaleev¹, Rüdiger Haas¹, Bhushan Billade¹, Leif Helldner¹, Karl-Åke Johansson¹, Lars Petterson¹, Christophe Granet², Mark Bowen³, Alex Dunnin³

Abstract We give a brief overview on the technical development related to geodetic VLBI done during 2014 at the Onsala Space Observatory.

1 Activities during 2014

Our activities in technical development for VLBI concentrated on the following topics:

- The Onsala Twin Telescope project
- Broadband feeds for VLBI2010
- A new 4.00–12.25 GHz front-end for the 20-m radio telescope
- FlexBuff and FILA40G

2 The Onsala Twin Telescope Project

The procurement of the telescopes for the Onsala Twin Telescope project was started in June. Several tenders were received. After a thorough study of the submitted tenders, a contract was signed in December to buy two 13.2-m VGOS telescopes from MT Mechatronics. In parallel to the procurement, preparations for the infrastructure work started. Figure 1 depicts the planned location of the northern telescope. Both telescope locations consist of bed rock and at the same height within a few centimeters. The distance between the telescopes

is 75 m. The surrounding area around the northern location has been partially filled with blasted rockshot rock, and the construction of a small road to connect the two locations has been started.



Fig. 1 Aerial view of the planned location for the northern telescope of the Onsala Twin Telescope project. The southern telescope location is just outside the photo to the right.

3 Broadband Feeds for VLBI2010

We continued our collaboration with the Gothenburg-based company Omnisys Instruments and provided support for the cryogenic and mechanical design of a cryostat for the integration of the Eleven feed, and further issues related to system integration. We also supported receiver Y-factor tests which were performed at the observatory during July 2014. Results are shown in Figure 2. The three lines represent three successive measurements of the receiver temperature, performed with ten-minute intervals in order to study the system stability.

1. Chalmers University of Technology, Department of Earth and Space Sciences, Onsala Space Observatory

2. BAE Systems Australia

3. CSIRO Astronomy and Space Science

OSO Technology Development Center

IVS 2014 Annual Report

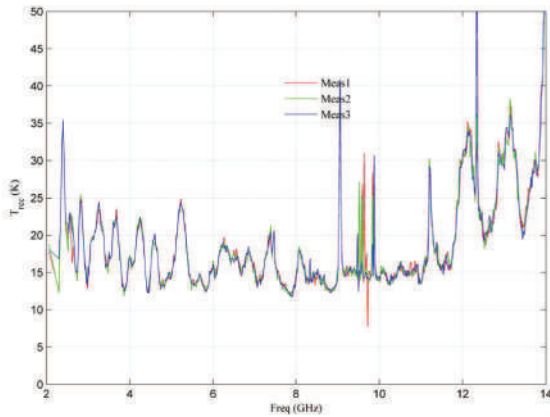

Fig. 2 On-sky tests of the VLBI2010 receiver developed by Omnisys in collaboration with the Onsala Space Observatory.

4 A New 4.00–12.25 GHz Front-end for the 20-m Radio Telescope

We started the design work for a 4.00–12.25 GHz cryogenic receiver for the 20-m telescope. The IVS observations at the 20-m antenna are currently conducted with a dual S/X system. The S-band (see Figure 3) uses an offset horn and a tertiary reflector that has a small dichroic window through which the X-band signal is collected by the current X-band horn.

One of the issues of the current S/X system is that it is located off-axis, with the center of the aperture of the current X-band horn being located at the position $x = 379$ mm and $y = 240$ mm. Furthermore, the design of both feeds is narrow band and does not allow extension of the S-band bandwidth beyond 250 MHz.

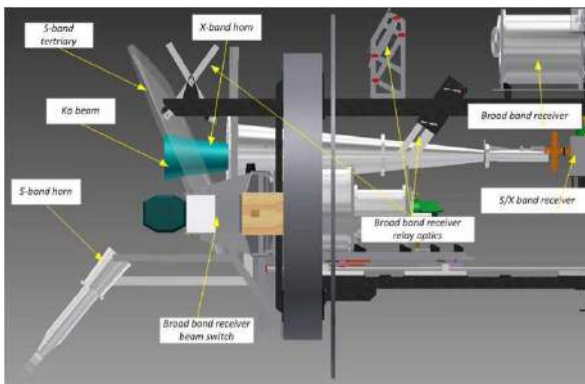

Fig. 3 The current S/X feed system on the 20-m radio telescope.

The interest for a wider bandwidth from both the IVS and the EVN communities initiated a survey study to localize a suitable design of components and suppliers that will allow extending the bandwidth for continuous coverage from C- to Ku-band. The survey study concluded that, because the geometry of the 20-m telescope is designed for mm-wave optics, it will be very challenging to find a commercial feed horn. The sub-reflector of the antenna has a half-subtended angle of only 6.09° and to achieve an edge taper of -12 dB at 6.09° , a horn with very high gain must be designed. After some investigation, we made an agreement with BAE Systems to make a feasibility study for the design of such a horn covering the 4.00–12.25 GHz band.

The next critical component in the receiver chain is the Ortho Mode Transducer. The design made by CSIRO Astronomy and Space Science (CASS) for the Australia Telescope Compact Array (ATCA) 22-m telescope was found to be very suitable for our application. In order to provide input to BAE for the mechanical layout and position of the feed we made a preliminary mechanical design of the receiver and the location of the feed-receiver system in the cabin.

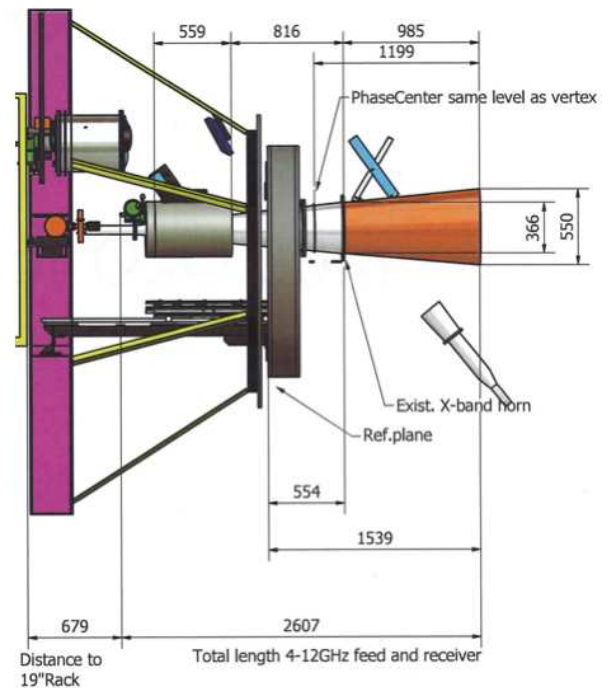

Fig. 4 The proposed mechanical arrangement of the 4.00–12.25 GHz horn for the 20-m telescope.

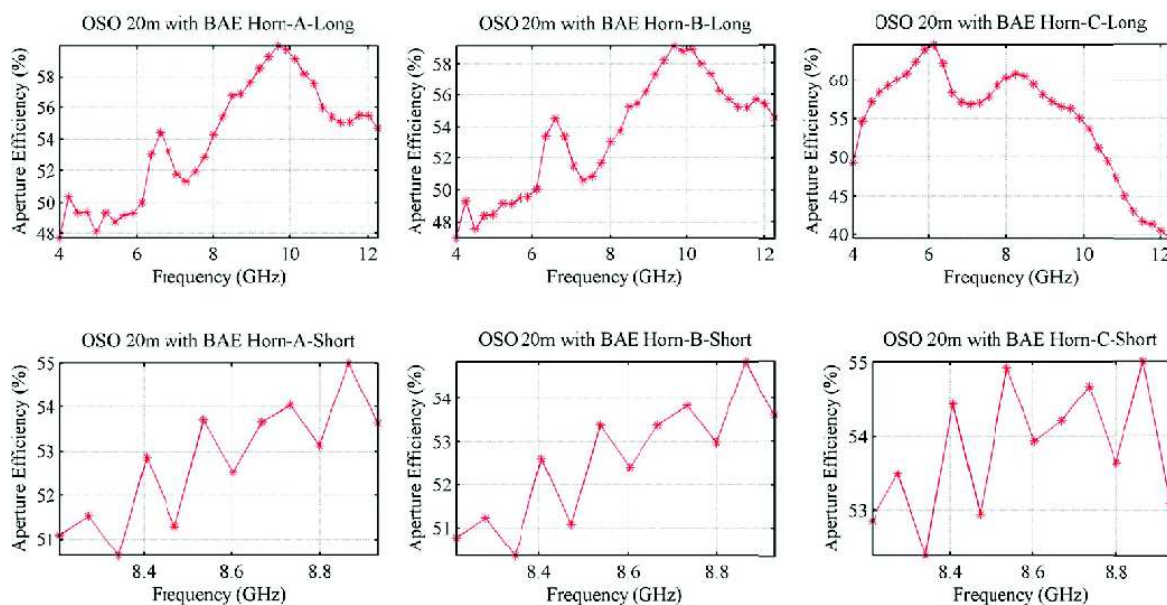

Fig. 5 Theoretical aperture efficiency with the “long” geometries (top) and the “short” geometries (bottom) of Horn-A, Horn-B, and Horn-C (left, middle, and right, respectively).

One of the constraints in the design was to provide a legacy mode for IVS observations in S- and X-band and also provide the primary operation in the wide-band 4.00–12.25 GHz. Therefore, the horn will be designed in sections, with at least one mechanical flange at a position of 816 mm from the input of the horn and a diameter of no more than 366 mm (see Figure 4), thus the existing tertiary with the dichroic window can then be used for S/X observations. This feed geometry is referred to as the “short” feed. The overall length of the complete 4.00–12.25 GHz horn will be set to be 1800 mm with an aperture diameter target of around 550 mm. This geometry is referred to as the “long” feed. This modular design with two sections will allow both operation modes, i.e., legacy S/X and wide-band 4.00–12.25 GHz, however not simultaneously.

During the feasibility study done by BAE, a number of different optimization runs were performed with various degrees of weighting for the different parameters and optimization goals. The following results report on the performance of three distinct horn geometries, all with the same input diameter and length, but with different profiles and performance. The three optimized horns are labelled Horn-A, Horn-B, and Horn-C and can be used in either their “long geometries” or “short geometries”. The Horn-A and Horn-B geometries were optimized to try to have even performance

over the whole 4.00–12.25 GHz band while the Horn-C geometry was optimized to improve the performance over the restricted 4.3–7.5 GHz to the detriment of the upper band (7.50–12.25 GHz).

The theoretical aperture efficiency of the antenna, with the various feeds on axis and at the correct position with respect to their phase-center positions, are presented in Figure 5. This feasibility study shows that the project can be carried out successfully.

5 FlexBuff and FILA40G

The FILA40G has been designed at Onsala Space Observatory within the FP7 RadioNet3 DIVA work package, as a unit to receive 4 x 8 Gb/s UDP (User Datagram Protocol) streams and then perform any needed processing on these streams, before ultimately writing the data out to sets of disks, retransmitting via a 40 Gigabit Ethernet (GbE) interface, or a combination of the two. It is intended to be connected to a DBBC3 [1] to allow the transmission and/or recording of the sampled data, but it is generic enough to allow for connection to other sampling equipment so long as they can provide data via Ethernet links. The current FILA40G software is based on a modified ver-

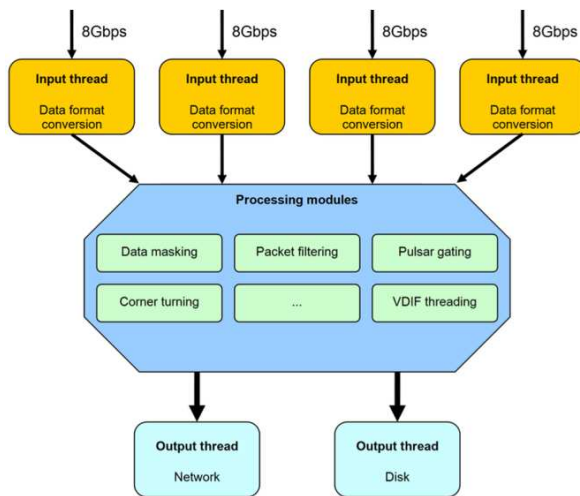

Fig. 6 Flow diagram and features for the FILA40G board.

sion of the jive5ab-2.5.1 software. A selection of features intended to be offered by the FILA40G, as well as a general flow diagram is presented in Figure 6. Currently VDIF threading and packet filtering are implemented and verified, corner turning is partially implemented, and plans are being made for pulsar gating. The FILA40G also acts as a timekeeper for the DBBC, transmitting short UDP packets containing the current timestamp over the 10 GbE links to the DBBC3s' CORE3 boards. The timestamps are generated from the FILA40G's system clock, which can be synchronized by NTP (Network Time Protocol), or a GPS receiver if a network connection is unavailable.

References

1. Tuccari G (2012) DBBC3 – A Full Digital Implementation of the VLBI2010 Backend. In: Proc. of the IVS 2012 General Meeting, 76–80, edited by D. Behrend and K. D. Baver, NASA/CP-2012-217504. <http://ivscc.gsfc.nasa.gov/publications/gm2012/tuccari.pdf>

IGN Yebes Technology Development Center

José Antonio López–Fernández, Francisco Colomer, Pablo de Vicente, Félix Tercero, José Manuel Serna, Juan Daniel Gallego, M^a Carmen Díez, Inmaculada Malo, Laura Barbas, Rubén Bolano, Susana García–Espada, Carlos Albo, Alberto Barcia, Jesús Gómez–González

Abstract The activities in technical development related to geodetic VLBI done during 2014 at IGN Yebes Observatory were focused on different topics that are detailed below.

1 RAEGE Radio Telescopes

The RAEGE radio telescopes at Yebes and Santa María are fully assembled, and the Yebes radio telescope, “Jorge Juan”, is now fully equipped with a tri-band receiver. On November 26, 2014, the 13.2-meter “Jorge Juan” radio telescope participated for the very first time in a geodetic S/X session together with our 40-meter radio telescope, confirming its first fringe detection. During 2014, the onsite work at the Santa María station have been focused on the infrastructures around the radio telescope (the control and power supply buildings). The receiver installation (a tri-band one) and the first light are planned for 2015.

2 LNA Development

During 2014, several Yebes-developed low noise cryogenic amplifiers at S, C, X, and Ka bands were allocated to equip VLBI receivers at Yebes Observatory, Azores, Ishioka (Japan), and Wettzell (BKG, Germany). The design for S-band has been transferred to the industry, and a Spanish company has produced the

LNAs. X-band has benefited from the developments accomplished for ALMA IF, and presently 4–12 GHz amplifiers are being used as VLBI frontends. Ka-band amplifiers are the fruit of a long-term successful collaboration with the Fraunhofer IAF and the University of Cantabria; they include mGaAs MMICs with good cryogenic performance. A remarkable new development in Ka-band was made together with the ETH-Zurich in the framework of an ESA contract. The amplifier is a compact hybrid design with interchangeable I/O ports 2.9 mm coaxial or WR-28 waveguide. Its ETH HEMT transistors are based in InAs. This new material has shown exceptional performance with record noise temperatures of 10 K averaged in the 25.5–32.5 GHz band, extremely high gain, and very low power dissipation. Unfortunately, the availability of these experimental devices is currently very limited.

Finally, we are working towards an ultra-wideband amplifier covering the 2–14 GHz band, following two approaches: an MMIC-based version and a hybrid amplifier. The first hybrid units produced were tested with different transistors in the first stage. The best results, obtained with NGST transistors, yield average noise temperatures of 7.5 K. These devices are subject to severe export regulations and, for the moment, can only be used on our premises. We are devoting our best efforts to ensure a reliable source of low noise transistors for radio astronomy applications in Europe.

3 Tri-band (S/X/Ka) Receiver

A cryogenically cooled tri-band receiver has been successfully designed and developed. Currently three of these receivers have been built: two of them for the

Instituto Geográfico Nacional (IGN)

IGN Yebes Technology Development Center

IVS 2014 Annual Report

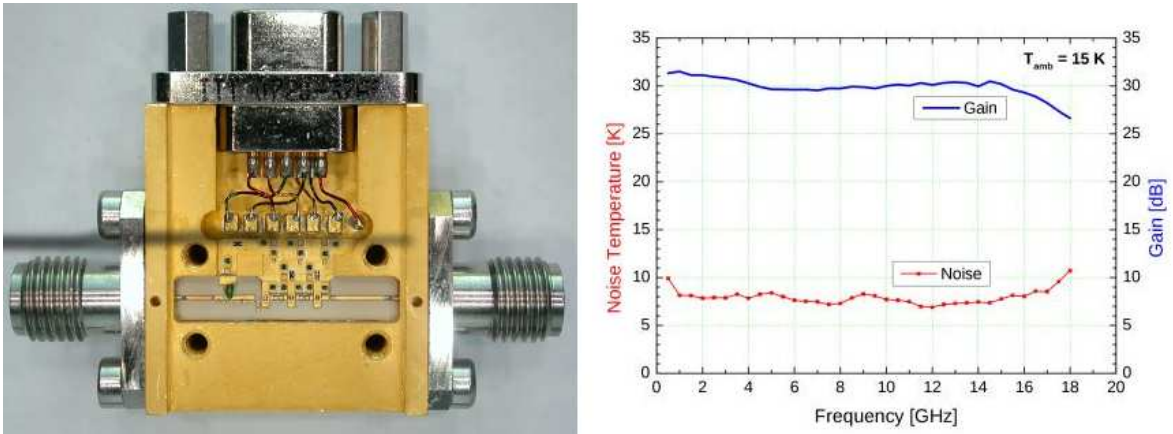

Fig. 1 2–14 GHz cryogenic amplifier picture, and noise and gain measurements at 15 K. InP NGST HEMT in the first stage.

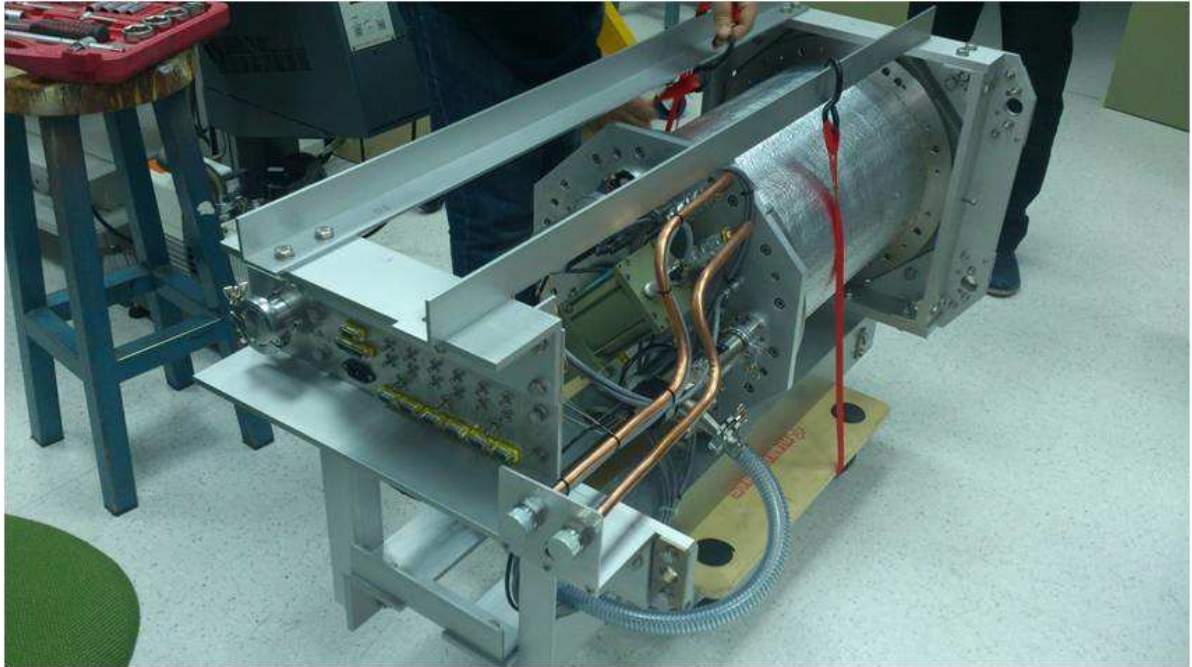

Fig. 2 Tri-band receiver installed in its frame positioner.

RAEGE radio telescopes in Yebes and Santa María, and one for the GSI's Ishioka station. This receiver allows simultaneous dual circular polarization observations at S, X, and Ka bands. The tri-band feed is actually made of three feeds in a coaxial arrangement. The S- and X-band feeds are fed by four symmetric ports at 90 degrees apart. The Ka-band feed output is a circular waveguide that interfaces to a septum polarizer-coupler developed in-house. The cryostat is built over a two-stage Sumitomo closed cycle refrigerator inside

a cylindrical dewar made of steel with suitable multi-layer insulation. The LNAs and 90° hybrid circuits are in-house designs developed at Yebes Labs. The averaged receiver noise temperatures are below 25 Kelvin. The receiver is fully integrated in a frame box positioner that facilitates the installation at the radio telescope feed cone.

4 Broadband Feed

In collaboration with the Carlos III University in Madrid, Yebes is developing an alternative broadband feed. The CQSA feed (Conical Quad-Spiral Array) is implemented as four elements, each one being a conical spiral antenna. The CQSA is double circular polarization with a symmetric pattern between 2 and 14 GHz. The phase center is not constant in the whole band, but its variation in the 4–14 GHz band is only one centimeter. The first prototype was made of titanium in order to assure the stiffness of the feed. The dimensions are 170 mm in height and 150 mm in diameter. The low conductivity of the titanium is compensated by a 10 micron silver plating layer. The feed has been measured in our anechoic chamber showing excellent performance. The RAEGE radio telescope performance has been simulated by means of PO software package GRASP and shows 70% aperture efficiency in the whole band. During the first months in 2015 the feed will be cooled, and the performance of the full receiver with our LNAs will be tested.

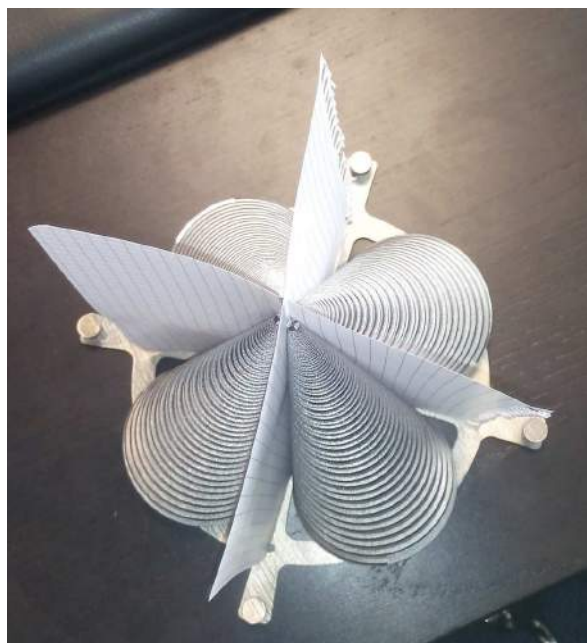

Fig. 3 CQSA feed prototype.

5 Control Software Development

During 2014 we worked on debugging the software for the control and monitoring of the 13-m RAEGE antenna in Yebes, as well as on characterizing the antenna. The work was oriented towards two different facets: single-dish observation and VLBI observations. We have investigated the RFI along the S, X, and Ka bands and its dependency on elevation and azimuth, finding that the RFI at S-band, although present, is less important in the 13-m than in the 40-m radio telescope. X-band seems to be a band almost free of RFI. Care was taken to avoid internal RFI sources inside the elevation cabin, where communication equipment and cables have been shielded.

We also determined pointing models for the antenna and the optimum focus using several sessions and following an iterative procedure. The noise diodes were calibrated using the atmosphere, and a hot load and gain curves at S, X, and Ka bands were determined while tracking sources from the horizon to zenith.

The connection between the Field System and the control system developed at Yebes is done via UDP sockets. Information from the weather station and the gps-maser comparison uses the same protocol. The Field System also transfers commands for the receivers: local oscillator frequency, attenuation, and noise diode on/off switching. Tests were performed to test the quality and the speed of the connectivity between both systems.

In August 2014, we received a DBBC2 equipped with four IFs/ADB2s/CORE2s to be used with the 13-m antenna. Once the equipment was configured and tested, we connected it to a Mark 5B+ recorder, and we performed a 24-hour VLBI session (R1656) with the 40-m telescope in parallel with the VLBA5 system. Fringes were found, and hence both the 13-m DBBC2 and the Mark 5B+ were validated.

OnOff sessions controlled by the Field System were also conducted to determine the SEFD of the telescope at S and X bands and to fine tune the calibration from the noise diodes. These tests were also important to debug the control software and the communication between the Field System and the local control system.

Finally, in November 2014, selected scans from an IVS session (R4663) were observed in parallel with the VLBA5 system connected to the 40-m telescope and the DBBC2 connected to the 13-m antenna. Fringes

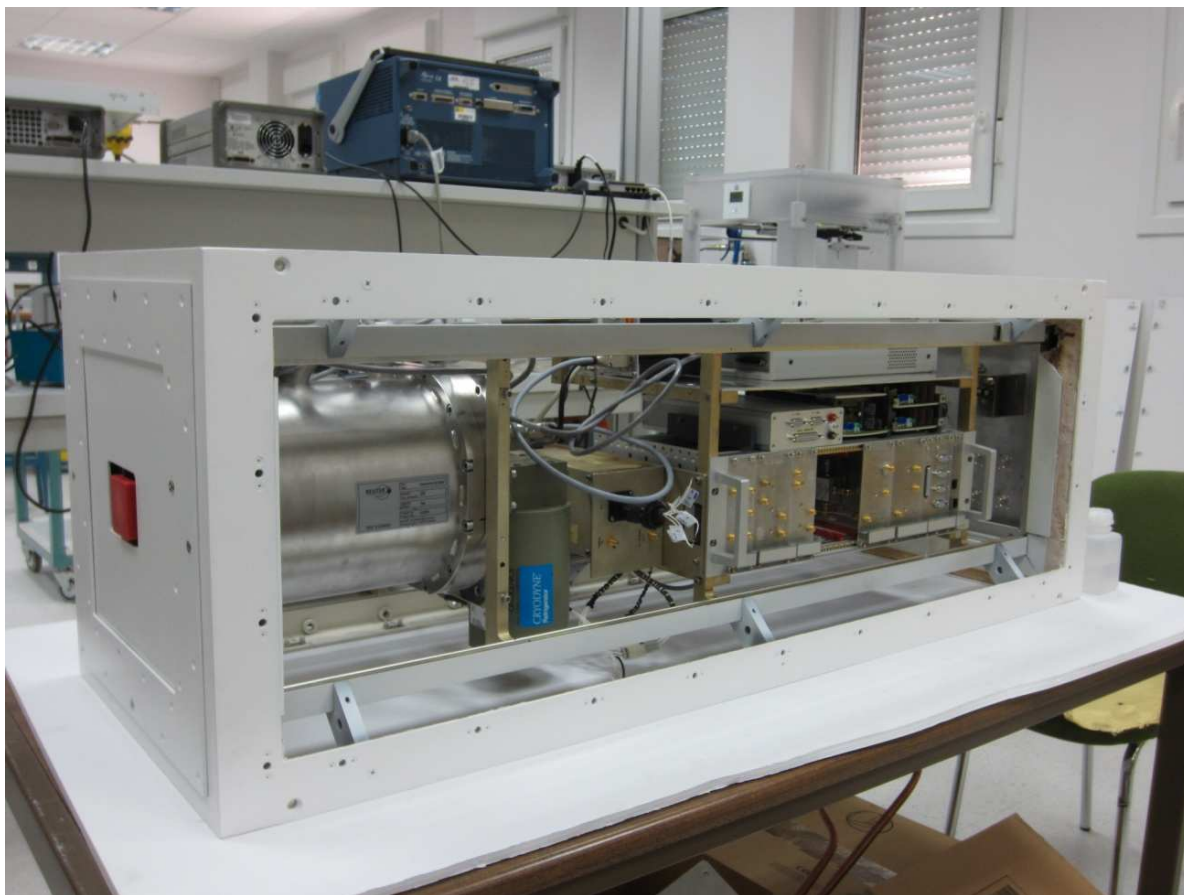

Fig. 4 O'Higgins receiver upgraded at Yebes.

were found at X-band. The lack of fringes at S-band was due to a problem with the signal from the IF.

Our near term goal is to have the 13 m be scheduled in 2015 as tagged along in some IVS sessions in which the 40-m antenna takes part. This will allow us to thoroughly test the whole receiving chain, detect problems, and correct them. It will also determine the position of the 13-m antenna and prepare the telescope for standard IVS observations. The midterm goal is to equip the antenna with a broadband receiving system and to start VGOS observations by the end of 2015.

6 S/X Receiver Activities

During 2014, several activities were carried out for the upgrade of cryogenic receivers belonging to BKG (Germany). One of the S/X Wettzell dewars was up-

graded by fixing some bugs (vacuum leaks, multilayer insulation,...) that deteriorated the cryogenic performance. The O'Higgins station in Antarctica was also fully upgraded by installing new LNAs and a custom waveguide coupler designed and built in our labs. Several receiver modules such as the down converter, noise calibration, and LO's were also upgraded. The functionalities of the receiver (setting and monitoring output power level, LO's lock status, noise cal, phase cal, and LNAs bias) can be controlled via Ethernet, using a remote control system developed in our labs.

Acknowledgements: The development of the tri-band and the broadband receivers is supported by project FIS2012-38160 financed by the Spanish Ministry of Economy and Competitiveness (MINECO).

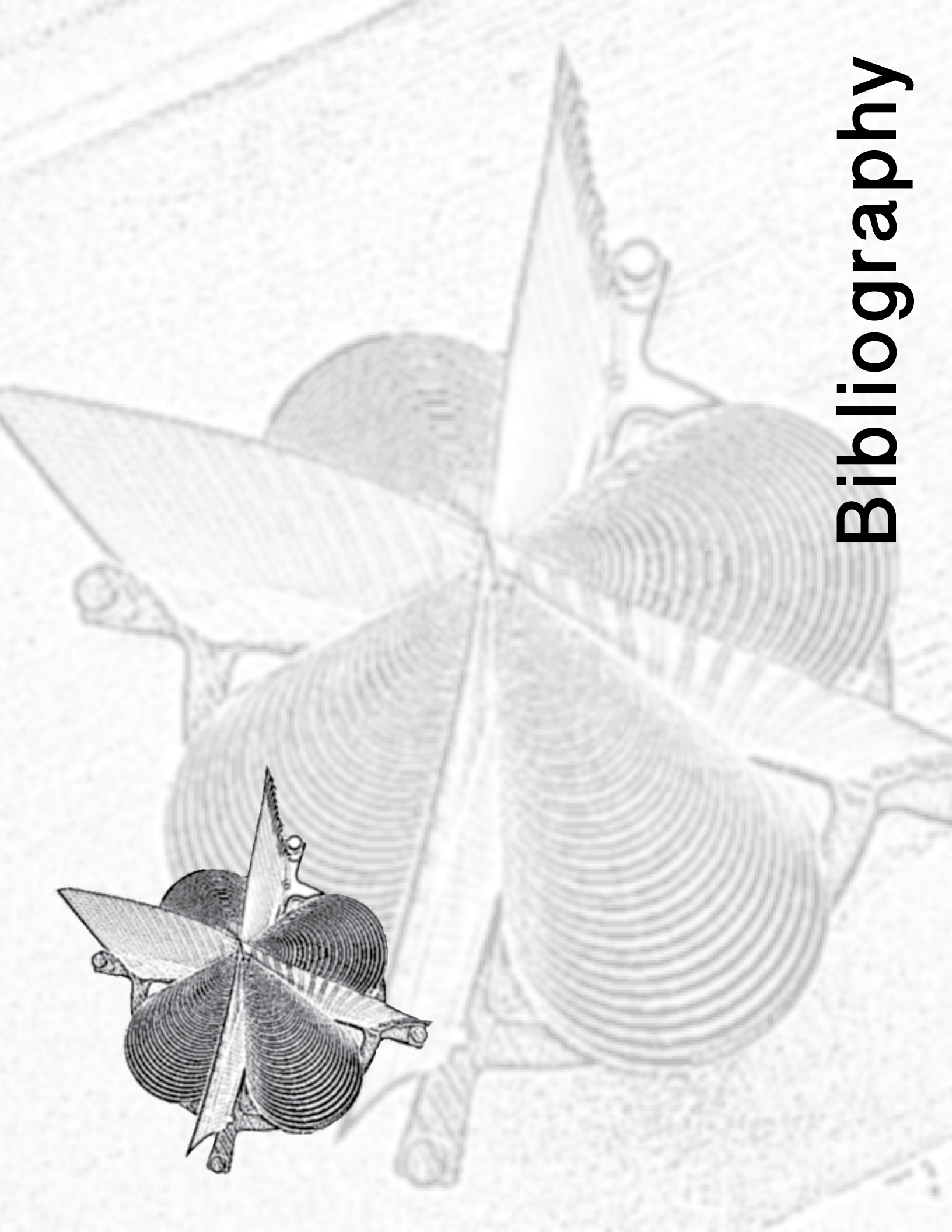
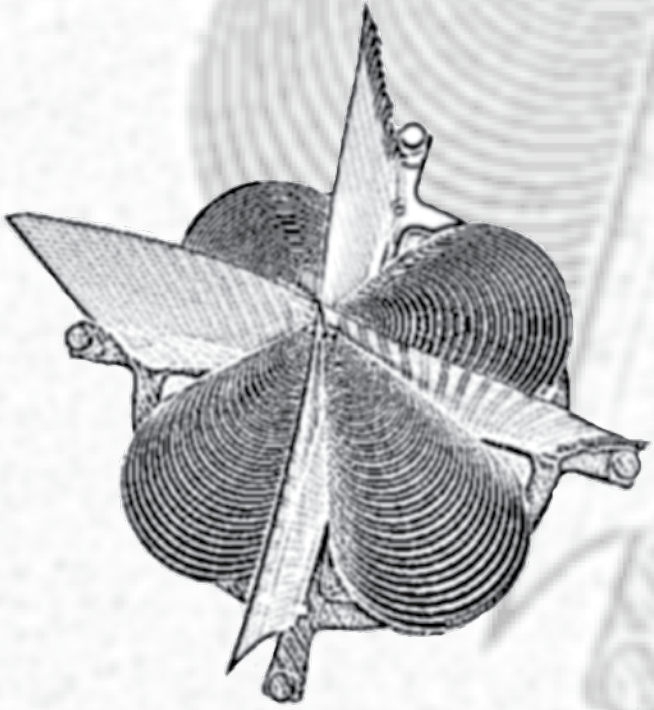

Bibliography

Bibliography

1 Introduction

The following bibliography compiles papers that were published in the field of geodetic and astrometric VLBI during 2014. There is no distinction between peer-reviewed, reviewed, or proceedings publications. This list is by no means exhaustive.

2 Geodetic and Astrometric VLBI Publications of 2014

- Y. AOYAMA, K. DOI, K. SHIBUYA: “JARE Syowa Station 11-m Antenna, Antarctica”. International VLBI Service for Geodesy and Astrometry 2013 Annual Report, edited by K. D. Baver, D. Behrend, and K. L. Armstrong, NASA/TP-2014-217522, 167–170, 2014.
- T. ARTZ, A. SPRINGER, A. NOTHNAGEL: “A complete VLBI delay model for deforming radio telescopes: the Effelsberg case”. *Journal of Geodesy*, 88(12), 1145–1161, DOI: 10.1007/s00190-014-0749-1, 2014.
- U. BACH AND A. KRAUS: “Effelsberg Radio Observatory 2013 Annual Report”. International VLBI Service for Geodesy and Astrometry 2013 Annual Report, edited by K. D. Baver, D. Behrend, and K. L. Armstrong, NASA/TP-2014-217522, 104–105, 2014.
- S. BACHMANN, M. LÖSLER, L. MESSERSCHMITT, R. SCHMID, M. BLOSSFELD, D. THALLER: “BKG/DGFI Combination Center Annual Report 2013”. International VLBI Service for Geodesy and Astrometry 2013 Annual Report, edited by K. D. Baver, D. Behrend, and K. L. Armstrong, NASA/TP-2014-217522, 257–260, 2014.
- S. BACHMANN, L. MESSERSCHMITT, D. THALLER: “IVS Combination Center at BKG: ITRF2013 Preparations and Source Position Combination”. International VLBI Service for Geodesy and Astrometry 2014 General Meeting Proceedings ‘VGOS: The New VLBI Network’, edited by D. Behrend, K. D. Baver, and K. L. Armstrong, Science Press (Beijing), ISBN 978-7-03-042974-2, 243–247, 2014.
- C. BARACHE AND S. LAMBERT: “Paris Observatory (OPAR) Data Center”. International VLBI Service for Geodesy and Astrometry 2013 Annual Report, edited by K. D. Baver, D. Behrend, and K. L. Armstrong, NASA/TP-2014-217522, 244–245, 2014.
- S. BASU, A. DE WITT, J. QUICK, A. BERTARINI, L. LEEUW: “Multi-epoch Study of Source Morphology in the Southern Hemisphere”. International VLBI Service for Geodesy and Astrometry 2014 General Meeting Proceedings ‘VGOS: The New VLBI Network’, edited by D. Behrend, K. D. Baver, and K. L. Armstrong, Science Press (Beijing), ISBN 978-7-03-042974-2, 426–430, 2014.
- K. BAVER AND J. GIPSON: “Balancing Sky Coverage and Source Strength in the Improvement of the IVS-INT01 Sessions”. International VLBI Service for Geodesy and Astrometry 2014 General Meeting Proceedings ‘VGOS: The New VLBI Network’, edited by D. Behrend, K. D. Baver, and K. L. Armstrong, Science Press (Beijing), ISBN 978-7-03-042974-2, 267–271, 2014.

- C. BEAUDOIN: “Design of a Circularly-Polarized VGOS Frontend for Simplified Mixed-Mode VLBI Observations”. International VLBI Service for Geodesy and Astrometry 2014 General Meeting Proceedings ‘VGOS: The New VLBI Network’, edited by D. Behrend, K. D. Baver, and K. L. Armstrong, Science Press (Beijing), ISBN 978-7-03-042974-2, 73–76, 2014.
- C. BEAUDOIN, P. BOLIS, B. COREY, M. DEROME, C. ECKERT, A. NIELL, C. RUSZCZYK, R. MCWHIRTER, A. WHITNEY: “A Cost and Complexity Survey on Emerging Technologies for the VGOS”. International VLBI Service for Geodesy and Astrometry 2014 General Meeting Proceedings ‘VGOS: The New VLBI Network’, edited by D. Behrend, K. D. Baver, and K. L. Armstrong, Science Press (Beijing), ISBN 978-7-03-042974-2, 53–59, 2014.
- C. BEAUDOIN, A. NIELL, R. CAPPALLO: “Haystack Observatory Technology Development Center”. International VLBI Service for Geodesy and Astrometry 2013 Annual Report, edited by K. D. Baver, D. Behrend, and K. L. Armstrong, NASA/TP-2014-217522, 341–344, 2014.
- D. BEHREND: “Coordinating Center Report”. International VLBI Service for Geodesy and Astrometry 2013 Annual Report, edited by K. D. Baver, D. Behrend, and K. L. Armstrong, NASA/TP-2014-217522, 83–85, 2014.
- D. BEHREND, C. THOMAS, E. HIMWICH, D. MACMILLAN: “CONT14: Preparation and Prospects”. International VLBI Service for Geodesy and Astrometry 2014 General Meeting Proceedings ‘VGOS: The New VLBI Network’, edited by D. Behrend, K. D. Baver, and K. L. Armstrong, Science Press (Beijing), ISBN 978-7-03-042974-2, 196–200, 2014.
- I. BEZRUKOV, A. SALNIKOV, A. VYLEGZHANIN: “Russian Data Recording System of New Generation”. International VLBI Service for Geodesy and Astrometry 2014 General Meeting Proceedings ‘VGOS: The New VLBI Network’, edited by D. Behrend, K. D. Baver, and K. L. Armstrong, Science Press (Beijing), ISBN 978-7-03-042974-2, 130–133, 2014.
- G. BIANCO, G. COLUCCI, F. SCHIAVONE: “Matera CGS VLBI Station 2013 Annual Report”. International VLBI Service for Geodesy and Astrometry 2013 Annual Report, edited by K. D. Baver, D. Behrend, and K. L. Armstrong, NASA/TP-2014-217522, 130–132, 2014.
- J. BÖHM, S. BÖHM, A. HELLERSCHMIED, A. HOFMEISTER, H. KRÁSNÁ, M. MADZAK, D. MAYER, L. PLANK, B. SOJA, J. SUN, C. TIerno-ROS: “Vienna Special Analysis Center Annual Report 2013”. International VLBI Service for Geodesy and Astrometry 2013 Annual Report, edited by K. D. Baver, D. Behrend, and K. L. Armstrong, NASA/TP-2014-217522, 330–333, 2014.
- J. BÖHM, H. KRÁSNÁ, S. BÖHM, V. CHOLIY, A. HELLERSCHMIED, A. HOFMEISTER, M. KARBON, D. MAYER, J. MCCALLUM, M. MADZAK, T. NILSSON, L. PLANK, S. SHABALA, B. SOJA, J. SUN, K. TEKE: “Vienna VLBI Software: Current Release and Plans for the Future”. International VLBI Service for Geodesy and Astrometry 2014 General Meeting Proceedings ‘VGOS: The New VLBI Network’, edited by D. Behrend, K. D. Baver, and K. L. Armstrong, Science Press (Beijing), ISBN 978-7-03-042974-2, 258–261, 2014.
- S. BOLOTIN, K. BAVER, J. GIPSON, D. GORDON, D. MACMILLAN: “The VLBI Data Analysis Software vSolve: Development Progress and Plans for the Future”. International VLBI Service for Geodesy and Astrometry 2014 General Meeting Proceedings ‘VGOS: The New VLBI Network’, edited by D. Behrend, K. D. Baver, and K. L. Armstrong, Science Press (Beijing), ISBN 978-7-03-042974-2, 253–257, 2014.
- R. BOUFFET, P. CHARLOT, S. LAMBERT: “Effects of AGN Jet Evolution on VLBI Astrometric Positions”. International VLBI Service for Geodesy and Astrometry 2014 General Meeting Proceedings ‘VGOS: The New VLBI Network’, edited by D. Behrend, K. D. Baver, and K. L. Armstrong, Science Press (Beijing), ISBN 978-7-03-042974-2, 417–420, 2014.
- N. CAPITAIN, J. C. LIU: “The Evaluation of the Earth’s Dynamical Flattening Based on the IAU Precession-nutation and VLBI Observations”. International VLBI Service for Geodesy and Astrometry 2014 General Meeting Proceedings ‘VGOS: The New VLBI Network’, edited by D. Behrend, K. D.

- Baver, and K. L. Armstrong, Science Press (Beijing), ISBN 978-7-03-042974-2, 373–375, 2014.
- R. CAPPALLO: “Correlating and Fringe-fitting Broadband VGOS Data”. International VLBI Service for Geodesy and Astrometry 2014 General Meeting Proceedings ‘VGOS: The New VLBI Network’, edited by D. Behrend, K. D. Baver, and K. L. Armstrong, Science Press (Beijing), ISBN 978-7-03-042974-2, 91–96, 2014.
- P. CHARLOT, A. BELLANGER, R. BOUFFET, G. BOURDA, A. COLLILOUD, A. BAUDRY: “Report for 2013 from the Bordeaux IVS Analysis Center”. International VLBI Service for Geodesy and Astrometry 2013 Annual Report, edited by K. D. Baver, D. Behrend, and K. L. Armstrong, NASA/TP-2014-217522, 253–256, 2014.
- L. COMBRINCK: “Space Geodesy, VLBI, and the Fourth Pillar of Geodesy – Spacetime Curvature”. International VLBI Service for Geodesy and Astrometry 2014 General Meeting Proceedings ‘VGOS: The New VLBI Network’, edited by D. Behrend, K. D. Baver, and K. L. Armstrong, Science Press (Beijing), ISBN 978-7-03-042974-2, 381–385, 2014.
- R. CURTIS: “Kokee Park Geophysical Observatory”. International VLBI Service for Geodesy and Astrometry 2013 Annual Report, edited by K. D. Baver, D. Behrend, and K. L. Armstrong, NASA/TP-2014-217522, 123–125, 2014.
- D. DALE, L. COMBRINCK, A. DE WITT: “A Strategic Independent Geodetic VLBI Network for Europe”. International VLBI Service for Geodesy and Astrometry 2014 General Meeting Proceedings ‘VGOS: The New VLBI Network’, edited by D. Behrend, K. D. Baver, and K. L. Armstrong, Science Press (Beijing), ISBN 978-7-03-042974-2, 335–338, 2014.
- P. DE VICENTE, R. BOLAÑO, L. BARBAS: “Control System and Tests for the 13.2-m RAEGE Antenna at Yebes”. International VLBI Service for Geodesy and Astrometry 2014 General Meeting Proceedings ‘VGOS: The New VLBI Network’, edited by D. Behrend, K. D. Baver, and K. L. Armstrong, Science Press (Beijing), ISBN 978-7-03-042974-2, 111–114, 2014.
- A. DE WITT, A. BERTARINI, S. HORUCHI, C. JACOBS, T. JUNG, J. LOVELL, J. MCCALLUM, J. QUICK, B. SOHN, C. PHILLIPS, R. OJHA: “Completing the K-band Celestial Reference Frame in the Southern Hemisphere”. International VLBI Service for Geodesy and Astrometry 2014 General Meeting Proceedings ‘VGOS: The New VLBI Network’, edited by D. Behrend, K. D. Baver, and K. L. Armstrong, Science Press (Beijing), ISBN 978-7-03-042974-2, 433–437, 2014.
- D. ERIKSSON, D. MACMILLAN “Continental Hydrology Loading Observed by VLBI Measurements”. *Journal of Geodesy*, 88(7), DOI: 10.1007/s00190-014-0713-0, 675–690, 2014.
- D. ERIKSSON, D. MACMILLAN, J. GIPSON: “Troposphere Delay Raytracing Applied in VLBI Analysis”. *Journal of Geophysical Research Solid Earth*, December 2014, 119(12), DOI: 10.1002/2014JB011552, 2014.
- D. ERIKSSON, D. MACMILLAN, J. GIPSON: “Troposphere Delay Raytracing Applied in VLBI Analysis”. International VLBI Service for Geodesy and Astrometry 2014 General Meeting Proceedings ‘VGOS: The New VLBI Network’, edited by D. Behrend, K. D. Baver, and K. L. Armstrong, Science Press (Beijing), ISBN 978-7-03-042974-2, 279–282, 2014.
- A. FEY AND R. GAUME: “USNO Analysis Center for Source Structure Report”. International VLBI Service for Geodesy and Astrometry 2013 Annual Report, edited by K. D. Baver, D. Behrend, and K. L. Armstrong, NASA/TP-2014-217522, 328–329, 2014.
- A. FEY, N. GEIGER, C. DIECK: “U. S. Naval Observatory VLBI Analysis Center”. International VLBI Service for Geodesy and Astrometry 2013 Annual Report, edited by K. D. Baver, D. Behrend, and K. L. Armstrong, NASA/TP-2014-217522, 325–327, 2014.
- R. FIGUEROA, J. REDMOND, K. PAZAMICKAS: “Goddard Geophysical and Astronomical Observatory”. International VLBI Service for Geodesy and Astrometry 2013 Annual Report, edited by K. D. Baver, D. Behrend, and K. L. Armstrong, NASA/TP-2014-217522, 108–110, 2014.
- Y. FUKUZAKI, T. TANABE, J. KURODA, S. KURIHARA, R. KAWABATA, T. WAKASUGI: “Construction of a VGOS Station in Japan”. International VLBI Service for Geodesy and Astrometry 2014

- General Meeting Proceedings ‘VGOS: The New VLBI Network’, edited by D. Behrend, K. D. Baver, and K. L. Armstrong, Science Press (Beijing), ISBN 978-7-03-042974-2, 32–35, 2014.
- Y. FUKUZAKI, K. WADA, J. KURODA, S. KURIHARA, R. KAWABATA, T. WAKASUGI: “Receiving performance of Ishioka VGOS Antenna”. *IVS NICT Technology Development Center News*, No. 34, ISSN 1882-3432, 8–10, 2014.
- J. GAN, Z. XU, X. ZHANG, S. GUO, R. ZHU, Y. XIANG: “VLBI Data Playback in FPGA”. *International VLBI Service for Geodesy and Astrometry 2014 General Meeting Proceedings ‘VGOS: The New VLBI Network’*, edited by D. Behrend, K. D. Baver, and K. L. Armstrong, Science Press (Beijing), ISBN 978-7-03-042974-2, 219–223, 2014.
- G. GANCIO, J. J. LARRARTE, E. DIAZ, F. AQUINO, S. SPAGNOLO: “Development of an Electromagnetic Interference Monitor from 1 GHz to 18 GHz”. *International VLBI Service for Geodesy and Astrometry 2014 General Meeting Proceedings ‘VGOS: The New VLBI Network’*, edited by D. Behrend, K. D. Baver, and K. L. Armstrong, Science Press (Beijing), ISBN 978-7-03-042974-2, 210–214, 2014.
- J. GIPSON: “IVS Working Group IV and the New Open Format Database”. *International VLBI Service for Geodesy and Astrometry 2014 General Meeting Proceedings ‘VGOS: The New VLBI Network’*, edited by D. Behrend, K. D. Baver, and K. L. Armstrong, Science Press (Beijing), ISBN 978-7-03-042974-2, 248–252, 2014.
- J. GIPSON: “The 2013 Analysis Coordinator Report”. *International VLBI Service for Geodesy and Astrometry 2013 Annual Report*, edited by K. D. Baver, D. Behrend, and K. L. Armstrong, NASA/TP-2014-217522, 86–88, 2014.
- J. GIPSON, J. BÖHM, S. BOLOTIN, D. GORDON, T. HOBIGER, C. JACOBS, S. KURDUBOV, A. NOTHNAGEL, O. SOVERS, O. TITOV, H. TAKIGUCHI: “Final Report of IVS Working Group 4 (WG4) on Data Structures”. *International VLBI Service for Geodesy and Astrometry 2013 Annual Report*, edited by K. D. Baver, D. Behrend, and K. L. Armstrong, NASA/TP-2014-217522, 11–25, 2014.
- J. GIPSON, K. LE BAIL, C. MA: “The NASA Goddard Group’s Source Monitoring Database and Program”. *International VLBI Service for Geodesy and Astrometry 2014 General Meeting Proceedings ‘VGOS: The New VLBI Network’*, edited by D. Behrend, K. D. Baver, and K. L. Armstrong, Science Press (Beijing), ISBN 978-7-03-042974-2, 390–394, 2014.
- A. GIRDIUK AND O. TITOV: “Plan and Schedule VLBI Observations of Close Approaches of Jupiter to Compact Extragalactic Radio Sources in 2016”. *International VLBI Service for Geodesy and Astrometry 2014 General Meeting Proceedings ‘VGOS: The New VLBI Network’*, edited by D. Behrend, K. D. Baver, and K. L. Armstrong, Science Press (Beijing), ISBN 978-7-03-042974-2, 359–363, 2014.
- A. GIRDIUK, O. TITOV, L. STANFORD: “An Alternative Model of the Gravitational Delay”. *International VLBI Service for Geodesy and Astrometry 2014 General Meeting Proceedings ‘VGOS: The New VLBI Network’*, edited by D. Behrend, K. D. Baver, and K. L. Armstrong, Science Press (Beijing), ISBN 978-7-03-042974-2, 376–380, 2014.
- J. GÓMEZ-GONZÁLEZ, J. A. LÓPEZ-FERNÁNDEZ, F. COLOMER, L. SANTOS: “An Atlantic Network of Geodynamical and Space Stations: The RAEGE Project”. *International VLBI Service for Geodesy and Astrometry 2014 General Meeting Proceedings ‘VGOS: The New VLBI Network’*, edited by D. Behrend, K. D. Baver, and K. L. Armstrong, Science Press (Beijing), ISBN 978-7-03-042974-2, 20–24, 2014.
- J. GÓMEZ-GONZÁLEZ, J. A. LÓPEZ-FERNÁNDEZ, F. COLOMER, L. SANTOS: “Instituto Geográfico Nacional of Spain”. *International VLBI Service for Geodesy and Astrometry 2013 Annual Report*, edited by K. D. Baver, D. Behrend, and K. L. Armstrong, NASA/TP-2014-217522, 191–194, 2014.
- D. GORDON: “Revisiting the VLBA Calibrator Surveys for ICRF3”. *International VLBI Service for Geodesy and Astrometry 2014 General Meeting Proceedings ‘VGOS: The New VLBI Network’*, edited by D. Behrend, K. D. Baver, and K. L. Armstrong, Science Press (Beijing), ISBN 978-7-03-042974-2, 386–389, 2014.
- D. GORDON, C. MA, D. MACMILLAN, J. GIPSON, S. BOLOTIN, K. LE BAIL, K. BAVER: “GSFC

- VLBI Analysis Center Report”. International VLBI Service for Geodesy and Astrometry 2013 Annual Report, edited by K. D. Baver, D. Behrend, and K. L. Armstrong, NASA/TP-2014-217522, 272–275, 2014.
- V. GUBANOV AND S. KURDUBOV: “Some New Results of the VLBI Data Analysis in the IAA RAS”. International VLBI Service for Geodesy and Astrometry 2014 General Meeting Proceedings ‘VGOS: The New VLBI Network’, edited by D. Behrend, K. D. Baver, and K. L. Armstrong, Science Press (Beijing), ISBN 978-7-03-042974-2, 325–329, 2014.
- S. GUO, Z. XU, J. GAN, X. ZHANG, R. ZHU, Y. WU, Y. XIANG: “Control System and Visualization of the VLBI Hardware Correlator at SHAO”. International VLBI Service for Geodesy and Astrometry 2014 General Meeting Proceedings ‘VGOS: The New VLBI Network’, edited by D. Behrend, K. D. Baver, and K. L. Armstrong, Science Press (Beijing), ISBN 978-7-03-042974-2, 231–235, 2014.
- A. GUSEV, J. PING, H. HANADA, F. KIKUCHI, A. KOSOV, J. LI, O. TITOV: “Radio Navigation Beacons on the Moon, Lunar Geodetic VLBI System, Physical Libration of the Moon for Chang’E-3/4, Luna-Gob, Luna-Resource and SELENE-2 Projects”. International VLBI Service for Geodesy and Astrometry 2014 General Meeting Proceedings ‘VGOS: The New VLBI Network’, edited by D. Behrend, K. D. Baver, and K. L. Armstrong, Science Press (Beijing), ISBN 978-7-03-042974-2, 485–489, 2014.
- R. HAAS: “IVS WG6 Final Report”. International VLBI Service for Geodesy and Astrometry 2013 Annual Report, edited by K. D. Baver, D. Behrend, and K. L. Armstrong, NASA/TP-2014-217522, 26–63, 2014.
- R. HAAS, G. ELGERED, J. LÖFGREN: “Twin Telescope and Tide Gauge Plans for the Onsala Space Observatory”. International VLBI Service for Geodesy and Astrometry 2014 General Meeting Proceedings ‘VGOS: The New VLBI Network’, edited by D. Behrend, K. D. Baver, and K. L. Armstrong, Science Press (Beijing), ISBN 978-7-03-042974-2, 205–209, 2014.
- R. HAAS, G. ELGERED, J. LÖFGREN, T. NING, H. G. SCHERNECK: “Onsala Space Observatory – IVS Network Station Activities During 2013”. International VLBI Service for Geodesy and Astrometry 2013 Annual Report, edited by K. D. Baver, D. Behrend, and K. L. Armstrong, NASA/TP-2014-217522, 151–154, 2014.
- R. HAAS, A. NEIDHARDT, J. KODET, C. PLÖTZ, U. SCHREIBER, G. KRONSCHNABL, S. POGREBENKO, D. DUEV, S. CASEY, I. MARTI-VIDAL, J. YANG, L. PLANK: “The Wettzell–Onsala G130128 Experiment: VLBI Observations of a GLONASS Satellite”. International VLBI Service for Geodesy and Astrometry 2014 General Meeting Proceedings ‘VGOS: The New VLBI Network’, edited by D. Behrend, K. D. Baver, and K. L. Armstrong, Science Press (Beijing), ISBN 978-7-03-042974-2, 451–455, 2014.
- R. HAAS, H. G. SCHERNECK, J. LÖFGREN, T. NING, N. KAREINEN: “Onsala Space Observatory – IVS Analysis Center Activities during 2013”. International VLBI Service for Geodesy and Astrometry 2013 Annual Report, edited by K. D. Baver, D. Behrend, and K. L. Armstrong, NASA/TP-2014-217522, 304–307, 2014.
- Y. HAGIWARA, S. SUZUKI, T. OYAMA, T. NISHIKAWA: “Report of VLBI Experiments between Australia and Japan”. IVS NICT Technology Development Center News, No. 34, ISSN 1882-3432, 6–7, 2014.
- D. M. HALL AND M. S. CARTER: “NEOS Operation Center”. International VLBI Service for Geodesy and Astrometry 2013 Annual Report, edited by K. D. Baver, D. Behrend, and K. L. Armstrong, NASA/TP-2014-217522, 206, 2014.
- D. M. HALL AND D. VEILLETTE: “Washington Correlator”. International VLBI Service for Geodesy and Astrometry 2013 Annual Report, edited by K. D. Baver, D. Behrend, and K. L. Armstrong, NASA/TP-2014-217522, 231–232, 2014.
- S. HALSIG, T. ARTZ, J. LEEK, A. NOTHNAGEL: “VLBI Analyses using Covariance Information from Turbulence Models”. International VLBI Service for Geodesy and Astrometry 2014 General Meeting Proceedings ‘VGOS: The New VLBI Network’, edited by D. Behrend, K. D. Baver, and K. L. Armstrong, Science Press (Beijing), ISBN 978-7-03-042974-2, 272–276, 2014.

- S. HAN, G. TANG, L. CHEN, J. CAO, T. P. REN, M. WANG: "VLBI Software Correlator at the Interferometric Tracking Center of the China Deep Space Network". International VLBI Service for Geodesy and Astrometry 2014 General Meeting Proceedings 'VGOS: The New VLBI Network', edited by D. Behrend, K. D. Baver, and K. L. Armstrong, Science Press (Beijing), ISBN 978-7-03-042974-2, 482–484, 2014.
- H. HASE, C. HERRERA, P. PINO, C. BELTRAN: "Status of the TIGO VLBI Station in Concepción". International VLBI Service for Geodesy and Astrometry 2013 Annual Report, edited by K. D. Baver, D. Behrend, and K. L. Armstrong, NASA/TP-2014-217522, 171–172, 2014.
- H. HASE AND F. PEDREROS: "The Most Remote Point Method for the Site Selection of the Future VGOS Network". International VLBI Service for Geodesy and Astrometry 2014 General Meeting Proceedings 'VGOS: The New VLBI Network', edited by D. Behrend, K. D. Baver, and K. L. Armstrong, Science Press (Beijing), ISBN 978-7-03-042974-2, 11–15, 2014.
- R. HEINKELMANN, M. KARBON, L. LIU, C. LU, J. A. MORA-DIAZ, T. NILSSON, V. RAPOSO-PULIDO, B. SOJA, M. XU, H. SCHUH: "GFZ Analysis Center 2013 Annual Report". International VLBI Service for Geodesy and Astrometry 2013 Annual Report, edited by K. D. Baver, D. Behrend, and K. L. Armstrong, NASA/TP-2014-217522, 265–267, 2014.
- R. HEINKELMANN, T. NILSSON, M. KARBON, L. LIU, C. LU, J. A. MORA-DIAZ, E. PARSELIA, V. RAPOSO-PULIDO, B. SOJA, M. XU, H. SCHUH: "The GFZ VLBI Solution: Characteristics and First Results". International VLBI Service for Geodesy and Astrometry 2014 General Meeting Proceedings 'VGOS: The New VLBI Network', edited by D. Behrend, K. D. Baver, and K. L. Armstrong, Science Press (Beijing), ISBN 978-7-03-042974-2, 330–334, 2014.
- A. HELLERSCHMIED, L. PLANK, A. NEIDHARDT, R. HAAS, J. BÖHM, C. PLÖTZ, J. KODET: "Observing Satellites with VLBI Radio Telescopes: Practical Realization at Wettzell". International VLBI Service for Geodesy and Astrometry 2014 General Meeting Proceedings 'VGOS: The New VLBI Network', edited by D. Behrend, K. D. Baver, and K. L. Armstrong, Science Press (Beijing), ISBN 978-7-03-042974-2, 441–445, 2014.
- E. HIMWICH AND J. GIPSON: "GSFC Technology Development Center Report". International VLBI Service for Geodesy and Astrometry 2013 Annual Report, edited by K. D. Baver, D. Behrend, and K. L. Armstrong, NASA/TP-2014-217522, 338–340, 2014.
- E. HIMWICH AND R. STRAND: "Network Coordinator Report". International VLBI Service for Geodesy and Astrometry 2013 Annual Report, edited by K. D. Baver, D. Behrend, and K. L. Armstrong, NASA/TP-2014-217522, 89–94, 2014.
- T. HOBIGER AND M. SEKIDO: "Analysis Center at National Institute of Information and Communications Technology". International VLBI Service for Geodesy and Astrometry 2013 Annual Report, edited by K. D. Baver, D. Behrend, and K. L. Armstrong, NASA/TP-2014-217522, 295–298, 2014.
- A. HOFMEISTER AND J. BÖHM: "Ray-traced Delays in the Atmosphere for Geodetic VLBI". International VLBI Service for Geodesy and Astrometry 2014 General Meeting Proceedings 'VGOS: The New VLBI Network', edited by D. Behrend, K. D. Baver, and K. L. Armstrong, Science Press (Beijing), ISBN 978-7-03-042974-2, 283–287, 2014.
- R. ICHIKAWA AND M. SEKIDO: "Data Center at NICT". International VLBI Service for Geodesy and Astrometry 2013 Annual Report, edited by K. D. Baver, D. Behrend, and K. L. Armstrong, NASA/TP-2014-217522, 241–243, 2014.
- A. IDDINK, T. ARTZ, A. NOTHNAGEL: "Combining Datum-free Normal Equation Systems and Solutions with Full Covariance Information for Upcoming CRF Realizations". International VLBI Service for Geodesy and Astrometry 2014 General Meeting Proceedings 'VGOS: The New VLBI Network', edited by D. Behrend, K. D. Baver, and K. L. Armstrong, Science Press (Beijing), ISBN 978-7-03-042974-2, 438–440, 2014.
- A. IDDINK, A. NOTHNAGEL, T. ARTZ: "Rigorous VLBI intra-technique combination strategy for upcoming CRF realizations". Proceedings of the Journées 2013 "Systèmes de Référence Spatio-Temporels", edited by N. Capitaine, Observatoire de Paris, 81–83, ISBN 978-2-901057-69-7, 2014.

- G. ILIN, V. BYKOV, V. STEMPOVSKY, A. SHISHIKIN: “WVRs for the “Quasar” Network”. International VLBI Service for Geodesy and Astrometry 2014 General Meeting Proceedings ‘VGOS: The New VLBI Network’, edited by D. Behrend, K. D. Baver, and K. L. Armstrong, Science Press (Beijing), ISBN 978-7-03-042974-2, 102–105, 2014.
- A. IPATOV, I. GAYAZOV, S. SMOLENTSEV, D. IVANOV, G. ILIN, N. SHUYGINA, Y. BONDARENKO: “Co-location of Space Geodetic Techniques at the “Quasar” VLBI Network Observatories”. International VLBI Service for Geodesy and Astrometry 2014 General Meeting Proceedings ‘VGOS: The New VLBI Network’, edited by D. Behrend, K. D. Baver, and K. L. Armstrong, Science Press (Beijing), ISBN 978-7-03-042974-2, 173–177, 2014.
- A. IPATOV, I. IPATOVA, V. MARDYSHKIN, A. EVSTIGNEEV, E. KHVOSTOV, A. LAVROV, V. CHERNOV: “Tri-band System for the Russian Interferometer”. International VLBI Service for Geodesy and Astrometry 2014 General Meeting Proceedings ‘VGOS: The New VLBI Network’, edited by D. Behrend, K. D. Baver, and K. L. Armstrong, Science Press (Beijing), ISBN 978-7-03-042974-2, 118–121, 2014.
- A. IPATOV, D. IVANOV, G. ILIN, S. SMOLENTSEV, M. VARGANOV, I. GAYAZOV, V. MARDYSHKIN, L. FEDOTOV, M. KAJDANOVSKY, A. VYTNOV, A. SALNIKOV, A. MIKHAILOV: “Russian VLBI System of New Generation”. International VLBI Service for Geodesy and Astrometry 2014 General Meeting Proceedings ‘VGOS: The New VLBI Network’, edited by D. Behrend, K. D. Baver, and K. L. Armstrong, Science Press (Beijing), ISBN 978-7-03-042974-2, 25–29, 2014.
- C. JACOBS: “JPL VLBI Analysis Center Report for 2013”. International VLBI Service for Geodesy and Astrometry 2013 Annual Report, edited by K. D. Baver, D. Behrend, and K. L. Armstrong, NASA/TP-2014-217522, 285–287, 2014.
- C. JACOBS, F. ARIAS, D. BOBOLTZ, J. BÖHM, S. BOLOTIN, G. BOURDA, P. CHARLOT, A. DE WITT, A. FEY, R. GAUME, D. GORDON, R. HEINKELMANN, S. LAMBERT, C. MA, Z. MALKIN, A. NOTHNAGEL, M. SEITZ, E. SKURIKHINA, J. SOUCHAY, O. TITOV: “ICRF-3: Roadmap to the Next Generation ICRF”. Proceedings of the Journées 2013 “Systèmes de Référence Spatio-Temporels”, edited by N. Capitaine, Observatoire de Paris, 51–56, ISBN 978-2-901057-69-7, 2014.
- W. JIANG, F. SHU, F. TONG, W. ZHENG: “Recent Geodetic Activities of the Shanghai VLBI Correlator”. International VLBI Service for Geodesy and Astrometry 2014 General Meeting Proceedings ‘VGOS: The New VLBI Network’, edited by D. Behrend, K. D. Baver, and K. L. Armstrong, Science Press (Beijing), ISBN 978-7-03-042974-2, 224–227, 2014.
- T. JIKE, Y. TAMURA, M. SHIZUGAMI: “VERA 2013 Geodetic Activities”. International VLBI Service for Geodesy and Astrometry 2013 Annual Report, edited by K. D. Baver, D. Behrend, and K. L. Armstrong, NASA/TP-2014-217522, 139–141, 2014.
- M. KARBON, B. SOJA, T. NILSSON, R. HEINKELMANN, L. LIU, C. LU, J. A. MORA-DIAZ, V. RAPOSO-PULIDO, M. XU, H. SCHUH: “ERP Estimation using a Kalman Filter in VLBI”. International VLBI Service for Geodesy and Astrometry 2014 General Meeting Proceedings ‘VGOS: The New VLBI Network’, edited by D. Behrend, K. D. Baver, and K. L. Armstrong, Science Press (Beijing), ISBN 978-7-03-042974-2, 298–301, 2014.
- N. KAREINEN, R. HAAS, L. LA PORTA, A. BERTARINI: “Going Digital – The Transition from Mark IV to DBBC at Onsala”. International VLBI Service for Geodesy and Astrometry 2014 General Meeting Proceedings ‘VGOS: The New VLBI Network’, edited by D. Behrend, K. D. Baver, and K. L. Armstrong, Science Press (Beijing), ISBN 978-7-03-042974-2, 178–182, 2014.
- P. KAUFMANN, A. MACILLIO PEREIRA DE LUCENA, A. SOMBRA DA SILVA: “Fortaleza Station 2013 Annual Report”. International VLBI Service for Geodesy and Astrometry 2013 Annual Report, edited by K. D. Baver, D. Behrend, and K. L. Armstrong, NASA/TP-2014-217522, 106–107, 2014.
- N. KAWAGUCHI: “The Tian Ma 65-m radio telescope of Shanghai Observatory”. IVS NICT Technology Development

- Center News, No. 34, ISSN 1882-3432, 14–16, 2014.
- V. KEN, V. MISHIN, D. PAVLOV, N. SOKOLOVA, I. SURKIS: “Design of a VGOS Software Correlator Based on GPUs”. *International VLBI Service for Geodesy and Astrometry 2014 General Meeting Proceedings ‘VGOS: The New VLBI Network’*, edited by D. Behrend, K. D. Baver, and K. L. Armstrong, Science Press (Beijing), ISBN 978-7-03-042974-2, 183–187, 2014.
- H. P. KIERULF, A. S. KIRKVIK, P. H. ANDERSEN: “NMA Analysis Center 2013 Annual Report”. *International VLBI Service for Geodesy and Astrometry 2013 Annual Report*, edited by K. D. Baver, D. Behrend, and K. L. Armstrong, NASA/TP-2014-217522, 299–300, 2014.
- J. KODET, K. U. SCHREIBER, C. PLÖTZ, G. KRONSCHNABL, I. PROCHAZKA: “The New Phase-calibration System of the Geodetic Observatory Wettzell”. *International VLBI Service for Geodesy and Astrometry 2014 General Meeting Proceedings ‘VGOS: The New VLBI Network’*, edited by D. Behrend, K. D. Baver, and K. L. Armstrong, Science Press (Beijing), ISBN 978-7-03-042974-2, 122–125, 2014.
- J. KODET, K. U. SCHREIBER, C. PLÖTZ, A. NEIDHARDT, G. KRONSCHNABL, R. HAAS, G. MOLERA CALVÉS, S. POGREBENKO, M. ROTHACHER, B. MÄNNEL, L. PLANK, A. HELLERSCHMIED: “Co-locations of Space Geodetic Techniques on Ground and in Space”. *International VLBI Service for Geodesy and Astrometry 2014 General Meeting Proceedings ‘VGOS: The New VLBI Network’*, edited by D. Behrend, K. D. Baver, and K. L. Armstrong, Science Press (Beijing), ISBN 978-7-03-042974-2, 446–450, 2014.
- T. KONDO AND K. TAKEFUJI: “On a Wide-Band Bandwidth Feed”. *IVS NICT Technology Development Center News*, No. 34, ISSN 1882-3432, 23–27, 2014.
- H. KRÁSNÁ AND J. BÖHM: “Impact of Seasonal Surface Displacement on Earth Rotation and Global Reference Frames”. *International VLBI Service for Geodesy and Astrometry 2014 General Meeting Proceedings ‘VGOS: The New VLBI Network’*, edited by D. Behrend, K. D. Baver, and K. L. Armstrong, Science Press (Beijing), ISBN 978-7-03-042974-2, 349–353, 2014.
- H. KRÁSNÁ, J. BÖHM, L. PLANK, T. NILSSON, H. SCHUH: “Atmospheric Effects on VLBI-Derived Terrestrial and Celestial Reference Frames”. In: *‘Earth on the Edge: Science for a Sustainable Planet’*, edited by C. Rizos and P. Willis, IAG Symposium, 139, Springer, ISBN 978-3-642-37221-6, 203–208, 2014.
- H. KRÁSNÁ, Z. MALKIN, J. BÖHM: “Impact of Seasonal Station Displacement Models on Radio Source Positions”. *Proceedings of the Journées 2013 ‘Systèmes de Référence Spatio-Temporels’*, edited by N. Capitaine, Observatoire de Paris, 65–68, ISBN 978-2-901057-69-7, 2014.
- H. KRÁSNÁ, M. NICKOLA, J. BÖHM: “Axis Offset Estimation of VLBI Telescopes”. *International VLBI Service for Geodesy and Astrometry 2014 General Meeting Proceedings ‘VGOS: The New VLBI Network’*, edited by D. Behrend, K. D. Baver, and K. L. Armstrong, Science Press (Beijing), ISBN 978-7-03-042974-2, 339–343, 2014.
- G. KRONSCHNABL, T. SCHÜLER, A. NEIDHARDT, C. PLÖTZ, T. KLÜGEL, J. KODET: “Status of the Wettzell Radio Telescope Triple and the O’Higgins VLBI System at Antarctica”. *International VLBI Service for Geodesy and Astrometry 2014 General Meeting Proceedings ‘VGOS: The New VLBI Network’*, edited by D. Behrend, K. D. Baver, and K. L. Armstrong, Science Press (Beijing), ISBN 978-7-03-042974-2, 145–149, 2014.
- S. KURDUBOV AND G. ILIN: “Using External Tropospheric Delay in VLBI Data Processing”. *International VLBI Service for Geodesy and Astrometry 2014 General Meeting Proceedings ‘VGOS: The New VLBI Network’*, edited by D. Behrend, K. D. Baver, and K. L. Armstrong, Science Press (Beijing), ISBN 978-7-03-042974-2, 277–278, 2014.
- S. KURDUBOV AND A. MELNIKOV: “Comparison of Russian Ru-U and IVS Intensive Series”. *International VLBI Service for Geodesy and Astrometry 2014 General Meeting Proceedings ‘VGOS: The New VLBI Network’*, edited by D. Behrend, K. D. Baver, and K. L. Armstrong, Science Press (Beijing), ISBN 978-7-03-042974-2, 321–324, 2014.
- S. KURDUBOV AND E. SKURIKHINA: “On the Selection of Core Sources”. *International VLBI*

- Service for Geodesy and Astrometry 2014 General Meeting Proceedings ‘VGOS: The New VLBI Network’, edited by D. Behrend, K. D. Baver, and K. L. Armstrong, Science Press (Beijing), ISBN 978-7-03-042974-2, 399–401, 2014.
- S. KURIHARA AND T. HARA: “Tsukuba VLBI Analysis Center”. International VLBI Service for Geodesy and Astrometry 2013 Annual Report, edited by K. D. Baver, D. Behrend, and K. L. Armstrong, NASA/TP-2014-217522, 321–324, 2014.
- S. KURIHARA AND T. HARA: “Tsukuba VLBI Correlator”. International VLBI Service for Geodesy and Astrometry 2013 Annual Report, edited by K. D. Baver, D. Behrend, and K. L. Armstrong, NASA/TP-2014-217522, 227–230, 2014.
- Y. KWAK AND J. CHO: “KASI Combination Center 2013 Annual Report”. International VLBI Service for Geodesy and Astrometry 2013 Annual Report, edited by K. D. Baver, D. Behrend, and K. L. Armstrong, NASA/TP-2014-217522, 288–291, 2014.
- S. LAMBERT, C. BARACHE, C. GATTANO: “Paris Observatory (OPAR) Analysis Center”. International VLBI Service for Geodesy and Astrometry 2013 Annual Report, edited by K. D. Baver, D. Behrend, and K. L. Armstrong, NASA/TP-2014-217522, 301–303, 2014.
- L. LANGKAAS AND A. JØRGENSEN: “UN Resolution About the Importance of Geodesy: A Global Geodetic Reference Frame for Sustainable Development (GGRF)”. International VLBI Service for Geodesy and Astrometry 2014 General Meeting Proceedings ‘VGOS: The New VLBI Network’, edited by D. Behrend, K. D. Baver, and K. L. Armstrong, Science Press (Beijing), ISBN 978-7-03-042974-2, 8–10, 2014.
- R. LANOTTE: “Matera CGS VLBI Analysis Center”. International VLBI Service for Geodesy and Astrometry 2013 Annual Report, edited by K. D. Baver, D. Behrend, and K. L. Armstrong, NASA/TP-2014-217522, 261–262, 2014.
- L. LA PORTA, W. ALEF, A. BERTARINI, S. BERNHART, G. BRUNI, A. MÜSKENS, H. ROTTMANN, A. ROY, G. TUCCARI: “The Bonn Astro/Geo Correlator”. International VLBI Service for Geodesy and Astrometry 2013 Annual Report, edited by K. D. Baver, D. Behrend, and K. L. Armstrong, NASA/TP-2014-217522, 209–212, 2014.
- K. LE BAIL, D. GORDON, J. GIPSON: “Evaluation of the Stability of ICRF2 in the Past Five Years Using the Allan Variance”. International VLBI Service for Geodesy and Astrometry 2014 General Meeting Proceedings ‘VGOS: The New VLBI Network’, edited by D. Behrend, K. D. Baver, and K. L. Armstrong, Science Press (Beijing), ISBN 978-7-03-042974-2, 395–398, 2014.
- J. LI AND F. XIONG: “Local Survey at the Shanghai Tianma 65-m Antenna”. International VLBI Service for Geodesy and Astrometry 2014 General Meeting Proceedings ‘VGOS: The New VLBI Network’, edited by D. Behrend, K. D. Baver, and K. L. Armstrong, Science Press (Beijing), ISBN 978-7-03-042974-2, 168–172, 2014.
- L. LIU, R. HEINKELMANN, V. TORNATORE, R. HAAS, A. NEIDHARDT, D. DUEV, J. KODET, J. LI, T. NILSSON, M. XU, C. PLÖTZ, U. SCHREIBER, S. POGREBENKO, G. KRONSCHNABL, J. A. MORA-DIAZ, B. SOJA, M. KARBON, C. LU, V. RAPOSO-PULIDO, H. SCHUH: “New Progress in VLBI Tracking of GNSS Satellites at GFZ”. International VLBI Service for Geodesy and Astrometry 2014 General Meeting Proceedings ‘VGOS: The New VLBI Network’, edited by D. Behrend, K. D. Baver, and K. L. Armstrong, Science Press (Beijing), ISBN 978-7-03-042974-2, 456–460, 2014.
- J. A. LÓPEZ-FERNÁNDEZ, E. GARCÍA, A. RIVERA-LAVADO, S. LLORENTE-ROMANO, F. J. HERRÁIZ-MARTÍNEZ, J. MONTERO-DEPAZ, M. MÉNDEZ-ALLER, L. SANTOS, J. M. SERNA-PUENTE, J. A. LÓPEZ-PÉREZ, F. TERCERO: “A Dual-Circular Polarization Broadband Feed for Ring Focus Configuration”. International VLBI Service for Geodesy and Astrometry 2014 General Meeting Proceedings ‘VGOS: The New VLBI Network’, edited by D. Behrend, K. D. Baver, and K. L. Armstrong, Science Press (Beijing), ISBN 978-7-03-042974-2, 68–72, 2014.
- J. A. LÓPEZ-PÉREZ, J. A. LÓPEZ-FERNÁNDEZ, F. TERCERO, B. VAQUERO, J. M. SERNA: “A Tri-band Cryogenic Receiver for VGOS Radio Telescopes”. International VLBI Service for Geodesy and Astrometry 2014 General Meeting Proceedings ‘VGOS: The New VLBI Network’, edited by

- D. Behrend, K. D. Baver, and K. L. Armstrong, Science Press (Beijing), ISBN 978-7-03-042974-2, 115–117, 2014.
- T. LOSSIN, M. LÖSLER, A. NEIDHARDT, R. LEHMANN, S. MÄHLER: “The Usage of Recursive Parameter Estimation in Automated Reference Point Determination”. International VLBI Service for Geodesy and Astrometry 2014 General Meeting Proceedings ‘VGOS: The New VLBI Network’, edited by D. Behrend, K. D. Baver, and K. L. Armstrong, Science Press (Beijing), ISBN 978-7-03-042974-2, 344–348, 2014.
- J. LOVELL, J. DICKEY, B. REID, J. MCCALLUM, S. SHABALA, C. WATSON, L. PLANK, S. ELLINGSEN, A. MEMIN: “AuScope VLBI Project and Hobart 26-m Antenna”. International VLBI Service for Geodesy and Astrometry 2013 Annual Report, edited by K. D. Baver, D. Behrend, and K. L. Armstrong, NASA/TP-2014-217522, 115–118, 2014.
- J. LOVELL, J. MCCALLUM, S. SHABALA, L. PLANK, J. BÖHM, D. MAYER, J. SUN: “Dynamic Observing in the VGOS Era”. International VLBI Service for Geodesy and Astrometry 2014 General Meeting Proceedings ‘VGOS: The New VLBI Network’, edited by D. Behrend, K. D. Baver, and K. L. Armstrong, Science Press (Beijing), ISBN 978-7-03-042974-2, 43–47, 2014.
- J. LOVELL, S. SHABALA, J. MCCALLUM, J. DICKEY, L. PLANK, C. REYNOLDS, S. GULYAEV, T. NATUSCH, S. WESTON, J. QUICK, J. BÖHM, J. SUN, O. TITOV, P. LOVELL, S. LOVELL: “Southern Hemisphere Geodesy and Astrometry with AUSTRAL”. International VLBI Service for Geodesy and Astrometry 2014 General Meeting Proceedings ‘VGOS: The New VLBI Network’, edited by D. Behrend, K. D. Baver, and K. L. Armstrong, Science Press (Beijing), ISBN 978-7-03-042974-2, 191–195, 2014.
- C. LU, R. HEINKELMANN, J. A. MORA-DIAZ, C. SCHWATKE, T. NILSSON, L. LIU, M. KARBON, V. RAPOSO-PULIDO, B. SOJA, H. SCHUH: “IVS Rapid Tropospheric Parameter Re-combination and Comparison with GNSS Products”. International VLBI Service for Geodesy and Astrometry 2014 General Meeting Proceedings ‘VGOS: The New VLBI Network’, edited by D. Behrend, K. D. Baver, and K. L. Armstrong, Science Press (Beijing), ISBN 978-7-03-042974-2, 354–358, 2014.
- C. MA, S. MERKOWITZ, B. LUZUM: “The Impact of NASA’s SGP and USNO on VGOS”. International VLBI Service for Geodesy and Astrometry 2014 General Meeting Proceedings ‘VGOS: The New VLBI Network’, edited by D. Behrend, K. D. Baver, and K. L. Armstrong, Science Press (Beijing), ISBN 978-7-03-042974-2, 3–7, 2014.
- H. MA, X. LIAN, X. SHI, Z. CHEN, S. WEI: “Research on Deep Space TT&C VLBI Digital Baseband Converting Methods Based on Parallel Down-conversion”. International VLBI Service for Geodesy and Astrometry 2014 General Meeting Proceedings ‘VGOS: The New VLBI Network’, edited by D. Behrend, K. D. Baver, and K. L. Armstrong, Science Press (Beijing), ISBN 978-7-03-042974-2, 106–110, 2014.
- M. MA, W. ZHENG, Y. HUANG, G. WANG: “The XF-Type Correlator for Delta-DOR in Deep Space Navigation”. International VLBI Service for Geodesy and Astrometry 2014 General Meeting Proceedings ‘VGOS: The New VLBI Network’, edited by D. Behrend, K. D. Baver, and K. L. Armstrong, Science Press (Beijing), ISBN 978-7-03-042974-2, 236–239, 2014.
- M. MADZAK, S. BÖHM, J. BÖHM, W. BOSCH, J. HAGEDOORN, H. SCHUH: “A New Empirical Ocean Tide Model for Improved High-Frequency Earth Rotation Variations”. International VLBI Service for Geodesy and Astrometry 2014 General Meeting Proceedings ‘VGOS: The New VLBI Network’, edited by D. Behrend, K. D. Baver, and K. L. Armstrong, Science Press (Beijing), ISBN 978-7-03-042974-2, 293–297, 2014.
- Z. MALKIN: “On the Accuracy of the Theory of Precession and Nutation”. *Astronomy Reports*, 58(6), DOI: 10.1134/S1063772914060043, 415–425, 2014.
- Z. MALKIN: “On the implications of the Galactic aberration in proper motions for the Celestial Reference Frame”. *Monthly Notices of the Royal Astronomical Society (MNRAS)*, 445(1), DOI: 10.1093/mnras/stu1796, 845–849, 2014.
- Z. MALKIN: “On the Galactic aberration constant”. Proceedings of the Journées 2013 “Systèmes de Référence Spatio-Temporels”, edited by N.

- Capitaine, Observatoire de Paris, 44–45, ISBN 978-2-901057-69-7, 2014.
- Z. MALKIN: “On errors of radio source position catalogs”. Proceedings of the Journées 2013 “Systèmes de Référence Spatio-Temporels”, edited by N. Capitaine, Observatoire de Paris, 69–72, ISBN 978-2-901057-69-7, 2014.
- Z. MALKIN: “On detection of the free inner core nutation from VLBI data”. Proceedings of the Journées 2013 “Systèmes de Référence Spatio-Temporels”, edited by N. Capitaine, Observatoire de Paris, 224–225, ISBN 978-2-901057-69-7, 2014.
- Z. MALKIN AND Y. SOKOLOVA: “Pulkovo IVS Analysis Center (PUL) 2013 Annual Report”. International VLBI Service for Geodesy and Astrometry 2013 Annual Report, edited by K. D. Baver, D. Behrend, and K. L. Armstrong, NASA/TP-2014-217522, 312–315, 2014.
- B. MÄNNEL, M. ROTHACHER, J. KODET, U. SCHREIBER, R. SCHMID: “GLONASS Satellites Simultaneously Observed by VLBI, GNSS, and SLR”. International VLBI Service for Geodesy and Astrometry 2014 General Meeting Proceedings ‘VGOS: The New VLBI Network’, edited by D. Behrend, K. D. Baver, and K. L. Armstrong, Science Press (Beijing), ISBN 978-7-03-042974-2, 461–465, 2014.
- D. MAYER, J. BÖHM, L. COMBRINCK, J. BOTAI, S. BÖHM: “Importance of the Hartebeesthoek Radio Astronomy Observatory for the VLBI network”. *Acta Geodaetica et Geophysica*, 49(3), 313–325, DOI 10.1007/s40328-014-0063-7, 2014.
- A. MELNIKOV, A. BERDNIKOV, S. GREKOV, D. MARSHALOV, A. MIKHAILOV, E. NOSOV, L. FEDOTOV: “First Fringes with BRAS on VLBI Network ‘Quasar’”. International VLBI Service for Geodesy and Astrometry 2014 General Meeting Proceedings ‘VGOS: The New VLBI Network’, edited by D. Behrend, K. D. Baver, and K. L. Armstrong, Science Press (Beijing), ISBN 978-7-03-042974-2, 134–137, 2014.
- M. MIYOSHI: “A New Verification Method of Applied Calibrations onto Visibility Data”. IVS NICT Technology Development Center News, No. 34, ISSN 1882-3432, 3–5, 2014.
- J. A. MORA-DIAZ, V. RAPOSO-PULIDO, R. HEINKELMANN, M. XU, T. NILSSON, M. KAR-BON, L. LIU, B. SOJA, C. LU, H. SCHUH: “Modeling Special Handling Source Positions in the GFZ VLBI Solution”. International VLBI Service for Geodesy and Astrometry 2014 General Meeting Proceedings ‘VGOS: The New VLBI Network’, edited by D. Behrend, K. D. Baver, and K. L. Armstrong, Science Press (Beijing), ISBN 978-7-03-042974-2, 402–406, 2014.
- A. NEIDHARDT AND A. COLLIOD: “Real-time Data Streams from ‘e-RemoteCtrl’ to Central VLBI Network Status Monitoring Services Like IVS Live”. International VLBI Service for Geodesy and Astrometry 2014 General Meeting Proceedings ‘VGOS: The New VLBI Network’, edited by D. Behrend, K. D. Baver, and K. L. Armstrong, Science Press (Beijing), ISBN 978-7-03-042974-2, 262–266, 2014.
- A. NEIDHARDT, G. KRONSCHNABL, R. SCHATZ, T. SCHÜLER: “Geodetic Observatory Wettzell – 20-m Radio Telescope and Twin Telescopes”. International VLBI Service for Geodesy and Astrometry 2013 Annual Report, edited by K. D. Baver, D. Behrend, and K. L. Armstrong, NASA/TP-2014-217522, 187–190, 2014.
- A. NEIDHARDT, C. PLÖTZ, T. KLÜGEL, T. SCHÜLER: “German Antarctic Receiving Station (GARS) O’Higgins”. International VLBI Service for Geodesy and Astrometry 2013 Annual Report, edited by K. D. Baver, D. Behrend, and K. L. Armstrong, NASA/TP-2014-217522, 148–150, 2014.
- A. NEIDHARDT, M. SCHÖNBERGER, C. PLÖTZ, G. KRONSCHNABL: “Developments for the Automation and Remote Control of the Radio Telescopes of the Geodetic Observatory Wettzell”. International VLBI Service for Geodesy and Astrometry 2014 General Meeting Proceedings ‘VGOS: The New VLBI Network’, edited by D. Behrend, K. D. Baver, and K. L. Armstrong, Science Press (Beijing), ISBN 978-7-03-042974-2, 48–52, 2014.
- M. NEGUSINI AND P. SARTI: “Italy INAF Analysis Center”. International VLBI Service for Geodesy and Astrometry 2013 Annual Report, edited by K. D. Baver, D. Behrend, and K. L. Armstrong, NASA/TP-2014-217522, 283–284, 2014.
- M. NEGUSINI AND P. SARTI: “Italy INAF Data Center Report”. International VLBI Service for

- Geodesy and Astrometry 2013 Annual Report, edited by K. D. Baver, D. Behrend, and K. L. Armstrong, NASA/TP-2014-217522, 240, 2014.
- M. NICKOLA, J. QUICK, L. COMBRINCK: “Hartebeesthoek Radio Astronomy Observatory (HARTRAO)”. International VLBI Service for Geodesy and Astrometry 2013 Annual Report, edited by K. D. Baver, D. Behrend, and K. L. Armstrong, NASA/TP-2014-217522, 111–114, 2014.
- A. NIELL, C. BEAUDOIN, S. BOLOTIN, R. CAPPALLO, B. COREY, J. GIPSON, D. GORDON, R. MCWHIRTER, C. RUSZCZYK, J. SOOHOO: “VGOS Operations and Geodetic Results”. International VLBI Service for Geodesy and Astrometry 2014 General Meeting Proceedings ‘VGOS: The New VLBI Network’, edited by D. Behrend, K. D. Baver, and K. L. Armstrong, Science Press (Beijing), ISBN 978-7-03-042974-2, 97–101, 2014.
- A. NIELL, R. CAPPALLO, B. COREY, J. SOOHOO, M. TITUS: “Haystack Observatory Analysis Center”. International VLBI Service for Geodesy and Astrometry 2013 Annual Report, edited by K. D. Baver, D. Behrend, and K. L. Armstrong, NASA/TP-2014-217522, 276–279, 2014.
- T. NILSSON, B. SOJA, M. KARBON, R. HEINKELMANN, L. LIU, C. LU, J. A. MORA-DIAZ, V. RAPOSO-PULIDO, M. XU, H. SCHUH: “Atmospheric Modeling in the Data Analysis of Twin Telescope Observations”. International VLBI Service for Geodesy and Astrometry 2014 General Meeting Proceedings ‘VGOS: The New VLBI Network’, edited by D. Behrend, K. D. Baver, and K. L. Armstrong, Science Press (Beijing), ISBN 978-7-03-042974-2, 36–39, 2014.
- T. NILSSON, B. SOJA, M. KARBON, R. HEINKELMANN, L. LIU, C. LU, J. A. MORA-DIAZ, V. RAPOSO-PULIDO, M. XU, H. SCHUH: “Tropospheric Modeling for the Intensive Sessions”. International VLBI Service for Geodesy and Astrometry 2014 General Meeting Proceedings ‘VGOS: The New VLBI Network’, edited by D. Behrend, K. D. Baver, and K. L. Armstrong, Science Press (Beijing), ISBN 978-7-03-042974-2, 288–292, 2014.
- T. NING, R. HAAS, G. ELGERED: “Determination of the Telescope Invariant Point and the Local Tie Vector at Onsala using GPS Measurements”. International VLBI Service for Geodesy and Astrometry 2014 General Meeting Proceedings ‘VGOS: The New VLBI Network’, edited by D. Behrend, K. D. Baver, and K. L. Armstrong, Science Press (Beijing), ISBN 978-7-03-042974-2, 163–167, 2014.
- C. NOLL: “CDDIS Data Center Summary for the IVS 2013 Annual Report”. International VLBI Service for Geodesy and Astrometry 2013 Annual Report, edited by K. D. Baver, D. Behrend, and K. L. Armstrong, NASA/TP-2014-217522, 237–239, 2014.
- E. NOSOV, A. BERDNIKOV, S. GREKOV, D. MARSHALOV, A. MELNIKOV, L. FEDOTOV: “Current Development State of the Russian VLBI Broadband Acquisition System”. International VLBI Service for Geodesy and Astrometry 2014 General Meeting Proceedings ‘VGOS: The New VLBI Network’, edited by D. Behrend, K. D. Baver, and K. L. Armstrong, Science Press (Beijing), ISBN 978-7-03-042974-2, 82–85, 2014.
- A. NOTHNAGEL AND A. MÜSKENS: “The Bonn Geodetic VLBI Operation Center”. International VLBI Service for Geodesy and Astrometry 2013 Annual Report, edited by K. D. Baver, D. Behrend, and K. L. Armstrong, NASA/TP-2014-217522, 201–202, 2014.
- A. NOTHNAGEL, A. SPRINGER, E. HEINZ, T. ARTZ, P. DE VICENTE: “Gravitational Deformation Effects: The Yebes 40-m Telescope Case”. International VLBI Service for Geodesy and Astrometry 2014 General Meeting Proceedings ‘VGOS: The New VLBI Network’, edited by D. Behrend, K. D. Baver, and K. L. Armstrong, Science Press (Beijing), ISBN 978-7-03-042974-2, 158–162, 2014.
- A. ORLATI, A. ORFEI, G. MACCAFERRI: “Medicina Station Status Report”. International VLBI Service for Geodesy and Astrometry 2013 Annual Report, edited by K. D. Baver, D. Behrend, and K. L. Armstrong, NASA/TP-2014-217522, 133–134, 2014.
- M. PANTALEEV, L. HELLDNER, B. BILLADE, M. IVASHINA, O. IUPIKOV, C. BENCIVENNI, J. YANG, P. S. KILDAL, T. EKEBRAND, J. JÖNSSON, Y. KARANDIKAR, A. EMRICH: “Broadband Feeds for VGOS”. International VLBI Service for Geodesy and Astrometry 2014 General Meeting Proceedings ‘VGOS: The New VLBI Network’, edited by D. Behrend, K. D. Baver, and K. L. Armstrong, Science Press (Beijing), ISBN 978-7-03-042974-2, 60–67, 2014.

- M. PANTALEEV, R. HAAS, B. BILLADE, L. HELLDNER, K. A. JOHANSSON, L. PETTERSON, M. IVASHINA, J. YANG, C. BENCIVENNI, O. IUPIKOV: "Onsala Space Observatory – IVS Technology Development Center Activities during 2013". International VLBI Service for Geodesy and Astrometry 2013 Annual Report, edited by K. D. Baver, D. Behrend, and K. L. Armstrong, NASA/TP-2014-217522, 349–352, 2014.
- E. PARSELIA, T. NILSSON, R. HEINKELMANN, A. GEBAUER, T. KLÜGEL, U. SCHREIBER, H. SCHUH: "Earth Rotation Determination by Combining Ring Laser Gyroscopes and VLBI". International VLBI Service for Geodesy and Astrometry 2014 General Meeting Proceedings 'VGOS: The New VLBI Network', edited by D. Behrend, K. D. Baver, and K. L. Armstrong, Science Press (Beijing), ISBN 978-7-03-042974-2, 495–499, 2014.
- B. PETRACHENKO: "Canadian VLBI Technology Development Center Report". International VLBI Service for Geodesy and Astrometry 2013 Annual Report, edited by K. D. Baver, D. Behrend, and K. L. Armstrong, NASA/TP-2014-217522, 337, 2014.
- B. PETRACHENKO: "IVS Technology Coordinator Report". International VLBI Service for Geodesy and Astrometry 2013 Annual Report, edited by K. D. Baver, D. Behrend, and K. L. Armstrong, NASA/TP-2014-217522, 95–98, 2014.
- B. PETRACHENKO, D. BEHREND, J. GIPSON, H. HASE, C. MA, D. MACMILLAN, A. NIELL, A. NOTHNAGEL, X. ZHANG: "VGOS Observing Plan". International VLBI Service for Geodesy and Astrometry 2014 General Meeting Proceedings 'VGOS: The New VLBI Network', edited by D. Behrend, K. D. Baver, and K. L. Armstrong, Science Press (Beijing), ISBN 978-7-03-042974-2, 16–19, 2014.
- B. PETRACHENKO, D. BEHREND, H. HASE, C. MA, A. NIELL, A. NOTHNAGEL, X. ZHANG: "Proposal for VGOS Observing Plan". International VLBI Service for Geodesy and Astrometry 2013 Annual Report, edited by K. D. Baver, D. Behrend, and K. L. Armstrong, NASA/TP-2014-217522, 70–79, 2014.
- B. PETRACHENKO AND A. WHITNEY: "VGOS Data Recorder Comparison". International VLBI Service for Geodesy and Astrometry 2013 Annual Report, edited by K. D. Baver, D. Behrend, and K. L. Armstrong, NASA/TP-2014-217522, 64–69, 2014.
- L. PLANK, J. B'OHM, H. SCHUH: "Precise station positions from VLBI observations to satellites: a simulation study". *Journal of Geodesy*, 88(7), 659–673, doi:10.1007/s00190-014-0712-1, 2014.
- M. POIRIER: "Westford Antenna 2013 Annual Report". International VLBI Service for Geodesy and Astrometry 2013 Annual Report, edited by K. D. Baver, D. Behrend, and K. L. Armstrong, NASA/TP-2014-217522, 184–186, 2014.
- V. RAPOSO-PULIDO, R. HEINKELMANN, J. A. MORA-DIAZ, M. XU, T. NILSSON, M. KARBON, L. LIU, C. LU, B. SOJA, H. SCHUH: "Datum Effects on the Stability of the Celestial Reference Frame Determined by VLBI". International VLBI Service for Geodesy and Astrometry 2014 General Meeting Proceedings 'VGOS: The New VLBI Network', edited by D. Behrend, K. D. Baver, and K. L. Armstrong, Science Press (Beijing), ISBN 978-7-03-042974-2, 407–411, 2014.
- T. P. REN, G. S. TANG, A. X. ZHANG, L. CHEN, S. T. HAN, Y. T. DAI: "Phase-based Radiometric System in Lunar Radio Measurements". International VLBI Service for Geodesy and Astrometry 2014 General Meeting Proceedings 'VGOS: The New VLBI Network', edited by D. Behrend, K. D. Baver, and K. L. Armstrong, Science Press (Beijing), ISBN 978-7-03-042974-2, 478–481, 2014.
- Y. SANGO, A. KIDUK, O. HONGJONG, H. SANGCHEOL: "Korea Geodetic VLBI Station, Sejong". International VLBI Service for Geodesy and Astrometry 2013 Annual Report, edited by K. D. Baver, D. Behrend, and K. L. Armstrong, NASA/TP-2014-217522, 155–157, 2014.
- R. SCHMID, M. GERSTL, M. SEITZ, D. ANGERMANN: "DGFI Analysis Center Annual Report 2013". International VLBI Service for Geodesy and Astrometry 2013 Annual Report, edited by K. D. Baver, D. Behrend, and K. L. Armstrong, NASA/TP-2014-217522, 263–264, 2014.
- M. SEITZ, P. STEIGENBERGER, T. ARTZ: "Consistent Adjustment of Combined Terrestrial and Celestial Reference Frames". In: 'Earth on the Edge: Science for a Sustainable Planet', edited by C. Rizos and P.

- Willis, IAG Symposia, 139, Springer, ISBN 978-3-642-37221-6, 215–221, 2014.
- M. SEKIDO AND E. KAWAI: “Kashima 34-m VLBI Station”. International VLBI Service for Geodesy and Astrometry 2013 Annual Report, edited by K. D. Baver, D. Behrend, and K. L. Armstrong, NASA/TP-2014-217522, 119–122, 2014.
- M. SEKIDO AND E. KAWAI: “Kashima and Koganei 11-m VLBI Stations”. International VLBI Service for Geodesy and Astrometry 2013 Annual Report, edited by K. D. Baver, D. Behrend, and K. L. Armstrong, NASA/TP-2014-217522, 126–129, 2014.
- M. SEKIDO, K. TAKEFUJI, M. TSUTSUMI: “Correlation Processing in NICT Kashima”. International VLBI Service for Geodesy and Astrometry 2013 Annual Report, edited by K. D. Baver, D. Behrend, and K. L. Armstrong, NASA/TP-2014-217522, 221–223, 2014.
- M. SEKIDO, K. TAKEFUJI, H. UJIHARA, M. TSUTSUMI, Y. MIYAUCHI, S. HASEGAWA, T. HOBIGER, R. ICHIKAWA, Y. KOYAMA: “Development of a Wideband VLBI System (GALA-V)”. International VLBI Service for Geodesy and Astrometry 2014 General Meeting Proceedings ‘VGOS: The New VLBI Network’, edited by D. Behrend, K. D. Baver, and K. L. Armstrong, Science Press (Beijing), ISBN 978-7-03-042974-2, 77–81, 2014.
- M. SEKIDO, K. TAKEFUJI, H. UJIHARA, M. TSUTSUMI, S. HASEGAWA, Y. MIYAUCHI, E. KAWAI, R. ICHIKAWA, Y. KOYAMA, T. KONDO: “Status of Broadband VLBI Observation System (Gala-V) Development”. IVS NICT Technology Development Center News, No. 34, ISSN 1882-3432, 17–19, 2014.
- S. SHABALA, J. MCCALLUM, L. PLANK, J. BÖHM: “Simulating the Effects of Quasar Structure on VLBI Observations”. International VLBI Service for Geodesy and Astrometry 2014 General Meeting Proceedings ‘VGOS: The New VLBI Network’, edited by D. Behrend, K. D. Baver, and K. L. Armstrong, Science Press (Beijing), ISBN 978-7-03-042974-2, 421–425, 2014.
- S. SHABALA, J. ROGERS, J. MCCALLUM, O. TITOV, J. BLANCHARD, J. LOVELL, C. WATSON: “The Effects of Frequency-dependent Quasar Evolution on the Celestial Reference Frame”. *Journal of Geodesy*, 88(6), 575–586, 2014.
- Z. SHEN, Q. FAN, Q. LIU, X. HONG, B. XIA: “Sheshan VLBI Station Report for 2013”. International VLBI Service for Geodesy and Astrometry 2013 Annual Report, edited by K. D. Baver, D. Behrend, and K. L. Armstrong, NASA/TP-2014-217522, 158–159, 2014.
- F. SHU, W. ZHENG, W. JIANG, Z. CHEN, R. ZHU: “Shanghai VLBI Correlator 2013 Annual Report”. International VLBI Service for Geodesy and Astrometry 2013 Annual Report, edited by K. D. Baver, D. Behrend, and K. L. Armstrong, NASA/TP-2014-217522, 224–226, 2014.
- M. SIEBER: “Ny-Ålesund Geodetic Observatory 2013 Annual Report”. International VLBI Service for Geodesy and Astrometry 2013 Annual Report, edited by K. D. Baver, D. Behrend, and K. L. Armstrong, NASA/TP-2014-217522, 145–147, 2014.
- E. SKURIKHINA, S. KURDUBOV, V. GUBANOV, D. SHIGAEV: “IAA VLBI Analysis Center Report 2013”. International VLBI Service for Geodesy and Astrometry 2013 Annual Report, edited by K. D. Baver, D. Behrend, and K. L. Armstrong, NASA/TP-2014-217522, 280–282, 2014.
- S. SMOLENTSEV AND A. DYAKOV: “Zelenchukskaya Radio Astronomical Observatory 2013 Annual Report”. International VLBI Service for Geodesy and Astrometry 2013 Annual Report, edited by K. D. Baver, D. Behrend, and K. L. Armstrong, NASA/TP-2014-217522, 195–197, 2014.
- S. SMOLENTSEV AND V. OLIFIROV: “Badary Radio Astronomical Observatory 2013 IVS Annual Report”. International VLBI Service for Geodesy and Astrometry 2013 Annual Report, edited by K. D. Baver, D. Behrend, and K. L. Armstrong, NASA/TP-2014-217522, 101–103, 2014.
- S. SMOLENTSEV AND I. RAHIMOV: “Svetloe Radio Astronomical Observatory 2013 IVS Annual Report”. International VLBI Service for Geodesy and Astrometry 2013 Annual Report, edited by K. D. Baver, D. Behrend, and K. L. Armstrong, NASA/TP-2014-217522, 164–166, 2014.
- B. SOJA, R. HEINKELMANN, H. SCHUH: “Investigations of the Solar Corona by VLBI”. International VLBI Service for Geodesy and Astrometry

- 2014 General Meeting Proceedings ‘VGOS: The New VLBI Network’, edited by D. Behrend, K. D. Baver, and K. L. Armstrong, Science Press (Beijing), ISBN 978-7-03-042974-2, 368–372, 2014.
- Y. SOKOLOVA, Z. MALKIN: “Pulkovo Combined Catalogue of Radio Source Positions PUL 2013”. *Astronomy Letters*, 40(5), DOI: 10.1134/S1063773714050041, 268–277, 2014.
- Y. SOKOLOVA, Z. MALKIN: “Erratum to: ‘Pulkovo Combined Catalogue of Radio Source Positions PUL 2013’ [Astron. Lett. 40, 268 (2014)]”. *Astronomy Letters*, 40(12), DOI: 10.1134/S106377371412007X, 829, 2014.
- J. SUN, J. BÖHM, T. NILSSON, H. KRÁSNA, S. BÖHM, H. SCHUH: “New VLBI2010 scheduling strategies and implications on the terrestrial reference frames”. *Journal of Geodesy*, 88(5), 449–461, doi:10.1007/s00190-014-0697-9, 2014.
- J. SUN, H. SCHUH, G. TANG: “Simulations of Minimum Elongation from the Sun”. *International VLBI Service for Geodesy and Astrometry 2014 General Meeting Proceedings ‘VGOS: The New VLBI Network’*, edited by D. Behrend, K. D. Baver, and K. L. Armstrong, Science Press (Beijing), ISBN 978-7-03-042974-2, 364–367, 2014.
- I. SURKIS, V. KEN, Y. KURDUBOVA, A. MELNIKOV, V. MISHIN, D. PAVLOV, N. SOKOLOVA, V. SHANTYR, V. ZIMOVSKY: “IAA Correlator Center 2013 Annual Report”. *International VLBI Service for Geodesy and Astrometry 2013 Annual Report*, edited by K. D. Baver, D. Behrend, and K. L. Armstrong, NASA/TP-2014-217522, 217–220, 2014.
- K. TAKEFUJI, M. SEKIDO, H. UJIHARA, M. TSUTSUMI, S. HASEGAWA, T. KONDO: “Development of digital filters toward GHz-width VLBI”. *IVS NICT Technology Development Center News*, No. 34, ISSN 1882-3432, 20–22, 2014.
- K. TAKEFUJI AND H. UJIHARA: “NICT Technology Development Center 2013 Annual Report”. *International VLBI Service for Geodesy and Astrometry 2013 Annual Report*, edited by K. D. Baver, D. Behrend, and K. L. Armstrong, NASA/TP-2014-217522, 345–348, 2014.
- S. TAKEKAWA, T. OKA, M. SEKIDO: “Flux monitoring observations of Sgr A* at S and X bands with the NICT Kashima–Koganei VLBI System II”. *IVS NICT Technology Development Center News*, No. 34, ISSN 1882-3432, 1–2, 2014.
- H. TAKIGUCHI, S. WESTON, T. NATUSCH, S. GULYAEV: “Warkworth Radio Astronomy Observatory, New Zealand”. *International VLBI Service for Geodesy and Astrometry 2013 Annual Report*, edited by K. D. Baver, D. Behrend, and K. L. Armstrong, NASA/TP-2014-217522, 180–183, 2014.
- G. TANG, J. CAO, S. HAN, S. HU, T. REN, L. CHEN, J. SUN, M. WANG, Y. LI, L. LI: “Research on Lunar Radio Measurements by Chang’E-3”. *International VLBI Service for Geodesy and Astrometry 2014 General Meeting Proceedings ‘VGOS: The New VLBI Network’*, edited by D. Behrend, K. D. Baver, and K. L. Armstrong, Science Press (Beijing), ISBN 978-7-03-042974-2, 473–477, 2014.
- L. M. TANGEN: “New Geodetic Observatory in Ny-Ålesund”. *International VLBI Service for Geodesy and Astrometry 2014 General Meeting Proceedings ‘VGOS: The New VLBI Network’*, edited by D. Behrend, K. D. Baver, and K. L. Armstrong, Science Press (Beijing), ISBN 978-7-03-042974-2, 155–157, 2014.
- E. TANIR KAYIKÇI AND K. TEKE: “KTU-GEOD IVS Analysis Center Annual Report 2013”. *International VLBI Service for Geodesy and Astrometry 2013 Annual Report*, edited by K. D. Baver, D. Behrend, and K. L. Armstrong, NASA/TP-2014-217522, 292–294, 2014.
- C. THOMAS, D. BEHREND, E. HIMWICH: “Evolution of the Geodetic Media Pool”. *International VLBI Service for Geodesy and Astrometry 2014 General Meeting Proceedings ‘VGOS: The New VLBI Network’*, edited by D. Behrend, K. D. Baver, and K. L. Armstrong, Science Press (Beijing), ISBN 978-7-03-042974-2, 201–204, 2014.
- C. THOMAS AND D. MACMILLAN: “CORE Operation Center 2013 Annual Report”. *International VLBI Service for Geodesy and Astrometry 2013 Annual Report*, edited by K. D. Baver, D. Behrend, and K. L. Armstrong, NASA/TP-2014-217522, 203–205, 2014.
- V. THORANDT, A. NOTHNAGEL, G. ENGELHARDT, D. ULLRICH, T. ARTZ, S. HALSIG, A. IDDINK, J. LEEK: “The BKG/IGGB VLBI Analysis Center”. *International VLBI Service for Geodesy*

- and Astrometry 2013 Annual Report, edited by K. D. Baver, D. Behrend, and K. L. Armstrong, NASA/TP-2014-217522, 268–271, 2014.
- V. THORANDT AND R. WOJZIAK: “BKG Data Center”. International VLBI Service for Geodesy and Astrometry 2013 Annual Report, edited by K. D. Baver, D. Behrend, and K. L. Armstrong, NASA/TP-2014-217522, 235–236, 2014.
- O. TITOV: “Geoscience Australia Analysis Center 2013 Annual Report”. International VLBI Service for Geodesy and Astrometry 2013 Annual Report, edited by K. D. Baver, D. Behrend, and K. L. Armstrong, NASA/TP-2014-217522, 251–252, 2014.
- O. TITOV, J. LOVELL, H. TAKEGUCHI, J. QUICK, S. SHABALA, J. MCCALLUM, J. SUN, J. DAWSON, A. DE WITT, C. REYNOLDS, H. BIGNALL, T. NATUSCH, S. WESTON, S. GULYAEV: “First Geodetic Results from the Australasian VLBI Network”. International VLBI Service for Geodesy and Astrometry 2014 General Meeting Proceedings ‘VGOS: The New VLBI Network’, edited by D. Behrend, K. D. Baver, and K. L. Armstrong, Science Press (Beijing), ISBN 978-7-03-042974-2, 317–320, 2014.
- M. TITUS, R. CAPPALLO, B. COREY, K. DUDEVOIR, A. NIELL, J. SOOHOO, A. WHITNEY: “Haystack Observatory VLBI Correlator”. International VLBI Service for Geodesy and Astrometry 2013 Annual Report, edited by K. D. Baver, D. Behrend, and K. L. Armstrong, NASA/TP-2014-217522, 213–216, 2014.
- V. TORNATORE: “PMD Analysis Center 2013 Annual Report”. International VLBI Service for Geodesy and Astrometry 2013 Annual Report, edited by K. D. Baver, D. Behrend, and K. L. Armstrong, NASA/TP-2014-217522, 308–311, 2014.
- D. TROFIMOV AND V. VITYAZEV: “Analysis Center of Saint Petersburg University”. International VLBI Service for Geodesy and Astrometry 2013 Annual Report, edited by K. D. Baver, D. Behrend, and K. L. Armstrong, NASA/TP-2014-217522, 249–250, 2014.
- G. TUCCARI: “Noto Station Status Report”. International VLBI Service for Geodesy and Astrometry 2013 Annual Report, edited by K. D. Baver, D. Behrend, and K. L. Armstrong, NASA/TP-2014-217522, 142–144, 2014.
- G. TUCCARI, W. ALEF, S. BUTTACCIO, S. CASEY, A. FELKE, M. LINDQVIST, M. WUNDERLICH: “DBBC3: An EVN and VGOS All-inclusive VLBI System”. International VLBI Service for Geodesy and Astrometry 2014 General Meeting Proceedings ‘VGOS: The New VLBI Network’, edited by D. Behrend, K. D. Baver, and K. L. Armstrong, Science Press (Beijing), ISBN 978-7-03-042974-2, 86–90, 2014.
- H. UJIHARA, K. TAKEFUJI, M. SEKIDO: “Development of Wideband Feed”. IVS NICT Technology Development Center News, No. 34, ISSN 1882-3432, 28–31, 2014.
- M. UUNILA, N. ZUBKO, M. POUTANEN, J. KALLUNKI, U. KALLIO: “Metsähovi Radio Observatory Network Station 2013 Annual Report”. International VLBI Service for Geodesy and Astrometry 2013 Annual Report, edited by K. D. Baver, D. Behrend, and K. L. Armstrong, NASA/TP-2014-217522, 135–138, 2014.
- A. E. VOLVACH, G. S. KURBASOVA: “The Simeiz Fundamental Geodynamics Area”. International VLBI Service for Geodesy and Astrometry 2013 Annual Report, edited by K. D. Baver, D. Behrend, and K. L. Armstrong, NASA/TP-2014-217522, 160–163, 2014.
- T. WAKASUGI AND R. KAWABATA: “Regular Geodetic VLBI Observation with a Wide-band Recording System”. IVS NICT Technology Development Center News, No. 34, ISSN 1882-3432, 11–13, 2014.
- T. WAKASUGI AND R. KAWABATA: “Status Report on the Tsukuba VLBI Station: Damage to the Substructure of the Antenna and Its Repair”. International VLBI Service for Geodesy and Astrometry 2014 General Meeting Proceedings ‘VGOS: The New VLBI Network’, edited by D. Behrend, K. D. Baver, and K. L. Armstrong, Science Press (Beijing), ISBN 978-7-03-042974-2, 150–154, 2014.
- T. WAKASUGI, R. KAWABATA, S. KURIHARA, Y. FUKUZAKI, J. KURODA, T. TANABE, S. MIZUNO, T. ISHIDA: “Tsukuba 32-m VLBI Station”. International VLBI Service for Geodesy and Astrometry 2013 Annual Report, edited by K. D. Baver, D. Behrend, and K. L. Armstrong, NASA/TP-2014-217522, 173–176, 2014.
- G. WANG: “An Introduction to the Sheshan VGOS Station Project”. International VLBI Service for

- Geodesy and Astrometry 2014 General Meeting Proceedings ‘VGOS: The New VLBI Network’, edited by D. Behrend, K. D. Baver, and K. L. Armstrong, Science Press (Beijing), ISBN 978-7-03-042974-2, 30–31, 2014.
- G. WANG, J. LI, M. XU, L. GUO, L. LIU, F. SHU, Z. QIAN, L. LI: “SHAO Analysis Center 2013 Annual Report”. International VLBI Service for Geodesy and Astrometry 2013 Annual Report, edited by K. D. Baver, D. Behrend, and K. L. Armstrong, NASA/TP-2014-217522, 318–320, 2014.
- J. WANG, G. WU, D. ZHANG, K. XU, X. OU: “Analysis of Error Sources of Very Long Baseline Interferometry in Deep Space Exploration”. International VLBI Service for Geodesy and Astrometry 2014 General Meeting Proceedings ‘VGOS: The New VLBI Network’, edited by D. Behrend, K. D. Baver, and K. L. Armstrong, Science Press (Beijing), ISBN 978-7-03-042974-2, 302–306, 2014.
- S. WEI, X. LIAN, X. HOU, H. MA, K. JIANG, Y. JIAO: “Research on VLBI Digital Baseband Converting Methods Combining the Efficient Uniform Channelization with the Orthogonal Mixing”. International VLBI Service for Geodesy and Astrometry 2014 General Meeting Proceedings ‘VGOS: The New VLBI Network’, edited by D. Behrend, K. D. Baver, and K. L. Armstrong, Science Press (Beijing), ISBN 978-7-03-042974-2, 138–142, 2014.
- A. WHITNEY, R. CAPPALLO, C. RUSZCZYK, J. SOOHOO, G. CREW: “Mark 6 16-Gbps Next-Generation VLBI Data System”. International VLBI Service for Geodesy and Astrometry 2014 General Meeting Proceedings ‘VGOS: The New VLBI Network’, edited by D. Behrend, K. D. Baver, and K. L. Armstrong, Science Press (Beijing), ISBN 978-7-03-042974-2, 126–129, 2014.
- K. XU, G. WU, X. OU, D. ZHANG, J. WANG: “ADOR Signal Correlation Processing Method”. International VLBI Service for Geodesy and Astrometry 2014 General Meeting Proceedings ‘VGOS: The New VLBI Network’, edited by D. Behrend, K. D. Baver, and K. L. Armstrong, Science Press (Beijing), ISBN 978-7-03-042974-2, 307–310, 2014.
- M. XU, R. HEINKELMANN, H. SCHUH, M. ZHAO, G. WANG: “The Acceleration of the Origin of the ICRF”. International VLBI Service for Geodesy and Astrometry 2014 General Meeting Proceedings ‘VGOS: The New VLBI Network’, edited by D. Behrend, K. D. Baver, and K. L. Armstrong, Science Press (Beijing), ISBN 978-7-03-042974-2, 412–416, 2014.
- M. XU AND G. WANG: “On the Definition of Aberration”. International VLBI Service for Geodesy and Astrometry 2014 General Meeting Proceedings ‘VGOS: The New VLBI Network’, edited by D. Behrend, K. D. Baver, and K. L. Armstrong, Science Press (Beijing), ISBN 978-7-03-042974-2, 490–494, 2014.
- Z. XU, J. GAN, S. GUO, X. ZHANG, R. ZHU, Y. WU, Y. XIANG: “Hardware Correlator Development at SHAO”. International VLBI Service for Geodesy and Astrometry 2014 General Meeting Proceedings ‘VGOS: The New VLBI Network’, edited by D. Behrend, K. D. Baver, and K. L. Armstrong, Science Press (Beijing), ISBN 978-7-03-042974-2, 228–230, 2014.
- D. ZHANG, G. WU, J. WANG: “Algorithm and Simulation Analysis of VLBI Data Correlation Processing”. International VLBI Service for Geodesy and Astrometry 2014 General Meeting Proceedings ‘VGOS: The New VLBI Network’, edited by D. Behrend, K. D. Baver, and K. L. Armstrong, Science Press (Beijing), ISBN 978-7-03-042974-2, 311–314, 2014.
- M. ZHANG AND A. YUSUP: “Nanshan VLBI Station Report 2013”. International VLBI Service for Geodesy and Astrometry 2013 Annual Report, edited by K. D. Baver, D. Behrend, and K. L. Armstrong, NASA/TP-2014-217522, 177–179, 2014.
- V. ZHAROV: “SAI VLBI Analysis Center 2013 Annual Report”. International VLBI Service for Geodesy and Astrometry 2013 Annual Report, edited by K. D. Baver, D. Behrend, and K. L. Armstrong, NASA/TP-2014-217522, 316–317, 2014.
- W. ZHENG, Y. HUANG, Z. CHEN, G. WANG, Q. LIU, F. TONG, P. LI, L. TONG, F. SHU: “Real-time and High-Accuracy VLBI in the CE-3 Mission”. International VLBI Service for Geodesy and Astrometry 2014 General Meeting Proceedings ‘VGOS: The New VLBI Network’, edited by D. Behrend, K. D. Baver, and K. L. Armstrong, Science Press (Beijing), ISBN 978-7-03-042974-2, 466–472, 2014.

- W. ZHENG, J. ZHANG, Y. YU, W. WANG, T. LI: “Software Correlator in the Chang’E-3 Mission”. International VLBI Service for Geodesy and Astrometry 2014 General Meeting Proceedings ‘VGOS: The New VLBI Network’, edited by D. Behrend, K. D. Baver, and K. L. Armstrong, Science Press (Beijing), ISBN 978-7-03-042974-2, 188–190, 2014.
- R. ZHU, X. ZHANG, Y. WU, S. GUO, Y. XIANG: “A New Generation of Platforms for CDAS”. International VLBI Service for Geodesy and Astrometry 2014 General Meeting Proceedings ‘VGOS: The New VLBI Network’, edited by D. Behrend, K. D. Baver, and K. L. Armstrong, Science Press (Beijing), ISBN 978-7-03-042974-2, 215–218, 2014.

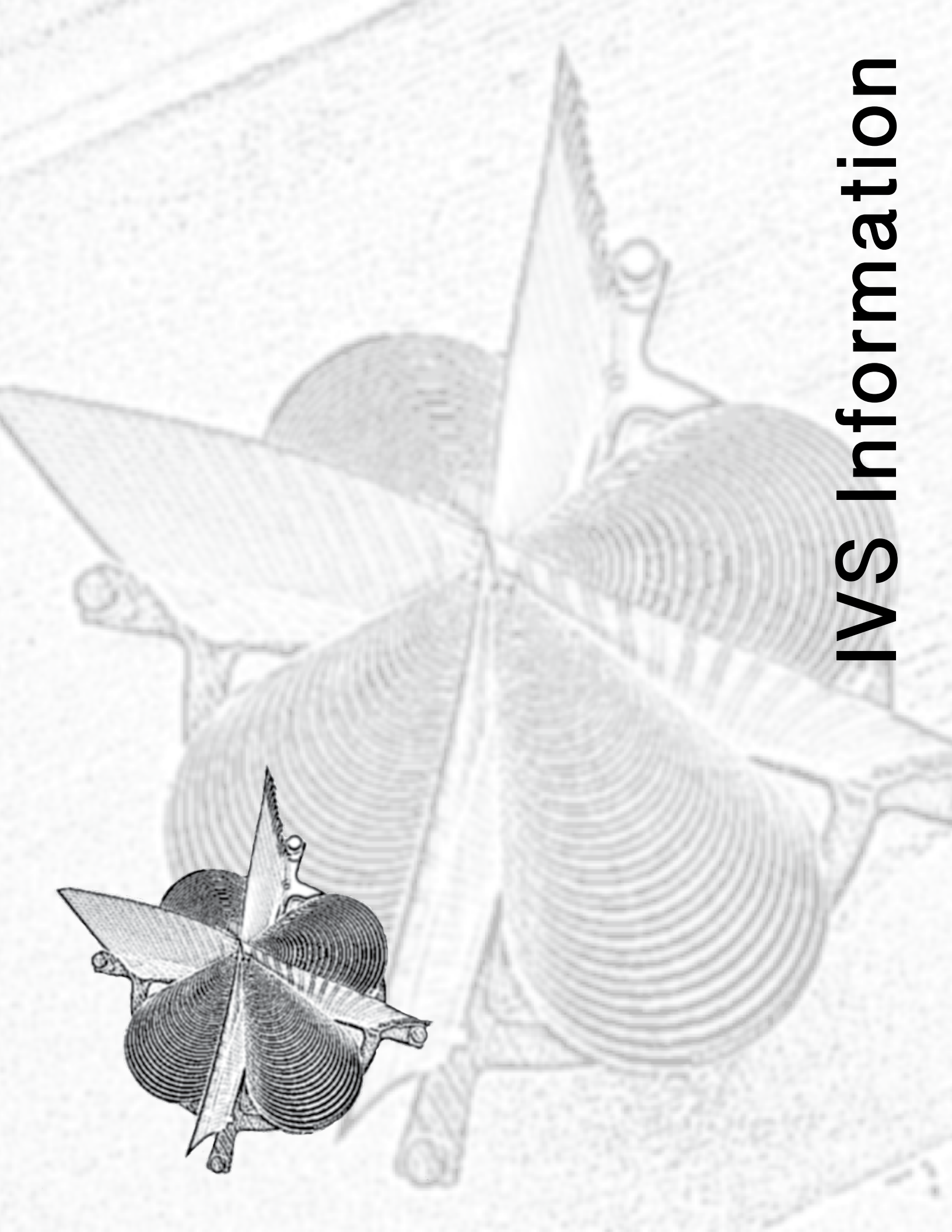
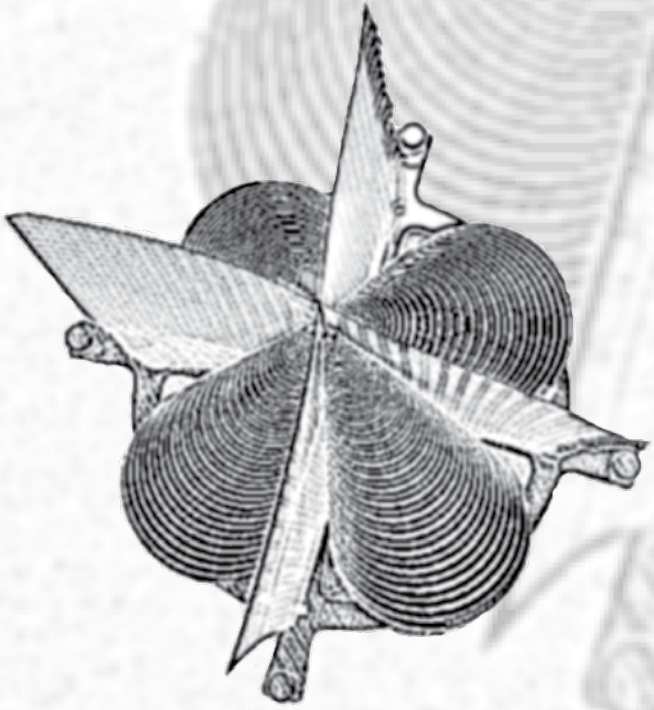

IVS Information

IVS Terms of Reference

1 Summary

1.1 Charter

The International VLBI Service for Geodesy and Astrometry (IVS) is an international collaboration of organizations which operate or support Very Long Baseline Interferometry (VLBI) components. IVS provides a service which supports geodetic and astrometric work on reference systems, Earth science research, and operational activities. IVS is a Service of the International Association of Geodesy (IAG) and of the International Astronomical Union (IAU).

1.2 Objectives

IVS fulfills its charter through the following objectives:

1. foster and carry out VLBI programs. This is accomplished through close coordination of the participating organizations to provide high-quality VLBI data and products.
2. promote research and development activities in all aspects of the geodetic and astrometric VLBI technique.
3. advance the education and training of VLBI participants through workshops, reports, and other means.
4. support the integration of new components into IVS.
5. interact with the community of users of VLBI products. IVS represents VLBI in the Global Geodetic

IVS 2014 Annual Report

Observing System (GGOS) of the IAG and interacts closely with the International Earth Rotation and Reference Systems Service (IERS).

In support of these objectives, IVS coordinates VLBI observing programs, sets performance standards for VLBI stations, establishes conventions for VLBI data formats and data products, issues recommendations for VLBI data analysis software, sets standards for VLBI analysis documentation, and institutes appropriate VLBI product delivery methods to ensure suitable product quality and timeliness. IVS coordinates its activities with the astronomical community because of the dual use of many VLBI facilities and technologies for both astronomy and astrometry/geodesy.

1.3 Data Products

VLBI data products contribute uniquely to these important activities:

- defining and maintaining the celestial reference frame,
- monitoring universal time (UT1), and
- monitoring the coordinates of the celestial pole (nutation and precession).

These results are the foundation of many scientific and practical applications requiring the use of an accurate quasi-inertial reference frame, such as high-precision positioning, navigation, and timing. In addition IVS provides a variety of VLBI products with differing applications, timeliness, detail, and temporal resolution, such as:

- all components of Earth orientation parameters,
- terrestrial reference frame,
- baseline lengths, and
- tropospheric parameters.

All VLBI data and products are publicly available in appropriate formats from IVS Data Centers.

1.4 Research

The IVS data and products are used for research in many areas of geodesy, geophysics, and astronomy, such as:

- UT1 and polar motion excitation over periods of hours to decades,
- solid Earth interior research (e.g., mantle rheology, anelasticity, libration, and core modes),
- characterization of celestial reference frame sources and improvements to the frame,
- tidal variations (solid Earth, oceanic, and atmospheric),
- improvements in the terrestrial reference frame, especially in the scale,
- climate studies (e.g., sea level change, deglaciation, and water vapor),
- regional and global geodynamics, and
- general relativity.

To support these activities, there are ongoing research efforts to improve and extend the VLBI technique in areas such as:

- instrumentation, data acquisition, and correlation,
- data analysis techniques,
- spacecraft tracking and navigation (Earth-orbiting and interplanetary), and
- combination of VLBI data and results with other techniques.

2 Permanent Components

IVS acquires, correlates, and analyzes VLBI data to produce geodetic, astrometric, and other results that are archived and publicized. IVS accomplishes its objectives through the following permanent components:

- Network Stations,
- Operation Centers,
- Correlators,
- Analysis Centers,
- Data Centers,
- Technology Development Centers, and
- Coordinating Center.

2.1 Network Stations

The IVS observing network consists of high performance VLBI stations.

- Stations may either be dedicated to geodesy or have multiple uses (including astronomical observations or satellite tracking applications).
- Stations comply with performance standards for data quality and operational reliability specified by the Directing Board.
- Stations provide local tie information, timing and meteorological data to the IVS Data Centers.
- VLBI data acquisition sessions are conducted by groups of Network Stations that may be distributed either globally or over a geographical region.

2.2 Operation Centers

The IVS Operation Centers coordinate the routine operations of specific networks. Operation Center activities include:

- planning network observing programs,
- supporting the network stations in improving their performance,
- generating the detailed observing schedules for use in data acquisition sessions by IVS Network Stations, and
- posting the observing schedule to an IVS Data Center for distribution and archiving.

IVS Operation Centers follow guidelines from the Coordinating Center for timeliness and schedule file formats.

2.3 Correlators

The IVS Correlators process raw VLBI data. Their other tasks are to:

- provide timely feedback to the Network Stations about data quality,
- jointly maintain the geodetic/astrometric community's media pool and transport,
- manage electronic data transfer,
- make processed data available to the Data Centers, and
- regularly compare processing techniques, models, and outputs to ensure that data from different Correlators are identical.

2.4 Analysis Centers

The IVS coordinates VLBI data analysis to provide high-quality products for its users. The analyses are performed by:

- Operational Analysis Center,
- Associate Analysis Centers,
- Special Analysis Centers for Specific Observing Sessions, and
- Combination Centers.

All Analysis Centers maintain and/or develop appropriate VLBI analysis software.

Operational Analysis Centers are committed to producing results to the specifications of the IVS Analysis Coordinator and always on schedule to meet IVS requirements. In addition, Operational Analysis Centers may produce Earth orientation parameters, station coordinates, and source positions in regular intervals.

Operational Analysis Centers place their final results in IVS Data Centers for dissemination to researchers and other users. They adhere to IVS recommendations for the creation of high-quality products and their timely archiving and distribution. Any deviations that an Operational Analysis Center makes from IVS recommendations are properly documented. Operational Analysis Centers provide timely feedback about station performance. In addition to these regular services, Operational Analysis Centers may also perform any task of an Associate Analysis Center.

Associate Analysis Centers are committed to regularly submit specialized products using complete series or subsets of VLBI observing sessions. The analysis is performed for specific purposes as recognized by the Directing Board, such as exploitation of VLBI data for new types of results, investigations of regional phenomena, reference frame maintenance, or special determinations of Earth orientation parameters. The Associate Analysis Centers place their final results in IVS Data Centers for dissemination to researchers and other users. They adhere to IVS recommendations for the creation of high-quality products and their timely archiving and distribution. Any deviations that an Associate Analysis Center makes from IVS recommendations are properly documented.

Special Analysis Centers for Specific Observing Sessions have responsibility for ongoing series-related investigations of one or more existing session types. They perform detailed and comparative analyses of each session of a series within a reasonable time after correlation. In addition, they report deficits and technical complications to the observing sites, the correlators, and to the schedulers as well as to the IVS Network and Analysis Coordinators.

Combination Centers are committed to produce combination results from the individual submissions of the Operational Analysis Centers as official IVS products. For this purpose they monitor the quality of the submissions. The official IVS products include, but are not limited to, EOP time series derived from session-based results for 24-hour network sessions and one-hour Intensive sessions. Combination Centers also contribute to the generation of the official IVS input to International Terrestrial Reference Frame (ITRF) computations. The combination work is done in a timely fashion and in close cooperation with the IVS Analysis Coordinator.

2.5 Data Centers

The IVS Data Centers are repositories for VLBI observing schedules, station log files, data and products. Data Centers may mirror other Data Centers to make the distribution and maintenance of data more efficient and reliable.

- Data Centers are the primary means of distributing VLBI products to users.

- Data Centers work closely with the Coordinating Center and with the Analysis Centers to ensure that all the information and data required by IVS components are quickly and reliably available.

Data Centers provide the following functions:

- receive and archive schedule files from Operation Centers,
- receive and archive log files and ancillary data files from the Network Stations,
- receive and archive data products from the Analysis Centers, and
- provide access and public availability to IVS data products for all users.

2.6 Technology Development Centers

The IVS Technology Development Centers contribute to the development of new VLBI technology for improvement of the VLBI technique. They:

- investigate new equipment and approaches,
- develop, test, and document new hardware, firmware, and software for operations,
- assist with deployment, installation, and training for any new approved technology, and
- maintain and support operational equipment.

2.7 Coordinating Center

The IVS Coordinating Center is responsible for coordination of both the day-to-day and the long-term activities of IVS, consistent with the directives and policies established by the Directing Board. Specifically, the Coordinating Center monitors, coordinates, and supports the activities of the Network Stations, Operation Centers, Correlators, Data Centers, Analysis Centers, and Technology Development Centers. The Coordinating Center works closely with the Technology Coordinator, the Network Coordinator, and the Analysis Coordinator to coordinate IVS activities.

The primary functions of the Coordinating Center are to:

- coordinate observing programs approved by the Directing Board,

- create and maintain the master schedule of observing sessions in coordination with IVS Network Stations and astronomical observing programs,
- foster communications among all components of the IVS,
- coordinate the best use of community resources,
- develop standard procedures for IVS components,
- organize training in VLBI techniques,
- organize workshops and meetings, including IVS technical meetings,
- produce and publish reports of activities of IVS components,
- maintain the IVS information system and archive all documents, standards, specifications, manuals, reports, and publications,
- coordinate IVS outreach and educational activities,
- provide liaison with the IAU, IAG, GGOS, IERS, and other organizations, and
- provide the Secretariat of the Directing Board.

2.8 Becoming a Permanent Component

IVS will accept proposals at any time to become a permanent component. Such proposals will be reviewed for approval by the Directing Board.

3 Coordinators

Specific IVS activities regarding network data quality, products, and technology are accomplished through the functions performed by three coordinators: a Network Coordinator, an Analysis Coordinator, and a Technology Coordinator.

3.1 Network Coordinator

The IVS Network Coordinator is selected by the Directing Board from responses to an open solicitation to all IVS components. The Network Coordinator represents the IVS Network Stations on the Directing Board and works closely with the Coordinating Center. The Network Coordinator is responsible for stimulating the maintenance of a high quality level in the station oper-

ation and data delivery. The Network Coordinator performs the following functions:

- monitors adherence to standards in the network operation,
- participates in the quality control of the data acquisition performance of the network stations,
- tracks data quality and data flow problems and suggests actions to improve the level of performance, and
- coordinates software development for station control and monitoring.

The Network Coordinator works closely with the geodetic and astronomical communities who are using the same network stations for observations. The Network Coordinator takes a leading role in ensuring the visibility and representation of the network stations.

3.2 Analysis Coordinator

The IVS Analysis Coordinator is selected by the Directing Board from responses to an open solicitation to the IVS Analysis Centers. The Analysis Coordinator is responsible for coordinating the analysis activities of IVS and for stimulating VLBI product development and delivery. The Analysis Coordinator performs the following functions:

- fosters comparisons of results from different VLBI analysis software packages and different analysis strategies,
- encourages documentation of analysis and combination software,
- participates in comparisons of results from different space geodetic techniques,
- monitors Analysis Centers' products for high quality results and for adherence to IVS standards and IERS Conventions,
- ensures that IVS analysis and combination products from all Analysis Centers are archived and are available to the scientific community, and
- supervises the formation of the official IVS products specified by the IVS Directing Board.

The Analysis Coordinator plays a leadership role in the development of methods for generation and distribution of VLBI products so that the products reach the

users in a timely manner. The Analysis Coordinator interacts with GGOS and the IERS and promotes the use of VLBI products by the broader scientific community. The Analysis Coordinator works closely with the astronomical communities who are using some of the same analysis methods and software.

3.3 Technology Coordinator

The IVS Technology Coordinator is selected by the Directing Board from responses to an open solicitation to the IVS Technology Development Centers. The Technology Coordinator performs the following functions:

- stimulates advancement of the VLBI technique,
- maintains awareness of all current VLBI technologies and ongoing development,
- coordinates development of new technology among all IVS Technology Development Centers,
- encourages technical compatibility with the astronomical community,
- encourages and oversees development of VLBI-related technical standards,
- coordinates the distribution of and access to technical documents and standards, and
- helps promulgate new technologies to the IVS community.

The Technology Coordinator works closely with the astronomical community, both to maintain technical compatibility between the geodetic and astronomical communities and to take advantage of technology development activities in the astronomical community.

4 Directing Board

4.1 Roles and Responsibilities

The Directing Board sets objectives, determines policies, adopts standards, and sets the scientific and operational goals for IVS. The Directing Board exercises general oversight of the activities of IVS including modifications to the organization that are deemed appropriate and necessary to maintain efficiency and reliability. The Directing Board may determine appropriate actions to ensure the quality of the IVS products.

The Directing Board will receive and review proposals for non-IVS research programs that request IVS resources.

4.2 Membership

The Directing Board consists of representatives of the IVS components, members at-large, appointed members, and ex officio members. The members are:

Representatives of IVS Components (see below):

- Correlators and Operation Centers representative (1)
- Analysis and Data Centers representatives (2)
- Networks representatives (2)
- Technology Development Centers representative (1)

Elected by the Directing Board upon recommendation from the Coordinating Center (see below):

- Members at large (3)

Selected by Directing Board upon review of proposals from IVS Member Organizations:

- Coordinating Center Director
- Network Coordinator
- Analysis Coordinator
- Technology Coordinator

Appointed members:

- IAU representative
- IAG representative
- IERS representative

Through a reciprocity agreement between IVS and IERS, the IVS serves as the VLBI Technique Center for IERS, and as such its designated representative(s) serve on the IERS Directing Board. In turn, the IERS Directing Board designates a representative to the IVS Directing Board. This arrangement is to assure full cooperation between the two services.

Total number: 16

The members appointed by IAU, IAG, and IERS are not subject to institutional restrictions.

The six members who are the representatives of the IVS components are elected by the IVS Associate Members. All elected members serve staggered four-year terms once renewable.

At-large members are intended to ensure representation on the Directing Board of each of the components of IVS and to balance representation from as many countries and institutions and IVS interests as possible. At-large members serve two-year terms once renewable.

A Directing Board member who departs before the end of his/her term is replaced by a person selected by the Directing Board. The new member will serve until the next official elections. The position will then be filled for a full term.

An individual can only serve two consecutive full terms on the Board in any of the representative and at-large positions. Partial terms are not counted to this limit. After serving two consecutive full terms, an individual becomes eligible again for a position on the Board following a two-year absence.

The three Coordinators are selected by the Directing Board on the basis of proposals from IVS Member Organizations. On a two-thirds vote the Directing Board may call for new proposals for any Coordinator when it determines that a new Coordinator is required. Coordinators are encouraged to give at least six months notice before resigning.

4.3 Elections

Election of Board members from the IVS components shall be conducted by a committee of three Directing Board members, the chair of which is appointed by the chair of the Directing Board. The committee solicits nominations for each representative from the relevant IVS components. For each position, the candidate who receives the largest number of votes from the Associate Members will be elected. In case of a tie the Directing Board will make the decision.

4.4 Chair

The chair is one of the Directing Board members and is elected by the Board for a term of four years with the

possibility of reelection for one additional term. The chair is the official representative of IVS to external organizations.

4.5 Decisions

Most decisions by the Directing Board are made by consensus or by simple majority vote of the members present. In case of a tie, the chair decides how to proceed. If a two-thirds quorum is not present, the vote shall be held later by electronic mail. A two-thirds vote of all Board members is required to modify the Terms of Reference, to change the chair, or to replace any of the members before their normal term expires.

4.6 Meetings

The Directing Board meets at least annually, or more frequently if meetings are called by the chair or at the request of at least three Board members. The Board will conduct periodic reviews of the IVS organization and its mandate, functions, and components.

5 Definitions

5.1 Member Organizations

Organizations that support one or more IVS components are IVS Member Organizations. Individuals associated with IVS Member Organizations may become IVS Associate Members.

5.2 Affiliated Organizations

Organizations that cooperate with IVS on issues of common interest, but do not support an IVS component, are IVS Affiliated Organizations. Affiliated Organizations express an interest in establishing and maintaining a strong working association with IVS to mutual benefit. Individuals affiliated with IVS Affiliated

Organizations may become IVS Corresponding Members.

5.3 Associate Members

Individuals associated with organizations that support an IVS component may become IVS Associate Members. Associate Members take part in the election of the incoming members of the Directing Board representing the IVS components.

5.4 Corresponding Members

IVS Corresponding Members are individuals who express interest in receiving IVS publications, wish to participate in workshops or scientific meetings organized by IVS, or generally are interested in IVS activities. Ex officio Corresponding Members are the following:

- IAG Secretary General
- Chair of GGOS
- President of IAG Commission 1 – Reference Frames
- President of IAG Commission 3 - Earth Rotation and Geodynamics
- President of IAU Division I – Fundamental Astronomy
- President of IAU Commission 8 – Astrometry
- President of IAU Commission 19 – Rotation of the Earth
- President of IAU Commission 31 – Time
- President of IAU Commission 40 – Radio Astronomy
- President of URSI Commission 52 – Relativity in Fundamental Astronomy
- President of URSI Commission J – Radio Astronomy

Individuals are accepted as IVS Corresponding Members upon request to the Coordinating Center.

Last modified: 23 September 2011

Links to Additional IVS Information

This page provides links to information about the individuals and groups that support IVS. Member organizations are organizations that support one or more permanent components. Permanent components are groups that formally commit to provide support in one of six categories: coordination of network operations (Operation Centers), collection of VLBI data (Network Stations), processing of raw data (Correlators), archival and distribution of data and products (Data Centers), analysis of data and generation of products (Analysis Centers), and development of new technology (Technology Development Centers).

Associate Members are individuals that are associated with a member organization and have been granted Associate Member status. Associate Members generally support IVS by participating in the activities of one or more components.

Affiliated organizations cooperate with IVS on matters of common interest but do not support a component.

Information Category	Link
Associate Members	
(listed alphabetically by last name)	ivscc.gsfc.nasa.gov/about/org/members/assoc_name.pdf
(listed alphabetically by their organization's country)	ivscc.gsfc.nasa.gov/about/org/members/assoc_org.pdf
Permanent Components	
Network Stations	http://ivscc.gsfc.nasa.gov/about/org/components/ns-list.html
Operation Centers	http://ivscc.gsfc.nasa.gov/about/org/components/oc-list.html
Correlators	http://ivscc.gsfc.nasa.gov/about/org/components/co-list.html
Data Centers	http://ivscc.gsfc.nasa.gov/about/org/components/dc-list.html
Analysis Centers	http://ivscc.gsfc.nasa.gov/about/org/components/ac-list.html
Technology Development Centers	http://ivscc.gsfc.nasa.gov/about/org/components/td-list.html
Member Organizations	http://ivscc.gsfc.nasa.gov/about/org/members/memberorgs.html
Affiliated Organizations	http://ivscc.gsfc.nasa.gov/about/org/members/affilmemberorgs.html

