

*Proceedings of the 2015 Industrial and Systems Engineering Research Conference*  
S. Cetinkaya and J. K. Ryan, eds.

## Deep Space Storm Shelter Simulation Study

**Kathryn Dugan**  
College of William & Mary  
Williamsburg, VA 23186

**Nipa Phojanamongkolkij, Jeffrey Cerro and Matthew Simon**  
NASA Langley Research Center  
Hampton, VA 23681

### Abstract

Missions outside of Earth's magnetic field are impeded by the presence of radiation from galactic cosmic rays and solar particle events. To overcome this issue, NASA's Advanced Exploration Systems Radiation Works Storm Shelter (RadWorks) has been studying different radiation protective habitats to shield against the onset of solar particle event radiation. These habitats have the capability of protecting occupants by utilizing available materials such as food, water, brine, human waste, trash, and non-consumables to build short-term shelters. Protection comes from building a barrier with the materials that dampens the impact of the radiation on astronauts. The goal of this study is to develop a discrete event simulation, modeling a solar particle event and the building of a protective shelter. The main hallway location within a larger habitat similar to the International Space Station (ISS) is analyzed. The outputs from this model are: 1) the total area covered on the shelter by the different materials, 2) the amount of radiation the crew members receive, and 3) the amount of time for setting up the habitat during specific points in a mission given an event occurs.

### Keywords

Radiation and Simulation

### 1. Introduction

Radiation is a major factor when traveling into deep space. NASA's Advanced Exploration Systems Radiation Works Storm Shelter Team (RadWorks) has been researching and developing design concepts to help mitigate the effects of radiation on astronauts during deep space missions. The main focus of this research is to provide the crew with protection from the effects of solar particle event (SPE) radiation during a deep space mission. The RadWorks team is producing concepts that utilize available materials (later referred to as logistics), including food, water, human waste, brine, trash, and non-consumables, to provide coverage. Non-consumables are items that are always available to crew members, such as hammers and tape. The motive for this approach is to use the items already available to the crew, instead of having to bring extra materials to build the shelters, which would increase the weight of the payload and may affect the initial launch into space.

A comprehensive trade study of system-level radiation protection concepts for deep space exploration was completed earlier in the project and reported in [1]. A video illustrating the four concepts selected from the trade studies are available in [2]. Results from the trade study were presented to program management such that concepts could be chosen for simulation hardware development and operational assessment. Protecting the crew in their natural private space area, the crew quarters, was a highly ranked approach (later referred to as Crew Quarters Option). Crew quarters are easy to enhance with logistical protection material and are an area where crew would likely spend additional time as well as sleep time, making them a region of high scheduled habitation. To make additional protection of any region, use of water and high water content items was highly desirable. This is because water provides good shielding properties. Thus, a water wall protected crew quarters became one concept to maintain for the next level of assessment.

Another result from the trade study noted was the dominant factor of trying to locate the crew away from "thin spots" in the habitat and in general to keep them as central as possible, surrounded by as much logistics as possible for as

long as possible. If the crew built a central storm shelter in the middle of the habitat, there would be protection not only of the built up shelter walls, but also of the myriad of existing systems and logistics which exist lining the outer walls of the habitation volume; thus the concept of creating a single shelter built up in a centralized region becomes the second concept (later referred to as Hallway Option) selected for further assessment and demonstration/evaluation purposes.

Knowledge of the amounts of logistics on hand through a mission timeline is important to show that sufficient radiation protection is available for reconfiguration during an SPE which could occur at any time point in a long mission. One way to assess this is to perform a mission Discrete Event Simulation (DES) to quantify logistics, food, water, and waste product usage over time. This is, in fact, the motivation of this study to assess which of the aforementioned two shelter concepts is more effective. However, at the time of this study, the RadWorks team is in the process of setting up radiation analysis and operational concepts for the Crew Quarters Option. As such, this shelter concept was not ready for the DES and was excluded in this study. The organization of the paper is as follows. A description of mission and shelter concept (the Hallway Option) are presented in Section 2. The radiation calculation used in the DES model is given in Section 3. A description of the model is given in Section 4. Section 5 analyzes the simulation results. Finally, Section 6 gives the conclusion of the study and provides potential future work.

## **2. Description of Mission and Shelter Concept**

### **2.1 Description of Logistics**

The mission being modeled is set to occur in deep space where there is little to no protection from radiation. The mission length is a maximum of 180 days where each day is equally likely to contain an SPE. The main living habitat for a full crew of four crew members is similar to the ISS. Within the ISS-like habitat, there is the ability to build a radiation protective unit in the main hallway or as part of the crew quarters. Both of these shelters must house all four crew members during the radiation effects. The astronauts receive an hour notice of the impending radiation in which they are to build the shelter before the radiation particles reach the habitat. The effects of the radiation event are considered to last for a maximum of 36 hours.

Each type of logistics is stored in its own type of container or bag, which distinguishes it from the others. The mission starts with all food stored in food storage pouches (FSP) and all contingency water, which is used for emergencies, being stored in iodine contingency water containers (ICWC). Trash is stored in containers called pucks and when an FSP is emptied of food, the pucks can be used to fill an emptied FSP. Both brine and human waste are stored in common protection containers (CPC). Neither FSPs nor CPCs can have cross contamination of components. All non-consumables, FSPs, ICWCs, and CPCs can be stored in a cargo transfer bag (CTB). Examples of the demonstration logistics are given in Figure 1.

### **2.2 Shelter Concept - Hallway Option**

The hallway option includes six sides that need to be filled with logistics. Each side is an unfolded CTB blanket that is hung up on pre-existing frames in the ISS-like shelter. The blankets are made up of a Velcro material such that logistics can be placed on each blanket. For initial evaluation of this option, the two main aisle-way walls are created using CTBs containing non-consumables. The wall filled with non-consumables is generally thicker than wall filled with other logistics, and therefore will provide a better radiation protection. The rest of the walls are compiled of the other logistics available. The shelter contains the four crew members while the radiation effects of a SPE are occurring. All four crew members need to fit inside the hallway option to receive radiation protection from the SPE. Figure 2 depicts the location within the ISS-like structure for the hallway option, which is the red rectangle in the front of the habitat. Figure 3 shows the buildup of the hallway option using different logistics. The white and yellow items represent different logistics on the walls of the shelter. The blue represents folded out CTB blankets. A video illustrating the deployment of this concept is available in [3].

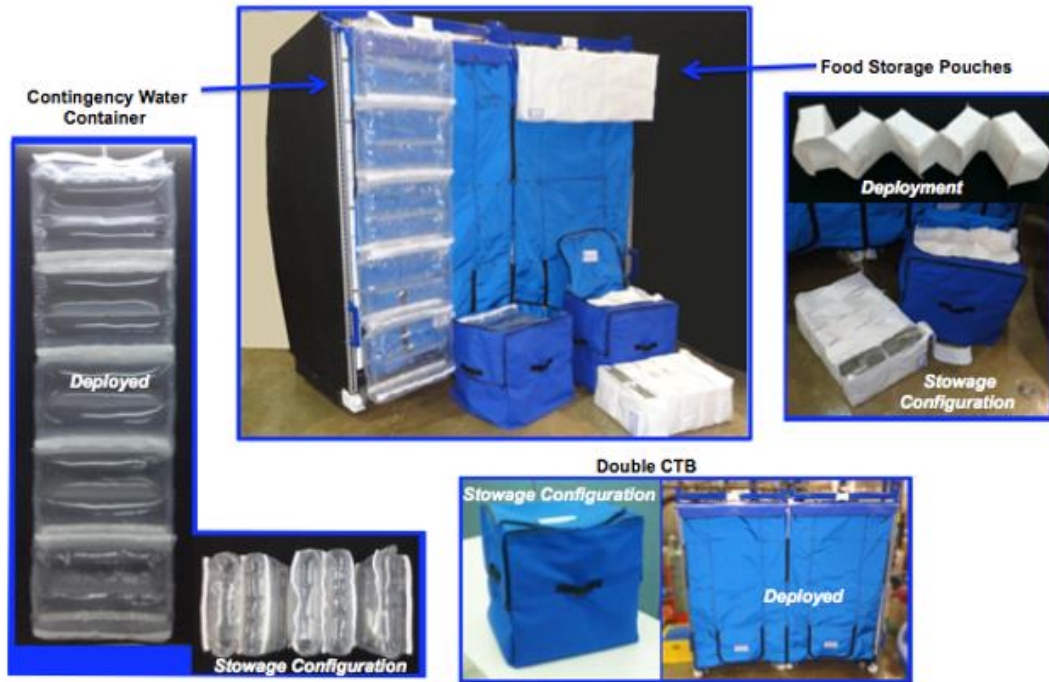

Figure 1: Samples of the demonstration logistics

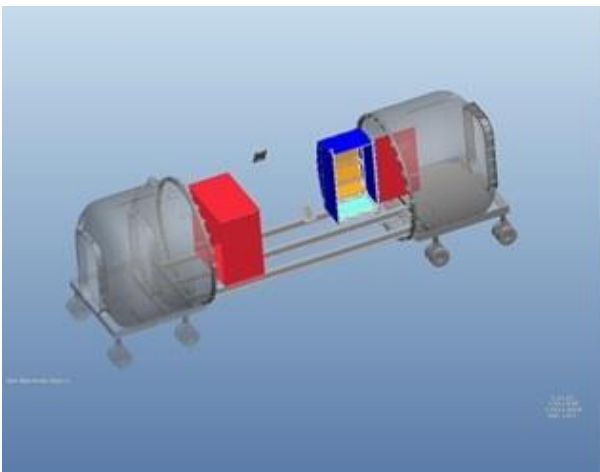

Figure 2: Locations within ISS-like structure of the Hallway option shown as red rectangle (also shown the Crew Quarters option as blue object)

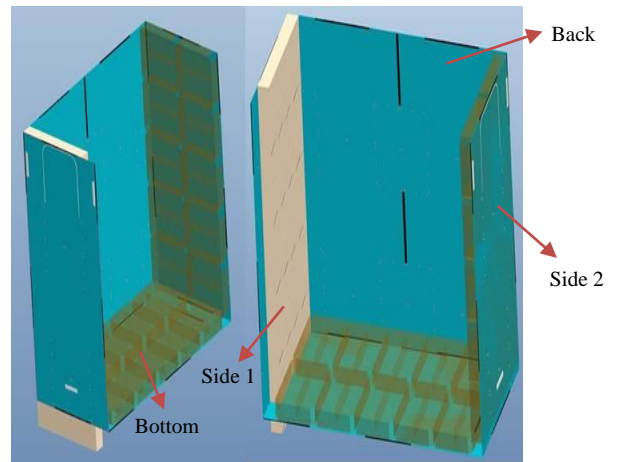

Figure 3: Sample hallway shelter built out of different materials

### 3. Radiation Calculations

The reader is directed to [4-7] for a thorough radiation analysis. The fundamental calculation relevant to this study is summarized here and is based on the conservative estimations of the radiation dosage.

#### 3.1 SPE Radiation

The SPE radiation values are calculated with respect to the amounts and types of materials located on the shelter. An “ideal dosage” is calculated using equation (1). This dosage is only a function of thickness of the wall that was built, regardless of materials, and provides 100% efficiency in blocking the radiation.

$$\text{Hallway: Ideal Dosage} = 251.983e^{-0.217 * \text{Thick.Input}} + 15.277 \quad (1)$$

Ideal dosage is in millisieverts (mSv), while the thickness input (*Thick.Input* in the equation) is a weighted average of all walls in meters since the thickness of the walls could vary across the shelter, such as in the hallway where the two main aisle way walls are filled with CTBs that are 0.426 meter-thick versus all other containers that are only 0.102 meter-thick.

Once the ideal dosage is calculated, the actual dosage can be obtained by dividing the ideal dosage by the gap efficiency of the logistic used to cover the wall. The gap efficiency represents how efficient each logistic is in protecting the occupants from radiation. The gap efficiencies for each of the logistics that can be used to build the shelter are presented in the second column of Table 1.

Table 1: Gap Efficiency for Each Logistics in Percent, Initial Starting Values of the Logistics at the Beginning of the Mission (“Mass” Column), and the Average Daily Consumption and Production Rates for a Full Crew (“Kilograms/day” Column)

Logistic	Gap Efficiency	Mass (kg)	Kilograms/day
Food	85%	1041	5.781
Contingency Water	90%	510	-
Drinking Water	90%	594	7.161
Non-Consumables	80%	1000	-
Waste	80%	0	1.797*
Brine	80%	0	1.074*
Trash	85%	0	2.697

\*with an ability to recycle 80% of its mass for drinking water

### 3.2 GCR Radiation

The GCR radiation exposure varies depending on location from 0.82 to 0.95 mSv/day. Within the ISS, there are different locations that receive better protection against GCR radiation. There is roughly a 10% reduction in exposure moving to a central location from the crew quarters. Within this study, an average of these locations is taken to obtain the 0.857 mSv/day exposure to the astronauts.

## 4. Model Description

Several assumptions were made during the development of the simulation model. A list of the assumptions is provided below.

- Average consumption and production rates, based on an average astronaut, are constant throughout the mission and the same for all astronauts (the last column of Table 1).
- The order in which to build the walls of the shelter are back, top, bottom, side 1, side 2, and front. This is important because each wall has a different surface area and therefore is critical in determining which of the available logistics can be used to build it. The definitions for each wall are also given in Figure 3.
- The order in which to use logistics is ICWCs, CPCs filled with waste, FSPs filled with pucks (trash), CPCs filled with brine, and FSPs filled with food.
- Walls of the same type of material are built first. If there is not enough of the same material type to build a wall, then walls with mixed materials (such as FSPs filled with both food and pucks) are built next.
- Only one layer of logistics is used to build each shelter wall for protection.
- Only one wall can be built at a time, no multi-tasking.
- The simulation begins with a predefined amount of logistics (the third column of Table 1) and terminates after the SPE occurs. It does not take into account the notification time (an hour in advance of the SPE event) or the length of the radiation effects (36 hours).
- An SPE either occurs on a day or it does not. There is no continuous checking every hour or minute for an SPE.

Arena software was used to build the DES model for this study. Although a SPE can occur on any day within the mission, the RadWorks team is interested in evaluating a set of specific days (i.e., 0, 30, 60, 90, 120, 150, and 180

days from the mission start) when SPE occurs. For each SPE event day, the simulation determined, based on 1,000 replicates, the total area covered on the shelter by the different logistics, radiation dosage for astronauts, and how long to set up the shelter.

At the beginning of the simulation, the totals for available food and water are assigned (the third column of Table 1) as well as the day when the SPE is to occur. Next, the astronauts are assigned consumption and production rates for each logistic as shown in the last column of Table 1. The on-hand totals for the mission of each logistic are modified based on these consumption and production rates for each simulated day. To determine the levels of filled containers of logistics, a packing evaluation procedure is executed each simulated day to find the levels available for building the shelter. Details on how logistics are packed is found in Figures 4 and 5.

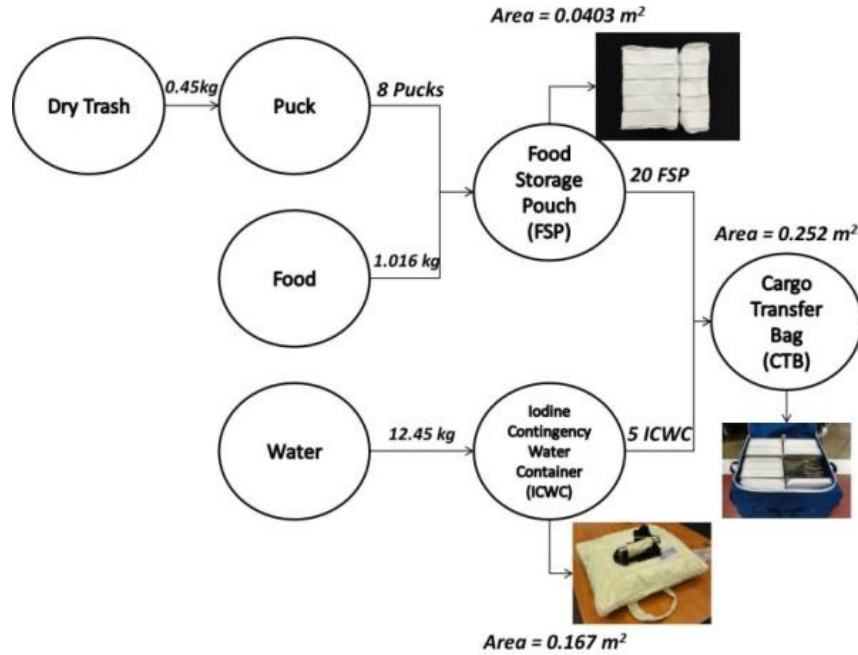

Figure 4: Flow Chart of Packing Logistics

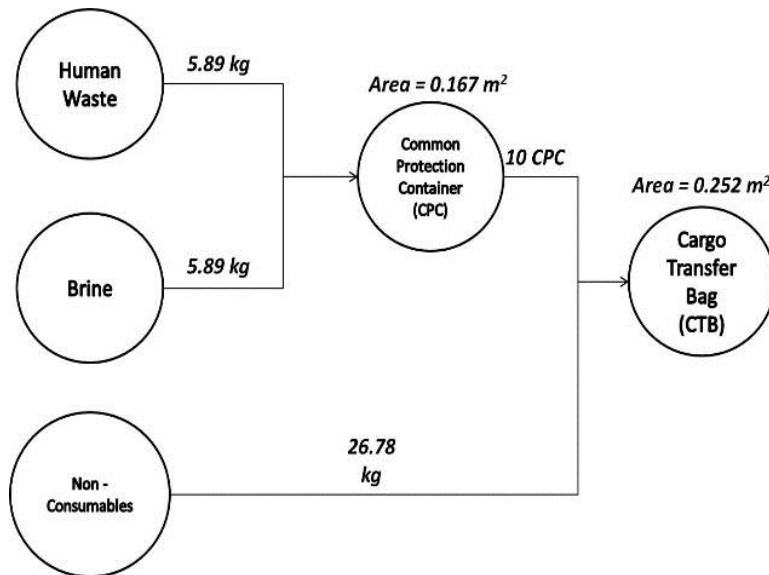

Figure 5: Flow Chart of Packing Logistics (Cont'd)

Before the simulated day is ended, a galactic cosmic ray (GCR) radiation calculation is computed. This radiation represents background radiation and occurs each day at the same level on all astronauts. The RadWorks team suggested to represent the daily GCR dosage as having a normal distribution with a mean of 0.857 mSv (from Section 3.2), and an assumed standard deviation of 0.0857 mSv (or 10% of the mean). Next the simulation checks to determine whether the SPE is to occur on that day, and if so then it is routed directly to building the shelter processes, otherwise the day is ended and the next day begins.

When the SPE is to occur, the simulation will begin the shelter building process. Each wall side is built based on the order sequence and the available logistics. The actual SPE radiation dosage is calculated according to Section 3.1. A normal distribution with a mean according to the actual dosage, and an assumed standard deviation of 10% of the computed actual dosage is used in the model. The time to build each shelter depends on the type of wall that is being built, same or mixed material type, and the area of the wall. The triangular distribution is used because the team was able to provide estimates for the minimum, most likely, and maximum times to build the wall. Table 2 displays these numbers. The sum of all wall-building times is taken to create the time it took to build the shelter. Before the simulation is terminated, the break-out of walls by logistics and types (same or mixed materials), the radiation dosage (SPE and GCR), and time to build the shelter are reported.

Table 2: The Amount of Time it Takes to Build a Particular Type of Wall, in Minutes per Square Meter

Type of Wall	Minimum	Mode (Most Likely)	Maximum
Same	0.5	1	2
Mix	0.5	1.5	2.5

## 5. Results

This section provides preliminary results of the DES model at the time of this study. The results are subject to change as more accurate inputs become available. Nevertheless, the preliminary results are useful for the RadWorks team to be able to evaluate many future what-if scenarios using the DES model.

### 5.1 Shelter Configurations

In the current study, variability exists for the SPE and GCR radiation dosages and time to build shelter. As such, the break-out of walls by logistics and types (called the shelter configurations) does not vary from run to run. Figure 6 represents the shelter configurations. On the x-axis is the day for when the SPE occurred and the y-axis is the number of walls built of a particular type. Walls were built using all of one material type (no mixed material type). Three walls were built with all ICWCs filled with water and two walls were built with CTBs filled with non-consumables. As expected, the model chose to build as many water walls as possible because of its effective protection. The two walls of non-consumable filled CTBs are the requirement for the hallway option as described in Section 2.2. Only one of the walls changed logistic type given when the SPE occurred in the mission. This happened between day 30 and day 60. An explanation for this is from the consumption and production levels for the full crew. After day 30 there is enough waste to build a wall and, based on the assumptions in the model, a wall filled with all waste is of higher priority than a wall filled with food.

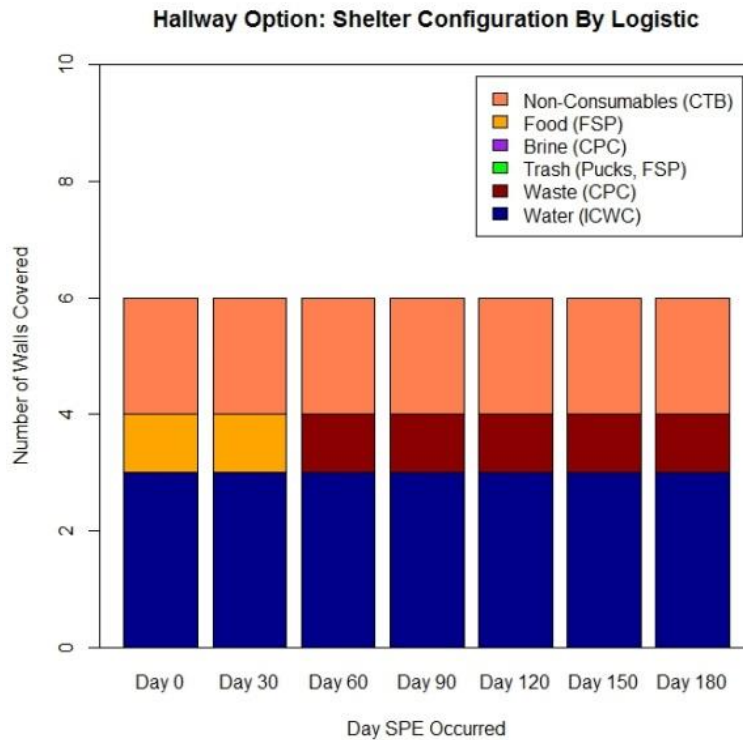

Figure 6: Hallway Option: Shelter Configurations Produced throughout the Mission

## 5.2 Radiation Levels

Figure 7 shows the radiation levels from the solar particle event. The dosage depends on what day in the mission it occurred on. On the x-axis is the day the SPE occurred and on the y-axis is the radiation dosage the astronauts received based on the shelter configuration produced as in the previous section. The graphs show the baseline, the 95th percentile, and the average from 1,000 replicates. The baseline was produced without varying the radiation level. The 95th percentile represents the tolerance for which 95% of the radiation values fall below.

Figure 8 shows the galactic cosmic ray radiation level across the mission. As with the SPE radiation figures, the simulation was run 1,000 times to get the 95th percentile and the average. The GCR levels in this figure are for when the SPE occurred on the days shown on the x-axis, which is why it increases from left to right. The 95th percentile widens from the baseline as more days pass because an additive effect of variations occurs on the radiation level.

Figure 9 shows the total radiation, both SPE and GCR, levels. Only the 95th percentile and the baseline are shown. The radiation level increases across the mission because the GCR increases each day. The RadWorks team will be able to use the 95th percentile total radiation level to compare against the safety tolerance for astronauts once it is known.

Hallway Option: SPE Radiation

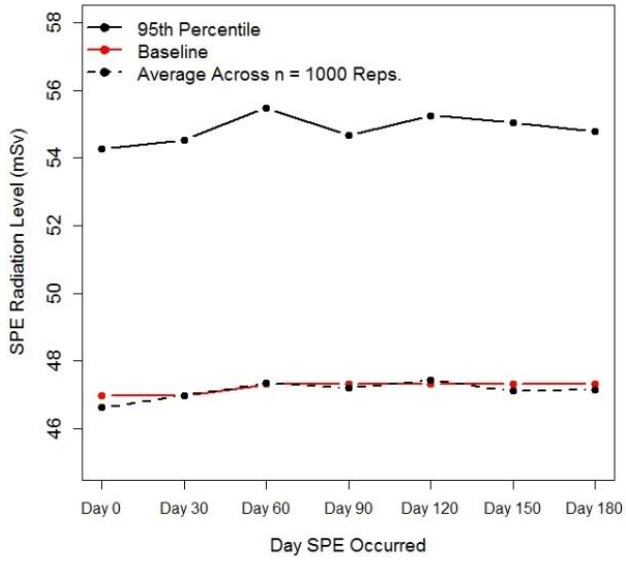

Figure 7: Hallway Option: SPE Radiation throughout the Mission

GCR Radiation

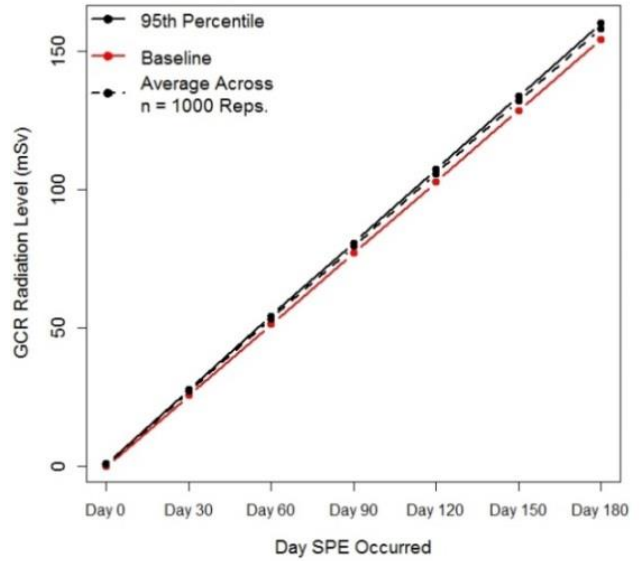

Figure 8: GCR Radiation throughout the Mission

Total Radiation

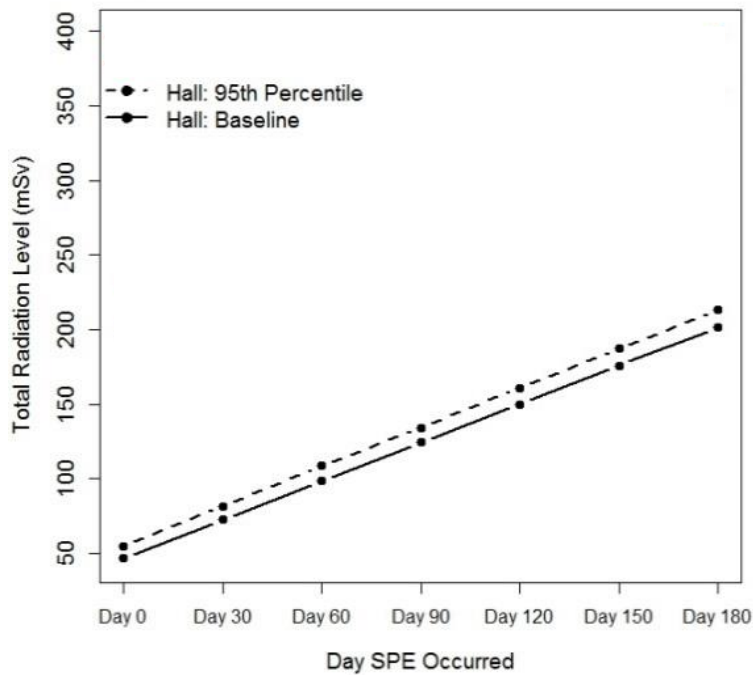

Figure 9: Total (SPE + GCR) Radiation throughout the Mission



### 5.3 Time to Build Shelter

Figure 10 displays the 95th percentile and the average across 1,000 replications to build the shelter. The Radworks team will be able to use the 95th percentile time to compare against the tolerance (currently set at 30 minutes) to ensure operational feasibility of the shelter concepts.

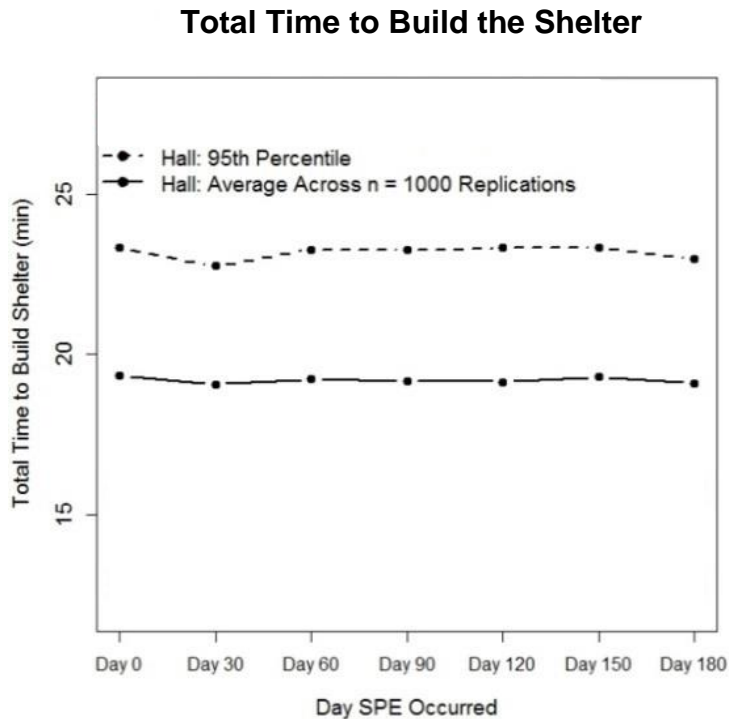

Figure 10: Time to Build Shelter throughout the Mission

## 6. Conclusion

This study developed a discrete event simulation (DES) model that built a storm shelter for protection against solar particle event radiation. The main hallway shelter concept was evaluated in the model. Depending on when the SPE occurs within a 180 day mission, different shelter configurations are produced based on the materials (logistics) available. Three walls were always built with all ICWCs filled with water because water is the most effective logistics in protecting against radiation. Only one of the walls changed logistic type given when the SPE occurred in the mission. If an SPE is to occur between day 0 and day 30, this wall is built by food. After day 30, there is enough waste to build a wall, given that a wall filled with all waste is of higher priority than a wall filled with food.

The assumptions and accuracy of the model inputs play a big role in the simulation findings. Nevertheless, the preliminary results in this study are useful for the RadWorks team to be able to evaluate many future what-if scenarios using the DES model. One example scenario is to simulate the Crew Quarter shelter concept in order to assess which of the two shelter concepts (the Hallway versus the Crew Quarter) is more effective in protecting against radiation exposure of astronauts. Future studies include testing the sensitivity of these assumptions as well as updating the model with more accurate inputs.

## Acknowledgements

Dr. Rex Kincaid of College of William & Mary provided input on the modeling framework. The Langley Aerospace Student Scholar program and the Virginia Space Grant Consortium provided funding for the research of this project.

## References

1. Cerro, J.A., 2013, "Trade Study of System Level Ranked Radiation Protection Concepts for Deep Space Exploration," Society of Allied Weight Engineers, 72nd Annual International Conference on Mass Properties, St. Louis MO , May 18-22, Paper No. 3593. [www.sawe.org/technical/papers](http://www.sawe.org/technical/papers) .
2. NASA Langley Research Center, February 15, 2013, "Space habitats of the future?" Retrieved from [https://www.youtube.com/watch?v=admRr0sp\\_v8](https://www.youtube.com/watch?v=admRr0sp_v8).
3. NASA Langley Research Center, February 13, 2014, "Radworks Space Storm Shelter Concepts." Retrieved from <https://www.youtube.com/watch?v=gmYEnLi285A>.
4. Simon, M.A., Cerro, J.A., Cloudsley, M.S., 2013, "RadWorks Storm Shelter Design for Solar Particle Event Shielding," AIAA SPACE 2013 Conference and Exposition, September 10-12, San Diego, CA. AIAA 2013-5435.
5. Simon, M.A., Cloudsley, M.S., Walker, S.A., 2013, "Habitat Design Considerations for Implementing Solar Particle Event Radiation Protection", 43rd International Conference on Environmental Systems (ICES), July 14-18, Vail, CO. AIAA 2013-3403.
6. Walker S.A., Cloudsley M.S., Abston H.L., Simon, M.A., Gallegos A.M., 2013, "Radiation Exposure Analyses Supporting the Development of Solar Particle Event Shielding Technologies," 43<sup>rd</sup> International Conference on Environmental Systems (ICES), July 14-18, Vail, CO. AIAA 2013-3042.
7. Simon, M.A., Cerro J.A., Latorella, K.A., Cloudsley, M.S., Watson, J., Albertson, C., Norman, R., Le Boffe, V., Walker, S.A., 2014, "Design of Two RadWorks Storm Shelters for Solar Particle Event Shielding", AIAA Info Space 2014.