

Conceptual Design and Structural Optimization of NASA Environmentally Responsible Aviation (ERA) Hybrid Wing Body Aircraft

Jesse R. Quinlan* and Frank H. Gern†

NASA Langley Research Center, Hampton, VA, 23681

Simultaneously achieving the fuel consumption and noise reduction goals set forth by NASA's Environmentally Responsible Aviation (ERA) project requires innovative and unconventional aircraft concepts. In response, advanced hybrid wing body (HWB) aircraft concepts have been proposed and analyzed as a means of meeting these objectives. For the current study, several HWB concepts were analyzed using the Hybrid wing body Conceptual Design and structural optimization (HCDstruct) analysis code. HCDstruct is a medium-fidelity finite element based conceptual design and structural optimization tool developed to fill the critical analysis gap existing between lower order structural sizing approaches and detailed, often finite element based sizing methods for HWB aircraft concepts. Whereas prior versions of the tool used a half-model approach in building the representative finite element model, a full wing-tip-to-wing-tip modeling capability was recently added to HCDstruct, which alleviated the symmetry constraints at the model centerline in place of a free-flying model and allowed for more realistic centerbody, aft body, and wing loading and trim response. The latest version of HCDstruct was applied to two ERA reference cases, including the Boeing Open Rotor Engine Integration On an HWB (OREIO) concept and the Boeing ERA - 0009H1 concept, and results agreed favorably with detailed Boeing design data and related Flight Optimization System (FLOPS) analyses. Following these benchmark cases, HCDstruct was used to size NASA's ERA HWB concepts and to perform a related scaling study.

Nomenclature

AB	= Aft Body
BDF	= Bulk Data File
BWB	= Blended Wing Body
CB	= Centerbody
CFD	= Computational Fluid Dynamics
ERA	= Environmentally Responsible Aviation Project at NASA
FAR	= Federal Aviation Regulations
FEM	= Finite Element Model
FLOPS	= Flight Optimization System
HCDstruct	= Hybrid wing body Conceptual Design and structural optimization
HWB	= Hybrid Wing Body
ITD	= Integrated Technology Demonstrator
LaRC	= Langley Research Center
LSAF	= Boeing's Low Speed Aeroacoustic Facility
MDOPT	= Multidisciplinary Design Optimization
NASA	= National Aeronautics and Space Administration
OML	= Outer Mold Line

*Aerospace Engineer, Aeronautics Systems Analysis Branch, 1 N Dryden Street, and AIAA Member.

†Senior Aerospace Engineer, Aeronautics Systems Analysis Branch, 1 N Dryden Street, and AIAA Member.

OpenVSP	= Open Vehicle Sketch Pad
OREIO	= Boeing Open Rotor Engine Integration On a BWB
PAI	= Propulsion Airframe Integration
TE	= Trailing Edge
TLNS	= Thin Layer Navier-Stokes

I. Introduction

HYBRID wing body (HWB) or Blended Wing Body (BWB) aircraft concepts are considered promising alternatives to conventional tube and wing configurations due to their large potential fuel savings and increased aerodynamic efficiency.¹ Fuel burn reductions of 25% and higher have been published for some ultra-high capacity configurations carrying up to 800 passengers. Most notable is the work of Liebeck and his co-workers at The Boeing Company. Their 450 passenger BWB-4501L design recently resulted in the 8.5% scale X-48B flight demonstrator² shown in Fig. 1. A significant difficulty in dealing with HWB design optimization has always been the lack of a data base of known flying designs which may serve as calibration and validation points for conceptual design and optimization programs like the Flight Optimization System (FLOPS),³ especially when compared to the vast amount of available tube and wing aircraft data. When transitioning from the conceptual to the preliminary design phase, the aircraft designer needs to be sure that the design chosen for further optimization is actually a viable design, and as a result of the lack of validation cases, the development of improved fidelity analysis tools becomes imperative for the conceptual design loop.

To validate the projected fuel burn and noise reduction potential of HWB designs for NASA’s Environmentally Responsible Aviation (ERA) project, significant efforts have been put forward to develop advanced structural and aerodynamic analysis tools for HWB conceptual design optimization. Aerodynamic methods improvement has been geared towards increased fidelity in-the-loop methods like enhanced panel codes and computational fluid dynamics (CFD).⁴ Recently developed structures tools include finite element model (FEM) based analyses to provide enhanced capabilities for HWB centerbody sizing and weight estimation which recently led to the approval for public release of the new HCDstruct tool (Hybrid wing body Conceptual Design and structural analysis).⁵



Figure 1. Boeing’s X-48B Blended Wing Body flight demonstrator (NASA Photo).

Following onto the prior versions of the tool,⁵⁻⁷ an overview of the current version of HCDstruct is presented in section II, including a full wing-tip-to-wing-tip modeling capability that permits application to full-aircraft configurations and a wide array of maneuver load cases. This latest version of the tool is then applied to several HWB concepts, including two reference cases in section III for which comparisons to Boeing and FLOPS data are made and subsequently to a family of NASA HWB concepts in section IV for which a scaling study is performed.

II. HCDstruct Overview

HCDstruct was developed at NASA Langley Research Center (LaRC) to fill a critical analysis gap between high level, lower order approaches commonly used for conceptual design and the low level, detailed, often finite-element-based optimization approaches commonly used for advanced preliminary design. Specifically, HCDstruct was developed to complement the FLOPS tool, which is a versatile, multidisciplinary suite of computer programs for conceptual and preliminary design and analysis of advanced aircraft concepts. However, the design sensitivities associated with off-design conditions for the regression-based sizing algorithms^{3,8} used by FLOPS are generally inaccessible by such a simplified approach. While the detailed finite element based sizing analyses often performed later in the design cycle, such as those for the HWB by Boeing,⁹ may theoretically offer such insights, the computational resources required to perform such analyses often limit these to single-point design analysis. Thus, HCDstruct was developed to bridge the gap between the regression-based sizing techniques of FLOPS and current state-of-the-art finite element based approaches for advanced preliminary design data. In fact, the tool has evolved to provide a means of optimizing the

primary structure for a HWB using finite element methods while only requiring FLOPS-level user data.

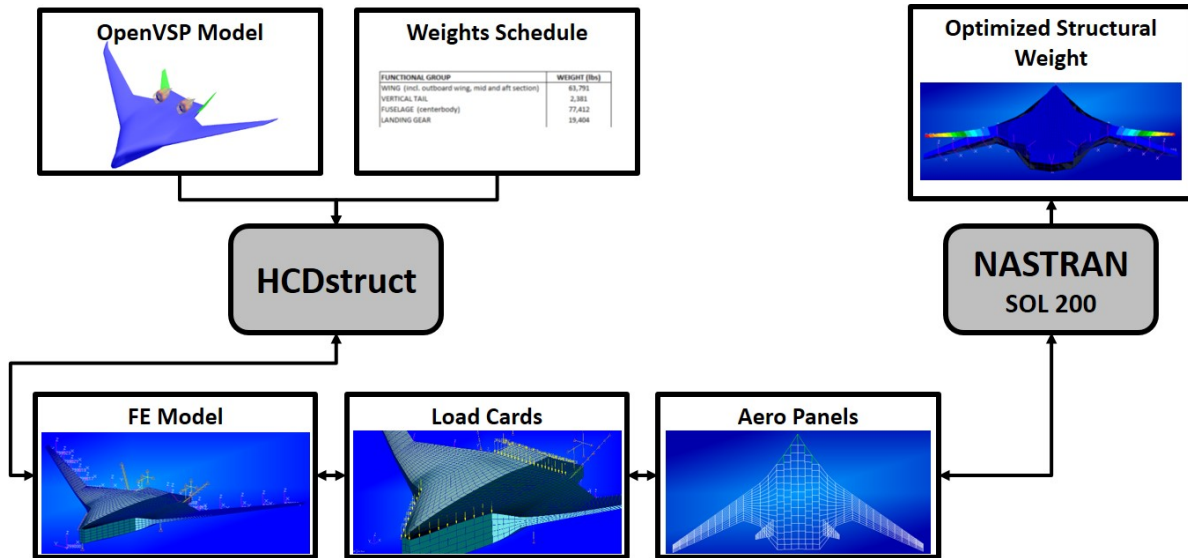

Figure 2. A notional flowchart detailing the general components of a structural optimization performed using HCDstruct.

Upon building the outer mold line (OML) in OpenVSP¹⁰ (or using any other suitable method) and sourcing basic vehicle geometry and weights data, HCDstruct utilizes a relatively small number of user inputs to construct a finite element model of the primary structure; to build the doublet-lattice aerodynamic panels and correction matrices; to configure all necessary sizing loads; and to configure all optimization design variables. These tasks are completed using a core set of Matlab scripts. These model data are translated and written to a complete set of bulk data files (BDF), which may then be executed directly by MSC NASTRAN¹¹ using SOLUTION 200 to perform a fully-aeroservoelastic optimization. This process is shown schematically in Fig. 2, where the optimized structural weight is output directly by NASTRAN.

The latest public release of HCDstruct utilizes a symmetric half-model finite element representation of the primary structure and aerodynamic panels, to which the full aircraft weight is applied. Concerns regarding the wing and structure overloading and associated trim response resulting from this approach prompted the development of a full wing-tip-to-wing-tip modeling capability; the full model version of HCDstruct is used exclusively in the current work. The modeled structural components include a pressurized centerbody, wing midsections, outboard wings, and an aft body section. Fifteen control surfaces are modeled, including thirteen elevons and two rudders. The aerodynamics are modeled using doublet-lattice aerodynamic panels that are constructed using the aircraft planform extracted from the OML. Aerodynamic corrections for the wing camber and twist distributions are also extracted from the OML.

Loads assumptions for commercial aircraft are outlined in Federal Aviation Regulations (FAR) Part 25,¹² and these assumptions drive the often thousands of load cases required to determine the limiting cases for aircraft in the final stages of design. At the conceptual design phase, however, a significantly smaller subset of load cases is used, and the development of critical load cases for HWB aircraft can be found in Ref. 13. For the current work, six load cases are used to constrain the structural optimization based on a worst-case analysis. These cases included:

1. 2.5-g limit load (full payload, zero fuel)
2. 2.5-g limit load (full payload, full fuel)
3. -1.0-g limit load (full payload, zero fuel)
4. -1.0-g limit load (full payload, full fuel)
5. 2.0-g taxi bump (full payload, full fuel)
6. 1.33P cabin overpressurization (centerbody only)

A safety factor of 1.5 is applied to limit load stress margins to model ultimate loads. With the current version of HCDstruct, the centerline symmetry boundary conditions were removed. Specifically, the leading point on the finite element model is now constrained using SPC1 cards for the x (streamwise) and y (spanwise) translational degrees of freedom and for the x (roll) and z (yaw) rotational degrees of freedom. SUPORT1 flags are used at the same leading point to apply reactionary forces in the z (vertical) translational degree of freedom and the y (pitch) rotational degree of freedom. The SOL 200 optimizer execution was limited to seven design cycles to be sure that the resulting design was physically-realizable; since SOL 200 uses a multi-constrained gradient-based search, in some cases the optimizer may remove so much structural mass that manufacturability becomes questionable. Thus, rather than using a hard convergence criterion, the optimizer execution was stopped once the region of marginal gains on the convergence history curve was reached.

III. Reference Cases

Previous applications of HCDstruct were limited to the Boeing OREIO reference case, and results agreed well with available Boeing data and FLOPS analyses. In the current study, the full-model version of HCDstruct is applied to two reference cases—the first being the Boeing OREIO configuration and the second being the Boeing ERA - 0009H1 concept, which is a derivative of the Boeing BWB - 0009A configuration. Since for both these cases Boeing performed significant structural sizing and optimization studies and researchers at NASA LaRC performed complementary FLOPS analyses, these cases present two opportunities to benchmark the latest version of HCDstruct, and the results for these two reference cases are presented below in sections III.A and III.B, respectively.

III.A. Boeing OREIO

The OREIO concept originated in 2010 when the Aeronautics Systems Analysis Branch at NASA LaRC commissioned Boeing to perform a systems analysis of an open rotor conceptual HWB design.¹⁴ The resulting concept has been used as a reference case in support of NASA’s Environmentally Responsible Aviation (ERA) project goals, as the configuration was designed for an entry into service by 2025 and test data from Boeing’s Low Speed Aeroacoustic Facility (LSAF)¹⁵ enabled overall noise and fuel burn performance analysis of an open rotor HWB concept. The systems-level study also considered the problem of propulsion airframe integration (PAI) with regard to the installation of open rotor engines on an HWB platform. A key strength to this case is the non-proprietary nature of the performance and design data, and the results of this reference case are included as an example test case in the HCDstruct distribution package.

Design requirements for the OREIO stemmed largely from the ERA project goals, which included reducing noise to 42 db cumulative below the Stage 4 certification level, reducing fuel burn by 50% as compared to current operational aircraft, and reducing emissions by 75% as measured using nitrogen oxide and the current standard level.¹⁶ The Mach number was set to 0.8, and NASA specified a freighter configuration with a 100,000 lb payload capacity and maximum wingspan of 65 m. To meet these requirements, Boeing performed systems-level optimizations using the Multidisciplinary Design Optimization (MDOPT)¹⁷ framework, which is an aerodynamic and multidisciplinary constrained optimization based on a design of experiments approach. A thin layer Navier-Stokes (TLNS) CFD solver was coupled to the optimizer, and only the wing and body were modeled to limit computational meshing requirements. A lift coefficient of 0.25 and altitude of 35,000 ft were assumed. Upon MDOPT optimization completion, the near-field pressure distribution was smoothed using CDISC,¹⁸ which is a CFD based inverse design tool coupled to the CFL3D¹⁹ flow solver. The final OREIO geometry was manually smoothed and is shown in Fig. 3. A detailed weight breakdown was published by Boeing in Ref. 14, which serves as the baseline for the current effort.

III.A.1. Finite Element Model

A three-dimensional model of the OREIO was built using OpenVSP based on the three-view drawings presented in Fig. 3, which included the full OML, vertical tails, engine systems, and the centerbody. A rendering of the full OML, with engines and vertical tails, is presented in Fig. 4. This OML is used by HCDstruct, in conjunction with a small set of user-defined input data, to build the primary structural components and aerodynamic model. Slices of the OML provide spatial bounds for the primary structure, and wing section slices of the OML provide camber and twist distributions required for the aerodynamic model.

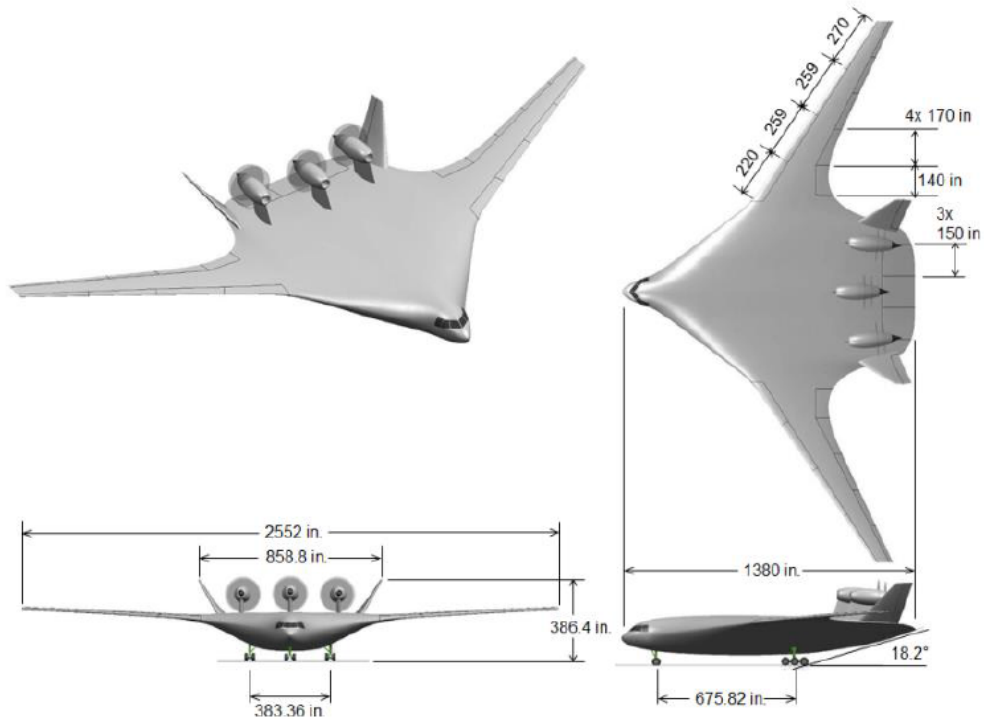

Figure 3. A three-view drawing of the Boeing OREIO concept including relevant dimensions.¹⁴

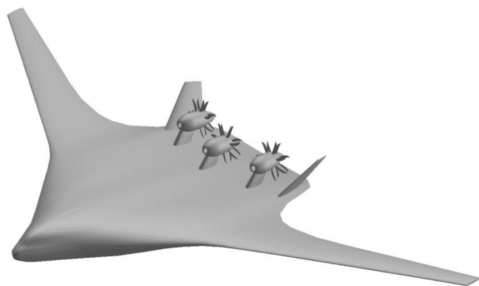

Figure 4. The OREIO OML rendered using OpenVSP.

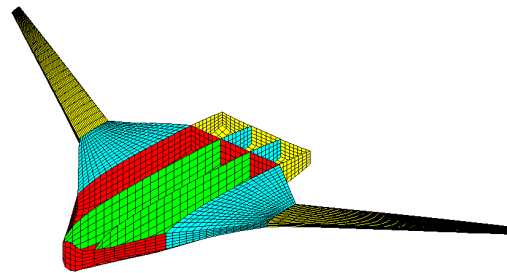

Figure 5. The primary structural components for the OREIO modeled using HCDstruct.

The centerbody was architected using the "home plate" convention introduced by Nickol and McCullers,²⁰ for which the leading point of the centerbody coincides with the leading point of the OML. The cabin body planform then takes on the shape of a "home plate," for which the wing midsections attach to the centerbody side walls and the aft body attaches to the centerbody rear wall. The current version of HCDstruct also permits a user-defined cockpit bulkhead placement. Both the centerbody and aft body are comprised of three internal bays. The front and rear wing spars are set to 12.5% and 62.5% chord location in order to simulate the front wing spar placement and rear control surface hingeline, respectively. The complete primary structure is shown in Fig. 5.

HCDstruct constructs each of the primary structural components using CQUAD4¹¹ elements. A depiction of the complete finite-element OREIO model, including the aerodynamic surfaces, primary structural components, vertical tails, engine systems, landing gear, and control surfaces is presented in Fig. 6. The structural model was comprised of 6080 shell elements (CQUAD4), 83 concentrated masses (CONM2), and 44 rigid bar elements (RBAR1), and the aerodynamic model consisted of 76 doublet-lattice aerodynamic panels (CAERO1). Structural optimization results using NASTRAN SOL 200 are presented in the following section.

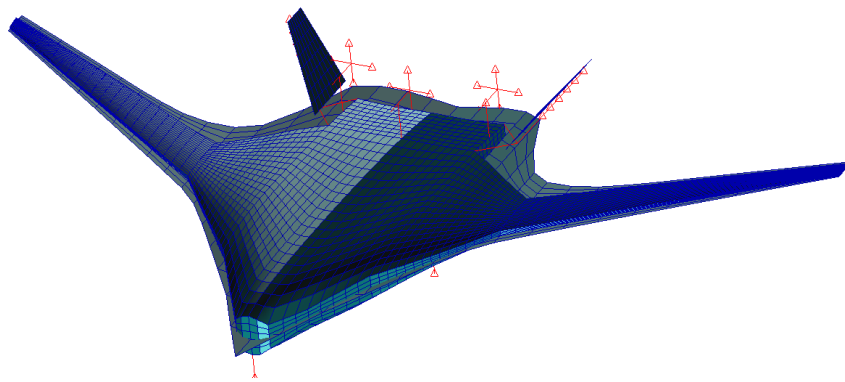

Figure 6. A NASTRAN rendering of the full OREIO model, including the aerodynamic panels, the primary structural components, the vertical tails, engine systems, landing gear, and control surfaces.

III.A.2. Structural Optimization Results

The aeroelastic finite element model built by HCDstruct was optimized using NASTRAN SOL 200, and the optimized structural weights were compared to those of the original Boeing MDOPT analysis and to those of a similar FLOPS analysis. These results are shown in Fig. 7, where the total structural weight is shown comprised of its constituent components. Since the cockpit is not included in the finite element model for HCDstruct, it is reported separately; the cockpit weight is included in the centerbody weights for the Boeing and FLOPS results. From left to right in Fig. 7, results are presented using the current version of HCDstruct, for Boeing's MDOPT analysis, and for a FLOPS analysis. The total structural weight and centerbody weight predicted by HCDstruct are within approximately 1% of that of the Boeing MDOPT analysis, whereas the wing agrees to within approximately 10%. While bounded by the Boeing and FLOPS results, the aft body weight predicted by HCDstruct is considerably higher than that of the Boeing MDOPT prediction. Due to the maximally-stressed nature of the HCDstruct finite-element model optimization, the additional weight of the aft body relieves the wing of some loading, which ultimately results in a total structural weight still inline with that of the Boeing MDOPT analysis. As was seen in previous studies⁵⁻⁷, the aft body structural weight poses the most sizing uncertainty for the current analysis.

III.B. Boeing ERA - 0009H1

The second reference case for HCDstruct utilized the ERA - 0009H1 concept,²¹ which is a derivative of the earlier Boeing ERA - 0009A concept²² and was developed in preparation for the ERA Integrated Technology Demonstrator (ITD) - 51A BWB demonstrator project.²³ Design of the ERA - 0009H1 was targeted foremost at meeting key performance metrics and ERA goals, but also at rectifying design issues observed through

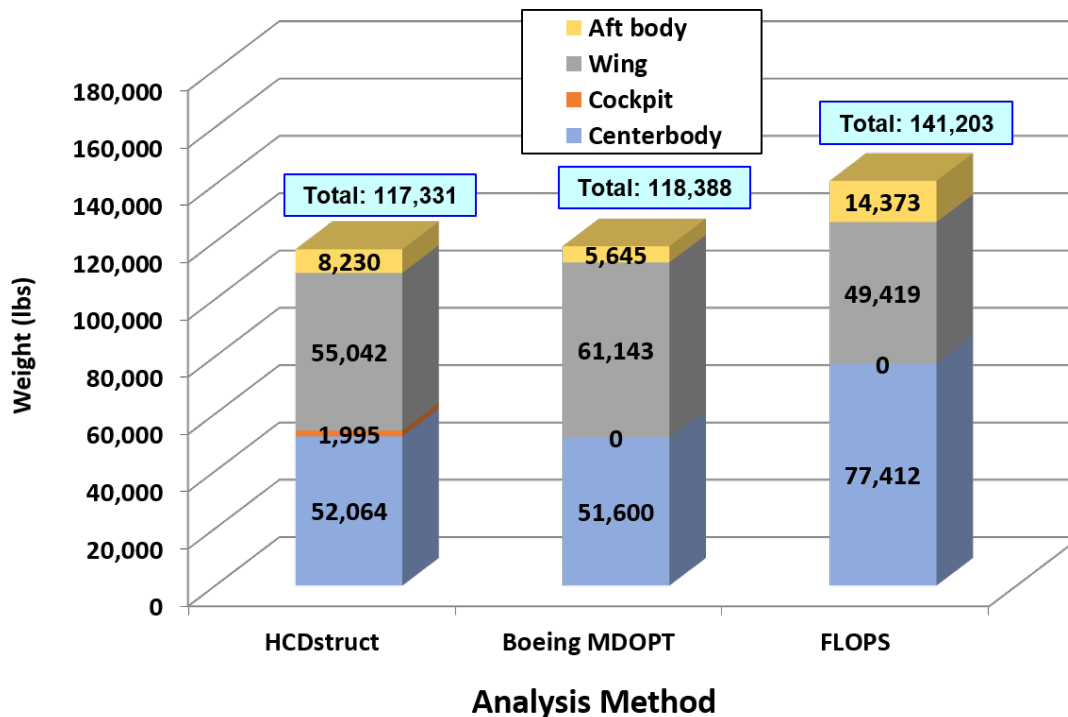

Figure 7. Comparisons of the optimized structural weights for the OREIO concept using HCDstruct to those of the detailed Boeing analysis and related FLOPS analyses.

related program testing. Particular attention was devoted to the planform, propulsion aerodynamic integration, high lift system, and propulsion system sizing and integration. Additionally, performance metrics for the ITD - 51A project included:

- low speed inlet distortion,
- low speed inlet recovery,
- engine installation drag penalty at cruise,
- engine position relative to the body trailing edge for noise,
- maximum lift coefficient at takeoff and landing, and
- cruise lift to drag ratio.

A complete discussion of the ERA - 0009H1 design and supporting analysis may be found in Ref. 21. A three-view depiction of the ERA - 0009H1 concept is shown in Fig. 8. Comparing to Fig. 3, the ERA - 0009H1 concept employs a slightly larger wing span and total length as compared to the OREIO concept. Furthermore, the ERA - 0009H1 utilizes two geared turbofan Pratt & Whitney engines, versus the three open rotor engines used for the OREIO. Overall, however, the concepts share considerable geometric resemblance.

III.B.1. Finite Element Model

A three-dimensional model of the ERA - 0009H1 was built using OpenVSP based on the three-view drawings presented in Fig. 8, which included the full OML, vertical tails, engine systems, and the centerbody. A rendering of the full OML, along with engines and vertical tails, is presented in Fig. 9. This OML was used by HCDstruct to build the primary structural components, as well as to construct the camber- and twist-corrected aerodynamic model. The centerbody was architected using the same "home plate" convention used for the OREIO, and the resulting primary structure is shown in Fig. 10. A depiction of the complete finite-element model, including the aerodynamic surfaces, primary structural components, vertical tails, engine

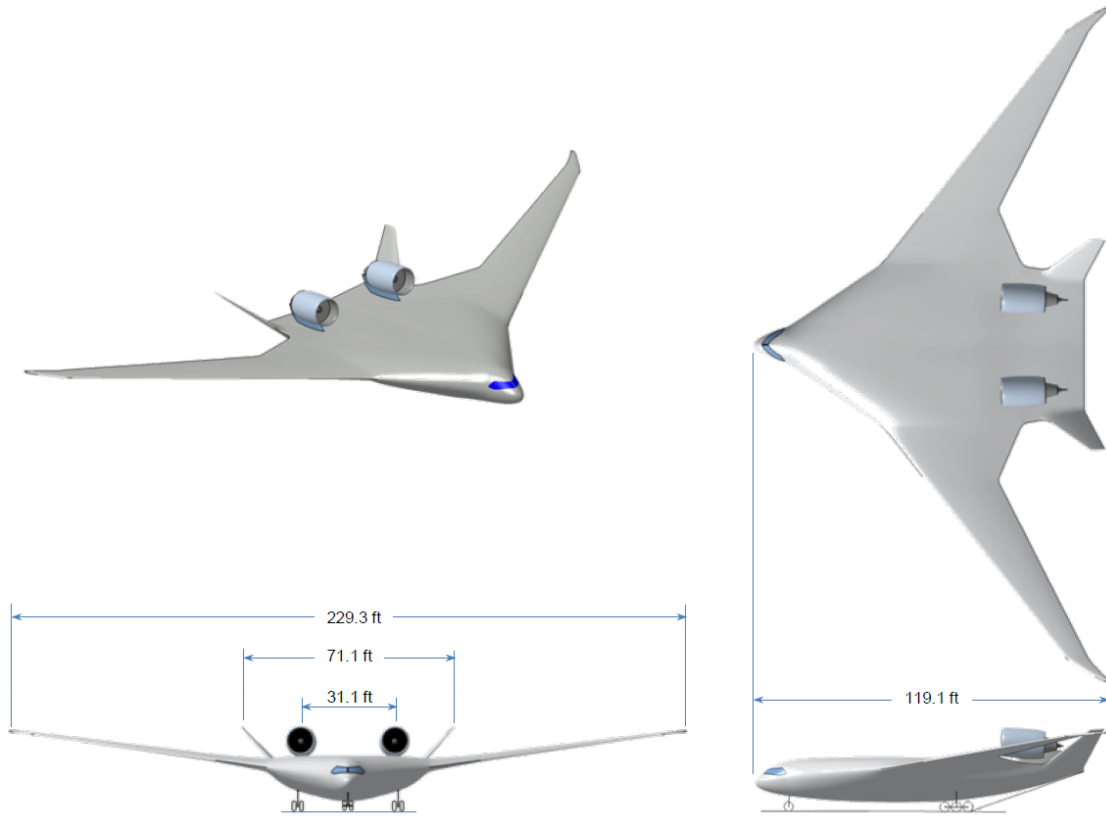

Figure 8. A three-view drawing of the ERA - 0009H1 concept including relevant dimensions.²¹

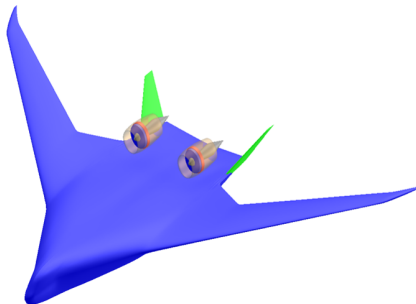

Figure 9. The ERA - 0009H1 OML rendered using OpenVSP.

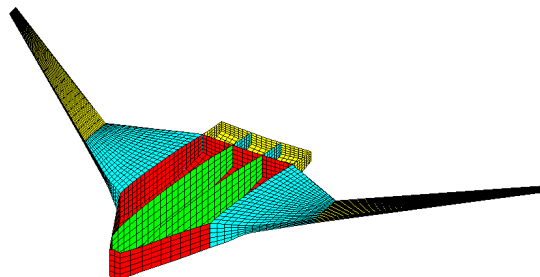

Figure 10. The primary structural components for the ERA - 0009H1 modeled using HCDstruct.

systems, landing gear, and control surfaces is presented in Fig. 11. The structural model was comprised of 6080 shell elements (CQUAD4), 77 concentrated masses (CONM2), and 37 rigid bar elements (RBAR1), and the aerodynamic model consisted of 76 doublet-lattice aerodynamic panels (CAERO1).

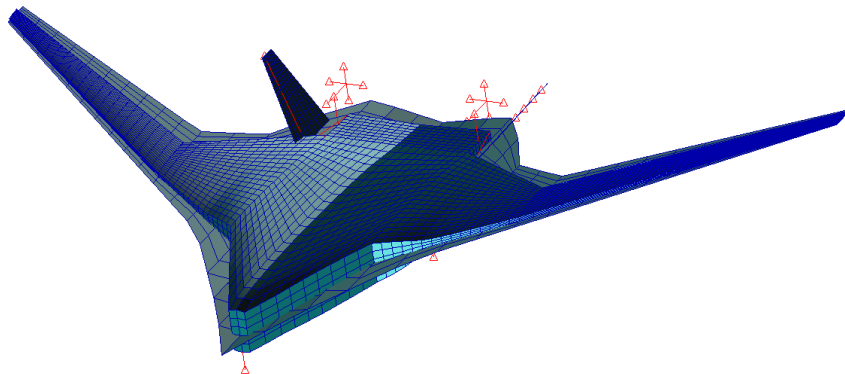

Figure 11. A NASTRAN rendering of the full ERA - 0009H1 model, including the aerodynamic panels, the primary structural components, the vertical tails, engine systems, landing gear, and control surfaces.

III.B.2. Structural Optimization Results

The aeroelastic finite element model was optimized using NASTRAN SOL 200, and the optimized structural weights were compared to those of the original Boeing design and to those of a similar FLOPS analysis. These results are shown in Fig. 12, where the total structural weight is shown comprised of its constituent components. Since the cockpit is not included in the finite element model for HCDstruct, it is reported separately; the cockpit weight is included in the centerbody weights for the Boeing and FLOPS results.

From left to right in Fig. 12, results are presented using the current version of HCDstruct, for Boeing's design, and for a FLOPS analysis. The total structural weight predicted by HCDstruct is within approximately 1.5% of that of the Boeing design, whereas the wing and centerbody agree to within approximately 7% and 1%, respectively. The aft body weight predicted by HCDstruct is considerably lower than that of both the Boeing design and the FLOPS analysis. While the aft body structure still presents a considerable sizing uncertainty, more importantly, the maximally-stressed optimization approach used by HCDstruct recovers the total structural weight well.

IV. NASA HWB Study

Following the OREIO and ERA - 0009H1 reference applications used to benchmark the current version of the code, HCDstruct was used to analyze the NASA HWB concepts put forth by Nickol,²⁴ who performed a sizing study using five familial concepts to develop a better understanding of the functional relationship between HWB fuel burn performance and size. A summary of the five concepts used in the original scaling study is included in Table 1. The smallest concept was designed to carry 98 passengers, while the largest was sized to carry 400. Each of the five concepts shown in Table 1 was designed as a comparable replacement for a current, conventional, transport aircraft. For the current study, HCDstruct was used to perform a scaling study using the three largest HWB concepts.

IV.A. NASA HWB Concept

The three NASA HWB concepts analyzed for the current study included the HWB216, HWB301, and HWB400, which were designed to carry 216, 301, and 400 passengers, respectively. The three concepts were designed for flight conditions summarized in Table 1, with design ranges varying from 5,800 to 7,500 nautical miles (nmi) at cruise Mach numbers of 0.80 - 0.85. With wing spans of 210, 240, and 260 ft, respectively, the HWB216, HWB301, and HWB400 aircraft were designed to fill an operational role in 2025 as small twin aisle, large twin aisle, and very large transports, similar to those of the Boeing 767-200ER, 777-200LR,

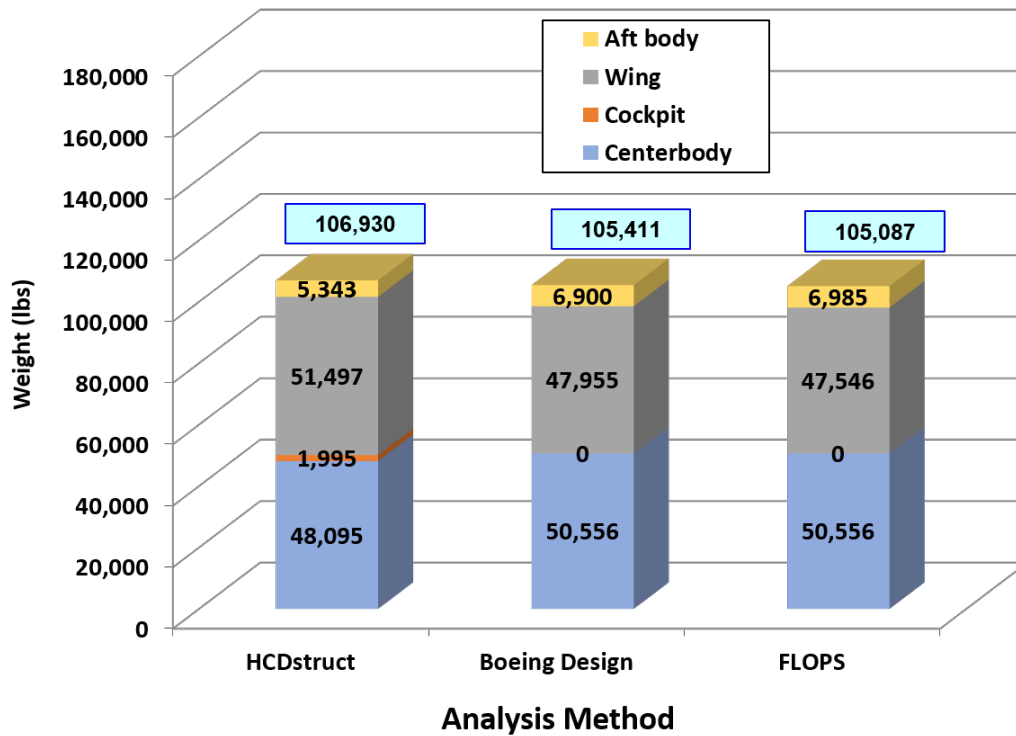

Figure 12. Comparisons of the optimized structural weights for the ERA - 0009H1 concept using HCDstruct to those of the detailed Boeing analysis and related FLOPS analyses.

Table 1. Summary of HWB concepts used for scaling study of Nickol.²⁴

Vehicle Class Size	Number of Passengers	Design Range [nmi]	Cruise Mach Number	Cruise Altitude [ft]	Cruise Lift Coefficient	Designation
Regional jet	98	2,400	0.78	39,000	0.17	HWB98
Large single aisle	160	2,875	0.78	39,000	0.19	HWB160
Small twin aisle	216	6,600	0.80	38,000	0.18	HWB216
Large twin aisle	301	7,500	0.84	35,000	0.22	HWB301
Very large	400	5,800	0.85	35,000	0.22	HWB400

and 747-400 aircraft. Of particular importance, the general size and layout of the HWB301 is similar to both the OREIO and ERA - 0009H1 reference cases. In this section, HCDstruct is used to optimize the primary structural mass of the three NASA HWB concepts summarized in Table 1 using NASTRAN SOL 200, and results are compared to corresponding FLOPS analyses. Subsequent investigations into the scaling of structural weight with passenger capacity are also discussed.

IV.A.1. Finite Element Model

Three-dimensional models of the HWB216, HWB301, and HWB400 were constructed using OpenVSP that included the OML, the vertical tails, and the propulsion systems. The HWB216 and HWB301 used a two-engine configuration, similar to the ERA - 0009H1, while the HWB400 used a three-engine configuration similar to the OREIO. Renderings of the three NASA HWB OpenVSP models are shown in Fig. 13. Each centerbody was sized using the same "home plate" archetype discussed in section III.A.1. The same high

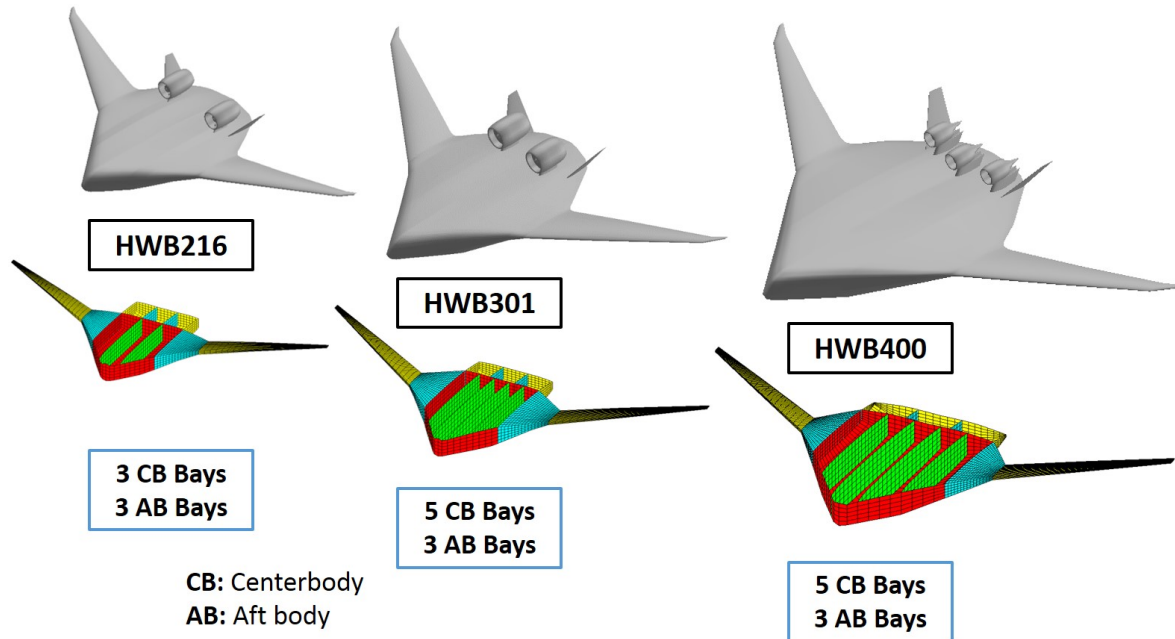

Figure 13. An overview of the three NASA HWB concepts analyzed using HCDstruct, where renderings of OpenVSP models are shown at the top of the figure and the corresponding finite-element structural models are shown at the bottom of the figure with annotations highlighting the centerbody and aft body internal bay configurations.

level structural topology was used to construct each of the NASA HWB finite element models as before, consisting of centerbody, wing midsection, outboard wing, and aft body components as shown in Fig. 13 for each concept. Due to the smaller size of the HWB216 and based on previous efforts,⁵ a 3-bay centerbody architecture was used, whereas for the HWB301 and HWB400 a 5-bay centerbody architecture was employed. By including additional internal walls, while maintaining passenger spacing requirements, the centerbody structure benefits from the added rigidity and reduced pillowing-effect, which subsequently permits lower total structural weight requirements by greater displacement relief. An aft body sensitivity study was performed on the number of internal bays, which indicated a general insensitivity to the detailed aft body configuration. This general insensitivity suggested that the HCDstruct aft body predictions were largely driven by physical considerations, such as the applied loadings of the propulsion systems and the aerodynamic forces on the vertical tails and rear control surfaces. Therefore, the aft body was constructed using three bays for each NASA HWB configuration, similar to that of the reference cases.

Due to the lack of published data on the NASA HWB control surfaces, an area-based sizing approach was used to set the location of the aft body rear spar and hingeline and is illustrated in Fig. 14. An area-based approach was used due to the significant curvature of the OML trailing edge (TE). If one assumes that the ratio of control surface area rear of the aft body to total area behind the rear centerbody spar is approximately constant across BWB concepts due to stability and control considerations, then the rear aft body spar location may be set using data from a reference case. For the current approach, the control

surfaces rear of the aft body are approximated as a trapezoid, for which the control surface area, A_{CS} , may be approximated as

$$A_{CS} \approx \frac{1}{2}Y(X_2 + X_3) \quad (1)$$

where Y , X_2 , and X_3 are the aft body width, the centerline distance from the rear aft body spar to the OML TE, and the distance from the rear aft body spar at the aft body side wall to OML TE, respectively, as shown in Fig. 14. With the aft body area, A_{AF} , given simply by

$$A_{AF} = YZ \quad (2)$$

where Z is the length of the aft body, the distance of the aft body rear spar from the rear spar of the centerbody may be easily set according to

$$Z = \frac{1}{2}\phi(X_1 + X_4) \quad (3)$$

where ϕ is a measure of the control surface-to-aft body area ratio and is given by

$$\phi \equiv \frac{A_{CS}}{A_{CS} + A_{AF}} \Big|_{REF} \quad (4)$$

For the reference cases, $\phi \approx 0.52$, which was used to set the rear aft body spar location for each of the

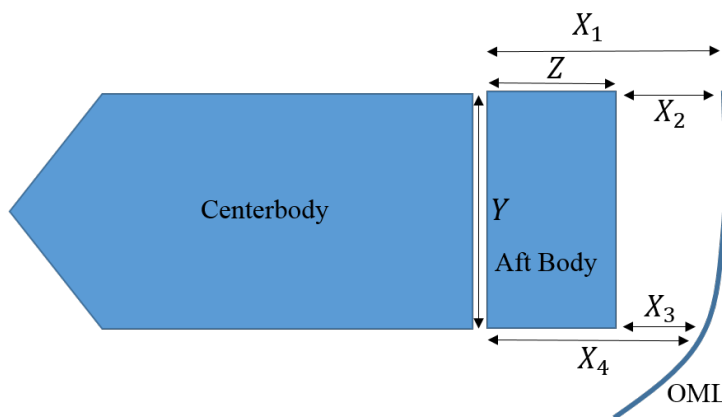

Figure 14. An illustration of the area-based approach for setting the location of the aft body rear spar and hingeline for the primary elevon control surfaces.

NASA HWB concepts. The resulting finite element models are shown in Fig. 15 and include the primary structure, the vertical tails, engine systems, landing gear, aerodynamic panels, and control surfaces. These models were input directly to NASTRAN SOL 200 to perform the structural optimizations, for which results are presented in the following section.

IV.A.2. Structural Optimization Results

Results of the NASTRAN SOL 200 structural optimizations for the HWB216, HWB301, and HWB400 are compared to corresponding FLOPS analyses in Fig. 16. The optimized structural weights generally show good agreement with the total structural weights predicted by FLOPS, where the HWB216, HWB301, and HWB400 results agree to within approximately 2%, 1%, and 6%, respectively. The centerbody agreement is also quite good, where the differences compared to the FLOPS centerbody predictions are generally less than 3%.

While more disagreement with the FLOPS results is generally apparent at the component level, the fully-stressed nature of the optimization process again ensures good agreement at the total structural level. Similar to the reference cases, the aft body appears to represent a significant source of uncertainty, as evidenced by the considerable underprediction relative to FLOPS for the HWB216 and overprediction relative to FLOPS for the HWB400. A compounding source of error in the aft body prediction may be the constant ϕ used to specify the rear aft body spar location and control surface hingeline. Because of the general differences in vehicle size and the better aft body weight comparisons to FLOPS for the HWB301, the constant ϕ assumption based on the reference cases may be inadequate for the current application.

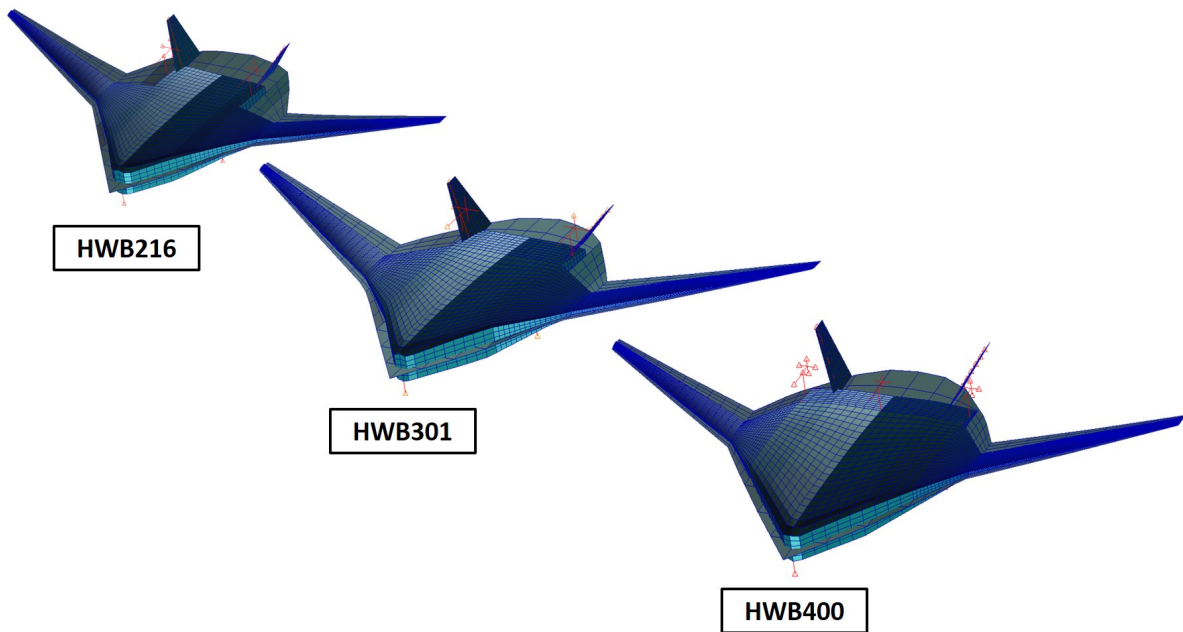

Figure 15. NASTRAN renderings of the full HWB216, HWB301, and HWB400 models, including the aerodynamic panels, the primary structural components, the vertical tails, engine systems, landing gear, and control surfaces.

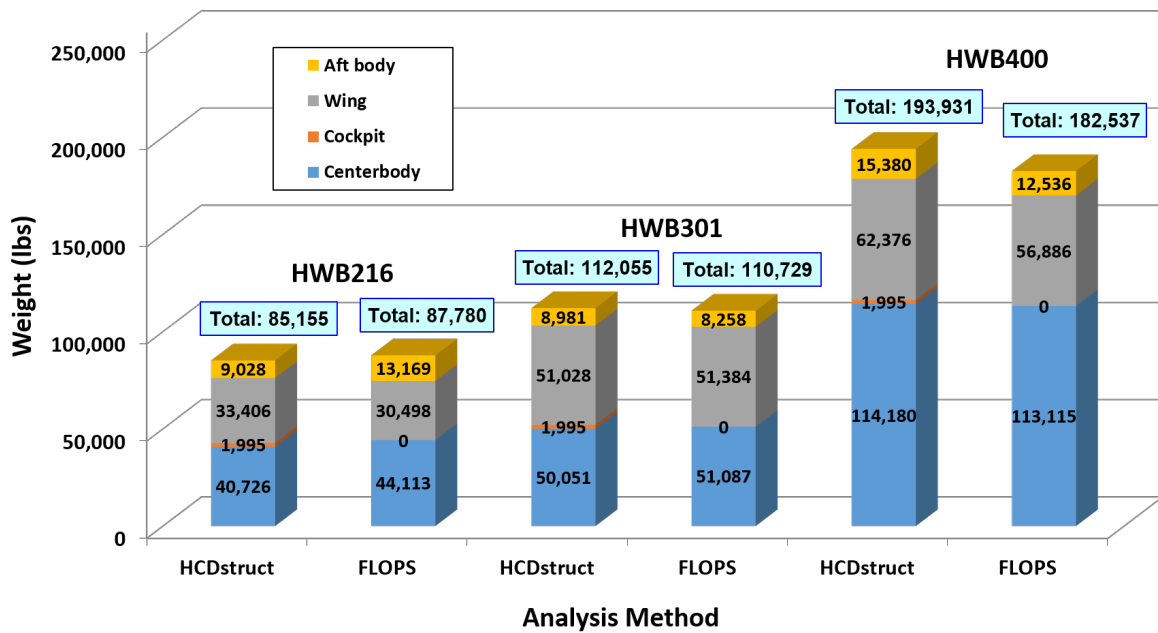

Figure 16. Comparisons of the optimized structural weights for the HWB216, HWB301, and HWB400 using HCDstruct and FLOPS.

IV.B. Scaling Study

Since earlier HWB studies focused on the projected benefits at very large passenger capacities—on the order of 800 or more—a scaling study focused on the structural weight and passenger capacity is necessary to quantify the benefits for smaller target applications, such as HWB surrogates for small twin-aisle tube-and-wing transports. Significant work toward demonstrating this scaling was performed in earlier studies in which a clear advantage was demonstrated for using 3 bay centerbody layouts for configurations smaller than approximately 270 pax and 5 bay centerbody layouts otherwise.^{5,6,24} The driving factor for reducing the number of centerbody bays with passenger capacity stemmed from required cabin open spaces; while increasing the number of centerbody bays provides additional centerbody displacement relief, for smaller concepts, passenger space requirements typically drive the cabin layout. At higher passenger capacities, with necessarily wider centerbodies, the limiting number of internal walls based on passenger space constraints increases.

To investigate the structural weight scaling of the NASA HWB with passenger capacity, the component-level primary structural weight results are shown as a function of passenger capacity in Fig. 17. Inline with the earlier work of Gern^{5,6} and Nickol²⁴, the HWB216 centerbody employed a 3 bay centerbody layout, whereas the HWB301 and HWB400 used 5 bay centerbody layouts. The centerbody structural weight results from Ref. 6 are also shown on Fig. 17. In comparing Fig. 17 to findings of previous studies, the

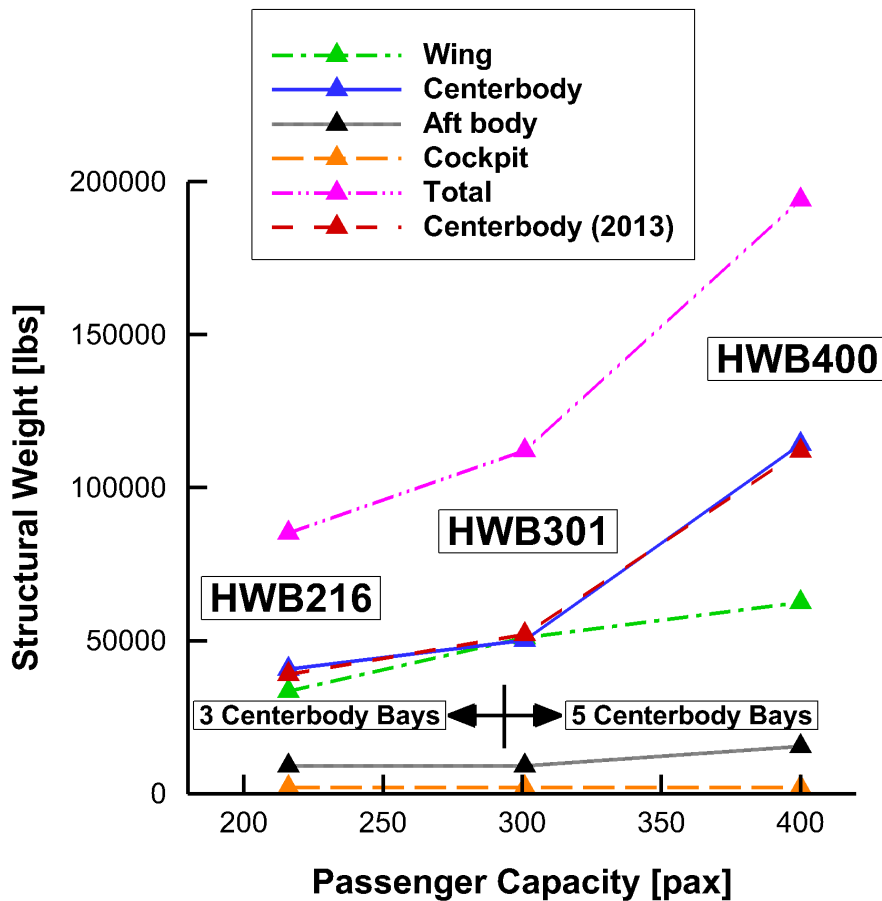

Figure 17. Primary structural component weights for cases HWB216, HWB301, and HWB400 shown as a function of passenger capacity to demonstrate configuration scaling. Centerbody data from an earlier study by Gern⁶ are also shown.

same centerbody scaling is apparent; the centerbody structural weight results match closely those of Ref. 6. Of particular interest, the total structural weight scaling with passenger capacity closely resembles that of the centerbody scaling, whereas the wing structure, aft body structure, and cockpit weights show a much more linear scaling with passenger capacity. Thus, the current scaling study suggests that the total vehicle

structural weight scales similarly to the centerbody structural weight, which is driven primarily by passenger space requirements and by displacement relief. This study affirms the considerable importance in structural design and layout of the centerbody, as well as the importance of the cabin overpressurization load case used to constrain the centerbody structural requirements for advanced HWB concepts.

V. Conclusions

In the current study, the latest version of HCDstruct was used to perform structural optimizations of several advanced BWB aircraft concepts in support of NASA's ERA project. Two reference cases, including the Boeing OREIO and the Boeing ERA - 0009H1, were studied in order to benchmark the current wing-tip-to-wing-tip model formulation implemented in HCDstruct. The results for both reference cases demonstrated reasonable agreement with both Boeing design data and FLOPS analysis results and suggested the aft body is responsible for significant uncertainty in the model formulation.

Following the two reference cases, HCDstruct was used to model the family of NASA HWB concepts. Results compared favorably to a FLOPS analysis for total structural weights, with more disagreement found at the component level where the aft body remained a significant source of uncertainty. An aft body sensitivity study on the number of internal bays and rear hingeline specification indicated a general insensitivity to the detailed aft body configuration, and therefore suggests that the HCDstruct aft body predictions are largely driven by physical considerations, such as the applied loadings of the propulsion systems and the aerodynamic forces on the vertical tails and rear control surfaces. Additionally, an area-based method for specifying the aft body rear spar location was found to provide improved optimized structural weight results.

A scaling study was performed using the HWB216, HWB301, and HWB400 configurations, and component-level scalings with passenger capacity suggested the total structural weight scales similarly to the centerbody structural weight, which is driven primarily by internal cabin layout and displacement relief. Wing, aft body, and cockpit weights varied approximately linearly with passenger capacity. The results of the scaling study further affirmed the importance of including the cabin overpressurization load case, which serves to size the centerbody structure.

Acknowledgments

The authors thank Craig Nickol for many helpful discussions. This work was supported primarily by NASA's Environmentally Responsible Aviation (ERA) project, with additional support provided by the NASA Pathways Program.

References

- ¹Liebeck, R. H., "Design of the BWB Subsonic Transport," *40th AIAA Aerospace Sciences Meeting and Exhibit*, Reno, NV, January 2002.
- ²Risch, T., Cosentino, G., Regan, C. D., Kisska, M., and Princen, N., "X-48B Flight-Test Progress Overview," *47th AIAA Aerospace Sciences Meeting and Exhibit*, Orlando, FL, January 2009.
- ³McCullers, L. A., *FLOPS Flight Optimization System*, FLOPS Users Manual, December 2009.
- ⁴Gern, F. H., "Improved Aerodynamic Analysis for Hybrid Wing Body Concept Design Optimization," *50th AIAA Aerospace Sciences Meeting and Exhibit*, Nashville, TN, January 2012.
- ⁵Gern, F. H., "Finite Element Based HWB Centerbody Structural Optimization and Weight Prediction," *53rd AIAA/ASME/ASCE/AHS/ASC Structures, Structural Dynamics, and Materials Conference*, Honolulu, HI, April 2012.
- ⁶Gern, F. H., "Conceptual Design and Structural Analysis of an Open Rotor Hybrid Wing Body Aircraft," *54th AIAA/ASME/ASCE/AHS/ASC Structures, Structural Dynamics, and Materials Conference*, Boston, MASS, April 2013.
- ⁷Gern, F. H., "Update on HCDstruct-A Tool for Hybrid Wing Body Conceptual Design and Structural Optimization," *15th AIAA Aviation Technology, Integration, and Operations Conference*, Dallas, TX, June 2015.
- ⁸Bradley, K. R., "A Sizing Methodology for the Conceptual Design of Blended-Wing-Body Transports," Tech. rep., NASA/CR-2004-213016, NASA Langley Research Center, Hampton, VA, September 2004.
- ⁹Li, V. and Velicki, A., "Advanced PRSEUS Structural Concept Design and Optimization," *12th AIAA/ISSMO Multi-disciplinary Analysis and Optimization Conference*, Victoria, British Columbia, Canada, September 2008.
- ¹⁰Hahn, A., "Vehicle Sketch Pad: A Parametric Geometry Modeler for Conceptual Aircraft Design," *48th AIAA Aerospace Sciences Meeting and Exhibit*, Orlando, FL, January 2010.
- ¹¹*MSC Nastran 2008, Quick Reference Guide*, MSC Software Corporation, Santa Ana, CA, 2008.
- ¹²*Federal Aviation Regulations Part 25-Airworthiness Standards: Transport Category Aircraft*, US Department of Transportation, 1974.

- ¹³Velicki, A., "Damage Arresting Composites for Shaped Vehicles," Tech. rep., NASA/CR-2009-215932, NASA Langley Research Center, Hampton, VA, September 2009.
- ¹⁴Pitera, D. M., DeHaan, M., Brown, D., Kawai, R. T., Hollowell, S., Camacho, P., Bruns, D., and Rawden, B. K., "Blended Wing Body Concept Development with Open Rotor Engine Integration," Tech. rep., NASA/CR-2011-217303, The Boeing Company, Huntington Beach, CA, November 2011.
- ¹⁵Czech, M. J., "Experimental Studies of Open Rotor Installation Effects," *3rd AIAA Atmospheric Space Environments Conference*, Honolulu, HI, June 2011.
- ¹⁶Collier, F. S., Thomas, R., Nickol, C. A., and Lee, Chi-Ming, T. M., "Environmentally Responsible Aviation—Real Solutions for Environmental Challenges Facing Aviation," *27th International Congress of the Aeronautical Sciences*, Nice, France, September 2010.
- ¹⁷LeDoux, S. T., Herling, W. W., Fatta, G. J., and Ratcliff, R. R., "MDOPT—A Multidisciplinary Design Optimization System using Higher Order Analysis Codes," *10th AIAA/ISSMO Multidisciplinary Analysis and Optimization Conference*, Albany, NY, September 2004.
- ¹⁸Johnson, F. T., Tinoco, E. N., and Yu, N. J., "Thirty Years of Development and Application of CFD at Boeing Commercial Airplanes, Seattle," *16th AIAA Computational Fluid Dynamics Conference*, Orlando, FL, June 2003.
- ¹⁹Krist, S. L., Biedron, R. T., and Rumsey, C. L., *CFL3D User's Manual (Version 5.0)*, NASA Langley Research Center, Hampton, VA, June 1998.
- ²⁰Nickol, C. L. and McCullers, L. A., "Hybrid Wing Body Configuration System Studies," *47th AIAA Aerospace Sciences Meeting and Exhibit*, Orlando, FL, January 2009.
- ²¹Bonet, J. T., Dickey, E., Princen, N., Sexton, M., Beyar, M., Tompkins, D. M., Kawai, R., Camacho, P., and Elmer, K., "Environmentally Responsible Aviation (ERA) Project - Hybrid Wing Body Engine/Airframe Operability Testing Final Report," Tech. rep., NASA/CR-2015-In Press, NASA Langley Research Center, Hampton, VA, June 2015.
- ²²Bonet, J. T., "Boeing ERA N+2 Advanced Vehicle Concept Results," *50th AIAA Aerospace Sciences Meeting*, January 2012.
- ²³Flamm, J. D., James, K. D., and Bonet, J. T., "Overview of ERA Integrated Technology Demonstration (ITD) 51A Ultra-High Bypass (UHB) Integration for Hybrid Wing Body (HWB)," *AIAA Science and Technology Forum and Exposition*, San Diego, CA, January 2016.
- ²⁴Nickol, C., "Hybrid Wing Body Configuration Scaling Study," *50th AIAA Aerospace Sciences Meeting and Exposition*, Nashville, TN, January 2012.