



# A Simple Method for High-Lift Propeller Conceptual Design

---

5 January 2016

Michael Patterson, Nick Borer,  
*NASA Langley Research Center*  
and Brian German  
*Georgia Institute of Technology*

# Presentation Outline

- Introduction
- Motivation
- High-Lift Propeller Design Method & Examples
- Conclusions & Future Work

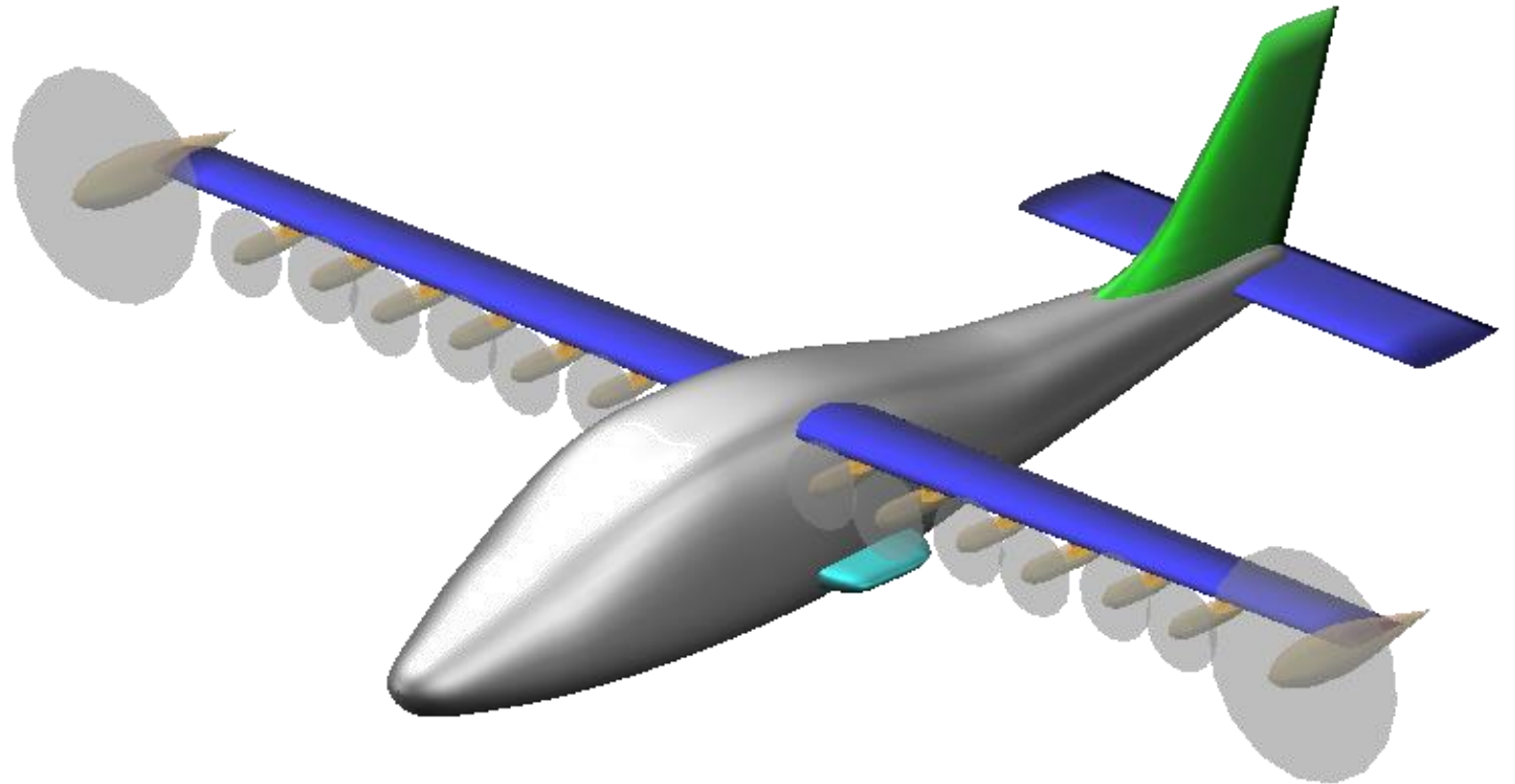

NASA's Scalable Convergent Electric Propulsion Technology and Operations Research (SCEPTOR) distributed electric propulsion concept



# Introduction

---

# Electric motors enable propellers to be installed in non-traditional, beneficial manners

- Electric motors have distinctly different characteristics than conventional engines
  - Lower weight and volume
  - Reduced vibration
  - Nearly “scale-invariant”
- Wing tip props can reduce induced drag / increase propulsive efficiency
- “High-lift props” placed upstream of a wing can increase lift
- Others...

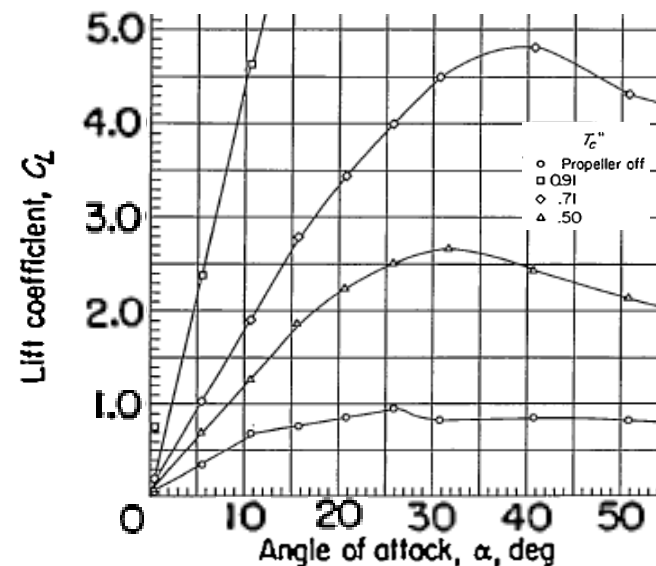
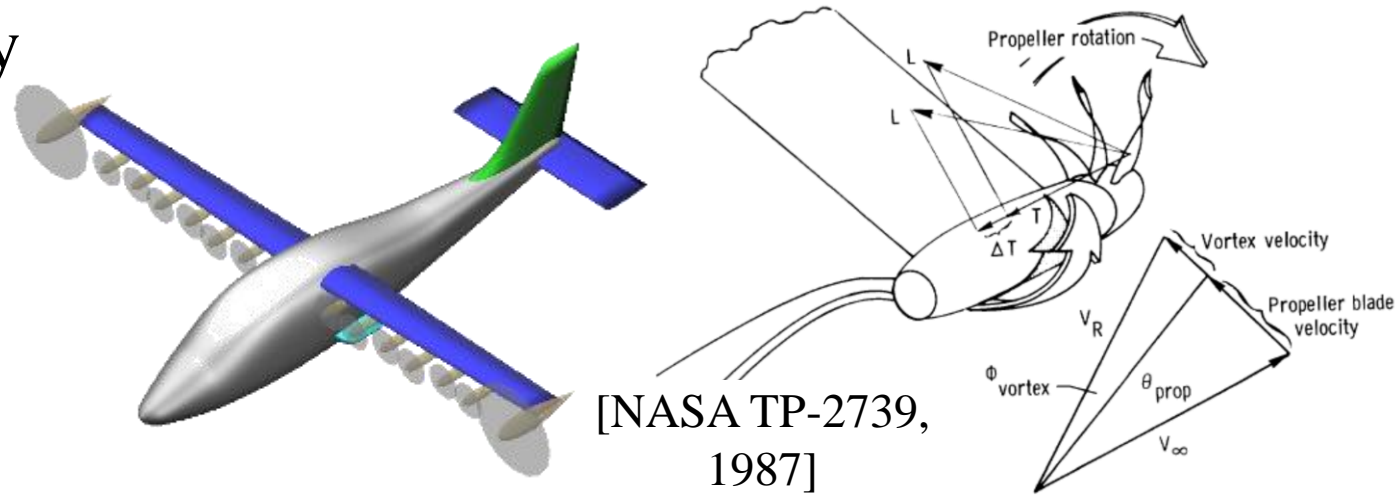

[NASA TR-1263, 1956]

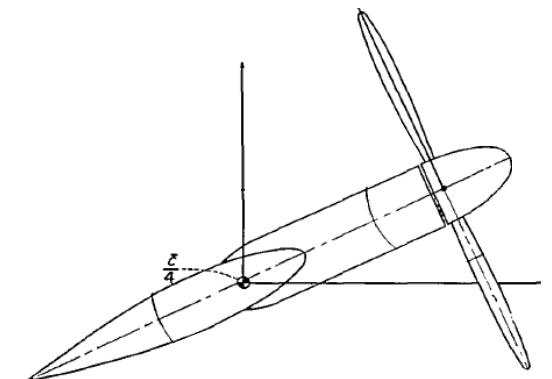

# Effect of prop slipstreams on downstream wings is complex, but can be approximated with a simple model

- Propellers induce axial and tangential (“swirl”) velocities
- High-lift props alter the zero-lift angle of attack and lift curve slope of downstream wing sections
- Wing upwash impacts inflow to prop disk
- To first-order, prop impacts on lift can be assessed via a single, average induced axial velocity
  - Small wing impacts on prop
  - Swirl affects on either side of disk “cancel out”

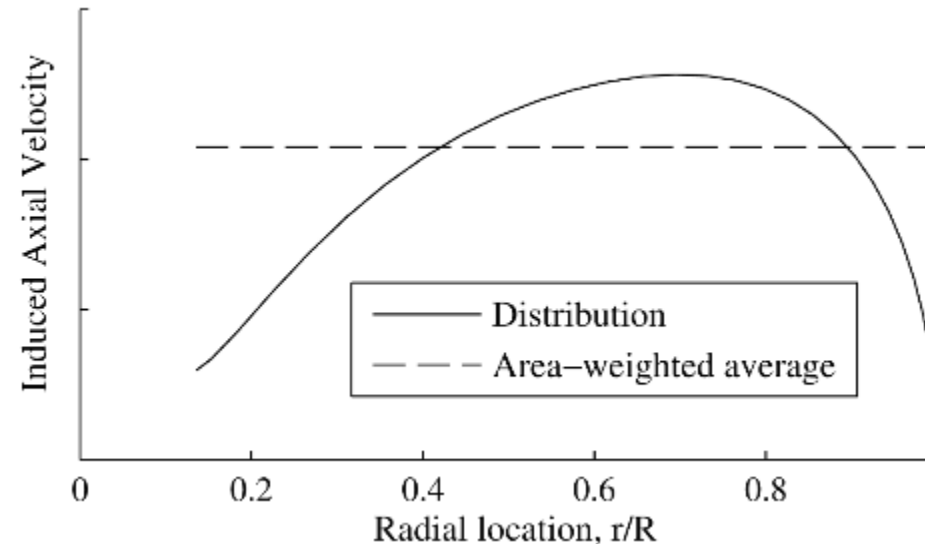
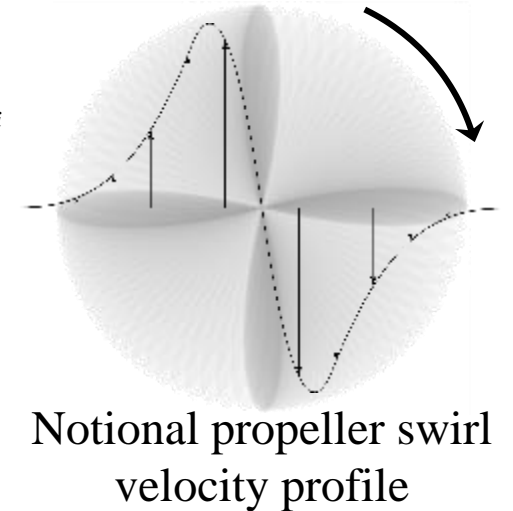
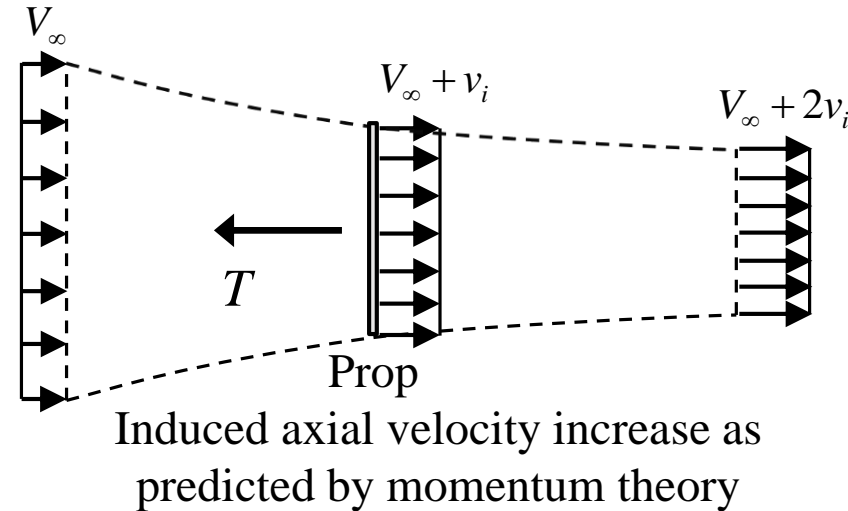

Typical induced axial velocity profile



# Motivation

---

Should high-lift propellers be designed in the same manner as conventional propellers?

# Because the goal of high-lift props differs from conventional props, they should be designed differently

- Goal of conventional props is to produce thrust, but goal of high-lift props is to augment lift
  - Thrust may actually be bad for high-lift props!
- Props primarily affect lift via induced velocity
- Chow et al. indicate that the axial velocity *profile* affects the lift generated
  - Placed Joukowski velocity profiles upstream of airfoil and studied lift generated
  - Varied airfoil height relative to profile
  - Define “non-uniformity parameter”:  $a/d^2$
  - Define “adjusted lift coefficient”:  $\bar{C}_L = \frac{C_L}{(1+a)^2}$

$$V(z) = V_\infty (1 + ae^{-z^2/d^2})$$

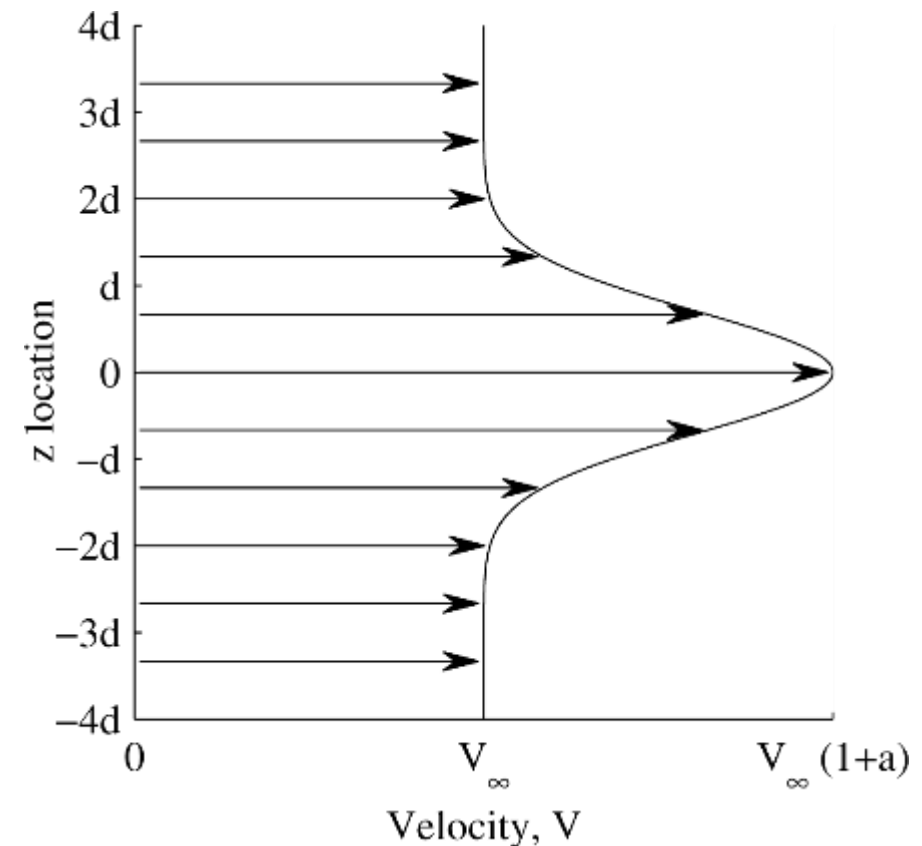

[Chow 1970, DOI 10.2514/3.44208]



# Maximum lift is generated when the axial velocity profile is as closely uniform as possible

- Chow et al. empirically determined a relationship between the adjusted lift coefficient and the non-uniformity parameter

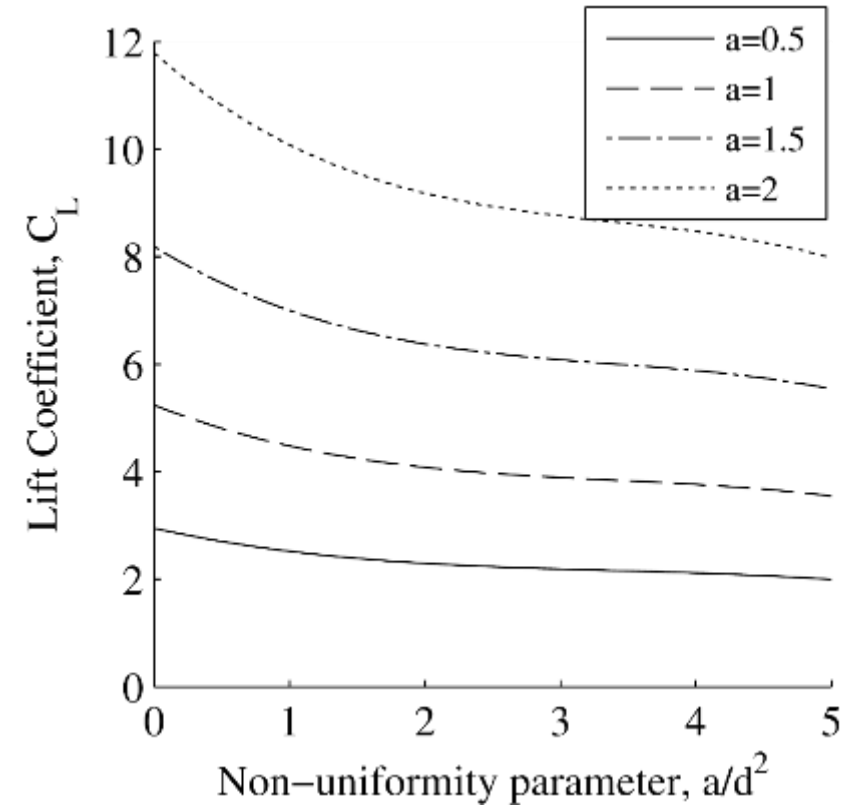
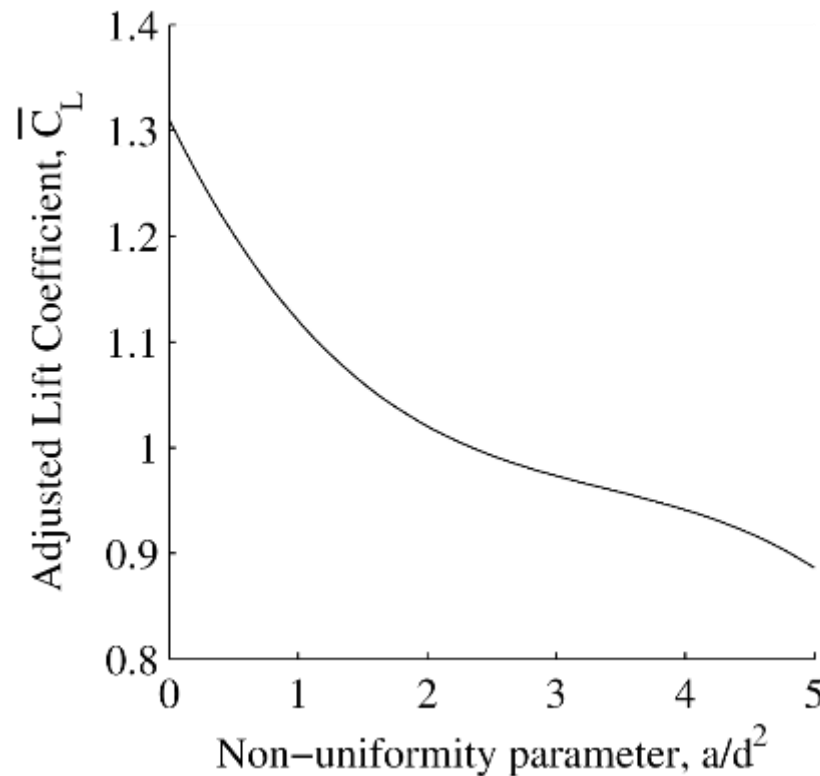

## Takeaways:

1. Lift decreases as non-uniformity increases regardless of max velocity
2. More lift produced as maximum velocity increases
3. Impact of non-uniformity increases as maximum velocity increases



# Maximum lift is generated when the axial velocity profile is as closely uniform as possible

- Chow et al. empirically determined the relationship between adjusted coefficient of non-uniformity parameter

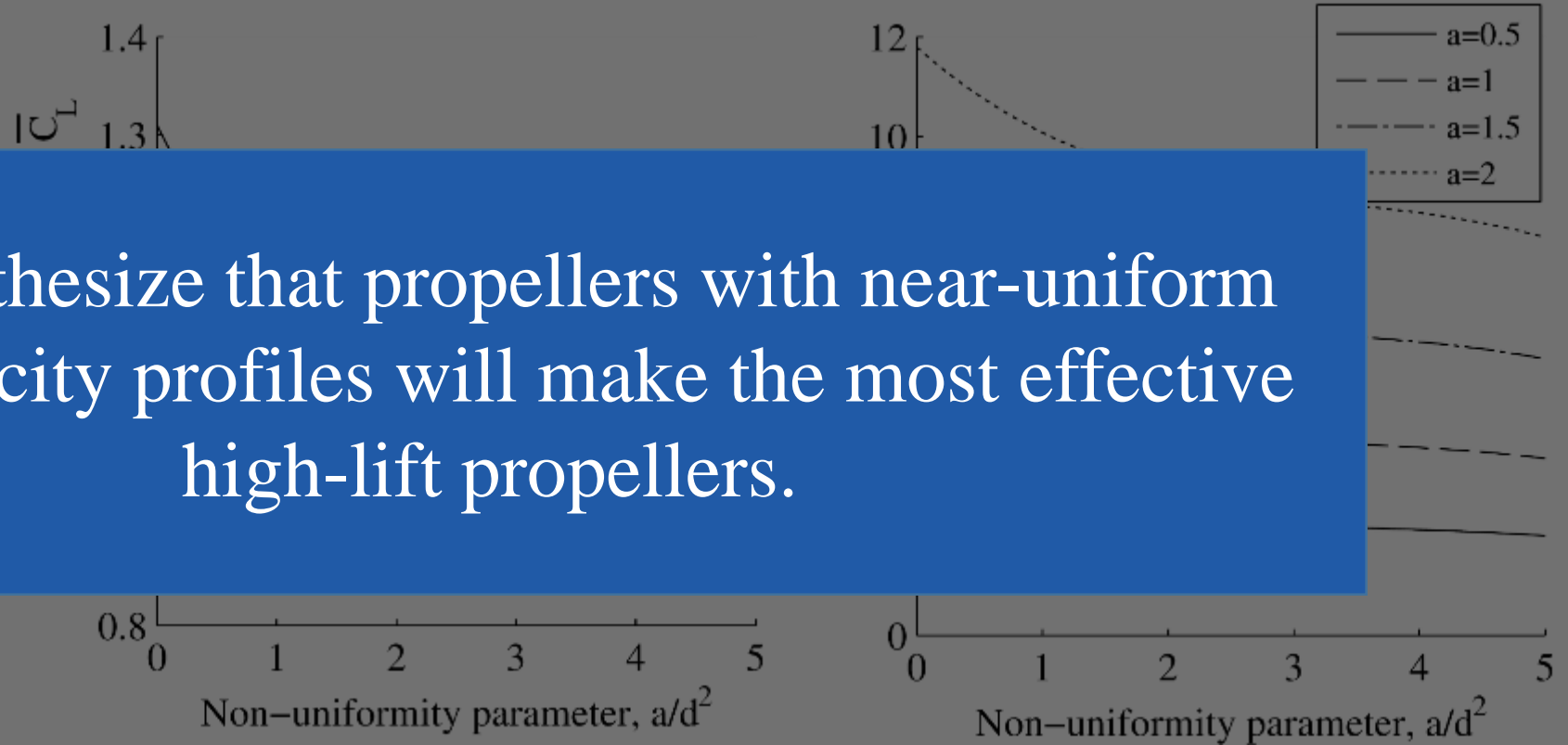

We hypothesize that propellers with near-uniform axial velocity profiles will make the most effective high-lift propellers.

## Takeaways:

1. Lift decreases as non-uniformity increases regardless of max velocity
2. More lift produced as maximum velocity increases
3. Impact of non-uniformity increases as maximum velocity increases



# High-Lift Propeller Design Method & Examples

---

# The design method is based on BEMT and seeks to maintain a near-uniform axial velocity distribution

- Method is built on blade element momentum theory (BEMT)
  - Analyze prop as sum of many “blade elements” as 2-D airfoils
  - Local velocity at airfoil sections,  $\mathbf{W}$ , split into axial and tangential components, which are defined by the freestream, prop rotation, and prop-induced velocities
  - Induced velocities presented as axial and tangential induction factors ( $a$  and  $a'$ )
- Blades are designed to a specified induced axial velocity distribution

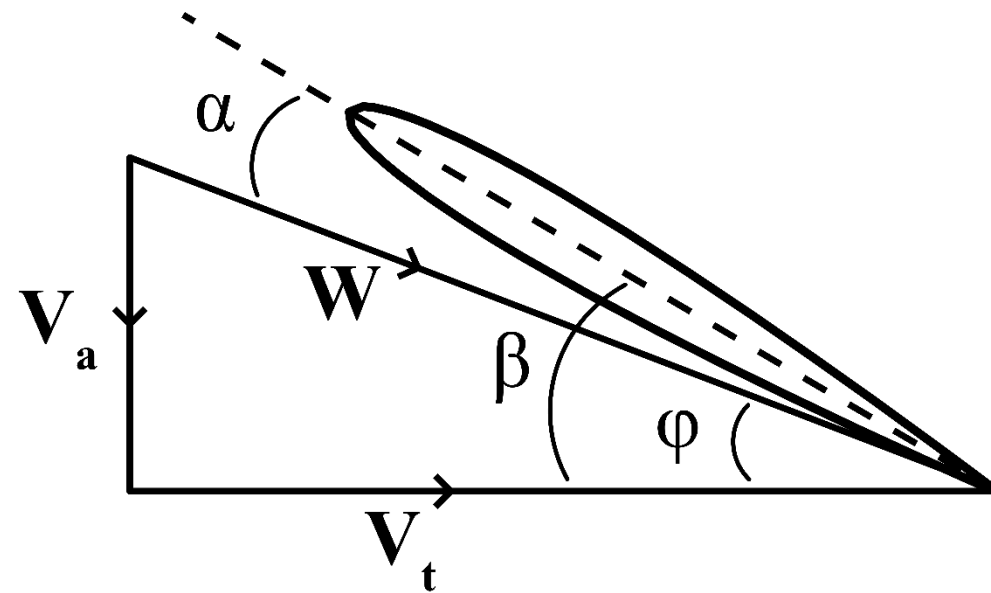

$$V_a = V_\infty (1 + a)$$

$$V_t = \Omega r (1 - a')$$

# The design method consists of four steps, where the first is the most important and novel

- Assumptions:
  - Designer desires constant induced axial velocity distribution
  - The diameter, number of blades, rotational speed, and airfoil(s) are known
  - The angular velocity added to the slipstream is small compared to the angular velocity of the propeller
- Steps in method:
  1. Set axial induction factor distribution
  2. Determine blade pitch angle distribution
  3. Determine blade chord length distribution
  4. Verify performance and iterate (if required)

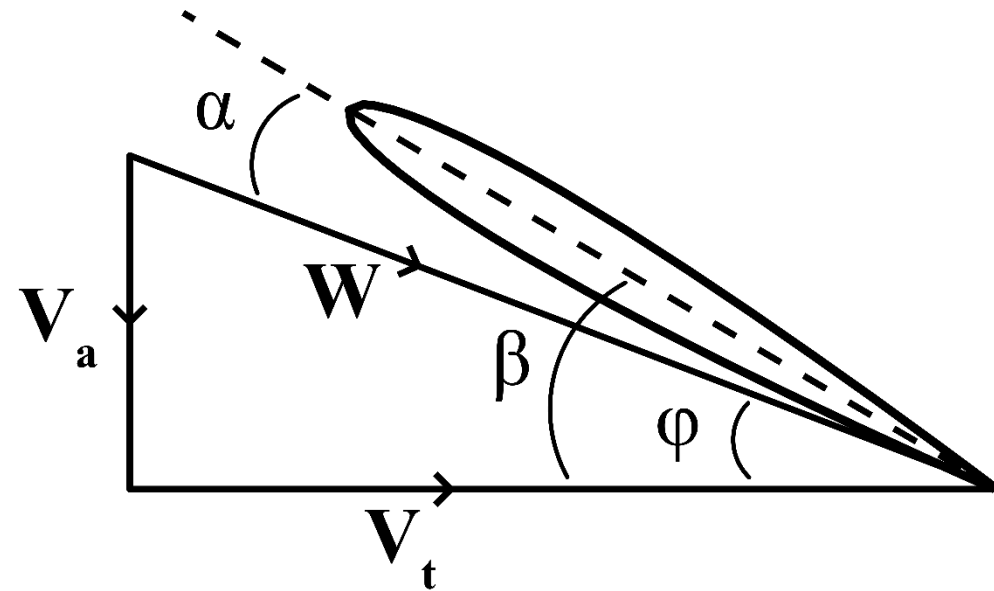

$$V_a = V_\infty (1 + a)$$

$$V_t = \Omega r (1 - a')$$

# Steps 1-3: Setting the axial induction factor distribution determines the blade chord/pitch distributions

- Begin by specifying a constant axial velocity distribution based on desired average induced velocity
- If assumptions are valid, then axial and tangential induction factors are related
  - Relationship implies maximum value for  $a'$  as 0.5
  - If desired value of  $a$  leads to  $a' > 0.5$ , limit  $a'$  to 0.5
  - If limiting  $a'$ , find new implied value of  $a$

$$a = \frac{v_i}{V_\infty}$$

$$V_\infty^2(1+a)a = \Omega^2 r^2(1-a')a'$$

$$a' = \frac{1 - \sqrt{1 - \frac{4V_\infty^2(1+a)a}{\Omega^2 r^2}}}{2}$$

$$a = \frac{-1 + \sqrt{1 + \frac{4\Omega^2 r^2(1-a')a'}{V_\infty^2}}}{2}$$

## Step 4: Verify prop performance and iterate (if required) until desired average induced axial velocity is achieved

- Average induced axial velocity from method will likely not match desired value (due to assumptions, hub/tip losses, limiting  $a'$ , etc.)
- We utilize XROTOR in vortex mode to verify average axial velocity
  - XROTOR is open-source prop design/analysis tool from Mark Drela's research group at MIT
- If average induced axial velocity is too low (high), increase (decrease) induced axial velocity specified in Step 1 and repeat
- In practice, found that approximately 2-3 iterations are required for convergence

# Example: notional high-lift propellers for NASA's SCEPTOR flight demonstrator

- NASA's Scalable Convergent Electric Propulsion Technology and Operations Research (SCEPTOR) project
  - Developing flight demonstrator to show efficiency gains possible from distributed electric propulsion
  - Retrofitting Tecnam P2006T aircraft with new, smaller wing and high-lift props
  - Configuration consists of 12, 5-bladed high-lift propellers with 22.7 inch diameter
  - Conceptual design studies indicate 23.2 ft/sec average induced axial velocity required at 55 knots
  - For design, assume constant airfoil (MH 114), design  $c_1$  of 1.1, rotational speed of 450 ft/sec, & hub diameter of 5.7 inch

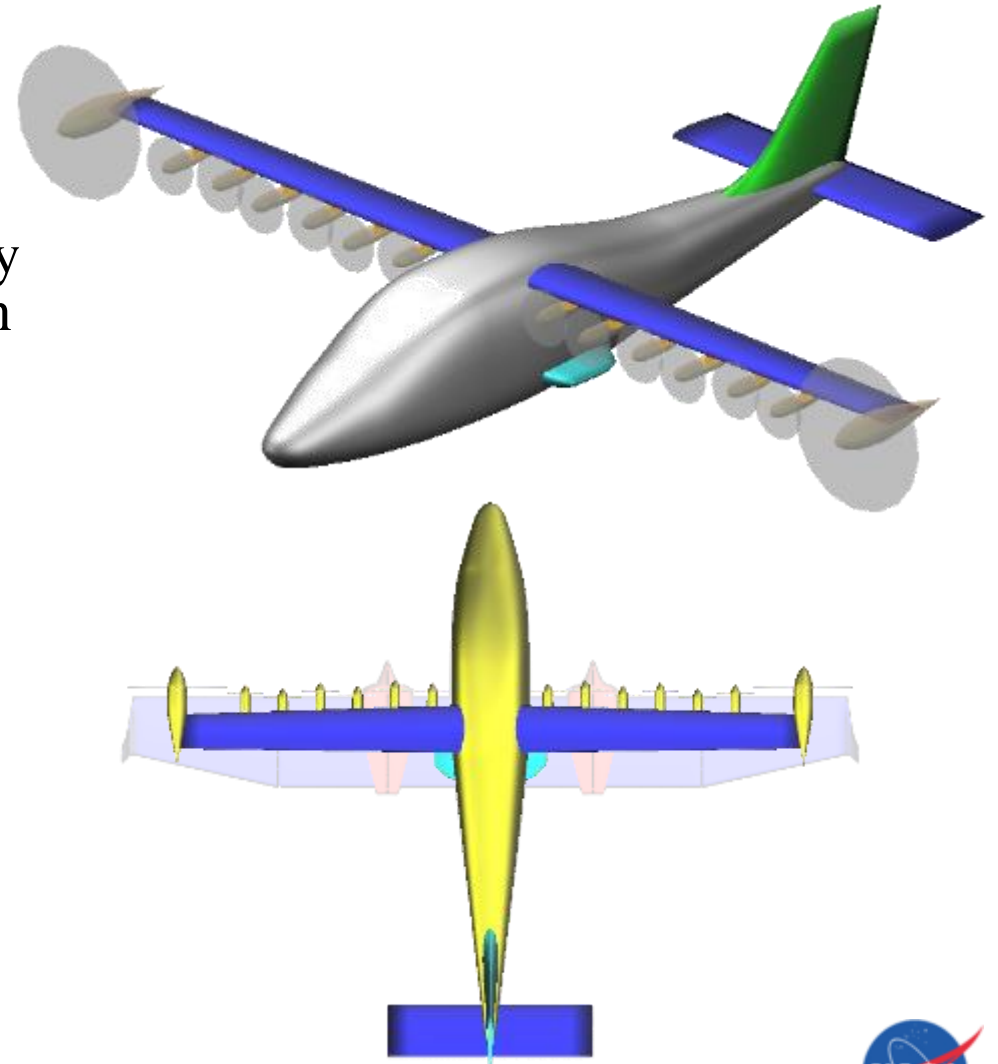

# A conventional, minimum induced loss (MIL) prop was designed via XROTOR for the SCEPTOR aircraft

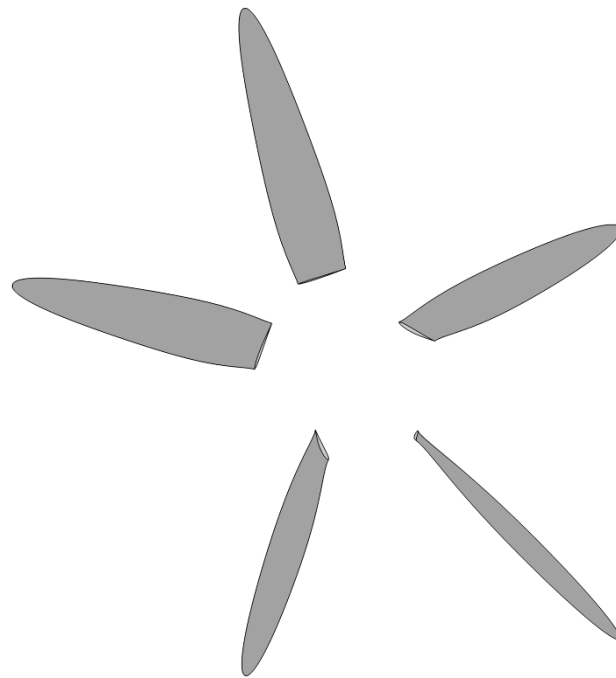
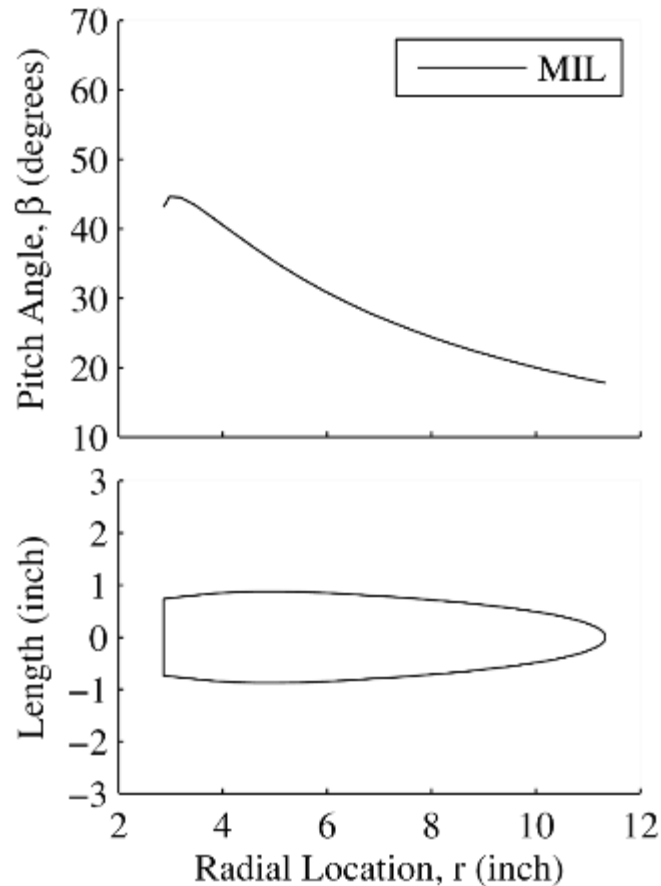

Isometric View

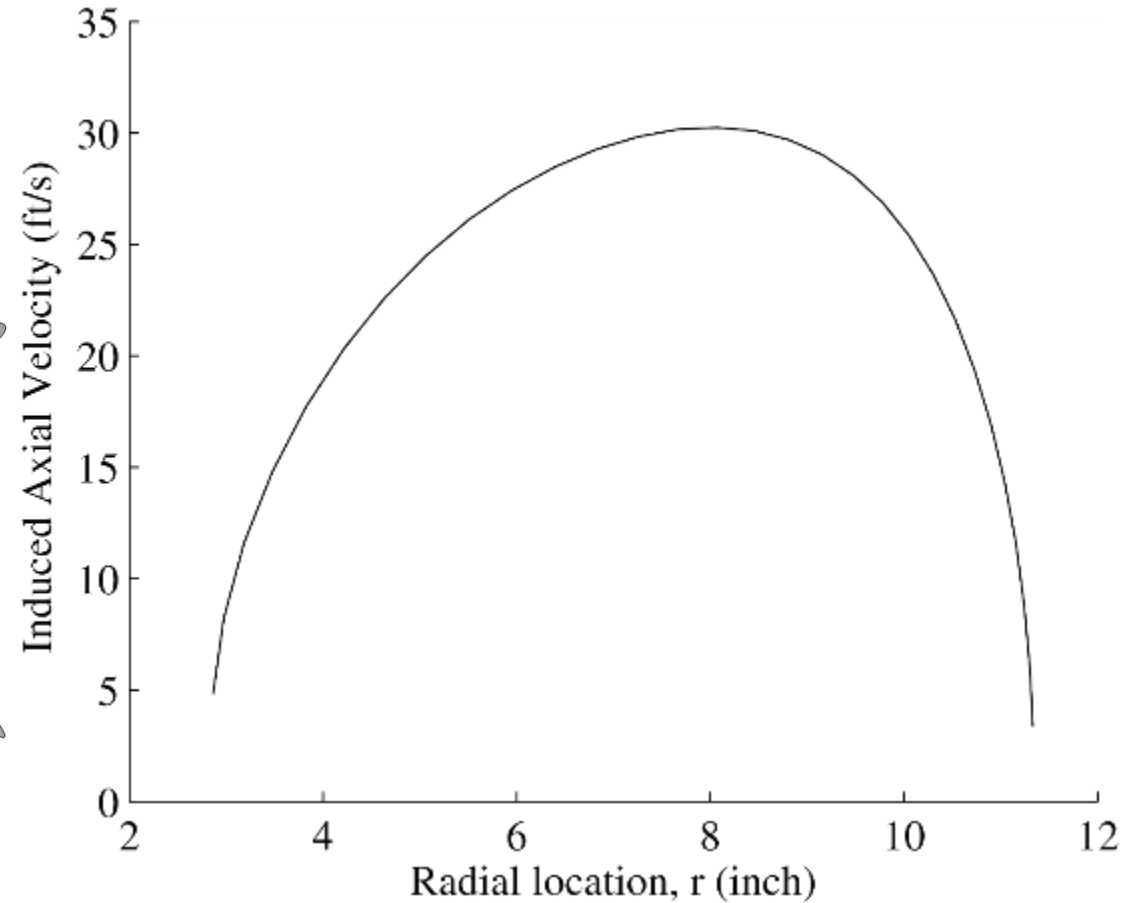



# The 1st iteration through the method produces insufficient induced axial velocity

- Average induced velocity of 20.1 ft/sec (desired 23.2 ft/sec)

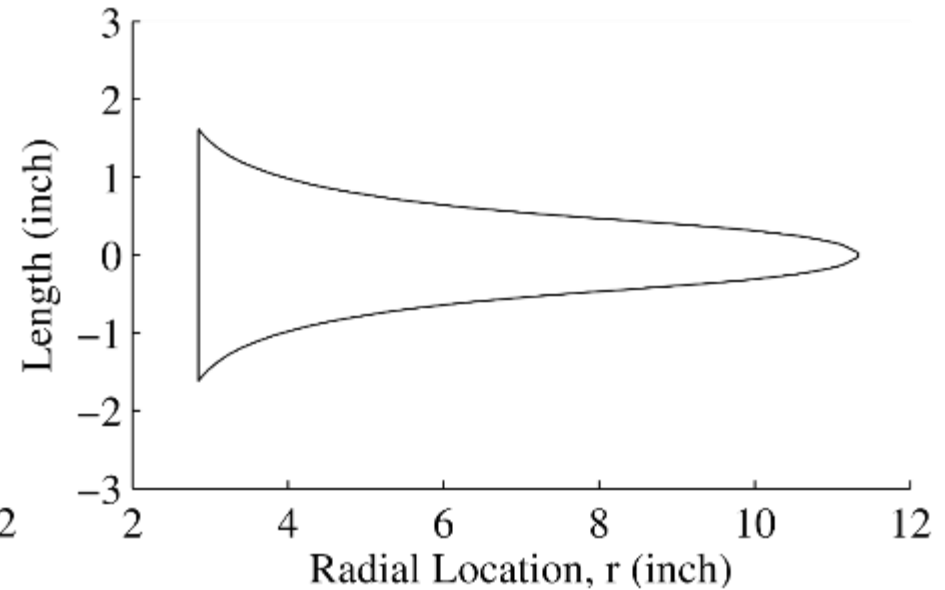
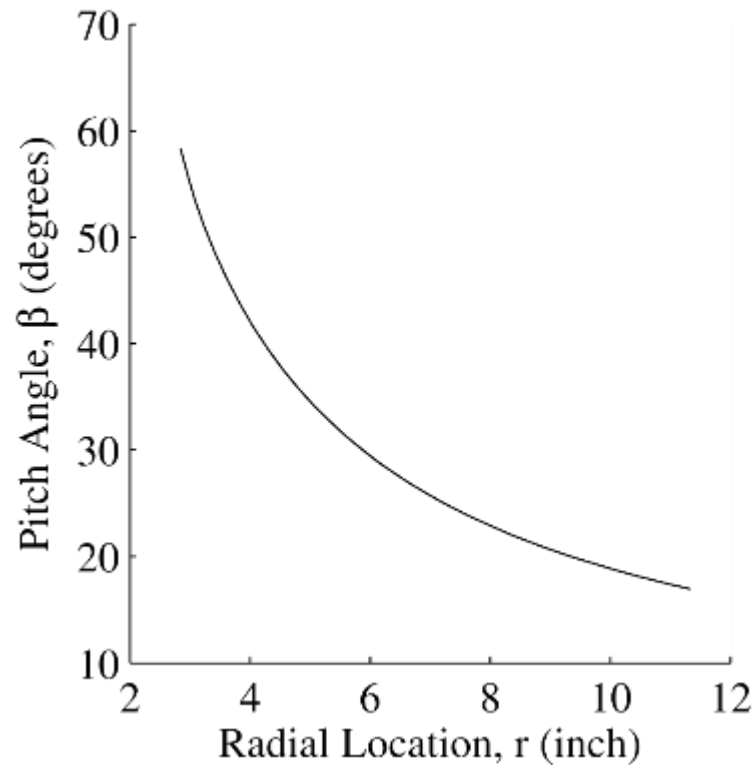
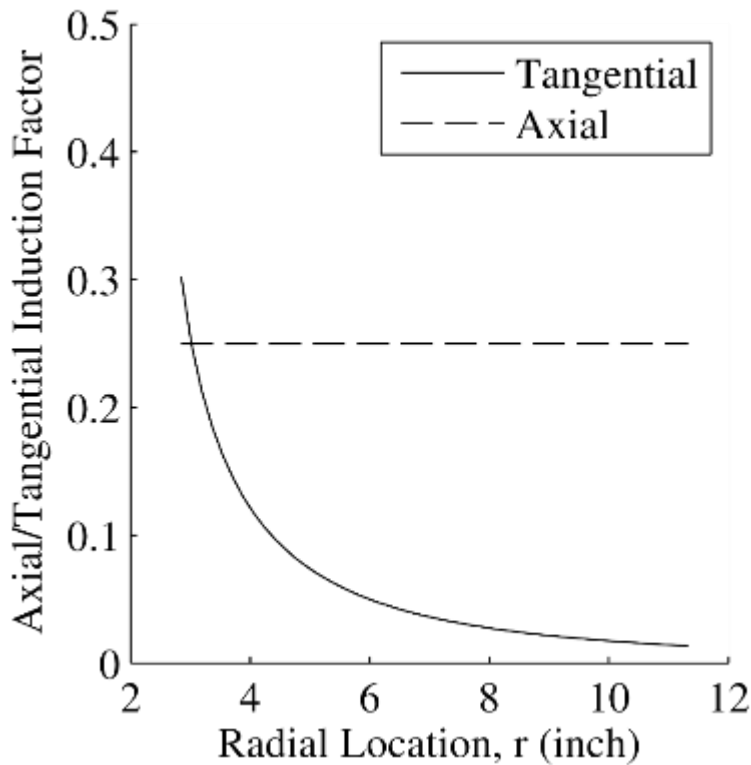

# The 2nd iteration through the method produces the desired induced axial velocity

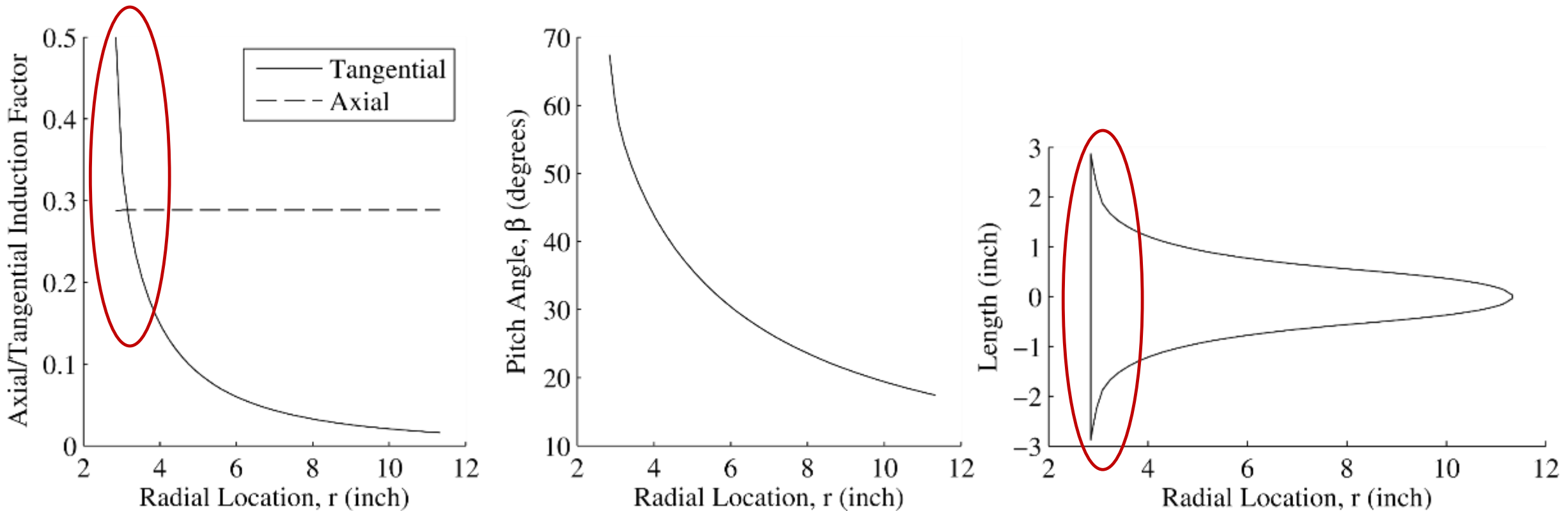

- Large chord length increases associated with large increases in the tangential induction factor

# Step 1, Modification Option 2: reduce chord/twist change near root by limiting increase in $a'$

- Goal: reduce large chord length and pitch angle changes near the root
- Large increases in tangential induction factor imply violation of assumption that the angular velocity added to the slipstream is small
- Limit slope of tangential induction factor vs  $r/R$  curve
  - In practice found  $da'/d(r/R) \approx 1.25$  provides the desired effect

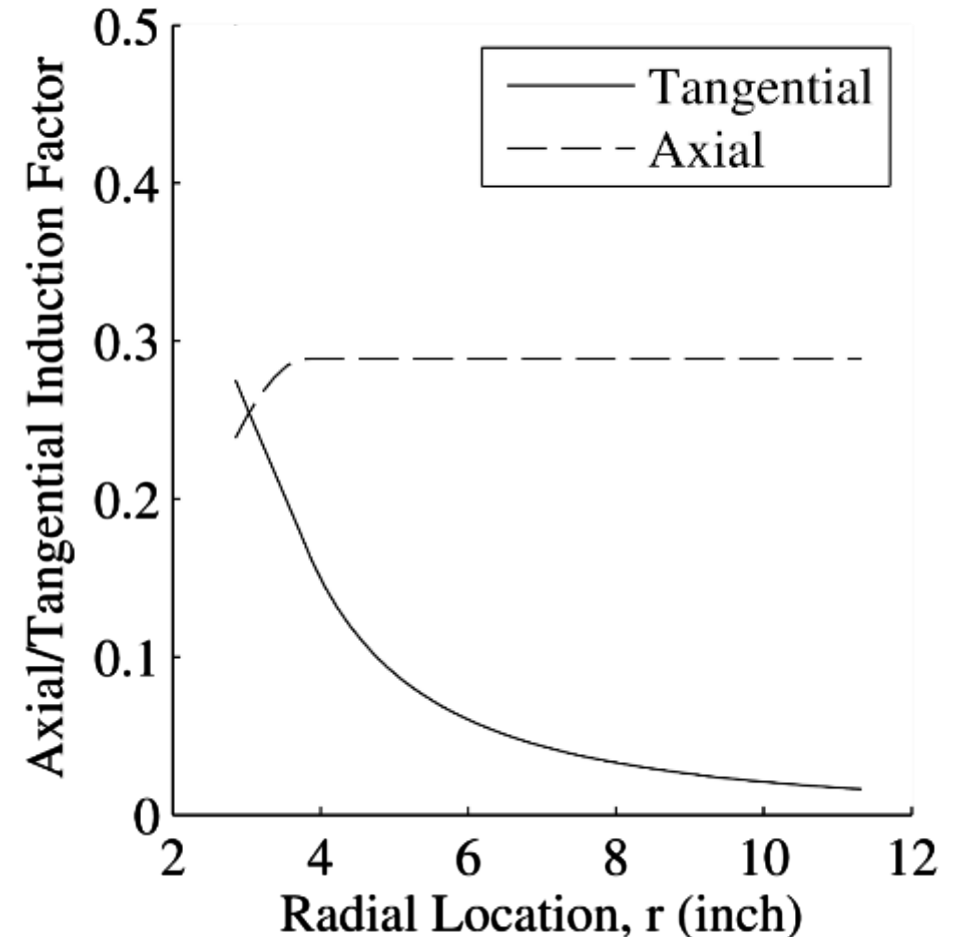

# Invoking Modification Option 2 to Step 1 reduces the very large increases in chord/pitch near the root

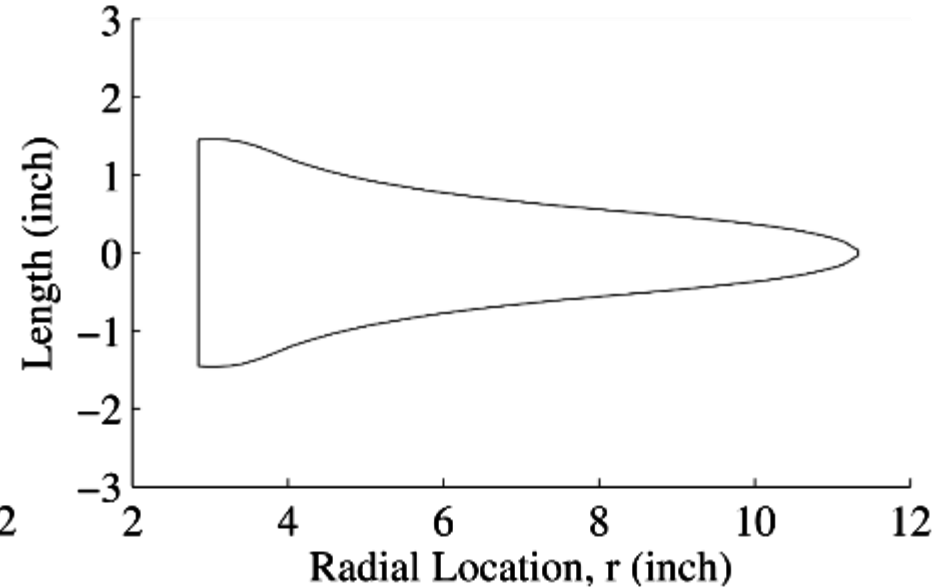
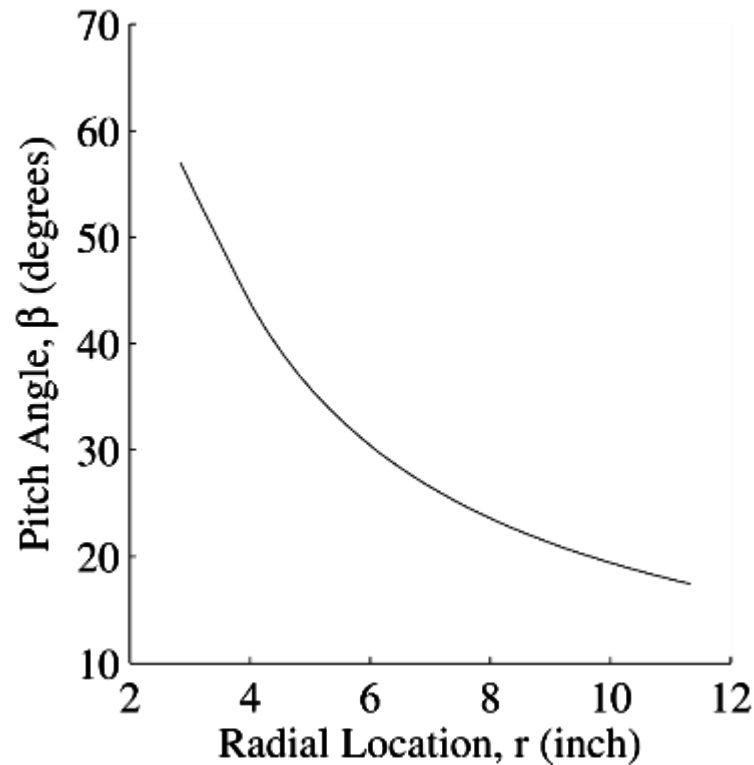
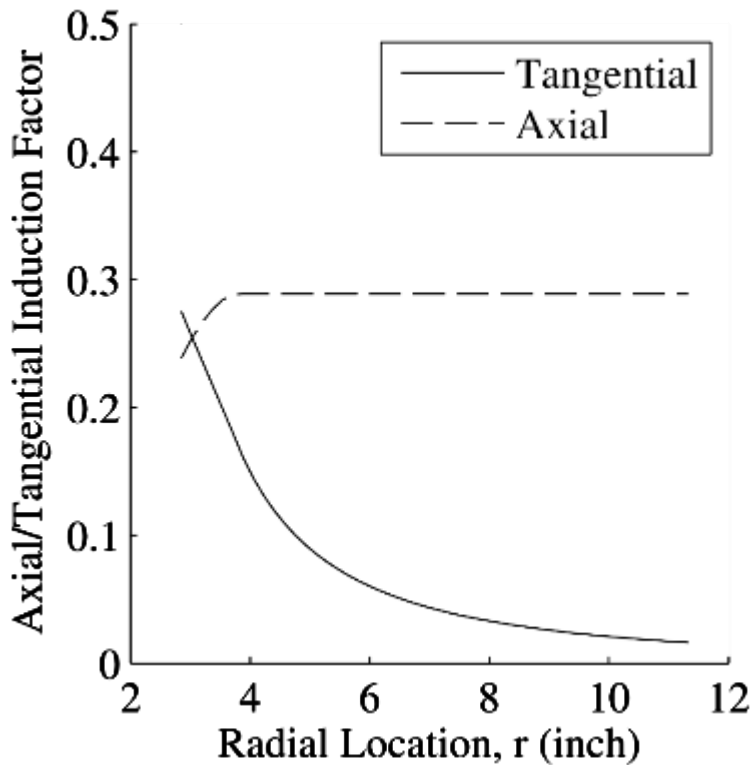

- With  $da'/d(r/R)=1.25$

# The method tends to produce designs with a velocity peak near the blade root

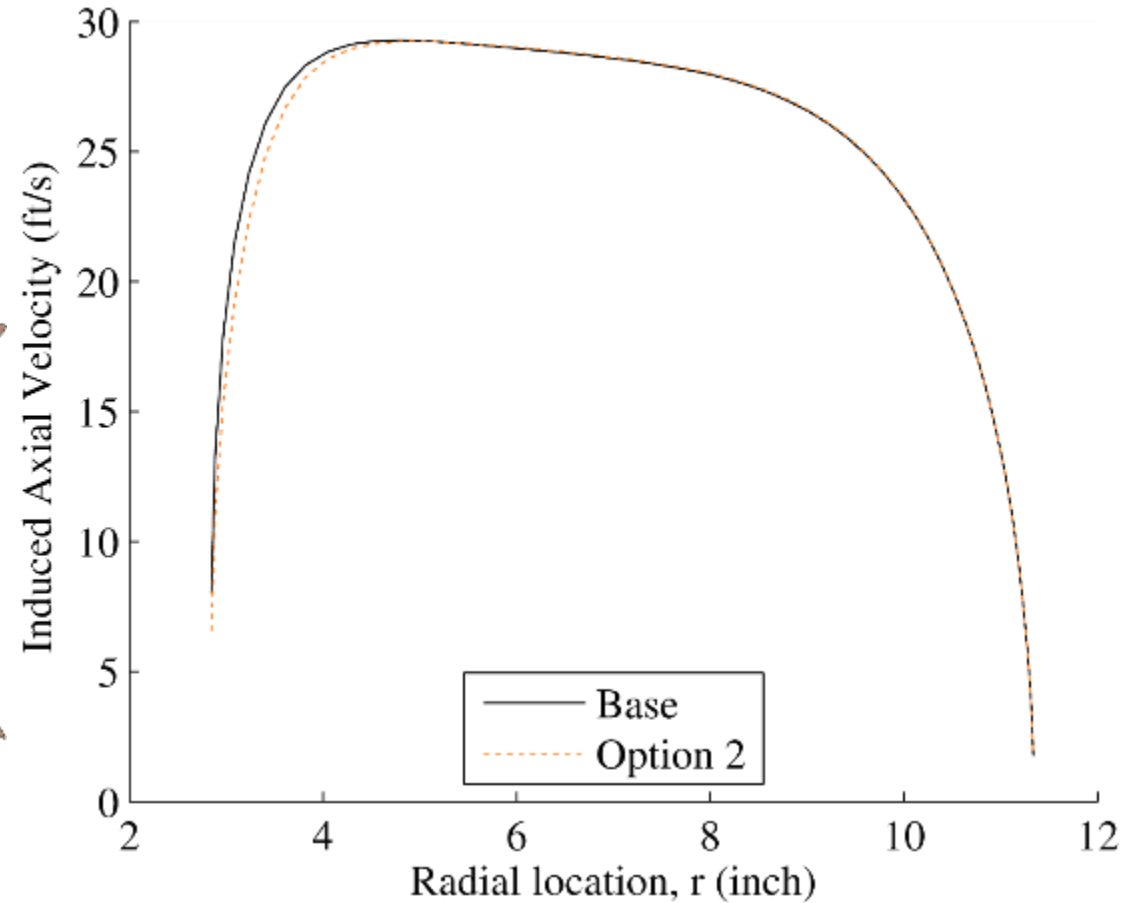
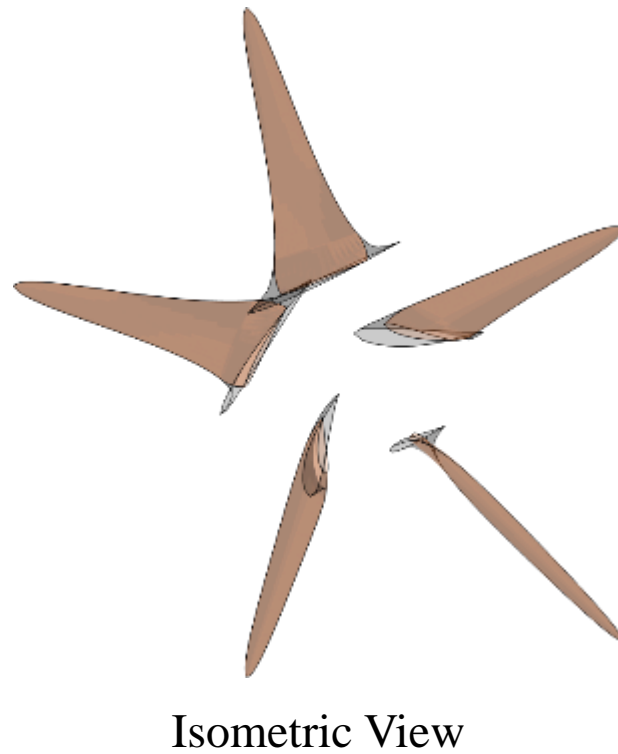
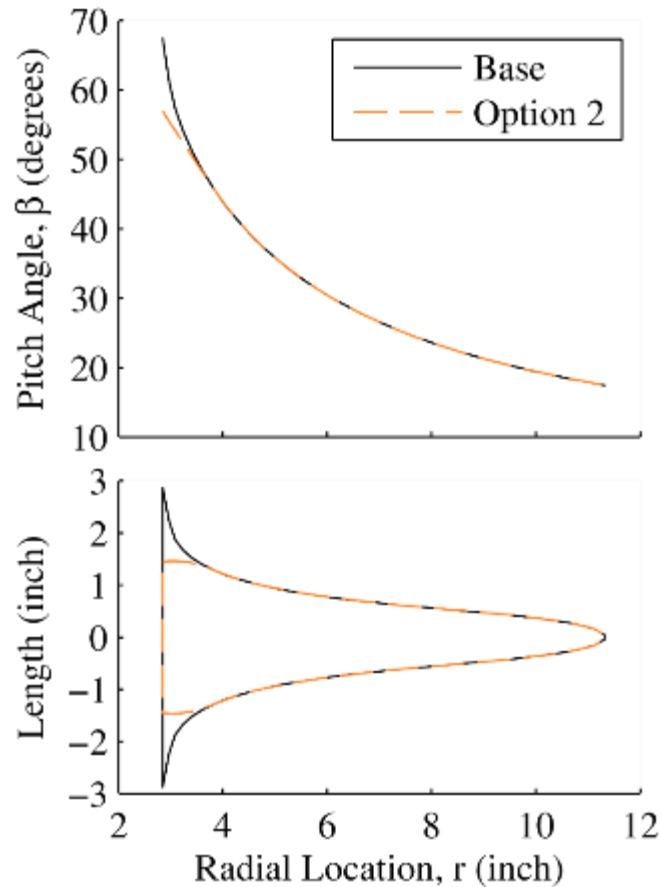

# Step 1, Modification Option 1: applying modified Prandtl tip loss factor to a provides desired blade loading at tip

- Modify tip loss factor with larger radius
  - Found  $R'=1.035R$  provides desired results

$$F = \frac{2}{\pi} \cos^{-1} \left[ e^{\frac{-B (R' - r)}{2 r \sin(\varphi)}} \right] \quad a_{mod} = \frac{a}{F}$$

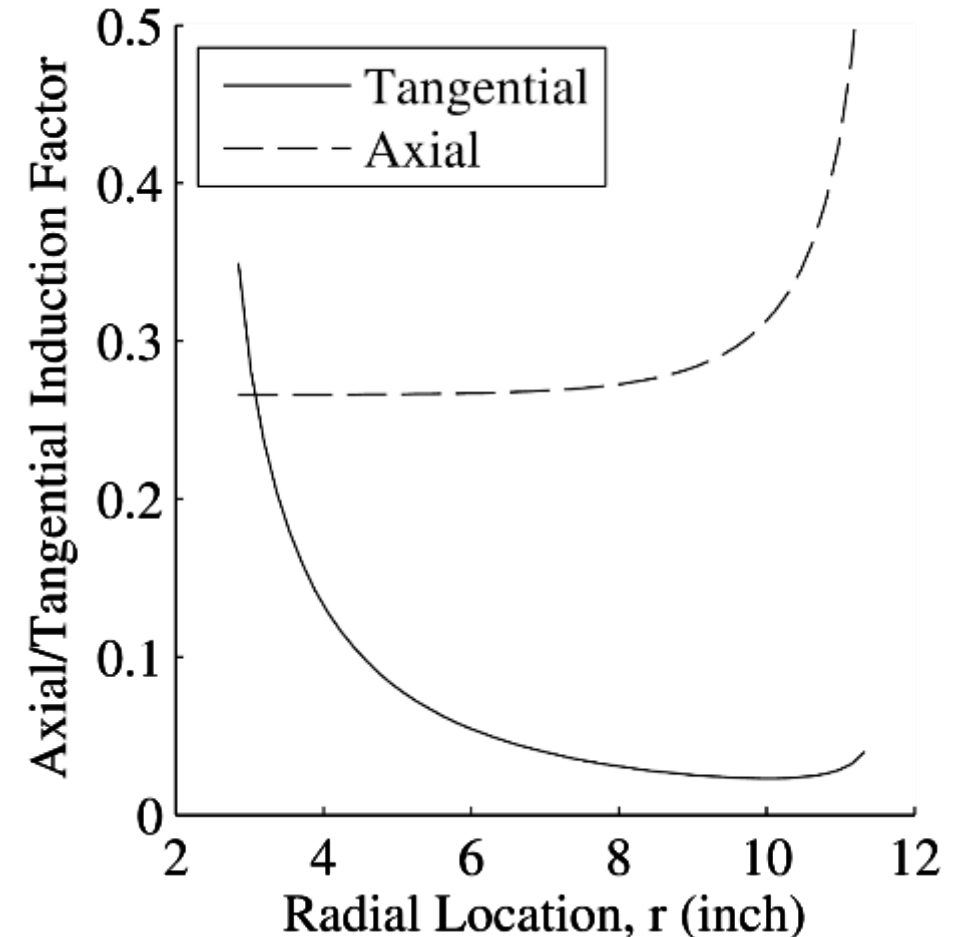
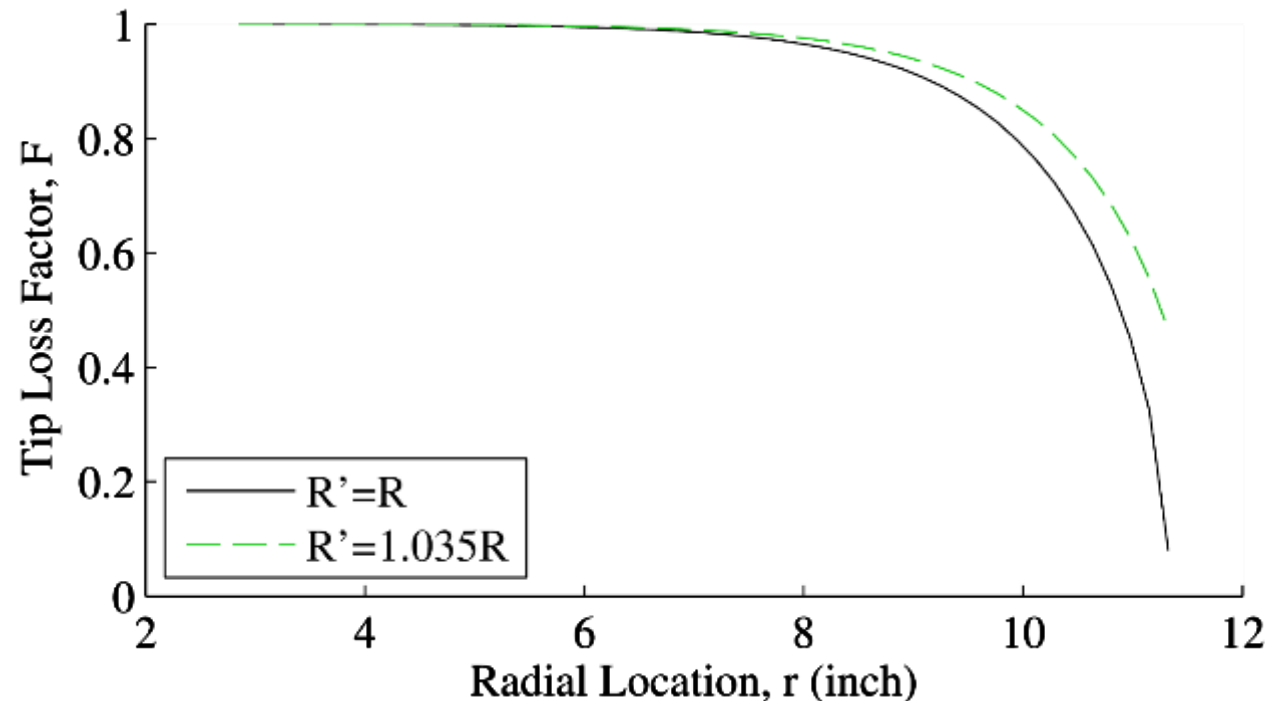

# Invoking Modification Option 1 to Step 1 increases the chord/pitch near tip and decreases chord/pitch near root

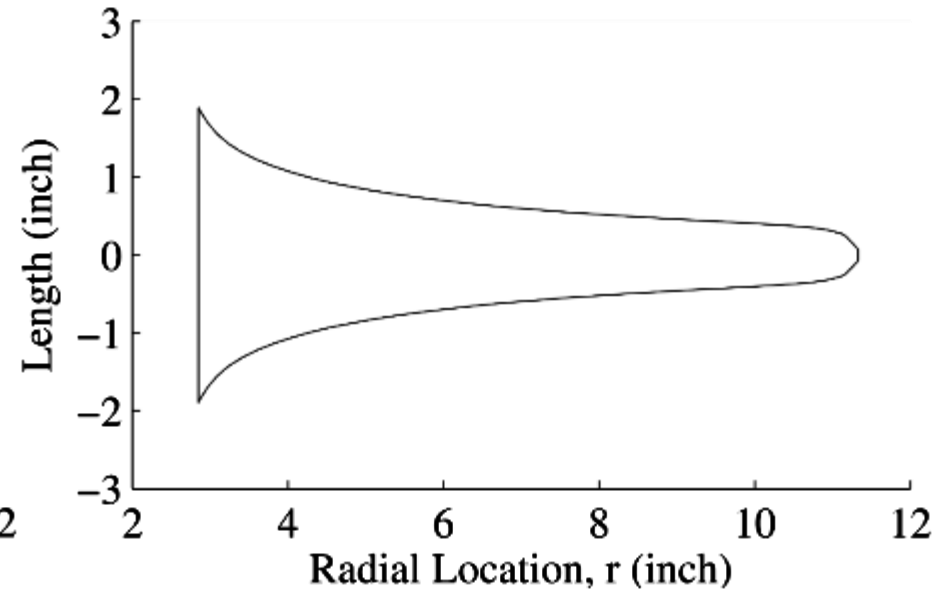
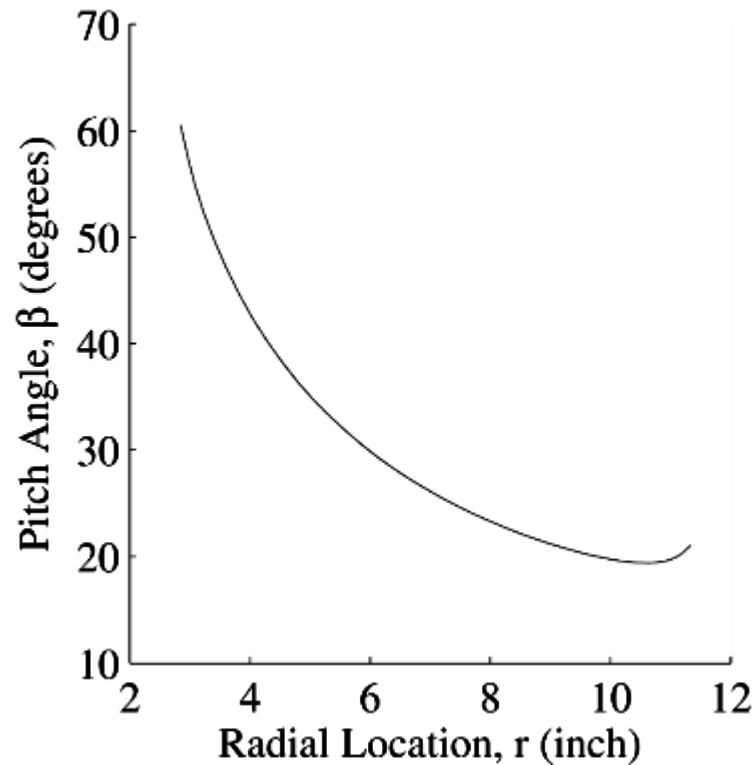
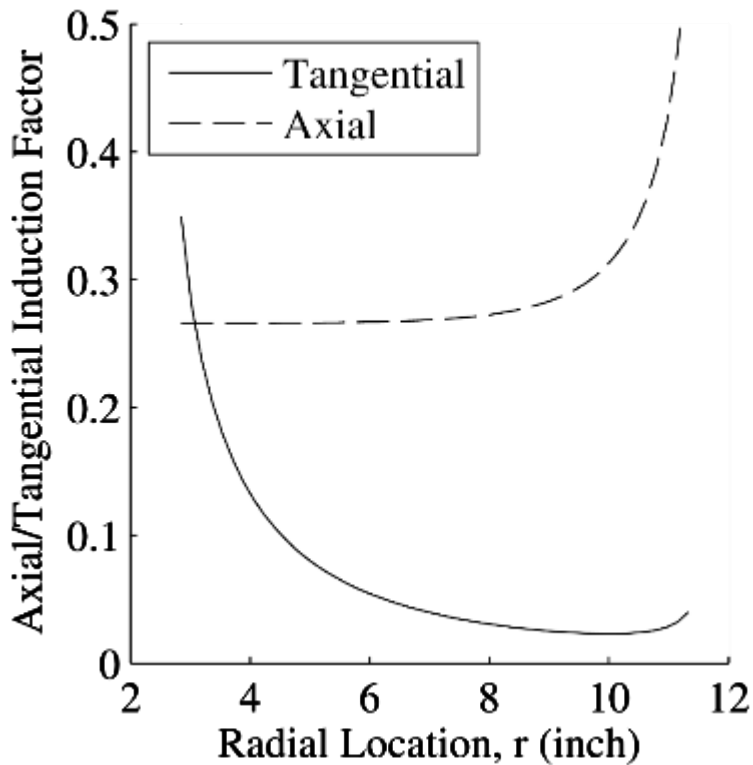

- With  $R'=1.035$

# Invoking Modification Option 1 to Step 1 provides the desired near-uniform induced axial velocity distribution

- Increased chord and pitch near tip
- Reduced chord and pitch near root

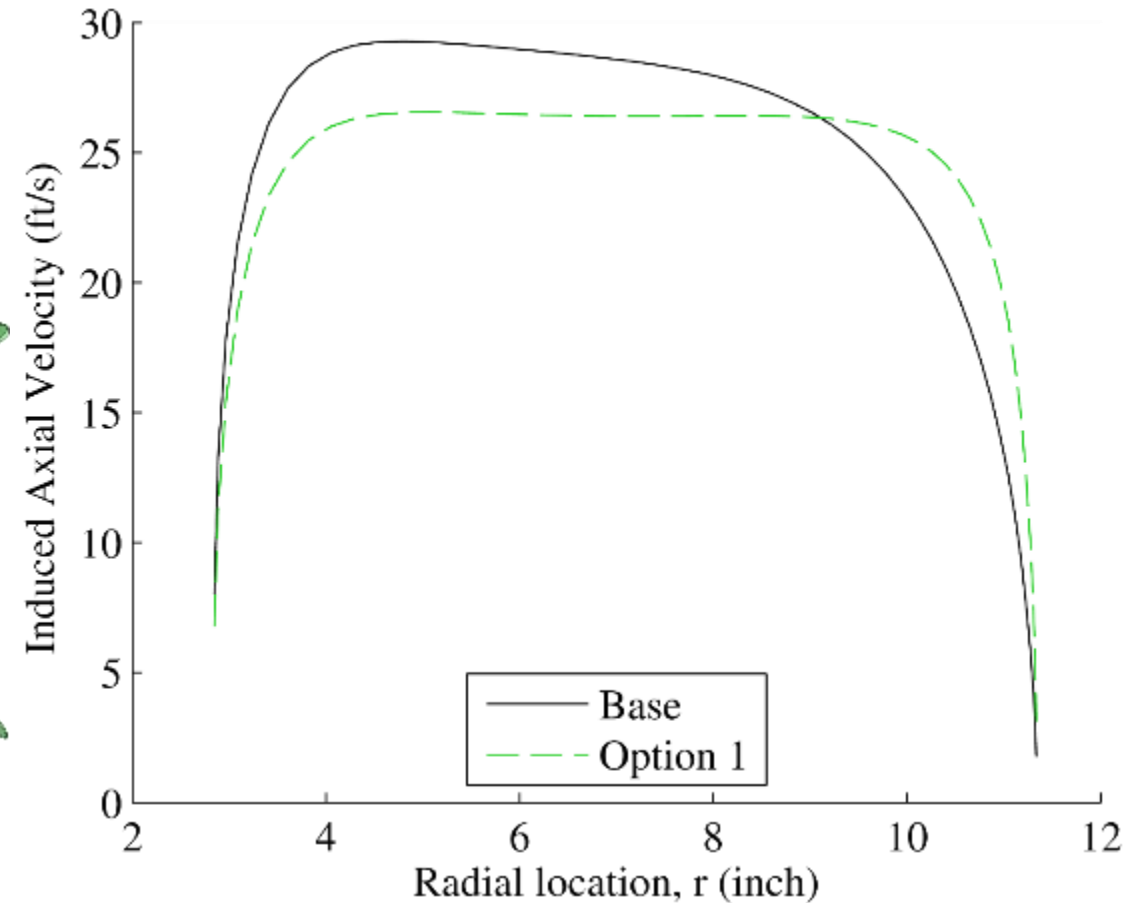
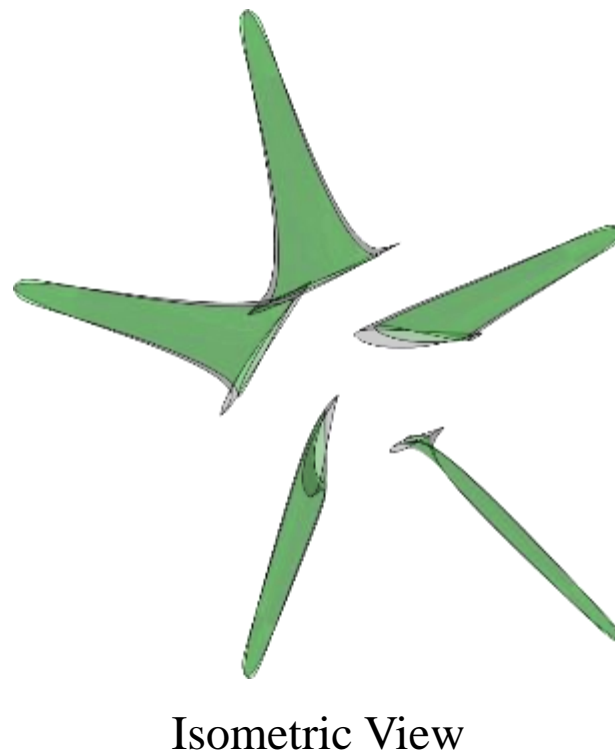
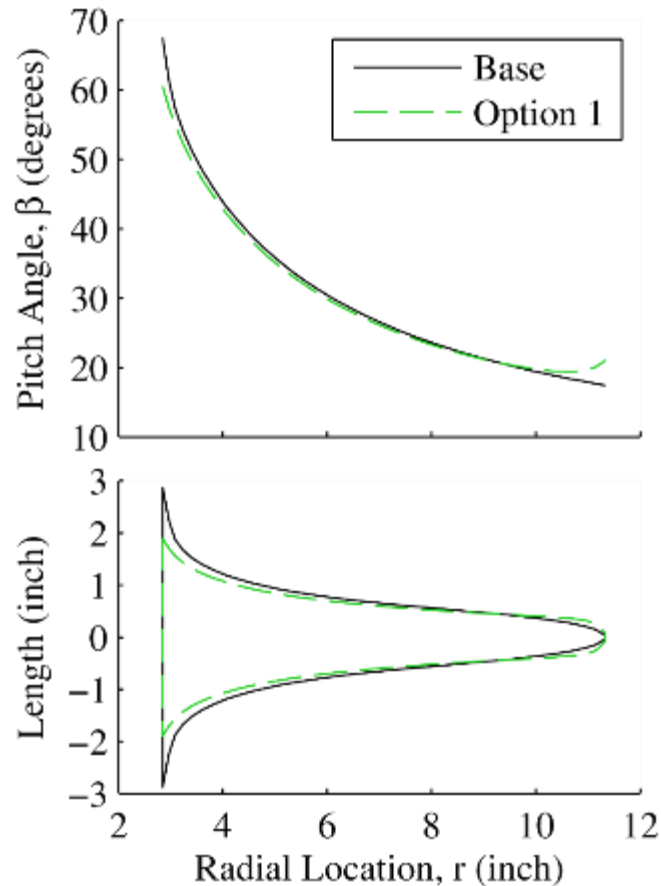



# Modification Options 1 & 2 when invoked simultaneously produce near-uniform velocities & reasonable blade shapes

- Slight decrease in induced axial velocity near root

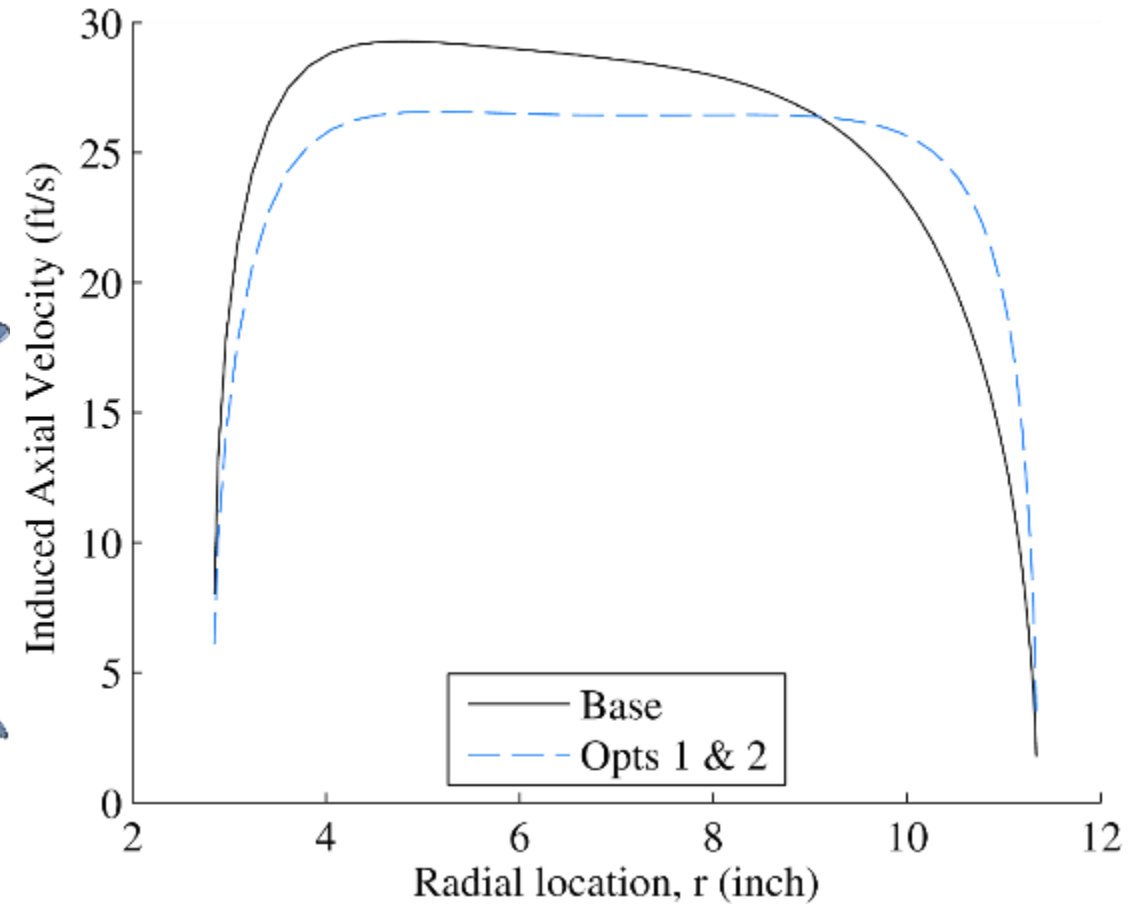
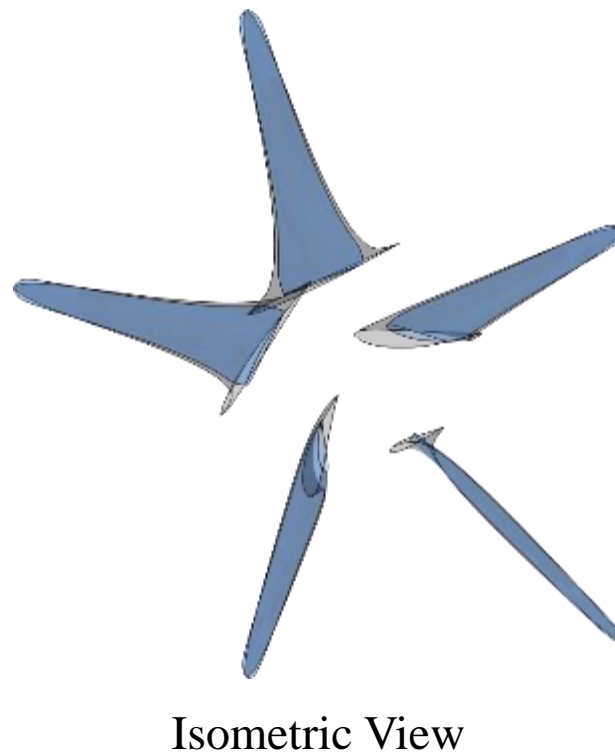
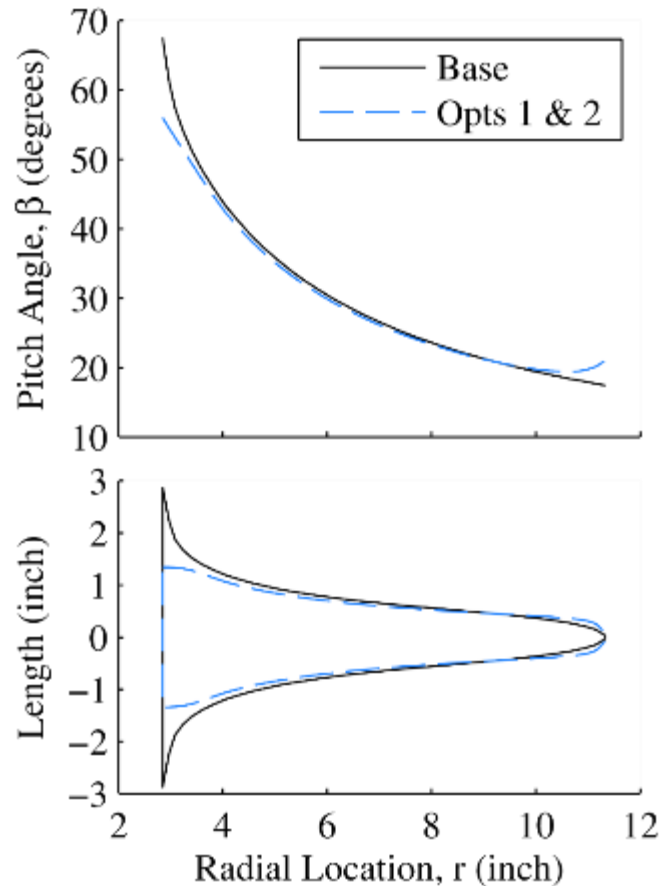

# Design method produces props with much more uniform velocity distributions than conventional props

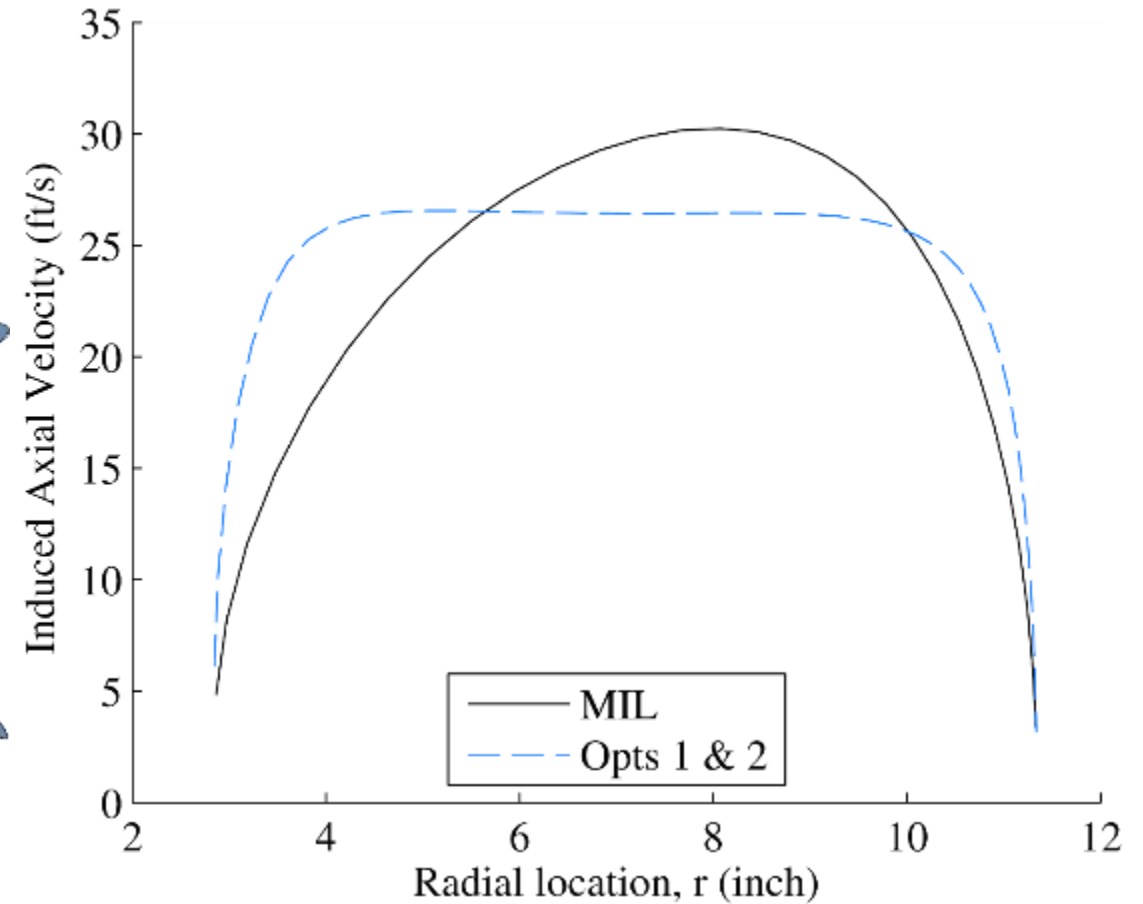
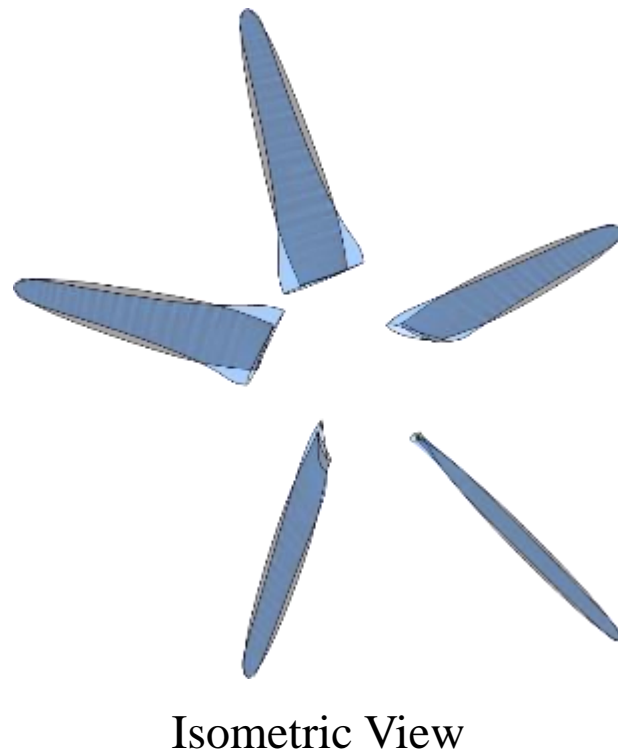
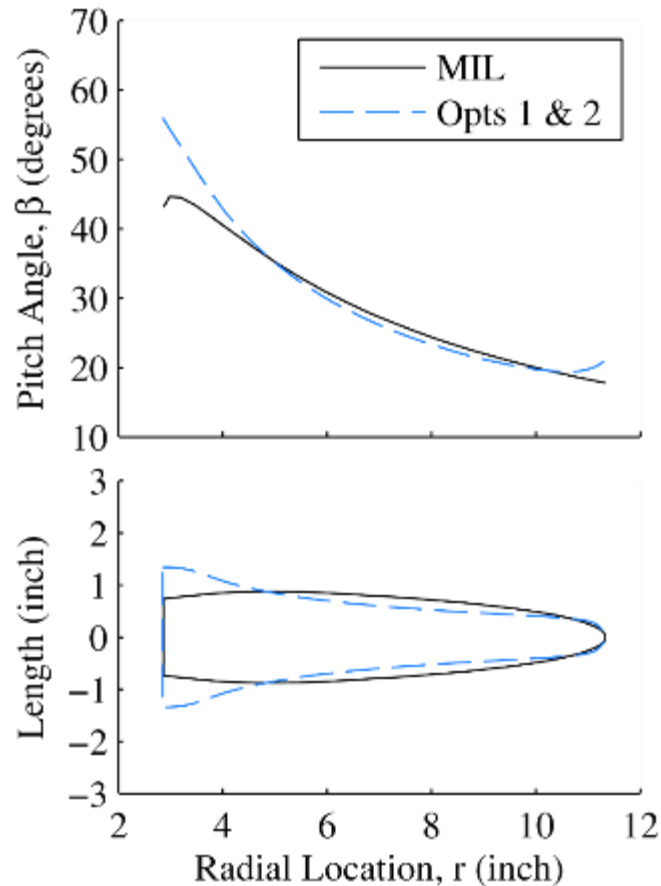

# Each new prop provides the same average induced axial velocity at ~15% lower power than the MIL prop

	Power		Torque		Thrust	
	kW	% Difference	N-m	% Difference	N	% Difference
MIL	7.21	--	15.1	--	170	--
Base	6.13	-15.0%	12.9	-14.6%	149	-12.4%
Option 1	6.17	-14.4%	12.9	-14.6%	151	-11.2%
Option 2	6.10	-15.4%	12.8	-15.2%	149	-12.4%
Opts 1 & 2	6.16	-14.6%	12.9	-14.6%	151	-11.2%

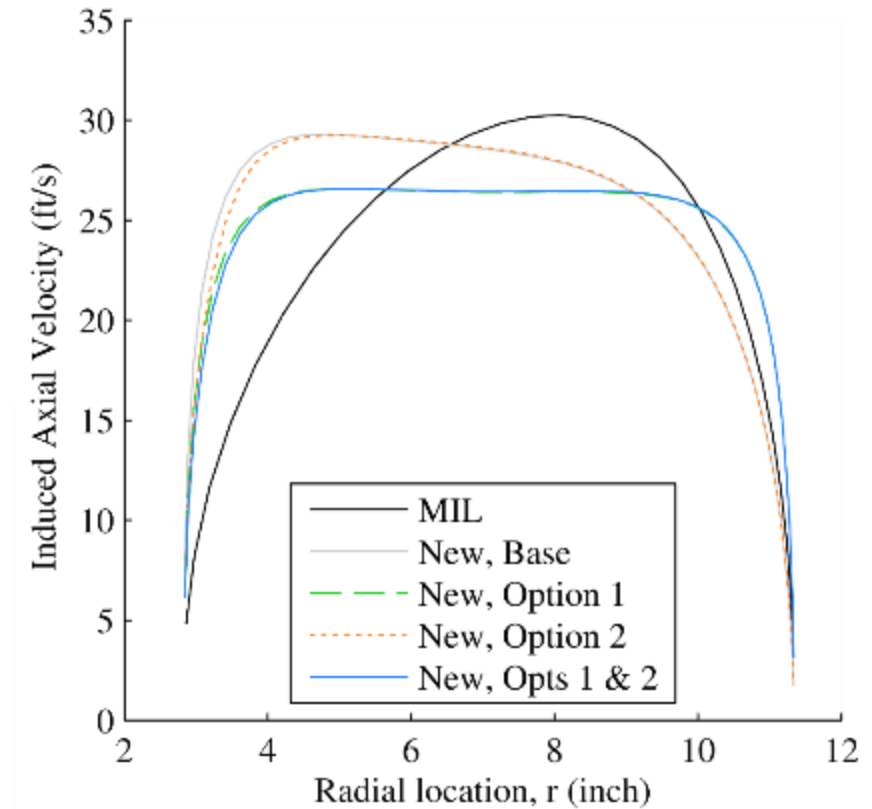
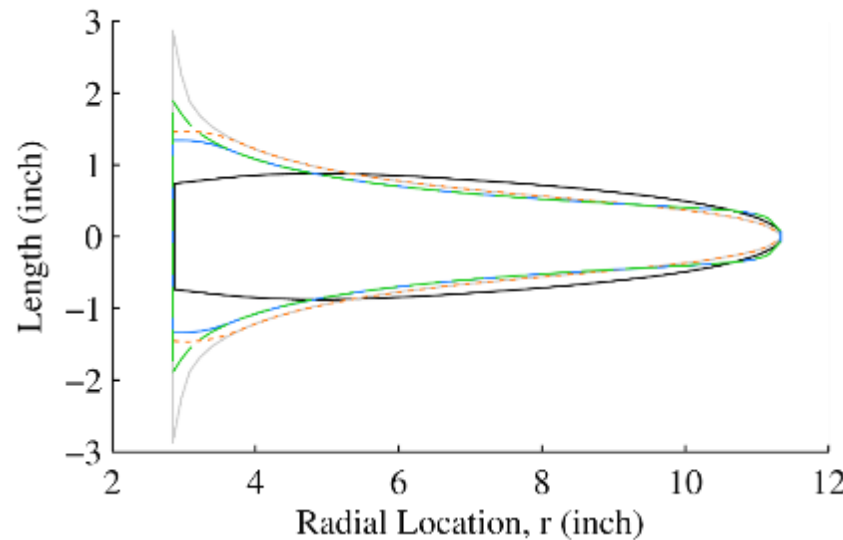
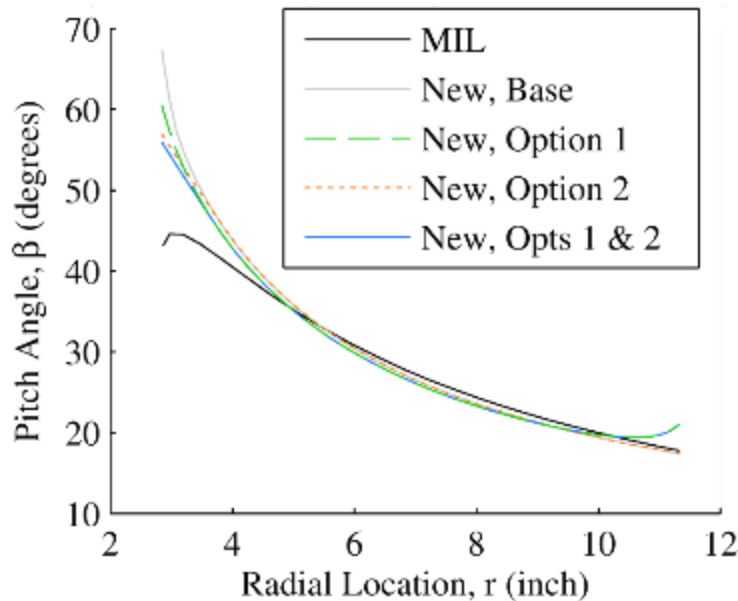



# Conclusions & Future Work

---

# The new prop designs are predicted to augment more lift than traditional props for a given power

- Recall hypothesis: propellers with near-uniform axial velocity profiles will make the most effective high-lift propellers
- Conclusions
  - Design method produces the desired near-uniform induced axial velocity profile
  - Design method produces high-lift props with ~15% lower powers and ~11% lower thrusts than traditional methods to produce the same average induced axial velocity
- Future work
  - Wind tunnel testing and/or unsteady CFD are required to validate performance predictions
  - Consider removing assumption that the rotational velocity added to the slipstream is small
  - Study impacts of large pitch angles near root on blade folding
  - Study impacts of varying airfoils along blade
  - Aeroelastic analysis



# Questions?

---

This work was funded under the Convergent Aeronautics Solutions (CAS) and Transformational Tools and Technologies (TTT) Projects of NASA's Transformative Aeronautics Concepts Program.



# Backup

---

# The average induced axial velocity is found via an area-weighted average

- For incompressible flow, area-weighted average is same as mass flow-weighted average

$$(V_a)_{avg} = \frac{\sum_{i=1}^n \{ \pi (r_{i+1}^2 - r_i^2) 0.5 [V_a(r_{i+1}) + V_a(r_i)] \}}{\pi (R^2 - r_{hub}^2)}$$

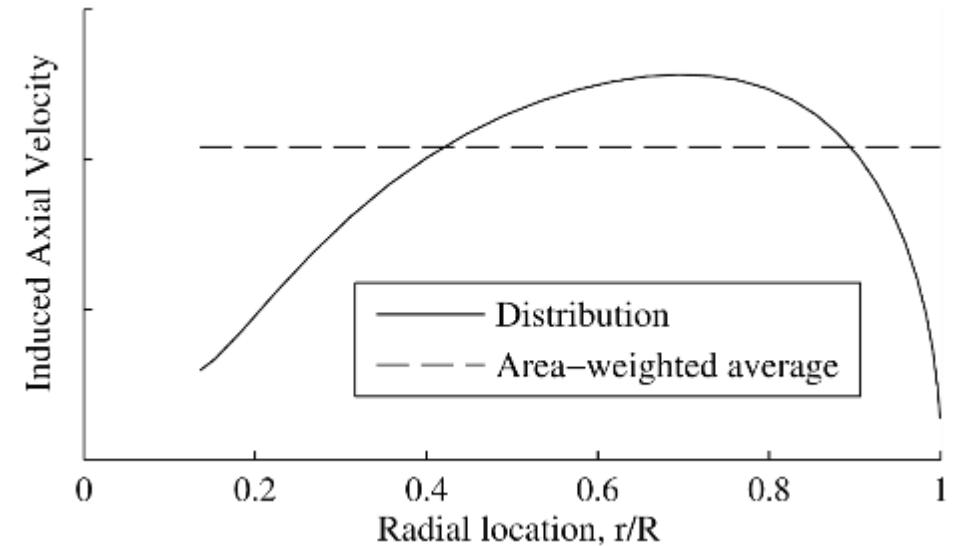



# Comparison of MIL prop and Base new prop

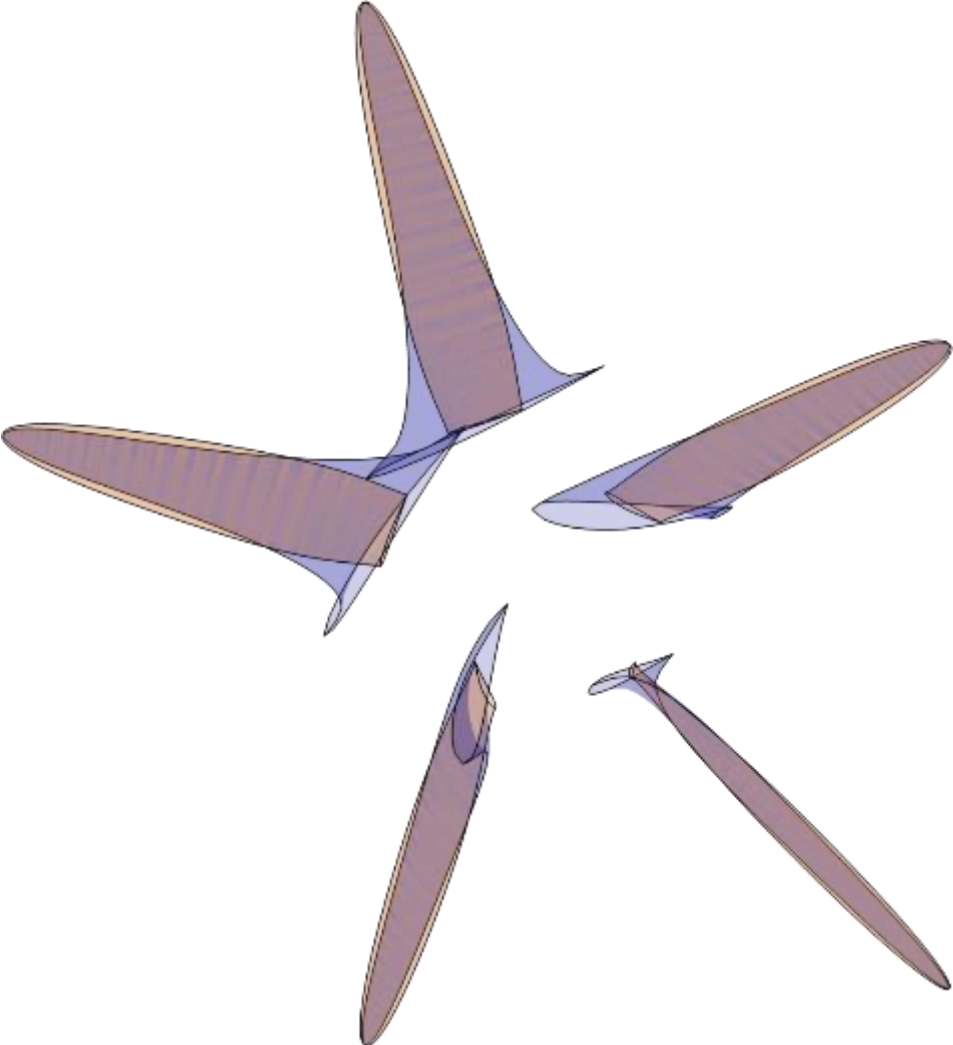

# Comparison of MIL prop and new prop with Optional Step 1

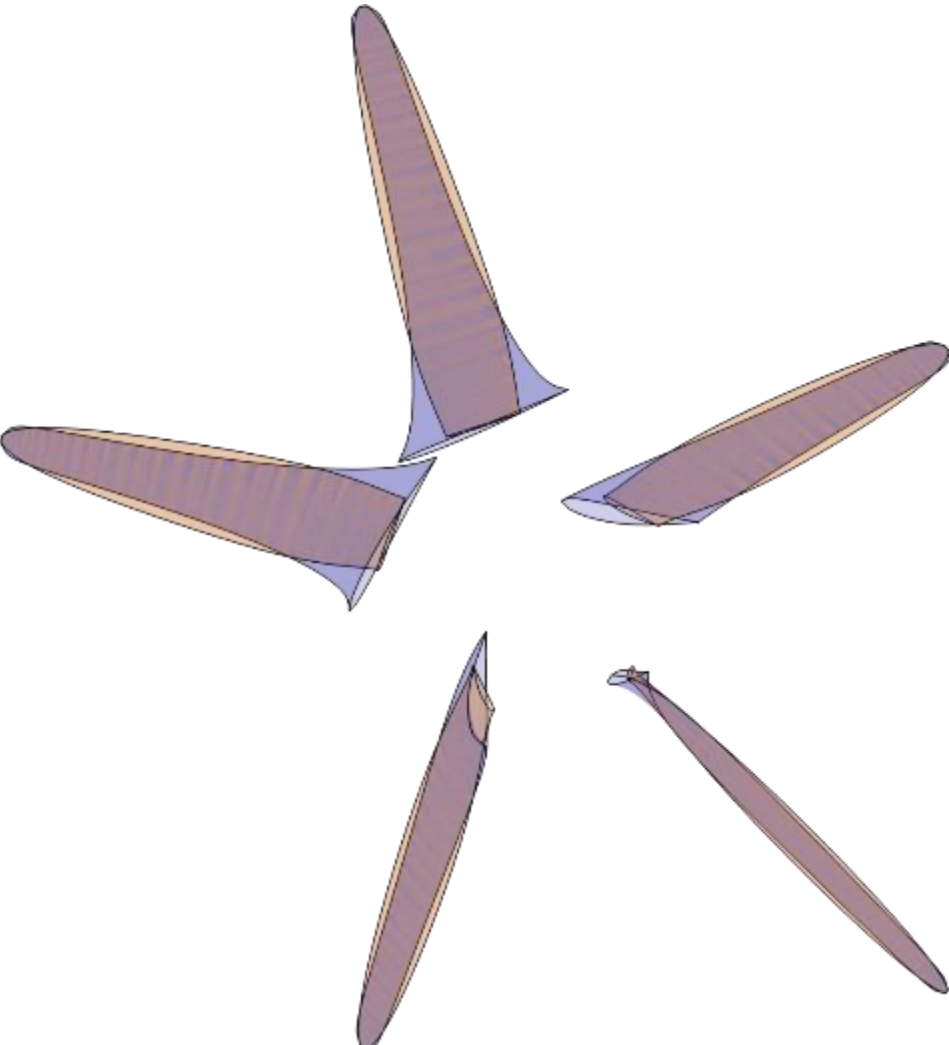

# Comparison of MIL prop and new prop with Optional Step 2

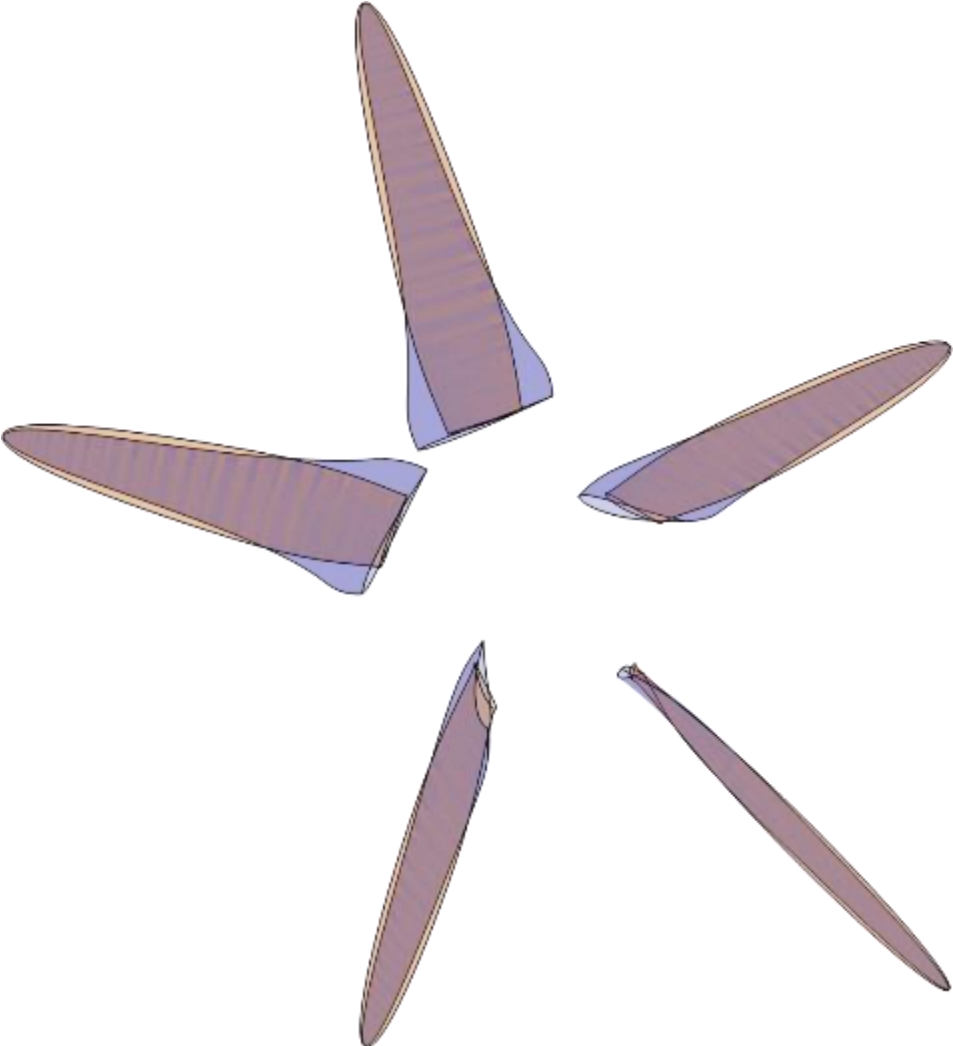

# Comparison of MIL prop and new prop with Optional Steps 1 & 2

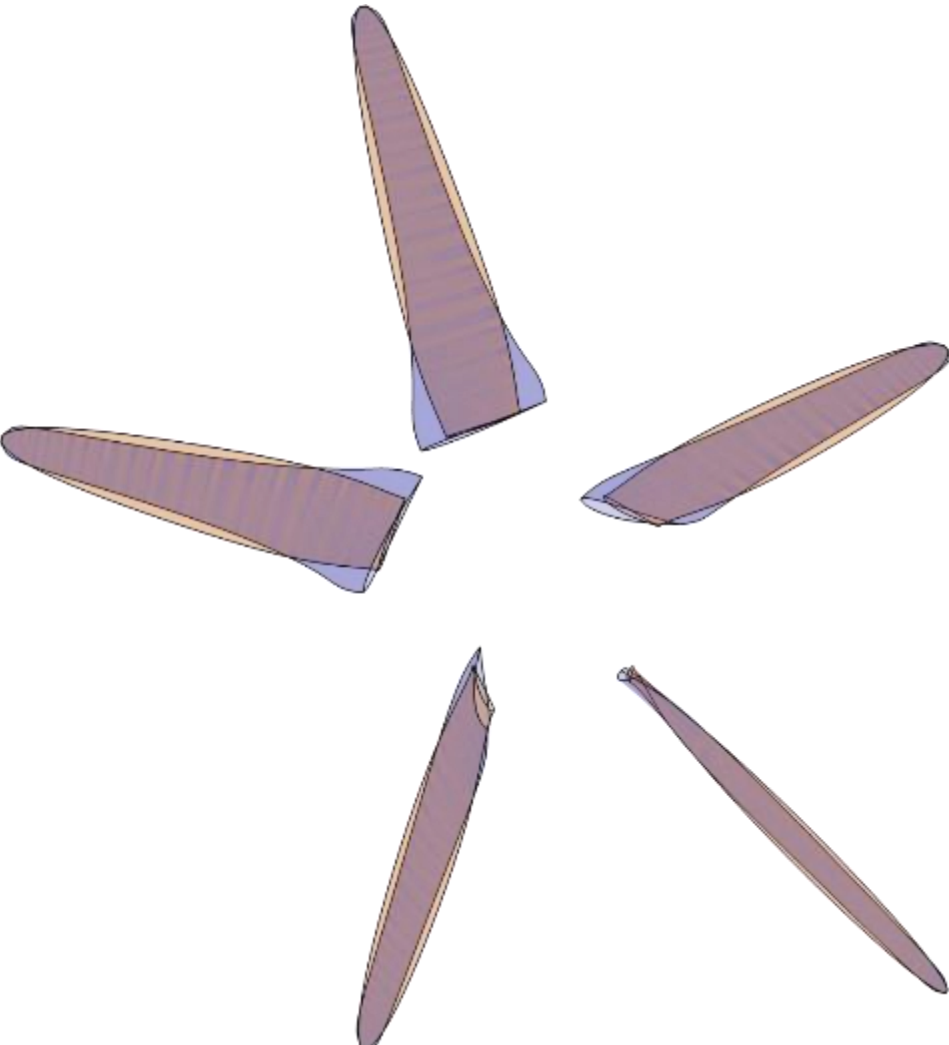

# The design method is based on BEMT and seeks to maintain a near-uniform axial velocity distribution

- Method is built on blade element momentum theory (BEMT)
  - Analyze prop as sum of many “blade elements” as 2-D airfoils
  - Local velocity split into axial and tangential components, which are defined by the freestream, prop rotation, and prop-induced velocities
  - Induced velocities presented as axial and tangential induction factors ( $a$  and  $a'$ )
  - We assume that the angular velocity added to the slipstream is small compared to the angular velocity of the propeller
- Method has four main steps:
  1. Set axial induction factor distribution
  2. Determine blade twist angle distribution
  3. Determine blade chord length distribution
  4. Verify performance and iterate (if required)

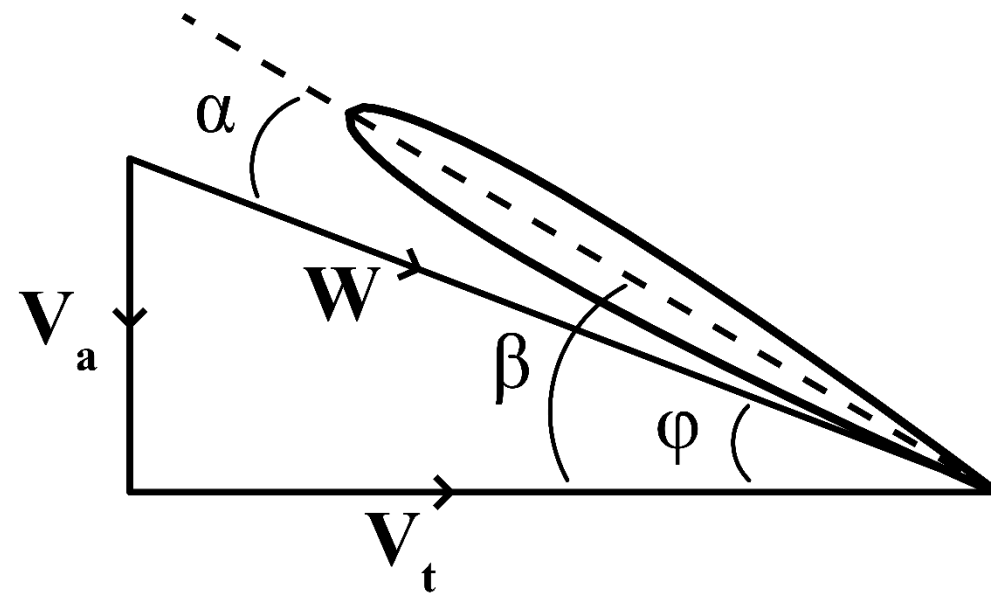

$$V_a = V_\infty (1 + a)$$

$$V_t = \Omega r (1 - a')$$

# Changing the maximum value of the slope can have large impacts on the resulting geometry

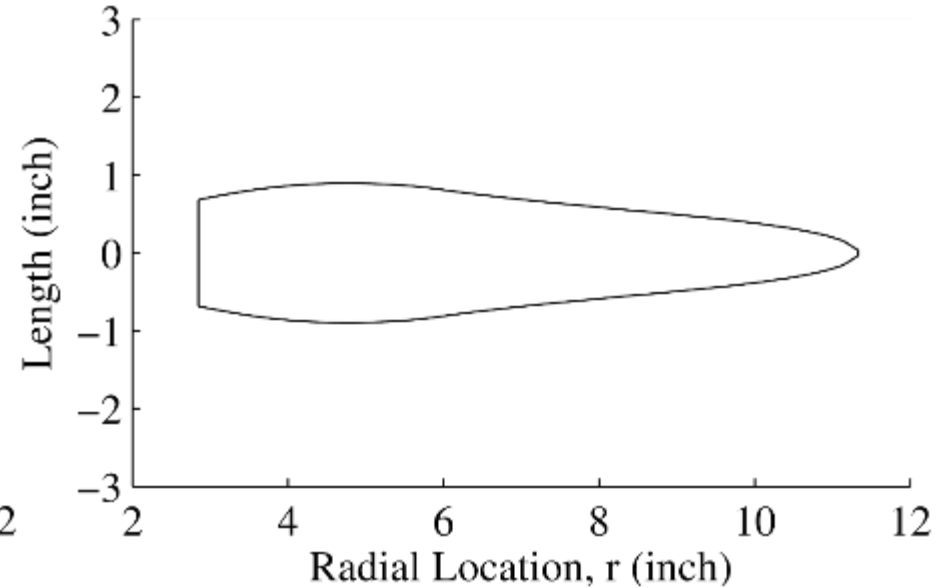
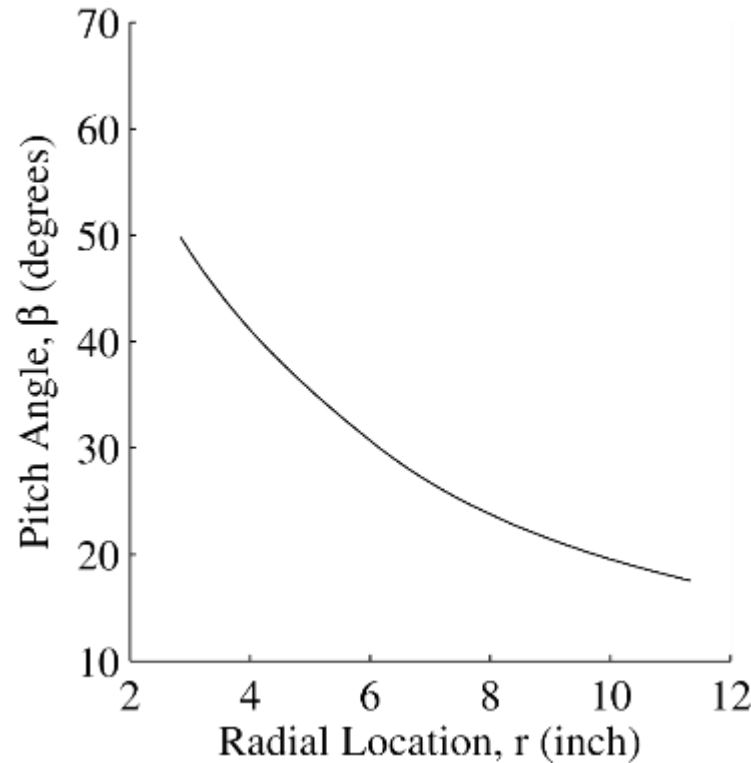
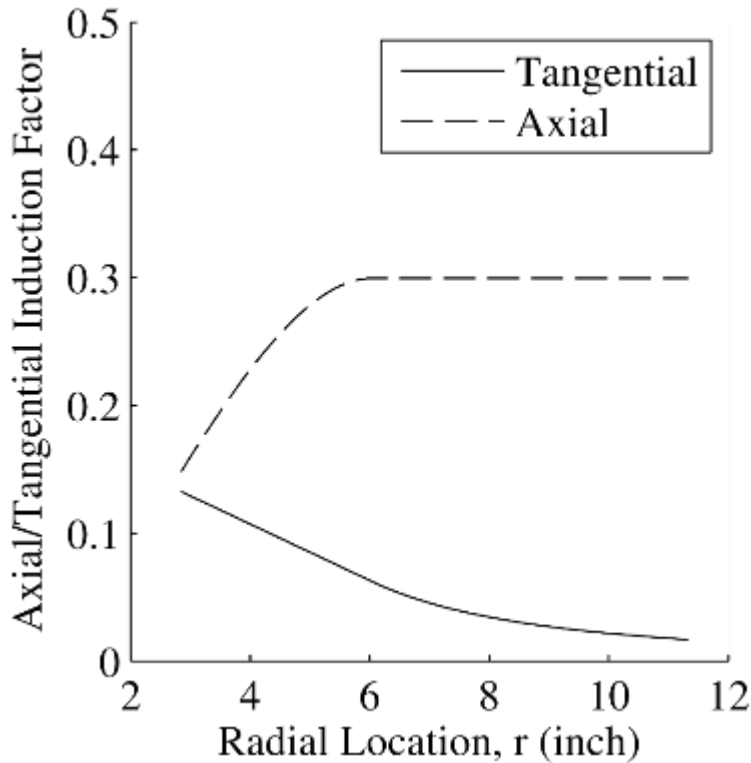

- With  $da'/d(r/R)=0.25$

## Step 2: Determine blade pitch angle distribution

- Calculate inflow angle,  $\varphi$ , with axial and tangential induction factors from Step 1
- For desired airfoil(s), specify desired angle of attack / section lift coefficient distribution
  - If only concerned with point performance, select  $\alpha$  for max L/D
  - Other considerations such as off-design point operation may lead to different  $\alpha$  distribution
- Blade twist found from inflow angle and angle of attack distributions

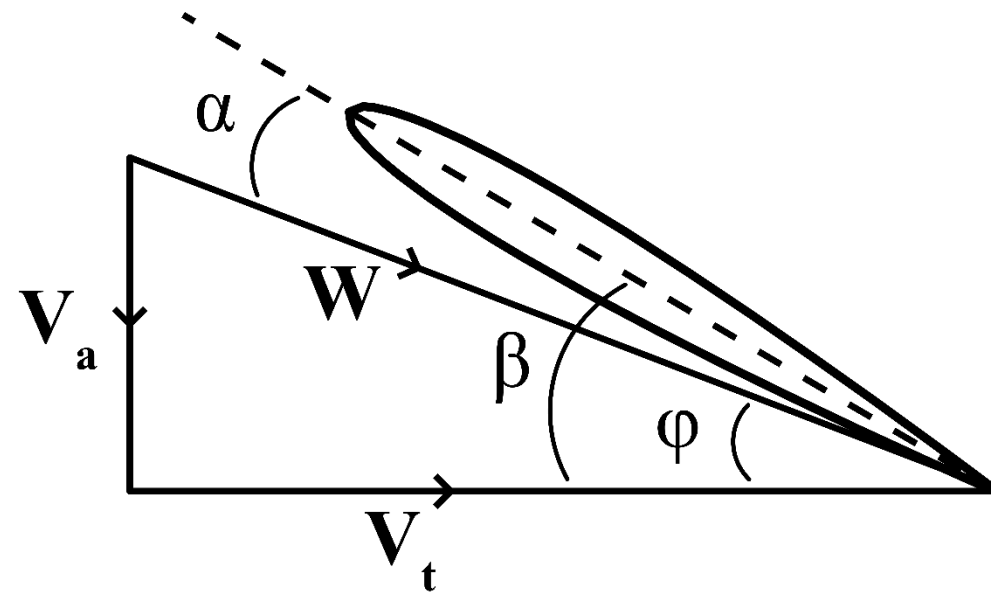

$$\varphi = \tan^{-1} \left( \frac{V_{\infty}(1+a)}{\Omega r(1-a')} \right)$$

$$\beta = \varphi + \alpha$$

## Step 3: Determine blade chord length distribution

- The thrust from an annulus of the prop disk can be expressed in two equations
  - One from momentum theory and the other blade element theory
  - Only unknown is the chord length
- Equate two expressions for thrust and solve for the chord length
  - Assumes the airfoil aerodynamic characteristics are known
  - Number of blades must be specified

$$dT = 4\pi r \rho V_\infty^2 (1 + a) a F dr$$

$$dT = \frac{B}{2} \rho W^2 [c_l \cos(\varphi) - c_d \sin(\varphi)] c dr$$

where  $F = \frac{2}{\pi} \cos^{-1} \left[ e^{-\frac{B}{2r} \frac{(R-r)}{\sin(\varphi)}} \right]$

$$c = \frac{8\pi r V_\infty^2 (1 + a) F}{B W^2 [c_l \cos(\varphi) - c_d \sin(\varphi)]}$$



# Step 1, Modification Option 1: increase induced axial velocity near tip

- Desire to increase axial velocity near tip
- Use Prandtl tip loss factor to account for tip losses

$$F = \frac{2}{\pi} \cos^{-1} \left[ e^{\frac{-B (R' - r)}{2 r \sin(\varphi)}} \right] \quad a_{mod} = \frac{a}{F}$$

