

# Green Propellant Loading Demonstration at U.S. Range

Henry W. Mulkey<sup>1</sup>, Joseph T. Miller<sup>2</sup> and Caitlin E. Bacha<sup>3</sup>  
*NASA Goddard Space Flight Center, Greenbelt, Md, 20771*

The Green Propellant Loading Demonstration (GPLD) was conducted December 2015 at Wallops Flight Facility (WFF), leveraging work performed over recent years to bring lower toxicity hydrazine replacement green propellants to flight missions. The objective of this collaboration between NASA Goddard Space Flight Center (GSFC), WFF, the Swedish National Space Board (SNSB), and Ecological Advanced Propulsion Systems (ECAPS) was to successfully accept LMP-103S propellant at a U.S. Range, store the propellant, and perform a simulated flight vehicle propellant loading. NASA GSFC Propulsion (Code 597) managed all aspects of the operation, handling logistics, preparing the procedures, and implementing the demonstration. In addition to the partnership described above, Moog Inc. developed an LMP-103S propellant-compatible titanium rolling diaphragm flight development tank and loaned it to GSFC to act as the GPLD flight vessel. The flight development tank offered the GPLD an additional level of flight-like propellant handling process and procedures. Moog Inc. also provided a compatible latching isolation valve for remote propellant expulsion. The GPLD operation, in concert with Moog Inc. executed a flight development tank expulsion efficiency performance test using LMP-103S propellant. As part of the demonstration work, GSFC and WFF documented Range safety analyses and practices including all elements of shipping, storage, handling, operations, decontamination, and disposal. LMP-103S has not been previously handled at a U.S. Launch Range. Requisite for this activity was an LMP-103S Risk Analysis Report and Ground Safety Plan. GSFC and WFF safety offices jointly developed safety documentation for application into the GPLD operation. The GPLD along with the GSFC Propulsion historical hydrazine loading experiences offer direct comparison between handling green propellant versus safety intensive, highly toxic hydrazine propellant. These described motives initiated the GPLD operation in order to investigate the handling and process safety variances in project resources between LMP-103S and typical in-space propellants. The GPLD risk reduction operation proved successful for many reasons including handling the green propellant at a U.S. Range, loading and pressurizing a flight-like tank, expelling the propellant, measuring the tank expulsion efficiency, and most significantly, GSFC propulsion personnel's new insight into the LMP-103S propellant handling details.

---

<sup>1</sup> Propulsion Engineer, Propulsion Branch, GSFC/ Mail Stop 597, AIAA Member.

<sup>2</sup> Propulsion Engineer, Propulsion Branch, GSFC/ Mail Stop 597.

<sup>3</sup> Propulsion Engineer, Propulsion Branch, GSFC/ Mail Stop 597, AIAA Member.

## Nomenclature

ADN	= Ammonium Dinitramide	IRAD	= Internal Research and Development
ASME	= American Society of Mechanical Engineers	MEOP	= Maximum Expected Operating Pressure
BB-1	= Blowback Valve	MOP	= Maximum Operating Pressure
CC	= Catch Container	MMS	= Magnetospheric MultiScale
CE	= European Conformity	NASA	= National Aeronautics and Space Administration
CSG	= Centre Spatial Guyanais	PACE	= Plankton, Aerosols, Clouds and ocean Ecosystems
DAQ	= Data Acquisition	PAPR	= Powered Air Purifying Respirator
DI	= De-Ionized	PPE	= Personal Protective Ensemble
DIAB	= DAQ-in-a-Box	PRISMA	= Prototype Research Instruments and Space Mission technology Advancement
DVT	= Design Verification Tank	PVS	= Pressure Vessel Systems
ECAPS	= Ecological Advanced Propulsion Systems	RAR	= Risk Analysis Report
EPV	= Expulsion Valve	SBIR	= Small Business Innovative Research
ESA	= European Space Agency	SCAPE	= Self Contained Atmospheric Protective Ensemble
ESD	= Electric Static Discharge	SDS	= Safety Data Sheet
FC	= Fuel Cart	SHAR	= Sriharikota High Altitude Range
FDT	= Flight Development Tank	SNSB	= Swedish National Space Board
FDV	= Fill and Drain Valve	STMD	= Space Technology Mission Directorate
FVV	= Fill and Vent Valve	TC	= Transport Container
GAS	= Get Away Special	TRR	= Test Readiness Review
GHe	= Gaseous Helium	TT	= Transfer Tank
GOWG	= Ground Operation Working Group	TTA	= Transfer Tank Assembly
GPLD	= Green Propellant Loading Demonstration	VAFB	= Vandenberg Air Force Base
GPLE	= Green Propellant Loading Equipment	VI	= Virtual Instrument
GPM	= Global Precipitation Measurement	WFF	= Wallops Flight Facility
GSP	= Ground Safety Plan	WFIRST	= Wide Field Infrared Survey Telescope
GSFC	= Goddard Space Flight Center		
HPGP	= High Performance Green Propulsion		
IA	= Implementing Arrangement		
IPA	= Isopropyl Alcohol		

## I. Introduction

Green propulsion offers numerous benefits to NASA missions, ranging from increasing propulsion system performance to decreasing spacecraft processing hazards, schedule, and cost<sup>1,2</sup>. Technology maturation funded through the Space Technology Mission Directorate (STMD), the Small Business Innovative Research (SBIR) Program, and National Aeronautics and Space Administration (NASA) field center's internal research and development efforts over the past several years continues to demonstrate NASA's interest in hydrazine-alternative green propulsion technologies. Recognizing a mutual interest in the exploration and use of outer space for peaceful purposes, NASA and the Swedish National Space Board (SNSB) outlined a collaboration contained in an Implementing Arrangement (IA) in which the agencies collaborate to perform initial testing for spacecraft applications of High Performance Green Propulsion (HPGP) technologies. Signed in September 2013, NASA initiated the IA with the SNSB to work synergistically on HPGP technologies and mission infusion potential. Ecological Advanced Propulsion Systems (ECAPS) HPGP technology employs the Swedish-developed LMP-103S, an ammonium dinitramide (ADN), water, methanol, and ammonia propellant blend, which has demonstrated >6% higher specific impulse and >30% higher density impulse over hydrazine<sup>3</sup>. The IA supports three principal activities<sup>4</sup>: 1-lbf (5 N) and 5-lbf (22 N) thruster development and life tests, tank fracture mechanics testing to determine pressurized propellant tank safe design life<sup>5,6</sup>, and a U.S. Range propellant loading demonstration. Thruster and tank fracture mechanics testing are scheduled to be completed in 2017. This paper focuses on the results and lessons learned from the propellant loading demonstration effort conducted at the U.S. Launch Range, NASA Wallops Flight Facility (WFF).

In 2010, the Prototype Research Instruments and Space Mission technology Advancement (PRISMA) launched from Yasny Launch facility in Russia. This mission was the first in-space green propellant demonstration employing two 0.2-lbf (1 N) HPGP thrusters and carrying a 12.1 lb (5.5 kg) LMP-103S propellant load. In addition to the HPGP system, PRISMA also utilized a monopropellant hydrazine propulsion system with six 0.2-lbf (1 N) thrusters<sup>7</sup>. This approach allowed direct comparison of on-orbit thruster and propulsion system performance and spacecraft processing. By conducting concurrent hydrazine and LMP-103S PRISMA spacecraft loading operations, ECAPS differentiated propellant commodity payload processing schedule and cost. The PRISMA mission realized greater than two-third savings in overall schedule and total cost with the HPGP propellant load versus the hydrazine equivalent<sup>8</sup>. From this initial work, NASA has formulated potential reductions in future science mission payload processing employing HPGP systems. There are discernable differences between launching from Yasny and U.S. Ranges; in addition, the various U.S. Ranges express different concerns regarding spacecraft processing safety and risk evaluation. Accordingly, the LMP-103S propellant loading demonstration was intended for U.S. Range approval of LMP-103S propellant and to further realize the gains related to the ease of handling. In support of Google's Terra Bella SkySat spacecraft constellation<sup>9</sup>, ECAPS will be performing LMP-103S propellant loading operations at three launch Ranges in 2016-2017: The first HPGP propellant load operation was conducted June 2016 at Sriharikota High Altitude Range (SHAR), India, four HPGP propellant load operations at Centre Spatial Guyanais (CSG), French Guiana and six HPGP propellant load operations at Vandenberg Air Force Base (VAFB), California U.S.A. With the inclusion of Yasny and WFF, over this year and the following, LMP-103S propellant will have been handled at five launch Ranges on three different continents<sup>10</sup>. This outcome results in four major Range Safety organizations (U.S., European, Indian, and Russian) gaining familiarity with LMP-103S propellant loading operations and the associated benefits.

## II. GPLD Objective and Overview

The Green Propellant Loading Demonstration (GPLD) at U.S. Range was a pathfinder activity for missions desiring the increased performance and ease of handling benefits associated with green propellants. Funded through the Goddard Space Flight Center (GSFC) Internal Research and Development (IRAD) program, the GPLD operation was successfully conducted December 2015 at WFF demonstrating the reduction in effort over an equivalent hydrazine load. The objective of this collaboration between GSFC, WFF, the SNSB, and ECAPS was to successfully accept LMP-103S propellant at a U.S. Range, store the propellant, and perform a simulated flight vehicle propellant loading. The GPLD program collaboration is shown in Figure 1.

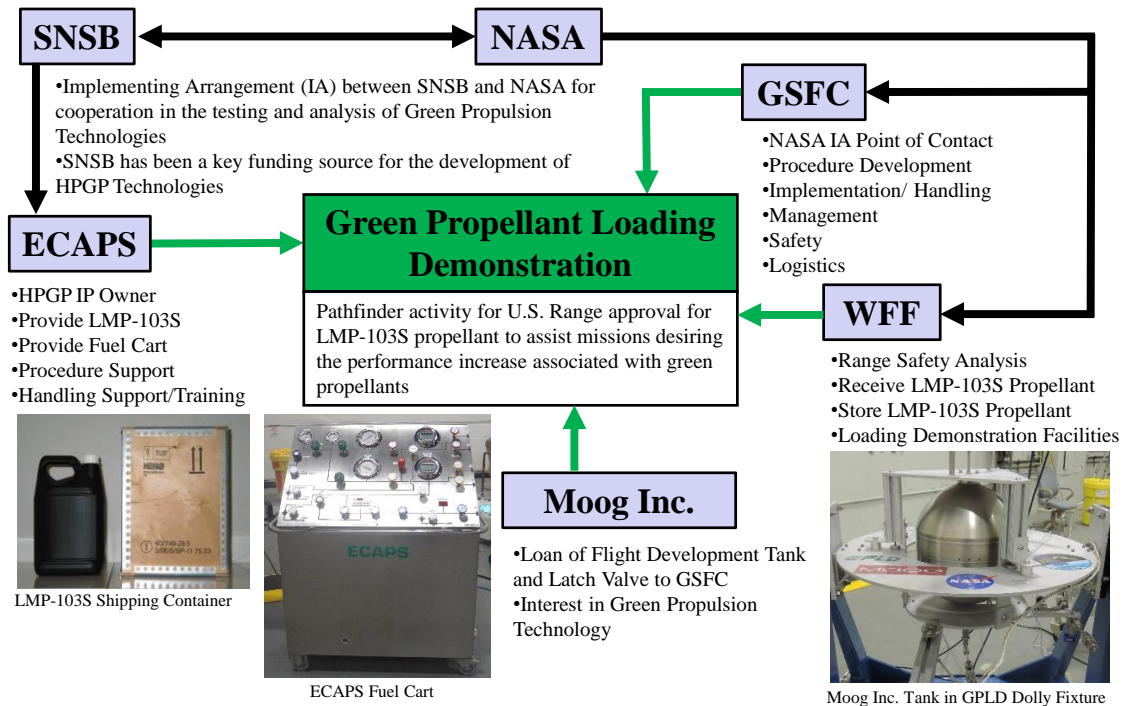

Figure 1: GPLD Collaboration

GPLD had complex programmatic and logistical requirements. In addition, due to staff constraints caused by other space flight commitments (dashed blue line, Figure 2), GPLD was unable to begin in earnest until March 2015, compressing the overall GPLD schedule. As detailed in Figure 2, GPLD was able to successfully demonstrate LMP-103S propellant transport, storage, and handling, including all procedure development and safety negotiation, within nine months (April – December 2015). The operation was low-cost and conducted on an abbreviated timeframe. A total of five Ground Operation Working Groups (GOWGs) were conducted between GSFC and WFF, to present the GPLD status, initiate discussions, and work actions. The Moog Inc. Flight Development Tank (FDT) was qualified to a tailored version of AIAA S-080<sup>11</sup> for use in the GPLD operation at WFF. This involved weekly discussions between Moog Inc. and GSFC to ensure that the FDT was on schedule and meeting GPLD operation-required milestones, as well as communicating test and results to WFF Range Safety. ECAPS provided GSFC LMP-103S propellant and loaned GSFC the use of their Fuel Cart (FC) for the GPLD operation. Use of the ECAPS FC required coordination with WFF on FC pressure vessel and loading equipment certification. Due to the LMP-103S propellant’s novelty and Range unfamiliarity, logistics for receiving and handling the propellant proved challenging; however, Range acceptance documents were created to define the requirements for facility, ground support equipment, and personal protective equipment (PPE).

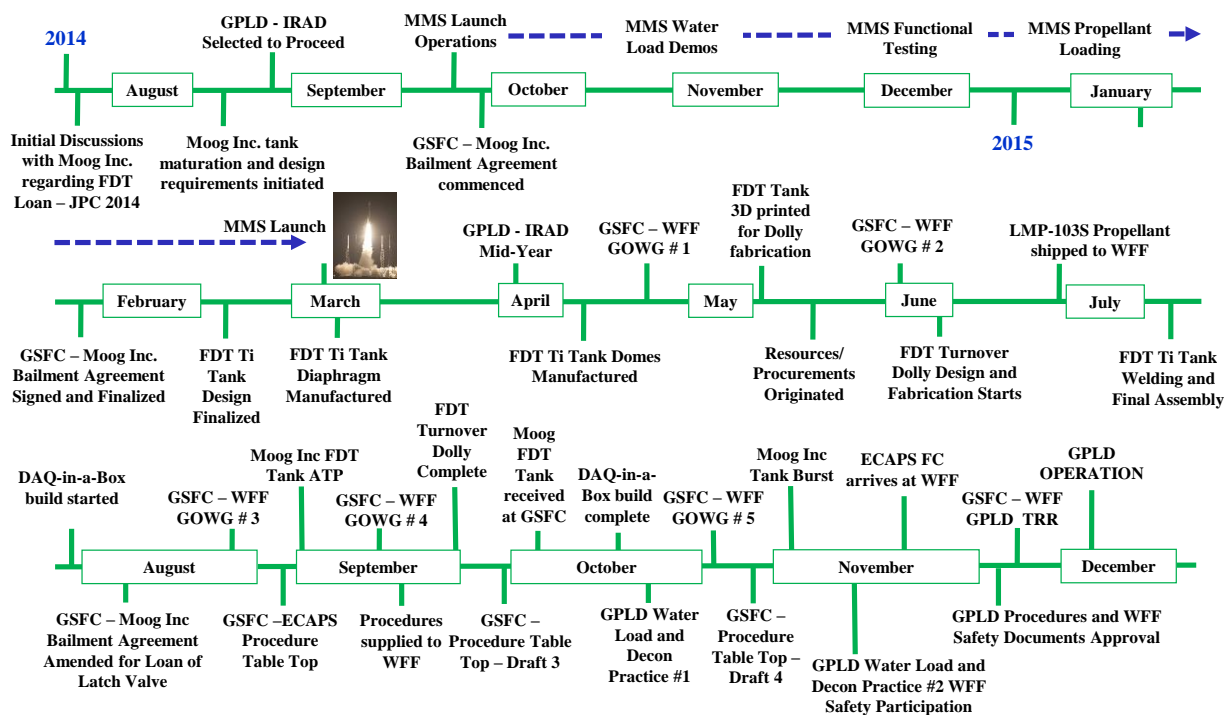
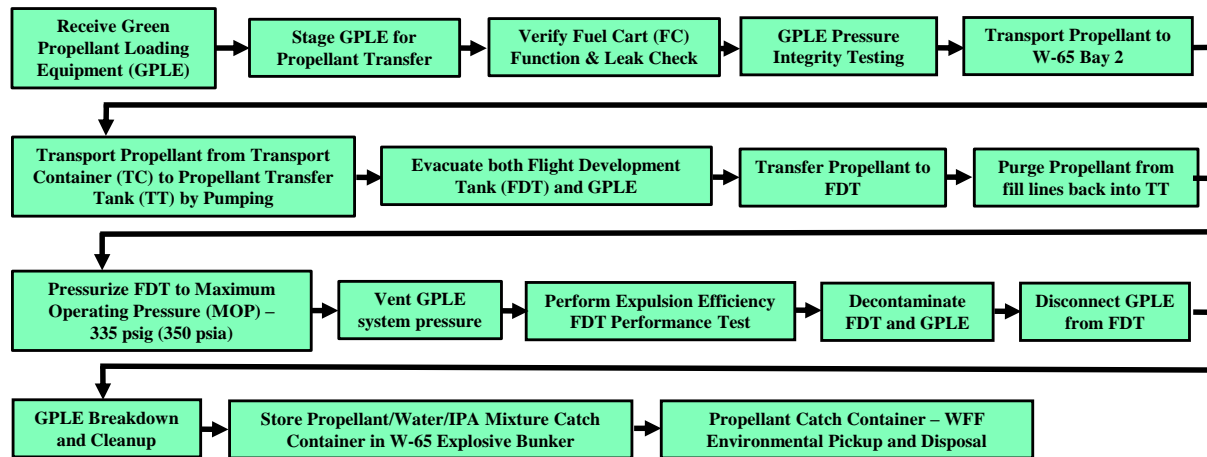

Figure 2: GPLD Planning and Implementation Timeline

### III. GPLD Operations

The GPLD operation was structured to imitate a flight vehicle propellant loading. Figure 3 details the GPLD operational flow. The loading and decontamination operations and subsequent procedures were developed from combined NASA GSFC historical hydrazine and ECAPS LMP-103S propellant handling experiences. The GPLD primarily was structured after the PRISMA spacecraft propellant loading operation. One notable difference was that GPLD required two LMP-103S open container operations, as opposed to one, and included a FDT tank expulsion test. GSFC propulsion personnel have recently loaded hydrazine propellant for the Global Precipitation Measurement (GPM) and the Magentospheric MultiScale (MMS) four observatory constellation missions. GPM’s hydrazine load was 1,202 lb (545 kg) and MMS loaded a total of 3,630 lb (1,646 kg). Each of these loading experiences provided framework and were consolidated to develop the GPLD operational plan and procedures. The GPLD, alongside GSFC Propulsion historical hydrazine loading experiences, provided direct comparison between handling green versus hydrazine propellant. These described motives initiated the GPLD operation, in order to investigate the process safety variances in project resources between LMP-103S and typical in-space propellants.



**Figure 3: GPLD Operations Plan**

### A. Loading Facility

The GPLD operation was conducted at the WFF W-65 Bay 2 launch support vehicle assembly processing facility. W-65 Bay 2 is a large high bay, 34' wide x 65' long x 21' tall (10 x 19 x 6.4 m) relating to a volume of 46,410 ft<sup>3</sup> (1,314 m<sup>3</sup>). The facility has temperature control within a 45 – 90°F (7.2 – 32.2°C) and humidity control of 30% – 70%. The facility does not contain a fire suppression system; however, WFF Launch Range has an on-site fire station. The facility has lightning protection and warning systems. The W-65 facility has a 5,000 lb (2,268 kg) 1.1 explosive class handling capability and 300,000 lb (136,078 kg) 1.3 explosive class. If mixed 1.1 and 1.3 explosives are present and to be handled, then the lower handling capacity of 5,000 lb is the limit.

The WFF Range and Explosive Safety Officer classified the GPLD operation and LMP-103S (when out of transport packaging) as 1.3C in accordance with NASA-STD-8719.12<sup>12</sup>. The sum total of LMP-103S propellant handled was 27 lb (12.4 kg) provided in two 1.32 gal (5 L) transport containers.

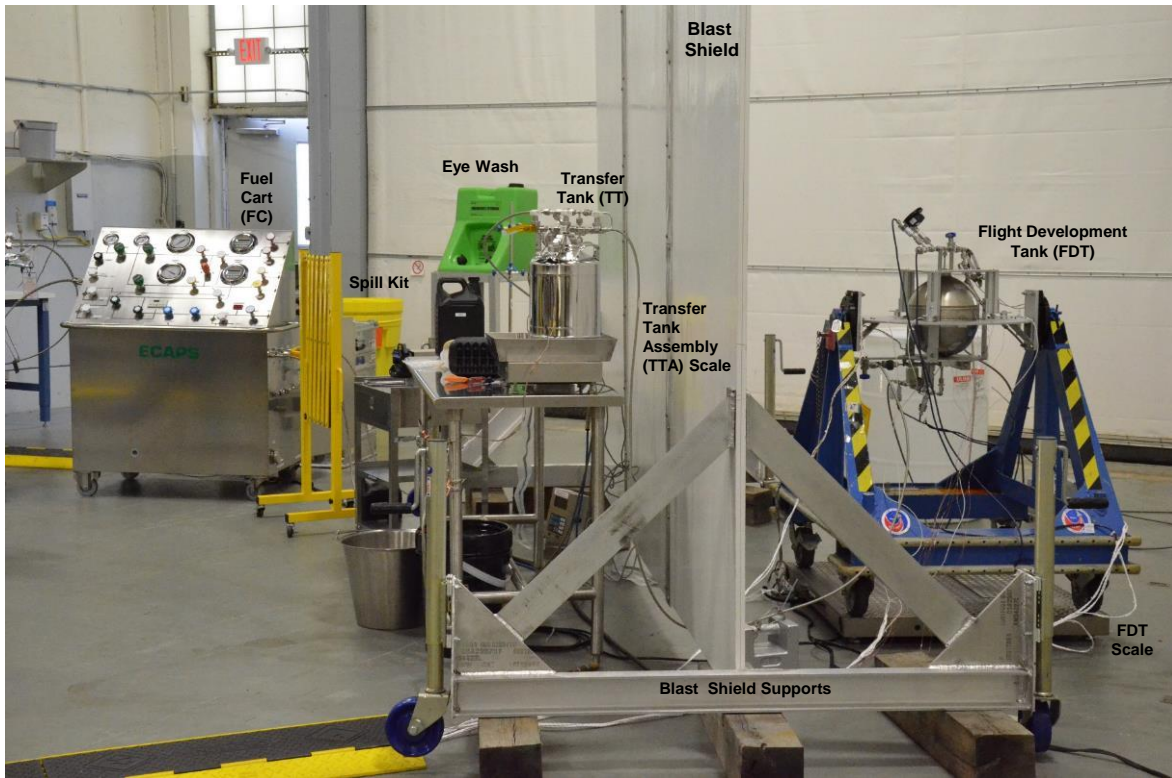

**Figure 4: WFF W-65 Facility**

### B. Loading Equipment

The GPLD required ground support equipment to complete pressure and vacuum integrity testing, LMP-103S propellant transfer from shipping container to a propellant loading source container, propellant transfer to the FDT and pressurization, FDT propellant expulsion, and decontamination. Pressure and propellant transfer operations are inherent to propellant loading operations; however, the GPLD exhibited one additional element, the FDT expulsion test and requisite LMP-103S propellant collection. Figure 5 displays the Green Propellant Loading Equipment (GPLE). Figures 6a and 6b show the ECAPS FC and the GPLD Transfer Tank (TT) processing area in the WFF W-65 Bay 2 facility.

The FC, provided by ECAPS enabled all pressurization and evacuation operations; the FC contains a high pressure supply capability rated at 1000 psia (69 bar), a low pressure branch rated at 29 psia (2 bar), and a vacuum system section. Each pressurization and evacuation section has integrated venting allowing the media to exit the cart at one location. The FC is fabricated of commercially available pressure regulators, valves, digital and analog pressure gauges all utilizing CRES wetted materials and connections. The fittings and tubing connecting these FC components were similarly CRES materials.



**Figure 5: Green Propellant Loading Equipment (GPLE) Staged Overview – WFF W-65 Bay 2 Facility**

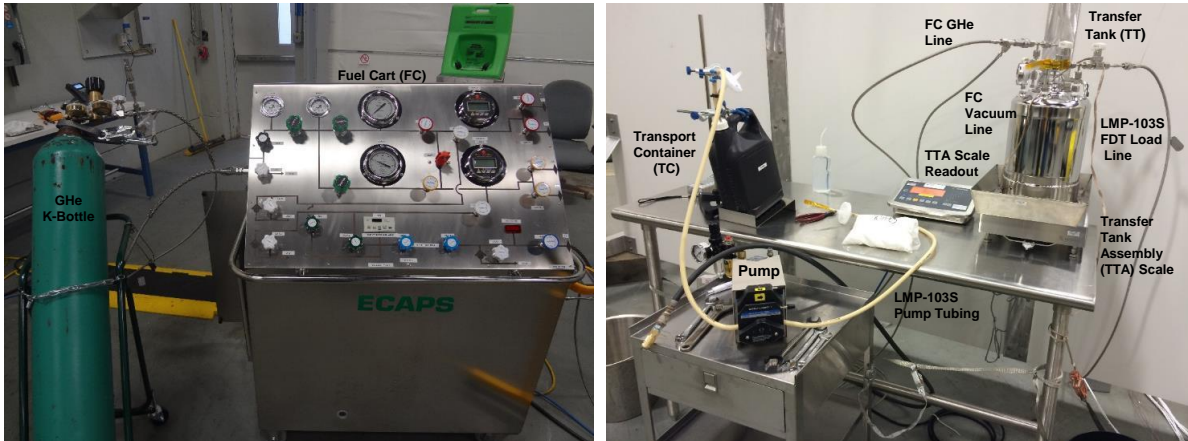

**Figure 6: a) ECAPS Fuel Cart (FC)**

**b) GPLD Transfer Tank (TT) Processing Area**

An ASME stamped 3 gal (11.35 L) 304L stainless steel vessel was used as the propellant loading source container, designated the TT. This 205 psig (14.1 bar) pressure rated vessel offered three port connections and one dedicated outlet with a dip tube assembly and an enclosure lid enabling a moderate level of vacuum capability. The TT was fitted with a valve and tube assembly manifold allowing FC low pressure and vacuum/vent pathways, and a propellant fill port utilized for loading the propellant from the shipping Transport Container (TC) to the TT. In addition, this valve assembly allowed pressurant or propellant media flow paths from the TT to the FDT tank. A compound analog pressure gauge and a Pressure Vessel Systems (PVS) required popping relief valve were installed on the remaining two TT ports. A clean, empty and identical 1.32 gal (5 L) propellant TC with a filter and dip tube cap assembly was employed as an intermediary for cap replacement of a full LMP-103S propellant container. This open container operation was required in order to place the filter and dip tube assembly into the full propellant TC for the propellant transfer into the TT using a peristaltic pump.

The TT was positioned on a transfer tank assembly (TTA) digital scale (0-110.2 lb (0-50 kg)) used to track the propellant mass leaving the TT and entering the FDT. Due to the LMP-103S propellant pump tubing connection to the TT and the potential for small drips, the TT was placed in a stainless steel catch tray. Additionally, there were 3x load cells (0-50 lb (0 - 22.7 kg)) located 120° apart on the FDT dolly to measure the propellant mass loaded into the FDT. As a tertiary means of mass monitoring, the FDT turnover dolly was positioned on a larger footprint digital scale (5,511.5 lb (0-2,500 kg)). The mass of propellant loaded into the FDT and the mass of propellant off-loaded from the TT was monitored via these three measurements. The TTA digital scale tracked the official mass of propellant loaded into the FDT.

As pictured in Figure 7, the GPLD FDT was developed by Moog, Inc. and is a rolling diaphragm<sup>13</sup> tank with a 400 psig (27.6 bar) Maximum Expected Operating Pressure (MEOP). For the GPLD operation the Maximum Operating Pressure (MOP) was designated 335 psig (23.1 bar), as governed by the 350 psia (24.1 bar) HPGP thrusters inlet maximum pressure<sup>14</sup>. The diaphragm and all components of the tank are manufactured from commercially pure titanium. The tank features an all welded construction of a metallic diaphragm to the tank shell. The pressurant and propellant volumes are separated by the diaphragm. The tank liquid volume is 390 in<sup>3</sup> (~6.4 L) with a pressurant volume of 190 in<sup>3</sup> (~3.1 L). Since this tank was only used for ground demonstration, the FDT was qualified to a tailored version of the AIAA S-080. Moog Inc. manufactured an acceptance FDT that was used for the GPLD operation and a Design Verification Tank (DVT) that was qualified and eventually burst. The Moog, Inc. tank for GPLD operations was considered pseudo flight hardware and was only approved by WFF Range safety for the GPLD ground use operation. For this tank design to be considered fully flight qualified, it will need to be reassessed against AIAA-S080, or the governing Range Safety manual. Tank fracture mechanics safe life testing and crack growth analysis are still necessary to satisfy U.S. Range requirements.

A Space Shuttle Get Away Special (GAS) payload dolly was brought to GSFC for refurbishment to serve as the FDT tank turnover dolly. As illustrated in Figure 7, a specialized cage fixture was fabricated to allow tank mounting into the dolly. The fixture also allowed the tank and propellant load to balance, disturbance free, on the three load cells as shown in more detail in Figure 7a. An FDT surrogate was 3D printed in order to manufacture the tank fixture and dolly before the tank arrived. Figure 7b exhibits the GPLD FDT tank assembly build up before final pressure and propellant inflow and outflow flex line connections hookup.

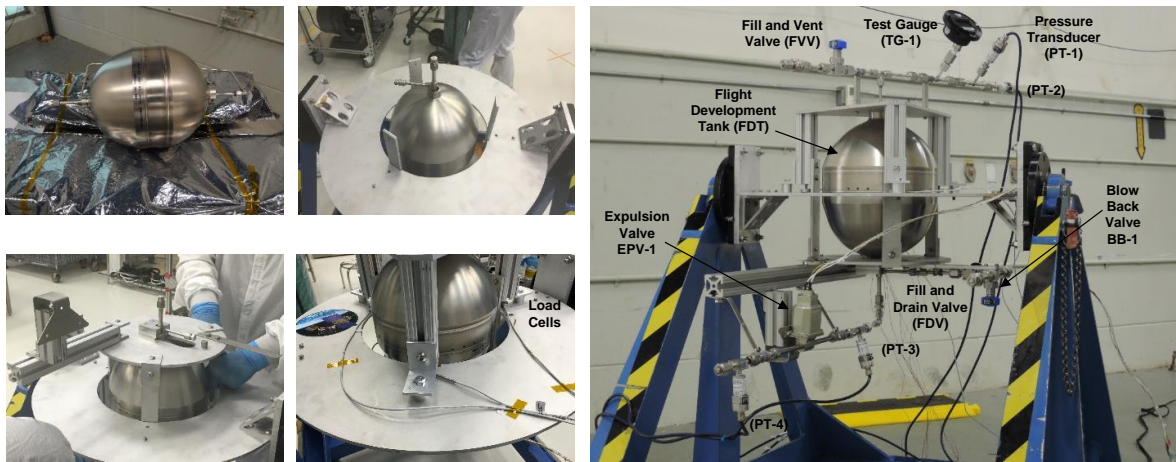
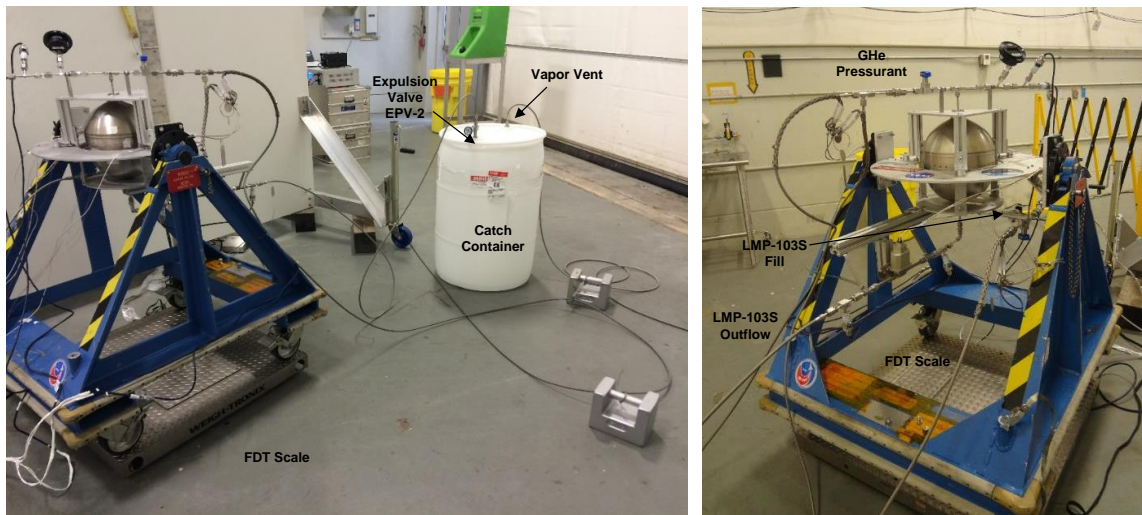

**Figure 7: a) FDT Dolly Installation**

**b) GPLD FDT Dolly Installation**

Figure 8 depicts the final FDT configuration. The FC gaseous pressurant flex line supply was connected to the top portion of the FDT with the Fill and Vent Valve (FVV) providing isolation. Local pressure measurement data from two pressure transducers and one digital pressure gauge were located on the FDT gas side. The high pressure gas FDT tank inlet FC supply extended to the propellant FDT compartment via the Blow Back valve (BB-1) isolation. This type of crossover enabled higher, > 29 psia (2 bar), pressure capability for integrity testing. The TT propellant flex line supply linked the FDT lower portion with the Fill and Drain Valve (FDV) providing isolation. This path allowed LMP-103S propellant to flow from the TT into the FDT propellant volume. During FDT expulsion, the LMP-103S propellant flowed out the FDT lower section into the Moog Inc. model 052-265 latch valve, labeled expulsion valve -1 (EPV-1), through a metering valve EPV-2 into a propellant catch container (CC). The LMP-103S propellant vapor exited the container and was vented from the CC directly to atmosphere through a small port in the Bay 2 rear wall.

The EPV-1 valve was connected to the FDT outlet tube fitting assembly and to the propellant outflow flex line, connected to the CC, using PTFE non-marring Swagelok front and back ferrules, stainless steel nuts, and lock wiring across the union. This operational arrangement required full pressurization to FDT MOP in order to verify connection integrity before propellant commodity introduction. In addition, due to the lack of Swagelok vendor pressure rating for the PTFE ferrules use, WFF PVS required GSFC propulsion to perform additional pressure testing to prove the connection safe use. To accomplish this, a cycling test was conducted to pressurize a small tube section to 1.25x MOP, then vented and evacuated, repeated five times. This test was repeated three times more than nominally would be conducted during the GPLD operation. A high pressure test was also performed to determine the PTFE ferrules and lock wire maximum hold pressure. This operation was identical to the cycling pressure test setup, but with fresh PTFE ferrules. The tube section was pressurized in incremental stages with five minute test periods in between. The lock wire broke and the PTFE ferrule slipped off the tube at nearly three minutes into the 1200 psi (82 bar) pressure test. These two operations provided confidence into this connection arrangement.

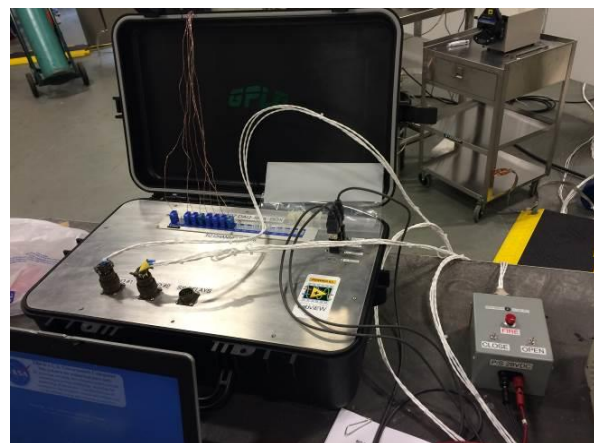

**Figure 8: a) FDT Expulsion and Catch Container**

**b) FDT Final Configuration**

### C. Instrumentation

As with other aspects of the GPLD project, data acquisition (DAQ) needed to be accomplished on budget and safely. To this end, a DAQ-in-a-Box (DIAB) shown in Figure 9 was fabricated. A medium sized Pelican case housed two NI-6212 differential voltmeters, one NI-9213 thermocouple reader and one NI-6525 low-power relay control. Each of the devices communicated via USB to an attached PC running LabVIEW and a customized virtual instrument (VI) performing all of the data logging and calculations. The NI devices were hardwired to circular connectors installed on an aluminum panel to enable quick and consistent connections to be made to the Omega load cells and Brooks pressure transducers. The T-type thermocouples were attached via a thermocouple bulkhead mount with two-prong connectors. Also shown in Figure 9 is the EPV-1 latch valve fire box that was fabricated to enable remote actuation (open and closing) for FDT expulsion.



**Figure 9: DAQ-in-a-Box**

The VI, shown in Figure 10, was developed using LabVIEW 2013 over the course of several weeks and was designed to be “plug and play” while still allowing for the user to control various aspects to safely monitor the loading and depressurizing operations. Through several water load rehearsals, the VI was judged robust enough to not cause any hindrance during setup for, and execution of, the loading and expulsion operations. All hardware calibration data was taken from vendor specifications but verified against test data generated by the team during the run-up to the operations.



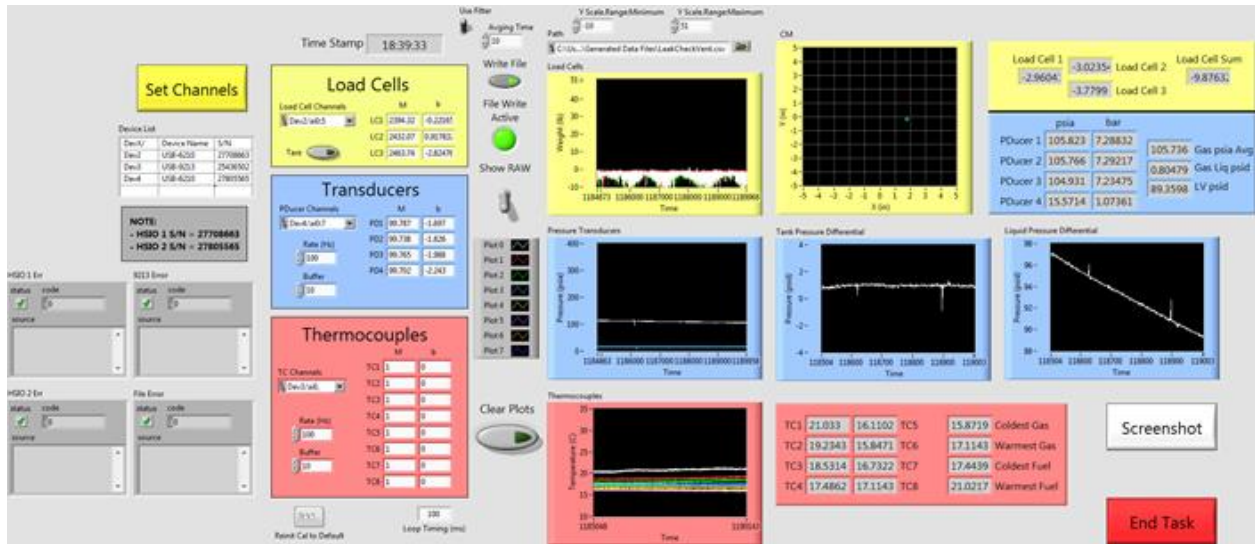

**Figure 10: GPLD Operation Virtual Instrument**

Data was captured by the DIAB during each of the major GPLD operations: leak checks, propellant loading, pressurization, expulsion, and the final vent. The data recorded was valuable despite receiving noisy load cell information. A slow sine curve was present in the collected load cell data as pictured in Figure 11. The noise was significantly reduced through the use of a moving average filter in post processing. This noise was a result of the small load cell output, on the order of 10 mV maximum, which was read by the NI-6212 running off unsteady 5V USB power provided over a long cable. In the future, both an RLC hardware filter and a more accurate, wall-powered NI voltmeter module would be used to reduce noise.

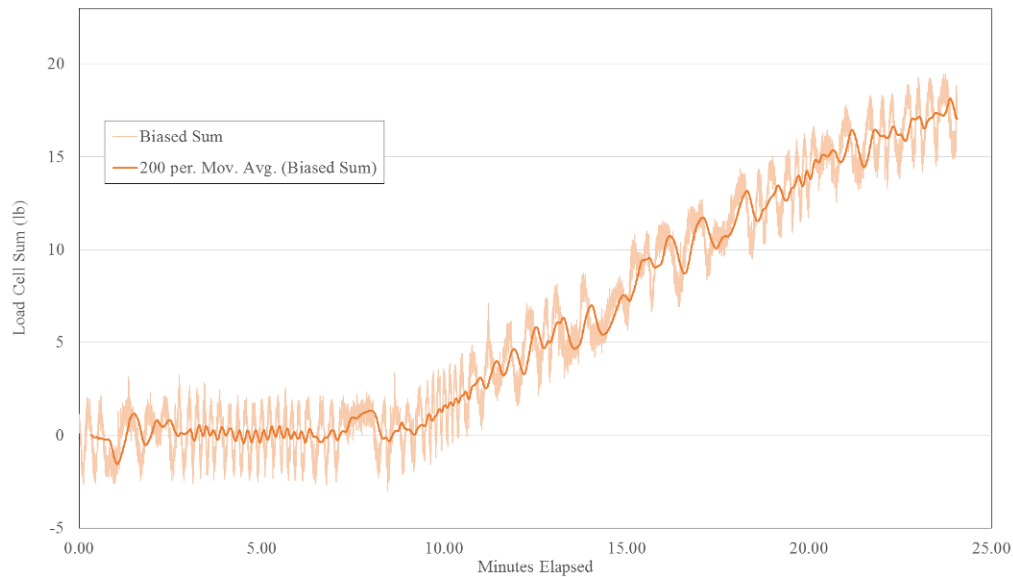

**Figure 11: Load Cell Sum – FDT Propellant Load**

#### D. Rehearsal

Two GPLD water loads rehearsals were conducted, with WFF Range Safety traveling to GSFC to participate in the second. The purpose of this activity was to demonstrate the GPLD loading procedure using a simulated FDT and the associated wetted GPLE. This team training exercise was based on the GPLD loading procedure. Using the GPLD loading procedure as the starting point, the most salient points were chosen and applied to work out potentially intricate concepts and methodologies. The water loading equipment was simplified to focus mainly on

the TC open container, TT liquid simulant loading and FDT loading operations using the GPLE TT. The FDT was simulated using a stainless steel container and likewise the TC used was a plastic container similar to the propellant shipping container. The mass of water loaded into the simulated FDT matched the FDT LMP-103S propellant load. The ECAPS provided FC was not available to use for the water loading operations. So a standard pressure panel and vacuum system equipment, historical to GSFC propulsion, were used. These two pieces of equipment provided the necessary functionality for rehearsal; however, it is best practice to prepare and rehearse with the intended propellant loading equipment when possible. All simulated waste, decontamination cleaning, and rinsate was collected in the CC, as identical for the GPLD operation at WFF.

After the first rehearsal was completed the team de-briefed, documenting the items requiring attention and noting the procedural aspects that worked well. The same operational evaluation process was repeated after the second rehearsal. The water loading rehearsals and lessons learned were directly incorporated into the final GPLD loading procedure. Rehearsals such as these are standard operation for NASA GSFC propulsion loading operations. The same GSFC propulsion personnel performed the water load rehearsals and the GPLD to bolster team cohesion.

## E. Operations

The GPLD activity at WFF was conducted over the course of eight days, divided into a three-day and five-day work session. Outlined in Table 1, Days 1-3 constitute the first work session, and Days 4-8 the second. The first work session included the GPLD Test Readiness Review (TRR), final GPLE pack up at GSFC and equipment transport to the WFF W-65 facility, travel to WFF, GPLE un-packing and staging, FDT installation into the turnover dolly, instrument buildup and end-to-end testing, and the GPLE finalized staging. The second work period began the propellant loading operation week. A WFF Range Safety briefing was conducted on the first day, directly followed by the FC un-packing, receiving and inspection, and leak testing. GSFC propulsion personnel performed a FC training exercise to establish familiarity with its function. This activity was required by WFF PVS and demonstrated the FC technician’s ability to pressurize the high and low pressure sections of the FC using the regulators and valves, operate the vacuum system and vent the gas. The remaining days were dedicated to GPLE final build up, high and low pressure integrity testing, TT propellant load operation, FDT MOP pressurization, FDT expulsion, decontamination, breakdown, and staging for transport back to GSFC.

**Table 1: GPLD Outline - Daily Operation**

Day 1 – Monday	Day 2 - Tuesday		Day 3 – Wednesday	
<ul style="list-style-type: none"> <li>• GPLD – TRR</li> <li>• Final pack up for to GPLE transport to WFF</li> </ul>	<ul style="list-style-type: none"> <li>• GPLD personnel travel to WFF</li> <li>• GPLE pickup and transport to WFF W-65 Bay 2 Facility</li> <li>• GPLD GSE Staging/Unpacking</li> <li>• FDT installation into turnover dolly</li> </ul>		<ul style="list-style-type: none"> <li>• Instrumentation buildup and checkout at WFF</li> <li>• Instrumentation end-to-end at WFF</li> <li>• Finalize W-65 Staging for GPLD operations</li> <li>• GPLD personnel return to GSFC</li> </ul>	
Day 4 – Monday	Day 5 - Tuesday	Day 6 – Wednesday	Day 7 – Thursday	Day 8 – Friday
<ul style="list-style-type: none"> <li>• WFF Safety Briefing</li> <li>• Fuel Cart Un-Packing</li> <li>• Fuel Cart Receiving and Inspection</li> <li>• Fuel Cart Leak Test</li> </ul>	<ul style="list-style-type: none"> <li>• FC Training Procedure</li> <li>• GPLE Final Build up</li> <li>• GPLE Dew Point Measurement</li> <li>• GPLE High Pressure Integrity Test</li> </ul>	<ul style="list-style-type: none"> <li>• GPLE Low Pressure Integrity Test</li> <li>• Pump propellant into TT</li> <li>• Pressurize TT and push propellant into FDT</li> <li>• Purge back fill line</li> </ul>	<ul style="list-style-type: none"> <li>• Pressurize FDT</li> <li>• Perform FDT Expulsion</li> <li>• Purge GPLE System</li> </ul>	<ul style="list-style-type: none"> <li>• Pop Back FDT Diaphragm</li> <li>• TT Decontamination</li> <li>• FDT Decontamination</li> <li>• Purge GPLE system</li> <li>• Breakdown and stage for transport to GSFC</li> </ul>

### 1. Loading and Expulsion

The GPLE operation to conduct the LMP-103S propellant transfer into the FDT and subsequent expulsion into the CC consisted of several items. As described earlier in section III B and depicted schematically in Figure 12, this equipment facilitated the GPLD operation. The pre-work performed in the first work session confirmed equipment had arrived from shipment and additionally that the facility provided the functionality to meet operational needs. This effort ultimately staged the W-65 Bay 2 facility for the GPLD. During this period, the turnover dolly was situated on the FDT digital scale, then after a FDT post shipment inspection, it was mounted into the turnover dolly. The FDT gas and propellant side valve manifolds were built up and cleaned as assemblies at GSFC prior to shipment. The manifolds were un-bagged and the gas and propellant manifolds were connected. The FDT load cell, pressure and temperature instrumentation sensors were positioned and harnessing was connected to the DIAB. The VI and data collection was then verified through an end-to-end checkout. The EPV-1 latch valve fire box commanding (open and closing) was also performed during the final checkout.

As part of the FC training procedure, a high pressure gaseous helium (GHe) k-bottle was connected to the FC pressure inlet and leak testing was performed at 550 psig (37.9 bar). Flex lines were then connected to the high and low pressure FC outlets and the vacuum vent inlet/outlet. The FC high pressure permitted a GHe flow path to both the FDT pressurant and propellant compartments. The FC low pressure and vacuum vent flex line were manifolded and connected directly to the TT. Flex lines were laid out and positioned close to their respective FDT inlets FVV, BB-1 and FDV. To verify the GPLE pressure connections dryness, a dew point measurement was taken at the end of each flex line, as well as through the TT. This is standard practice for propulsion system integration pressure testing and hydrazine loading operations, and through historical practice, was carried into the GPLD loading procedure. LMP-103S consists of 14% water and as such, lacks water sensitivities as with hydrazine propellant. After dryness verification through dew point, the final FC to FDT flex lines were joined. The FDT outlet to CC flex line was attached and additionally, the propellant vapor vent flex line attached and routed to the outside. All GHe and propellant vapors were exhausted to the local atmosphere directly outside Bay 2.

After the GPLE was set-up, properly configured as illustrated in Figure 12, and all fitting connections tightened, pressure integrity testing was performed prior to conducting propellant loading, FDT pressurization, and expulsion. This three step test certified the GPLE for use. The first part was a pressure decay test at 350 psia (24.1 bar) of the GPLE connections up to FVV and FDV. The second part was a FDT MOP pressure decay test, specifically testing the open EPV-1 latch valve configuration PTFE ferrule and lock-wire connections at 350 psia (24.1 bar). Due to the requisite FDT diaphragm pressure differential limit, the FDT pressurant and propellant volumes were pressurized concurrently. Once the decay test time was complete, the EPV-1 latching valve was commanded closed, the downstream pressure vented using EPV-2 and the pressure decay test was repeated. Initially, the EPV-1 latch valve was open to test PTFE ferrule and lock wire connections and additionally the flex line connecting the FDT propellant outlet to the CC. Once this section was vented, the EPV-1 valve was tested to verify it could internally hold the 350 psia (24.1 bar) propellant pressure load before commanding open and expelling into the CC. The final pressure decay test was at low pressure, 21.8 psia (1.5 bar), from FC low pressure outlet through the TT up to the FDV. The GPLE environmental pressure gauges and FDT instrumentation was monitored and data collected during these integrity operations.

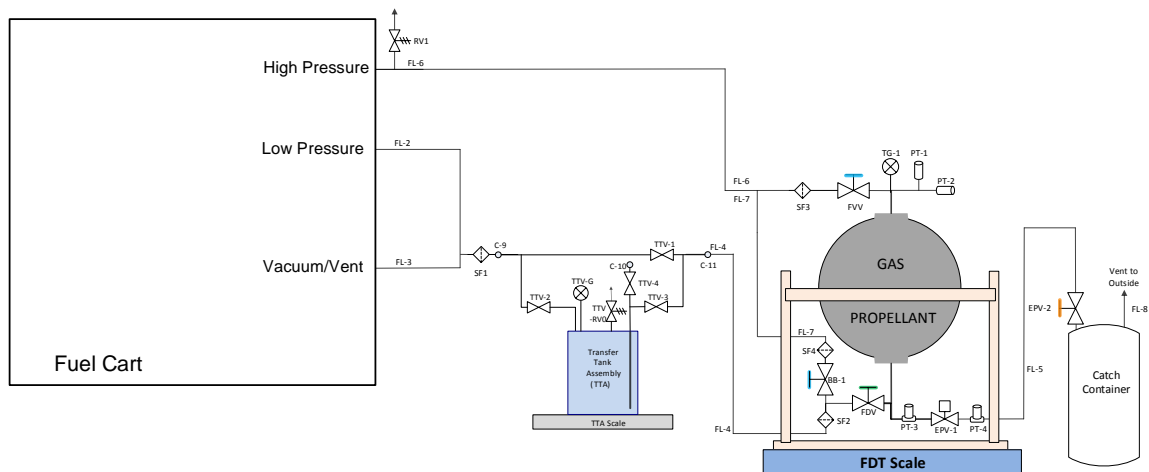

**Figure 12: GPLD Load Schematic**

The next process was to load the TT with propellant as depicted in Figure 13. This 18.1 lb (8.2 kg) TT load involved two LMP-103S open container operations. Just prior, two LMP-103S TCs were unboxed and moved from storage into the W-65 Bay 2 facility. The first LMP-103S full propellant TC was placed directly next to a clean, empty and identical TC, as pictured in figure 6b, containing a dip tube and filter cap assembly. Using previously rehearsed coordination, the full propellant TC was opened, cap removed and then dip tube and filter cap assembly from the empty TC container, positioned into the full propellant TC, and secured. The propellant TC was open roughly 10 seconds and no propellant vapor was detected using an ammonia gas detector. The propellant pump outlet was placed in a 2.64 gal (10 L) waste container and the pump tubing primed. A small amount of LMP-103S propellant was expelled into the waste container. Directly following the pump tubing propellant priming, the pump transfer tubing was connected to the TT propellant fill inlet. The peristaltic pump was then started, beginning the propellant flow from the full propellant TC to the TT. A small leak was observed at the TT propellant inlet

connection and the transfer was stopped. DI water wetted wipes were used to clean up the propellant. Once complete, the wipes were placed in a solid waste bucket. The cleanup took approximately 5 minutes. The leak path was corrected and the propellant transfer operation proceeded with no concern from Range Safety. The first pumping operation transferred 13.2 lb (6.0 kg) of LMP-103S into the TT. The propellant transfer pump tubing was then emptied by reversing the pumping direction in order to push the residual propellant back into its TC. The pump back process required only the small volume propellant removal remaining in the tube; however, the pump was operated longer than necessary and the eventual airflow into the TC stirred the propellant causing vapor to exhaust through the filter in the TC cap. This vapor detection was instantaneous and dissipated rapidly throughout the large 46,410 ft<sup>3</sup> (1,314 m<sup>3</sup>) Bay 2 facility. Upon vapor detection, the pump was immediately stopped and a brief discussion was held between the GPLD operators and Range safety. A TC cap filter inlet/outlet exhaust line was installed in order to move any stirred up propellant vapors away from personnel to vent to the outside atmosphere. This variance took roughly 10 minutes to discuss, write the procedural redlines and install the exhaust line. The second propellant transfer operation proceeded with no concern from Range Safety.

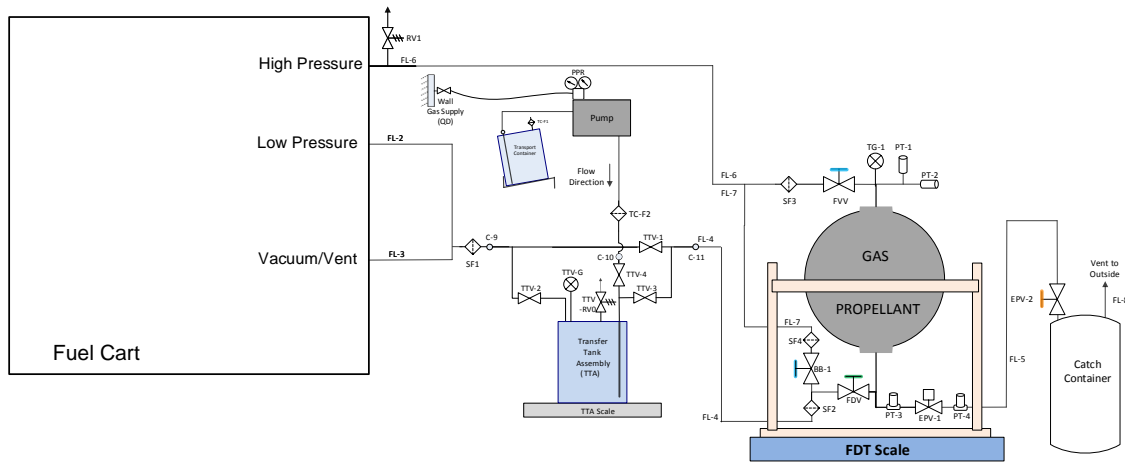
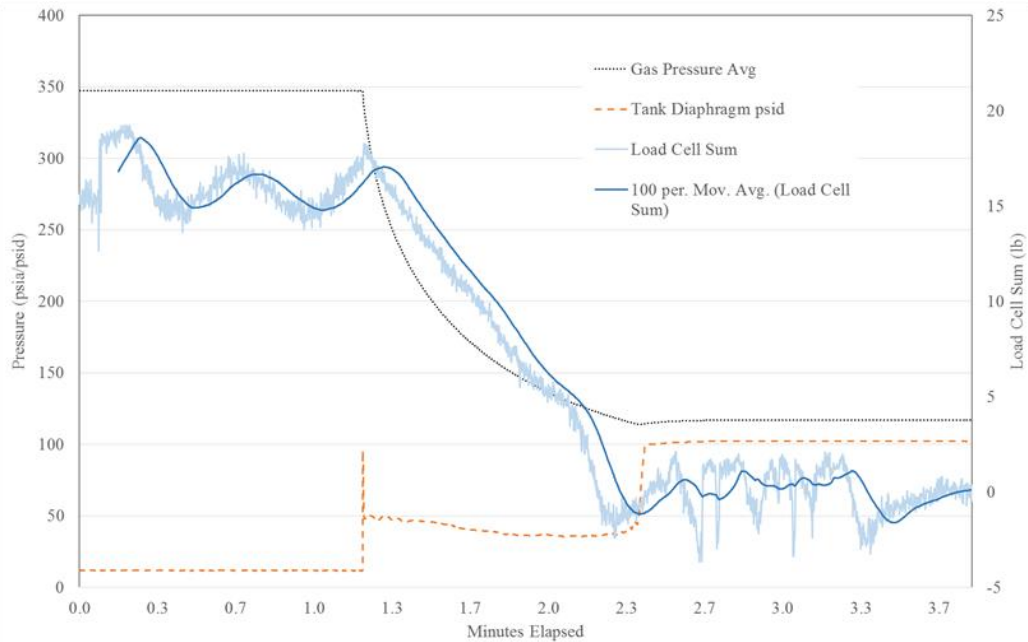

**Figure 13: Transfer Tank (TT) Loading**

Using the same method as before, the dip tube and filter cap assembly was connected to the second LMP-103S full propellant TC. The propellant pump tubing was primed and then connected to the TT propellant fill inlet. The peristaltic pump was then started, beginning the propellant flow from the propellant full TC to the TT. The second pumping operation transferred 4.9 lb (2.2 kg) of LMP-103S into the TT. The propellant transfer pump tubing was then emptied by reversing the pumping direction in order to push the residual propellant back into its TC. No propellant vapor was detected during the second pump back operation. The TC cap removal and replacement was performed a final time to place the dip tube and filter cap assembly into an Isopropyl Alcohol (IPA) / De-Ionized (DI) water cleaning mixture. The cleaning solution was pumped through the pump transfer tubing into the waste container for decontamination. The fully drained and partially drained LMP-103S propellant TCs were removed from the area and placed back in storage. The propellant transfer GPLE was disassembled, removed from the work area and stored.

The FDT and GPLE supply lines were evacuated directly ahead of propellant loading. The FDT was evacuated in both pressurant and propellant volumes. The mass of LMP-103S propellant loaded into the FDT was 17.2 lb (7.80 kg). The FC low pressure circuit was utilized to pressure-feed and move propellant from a TT into the FDT. The propellant flow rate was maintained at  $\leq 1.1$  lb/min (0.5 kg/min) for the gross filling and  $\leq 0.44$  lb/min (0.2 kg/min) for the fine filling rate closing in on the nominal target mass. The mass flow rate was tracked by monitoring mass decrease via the TTA scale digital display and time via stopwatch. This operation was straight forward, accomplished without issues, and transferred the accurate propellant mass to within tolerance. Using the FC vacuum circuit to bring the TT below atmosphere, the propellant was purged back away from the FDV valve. The FDT tank pressurant volume was then pressurized to MOP 350 psia (24.1 bar) and FVV isolated from the FC. A short hold period was conducted for temperature stabilization to see if the FDT MOP would fall below the nominal range. FDT pressurant top off was not required and the final pre-expulsion safety and instrument checkout was performed verifying all gauges and measurements were nominal. The FDT was now loaded 17.2 lb (7.80 kg) of LMP-103S, pressurized to 350 psia (24.1 bar) and instrumentation fully configured for the expulsion efficiency test. The EPV-2 valve was opened partially and the VI measurement data recording started.

The expulsion efficiency test was conducted by commanding the EPV-1 latch valve to the open position. Immediately, propellant began to flow out of the FDT and into the CC. The FDT scale and the load cells were used to establish the expulsion efficiency, both indicating ~ 99.9 % positive expulsion. The germane FDT expulsion measurement data is shown in Figure 14, below. As stated earlier in the instrumentation section, the load cell signal was extremely noisy, however the overall load cell method trended correctly with the pressure blow-down. Also of note is the FDT diaphragm pressure differential over the expulsion test.



**Figure 14: FDT Expulsion**

After the successful expulsion operation was performed, the FDT pressurant volume was at ~ 120 psia (8.3 bar). The FDT residual GHe was vented through the gas manifold FVV valve into the BB-1 valve and exhausted through the FDT propellant valve manifold, then through the EPV-2 into the CC and out the vent line to the atmosphere. During the course of the FDT vent operation, the dry GHe gas evaporated the LMP-103S propellant solvents leaving behind ADN crystals. This detail led to a slightly more complex decontamination effort than originally planned. The EPV-2 metering valve flow area was clogged and removal of this valve became necessary. It was detached from the CC and flushed with water and the waste collected in the aforementioned 2.64 gal (10 L) waste container. The CC was then moved to outside the Bay 2 facility and the FDT propellant outflow flex line was re-attached to the CC. Even with the EPV-2 valve removal and restriction opened, the FDT was not fully vented, with a small residual pressure remaining. During the FDT vent down and GPLE purging steps, the propellant solvents had been removed leaving residual crystals. With this fact now apparent, the team moved into the GPLE decontamination efforts.

## 2. Decontamination Operations

System decontamination after flowing propellant is important for both personnel and equipment safety. The low toxicity LMP-103S propellant demonstrated handling benefits throughout the GPLD; however, due to the nature of the propellant being a salt solution, if handled improperly, ADN crystals will remain when the bulk fluid evaporates. To test system cleanliness, DI water was flushed through the system and a sample tested for conductivity. A conductivity measurement  $<5 \mu\text{S}/\text{cm}$  indicates that the component is clean and propellant residuals have been properly removed. The decontamination procedure was based on flushing the system with a cleaning solution (75% DI water and 25% Isopropyl Alcohol (IPA)) two to three times followed by two to three flushes of pure DI water. A DI water/IPA mixture was utilized due to the hydrophobic filtration at the TC propellant outflow tube. If different filters are used, then only pure DI water is required. Both the transfer tank and propellant tank, as well as their associated lines, would be cleaned using this method. When filled with the cleaning solution or water, the tanks would be swished around to ensure all surfaces would receive treatment. For the TT, this process involved lifting, tilting back and forth, the FDT was rocked using the turnover dolly. These rinses were all preceded by purging the

system using gas to clear bulk propellant. Further, the metal diaphragm on the FDT would be blown backward slightly to allow fluid to work itself into the liquid side of the tank. It was not fully determined at what pressure the diaphragm would pop back, or if it would break, but the risks and unknowns were deemed acceptable by both the loading team and the tank manufacturer to allow the team to clean the tank.

The procedure was initiated while already in an anomalous configuration due to the residual pressure remaining from the gas purge at the end of the expulsion operation. Steps were taken to examine several key valves in the system and it was noticed that crystals had formed at several points. These crystals were choking the flow and causing the aforementioned behavior. A simple water rinse was sufficient to clear the crystals. Through further investigation it was discovered that crystals had also formed on the valves at the gas port of the tank. It was clear that extra steps and deviations would need to be taken to work around the unexpected buildup throughout the system. After the first set of blockages were cleared, the diaphragm was popped backward. Diaphragm movement occurred at a much lower pressure than anticipated and it would appear from the data below that the diaphragm potentially ruptured during this operation, as indicated by the equalization of transducers PT-1 and PT-3 after the initial event as shown in Figure 15 below.

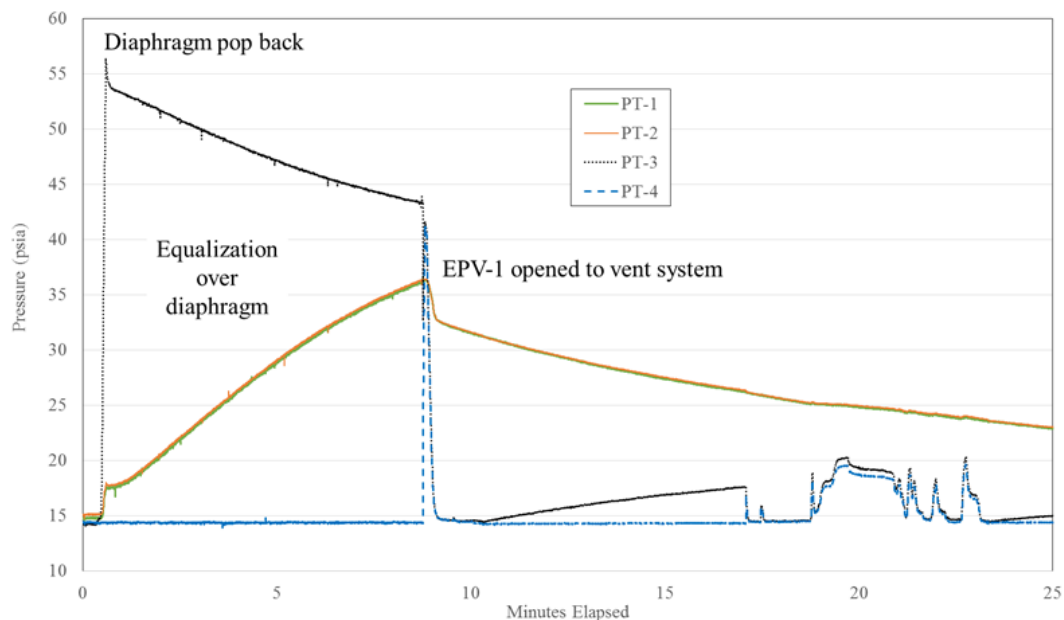

**Figure 15: FDT Diaphragm Pop Back**

After crystals were found in the gaseous and high pressure section it clearly became necessary to flush DI water through every part of the system. A plan was written in short order with input from the GSFC Loading Team, GSFC Safety, WFF Safety, and ECAPS which encompassed breaking configuration several times and utilizing the rotating nature of the tank dolly to invert the tank and pump cleaning solution and DI water into the gas portion. The first sample in nearly every section tested was orders of magnitude too contaminated to be considered clean, but within a few rinses each section was cleared of propellant or ADN residue. With other more hazardous propellants this operational deviation would have taken several hours to formulate, approve, and execute. Extra time would also be necessary for mandatory shift switches, maximum day lengths, and any incidentals that might arise during the operation. In contrast, the GPLD decontamination operation was completed within 8 hours including the system cleaning, break down, and storage for transport back to GSFC.

The crystal formation itself was determined to be a result of the lengthy (~15-20 minutes) FDT vent down and gas purges run at the end of tank expulsion and the initial steps of the decontamination procedure. Having recently come off a hydrazine loading operation, and also due to standard practices with other fluids, the team was conditioned to performing gas purges after flows to ensure bulk liquid was pushed toward waste processing containers. With LMP-103S propellant, however, this serves to accelerate evaporation process forming crystals that choke the outlet of small valve sections. Had the team initially flushed with DI water and followed that with a gaseous purge it is highly likely that this situation would not have occurred. Despite the relative ease of cleanup, it is highly advised that a liquid cleaning agent be used immediately after flowing propellant to prevent ADN salt residue buildup.

#### IV. Range Safety

As part of the demonstration work, GSFC and WFF documented Range safety analyses and practices including all elements of shipping, storage, handling, operations, decontamination, and disposal. LMP-103S has not been previously handled at a U.S. Launch Range and requisite for this activity was a GPLD Risk Analysis Report (RAR), and the Ground Safety Plan (GSP). GSFC and WFF Safety offices jointly developed the safety documentation for application into the operation. The analyses defined the required PPE, handling facility, propellant monitors and controls, as well as the safety support personnel required during loading.

The GPLD required personnel are outlined in Table 2 and was divided into three operational categories. Nominal operations included the pressure integrity testing and propellant loading into the FDT using a leak tested closed system. Critical operations comprised the TC open container operations and in the event of a large spill response, designated the personnel required. The pressurization operations included the FDT MOP pressurization and FDT expulsion. These operational groupings, agreed to in procedures and the GSP, were relaxed as the GPLD operational week proceeded and Range safety developed greater comfort for both the LMP-103S propellant and the GPLD operation. The Range safety GPLD program manager allowed ECAPS and Moog Inc. personnel into Bay 2 facility for the FDT expulsion and subsequent decontamination, for example.

The GPLD operation demonstrated that Self Contained Atmospheric Protective Ensemble (SCAPE) was unnecessary and not required by Range Safety to process the LMP-103S propellant. In addition, a dedicated control room separating the procedural instructor and propellant loading operators was extraneous and not utilized. After monitoring insignificant ammonia concentration well below the operator 8 hour exposure limit during the first TC open container operation, the use of filter cartridge respiratory protection was ruled dispensable by Range Safety. During the second TC LMP-103S open container operation, all decontamination, and GPLE connection disassembly was performed without respiratory protection, while still employing ammonia vapor monitoring.

**Table 2: GPLD Operations Required Personnel**

Organization	Critical / Essential Personnel	Operation	Job Responsibility
NASA-GSFC	GPLD Operations Coordinator (LOC)	<u>Nominal</u> <u>Critical</u> <u>Pressurization</u>	Lead Propulsion Engineer running the procedure and directing the overall operation.
	Instrumentation Operator (DAQ)	<u>Nominal</u> <u>Pressurization</u>	Propulsion Engineer primarily responsible for monitoring and recording through LabVIEW FDT temperatures, pressures and load cell output on the DIAB. Also in charge of Latching Isolation Valve (EPV-1) actuation
	Fueling Cart (FC) Operator (TECH-1)	<u>Nominal</u> <u>Pressurization</u>	Propulsion Technician primarily responsible for operating the FC.
	Transfer Tank / Peristaltic Pump Operator (TECH-2)	<u>Nominal</u> <u>Critical</u> <u>Pressurization</u>	Propulsion Technician primarily responsible for operating the TTA and FDT valves, and peristaltic pump operator for propellant transfer. Also, on stand-by to fill in and help out as necessary if required
	GSFC Safety Representative (Safety)	<u>Nominal</u> <u>Pressurization</u>	Monitors the operation to ensure safety of the personnel and the hardware.
NASA -WFF	WFF Safety (OSS)	<u>Nominal</u> <u>Critical</u> <u>Pressurization</u>	NASA WFF safety specialist who will monitor the GPLD operation to ensure the safety of the facility.
ECAPS	ECAPS Personnel	<u>Nominal</u>	LMP-103S Handling and Fueling Specialist
	ECAPS Personnel	<u>Nominal</u>	
Moog Inc.	Moog FDT subject matter expert	<u>Nominal</u>	Moog personnel Flight Development Tank (FDT) expert

##### A. Risk Analysis Report and Ground Safety Plan

The RAR prepared by GSFC and WFF Range safety captured technical information required for GPLD system safety verification and certification. This document identified GPLD associated risks, comparing the risk potential versus control techniques to evaluate the feasibility of safely conducting this demonstration. The risk analysis was performed in accordance with WFF Range safety process guideline 800-PG-8715.5.1<sup>15</sup>. The RAR investigated all aspects of the loading equipment, procedures, and operational methods. Risks associated with the FDT, GPLE,

inadvertent release of propellant from either, explosives, high pressure, and chemical systems were the major safety topics evaluated. From these areas, specific safety engineering analyses were performed, including the propellant tank danger area based on tank MEOP, propellant vapor composition analysis, anticipated propellant vapor exposure for open container operations, anticipated exposure for catastrophic release, exclusion zones, control area definition, and an electrical hardware overview.

The identified risks were categorized into the handling of the LMP-103S propellant and explosive material, propellant spills or leaks during the operation leading to personnel exposure or propellant volatile evaporation, flammability concerns due to the LMP-103S methanol and ammonia constituents, and FDT catastrophic failure. The probability and severity of occurrence was evaluated and Range Safety controls were established and documented in the GSP in order to make the Range operation permissible. Since this was the foundational Range handling operation, a conservative safety approach was taken in the risk evaluation and control.

Based on the RAR, the GSP outlined the GPLD operator and Range safety responsibilities in the implementation of the loading operation. The GPLD test director, WFF program manager, and Range safety specialist shared accountabilities for safe GPLD performance. The GSP outlined the GPLD operator training requirements, which required each to have 1) Explosive Handler Certification, 2) Pressure Operator Certification, 3) Respirator Certification and 4) the completion of the 1-day, LMP-103S safety briefing. The chemical systems were described and emergency, first-aid and firefighting procedures for LMP-103S propellant were acknowledged.

For this operation, the LMP-103S flashpoint temperature was unknown and, without this information, the propellant vapor was considered flammable due to the methanol and ammonia concentration. LMP-103S flammability experiments have been performed at Eurenco Bofors in Sweden, and by the Finnish Defence Research Agency as part of the LMP-103S propellant European Conformity (CE) certification. In each of these tests, it was shown that it was not possible to ignite pure LMP-103S. However, the industry standard test method for closed cup flash point determination, had not been performed and, as such, the propellant vapor was designated flammable for this exercise.

In order to determine the potential for a flammable vapor condition to exist, a RAR assessment was completed based on the LMP-103S methanol's constituent. Methanol was also chosen for evaluation due to its lower explosive limit as opposed to ammonia. Based on the propellant liquid operational usage in the closed and pressurized system, the area surrounding the test setup was designated a Class I Division II environment, defined as an area where ignitable concentrations of flammable gas, vapor, or liquid are not likely to exist under normal operating conditions, but may accidentally exist. The control area was based on each potential leak source and from each, the appropriate exclusion zone defined. Although not an explosive material such as LMP-103S, IPA is a flammable liquid with roughly the same flashpoint temperature of methanol and additionally, IPA exhibits a lower explosive limit. During the GPLD propellant decontamination, 2.5 gal (9.5 L) of pure IPA was mixed with DI water to prepare the cleaning fluid. The IPA flammability risk was not controlled as rigorously as LMP-103S, representing an interesting dichotomy between the utility of commonly used chemicals with known flammability risks and the risks of a less familiar potentially flammable material.

There were initial concerns regarding the use of electronics in the loading hall due to the potential for a flammable atmosphere. Limited types of electrical equipment may be utilized in a Class I Division II environment. Each piece of electrical equipment proposed for use in the control area was evaluated by GSFC and WFF safety to certify that the device was properly rated for use. Some devices were properly rated, or intrinsically safe, for use in the control area, while others were evaluated to demonstrate insufficient energy to act as an ignition source. A few were situational use, meaning the device contained sufficient energy to act as an ignition source. In the operation of each case the environment was verified as non-flammable using a propellant vapor detection monitor before operation.

Propellant vapor dispersion calculations, power density calculations, and the use of proper equipment placement combined to satisfy all involved parties and allow the use of the electrical devices, power supplies, and DAQ system during operations as opposed to enforcing a full explosion-proof system. The methanol dispersion calculations indicated that outside of a prescribed radius the vast majority of methanol would sit no higher than three feet above the ground. This dispersion calculation assumed 2.64 gal (10 L) of LMP-103S was released and the methanol was released at a rate of 46.3 grams/min. It is important to note that for GPLD, at any one time, the most propellant in the system was 1.75 gal (6.7 L). In order to release the full 2.64 gal (10 L), multiple failures and personnel mishandlings would need to have occurred simultaneously. By placing all electronics and power supplies on a table higher than three feet, this condition was met. The load cells and pressure transducers power consumption was low enough, and the devices far enough away from each other and the greatest flammable atmosphere potential, the TT, that power density calculations showed no reasonable risk of igniting the methanol vapor.



To protect GPLD personnel from the ammonia and methanol propellant vapor, two types of respirators were designated - Powered Air Purifying Respirators (PAPR) and supplied air. At no point in the GPLD operation was supplied air used and was only planned for in the event of a catastrophic anomaly involving the full release of propellant. For this risk assessment, the basis was that the full 2.64 gal (10 L) of LMP-103S was assumed released and the methanol and ammonia immediately came out of solution. Without propellant vapor composition analysis data, the worst case approach was applied to the GPLD operation. The respiratory protection approach was created by both GSFC and WFF safety and agreed upon by the GSFC industrial health group. During operations, personnel monitored the actual ammonia concentrations using ammonia gas detectors. This, in concert with the RAR propellant vapor exposure analysis, produced a situational respirator protection protocol. For nominal operations the propellant was fully enclosed in the system with no leaks or release of propellant and no respiratory protection was required. During the first open container operation, PAPR protection was worn and the ammonia concentration level was monitored. Since it was observed that the ammonia concentration was consistently below the defined ammonia concentration action point, personnel were allowed to forgo the use of respirator protection. This was contingent on continued monitoring to determine if respiratory protection would resume. The respirator protection plan defined ammonia concentration action points for the opening of wetted lines and leaks. At the point in the procedure necessary to open potentially wetted lines, Range safety deemed it permissible to only monitor the ammonia concentrations and to evaluate the respirator protection needs based on measurement data.

## B. Personnel Protective Equipment

GPLD personnel were required to wear chemical resistant gloves, splash resistant clean room suits, and safety glasses as shown in Figure 16. The gloves were made from a polychloroprene material and the clean room suits were chosen to meet the GSFC cleanroom certifications for future LMP-103S loading efforts. ESD (Electric Static Discharge) wrist straps were required during the open container operations and, additionally, any time a connection was opened where undiluted, residual propellant was expected. LMP-103S is not ESD sensitive, however due to its explosive characteristics, the WFF Range explosive safety officer required GPLD personnel to wear ESD protection as an explosive handling best practice. Proper respiratory protection was required for the TC open container operation, but as mentioned and pictured in Figure 16a, respirators were not required for the second TC open container operation. Figure 16b shows the GPLD team in process of FDT loading. For decontamination, only lab coats, gloves, and safety glasses were required.



Figure 16: a) TC Open Container Operation

b) GPLD personnel loading the FDT

## V. GPLD Cost Comparison

Table 3 presents a resource comparison between spacecraft processing hydrazine and LMP-103S propellant. In order to detail quantitative savings and the benefits related to handling LMP-103S, items associated with propellant loading were investigated, specific to the methods employed by GSFC in loading GPM and MMS. The labor and other direct costs are normalized with the hydrazine effort set to a value of “1” as the known reference, and the LMP-103S processing shown as either a percent reduction or increase. The known reference magnitude is not offered in the table and varies substantially depending on the item. A draft hydrazine and HPGP loading and decontamination schedule was created, taking into consideration the previous GSFC hydrazine loadings and the GPLD operation. For hydrazine, the four hour SCAPE operator limit, personnel and required shift changeover,

control room operational personnel, and fire watch shifts were considered and built into the schedule. In addition, after a hydrazine load two propulsion personnel are at the launch site, continuously, from load to launch representing the marching army. A moderate two week period was considered for this comparison, but could be less or even greater depending on the specific mission, encapsulation, and launch slips, etc. A propellant sampling operation was assumed for each, as this is a GSFC spacecraft propellant loading requirement. LMP-103S propellant sampling is a topic area in the European Space Agency (ESA) LMP-103S monopropellant space qualification<sup>16</sup>. Since the sampling method is not finalized, a conservative value was estimated for LMP-103S propellant sampling due to the unknowns. However, the sampling was assumed to be greater for a hydrazine.

A final decontamination schedule was prepared for the hydrazine comparison, as this operation for both GPM and MMS, was performed after loading when the spacecraft had been moved out from the loading facility. The HPGP FC and GPLE decontamination operation was included into the loading week schedule effort; essentially the last day of the operation. For both the GPM and MMS loading operation, multiple hypergol trainings were required and these costs were carried forward into this assessment. GSFC propulsion has a hydrazine loading cart and available equipment for use in a hypergol loading. For a LMP-103S loading effort, a loading cart similar to the ECAPS FC would need to be manufactured. GSFC propulsion has the necessary functions in multiple pieces of equipment, however, for simplicity combining all loading functions into one single piece of equipment is greatly beneficial. One of the major potential sources of LMP-103S process savings is from the reduction in propellant handling facilities. For GPLD, the operation was conducted in an explosive rated high-bay. All propellant vapor was vented directly to the atmosphere, not into a scrubber as with hydrazine processing. The W-65 Bay 2 facility also contained no air exchange or turnover functions. These items, and the potential further reductions, could prove even more substantial, representing greater savings. This assessment covers the propulsion loading effort only and not the propellant cost or any additional HPGP propulsion system drivers. In all, GPLD proved a ~ 72% resource reduction in contrast to an equivalent hydrazine loading effort. The GPLD quantitative comparison information compares quite favorably with the reductions realized in the PRISMA loading campaign.

**Table 3: Hydrazine versus HPGP Processing – Quantitative Comparison**

	Hydrazine		HPGP (LMP-103S)		Basis of Estimate
	Labor Cost	Cost	Labor Cost	Cost	
<b>Loading</b>	1	---	0.701	---	Based on DRAFT Schedule – GPM – MMS – GPLD
<b>Decontamination</b>	1	---	<b>Included in Load Hours</b>		Based on DRAFT Schedule – GPM – MMS – GPLD
<b>Fire Watch</b>	1	---	<b>Not Required</b>		Based on DRAFT Schedule – GPM – MMS – GPLD
<b>Marching Army</b>	1	---	<b>Not Required</b>		Assuming 2 weeks – Propellant Load to Launch
<b>Physicals</b>	1	---	0.125	---	SCAPE Comprehensive Physical vs Ordnance Handler
<b>Training</b>	1	1	0.125	---	WSTF TES, KSC SCAPE, Hypergol systems
<b>Sampling</b>		1		0.5	SCAPE – KSC
<b>Drain Container Processing</b>		1		0.3	KSC – GPM – MMS – GPLD
<b>SCAPE Rental and Support (PPE)</b>		1		0.15	Based on DRAFT Schedule – GPM – MMS – GPLD HPGP – SCAPE not required
<b>Load Cart Final Decontamination</b>		1	<b>Not Required</b>		Based on DRAFT Schedule – GPM – MMS – GPLD
<b>Procedures</b>	1		0.5		MMS – GPM – GPLD
<b>GSE</b>		1		2	GPM – MMS – Green Load Cart Build
<b>Travel</b>		1	<b>Not Required</b>		WSTF/KSC Training for SCAPE Certification
<b>Facilities</b>	TBD		TBD		Buried costs that could prove substantial
	<b>Hydrazine</b>	<b>1</b>	<b>HPGP</b>	<b>0.28</b>	~ 73% overall total cost reduction for HPGP

## **VI. Accomplishments**

GPLD was the inaugural domestic LMP-103S loading operation, demonstrating transport, storage, and handling of the propellant at a U.S. Range. The team successfully developed GPLE flight passivation and cleaning processes. Moreover, the loading and decontamination procedures approved by GSFC and WFF Safety for GPLD can be leveraged in the future. The NASA GSFC team was able to show a clear reduction in effort with HPGP versus hydrazine loading through quantitative assessment. Through the demonstration, NASA GSFC gained practical experience in LMP-103S handling. As with most loading operations, small leaks are always a possibility. With the demonstration, the GPLD team was able to perform a small propellant leak clean-up and ADN salt decontamination without major or even minor safety concerns, complications, or violations.

The GPLD was a tremendously successful collaboration of NASA, SNSB, ECAPS, and Moog, Inc. Through this effort, LMP-103S propellant has achieved a U.S. Range acceptance, as well as a Range and Pressure PVS FC equipment certification. The Moog Inc. titanium rolling diaphragm tank was tested for expulsion efficiency with propellant as opposed to a water simulant. Through this effort, the tank development effort, and AIAA-S-080 qualification process, it is now scheduled to fly on Sierra Nevada Corporation's SN-50 Nanosat. Through GPLD, WFF was the first U.S. Range to accept the propellant, developing Range analysis documents required for future missions.

## **VII. HPGP Risk Reduction and Future Efforts**

As science missions move forward with potential infusion of green propellants, a number of questions remain open which must be addressed. One of the most significant outcomes of the GPLD safety planning meetings and operation was the identification of additional LMP-103S chemical property data necessary to process LMP-103S propellant in the most effective way and deliver the greatest benefit to future missions. ESA has multiple programs in work to space qualify LMP-103S propellant. These programs are investigating propellant analysis methods, physical and chemical properties, vapor phase and gas absorption, propellant handling operations, additional safety testing, propellant production and quality assurance, and propellant toxicity. In addition, GSFC is working with WSTF to perform LMP-103S closed and open cup flashpoint and propellant vapor phase composition measurements. The current Safety Data Sheet (SDS) associated with LMP-103S was last published in 2012. Since that time, a number of additional tests and experiments have been performed to further prove the inherent safety of LMP-103S propellant. Updating the SDS to reflect the most current test data and information will aid in the potential for the relaxation of conservative safety controls.

In addition to the Range-specific analysis identified, there are a number of propulsion system performance questions. Such as how do off the shelf propulsion components perform with this novel propellant, how does the fluid behave in terms of flow rates and surge pressures, and do valves operate differently. The historical data available from the PRISMA and Terra Bella SkySat propulsion system components must be leveraged and expanded upon going forward. Additional material compatibility work must be done to increase the knowledge of propellant compatibility with a variety of off the shelf fluid system components and materials. Additional flow testing and system priming testing is planned for 2017 to further gain system flow performance data using propulsion system components and LMP-103S propellant. Thruster qualification life testing is additionally required to design and effectively utilize HPGP systems for NASA missions. HPGP total system trades have been conducted for two current early phase GSFC missions: Plankton, Aerosols, Clouds, and ocean Ecosystems (PACE) and Wide Field Infrared Survey Telescope (WFIRST). Each gains benefit from this propellant through increased performance and the handling benefits proven through GPLD. HPGP technology is being considered for these missions due to the 1-lbf (5 N) and 5-lbf (22 N) thruster maturity and the 2017 planned life testing to demonstrate the increased throughput mandatory meet these mission requirements. In upcoming years, ECAPS, ESA, and NASA are all working to perform tests that address any gaps in system performance moving LMP-103S technologies toward mission infusion.

## **VIII. Conclusions**

The institutional knowledge and practical hands-on experience gained from this pathfinder activity can be taken and directly applied to future NASA mission LMP-103S propellant flight loading scenarios. The GPLD operation demonstrated a significant reduction in effort over a hydrazine equivalent loading providing quantifiable evidence of cost and schedule savings. This evidence has been documented, communicated, and presented to both the PACE and WFIRST missions as part of the green propulsion trades, proving the GPLD operational impact. Through this work, NASA continues to advance the experience base with LMP-103S green propellant and close the gap between research and eventual flight, laying the foundation for future NASA mission infusion.

## Acknowledgments

The authors would like to thank all who participated in this collaborative achievement. For the IA, a great deal of acknowledgement is due to Dr. Olle Norberg and Christer Nilsson of SNSB, Neal Newman at NASA HQ, and Ted Mecum at NASA GSFC. From ECAPS, both Kjell Anflo and Dr. Peter Thormählen spent a week in WFF during the GPLD effort. Additionally from ECAPS, Mathias Persson and Aaron Dinardi coordinated logistics and directed multiple efforts to move things forward. The FDT tank designer Harry Conomos from Moog Inc., also spent the week at WFF for the operation. Paul King and Jeff Moore from Moog Inc. for the FDT bailment and initial discussions at JPC 2014. GSFC safety Michelle Rizzo and WFF Range safety Tom Moskios worked tirelessly to provide the appropriate safety documentation and controls for the operation. A special thanks is owed to the GSFC management Dr. Christyl Johnson, Chief Technologist Peter Hughes and Deputy Chief Technologist Deborah Amato. Some of the additional critical team members include Mike Wilks, Kyle Bentley, Khary Parker, Steve Graham, Andrew Maynard, Roman Kilgore, Frank Coleman, Gordon Marsh, Zbigniew Moore, Gerald “Jack” Vieira, Keith Thompson, Linda Thompson, Daniel Walsh, and Justin Revell.

## References

- <sup>1</sup>Cardiff, E. H., Mulkey, H. W., and Bacha, C. E., “An Analysis of Green Propulsion Applied to NASA Missions,” *Space Propulsion 2014 2966727*, Cologne, Germany, 19-22 May 2014.
- <sup>2</sup>Bacha, C. E., Johnson, C., Johnson, M. A., Robinson, J. W. and Deans, M.C., “A Systems Approach for the Transition of NASA Missions to Green Propulsion,” *Space Propulsion 2016 3125325*, Rome, Italy, 2-6 May 2016.
- <sup>3</sup>Anflo, K., “Concluding a 5 year In-Space Demonstration of an ADN-Based Propulsion System on PRISMA,” *Space Propulsion 2016 3124919*, Rome, Italy, 2-6 May 2016.
- <sup>4</sup>Mulkey, H. W., Bacha, C. E., Anflo, K., Persson, M., and Dinardi, A., “NASA and SNSB Implementing Arrangement Status,” *Green Monopropellant Alternatives to Hydrazine JANNAF / NIRPS Joint Technical Interchange Meeting*, Huntsville, Alabama, 3-4 August 2015.
- <sup>5</sup>Sampson, J. W., Martinez, J., and McLean, C., “Fracture Mechanics Testing of Titanium 6Al-4V in AF-M315E,” *AIAA-2015-3756 51<sup>st</sup> AIAA/SAE/ASEE Joint Propulsion Conference*, Orlando, Florida, 27-29 July 2015.
- <sup>6</sup>Lewis, C. J., and Kenny, J. T., “Sustained Load Crack Growth Design Data for Ti-6Al-4V Titanium Alloy Tanks Containing Hydrazine,” *AIAA-76-769 12<sup>th</sup> AIAA/SAE Joint Propulsion Conference*, Orlando, Florida, 27-29 July 2015.
- <sup>7</sup>Anflo, K., and Crowe, B., “In-Space Demonstration of an ADN-based propulsion system,” *AIAA-2011-5832 47<sup>th</sup> AIAA/SAE/ASEE Joint Propulsion Conference*, San Diego, California, 31 July-3 August 2011.
- <sup>8</sup>Johnson, C., “Environmental Life Cycle Criteria for Making Decisions about Green versus Toxic Propellant Selections,” Ph.D. Dissertation The George Washington University, Washington D.C, 2012.
- <sup>9</sup>Persson, M., “HPGP a Flight Proven Technology Selected for Multiple LEO Missions,” *Space Propulsion 2016 3124942*, Rome, Italy, 2-6 May 2016.
- <sup>10</sup>Anflo, K., Thormählen, P., Ferring, S., Friedhoff, P., Mulkey, H.W., Bacha, C. E., and Conomos, H., “High Performance Green Propulsion On the Way for Three Launches from Three Continents,” *Space Propulsion 2016 3124920*, Rome, Italy, 2-6 May 2016.
- <sup>11</sup>AIAA-S-080-1998, *Space Systems – Metallic Pressure Vessels, Pressurized Structures, and Pressure Components*, American Institute of Aeronautics and Astronautics, Reston Va, U.S.A.
- <sup>12</sup>NASA-STD-8719.12, *Safety Standard for Explosives, Propellants and Pyrotechnics*, National Aeronautics and Space Administration, Washington D.C., U.S.A.
- <sup>13</sup>Marvin, M., Kammerer, H. and Gidley, J.T., “Parametric Evaluation of Contoured Aluminum Diaphragm Positive Expulsion Tanks,” *AIAA-92-3186 28<sup>th</sup> AIAA/SAE/ASEE Joint Propulsion Conference*, Nashville, Tennessee, 6-8 July 1992.
- <sup>14</sup>Persson, M., Anflo, K., Dinardi, A. and Bahu, J.M., “A Family of Thrusters for ADN-Based Monopropellant LMP-103S,” *AIAA-2012-3815 48<sup>th</sup> AIAA/SAE/ASEE Joint Propulsion Conference*, Atlanta, Georgia, 30 July-1 August 2012.
- <sup>15</sup>800-PG-8715.5.1, *Range Safety Process for Programs and Projects*, Code 803, Wallops Flight Facility, Wallops Island, Va.
- <sup>16</sup>Thormählen, P., Lackman, T., Anflo, K., and Valencia-Bel, F. “Space Qualification of monopropellant LMP-103S,” *Space Propulsion 2016 3125343*, Rome, Italy, 2-6 May 2016.