

JPL Publication 16-4



Surface Pressure Dependencies in the GEOS-Chem-Adjoint System and the Impact of the GEOS-5 Surface Pressure on CO₂ Model Forecast

Meemong Lee and Richard Weidner

**National Aeronautics and
Space Administration**

**Jet Propulsion Laboratory
California Institute of Technology
Pasadena, California**

February 2016

This research was carried out at the Jet Propulsion Laboratory, California Institute of Technology, under a contract with the National Aeronautics and Space Administration.

Reference herein to any specific commercial product, process, or service by trade name, trademark, manufacturer, or otherwise, does not constitute or imply its endorsement by the United States Government or the Jet Propulsion Laboratory, California Institute of Technology.

© 2016 California Institute of Technology. Government sponsorship acknowledged.

Contents

I. INTRODUCTION.....	1
II. FORWARD MODEL PROCESS	3
II.1 Surface Pressure Variables.....	3
II.2 Tracer State Representation	4
II.3 Transport Model	6
III. CO₂ MODEL FORECAST AND IMPACT EVALUATION	9
III.1 Surface Pressure Impact on Dynamics Model Simulation	9
III.2 Surface Pressure Impact on Emission Model Simulation.....	14
IV CONCLUSION	18
APPENDIX-A TRANSPORT MODEL SOFTWARE.....	19
APPENDIX-B DRY AIR MASS FOR UNIT CONVERSION	23
APPENDIX-C GCA CODE MODIFICATIONS	26

Figures

Figure 1. Dry Surface Pressure Setup and the Relationship between the True Surface Pressures (PS1 and PS2) and the Interpolated Surface Pressures (PFLT and PSC2)	3
Figure 2. Tracer State (STT) Transition during Model Simulation and External Interfaces.....	5
Figure 3. Temporal Transitions of the True Surface Pressure (PS1, PS2), Interpolated Surface Pressure (PFLT & PSC2), Air Mass (AD), and the Tracer State (STT).....	6
Figure 4. Global Surface Pressure Variables and the Transport-internal Pressure Processing	7
Figure 5. Two-stage Mass Balanced Advection Template Formulation and Tracer Mass Ratio Update Process	8
Figure 6. Functional Collaboration of the GCA system, the CMS Emission Model, and the Multi-Mission Observation Operator within the GCA-M2O2 Framework	9
Figure 7 Total Air Mass during the Wet Surface Pressure Simulation (top) and during the Dry Surface Pressure Simulation (bottom) tracked 3 hourly for one year (2010).....	11
Figure 8 Conservation of the Total CO ₂ Mass (sampled 3 hourly)	11
Figure 9 Seasonal Cycle of the Global Mean CO ₂ (sampled daily)	12
Figure 10 CO ₂ Comparison of the CO ₂ Concentration between the Two Surface Pressure Cases at the Time with the Highest Global Mean Difference (2010/08/01)	13
Figure 11 Seasonal Cycle of the MACC-III Emission Inventory	15
Figure 12 Global Mean CO ₂ difference (Dry-Wet) with emission model (MACC-III) and without (370 PPM)	15
Figure 13 CO ₂ Difference (Dry-Wet) Captured on 2010/08/01 (top) and on 2011/01/01 (bottom)	16

Figure 14 Latitudinal Mean Surface CO ₂ Difference (Dry – Wet) on 2010/08/01 (Aug) and 2011/01/01 (Jan)	16
Figure 15 Total CO ₂ Mass Change and the Difference (Wet –Dry) during 2010 and 2011	17

Tables

Table 1. Impact of the Surface Pressure on Dynamics Model Simulation	10
Table 2. Impact of the Surface Pressure on Emission Model Simulation	14

Abstract

The total (wet) surface pressure of the Goddard Earth Observing System (GEOS) meteorology is employed as dry surface pressure in the GEOS-Chem Adjoint (GCA) system ignoring the presence of water vapor. The Jet Propulsion Laboratory (JPL) Carbon Monitoring System (CMS) research team has been evaluating the impact of the above discrepancy on the CO₂ model forecast and the CO₂ flux inversion. The JPL CMS research utilizes a multi-mission assimilation framework developed by the Multi-Mission Observation Operator (M2O2) research team at JPL extending the GCA system. The GCA-M2O2 framework facilitates mission-generic 3D and 4D-variational assimilations streamlining the interfaces to the satellite data products and prior emission inventories. The GCA-M2O2 framework currently integrates the GCA system version 35h and provides a dry surface pressure setup to allow the CO₂ model forecast to be performed with the GEOS-5 surface pressure directly or after converting it to dry surface pressure.

The dry surface pressure setup was implemented based on a close investigation of the surface pressure dependencies in the GCA system. The GCA system derives the air mass and the mass flux based on the surface pressure and its gradient. The air mass is used in multiple functions (including the unit conversion), and the mass flux is used in transport. The water vapor impact was evaluated by comparing the CO₂ model forecast performed with the GEOS-5 surface pressure and that performed with the dry surface pressure. The findings from the evaluation are threefold: 1) only the GEOS-5 surface pressure case shows a seasonal bias in the total air mass (2Gt) and the global CO₂ volume mixing ratio (<0.1%); 2) both pressure cases balance the total CO₂ mass; and 3) the dry surface pressure case shows higher sensitivity to the surface emission (+/-1 ppm). This report describes the surface pressure dependencies in the GCA system and the impact of the GEOS-5 surface pressure on the CO₂ model forecast.

I. Introduction

The GCA system performs forward and adjoint modeling of the atmospheric chemistry transport based on the various versions of the meteorology data products generated by the GEOS.¹ The GEOS-5 meteorology data products (generated by the version 5 of the GEOS) are organized in three temporal resolution groups, I6 group (6 hourly instantaneous), A3 group (3 hourly average), and A6 (6 hourly average). All three groups share the same spatial resolution, 0.5° x 0.625° horizontally and 72 levels vertically. The GEOS-Chem group at Harvard provides two reduced-resolution global data products (2° x 2.5° or 4° x 5°) and three native-resolution regional data products (North America, Europe, and China) for the GEOS-Chem community.

Within the GCA system, the surface pressure of the GEOS meteorology is employed as dry surface pressure, ignoring the presence of water vapor. The JPL Carbon Monitoring System (CMS) research team has been evaluating the impact of the above discrepancy on the CO₂ model forecast and the CO₂ flux inversion. The JPL CMS research utilizes a multi-mission assimilation framework developed by the

¹ See the "GEOS-Chem Adjoint" web page, in the *GEOS-Chem Wiki* website, Harvard Univ., Boston, MA. (accessed Jan. 20, 2016) http://wiki.seas.harvard.edu/geos-chem/index.php/GEOS-Chem_Adjoint

Multi-Mission Observation Operator (M2O2) research team at JPL extending the GCA system [2].² The GCA-M2O2 framework facilitates mission-generic 3D and 4D-variational assimilations streamlining the interfaces to the satellite data products and prior emission inventories.

This report describes the surface pressure dependencies in the GCA system (version 35h) and the impact of the GEOS-5 surface pressure on the CO₂ model forecast. Section II describes the conversion of the GEOS-5 surface pressure to dry surface pressure, the surface pressure dependency on the unit conversion processes during the model forecast, and the surface pressure dependency on the advection template formulation process in the transport model. Section III describes the configuration of the GCA-M2O2 framework employed in the evaluation study and presents the findings from the CO₂ model forecasts, and summarizes the impact evaluation results.

The three appendices are organized to provide relevant background materials. Appendix A investigates the PJC_PFIX and the TPCORE_FVDAS modules in formulating the advection template based on the winds and the surface pressures. Appendix B discusses the lessons learned from applying dry air mass (total air mass – water vapor mass) in the unit conversion between CO₂ mass (kg) and CO₂ volume mixing ratio (v/v). Appendix C lists the modifications made to the GCA software within the GCA-M2O2 framework including the use of mass ratio (kg/kg) for the dynamics model simulation and the conversion of the GEOS surface pressure to dry surface pressure.

² See the “GEOS-Chem Adjoint” web page, in the *GEOS-Chem Wiki* website, Harvard Univ., Boston, MA. (accessed Jan. 20, 2016) [http://wiki.seas.harvard.edu/geos-chem/index.php/Multi-mission_Observation_Operator\(M2O2\)](http://wiki.seas.harvard.edu/geos-chem/index.php/Multi-mission_Observation_Operator(M2O2))

II. Forward Model Process

The forward model process is organized with an initialization step and two temporally nested do-loops, a meteorology field do-loop and a model forecast do-loop, as shown in Figure 1. The interval of the meteorology field do loop is set to be 6 hours to align with the interval of the I6 field group of GEOS-5 and the interval of the model forecast do-loop is set to be the temporal resolution of the transport model simulation. The temporal resolution of the transport model is tightly coupled with the spatial resolution of the meteorology data in order to limit the horizontal movement to be less than one grid cell during one simulation time step. The temporal nesting facilitates tracking of two surface pressure types, the true surface pressure in the meteorology field loop and the estimated surface pressure in the model forecast loop. In this section, the surface pressure dependencies are examined in three levels: 1) surface pressure variable setting, 2) air mass derivation and tracer state representation, and 3) mass flux formulation and transport.

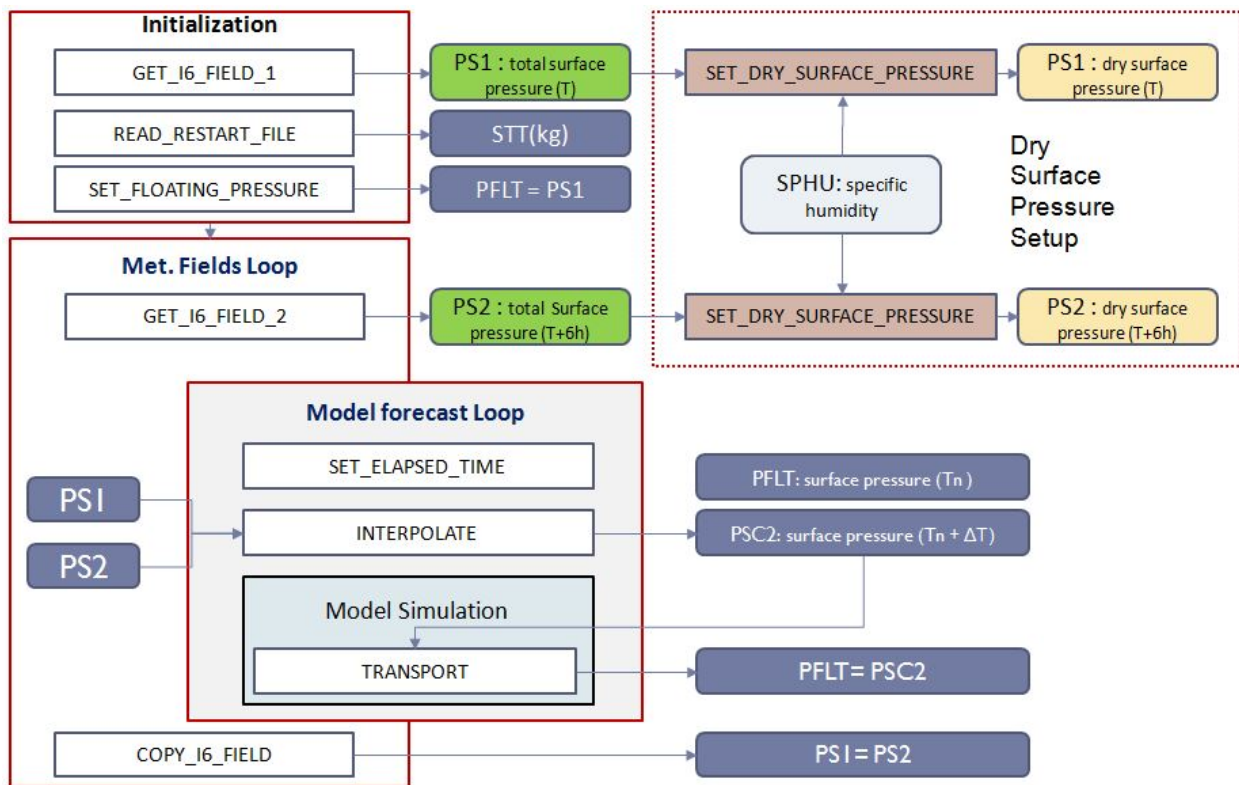

Figure 1. Dry Surface Pressure Setup and the Relationship between the True Surface Pressures (PS1 and PS2) and the Interpolated Surface Pressures (PFLT and PSC2)

II.1 Surface Pressure Variables

The Meteorology Fields do-loop manages the “true” surface pressures tracking two instances of the GEOS-5 surface pressure fields with two global variables, PS1 and PS2. As the iteration continues, the PS1 is set with the PS2 at the end of iteration and the PS2 is set with the next instance of the GEOS-5 surface pressure field. Similarly, the Model Forecast do-loop progresses the simulation time step (i) and tracks the interpolated true surface pressures fields with a global variable, PSC2. The PFLT is set with the

PSC2 at the end of iteration and the PSC2 is interpolated for the next time step. The relationship among the above four surface variables can be expressed as below.

- (1) $PS1 = PS_{true}(T)$
- (2) $PS2 = PS_{true}(T+6hr)$
- (3) $PSC2^i = PS1 + i * (PS2 - PS1)/N$
where N is the number of model simulation steps during the 6 hour interval
- (4) $PFLT^i = PSC2^i$
- (5) $PFLT^0 = PS1$

The current implementation of the GCA system assumes the true surface pressure is dry while the GEOS-5 surface pressure is wet. An approach to resolve the discrepancy is to convert the GEOS-5 surface pressure to dry surface pressure as illustrated in Figure 1 (Dry Surface Pressure Setup).

The conversion includes the following three operations: 1) compose a wet pressure profile based on the wet surface pressure; 2) compute the dry pressure thickness from the wet pressure thickness; 3) integrate the dry pressure thickness column. The above three operations can be expressed as below where Ap and Bp are the vertical profile parameters defined by the GEOS and SPHU is the specific humidity field in the GEOS-5.

- (6) $P_{wet}(L) = Ap(L) + Bp(L) \times PS_{wet}$
- (7) $\Delta P_{dry}(L) = (P_{wet}(L) - P_{wet}(L+1)) \times (1 - SPHU(L))$
where $SPHU(L) := M_{waterVapor}(L) / (M_{waterVapor}(L) + M_{dryAir}(L))$
- (8) $PS_{dry} = \sum_{L=1,47} \Delta P_{dry}(L)$

The PS1 and PS2 are used only to estimate the PFLT and the PSC2, which are employed in the model simulation. The dependencies of the model forecast on the PFLT and PSC2 are discussed with respect to the process flow of the tracer state representation during the model simulation.

II.2 Tracer State Representation

The Model Forecast do-loop tracks the tracer state with a global variable, STT, performing inter-model unit conversion, air quantity derivation, and model simulation. As shown in Figure 2, there are five model types, transport, planetary boundary layer mixing, convection, emission, and chemistry, where the first three model types assume the STT in mass ratio unit (kg/kg) while the last two model types assume the STT in mass unit (kg). The first three model types update the spatial distribution of the tracer based on the GEOS-5 meteorology fields, such as winds, planetary boundary layer height (PBLH), and cloud mass flux (CMFMC). The last two model types update the tracer mass based on the emissions and chemical reactions.

The transport model advances the current surface pressure (PFLT) and the air quantities are updated accordingly for the subsequent processes. The AIRQNT function derives the pressure thickness (ΔP) and the air mass (AD) based on the PFLT. The pressure at the bottom edge of at the level L defined to be a

function of A_p , B_p , and the surface pressure where A_p and B_p are predefined as the top pressure and the bottom sigma edge respectively.

$$(9) P_{\text{edge}}(L) = A_p(L) + B_p(L) \times \text{PFLT}$$

The vertical profile of the air mass (AD) at each grid cell is defined to be a function of the pressure thickness (the difference between the adjacent levels) and the surface area. Thus, the air mass (kg) is computed as a product of the pressure thickness (hPa) and surface area (m^2), divided by the gravity constant g (m/sec^2).

$$(10) \Delta P(L) = P_{\text{edge}}(L) - P_{\text{edge}}(L+1)$$

$$(11) \text{AD}(L) = \Delta P(L) \times \text{Area} / g$$

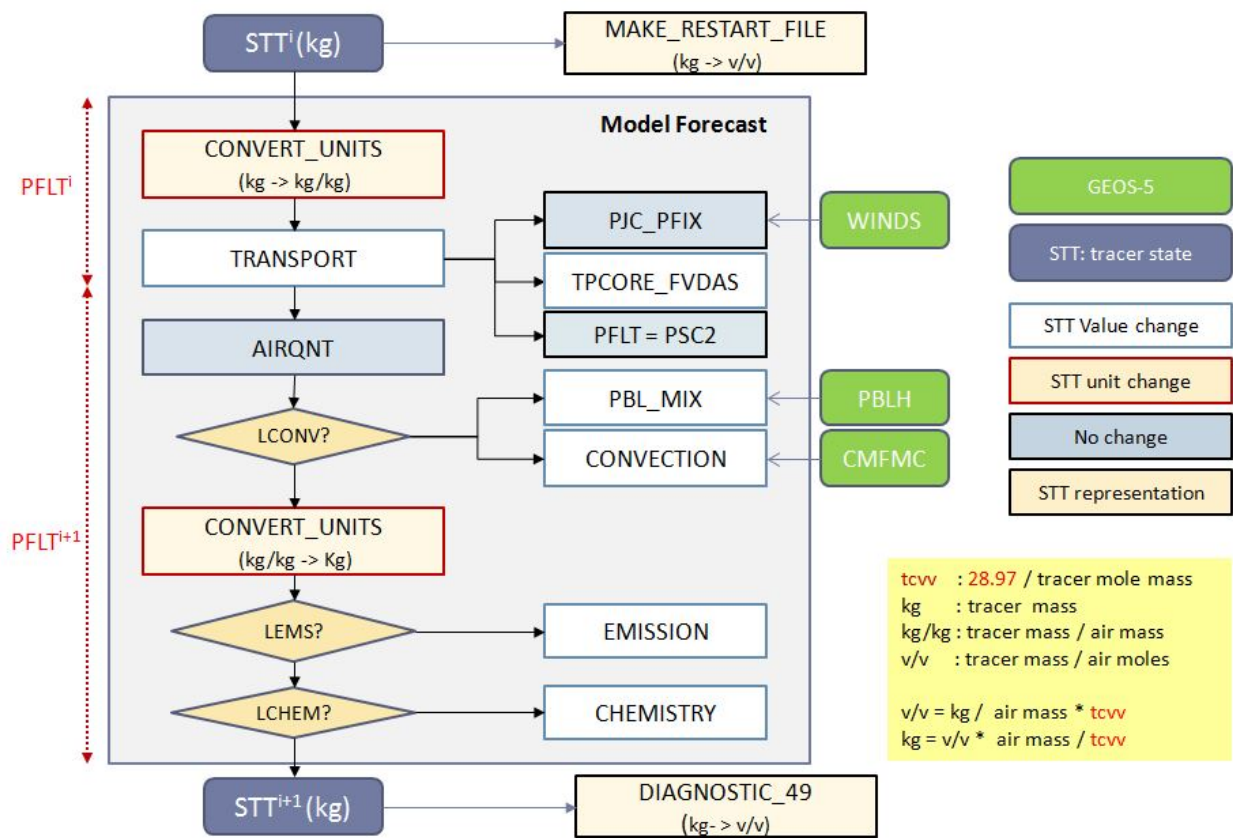

Figure 2. Tracer State (STT) Transition during Model Simulation and External Interfaces

The inter-model unit conversion process applies the air mass captured in AD to convert between the mass-to-mass ratio. The tracer state is also captured in a volume-mixing ratio when it is saved as a restart file or in a diagnostic time series. The unit conversion formula between volume mixing ratio (v/v), tracer mass (kg), and mass ratio (kg/kg) are defined as below where the constant 28.97 represents the molecular mass of dry air.

$$(12) \text{tcvw} = \text{MW}_T / \text{MW}_A = \text{MW}_T / 28.97$$

- (13) $STT(kg) = STT(v/v) \times AD / tcvv$
- (14) $STT(kg/kg) = STT(kg) / AD$
- (15) $STT(v/v) = tcvv \times STT(kg) / AD$

The temporal unit transition of the tracer state (STT) and its dependencies to the surface pressure (PFLT) is depicted in Figure 3 where the READ_RESTART_FILE function converts from the volume mixing ratio unit to the mass unit and CONVERT_UNITS function converts between the mass unit and the mass ratio unit. The first level of the surface pressure dependency is created by the way the air mass (AD) is derived where it represents the total air mass when the GEOS-5 surface pressure is set as the true surface pressure. The second level of surface pressure dependency is created by the way the mass flux is constrained based on the difference between the PFLT and the PSC2 in the Transport model.

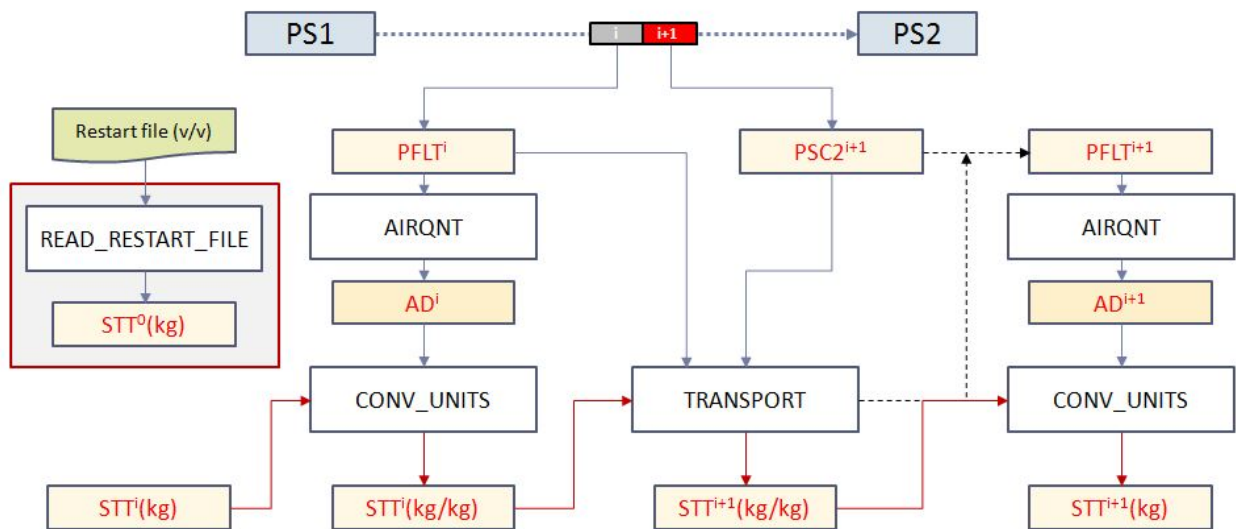

Figure 3. Temporal Transitions of the True Surface Pressure (PS1, PS2), Interpolated Surface Pressure (PFLT & PSC2), Air Mass (AD), and the Tracer State (STT)

II.3 Transport Model

In the Transport model, the PFLT and the PSC2 are mapped to two local variables, P1 and P2, and the center of the two is set as the mean surface pressure, PM. The Transport model employs a separate function to derive the pressure terms from the above three surface pressures as shown in Figure 4 where the three color bars indicate the three temporal instances. The process flow within the Transport model includes PJC_PFIX (which generates a prior mass flux), TPCORE_FVDAS (which simulates advection), and SET_FLOATING_PRESSURE (which advances the surface pressure). As shown in Figure 5, PJC and TPCORE collectively generate an advection template which is applied to each tracer to simulate the horizontal and vertical advection movement.

The Transport model assumes that all constituents in the dry air move together and that the mass flux derived from the total air winds can be constrained by the dry surface pressure change. The surface pressure dependencies in the Transport model are twofold: 1) the spatial distribution of the advection template is constrained by the horizontal distribution of the surface pressure change (P2-P1) and the

vertical pressure profile; and 2) the tracer state unit conversion before and after the advection simulation employs the air density derived from the corresponding surface pressure. The advection template describes the movement distance in longitude, latitude, and vertical coordinates; and it is prepared in two stages. The first stage is performed by PJC_PFIX, which initially estimates the mass flux based on the true winds and updates the estimated mass flux to balance the mass. The mass balancing operation is referred to as a “pressure-fix” indicating that the mass flux is fixed to match the mass flux derived from the surface pressure transition.

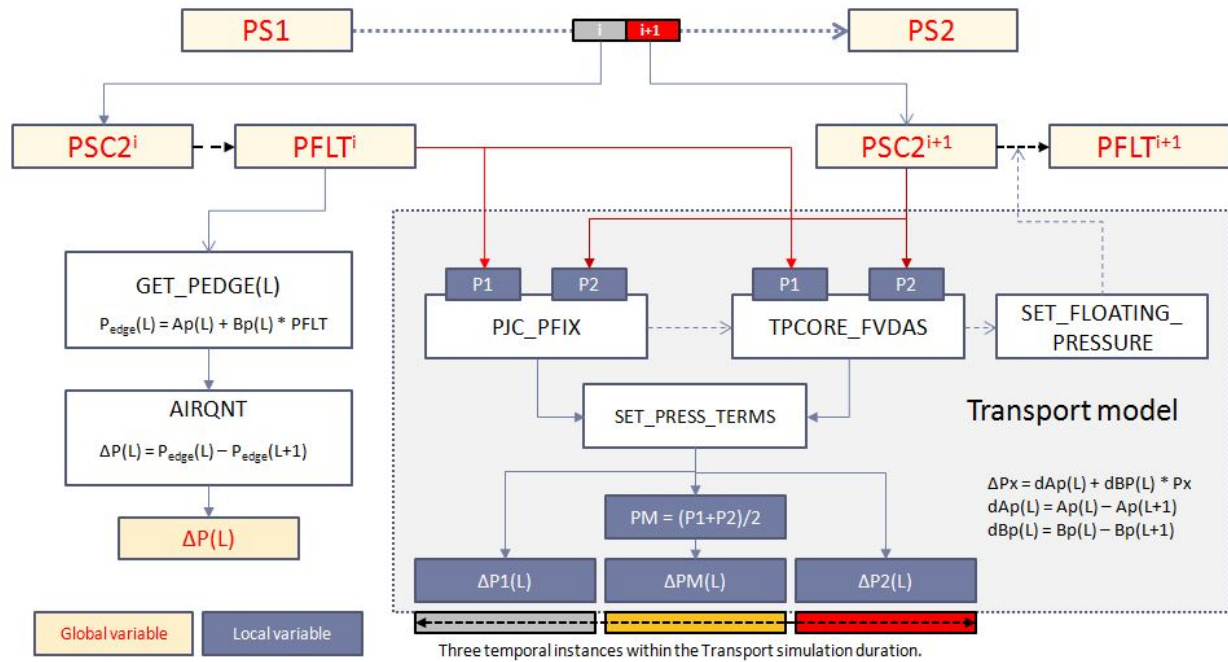

Figure 4. Global Surface Pressure Variables and the Transport-internal Pressure Processing

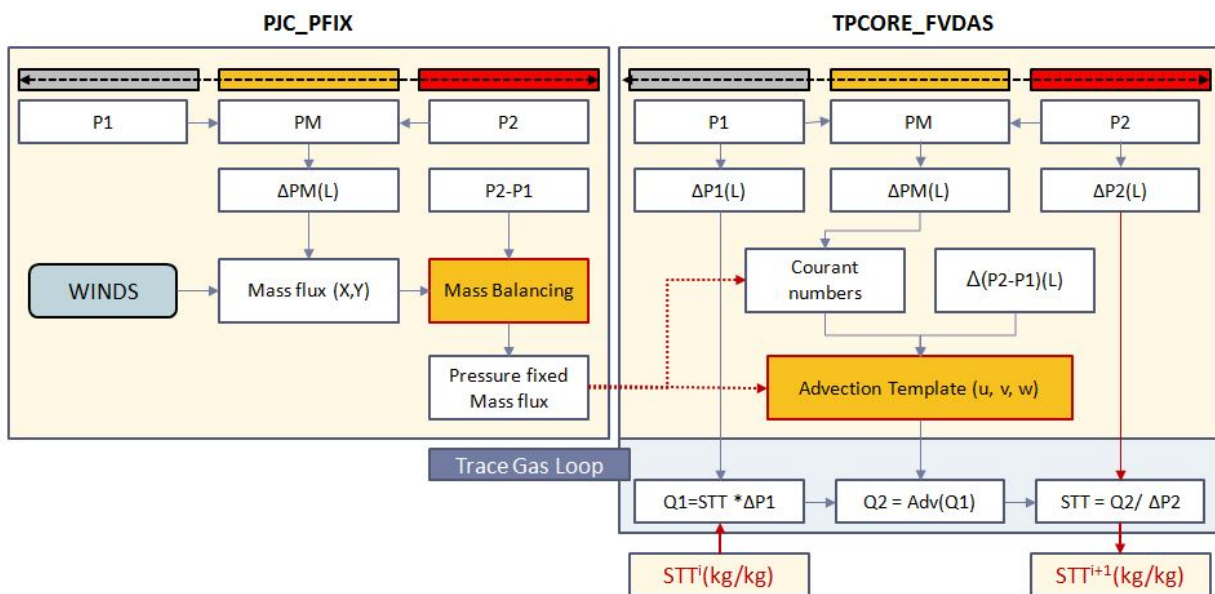

Figure 5. Two-stage Mass Balanced Advection Template Formulation and Tracer Mass Ratio Update Process

The second stage is performed by TPCORE_FVDAS, which receives the pressure-fixed mass flux from PJC_PFIX and converts it into three-dimensional advection distances (u , v , and w). The horizontal distances are computed as Courant numbers, which describe the movement as a fraction of respective grid cell size. The requirement for the maximum duration for the Transport model is determined so that the horizontal movement (i.e., Courant numbers for u and v) of the advection template does not exceed the respective grid cell size. For example, the maximum setting for the simulation time step is 15 min for the $2^\circ \times 2.5^\circ$ grid and 30 min for the $4^\circ \times 5^\circ$ grid. A detailed description of the software implementation of PJC_PFIX and TPCORE_FVDAS is provided in Appendix A.

In order to apply the above advection template to redistribute the tracer mass, the advection template must represent the distribution change of dry air only. Otherwise, the resulting template introduces the water vapor distribution change. The unit conversion before and after the advection simulation applies the air density (pressure thickness) derived from the corresponding surface pressure. Prior to advection, the trace mass is calculated by applying the air density derived from P1. After advection, the redistributed tracer density is converted back to mass ratio employing the air density derived from P2. When P1 and P2 are set based on the wet surface pressure, the resulting mass ratio includes the mass ratio changes incurred by the water vapor.

III. CO2 Model Forecast and Impact Evaluation

The GCA-M2O2 framework supports the CMS-CO2 flux inversion task by integrating the CO2 emission inventories, activating the CMS emission models, and interfacing with the CO2 observation data products as shown in Figure 6. The GCA system provides an interface to the GEOS-5 meteorology data and forward and adjoint dynamics models. The CMS emission model provides an interface to the CO2 flux inventories and forward and adjoint CO2 models. The M2O2 provides a mission-generic observation force function that can simultaneously assimilate the observations from multiple missions. For the impact study, four cases of CO2 model forecasts have been generated by configuring the GCA-M2O2 framework for two stages of model options (with and without the emission model) and for two types of surface pressures (wet and dry).

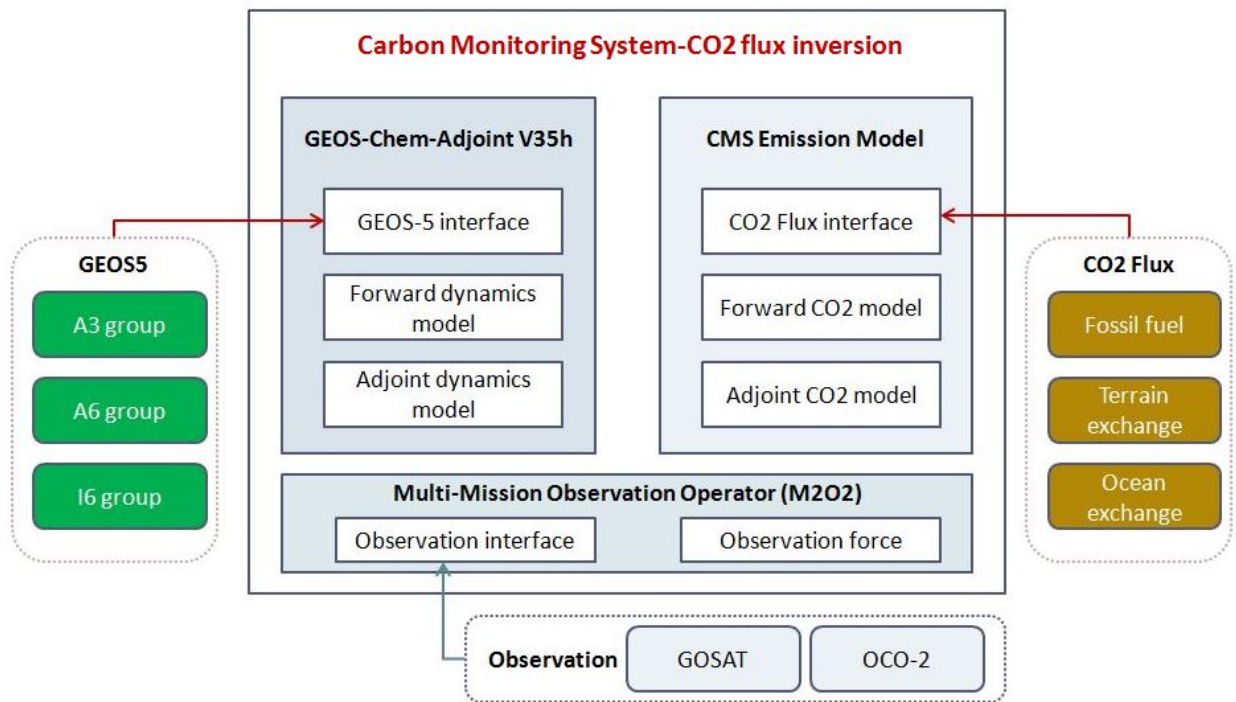

Figure 6. Functional Collaboration of the GCA system, the CMS Emission Model, and the Multi-Mission Observation Operator within the GCA-M2O2 Framework

III.1 Surface Pressure Impact on Dynamics Model Simulation

The CO2 model forecast from the first stage of the model option represents the concentration change due to the dynamics models, which include transport, mixing, and convection. The evaluation criteria of the surface pressure impact include the following:

- 1) Conservation of the total air mass,
- 2) Conservation of the total CO2 mass,
- 3) Deviation of the global mean CO2 (v/v) from the initial condition, and
- 4) Presence of water signature in the instantaneous CO2 (v/v) field.

Setup:

- Simulation period : 2010/01/01 -2010/12/31
- Simulation resolution
 - Spatial resolution : 4°x 5°
 - Temporal resolution : 30 minutes
 - Data dimension is 46 columns, 72 rows, and 47 levels
- Initial condition : 370 ppm
- Diagnose
 - Temporal resolution : 3 hourly
 - Tracked variables : AD, STT_{kg} (when STT unit is kg)
 - Saved states : Total air mass, Total CO2 mass, CO2 (v/v)

Total operation indicates a three dimensional Sum ($\sum_{k=1, nlevels} \sum_{j=1, nrows} \sum_{i=1, ncols}$)

Total Air Mass = **Total** (AD(l, j, k))

Total CO2(kg) = **Total** (STT_{kg}(l,j,k))

CO2_{v/v} (i,j,k) = STT_{kg} (l,j,k) / AD(l,j,k) x tcvv

Post Processing:

- Global Mean CO2_{v/v}(t) = **Total**(CO2_{v/v}(l,j,k)) / (ncols x nrows x nlevels) at each time step
- Monthly Average of the Global Mean CO2_{v/v}(t)

Findings:

- a) Table 1 lists the summery of the impacts with respect to the above four evaluation categories.
- b) Figure 7: The total air mass is 18Gt higher than the dry air mass and has up to 2Gt seasonal bias.
- c) Figure 8: The total CO2 mass is initialized ~6Gt higher in the wet surface pressure case but it stays constant in both cases.
- d) Figure 9: The seasonal bias of the global mean CO2_{v/v} is inversely correlated to that of the total air mass. The wet surface pressure case deviates upto 150 ppb in August.
- e) Figure 10: The wet surface pressure case CO2_{v/v} captured on August 1st (when the deviation is highest) shows larger deviations from the initial condition for both the latitudinal average CO2 and the surface CO2, and has a water signature.

Table 1. Impact of the Surface Pressure on Dynamics Model Simulation

Evaluation Criteria	Wet	Dry	Performance
Total air mass	5136 Gt + 2 Gt	5118.5 Gt ±0.5Gt	Dry > wet
Total CO2 mass	2886 Gt	2880 Gt	Same
Global mean deviation	-0.2 ppm	-0.05 ppm	Dry > wet
Water signature	Present in summer	Not present	Dry > wet

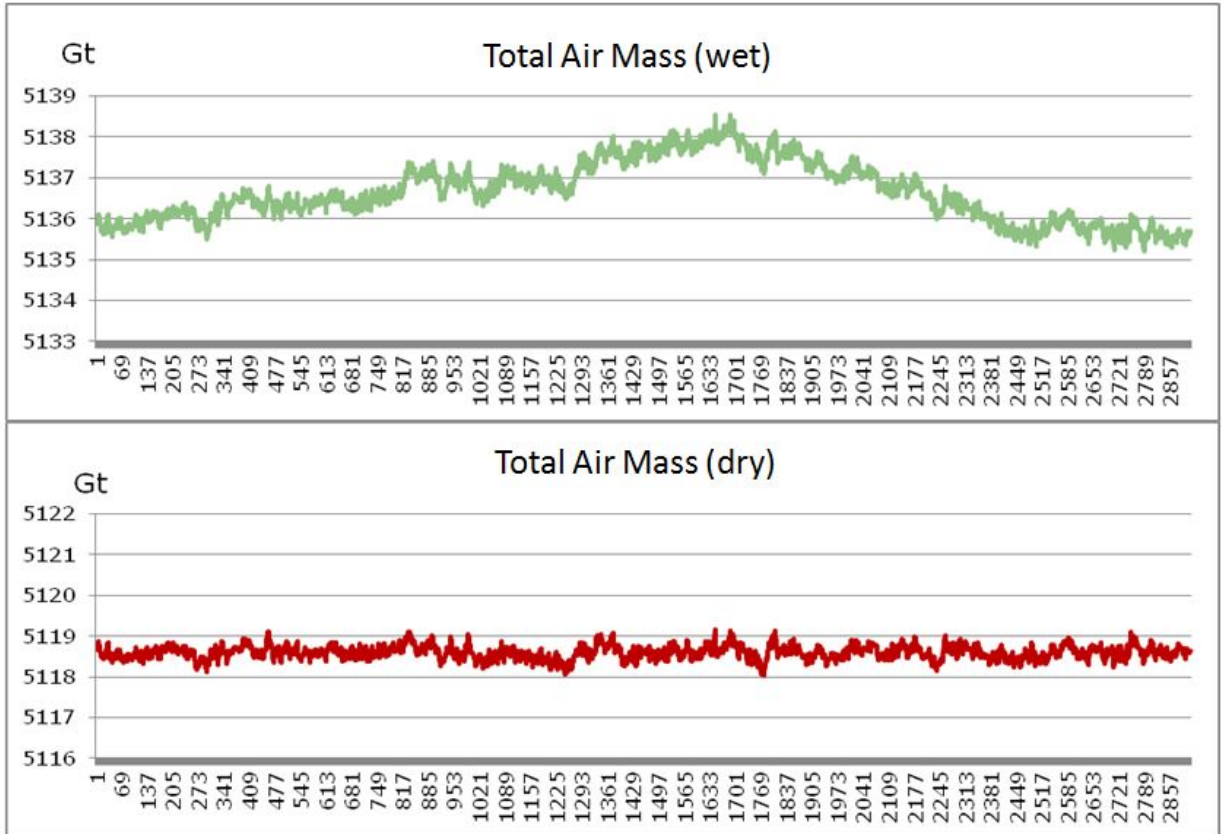

Figure 7 Total Air Mass during the Wet Surface Pressure Simulation (top) and during the Dry Surface Pressure Simulation (bottom) tracked 3 hourly for one year (2010)



Figure 8 Conservation of the Total CO2 Mass (sampled 3 hourly)

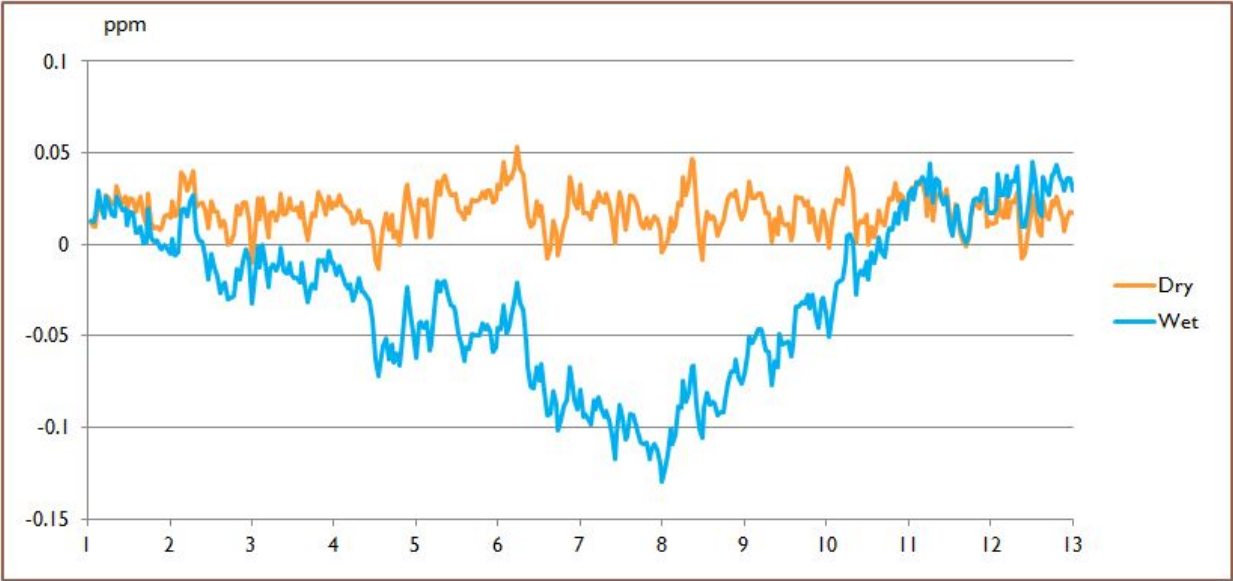

Figure 9 Seasonal Cycle of the Global Mean CO2 (sampled daily)

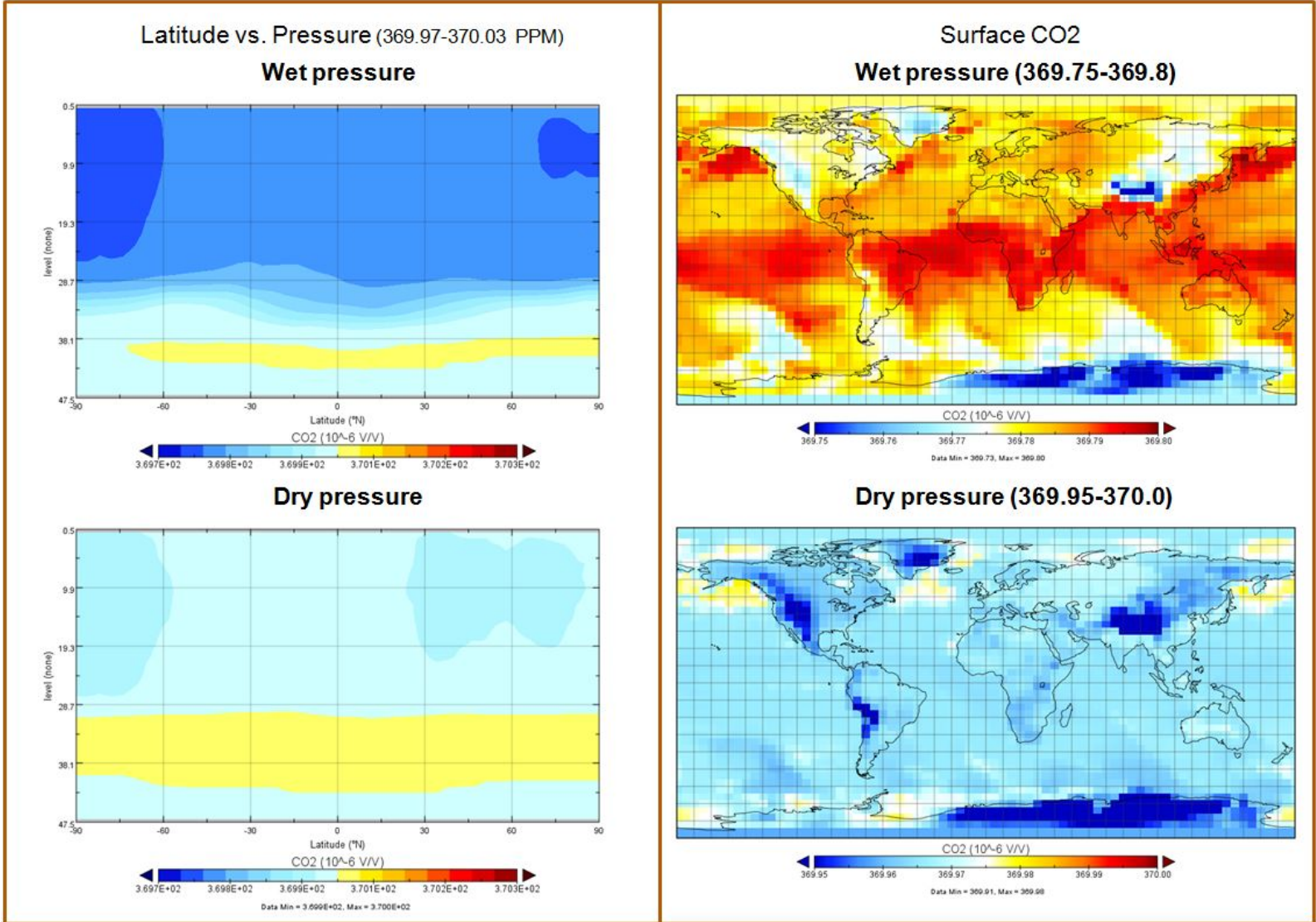

Figure 10 CO2 Comparison of the CO2 Concentration between the Two Surface Pressure Cases at the Time with the Highest Global Mean Difference (2010/08/01)

III.2 Surface Pressure Impact on Emission Model Simulation

The CO2 model forecast from the second stage of the model option represents the concentration change from the emission model in addition to the dynamics models, thus the difference between the two surface cases indicates the over-all impact of the water vapor on CO2 model forecast. The evaluation criteria of the surface pressure impact include the following:

- 1) Difference of the total CO2 mass,
- 2) Difference of the global mean CO2 (v/v),
- 3) Spatial difference of the instantaneous surface CO2 (v/v) field, and
- 4) Vertical profile difference of the instantaneous CO2(v/v) field.

Setup:

- Simulation period : 2010/01/01 -2011/12/31
- Simulation resolution : same as the stage 1
- Initial condition : model forecast using the CMS-prior CO2 fluxes
- CO2 flux Inventory : MACC_III (Figure 11)
- Diagnose : same as the stage 1

Post Analysis: same as the stage 1

Findings:

- a) Table2 lists the summery of the impacts with respect to the above evaluation criteria.
- b) Figure 12: The seasonal cycle of the global mean CO2 difference (dry - wet) with the emission is similar to that without the emission.
- c) Figure 13: The spatial distribution of the CO2 (v/v) difference shows a seasonal inversion in the vertical profile below level 30 and between the two hemispheres.
- d) Figure 14: The latitudinal average of the surface CO2 difference (dry-wet) shows the surface CO2 of the dry surface pressure case is more sensitive to the emission.
- e) Figure 15: The total CO2 mass change is consistent within 0.05Gt per month after the initial difference of 7.05 Gt. The Total CO2 mass change matches with the CO2 mass integrated from the MACC-III emission inventory within 0.02Gt/month.

Table 2. Impact of the Surface Pressure on Emission Model Simulation

Evaluation criteria	impact
Total CO2 Mass	Initial difference of 7.05 Gt and < 0.05 Gt variation
CO2 emission (dry – wet)	< 0.02 Gt/month, < 0.01 Gt /year
Global mean CO2 (dry-wet)	0-120 ppb
Surface CO2 s (dry-wet)	± 3 ppm (grid cell level), ± 1ppm (latitudinal average)
Vertical CO2 (dry-wet)	± 1 ppm (latitudinal average)

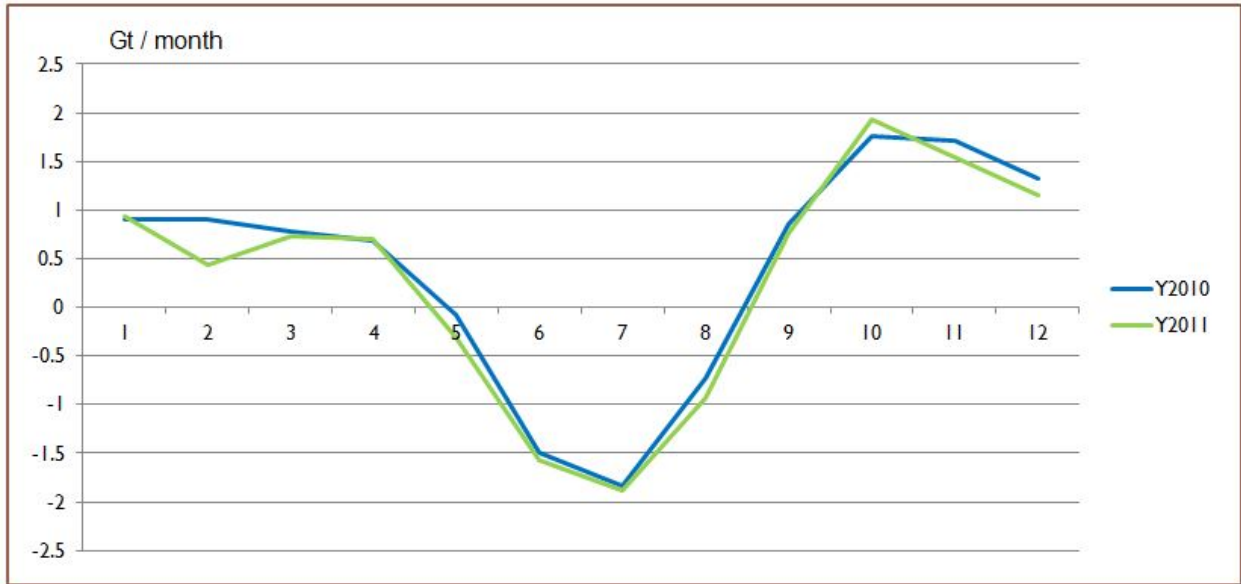

Figure 11 Seasonal Cycle of the MACC-III Emission Inventory



Figure 12 Global Mean CO2 difference (Dry-Wet) with emission model (MACC-III) and without (370 PPM)

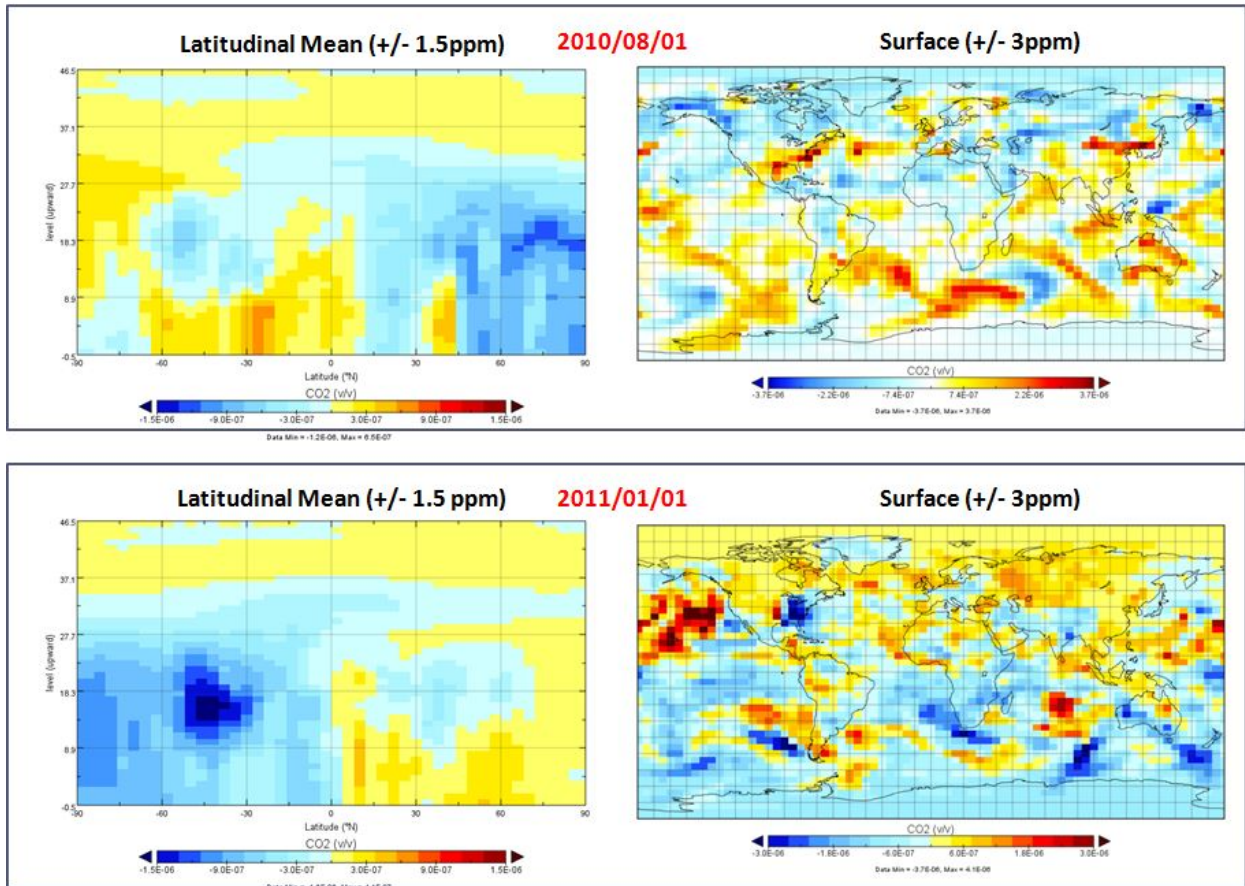

Figure 13 CO2 Difference (Dry-Wet) Captured on 2010/08/01 (top) and on 2011/01/01 (bottom)



Figure 14 Latitudinal Mean Surface CO2 Difference (Dry - Wet) on 2010/08/01 (Aug) and 2011/01/01 (Jan)

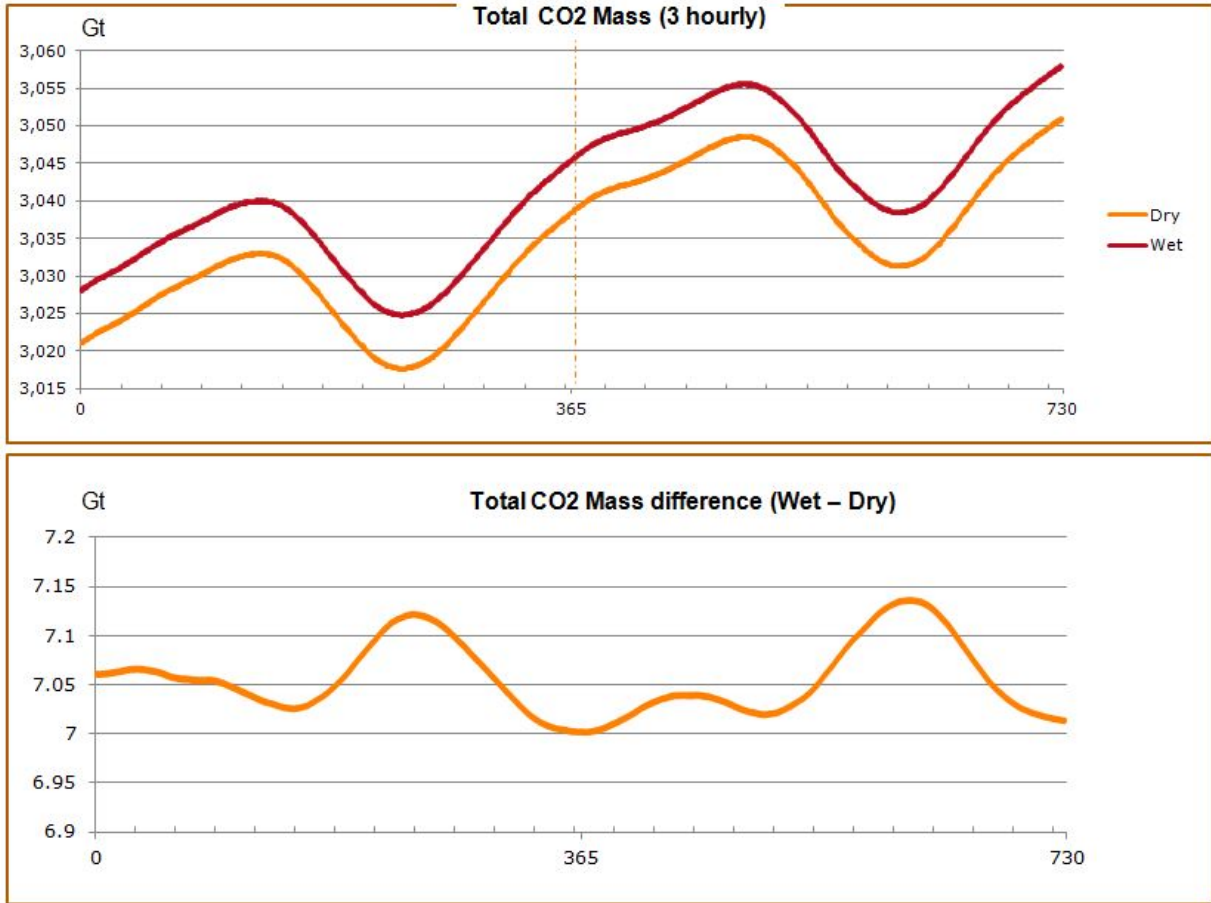

Figure 15 Total CO2 Mass Change and the Difference (Wet -Dry) during 2010 and 2011

IV Conclusion

The surface pressure dependencies in the GCA system are divided into two types, a first order dependency and a second order dependency based on whether the dependency is a function of the surface pressure or a function of the surface pressure gradient. The first order dependency has been found in the air quantity derivation and the unit conversion processes, which include AIRQNT, READ_RESTART_FILE, MAKE_RESTART_FILE, CONVERT_UNITS, and DIAG_49. The second order dependency has been found in the prior mass flux formulation and the advection template generation processes, which include PJC_PFIX, and TOCPRE_FVDAS. All of the above functions process the surface pressure assuming it represents the dry air only.

When the water vapor mass is removed partially, it introduces inconsistencies among the functions that share the surface pressure, thus increases the water vapor anomaly. For example, when the dry air mass was employed to convert the volume mixing ratio to mass during READ_RESTART_FILE and to convert between mass and mass ratio in CONVERT_UNITS, it introduced a strong correlation between the CO₂ mass distribution and the water vapor mass distribution due to the inconsistent interpretation of the mass ratio among the various functions in the GCA system. Therefore, it is important to comprehensively address the complex surface pressure dependencies in the GCA system and remove the water vapor mass at the right stage of the CO₂ model forecast process.

In order to study the impact of the water vapor included in the GEOS-5 surface pressure in CO₂ model forecast, a preprocessing step has been developed to convert the GEOS-5 surface pressure to dry surface pressure so that the CO₂ model forecast can be obtained for “wet” and “dry” surface pressures. The “wet” and “dry” CO₂ model forecasts were performed in two simulation stages: 1) dynamics simulation (transport, mixing, and convection), and 2) dynamics and emission (with the CMS emission inventory) simulation. The evaluation of the first simulation stage showed the dry surface pressure setup improved the seasonal biases in the total air mass, the total CO₂ mass, and the global CO₂ volume mixing ratio, and removed the water signature. The evaluation of the second simulation stage showed the dry surface pressure setup reduces the seasonal bias and increases the sensitivity to the emission.

It has been shown that water vapor related anomalies in the CO₂ model forecast can be resolved by removing the water vapor contribution from the GEOS-5 surface pressure as it is read in so that the dry surface pressure assumption employed by the GCA system can be supported. The GCA-M2O2 provides the pressure profile and the surface pressure in both total air and dry air in order to be compatible with the observational environment where the pressure represents total air.

Appendix-A Transport Model Software

The transport model is composed of two modules, PJC_PFIX, which generates the reference advection template and TPCORE_FVDAS, which simulate advection of the tracers applying the advection template to all tracers. Figure A-1 describes the internal process flow of PJC_PFIX and TPCORE_FVDAS and the interface between them with the key variables that facilitate the internal and external data flow. As discussed earlier, the “SET_PRESS_TERMS” function is employed by both modules to set the temporal transition of the pressure thickness during the model forecast duration.

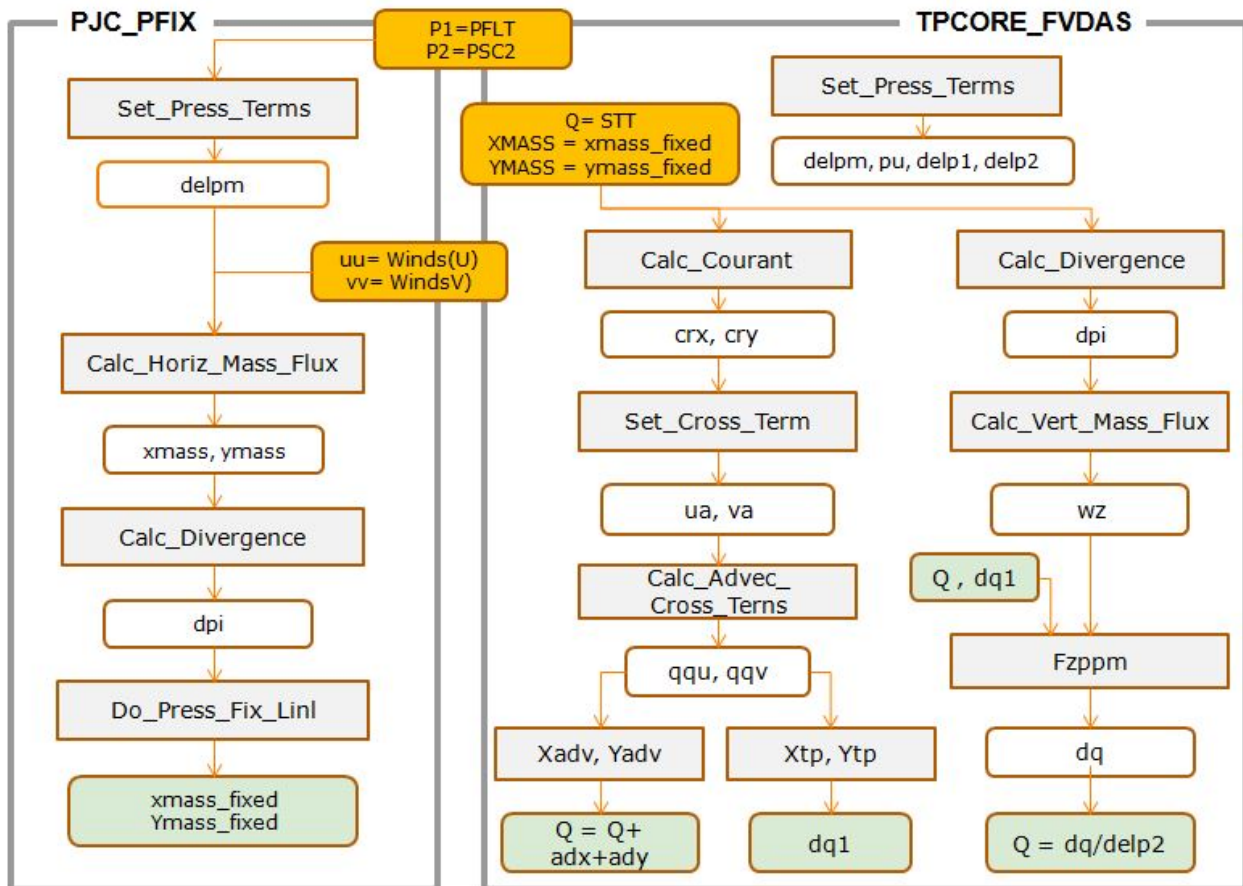

Figure A-1. Transport Model (PJC_PFIX and TPCORE_FVDAS) Process Flow

A.1 PJC_PFIX

The PJC_PFIX computes the pressure thickness as the pseudo air density and generates the advection template applying the longitudinal and the latitudinal winds to the pressure thickness. Then, it corrects the advection template to achieve the mass balancing with respect to the meteorology-based surface pressure and to align the vertical gradient to match that of the hybrid vertical grid. The GEOS-5 winds represent the movement of total air. The mass balancing step forces the Transport model to be aligned

with the prescribed future surface pressure by removing the mass flux deviation introduced by the winds.

PJC_PFIX generates the advection template in two mass flux arrays, XMASS for longitudinal mass flux and YMASS for latitudinal mass flux, in following four steps based on the current and future surface pressures (P1 & P2) and the longitudinal and latitudinal winds (U & V).

- i. Set Press Terms: computes the pressure thickness as the pseudo air density (delpm) based on the two surface pressures. (Note: A temporal averaging is applied.)

$$\text{delpm} = (\text{Ap}(L) - \text{Ap}(L+1)) + (\text{Bp}(L) - \text{Bp}(L+1)) * (\text{P1} + \text{P2})/2 = \text{dAp}(L) + \text{dBp}(L) * (\text{P1} + \text{P2})/2$$

- ii. Calc Horiz Mass Flux: computes the mass fluxes (xmass & ymass) based on the pseudo air density and the winds applying the Courant number conversion (CR). (Note: One-sided spatial averaging is applied.)

$$\text{xmass}(l,j,k) = \text{delpm}(i-1,j,k) * \text{CR}(\text{uu}(i-1,j,k)) + \text{delpm}(l,j,k) * \text{CR}(\text{uu}(l,j,k))$$

$$\text{ymass}(l,j,k) = \text{delpm}(i,j-1,k) * \text{CR}(\text{vv}(i,j-1,k)) + \text{delpm}(l,j,k) * \text{CR}(\text{vv}(l,j,k))$$

- iii. Calc Divergence: computes the column mass change (dpi) by vertically integrating the above mass fluxes weighted by the areal coverage. (Note: A spatial gradient is employed for temporal gradient.)

$$\text{dpi}(l,j) = \text{Column}((\text{xmass}(l,j,k) - \text{xmass}(i-1,j,k)) + \text{W}(\text{area}(j)) * (\text{ymass}(l,j,k) - \text{ymass}(i,j-1,k)))$$

- iv. Do Press Fix Lin: computes the mass divergence and updates the mass flux by applying the vertical pressure thickness profile of the mass divergence. The mass divergence is defined to be the difference between the above surface pressure change (dpi) and the true surface change (P2-P1).

$$\text{Xmass_fixed}(l,j,k) = \text{xmass}(l,j,k) + (\text{dBp}(k) * (\text{dpi}(l,j) - (\text{P2}(l,j) - \text{P1}(l,j))))$$

$$\text{Ymass_fixed}(l,j,k) = \text{ymass}(l,j,k) + (\text{dBp}(k) * (\text{dpi}(l,j) - (\text{P2}(l,j) - \text{P1}(l,j))))$$

A.2 TPCORE_FVDAS

TPCORE_FVDAS derives the pressure thicknesses and applies them to the mass fluxes (XMASS and YMASS) to calculate the Courant numbers, the advection movement represented in fraction of the grid cell count. The following two steps are tracer-independent; thus, they can be performed external to TPCORE_FVDAS.

- i. Set Press Terms: computes the pseudo air density (delpm) and generates the pressure edge array by applying a two grid cell averaging in longitude direction (pu). The air density at the beginning and at the end of the simulation time step are also computed (delp1 & delp2)

- a. $pu(l,j) = (delpm(i-1,j) + delpm(l,j))/2$
 - b. $delp1(l,j,k) = dAp(k) + dBp(k)*P1(l,j,k)$
 - c. $delp2(l,j,k) = dAp(k) + dBp(k)*P2(l,j,k)$
- ii. Calc_Courant: computes the Courant numbers (crx and cry) by dividing the mass fluxes with corresponding pseudo air densities that were multiplied in PJC_PFIX. The Courant numbers represent a combination of the winds and surface pressure tendencies.

- a. $crx(l,j) = xmass(i-1,j) / pu(i-1,j) + xmass(i,j) / pu(i,j)$
- b. $cry(l,j) = ymass(l,j-1)/(pu(l,j-1) * cos(lat(j))) + ymass(l,j) / (pu(i,j) * cos(lat(j)))$

TPCORE_FVDAS performs the advection in horizontal direction followed by the vertical direction. During the horizontal advection, the following four steps are repeated for each vertical level.

- i. Set_Cross_Term: computes the pseudo winds (ua and va) by applying a two-grid cell averaging to the Courant numbers in corresponding directions. (Note: One sided spatial averaging is applied in opposite direction from the PJC_PFIX)
 - c. $ua(l,j) = 0.5 * (crx(i,j) + crx(i+1,j))$
 - d. $va(l,j) = 0.5 * (cry(l,j) + cry(l,j+1))$
- ii. Calc_Advec_Cross_Terms: estimates the affected mass ratio in longitude (qqu) and latitude (qqv) by adding the expected mass ratio changes from the winds. (Note: The spatial gradient is used to estimate the temporal change.)
 - e. $qqu(l,j) = Q(l,j) + ua(l,j) * (Q(iu,j) - Q(iu+1,j))/2$ where $iu = i - ua(i,j)$
 - f. $qqv(l,j) = Q(l,j) + va(l,j) * (Q(l,jv) - Q(l,jv+1))/2$ where $jv = j - va(l,j)$
- iii. Xadv_Dao2 & Yadv_Dao2: computes the mass ratio changes (adx and ady) by applying a second order interpolation surrounding the source location.
 - a. $adx = Interpolate(qqu(iu-1,j), qqu(iu,j), qqu(iu+1,j))$ where $iu = i - int(ua(i,j,k))$
 - b. $ady = Interpolate(qqv(i,jv-1), qqv(i,jv), qqv(i,jv+1))$ where $jv = j - int(va(i,j,k))$
 - c. $Q(l,j) = Q(l,j) + adx + ady$
- iv. XTp and YTp: computes the pseudo tracer mass (dq1) based on the affected mass ratios (qqu and qqv), Courant numbers (crx, cry), and the pseudo air density (pu)

TPCORE_FVDAS estimates the tracer mass flux (dq) as a function of the advection and updates the mass ratio of the tracer applying the new air mass (delp2) in the following three steps.

- i. Calc_Divergence: computes the column mass change (dpi) by vertically integrating the mass fluxes weighted by the areal coverage. (Note: same as in PJC_PFIX)

$$\mathbf{dpi(l,j,k) = (xmass(l,j,k) - xmass(i-1,j,k)) + W(area(j)) * (ymass(l,j,k) - ymass(l,j-1,k))}$$

$$\mathbf{dps_ctm(l,j) = Column(dpi(l,j,k))}$$

- ii. Calc_Vert_Mass_Flux: computes the vertical mass flux that conserves the mass balance.

$$\mathbf{wz(l,j,k) = dpi(l,j,k) - dBp(k) * dps_ctm(l,j,k)}$$

$$\mathbf{wz(l,j,k) = 0.5 * (wz(l,j,k+1) + wz(l,j,k))}$$

- iii. Update the tracer array (Q) based on the updated tracer mass computed by the FZPPM function and the updated air mass.

$$\mathbf{dq = Fzppm(Q, dq1, wz, pu)}$$

$$\mathbf{Q = dq / delp2}$$

Appendix-B Dry Air Mass for Unit Conversion

Initially, the impact of applying the total air surface pressure was identified as a unit conversion error due to the incorrect representation of dry air mass that can be simply corrected by extracting the dry air mass from the total air mass.

Approach: The dry air mass can be computed by removing the water vapor mass from the total air mass employing the specific humidity information which defines the mass ratio between the water vapor and the total air.

$$(1) \text{ SPHU}(L) = M_{\text{wp}}(L) / (M_{\text{dry}}(L) + M_{\text{wp}}(L)) = M_{\text{wp}}(L) / M_{\text{total}}(L)$$

$$(2) M_{\text{dry}}(L) = M_{\text{total}}(L) (1 - \text{SPHU}(L))$$

Experiment Setup:

- Simulation period : 2010/01/01 -2010/12/31
- Initial condition : 370 ppm
- Emission model : off
- Diagnose resolution : 4° x 5°, 3 hourly

Findings:

- The total air mass (Figure B-1) shows seasonal variance up to 2 Gt.
- The daily global mean CO₂ concentration plots (Figure B-2) show that the new unit conversion process inverts the seasonal bias of the concentration.
- The concentration maps (Figure B-3) show the new unit conversion process introduces a strong moisture signature up to 7 ppm.

Conclusion: When the dry air mass is applied for unit conversion, the air mass in the mass ratio representation of the trace gas becomes inconsistent with the air mass employed for the mass flux formulation. The inconsistency introduces the moisture signature in the CO₂ concentration because the movement of the water vapor in addition to the dry air has been applied to the movement of CO₂.

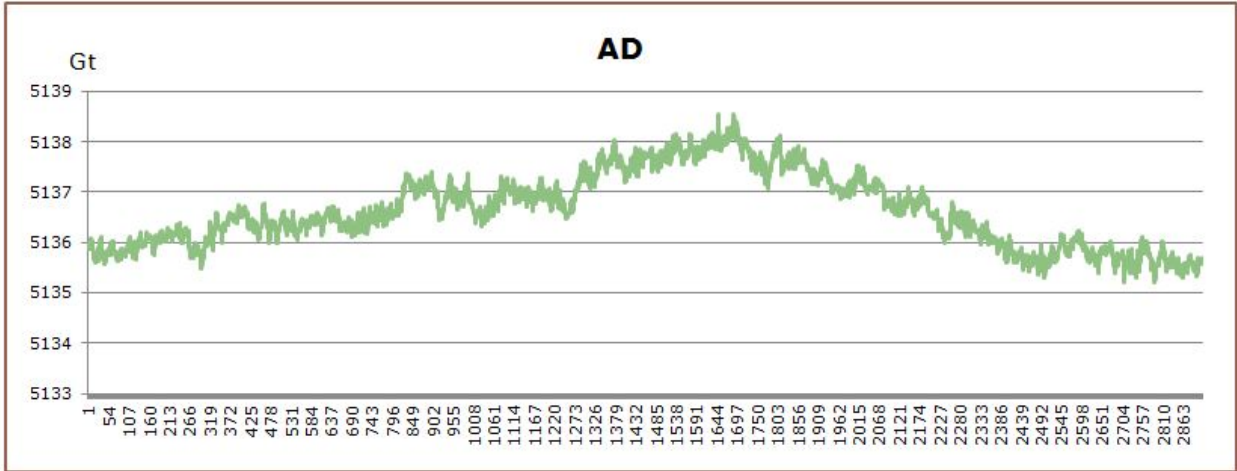

Figure B-1. Seasonal Variance of the Total Air Mass (AD) Captured in 3-hour Interval

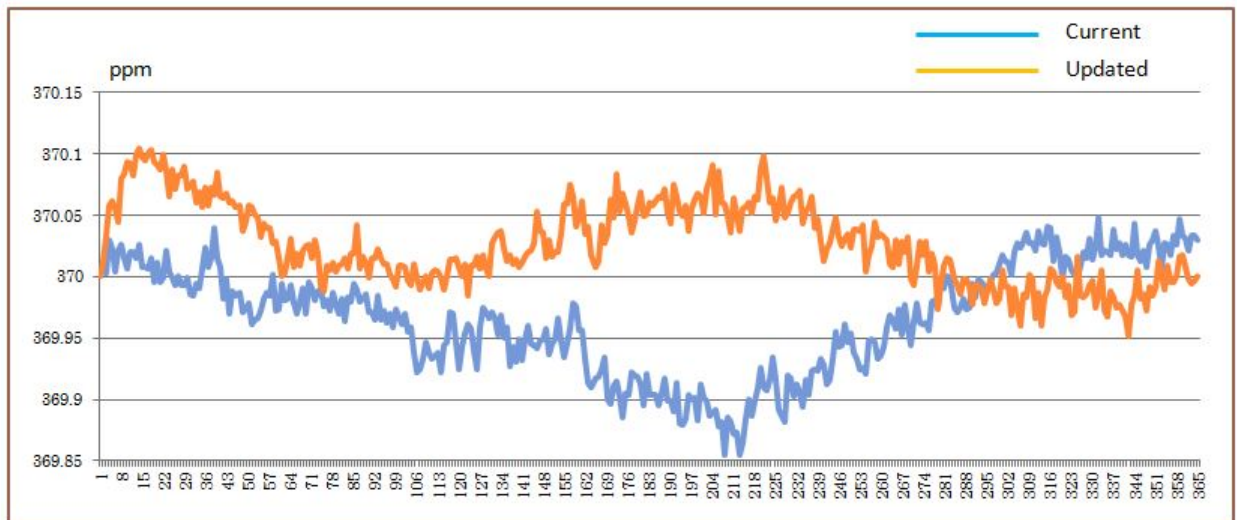

Figure B-2 Comparison of the Global Mean CO2 Concentration between the Current Simulation (total air mass used in unit conversion) and the Updated Simulation (dry air mass used in unit conversion)

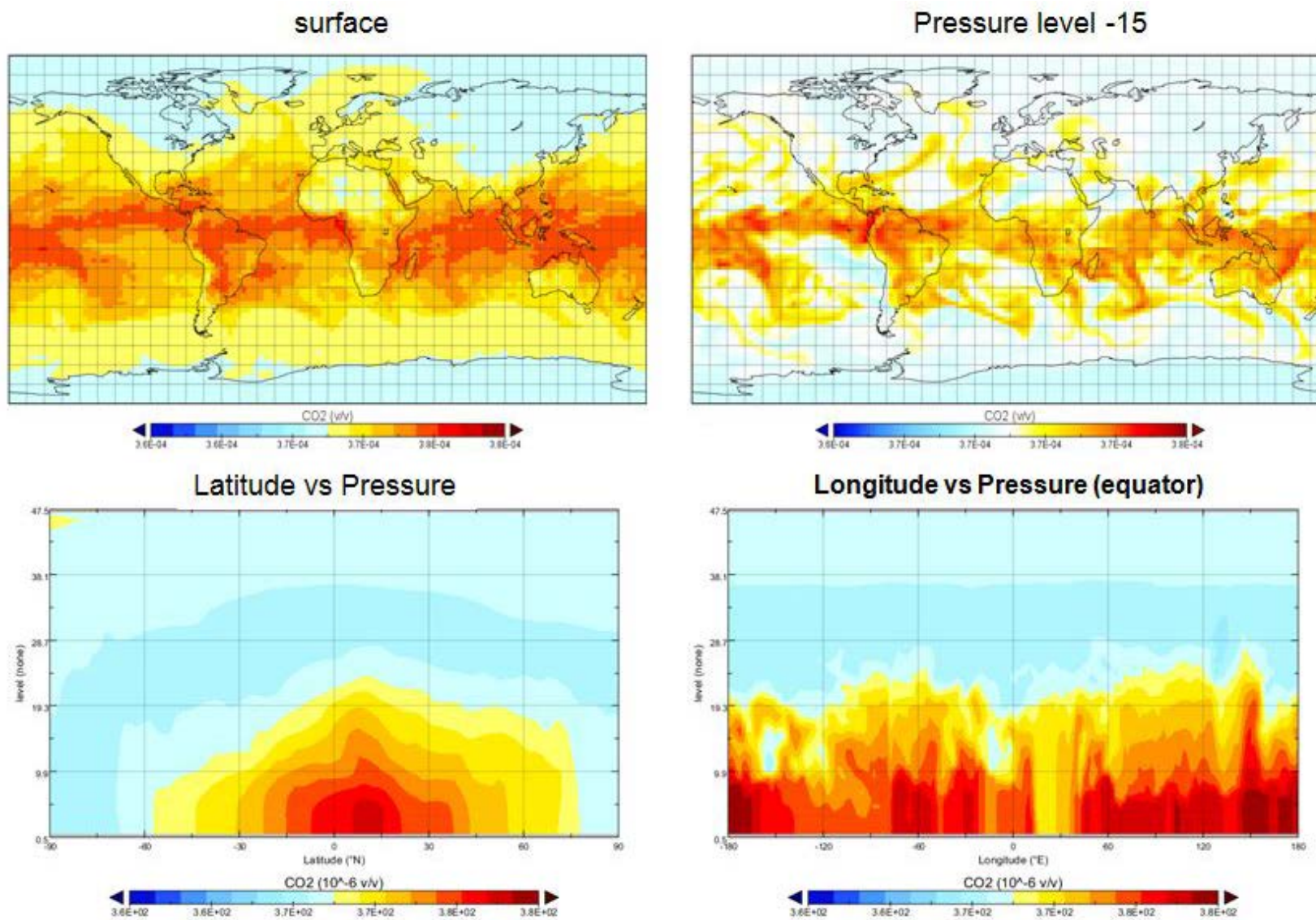

Figure B-3 Four Views of the Water Signature in the CO₂, at the Surface, at the Pressure Level-15 (~750hPa), in the Latitudinal Profile, and in the Longitudinal Profile

Appendix-C GCA code modifications

The GCA code has been modified to address the following three findings:

1. The tracer unit for the dynamics model simulation, which includes transport, mixing, and convection, should be the mass ratio (kg/kg). It is currently set to be the volume mixing ratio (v/v).
2. The mass balancing step surrounding the TPCORE_FVDAS call shown in Figure C-1 is erroneous. Without the step, the mass is perfectly balanced and improves the computational efficiency by ~10%.
3. The GCA system processes the surface pressure read in from GEOS meteorology data assuming it is dry surface pressure.

Figure C-2 shows the impact of the above changes with respect to the latitudinal deviation from the initial condition of 370 ppm. The deviation was found to be less than 0.01 ppm with a slight monthly variation. The modifications made to the GCA-v35h software are briefly summarized in the Table C-1.

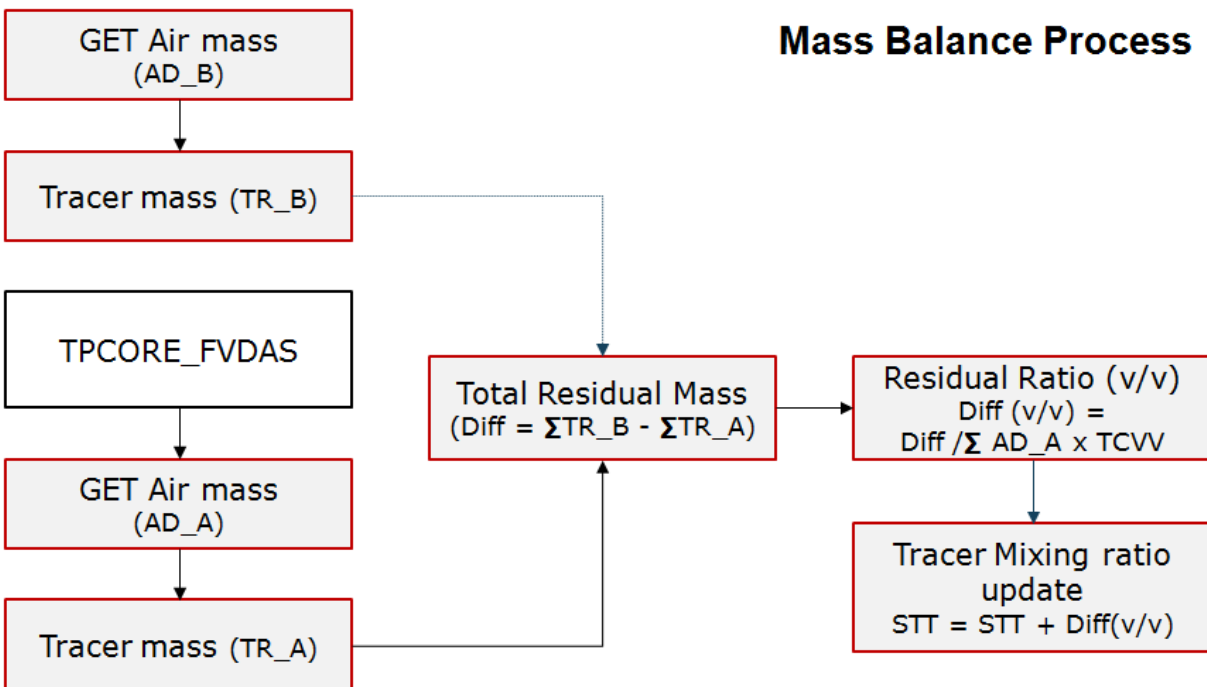

Figure C-1. Post TPCORE_FVDAS Mass Balance Process in the GCA-V35h

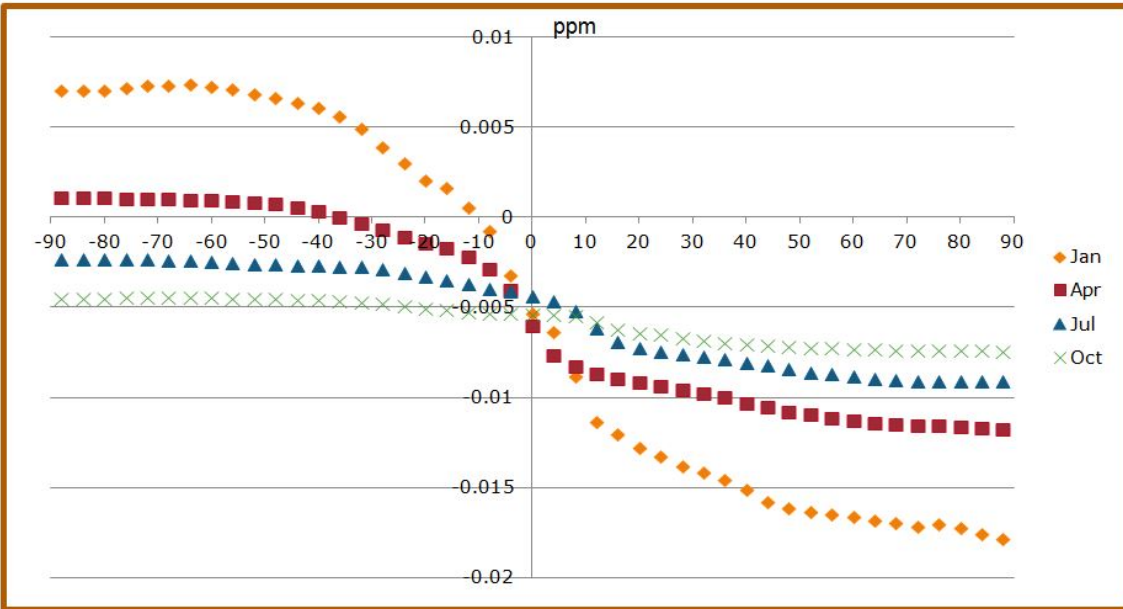

Figure C-2 Latitudinal Average Difference (updated – current) of the CO2 Model Forecasts

Table C-1. GCA-v35h Software Modification Summary

File name	function	Description
dao_mod.f (* indicates a new function.)	CONVERT_UNITS	Two additional unit conversion options have been added: option 5 (Kg->kg/kg) and option 6 (kg/kg->kg) to support the dynamics model simulation in mass ratio unit (kg/kg).
	SET_DRY_SURFACE_PRESSURE*	Converts the GEOS-5 wet surface pressure field to dry surface pressure field.
	GET_WET_PRESSURE_PROFILE*	Returns the wet pressure profile for a specified location. It is used in the observation operator to project the model forecast in the observation pressure grid which is specified in wet pressure.
	GET_WET_SURFACE_PRESSURE*	Returns the wet surface pressure for a specified location.
transport_mod.f	DO_TRANSPORT	The post TPCORE_FVDAS mass balancing step (see Figure C-1) has been removed.
geos_chem_mod.f	DO_GEOS_CHEM	The unit options 1 (kg->v/v) and 2 (v/v->kg) in the CONVERT_UNIT function have been replaced with options 5 and 6.
		“SET_DRY_SURFACE_PRESSURE” call has been added following the surface pressure read function calls (GET_I6_FIELD_1 and GET_I6_FIELD_2).

