



This is a repository copy of *Improving Rail Wear and RCF Performance using Laser Cladding*.

White Rose Research Online URL for this paper:
<http://eprints.whiterose.ac.uk/100557/>

Version: Accepted Version

Proceedings Paper:

Lewis, S.R., Fretwell-Smith, S., Goodwin, P.S. et al. (6 more authors) (2016) Improving Rail Wear and RCF Performance using Laser Cladding. In: *Wear. 10th International Conference on Contact Mechanics and Wear of Rail/Wheel Systems*, 30 Aug - 03 Sep 2015, Colorado, USA. Elsevier , pp. 268-278.

<https://doi.org/10.1016/j.wear.2016.05.011>

Reuse

This article is distributed under the terms of the Creative Commons Attribution-NonCommercial-NoDerivs (CC BY-NC-ND) licence. This licence only allows you to download this work and share it with others as long as you credit the authors, but you can't change the article in any way or use it commercially. More information and the full terms of the licence here: <https://creativecommons.org/licenses/>

Takedown

If you consider content in White Rose Research Online to be in breach of UK law, please notify us by emailing eprints@whiterose.ac.uk including the URL of the record and the reason for the withdrawal request.



eprints@whiterose.ac.uk
<https://eprints.whiterose.ac.uk/>

Improving Rail Wear and RCF Performance using Laser Cladding

S. R. Lewis¹, R. Lewis¹, P. S. Goodwin², S. Fretwell-Smith³, D. I. Fletcher¹, K. Murray⁴

(1) Department of Mechanical Engineering, University of Sheffield, UK. (2) Laser Cladding Technology Ltd, Worksop, UK.

(3) Tata Steel Rail Technologies, Rotherham, S60 3AR. (4) Sandvik Osprey Ltd, Neath, UK.

*stephen.lewis@Sheffield.ac.uk

ABSTRACT

Laser cladding has been considered as a method for improving the wear and RCF performance of standard grade rail. This paper presents results of small scale tests carried out to assess the wear and RCF performance of rail which had been laser clad. Using the Laser Cladding process premium metals can be deposited on to the working surface of standard rail with the aim of enhancing the wear and RCF life of the rail. Various laser clad samples were tested using a twin-disc method. The candidate metals were clad on top of standard 260 grade rail discs and were tested against a disc of standard wheel material. During the tests wear rates and RCF initiation were monitored and compared to those of a standard rail disc. Six candidate cladding materials were chosen for this test: A multi-phase Manganese Steel Variant (MMV), Martensitic Stainless Steel (MSS), TWIP Steel, NiCrBSi, Stellite 12 and Stellite 6. The MSS, Stellite 6, and Stellite 12 samples showed reduced wear rates relative to the standard 260 Grade rail discs, and also produced a reduction in wheel steel wear. The RCF initiation resistance of all of the candidate materials was superior compared to the 260 Grade material.

1. INTRODUCTION

Rail maintenance and replacement represent some of the major costs of running a rail network. Rail lifetime is determined by two major factors; wear and rolling contact fatigue (RCF). The use of premium rail grades is one solution to increasing rail life. However, work carried out in [1] showed that the laser cladding of rail shows great potential in increasing the RCF performance of standard grade rail. Laser cladding of rail also offers a potentially more cost effective solution to extending rail life as opposed to manufacturing and entire section of rail from premium material. With laser cladding only the top few millimeters of rail need to be treated with the bulk of material being a cheaper standard rail grade. The objective of this work was to characterise the wear and RCF performance of a wide range of laser clad materials with a view to selecting the best performing ones for full scale testing.

Six candidate cladding materials were chosen for this test: A multi-phase Manganese Steel Variant (MMV), Martensitic Stainless Steel (MSS), TWIP Steel, NiCrBSi, Stellite 12 and Stellite 6. These were clad onto the

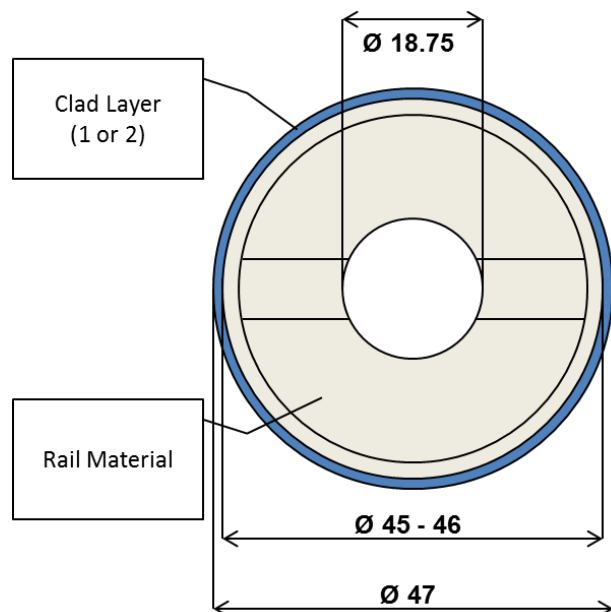

Figure 1. Schematic of a twin-disc specimen

running surface of SUROS discs machined from R260 grade rail. Materials were deposited in nominally 1 mm thick layers. 1 or 2 layers were applied, as shown in Figure 1. The width of a layer of deposit is typically 1 mm and several layers are required to cover the 10 mm wide running band of a twin-disc specimen. Once the surface of a specimen is covered and the deposit cooled the surface as a “ploughed field appearance due to the adjacent beads of deposit. After the required number of layers are applied the discs then need to be ground to achieve the final test surface finish.

2. TEST APPARATUS/METHODOLOGY

A Twin-Disc machine, shown in Figure 2a, was used in this study and is described in detail in [2]. The test samples were machined from sections of wheel and rail. A candidate material was then deposited on to the running band of each sample as shown in Figure 1.

Two types of tests were carried out; one to look at wear and the other RCF. Before each test, the samples were cleaned in an ultrasonic bath with acetone. In the wear tests the discs were run for a total of 30,000 cycles in 5,000 cycle intervals. Wear was periodically measured by weighing the discs before the test start and after each subsequent 5000 cycles. The tests were intermittently stopped in order to monitor the evolution of the wear rates of the discs over time. The wear tests were designed to characterize the traction and wear properties of the laser clad samples under dry conditions. Some of the candidate cladding materials were known to work-harden, hence will not show a stable wear rate. Therefore monitoring the evolution of the wear rate was allowed a better understanding of the wear characteristics of each material. Micro-hardness of the discs was also measured before and after each test. The RCF test samples were run for 500 cycles under dry conditions to build up plastic flow at the disc surface and initiate cracks. The discs were then run for 50,000 wet cycles [3]. The contact between the discs was wetted by dripping water at a rate of 1 drop per second onto the discs. The contact was wetted to accelerate the rolling contact fatigue process. Both types of test were performed at a slip of 1% and a maximum Hertzian contact pressure of 1500 MPa. An Ellotest B1 Eddy

Current Crack Detector was used to show the presence of any fatigue cracks in the specimens during the RCF tests. A differential eddy current probe was offset 0.3 mm from the surface of the rail disc, see Figure 2b. This induces an eddy current in the surface of the disc. Any crack or fissure in the disc surface will disturb this eddy current and these disturbances are sent back to the detector unit. The unit is calibrated with a reference disc which has a 5mm long wire eroded crack in its surface parallel to the discs axis of rotation.

Six candidate cladding materials were chosen for this test: A multi-phase Manganese Steel Variant (MMV), Martensitic Stainless Steel (MSS), TWIP Steel, NiCrBSi, Stellite 12 and Stellite 6. These were clad onto the running surface of SUROS discs machined from R260 grade rail. Clad samples were prepared with 1 or two layers deposited which gave nominal thicknesses of 1 mm and 2 mm. However, the clad discs had to be ground back to a diameter of approximately 46 mm due to an error during the grinding process. This meant that some of the discs with two layer may not still have had two full layers of clad left on them after grinding.

260 Grade material was also tested as a baseline to check that it could be used as a direct repair of rail track. Two types of reference disc were also tested; these were an un-clad 260 grade rail disc, and a disc machined entirely from MMV steel. The testing of a solid MMV disc allowed a comparison of performance between a rail that was manufactured entirely out of MMV and MMV being used just as a cladding on the surface of standard grade rail. The Stellite material comes in different grades, and two variants: Stellite 12 and Stellite 6 were both tested in this work. Stellite 6 was tested in [1] and was found to show superior wear and RCF resistance. The microstructure of Stellite 12 is thought to promote greater RCF resistance over Stellite 6. It was noted however, during manufacture of the discs that Stellite 12 is much harder to clad than Stellite 6. It was therefore decided to test both materials in this work to see if there were any tribological benefits to using Stellite 12 over Stellite 6.

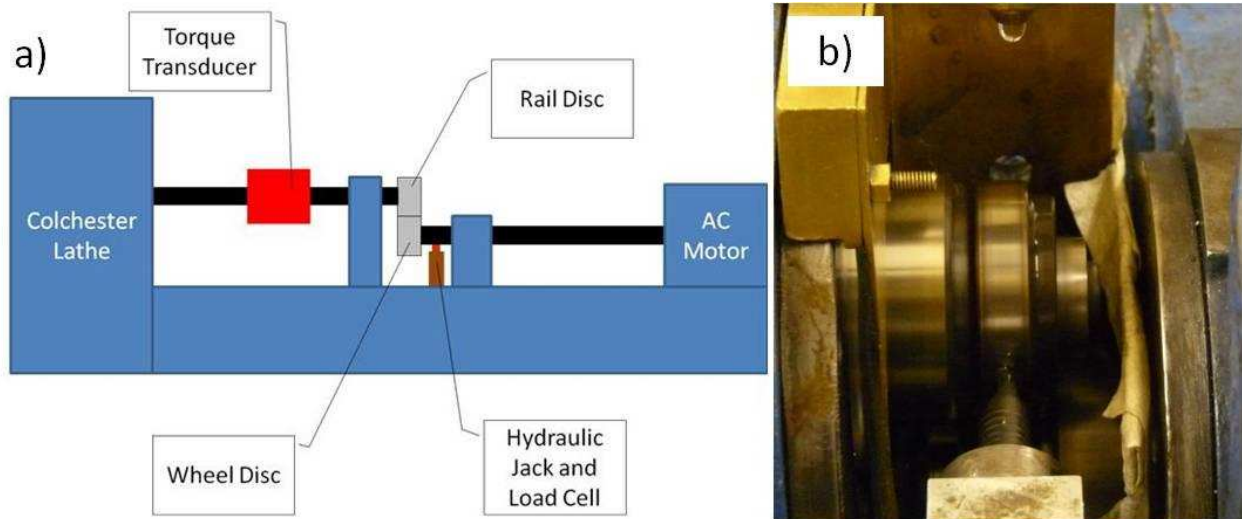

Figure 2. a) Schematic of SUROS machine b) Eddy current probe secured close to rail disc

This work follows on from previous tests [1] where much shorter duration wear tests were performed. Results of previous wear testing were found to be inconclusive and it was decided that the short test duration had not been enough to show steady state wear of the samples. The current wear tests were therefore extended to 30,000 cycles to allow the samples to reach a steady state (i.e. fully developed work hardening, ratchetting or shakedown) which would be expected in around 17500 cycles for a normal grade 240Hv rail steel [4].

3. RESULTS

3.1 Traction

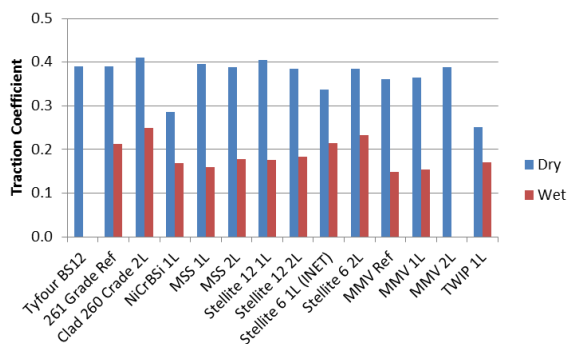

Figure 3. Average traction coefficients for each cladding in both dry and wet conditions. Ref indicates reference, 1L indicates 1 clad layer and 2L indicates 2 clad layers

Figure 3 shows average traction results for each of the different claddings compared to an unclad reference

260 grade rail disc. The dry traction data was taken from the wear tests and the wet data taken from the RCF tests.

3.2 Wear Tests

Figure 4 shows the evolution of the wear rate of the rail discs. The results have been compared to tests done by Tyfour et al. [6] in which the wear rate evolution of BS11 rail rolling against R8A Wheel steel was measured using the SUROS machine under the same conditions as those used for these tests.

Figure 4 shows that there is a wide variation in the wear behavior of the rail discs. There seems to be 3 distinct groups which the discs can be put into:

- Group 1, where the wear rate stays below 5 $\mu\text{g}/\text{cycle}$. This group includes both the 1 and 2 layer MSS and Stellite 12 discs and the Stellite 6 2 layer disc.
- Group 2, where the wear rate is between 5 and 15 $\mu\text{g}/\text{cycle}$. This group includes both the 1 and 2 layer MMV, the Stellite 6 1 layer disc, the 260 grade reference disc, the clad 2 layer 260 grade disc and the NiCrBSi disc.
- Group 3, where the wear rate remains mainly above 15 $\mu\text{g}/\text{cycle}$. This group includes the MMV reference disc, the Tyfour BS11 disc [6] and the TWIP disc

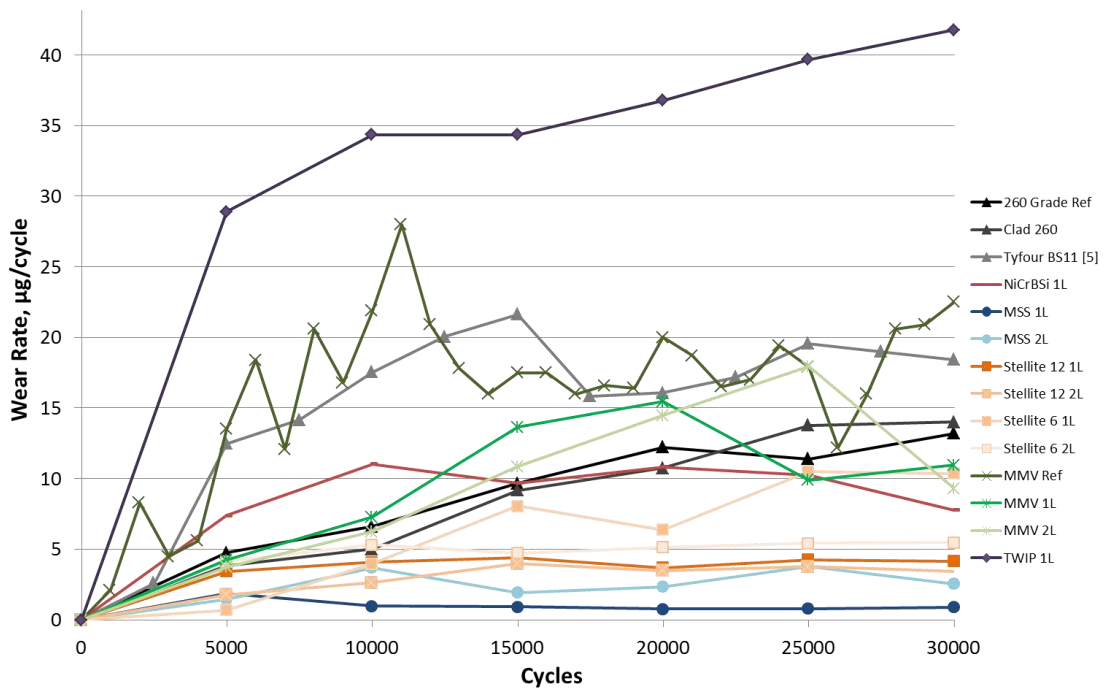

Figure 4. Wear rate evolution of the rail discs under dry conditions

The hardness of each rail disc was compared against the wear rate of the wheel disc that it was tested against as shown in Figure 5. Each disc was sectioned and polished after testing and a Vickers

Micro-Hardness case measurement taken close to the disc surface. Figure 6 shows the correlation between average rail disc hardness and rail disc wear rate.

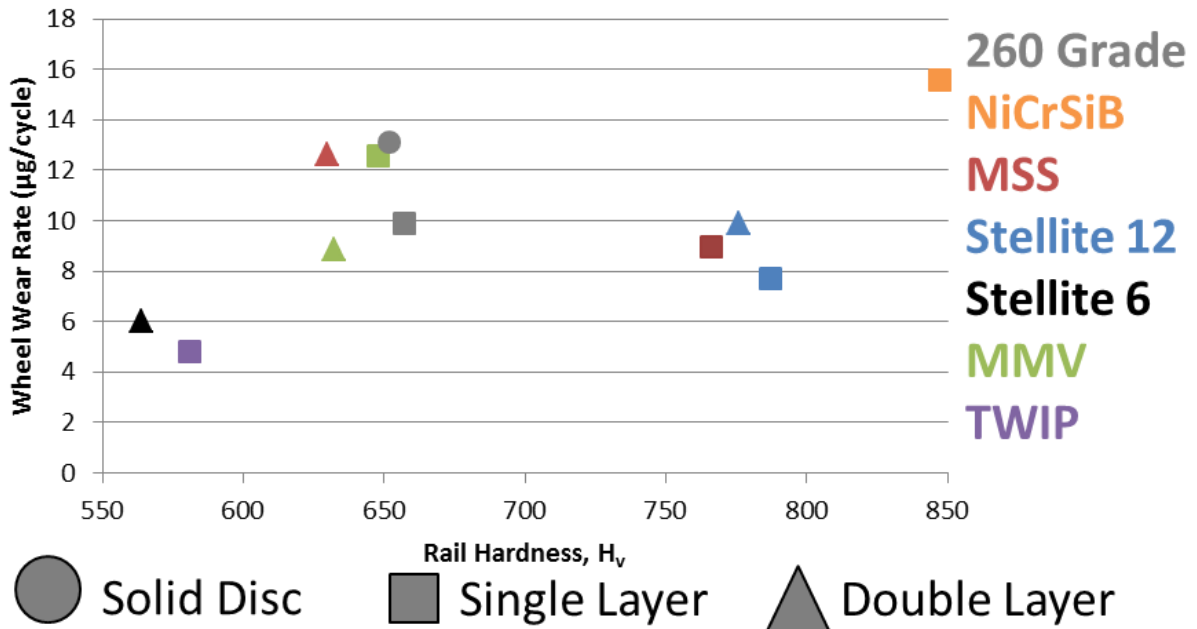

Figure 5. Average wear rate of wheel discs in dry conditions plotted against the end-of-test rail disc hardness, colour of data point indicates material/clad type, shape indicates number of layers

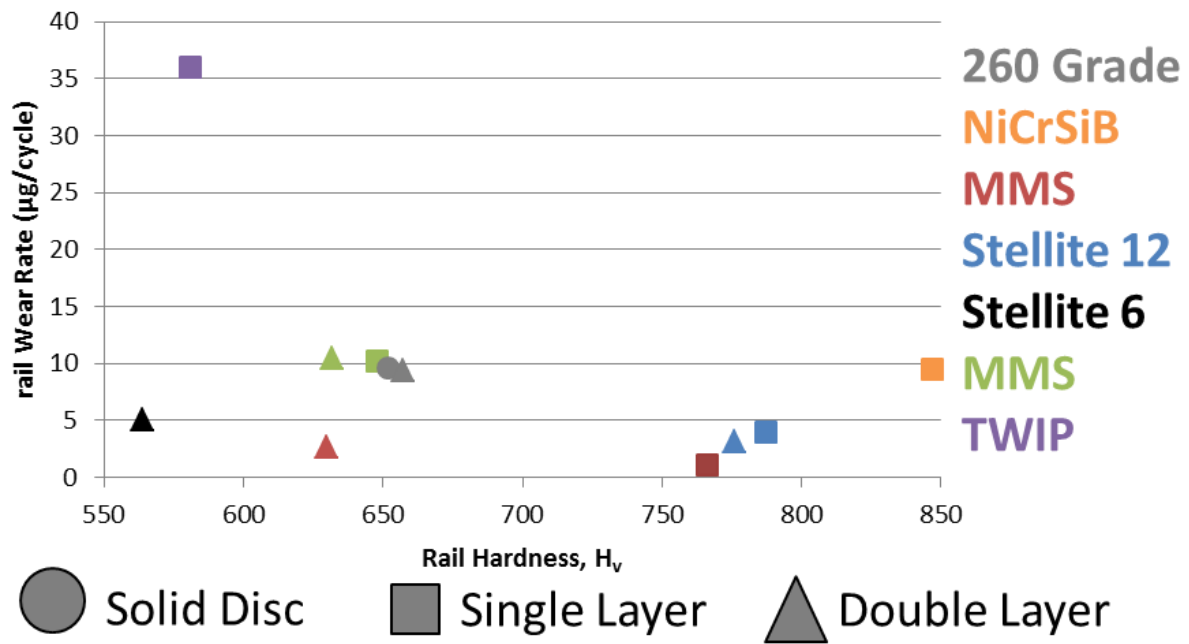

Figure 6. Average wear rate of rail discs in dry conditions plotted against the average rail disc hardness, colour of data point indicates material/clad type, shape indicates number of layers

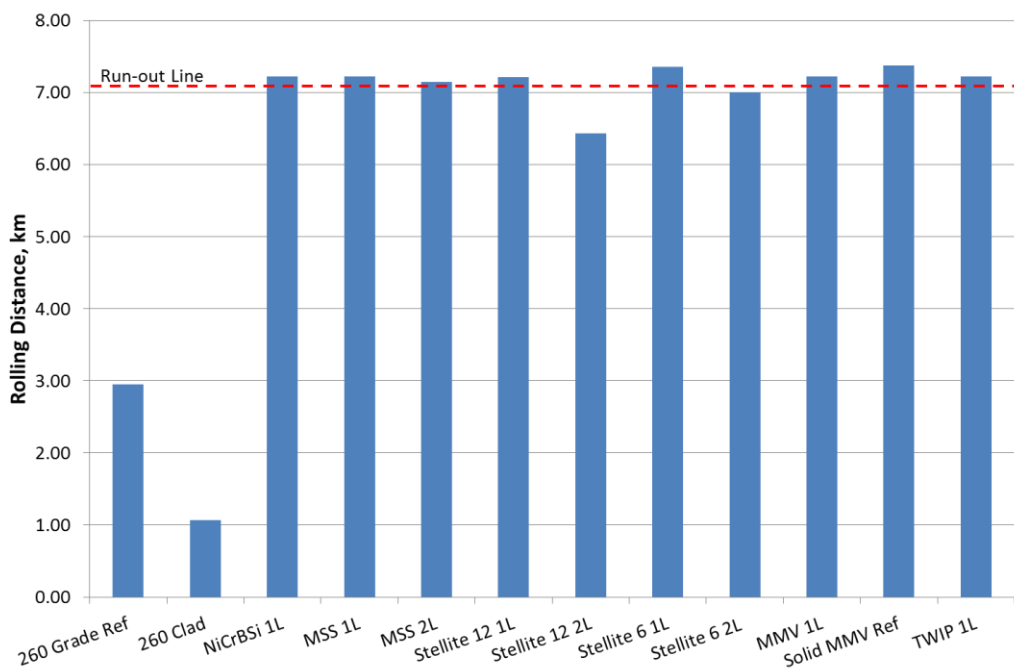

Figure 7. Results of RCF tests. RCF life is expressed in terms of rolling distance

3.3 RCF TESTS

The RCF initiation life of each disc is quoted in rolling distance and results are shown in Figure 7. Tests were limited to 50,000 cycles (~7 km depending on disc size) for practicality reasons. Tests which ran beyond 7.14 km without failure (as defined by the eddy

current method, see section 2) were stopped and recorded as run-out tests. 7.14 km equates to approximately 50,000 cycles for a standard 47 mm diameter disc.

Figure 7 shows that none of the clad samples showed any signs of RCF initiation and all ran out to the

50,000 cycle limit. (Note: the Stellite 12 1L sample had a reduced diameter, however still completed 50,000 cycles). The RCF initiation life of the reference sample was 3 km showing that all clad samples show superior RCF initiation resistance compared to standard 260 Grade rail. The best performing samples from the wear tests (MSS, Stellite 12 & 6) were tested for a further 50,000 cycles with none showing any signs of crack initiation after 100,000 cycles.

4. DISCUSSION

4.1 Traction

In dry conditions the majority of discs showed a traction coefficient above 0.35 with the two exceptions being the 1 layer NiCrBSi and the 1 layer TWIP samples both giving coefficients of 0.29 and 0.25 respectively. In wet conditions all of the discs gave values within a similar range. Apart from the NiCrBSi and TWIP discs none of the traction coefficients of the clad discs deviated far from the 260 Grade reference sample, indicating that in the field MSS, Stellite 12 and MMV clads would give similar adhesion levels to un-clad 260 Grade rail. Interestingly, in dry conditions, the 2 layer clad 260 and MMV samples show higher traction than their un-clad reference counterparts.

4.2 Wear

The best performing cladding in this test was 1 layer MSS where the wear rate remained consistently below $1 \mu\text{g}/\text{cycle}$. The discs in group 1 (see Section 3.2) seemed to get to a steady state of wear relatively quickly (within 5000 cycles) where upon there was little variation in the wear rate after this point. Most of the discs in group 2 reached a maximum wear rate after which a lower cyclical wear rate was seen. However, the 260 Grade reference sample and the clad 260 sample both seemed to show gradually increasing wear rates. The worst performing disc, in terms of wear, was the 1 layer TWIP sample which showed a wear rate far in excess of any other sample tested. The wear rate of the TWIP disc also increased throughout the test. It was observed that there is a large degree of plastic deformation on the surface of the TWIP sample. What is not easy to determine here is whereabouts the wear rate of each sample lies on the curve representing the life of typical tribological components as shown in Figure 8 [5].

Due to the scaled nature of the tests and the range of mechanical properties of each of the materials tested it is difficult to say whereabouts 30,000 test cycles

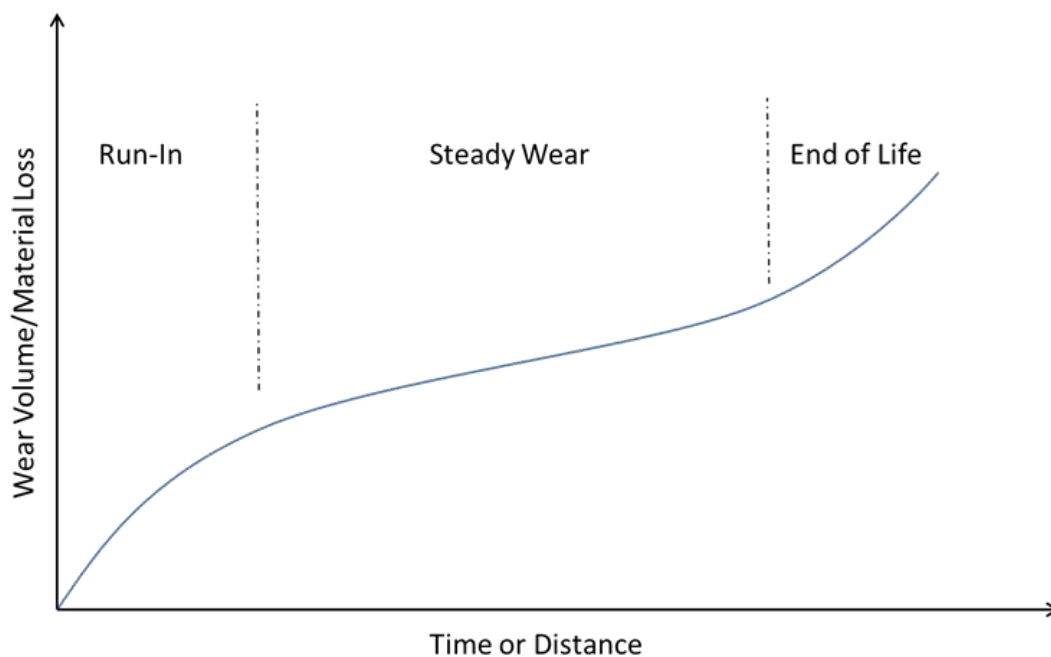

Figure 8. Typical wear behaviour over the lifetime of a component [5]

places each of the samples on the curve shown in figure 8. It is possible that the samples in group 1 “Steady wear rate” may be in the “Steady Wear” regime as per Figure 8. It is also possible that those materials in group 1 do not exhibit typical wear behavior and instead transition straight to “Steady Wear”. Thus materials in Groups 2 and 3 which show increasing wear behavior may still be in the “Run-In” phase and may potentially show steady wear if the tests were continued beyond 30,000 cycles. In this work wear has been expressed as a rate i.e. total mass loss divided by the number of cycles ($\mu\text{g}/\text{cycle}$). For the values of wear rate expressed in Table 1 it is easy to assume a linear amount of material loss over a given time frame. However, as shown in Figure 4, and discussed in great detail in [6], the wear rate is constantly changing as different wear mechanisms come to dominate due to shifts in wear transition. With reference to Figure 4 it seems as if 30,000 cycles was sufficient for most of the samples to transition into the “steady wear” regime as depicted in Figure 8. What can be definitely concluded, however, is that the materials in Group 1 show wear rates far lower than any other of the materials that even if the group 2 and 3 materials were to eventually reach steady wear the differences in cumulative material loss between the groups would be very large. It can be noticed from Figure 4 how the 1 layer Stellite 6 sample does not wear similar to its 2 layer counterpart and thus is in group 2 as opposed to group 1. It is not clear why this is, however, the 1 and 2 layer Stellite 6 samples were manufactured by different methods. The 1 layer sample was clad from a pre-machined SUROS disc whereas the 2 layer sample was manufactured by cladding a length of 260 grade cylinder which was then manufactured into SUROS discs. Only 2 of the samples used in this project were manufactured using this second method. All others were manufactured by cladding pre-machined SUROS discs. It should be noted that the chart in Figure 8 is representative of many tribological applications. However, it may not truly represent in-service conditions and is only used to support observations in these tests.

Table 1 shows the average (overall) wear rates for the wheel and rail discs under dry conditions. The wear

rates of each of the clad discs is also expressed as a percentage of the standard 260 Grade reference disc. In Table 1 any wear rate which was in excess of either the reference (260 Grade) wheel or rail, i.e. 100% or greater, has been highlighted red. Any wear rate which is less than the reference is highlighted green indicating good wear performance. Wear rates which are less than 50% of the reference case are highlighted light green indicating superior wear performance. Six of the rail samples tested are in the good/superior wear category. These are: 260 Grade Clad, NiCrBSi 1L, both MSS samples, both Stellite 12 samples and both Stellite 6 samples. Of those 6, only the MSS and Stellite 12 samples showed superior wear performance. In all but one of the cases tested the wheel wear rate was classified as good/superior with Stellite 6 and TWIP, both 1 layer, showing superior wheel wear rates.

Table 1. Twin-disc wear rates

Clad	Layers	Dry Wear Rate		Dry Wear Rate	
		Overall Wear Rate	Percentage of 260 Ref	W	R
Tyfour BS11 [4]		32.10	16.21	244%	168%
260 Grade Ref	0	13.14	9.64	-	-
260 Grade Clad	2	9.92	9.42	75%	98%
NiCrBSi 1L	1	15.60	9.49	119%	98%
MSS 1L	1	8.96	1.04	68%	11%
MSS 2L	2	12.65	2.63	96%	27%
Stellite 12 1L	1	7.72	4.00	59%	41%
Stellite 12 2L	2	9.87	3.17	75%	33%
Stellite 6 1L	1	4.51	6.66	34%	69%
Stellite 6 2L	2	6.00	5.03	46%	52%
MMV Ref	0	7.82	16.41	59%	170%
MMV 1L	1	12.55	10.25	96%	106%
MMV 2L	2	8.87	10.42	67%	108%
TWIP 1L	1	4.81	35.97	37%	373%

It is not clear why the number of layers of clad should make a difference to the wear rate of a particular clad specimen as from a tribological point of view the interface is still made of the same composition of materials on the surfaces. However, the cooling rates experienced during manufacture of the 1 and 2 layer samples could be different resulting in differences in microstructure. This will only become clear however, when sub-surface inspection is done. The effective stiffness of the samples will also be effected by the thickness of the clad layer on top of the substrate but how this would combine with other factors such as: surface topography, hardness etc., to effect the overall wear rate is unclear.

The highest average wear rate was shown for the TWIP rail disc in dry conditions. Excluding the TWIP sample the highest wear rate in dry conditions was seen with the solid MMV sample “MMV Ref” with a wear rate of 16.41 $\mu\text{g}/\text{cycle}$ compared to 9.64 $\mu\text{g}/\text{cycle}$ with the, Un-clad, 260 grade reference disc. The clad MMV samples, however, showed a much lower wear rate than the solid MMV disc at 10.25 and 10.42 $\mu\text{g}/\text{cycle}$ for both the 1 layer and 2 layered samples respectively. These wear rates are also in line with the 260 Grade reference sample. The best performing discs in wet conditions were the MSS and Stellite 12 samples with the lowest wear rate shown by the 1 layer MSS sample at 1.04 $\mu\text{g}/\text{cycle}$. This is almost 10% of the wear rate of the reference sample. The 2 layer MSS sample showed a higher wear rate at 2.63 $\mu\text{g}/\text{cycle}$. The Stellite 12 samples were the second best performers with wear rates of 4.00 and 3.17 $\mu\text{g}/\text{cycle}$ for the 1 and 2 layer samples respectively. The third best performers were the Stellite 6 samples which both wore more than the Stellite 12 samples with wear rates of 6.66 and 5.03 $\mu\text{g}/\text{cycle}$ for the 1 and 2 layer samples respectively. Even though the Stellite 6 wear rates were higher than Stellite 12 they were still lower than the reference wear rate for un-clad 260. Wheel wear rates were also reduced with the majority of the other clad samples.

260 Grade material was also clad onto a 260 grade disc to represent a direct repair to a damaged rail and to explore how much the results are dependent on the cladding material and how much on the heating and microstructural effect of the cladding process itself. The wear rate of this rail sample was similar to the reference case, however, the wheel wear rate was reduced. It can therefore be said that for the case of 260 grade rail material the cladding process does not necessarily affect rail wear behavior.

Figure 5 shows a comparison between the mean rail disc hardness and the wear rate of the wheel disc which it was tested against. No correlation between rail hardness and wheel wear can be seen in the data. However, only one of the samples showed a higher wheel wear rate than the reference case; that being the NiCrBSi sample. This suggests that in the

majority of cases if a premium/harder material were to be clad onto a standard 260 Grade rail this would not adversely affect the wheel wear rate. In all but one of the claddings tested the wheel wear rate was either unaffected or lower than in the baseline 260 Grade case. This is also shown in Table 1.

It should be noted that even though twin-disc testing is a generally accepted small scale test method for testing friction and wear of wheel/rail materials the results yielded cannot be translated directly to the full scale. For example in the field new rails show higher wear rates due to non-conformal contacts between the wheel and rail. The wear rate then reaches a steady state as the contacts conform and the softer decarburised layer is worn from the rail. Such effect cannot be replicated in twin-disc testing. As such it is the relative ranking of the wear rates which need to be noted rather than the absolute wear rates.

5.3 RCF

With the 260 Grade reference disc the gates of the eddy current detector were triggered at 2.9 km. Failure in the region of 2.5 – 3.0 km would be expected of a 260 Grade disc tested under these conditions [3]. The clad 2 layer 260 grade disc ran for the shortest distance and underperformed the reference disc with a running duration of only 1.07 km. This was almost a third of the benchmark distance. The only other clad disc not to run-out was the 2 layer Stellite 12 sample which triggered the gates of the eddy current detector at 6.43 km, however, this still represents an endurance of 222% of the 260 Grade disc. Post sectioning of these samples may reveal the cause of failure and whether any modifications to the deposition conditions could improve the integrity of the deposit. All other samples tested did not show any failure and the tests were stopped at the 7.0 km mark due to project time constraints. Therefore these discs potentially could have run much further than 7.0 km.

5.4 Run-out RCF Tests

To investigate further the three best performing claddings from the wear tests, new MSS, Stellite 12 and Stellite 6 discs, were tested with the aim of

running beyond 7.0 km. However, during these run-out tests the MSS and Stellite 12 discs showed signs of failure early on in the tests (below 1 km) and detailed metallographic examination is required to establish whether the particular samples tested had sub-surface flaws that initiated the fatigue cracks detected by the eddy current system. It was therefore decided to run the discs for a total of 14.0 km which was twice the distance used in the RCF tests. The Stellite 6 sample however, showed no early signs of failure and did not trigger the eddy current detector until 11.9 km. This is 410% of the reference sample. It was decided however, to continue the test up to the 14.0 km limit so that the Stellite 6 sample was comparable to the MSS and Stellite 12 run-out samples. When the discs are sectioned any cracks in the discs will become obvious and can then be compared to any cracks in the RCF samples which ran to 7.0 km.

6. CONCLUSIONS

Testing of laser clad twin-disc samples has been carried out and the following conclusions can be made:

- MSS and Stellite 12 samples wore at a rate of less than 50% of the reference 260 Grade disc. Stellite 6 also shows wear rates of less than 70% of a 260 Grade disc.
- Testing also shows that the use of harder deposits on top of the rail does not increase wheel wear rates and in most cases decreased it.
- All of the clad samples showed superior RCF initiation resistance compared to the reference sample, with clad samples showing life to RCF initiation of at least 240% of the 260 grade sample.
- MSS and Stellite samples showed RCF initiation lives of at least 420% of the reference sample.
- These results show that for the conditions tested cladding premium alloys on to standard 260 grade rail has the potential to vastly increase RCF initiation life.
- Sub-surface inspection of the clad samples showed no delamination of the clad from the 260 Grade base material.

The three best performing cladding materials based on wear and RCF performance were MSS, Stellite 6 and Stellite 12.

ACKNOWLEDGEMENTS

The authors would like to acknowledge like to acknowledge The Technology Strategy Board (TSB, now reformed as Innovate UK) who provided funding to support this work (project no. 17742-125255)

REFERENCES

- [1] S. R. Lewis, R. Lewis, D. I. Fletcher, 2015. Assessment of laser cladding as an option for repairing/enhancing rails. *Wear*, [Article In Press]
- [2] D.I. Fletcher, J.H. Beynon, 2000. Development of a machine for closely controlled rolling contact fatigue and wear testing. *Journal of Testing and Evaluation*, Vol. 28 (4), pp. 267–275
- [3] W.R. Tyfour, J.H. Beynon, A. Kapoor, 1996. Deterioration of rolling contact fatigue life of perlitic rail steel due to dry – wet rolling – sliding line contact. *Wear*, Vol. 196, pp 255-265
- [4] W. R. Tyfour, J.H. Beynon, A. Kapoor, 1995. The steady state wear behavior of pearlitic rail steel under dry rolling-sliding contact conditions. *Wear*, Vol. 180 79-89
- [5] J. Williams., 2005. *Engineering Tribology*, New York: Cambridge University Press.
- [6] P.J. Blau, 2014. How common is the steady-state? The implications of wear transitions for materials selection and design, *Wear*, <http://dx.doi.org/10.1016/j.wear.2014.11.018i>