



Durability problems of 20th century reinforced concrete heritage structures and their restorations

By: Tekeste Teshome Gebregziabhier

Supervisor: Pere Roca I Fabregat

Barcelona, July 2008

Erasmus Mundus Programme: ADVANCED MASTERS IN STRUCTURAL ANALYSIS OF MONUMENTS AND HISTORICAL CONSTRUCTIONS
Consortium Institutions: UNIVERSITY OF MINHO, PORTUGAL
CZECH TECHNICAL UNIVERSITY IN PRAGUE, CZECH REPUBLIC
UNIVERSITY OF PADOVA, ITALY
TECHNICAL UNIVERSITY OF CATALONIA, SPAIN
Satellite Participant: INSTITUTE OF THEORETICAL AND APPLIED MECHANICS, CZECH REPUBLIC



Acknowledgement

I am hereby to acknowledge the continuous support and help I got from my supervisor Prof. Pere Roca I Fabregat, who is always positive and helpful for his students.

I would like also to thank Ms. Kidmealem Getachew, my best friend, for her continuous moral support and advice from the beginning to the end of this master's course.

Last but not least, I would like to thank all the students of the "Advanced Masters in Structural Analysis of Monuments and Historical Constructions, SAHC", the first edition 2007-2008, for their experience sharing and cooperation in the day to day life here in Europe.

Tekeste Teshome Gebregziabhier

Abstract

This paper presents a study on the 20th century reinforced concrete heritage structures, their durability problems, their repair and restorations according to the conservation principles of heritage structures and the repair principles of reinforced concrete structures. The common problems on reinforced concrete heritage structures such as reinforcement corrosion, alkali aggregate reaction, freeze thaw and overloading of the structure are identified and their respective repair methods presented. Even though so many causes exist that contribute for durability problems of reinforced concrete heritage structures, the mentioned ones are the most common appearing in most cases.

The evaluation methods and steps to be followed in determining/assessing the conditions of the deteriorated/distressed reinforced concrete heritage structures and their safety levels are briefly presented. The factors to be considered in assessing the compatibility of repair materials and methods to the old concrete and the current practice of using new materials and techniques for repair of reinforced concrete heritages which are showing long term performance problems are also included.

Case studies of typical reinforced concrete heritages already repaired and strengthened, and damage identification of Palau Blaugrana in Barcelona are also presented to strengthen the previous parts of the paper.

The extent or possibility to which the available repair and strengthening methods fit for reinforced concrete heritage structures are assessed based on the principles for the repair of reinforced concrete structures and the conservation principles of heritage structures from recommendations. The new repair materials and methods are weighted with conservation principles of heritages. In addition, general proposals on the repairs and restorations on reinforced concrete heritage structures are made.

TABLE OF CONTENTS

1. Introduction.....	6
1.1 Motivation.....	6
1.2 Objectives	7
1.3 Methodology.....	8
1.4 Organization of the document.....	8
2. Common problems of Reinforced concrete Heritage Structures	9
2.1 History of Reinforced concrete.....	9
2.2 Reinforced concrete heritages	9
2.2.1 Reinforced concrete heritage typologies	11
2.3 Causes of reinforced concrete deterioration	14
2.3 Major signs of concrete deterioration	15
2.4 Corrosion of reinforcement.....	19
2.4.1 Factors affecting corrosion of steel in concrete	21
2.4.2 Mechanisms of corrosion.....	23
2.4.3 Forms of corrosion.....	24
2.4.4 Chloride induced reinforcement corrosion.....	24
2.4.5 Carbonation induced reinforcement corrosion.....	28
2.4.6 Condition evaluation of corrosion	31
2.4.7 Consequences of corrosion.....	33
2.4.8 Rehabilitation of corrosion damaged reinforced concrete structures	34
2.5 Alkali aggregate reaction.....	41
2.5.1 Alkali silica reaction (ASR)	42
2.5.2 Identification of ASR.....	43
2.5.3 Symptoms or indications of ASR.....	44
2.5.4 Mitigating ASR in existing concrete	45
2.6 Freeze thaw in concrete.....	46
2.6.1 Rehabilitation of freeze thaw damages	48
2.7 Overloading of Reinforced concrete Heritages	48
2.7.1 Mitigation of overloading.....	49
3. Planning for reinforced concrete heritages/structures repair, restoration and preservation	50
3.1 Introduction	50
3.2 Condition Survey.....	51
3.3 Laboratory investigation.....	52

3.4 Nondestructive Testing (NDT).....	53
3.5 Minor or partially destructive testing.....	53
4 Methods for repair and Rehabilitation of reinforced concrete heritages/structures	56
4.1 Introduction	56
4.2 Objectives repair or strengthening	57
4.3 Repair and strengthening methods	58
4.3.1 Judicious neglect or do nothing	59
4.3.2 Repair of cracking.....	59
4.3.3 Repair of spalling.....	64
4.3.4 Repair of overloading and deflection (Strengthening and upgrading)	66
4.3.5 Seismic upgrading using shear walls	74
4.3.6 Cathodic Protection and protective surface treatments.....	75
5. Compatibility of repair materials	76
5.1 Introduction	76
5.2 Patch Repairs.....	76
5.2.1 Dimensional compatibility	77
5.2.2 Bond compatibility and durability	78
5.2.3 Structural and mechanical compatibility	78
5.2.4 Electrochemical compatibility	80
5.2.5 Permeability compatibility	80
5.2.6 Chemical compatibility.....	80
5.3 FRP and protective surface treatments.....	80
5.4 Corrosion Protection techniques	81
6 Principles for the repair of Reinforced Concrete Structures	82
6.1 Introduction	82
6.2 Defects in reinforced concrete heritage	83
6.3 Options, principles and methods.....	84
6.3.1 Principles for the repair and protection of damages to the concrete	84
6.3.2 Principles for the repair and protection of damages due to reinforcement corrosion	86
7 Repair and strengthening Proposals	87
7.1 Introduction	87
1.2 Possibility of use of conservation principles.....	88
1.2.1 Conservation principles from recommendations	88
1.2.2 Acceptability or extent of repair and strengthening methods.....	91

1.3 New materials and techniques	95
1.4 General proposals	97
8 Case studies	100
8.1 Unity temple: Structural repair and Conservation [24]	100
8.2 Rehabilitation and strengthening of an old industrial mill reinforced concrete building at Overijse, Belgium [25]	103
8.3 Cathodic protection repairs in multi-storey buildings on the Dutch coast[7].....	108
8.4 Palau Blaugrana.....	111
9. Conclusions	115

1. INTRODUCTION

“Heritage is our legacy from the past, what we live with today, and what we pass on to future generations. Our cultural and natural heritages are both irreplaceable sources of life and inspiration. What makes the concept of World Heritage exceptional is its universal application. World Heritage sites belong to all the peoples of the world, irrespective of the territory on which they are located.” UNESCO

In previous centuries, most of the historical heritage structures were built with masonry and wooden/timber structures. But after the advent of reinforced concrete at the late 19th and early 20th centuries, most structures were built with reinforced concrete, of which some of the important structures are nowadays considered as heritages. Over the past decades, there has been a growing awareness in the world of the importance of preserving our heritage. In turn, this has caused more reinforced concrete structures to fall within the jurisdiction of the heritage sector.

1.1 Motivation

The advent of reinforced concrete at the late 19th and early 20th century urges the massive construction of reinforced concrete structures such as buildings, bridges and other structures, that replaces the previous masonry and timber structures. This is the cause of modernization of the late 19th and 20th century reinforced concrete structures. The more advance in production of construction materials and architectural concepts cause more reinforced concrete structures to be built in this era. But as the passage of time shows, this reinforced concrete material that once beleived to be eternal shows durability problems due to deterioration/distress of the structure on the long term.

Some of these reinforced concrete structures built at that time are nowadays considered to be heritage structures by organizations like UNESCO . Over the past decades, there has been a growing awareness in the world of the importance of preserving our heritage structures. In turn, this has caused more reinforced concrete structures to fall within the classifications of the heritage sector.

Due to the deterioration/distress of these reinforced concrete heritage structures, their repair and maintenance is becoming indespensible to prolong the service life of the structures. The repair and strengthening of these reinforced concrete heritage structures are posing challenges to conservation professionals/restorers these days. It is a common practice to repair these structures based on past experience, and with the new materials and techniques availabe today.

The need for the preparation of this paper is due to these increasing number of reinforced concrete structures being regarded as heritage structures and the most common durability and strength problems they are facing. This report intends to identify some of the most common deterioration/distress problems of reinforced concrete heritage structures and their repair methods, the extent the current repair methods can be applied based on the existing principles of conservation of heritage structures and repair principles of reinforced concrete structures.

The paper also proposes the compatibility between the available repair methods with the existing conservation principles of heritage structures.

1.2 Objectives

The main objectives of this paper are the identification of the common durability problems in reinforced concrete heritage structures and their repair and restoration methods, and the possibility of using available conservation principles of heritage structures and repair principles reinforced concrete structures in reinforced concrete heritage structures.

Specific objectives:

- State of the art of the most common durability problems of reinforced concrete structures/heritages
- To search for traditional and modern methods of repair, strengthening and upgrading of the reinforced concrete structures/ heritages
- The possibility of extension of the European Standard EN1504 (Repair Principles of reinforced concrete structures) to reinforced concrete heritage structures.
- The possibility of using conservation principles(such as ICOMOS, ISCARSAH) of heritage structures to reinforced concrete structures/heritages
- Problems of new repair materials and techniques against conservation principles
- Proposals of the writer of the paper about the repair and strengthening of reinforced concrete heritages.
- Analysis of case studies on damage identification and repair
- Conclusions

Partial Objectives:

Sites visits to reinforced concrete structures in Barcelona

- Palau Blaugrana (thin shell reinforced concrete structure)

1.3 Methodology

This paper presents the problems of reinforced concrete heritage structures and the challenges in their repair methods as compiled from books, journals and internet sources that are believed to be common in modern reinforced concrete structures. There is no absolute document referred about reinforced concrete heritage structures. Reference is made on reinforced concrete structures and supported by principles of conservation of heritage structures from recommendations and repair principles of reinforced concrete structures from the European Standard EN1504.

1.4 Organization of the document

The organization of this report is outlined as below:

Chapter 1 Motivation and objectives of this thesis topic or paper

Chapter 2 Introduction about reinforced concrete heritage structures, their typologies and their similarity with modern reinforced concrete structures. Common problems of reinforced concrete problems are outlined, which are also believed to occur in reinforced concrete heritage structures.

Chapter 3 Planning for reinforced concrete structures repair, restoration and preservation, which are also to be followed in heritage structures are discussed.

Chapter 4 Repair, strengthening and upgrading of reinforced concrete heritages, which are commonly used in the past and nowadays, new techniques and repair materials common these days.

Chapter 5 Compatibility between the repair materials and techniques with the substrate deteriorated/distressed reinforced concrete fabric.

Chapter 6 Possibility of extending the repair principles of reinforced concrete structures (EN1504) to reinforced concrete heritage structures.

Chapter 7 Proposals on the repair and strengthening of reinforced concrete heritage structures based on repair principles of reinforced concrete structures (EN1504) and conservation principles of heritage structures to reinforced concrete heritage structures.

Chapter 8 Analysis of case studies on problems and repair of structures

Chapter 9 Conclusions

2. COMMON PROBLEMS OF REINFORCED CONCRETE HERITAGE STRUCTURES

2.1 History of Reinforced concrete

Reinforced concrete is comparatively a new or recent construction material from the late 19th and early 20th century, and its invention is usually attributed to Joseph-Louis Lambot in 1848. Joseph Monier, a French gardener, patented a design for reinforced garden tubs in 1867, and later patented reinforced concrete beams and posts for railway and road guardrails. The major developments of reinforced concrete have taken place since the year 1900 [34].

2.2 Reinforced concrete heritages

Reinforced concrete heritages are those structures which are built at the end of the 19th century and at the beginning of the 20th century. These structures are designed and constructed by different architects and designers around the world across the 19th and 20th centuries. Some of them are constructed to commemorate a person or an event in the past, some to show the technology and modernization of the era and others for another services and reasons. They are nowadays classified as heritages due to the special nature with respect to other similar structures. Their classification under heritage structures is effected by organizations such as UNESCO.

Reinforced concrete is a new construction material, once believed an eternal construction material. But as the passage of time shows, it is facing major problems in strength and durability as the structures were/are exposed to various external or internal aggressions that would lead to the deterioration of the concrete structure, which in turn necessitates either their maintenance work or even sometimes replacement of the existing structural concrete.

The repair of reinforced concrete heritages is posing challenges to conservation engineers since there are no special techniques developed for them. There is very little information about the repair and strengthening of the concrete heritage structures, which lead to the use of modern techniques that are used in modern structures. Today there are lots of techniques for repair and strengthening of newly built reinforced concrete structures, which are invariably used in reinforced concrete heritages. This study needs further development in the future considering different cases to reinforced concrete heritage structures.

But there still exist a paradox in the difference between modern and heritage reinforced concrete heritage structures. It is generally can be told that since reinforced concrete is a comparatively new construction material (~100 years old), it is reasonable to tell that most of

the problems of the modern reinforced concrete structures also exist in historic reinforced concrete structures. This further show the possibility of using testing methods, repair and strengthening methods etc of modern concrete to be used for heritage reinforced concrete heritages with in certain limitations until further developments.

It is worthwhile to mention that most of the reinforced concrete that are classified nowadays as heritage structures are also of the 20th century reinforced concrete structures. Thus, reinforced concrete structures will share common properties whether they are modern or heritage structures. This does not mean that there is no difference between reinforced concrete structures at the beginning or mid of 20th century and now; it is clear that a lot of modifications of the reinforced concrete materials (cement, steel, aggregate, additives etc) are made since then. In addition, the environmental conditions are changing rapidly from time to time increasing the ingress of aggressive agents in to the reinforced concrete structures.

The big controversy still now is what makes ordinary reinforced concrete structures to be regarded as heritage structures? A bridge giving a service now may be regarded as a heritage someday. Nowadays so many bridges are also regarded as reinforced concrete heritages.

The following questions are not still answered about reinforced concrete heritages:

- Which type of structures shall be categorized as reinforced concrete heritages?
- What are the criterions to call them heritage? For example, The Unity Temple in figure 2.1 is constructed in 1905-1908, but the Sydney Opera House (figure 2.2.a) is completed 1973(relatively newer), but both of them are heritages.
- Which type of intervention techniques are best for their restoration and repair?
- Other factors not listed here

What are the key points that make reinforced concrete structures to be regarded as heritage structures?

- If a special thing or event was related in the past to their construction
- If the monument is built to commemorate a person or an important event
- If the structure is from the beginning of the 20th century and it is still in service
- If the structure survived typical historical event that damages other structures
- Other factors

In this paper the most common problems of heritage reinforced concrete structures and their causes, the available testing methods and identification, the way the deteriorated structures can be repaired and maintained, the methods used in the strengthening of these heritages,

principles for repair and strengthening, case studies, and some recommendations and conclusions are drawn for the 20th C reinforced concrete heritage structures based on the recommendations of modern reinforced concrete structures.

2.2.1 Reinforced concrete heritage typologies

There are various types of reinforced concrete heritage structures: shell and dome structures, bridges, cathedrals, buildings, towers, landmarks etc. These structures are designed and constructed by different architects around the world across the 19th and 20th centuries. Some of them are constructed to commemorate a person or an event in the past, some to show the technology and modernization of the era and the others for another services and reasons.

Heritage buildings: buildings are used or intended for supporting or sheltering any use or continuous occupancy. The unity temple in figure 2.1 was constructed to give service as a chapel and public gatherings at the time.



Figure 2.1 the Unity temple in Oak Park, Illinois (built between 1905 and 1908) [34]

Shell and dome structures: shells are used as roof structures in buildings. The use of thin shell structure allows wide areas to be spanned without the use of internal supports giving an open, unobstructed interior. Modern thin concrete shells, which began to appear in the 1920s, are made from thin steel reinforced concrete, and in many cases lack any ribs or additional reinforcing structures, relying wholly on the shell structure itself.



Figure 2.2 a) The Sydney Opera House is one of the world's most recognizable opera houses and landmarks (completed in 1973) [34]; b) Lotus temple in New Delhi, India completed in 1986[34]

Statues and landmarks: they are constructed to represent a person or historical event or to represent some facts in the past or to express religion. Christ the Redeemer (figure 2.3) is completed in 1931 to represent the statue of Jesus Christ and it is the symbol of Christianity.



Figure 2.3 Cristo Redentor(1931), Rio de Janeiro, One of the New Seven Wonders of the World [34]

Bridges: Bridges are constructed to pass the obstacles (such as rivers as shown in figure 2.4) of the ground surface. Some others are constructed to give military or commercial services. The construction of the reinforced concrete bridges also come in to view at the late 19th century and early 20th centuries.



a)



b)



c)

Figure 2.4 a) The Paulins Kill Viaduct, Hainesburg, New Jersey completed in 1910, a pioneer in the use of reinforced concrete [34]; b) Pont de Châtelleraut in France (1900) [34]; c) The Salginatobel Bridge (1930) in the Swiss Alps, it was declared a Historic Civil Engineering Landmark in 1991[34].

Towers: Towers were constructed throughout history for different purposes as: to provide its users with an advantage in surveying defensive positions and obtaining a better view of the surrounding areas, including battlefields; to communicate information over greater distances (figure 2.5.b); for recreation; as a symbol of church spire (figure 2.5.a) etc [34].

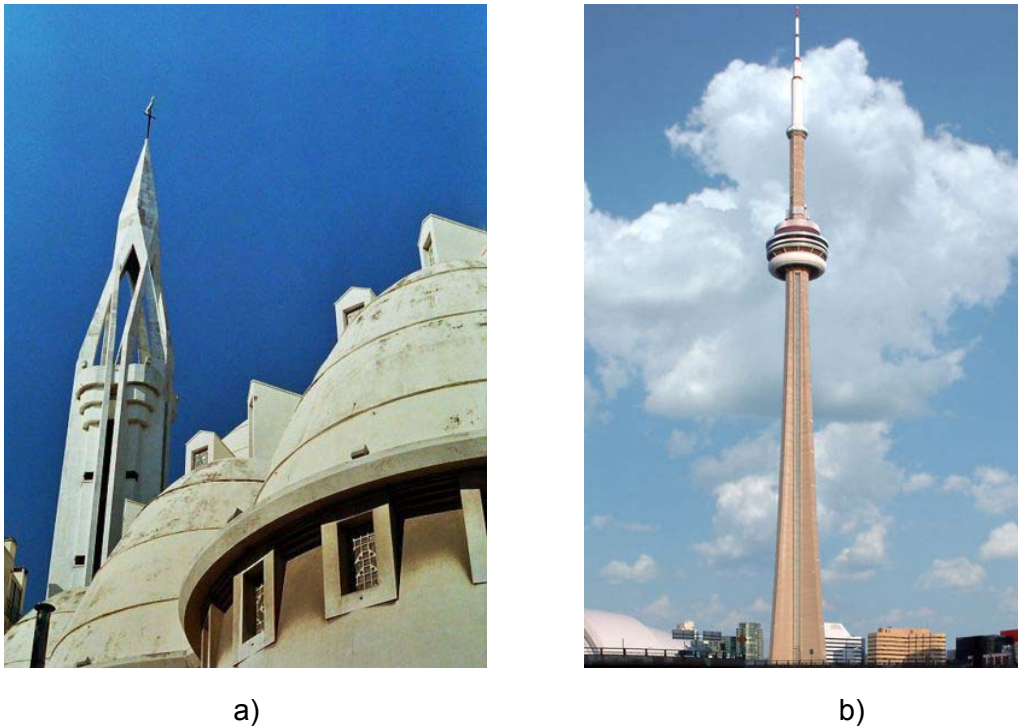

Figure 2.5 a) Reinforced concrete tower at Sainte Jeanne d'Arc Church (Nice, France, 1926–1933) [34]; b) CN Tower (the world's tallest completed freestanding structure) in Toronto, Ontario, Canada (1973 – 1976) [34]

2.3 Causes of reinforced concrete deterioration

Deterioration/distress of historic reinforced concrete can occur due to the following causes (factors) [33]:

- Environmental factors: which are typically moisture and carbon dioxide
- Materials and workmanship:
 - Early aggregates used absorb water and produce a weak and porous concrete. It also leads to the alkali aggregate reactions which lead to cracking and white surface staining. Aggregates were not always graded by size that created poorly consolidated and weak concrete
 - The use of sea water and beach sand in the mix or use of calcium chloride as an additive which causes long term problems
 - Poor concrete vibration which leaves voids at critical structural sections
 - Structural design defects, for example, the amount of protective concrete cover around reinforcing bars was often insufficient. There was also limited or no standard for reinforced concrete constructions; and etc.
- Improper maintenance of historic buildings can cause long-term deterioration of concrete. Water is a principal source of damage to historic concrete.

In addition, as cited in the introduction (section 2.2 above), it is reasonable to consider that the problems of modern and heritage reinforced concrete structures be similar.

Basically the causes of the deterioration of the reinforced concrete structures can be classified in to four main categories depending on the causes of deterioration [7]:

1. Mechanical actions, e.g. impact, overloading, movement caused by settlement, vibration, blasting etc.
2. Chemical actions(such as AAR and direct chemical exposure) and biological actions from the environment
3. Physical actions, e.g. freeze-thaw action, thermal cracking, moisture movement, salt crystallization and erosion
4. Reinforcement corrosion: due to chloride ion and carbonation mainly. Electropotential corrosion between steel reinforcement and another existing metal with in the concrete is not considered here.

Most of the problems occurring in reinforced concrete structures, which are also believed common in reinforced concrete heritages, are listed in Table 2.1 below along with their causes and preventions. All the problems stated below in table 2.1 contribute in the changes in color, texture, strength, chemical composition of the concrete heritage structures, or other properties of a natural or artificial material used in the structure.

2.3 Major signs of concrete deterioration

There are different mechanisms for the manifestations or signs of deteriorated reinforced concrete structures depending on their cause. The common signs of concrete deterioration can be summarized as [33]:

1. Cracking: Every concrete will crack, but varying in depth, width, direction, pattern, location, and cause. Cracks can be either active (which widen, deepen, or migrate through the concrete) or dormant (inactive) which can facilitate moisture ingress cause further damage if they are not repaired.
2. Structural cracks: can result from temporary or continued overloads, uneven foundation settling, or original design inadequacies.
3. Spalling: is the loss of surface material in patches of varying size because of corrosion of reinforcement steel, freeze thaw actions etc.

4. Deflection: is the bending or sagging of reinforced concrete structural elements such as beams, columns, slabs etc which can be due to overloading, corrosion of steel, by inadequate construction techniques, or by concrete creep.
5. Stain: is a white powdery surface which may be caused by alkali aggregate reactions. The stain can be colored due to the corrosion of reinforcement.
6. Erosion: due to wind, rain etc
7. Corrosion: is the rusting of the reinforcing steel in concrete mainly due to carbonation of concrete and the ingress of chloride ions. The rust will expand in volume and creates cracking and spalling of concrete. In addition, it reduces the load carrying capacity of the structural member.

Table 2.1 Common problems and causes of reinforced concrete heritage structures [1]

Problems	Causes	Laboratory analysis	Symptoms	Prevention
Accidental loading	Impact; explosion; Earthquakes	No	Spalling or cracking of concrete	Can't be prevented, but reduce the impact
Acid attack	highly concentrated acids nearby the concrete structures	to identify the specific acid present	Highly alkaline concrete material affected by acids causing loss of cement paste and aggregate from the matrix and reinforcement attack causes staining, cracking and spalling	Concrete with a low water-cement ratio(w/c) or appropriate surface coating or treatment
Aggressive water attack	water with low concentration of dissolved salts	to measure the aggressiveness of the water	leaching of surface produces rough concrete surface	Coating susceptible areas with nonportland-cement-based coating
Alkali-silica reaction	Reaction of aggregates containing silica with highly alkaline solutions, forming a solid that expands in the presence of water	Petrographic examination	Random cracking; Map or pattern of cracking and swelling of concrete	Removal or replacement of damaged concrete and/or a protective waterproofing render
Sulfate attack	Attack of concrete by naturally occurring sulfates found in soil or in solution in ground water adjacent to concrete structures	To determine occurrence of reactions	softening and loss of surface layers; Map or pattern of cracking and disintegration of concrete	Remove all suspect and degraded concrete, and patch or full repair using a polymer mortar
Construction errors	Poor workmanship and carelessness	No	Enhance the adverse impacts of other mechanisms or accelerate the penetration of aggressive agents(CO ₂ ,Cl ₂ ...) in to the concrete	To know what this construction errors are and following aggressive inspection program
corrosion of reinforcement	Differences in concrete of Moisture content, chloride content, oxygen content and electric potential difference	Determination of chloride content in the concrete, to determine the amount of concrete to be removed during repair	Rust staining of concrete followed by cracking(following the reinforcement)and spalling	Use of concrete with low permeability, providing adequate cover to reinforcement
Design errors	Inadequate structural design	No	Spalling due to higher compressive stresses and cracking due to high tensile stresses	Review of initial designs
	Poor design details	No	cracking due to localized concentrations of high stresses, that allows the passage of water and chemicals	Careful review of plans and specifications; correcting the detailing
Freezing and thawing	Expansion of the pore water in the cement paste and aggregate in cold climates	Laboratory examination of the core taken from the damaged structure	Varies from surface scaling to disintegration	Removal and replacement of damaged concrete with concrete having low w/c and air entrainer admixture, and providing drainage

Settlement and movement (due to failure of foundation materials)	Differential movement among various elements of the structure	review of instrumentation data to determine the movement	Cracking or spalling or faulty alignment of structural members; movement in non structural elements	Geotechnical solutions
	Subsidence: the entire structures or a single element of the structure is moving with respect to the remaining structure	review of instrumentation data to determine the movement	Cracking or spalling or faulty alignment of structural members; movement in non structural elements	Foundation soil strengthening by injection or grouting; underpinning; installing perforated drain pipe around the foundation
Shrinkage (loss of moisture from concrete)	Plastic shrinkage: occurs before setting. Bleeding of the paste allows evaporation of water at the surface	No	cracks at the surface due to tensile stresses if the evaporation is faster than the water supplied	not common for heritage structures, but common for patch repair materials used on the existing concrete substrate
	Drying shrinkage: long term loss of moisture from concrete after setting	No	Shrinkage and restraints from other parts of the structure creates tensile stresses that leads to shallow and fine cracks, the cracks being orthogonal or blocky in pattern	These cracks are aesthetic defects and as a rule no need of repair. If the effect need to be masked, surface grinding followed by a flood application with silicon is recommended
Temperature changes (change volume of concrete)	Internally generated temperature differences: caused by hydration of cement	No	thermal cracks as the tensile strength of the concrete is exceeded	It is rare in historic concrete, but the reformation of concrete by overlaying face the problem. To avoid this thermal stress by using low cement content, using combination of cement and pozzolans, placing the concrete at minimum temperatures, using aggregates of low modulus of elasticity and thermal coefficient
	Externally generated temperature differences: caused by variations in climatic conditions	No	thermal cracks as the tensile strength of the concrete is exceeded	Provision of contraction and expansion joints; providing reinforcing steel (temperature steel) to distribute the cracks and to minimize the size or crack already occurred ; careful review of repair materials
	Fire	No	Integrity loss, spalling or cracking	Fire alarm systems and prevention of sources of fire???
Over loading	The structure was designed using the previous available code that may be inadequate for current conditions; change in the use of the structure which lead to overloading and movements	No	Cracking, deformation and other damages due to bending, shearing ,torsion etc	Strengthen or repair the structure according to current use and standard

Of all the problems listed in table 2.1 above, the most common durability problems of reinforced concrete structures/heritages such as corrosion of reinforcing steel, alkali silica reaction, freeze thaw and overloading of the structure are discussed below.

2.4 Corrosion of reinforcement

Nowadays, most reinforced concrete structures are showing strength and durability related problems leading to the reduction in durability and service life of the structure. Reinforced concrete materials are mostly used in load bearing elements of structures (both for modern and heritage reinforced concrete structures). One of the most known cause for the reduction of durability of these structures is the corrosion of the reinforcing steel. Concrete is a weak material under tension, so reinforcing steel is embedded in concrete is to carry tension loads, which is usually affected by the corrosion of the reinforcement. The corrosion leads to the reduction of the material strength and the ductility of the structure, which in turn poses a treat to historical reinforced concrete heritages/structures. This reduction in durability and service life causes economic impacts as repairing expenses are comparatively high. In addition, it leads to social and environmental impacts due to the decrease of reliability and safety [12] as sown in figure 2.6 below.



Figure 2.6 Corrosion of reinforcement/tendons causes the collapse of the roof of the former Congress Hall in Berlin in 1980 [37]

According to [12], with increasing duration of exposure to a corrosive environment, the steel mass loss increases leading to a significance increase of the applied stress and a significant reduction of the tensile ductility of the reinforcing steel. [12] Shows that reinforcing bars subjected to corrosion may suffer a relatively modest loss of strength but a significant loss of ductility.

The deterioration of reinforced concrete structures can be caused by:

- The attack of the integrity of concrete due to chemical and acid attacks, freeze thaw and other factors.
- The attack of the embedded reinforcing steel, for example by chloride and carbonation.

In general, corrosion of the embedded reinforcing steel is the principal cause of the deterioration of concrete structures [4].

This section will discuss the problems associated with corrosion of steel in reinforced concrete and the factors responsible for the degradation of the mechanical properties of reinforced concrete. Corrosion of the reinforcement steel is caused due to [4]:

- Inadequate concrete cover to the reinforcement
- Leaving the reinforcement exposed to the aggressive environment
- Presence or contact of different types metals having different electrochemical potential(galvanic corrosion)

The main causes for corrosion of reinforcement can be generalized as follows [5]:

1. When the rebar in the concrete is exposed to the chlorides either contributed from the concrete ingredients or penetrated from the surrounding chloride-bearing environment;
2. Carbonation of concrete or penetration of acidic gases into the concrete;
3. Factors related to concrete quality, such as water cement (w/c) ratio, cement content, impurities in the concrete ingredients, presence of surface cracks, etc.
4. Factors related to the external environment, such as moisture, oxygen, humidity, temperature, bacterial attack, stray currents, etc.

The assessment of the causes and extent of corrosion is carried out using various electrochemical techniques.

It is believed that the surrounding concrete is able to prevent corrosion in the reinforcement in three different ways [5] and [6]:

- Hydration products of cement in concrete form a high alkalinity (pH=12-13) that passivates the reinforcement thereby preventing it from corrosion.
- Well-consolidated and properly cured concrete with a low w/c ratio has a low permeability, which minimizes penetration of corrosion inducing agents, such as chloride, carbon dioxide, moisture, etc. to the steel surface.
- The high electrical resistivity of concrete restricts the rate of corrosion by reducing the flow of electrical current from the anodic to the cathodic sites.

2.4.1 Factors affecting corrosion of steel in concrete

The factors contributing for the corrosion of reinforcement in concrete can be generalized as External and Internal factors.

1. **External factors:** include environmental factors as follows[5]:

- Availability of oxygen and moisture at rebar level. Moisture fulfills the electrolytic requirement of the corrosion cell.
- Carbonation and entry of acidic gaseous pollutants(SO₂ and NO₂) due to their tendency to reduce the pH of the concrete, leading to reinforcement corrosion, loss of passivity of concrete against reinforcement corrosion, and catastrophic reinforcement corrosion, as indicated in Table 2.2 [5].

Table 2.2 State of reinforcement corrosion at various pH levels

pH of concrete	State of reinforcement corrosion
Below 9.5	Commencement of steel corrosion
At 8.0	Passive film on the steel surface disappears
Below 7	Catastrophic corrosion occurs

- Aggressive anions, mostly chloride ions, reaching to the rebar level, either through the concrete ingredients or from the external environment: which increases the corrosion rate, but the change in pH of concrete is insignificant. Some countries limit the total chloride content in concrete codes as presented in Table 2.3 [5].

Table 2.3 Chloride content limits, as recommended by some codes of practices

Country	Recommended limits of chloride content(% by mass of cement)
USA	0.15% for chloride exposure and 0.3% for chloride free exposures
UK	0.3%
India	0.15%

- *Stray currents*
- Relative humidity and temperature
- *Bacterial action*

2. **Internal factors:** these includes concrete and steel quality parameters as described below[5]:

- Cement composition: The cement in the concrete provides protection to the reinforcing steel against corrosion by maintaining a high pH in the order of 12.5–13.

- Impurities in aggregate: Aggregates containing chloride salts cause serious corrosion problems, particularly those associated with sea-water and those whose natural sites are in ground water containing high concentration of chloride ions.
- Impurities in mixing or curing water(Chloride sources).
- Admixtures: addition of chloride set accelerators (CaCl_2 was widely used until the mid 1970s) to accelerate the hydration of cement.
- Water-cement ratio (w/c): it does not by itself control the rate of corrosion of reinforcement. The ingress of aggressive agents depends on the permeability of concrete, which is a function of w/c ratio that affects the corrosion of rebar. The following effects can be observed related to w/c ratio:
 - The depth of penetration of a particular chloride threshold value increases with an increase in the w/c ratio.
 - Carbonation depth has been found to be linearly increasing with an increase in the w/c ratio.
 - The oxygen diffusion coefficient is also found to be increasing with an increase in the w/c ratio.

Low w/c ratio decreases the concrete permeability, which in turn reduces the chloride penetration, carbon dioxide penetration, and oxygen diffusion in to concrete.

- *Cement content*: Due to inadequate amount of cement in mix the concrete is not consolidated properly leading to the formation of honeycombs and other surface defects. These honeycombs and surface defects help in the penetration and diffusion of corrosion causing agents, such as Cl^- , H_2O , O_2 , CO_2 , etc., in concrete. This results in the initiation of reinforcement corrosion.
- *Aggregate size and grading*: Aggregate grading is another factor, which should be considered for high quality impermeable concrete. The coefficient of permeability of concrete increases considerably with increasing size of aggregates. The proportioning of coarse and fine aggregates is important for the production of a workable and durable concrete.
- *Poor construction practices*:
- *Cover to the reinforcement*: Cover depth has a significant effect in case of corrosion due to penetration of either chloride or carbonation. Risk of reinforcement corrosion increases with low cover thicknesses.
- *Chemical composition and structure of the reinforcing steel*:

Of all the factors that aggravates the corrosion of the embedded reinforcement, carbonation and chloride ions cause the most significant deterioration problems in reinforced concrete structures (figure 2.7). These two factors will be discussed in detail in the following sections.

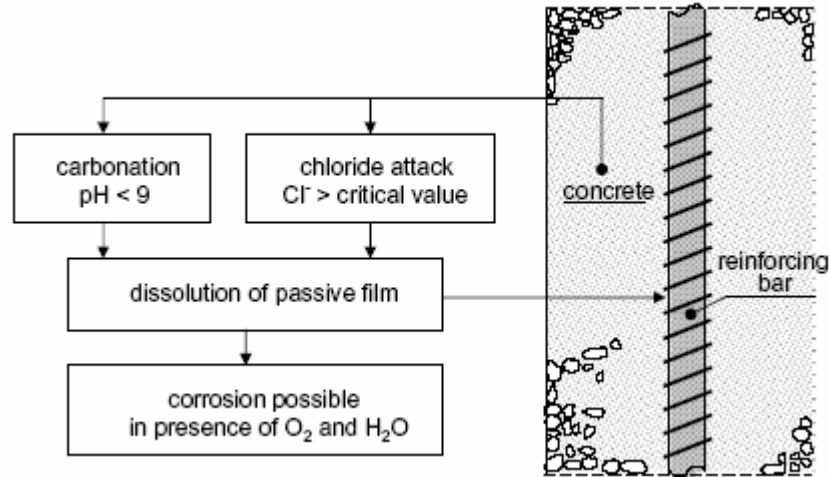

Figure 2.7 Initiation of mechanisms of steel corrosion in concrete [12]

2.4.2 Mechanisms of corrosion

Reinforcement corrosion is an electrochemical process (Figure 2.8), at the anode iron is oxidized to iron ions that pass into solution, and at the cathode oxygen is reduced to hydroxyl ions. The anode and the cathode form a corrosion cell, with the flow of electrons in the steel and of ions in the concrete pore solution leading to the corrosion of reinforcement. The corrosion product will expand 4-6 times the original or parent volume of iron or steel.

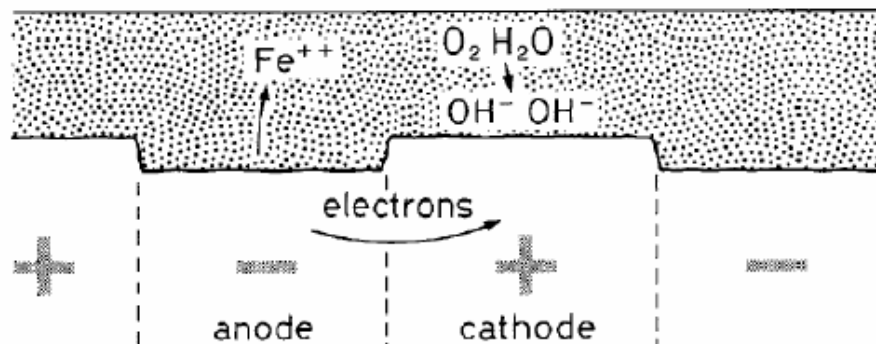
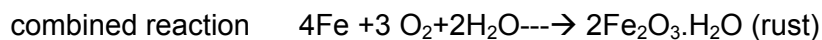
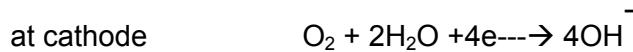

Figure 2.8 Corrosion of iron and steel occurs in the simultaneous presence of water and oxygen [14].

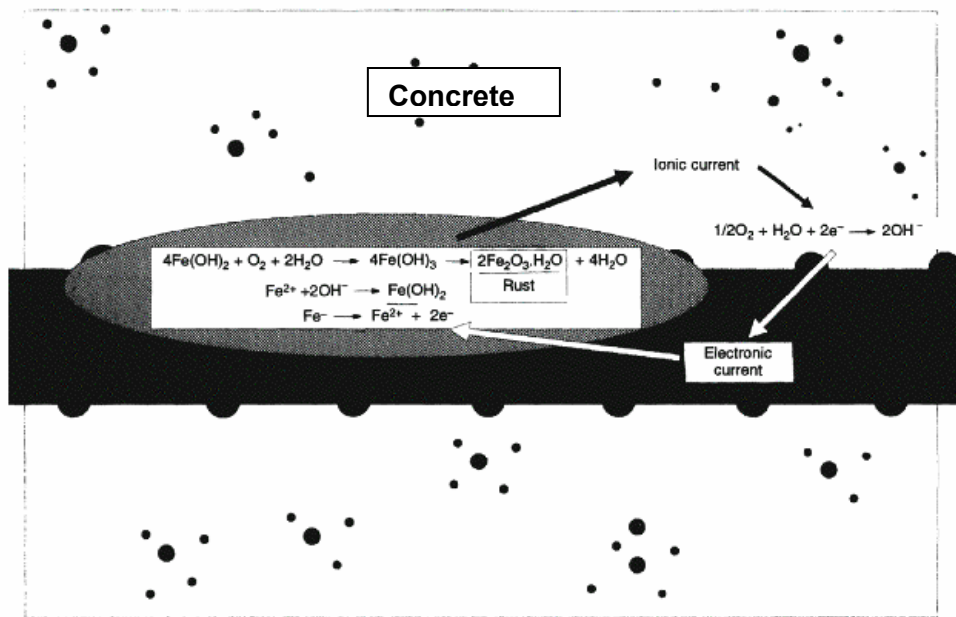

Figure 2.9 the corrosion reaction on steel [3]

2.4.3 Forms of corrosion

There are generally two common forms of corrosion: Pitting and uniform corrosion. Pitting corrosion is a localized corrosion which can be created due to the attack of corrosion agents acting on specific locations as compared to the whole steel mass. Uniform corrosion is acting uniformly all over the steel mass. Pitting corrosion is known to cause the most severe deterioration problems in reinforced concrete structures.

2.4.4 Chloride induced reinforcement corrosion

The durability of reinforced concrete structures is affected by the penetration of chloride ions, the main sources of chloride ions being [3]:

- Either contributed from concrete ingredients including deliberate addition of chloride set accelerators (CaCl₂ was widely used until the mid 1970s), use of sea water in the mix and using contaminated aggregate (usually sea dredged aggregates which were unwashed or inadequately washed) or
- Penetrated or diffused from the surrounding chloride-bearing environment or marine environment.



Figure 2.10 reinforcement corrosion caused by chloride ingress [21]

The diffusion of chloride from the surrounding environment into concrete is the major problem in most parts of the world.

Once the chloride content at the reinforcement reaches a threshold value (as shown in Table 2.4[8]) and enough oxygen and moisture are present, the reinforcement corrosion will be initiated, that may form corrosion products including various oxides of iron which are relatively lower density and occupy much more volume than the original iron. Corrosion products then accumulate in the concrete–steel interface transition zone; generate expansive pressure on the surrounding concrete, and the pressure builds to such a high level that cause crack initiation and propagation [6].

In addition to the cracking in surrounding concrete, chloride-induced reinforcement corrosion results in loss of the concrete–steel interface bond, and reduction of the cross-sectional area of reinforcement, thus reducing the load carrying capacity of concrete structure [6].

Table 2.4 Corrosion risk in concrete containing the chlorides (Pullar-Strecker, 1987) [8]

Chloride(per % by weight)	Condition of concrete adjacent to reinforcement	Corrosion risk
Less than 0.4%	1. Carbonated	High
	2. Uncarbonated, made with Cement containing less than 8% or more C ₃ A in total Cementious material	Moderate
	3. Uncarbonated, made with Cement containing 8% or more C ₃ A in total cementious material	
0.4%-1%	1. As above	High
	2. As above	High
	3. As above	Moderate
More than 1.0%	All cases	High

2.4.4.1 Chloride attack mechanism

The penetration of chloride ions through the porous concrete media may result in the accumulation of chloride content at reinforcement level. The chloride ion attacks the passive layer but, unlike carbonation, there is no overall drop in pH. Chloride act as catalysts to corrosion when there is sufficient concentration at the rebar surface to break down the passive layer. They are not consumed in the process but help to break down the passive layer of oxide on the steel and allow the corrosion process to proceed quickly. This is illustrated in Figure 2.11 below. This makes chloride attack difficult to remedy as chloride are hard to eliminate [3].

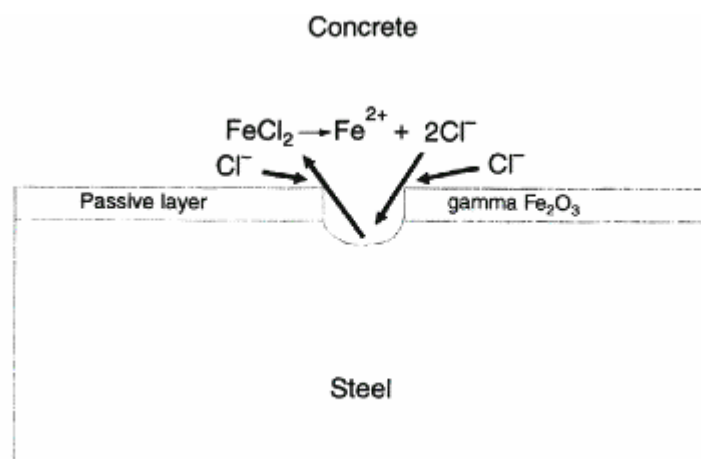
**Figure 2.11 the breakdown of the passive layer and 'recycling chlorides' [3]**

The chloride-induced reinforcement corrosion process of reinforced concrete structures can be divided roughly into three phases as shown in Figure 2.12 [6].

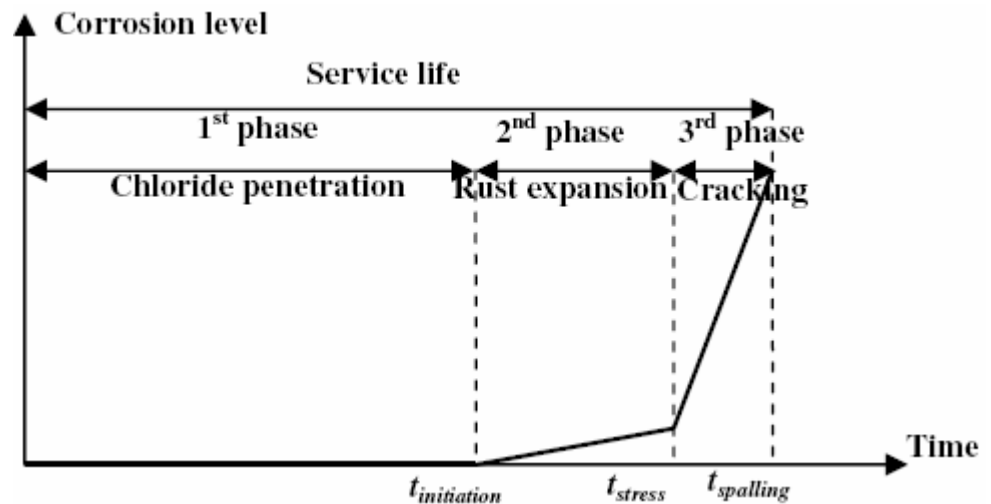

Figure 2.12 Chloride induced reinforcement corrosion process [6].

- **1st Phase (Chloride penetration):** The penetration or diffusion of chloride from the concrete surface through the concrete cover toward the reinforcement;

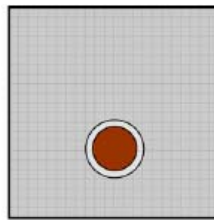

Figure 2.13 Chloride penetration and corrosion initiation [8]

- **2nd Phase (Rust expansion):** The 2nd phase starts when the chloride content at the reinforcement reaches a threshold value to initiate the corrosion process at time $t_{initiation}$. This phase is dominated by the reinforcement rust expansion, during which the corrosion products accumulate in the concrete-steel interface transition zone. Once voids in the interface transition zone are occupied completely with the rust at time t_{stress} , further rust accumulation will trigger expansive stress and then cracking in the surrounding concrete, which indicates the start of the third phase.

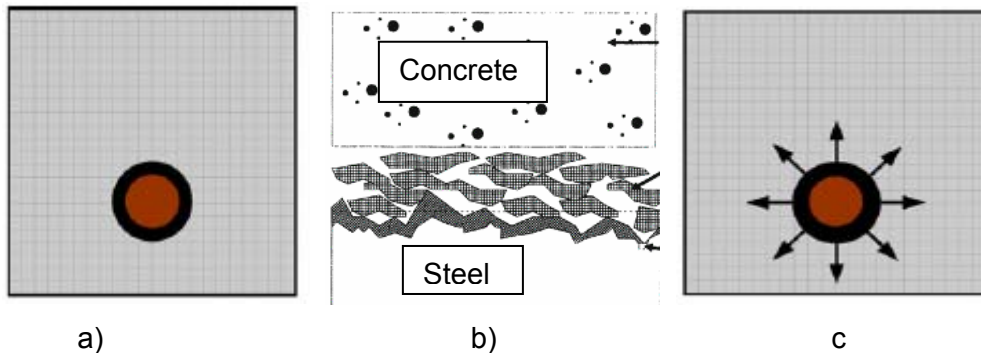

Figure 2.14 a) Free expansion of rust; b) rust growth and accumulation; c) stress initiation. [3] and [8]

- **3rd Phase:** In this last phase, the rust expansion-induced cracks propagate from the reinforcement to the surrounding concrete leading to the spalling and delamination of the concrete as shown in Figure 2.10. Corners tend to crack first on corroding reinforced concrete structures. This is because the oxygen, water, chlorides and carbon dioxide have two faces as path ways to the steel. Delamination occurs as corrosion proceeds on neighboring rebars and the horizontal cracks join up as shown Figure 2.15.

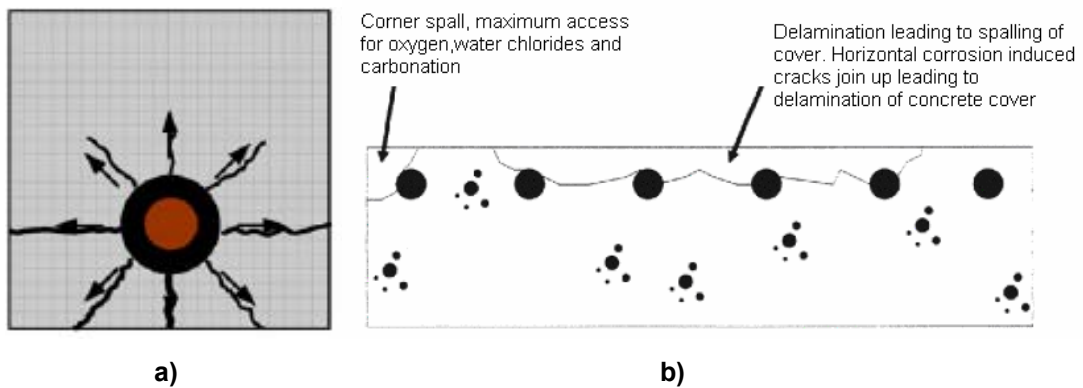

Figure 2.15 a) Concrete cracking due to rust expansion [8]; b) Corrosion induced cracking and spalling[3]

2.4.5 Carbonation induced reinforcement corrosion

Apart from chloride ions, carbonation is the other most important factor that will contribute for the corrosion of reinforcing steel, thereby reducing the strength and durability of load carrying reinforced concrete elements as shown in figure 2.16.



Figure 2.16 reinforcement corrosion caused by carbonation of concrete [21]

Carbonation is the interaction of carbon dioxide gas in the atmosphere with concrete hydrates, such as portlandite ($\text{Ca}(\text{OH})_2$) and Calcium silicate hydrates (CSH), producing calcite CaCO_3 and water [3] and [11]. Like many other gases carbon dioxide dissolved in water to form an acid. Unlike most other acids the carbonic acid does not attack the cement paste, but just neutralizes the alkalis (reduce the pH of concrete), mainly forming calcium carbonate as shown in the chemical equations below [3]:

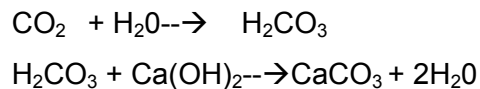

The calcium carbonate forms a porous line that will allow oxygen flows through surface concrete to corrode steel reinforcement [11]. The formation of CaCO_3 reduces the pH of concrete. Carbonation is strongly linked to drying of concrete. Wet concrete does not carbonate! [7]

Although carbonation is often considered as less severe than chloride ingress, it is much more widespread, because it involves carbon dioxide (CO_2) from air. Furthermore, carbonation coupled with chloride ingress reduces durability of concrete exposed to de-icing salts and marine environments, because carbonation accelerates chloride ingress [1]. Besides, ductility of concrete would decrease with an increase in the degree of carbonation [2] and [11].

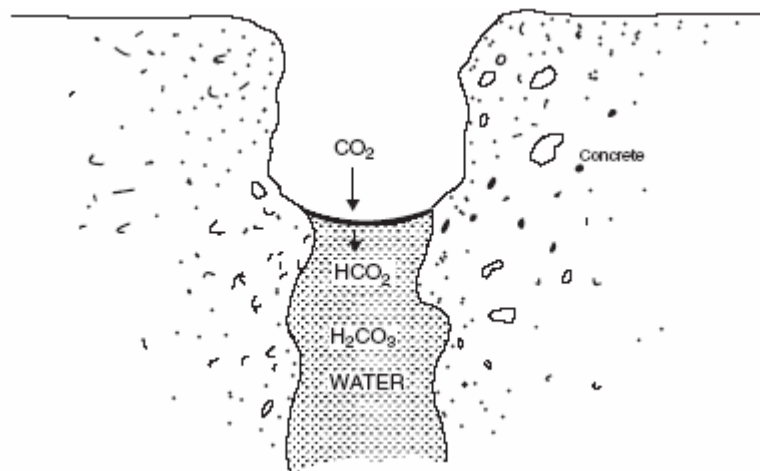

Figure 2.17 Reaction of carbon dioxide in pore water with lime and alkaline constituents [7].

Carbonation damage occurs most rapidly when there is little concrete cover over the reinforcing steel. Carbonation can occur even when the concrete cover depth to the reinforcing steel is high. This may be due to a very open pore structure where pores are well connected together and allow rapid CO_2 ingress by diffusion due to concentration gradients

between porous net and environment of concrete [3] and [11]. It may also happen when alkaline reserves in content, high water cement ratio and poor curing of the concrete.

Some of the factors that influence the resistance of reinforced concrete against carbonation induced corrosion are [3]:

1. *Carbonation rate*: which is a function of concrete cover thickness
2. *Cement content*: as the process of carbonation is neutralizing the alkalinity of concrete, good reserves of alkalinity is required, that is a high amount of cement content.
3. *Water-cement ratio (w/c)*: the water cement ratio has a direct relation with impermeability of concrete. Carbonation can be reduced by far if the w/c ratio in concrete is low.
4. *Compaction and curing or permeability*: The diffusion process is made easier if the concrete has an open pore structure. Thus well compacted and cured concrete has small pores and lower connectivity of pores so that CO₂ can't diffuse through the concrete easier. Microsilica and other additives can block pores or reduce pores sizes.
5. *Cover to reinforcement*: enough cover must be provided to prevent the carbonation front advancing into the concrete to the depth of the steel within the lifetime of the structure.

According to [3], Carbonation is common in old structures, badly built structures (particularly building). Carbonation is rare in modern civil engineering structures where water/cement ratios are low, cement contents are high with good compaction and curing, and there is enough cover to prevent the Carbonation front advancing into the concrete to the depth of the steel within the lifetime of the structure.

Wet/dry cycling on the concrete surface will accelerate carbonation by allowing carbon dioxide gas in during the dry cycle and then supplying the water to dissolve it in the wet cycle (according to the above equation). This gives problems in some countries in tropical or semi-tropical regions where the cycling between wet and dry seasons seems to favour carbonation, e.g. Hong Kong and some Pacific Rim countries [3].

Carbonation is easy to detect and measure. A PH indicator, usually phenolphthalein in a solution of water and alcohol, will detect the change in pH across a freshly exposed concrete face. Phenolphthalein changes from colorless at low pH (carbonated zone) to pink at high pH (uncarbonated concrete) [3]. Measurements can be taken on concrete cores, fragments and down drilled holes.

2.4.6 Condition evaluation of corrosion

So far it is tried to show the main mechanisms of corrosion. In this section, methods for the condition evaluation of corrosion of reinforcing steel will be discussed. These evaluation methods are very important for the effective repair of corrosion related deteriorations of reinforced concrete structures . The condition survey or evaluation can be categorized in to preliminary survey and detailed survey [3].

Preliminary survey

The preliminary survey will characterize the nature of the problem and give guidance for detailed survey. It includes visual inspection, probing of crack and spalls to see their extents, reinforcement cover measurement, taking broken pieces of concrete as sample for laboratory etc.

Detailed survey

The detailed survey will confirm the cause of corrosion; quantify the extent and severity deterioration due to corrosion. Since the repair is mostly depend on the detailed survey, most of the affected parts should be covered. The detailed survey helps to avoid unnecessary or expensive restoration or repair. The condition evaluation of corrosion helps to:

- Determine the cause of corrosion
- Determine the extent of corrosion
- Assess the current and future performance of corroded and sound reinforcement)
- Enable appropriate and cost-effective remedial measures to be selected

Some of the techniques commonly used for the condition survey of corrosion of reinforcing steel in concrete are listed in Table 2.5[3].

Table 2.5 Methods for condition survey of corrosion of reinforcing steel in concrete

Method	Detect/Application	Use	Limitation
Visual inspection	To estimate nature and extent of surface defect	visual inspection and collecting pictures and videos about the concrete surface using camera and	Depends on the skill of operator
Hammer/Chain	Delamination of concrete	Hit the concrete surface using hammer or drag the chain over the surface to hear the sound variation on the concrete surface	Water and deep delamination can affect result; depends on the skill of operator
Cover meter	Rebar depth, position and size; to check adequate cover has been provided	Move the cover meter over the concrete surface, and the location of the reinforcement is identified when the sound of the cover meter changes; the depth is recorded in the instrument	They are slow, and deep cover and closely spaced bars will affect the readings
Half cell potential measurements	Indication of corrosion risk of steel	Move the half cell along the concrete surface and observe the potential difference created	Needs specialist; Very negative potentials can be found in saturated conditions where there is no oxygen
Phenolphthalein	To estimate Carbonation depth and future carbonation	Expose/split fresh concrete surface and spray phenolphthalein indicator and observe the color change or take a core sample and apply phenolphthalein in laboratory	Dark colored fine aggregates can cause problems in color changes; Poorly consolidated and underground concrete exposed to dissolved carbonates in the water may not show clearly defined carbonation front; phenolphthalein change color at PH 9 but the passive breaks at PH 10-11
Chloride content	Chloride corrosion and chloride profile	Powdered samples from drilling will be dissolved in acid in the laboratory; in field using Quantab strips and specific ion electrode	Quantab strip is modest in accuracy and becomes inaccurate by certain aggregate types; Specific ion electrode is accurate but the equipment is expensive and needs trained personnel
Receptivity	concrete receptivity/corrosion risk by estimating whether steel is depassivated	Wenner probe is used to estimate the potential difference caused by depassivation	It is not used directly as independent measurement but to supplement other tests
Linear Polarization	To measure corrosion rate	Polarize the steel with an electric current and monitor its effect on the half cell potential	Detection of instantaneous corrosion rate which can change with temperature, relative humidity and other factors; there will be error in the estimated area of measurement specially at low corrosion rates

2.4.7 Consequences of corrosion

Once reinforcement corrosion is initiated, it progresses almost at a steady rate and shortens the durability and service life of the structure. The rate of corrosion directly affects the extent of the remaining service life of a corroding RC structure [5]. As the corrosion is in progress, the following two things will happen among others [1], [5] and [12]:

1. First, the cross-sectional area of the reinforcement is reduced, which in turn reduces the load-carrying capacity of the steel while loads of a reinforced concrete structure remain the same during the service life of the structure. The reduction in cross sectional area of the reinforcing steel will lead to an increase of the stress applied to the bars, which reduces the safety factors taken for the properties of the reinforcing steel. The corrosion also reduces both the ultimate
2. Second, the products of the corrosion, iron oxide (rust), expand since they occupy about eight times the volume of the original material. This increase in volume leads to cracking and ultimately spalling of the concrete. The cracking and spalling of the concrete surface impairs the appearance of the structure as shown in figure 2.18 below.

Generally the reinforcing steels are located in the zones of high tensile stresses or shear stresses of the load bearing elements, the well being of the structure is guaranteed if the well being of the reinforcement is maintained. As the ductility of a reinforced concrete depends on the reinforcing steel, the reduction in ductility of the reinforcing steel will lead to collapses without any warning. The structure without its service load bearing capacity will not give its intended function.



Figure 2.18 Corrosion damage in a North American elevated highway structure exposed to de-icing salts - notice spalling of the concrete cover, leaving the rebar exposed [38]

2.4.8 Rehabilitation of corrosion damaged reinforced concrete structures

There are various available physical and chemical rehabilitation techniques for rehabilitating corrosion damaged reinforced concrete structures to extend the service life and the safety of the structures. Before the rehabilitation starts, the causes of the damage should be identified by in situ tests or NDT to avoid unnecessary or expensive rehabilitation costs and to select the appropriate repair method. The appropriate repair and rehabilitation systems must be chosen for each structure according to its type, condition and future use [3]. Once the cause of the corrosion is known, there are common repair techniques for reinforced concrete structures damaged by reinforcement corrosion. The repair techniques can be broadly classified as:

1. Traditional repair methods: such as patching, Concrete placement, etc;
2. Electrochemical Techniques or methods: such as cathodic protection, chloride removal and realkalization.

2.4.8.1 Traditional repair methods

The traditional methods are those methods that have been used decades ago and are now still in use. Most of the traditional methods need the removal of deteriorated concrete due to chloride or carbonation before the repair method is applied.

Concrete removal and surface preparation

There are a number of methods for removing concrete, the choice being depended on the specification, budget, preferences and the scale of the concrete surface to be removed. Pneumatic hammer, hydrojetting and milling machines are among the known concrete removal methods [3]. The concrete removal and surface preparation includes the removal of unsound concrete, cleaning the rebar surface and squaring the edges. The concrete must be removed from all around the bar and behind the bar so that all the corroded part is exposed and the dust removed as shown in figure 2.19. The cleaned steel may be coated with anti-corrosion agents. This prepares the concrete surface for the next step that is patching .

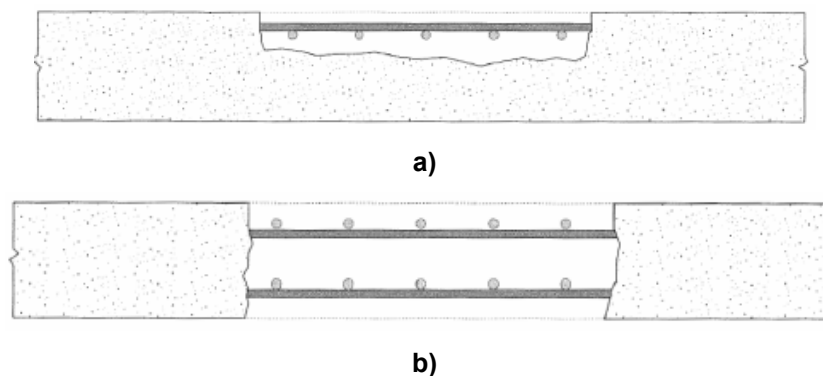

Figure 2.19 Partial (a) or full depth (b) of concrete removal and reinforcement cleaning [17]

Patches

After removing the damaged concrete, the empty space will be patched or filled with either prebagged materials or concrete mixes on site. Patching guarantee the carbonation repairs by restoring the alkalinity of concrete, but patch repairing is not adequate to stop further deterioration in the presence of chloride attack as patching of the corroded areas can accelerate corrosion elsewhere [3]. In addition, while removing the concrete cover either by spalling or concrete removal, the following two things may happen:

1. Removing the concrete will redistribute the load with in the structure, and the patch repair may not take the load through it as the original concrete. This effect is particularly important for slender reinforced concrete elements which are liable to buckle.
2. The exposed steel may bend once the bond between steel and concrete is lost, which will cause severe structural problems.

Thus patch repair should be minimized as much as possible or care must be taken for structural members (such as columns) where the above two problems may happen. Most writers say this is why electrochemical techniques are becoming common in repair of deteriorated concrete, as it needs any removal concrete except deteriorated concrete. But it is the patching repair that is common in most day to day repairs.

Protective surface treatments: Coatings, sealers, membranes and barriers

Once the patching of the removed concrete surface is finished, coatings are mostly applied. Coatings are beneficial in excluding undesirable aggressive agents such as chlorides and carbon dioxide, water or cosmetically restoring the appearance after concrete repair [3]. They will also hide the difference between the original concrete and new patching material.



Figure 2.20 Concrete removal, surface preparation, patching and surface treatment

1. Carbonation repair

- Anti-carbonation coatings: Coatings which should be applied after carbonated concrete repair to stop further carbon dioxide ingress.

2. Chloride repair

- Penetrating sealers: Penetrating sealers used to reduce chloride ingress in to the concrete, but according to [3], these sealers will accelerate carbonation.

- Drainage and guttering: This takes away chloride or salt containing water away from the concrete surface.
- Encasement and overlay: This reduces corrosion in high chloride bearing environments. Overlay may be polymer modified concrete, low slump dense concrete, or micro silica concretes. Overlay or encasement may absorb some of the chlorides on the old concrete surface there by reducing the chloride level. If some or all of the older concrete surface is removed, the overlay will reduce the high chloride gradient that drives chloride further in to the concrete

The limitation of coatings is that, they may retain humidity in the concrete that can initiate or enhance corrosion. When the humidity drops or temperature rises, the retained water exerts local force that can burst the coatings.

Corrosion inhibitors

Corrosion Inhibitors such as nitrite additives added to concrete are common to hinder corrosion. Most inhibitors develop a very thin chemical layer on the steel surface that inhibits corrosion attack or the chemical reactions that are taking place on the steel surface. The inhibitors can be applied as coatings on the surface or on to the exposed steel at patch repairs, incorporated in to the patch repairs, applied in grooves or drilled holes(but expensive and damaging) in the concrete cover or incorporated into concrete overlays. Optimum dosage of inhibitor should be applied to avoid localized or pitting attack due to shortage of inhibitors [3].

2.4.8.2 Electrochemical techniques

The use of electrochemical techniques for the repair of chloride and carbonation corrosion has been developed during the past decades. These techniques are getting more attention due their effectiveness in the field and laboratory. Electrochemical techniques avoid corrosion either by stopping it or maintaining it with in reasonable limit or preventing it. The other important feature of these techniques is that they don't need removal concrete except the deteriorated concrete. The most commonly used electrochemical techniques for the control of corrosion in existing reinforced concrete structures are [16]:

1. Cathodic protection
2. Chloride removal
3. Re-alkalization

Cathodic protection is applied for structures affected by chloride corrosion. Chloride removal and re-alkalization are applied to structures in which corrosion has not or has already

initiated. These techniques aim at modifying the composition of concrete that is carbonated or contains chlorides, in order to restore its original protective characteristics.

Both the protection of reinforcing steel and the restoring of the concrete alkalinity are obtained by forcing a direct current to circulate between the anode, placed on the surface of the reinforced concrete structure, and the reinforcement as shown in figure 2.21 below. But the circulation of the current is believed to stimulate alkali aggregate reaction, reduce the bond between the reinforcement and concrete or lead to the acidification of the anodic region.

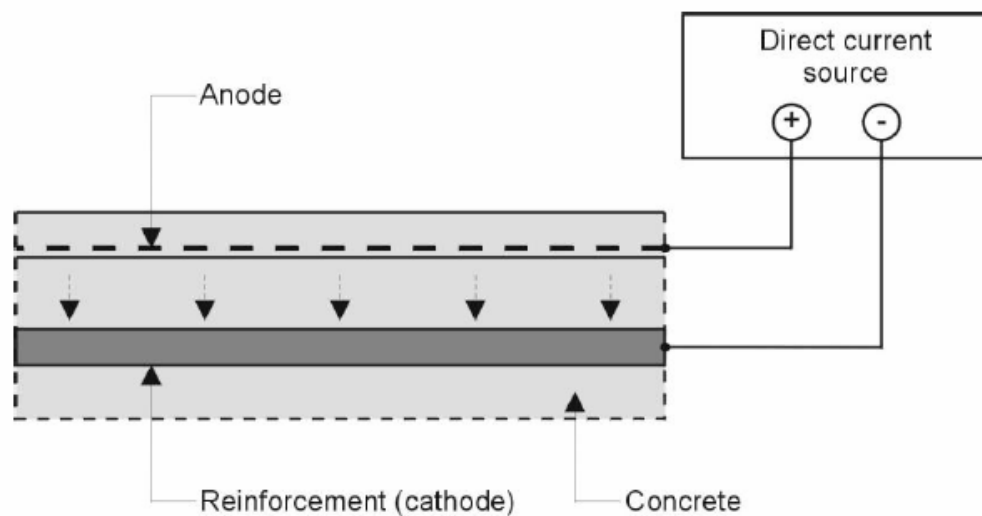

Figure 2.21 Schematic representation of application of electrochemical techniques [16]

2.4.8.2.1 Cathodic protection

Cathodic protection is applied for reinforced concrete structures affected by chloride corrosion; the steel is subjected to cathodic polarization, i.e. its potential is brought to values more negative than the free corrosion value, so that the corrosion rate is reduced. According to [16], this method is also found to be effective in repassivating steel in carbonated concrete, but it is not mostly applied as other methods are economical. The mechanism how this technique helps to protect chloride and carbonation corrosion is showed in figure 2.22 and 2.23 below respectively [3].

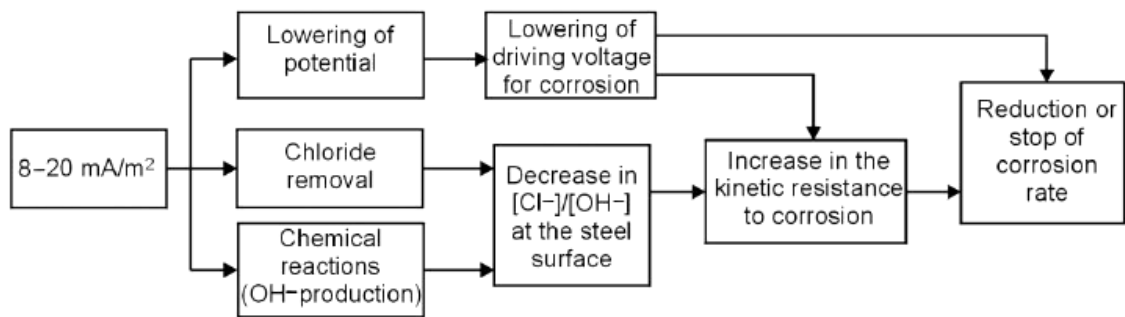

Figure 2.22 Cathodic protection of steel in chloride-containing concrete [16]

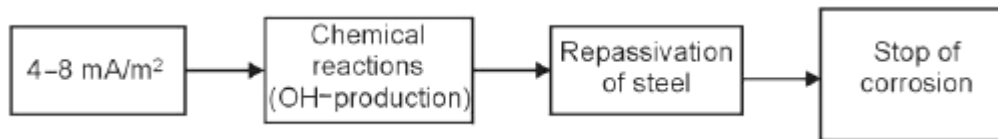

Figure 2.23 Cathodic protection of steel in carbonated concrete [16]

To achieve the cathodic protection, the anode system will be introduced in to the concrete surface. This anode system helps in the distribution of current on the surface of the structure to help better protection of the reinforcing steel against corrosion. According to [16], various methods of anode system are available such as:

- Titanium mesh, wire or strip embedded in concrete with an overlay
- Conductive coating with carbon powder in organic matrix
- Zinc coating foil attached to concrete surface via an ion-conducting gel adhesive.

Typical applications of the anode system to various members of a reinforced concrete are presented in figure 2.24 below [16].

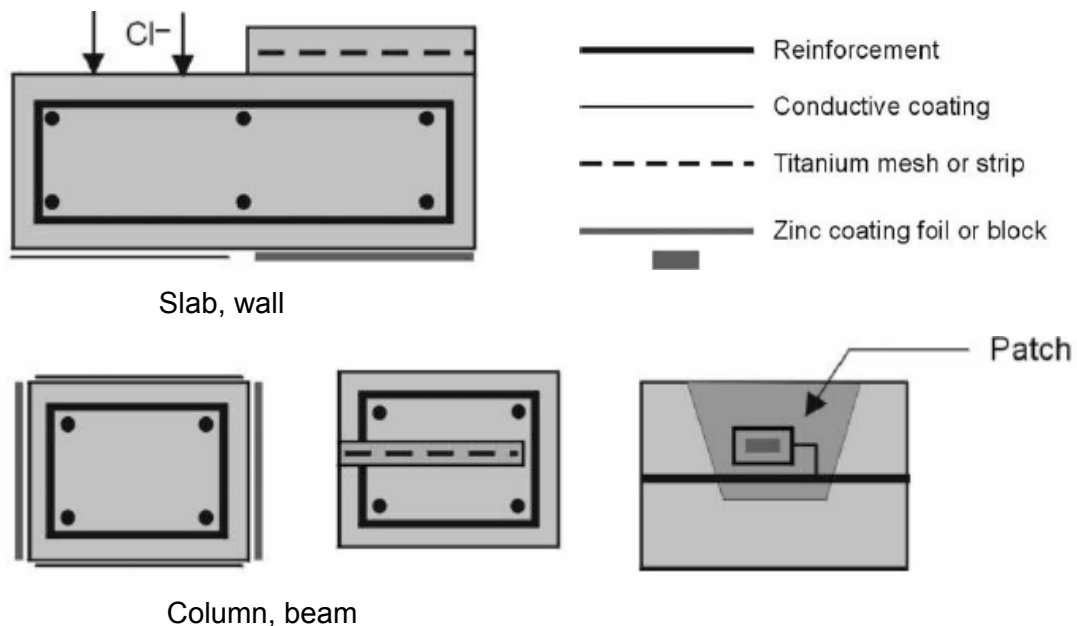

Figure 2.24 Examples of anode layouts with respect to a concrete cross section [16]

According to [8], no concrete repair methods can put corroded metal back on to the reinforcement except cathodic protection. It also states that the cost of cathodic protection is as much as half of other repair methods.

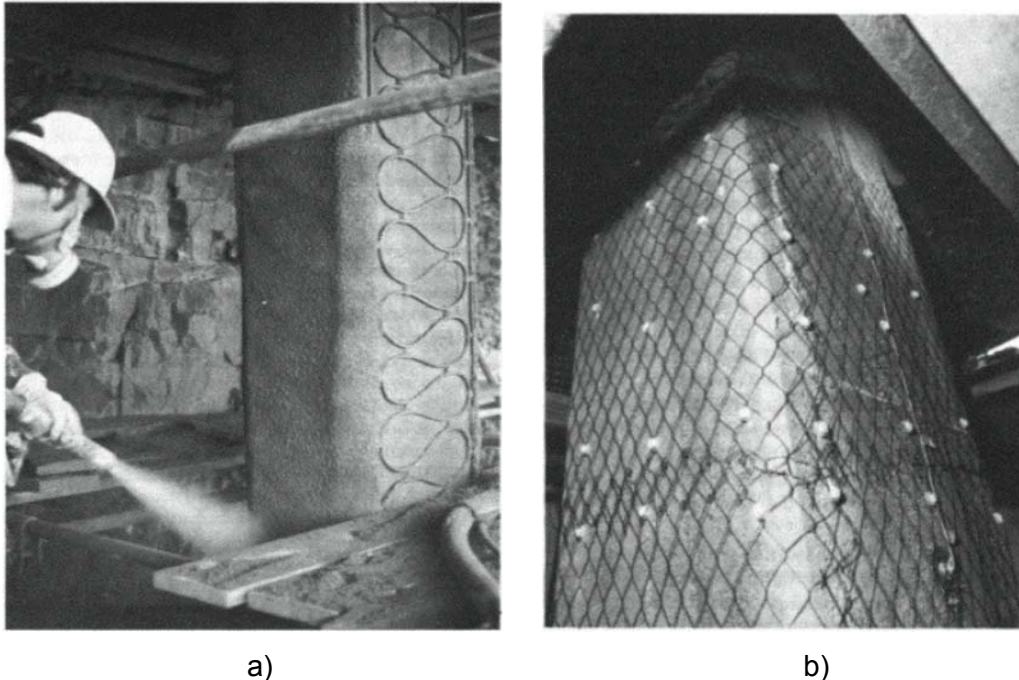

Figure 2.25 Anode layouts on bridge column a) fixed anode cover coat on bridge column; b) Metal oxide mesh fixed to bridge column [8].

2.4.8.2.2 Chloride removal

This electrochemical chloride removal technique uses liquid electrolytes and direct voltage to remove the chloride ions. In this process of chloride removal, the original concrete surface is left unchanged after treatment and this helps in the restoration of reinforced concrete architectural heritages or monuments.

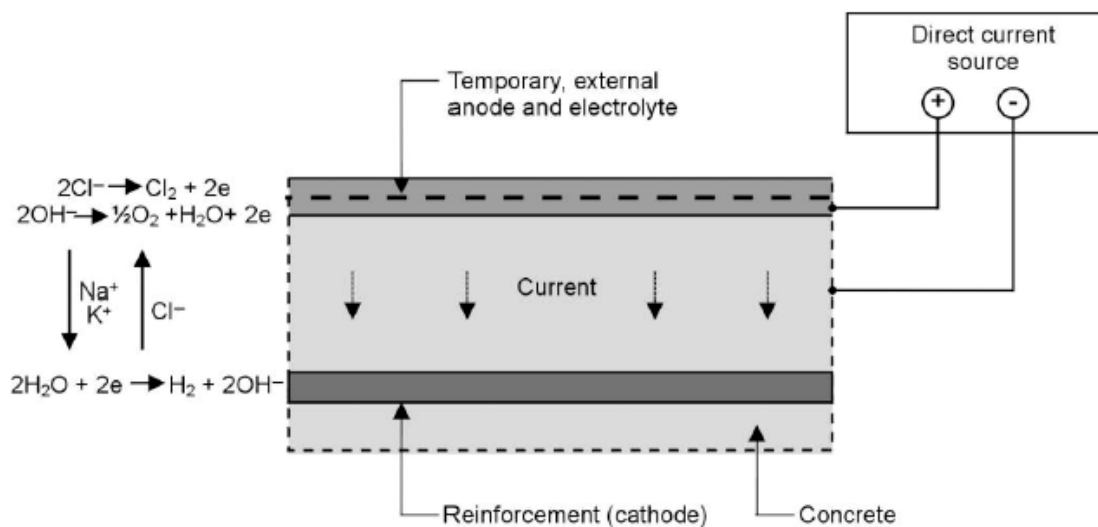

Figure 2.26 Principal Reactions involved in chloride extraction [16]

2.4.8.2.3 Re-alkalization

This technique aims at modifying the composition of concrete that is carbonated by raising the PH or alkalinity, thereby helping the concrete to restore its original protective characteristics. The increase in alkalinity will passivate the corroded reinforcement steel [16].

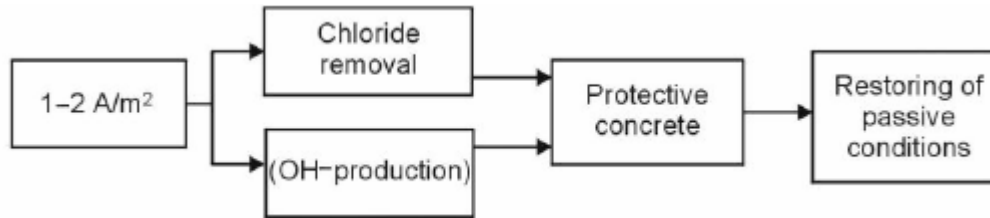

Figure 2.27 Re-alkalization or chloride removal [16]

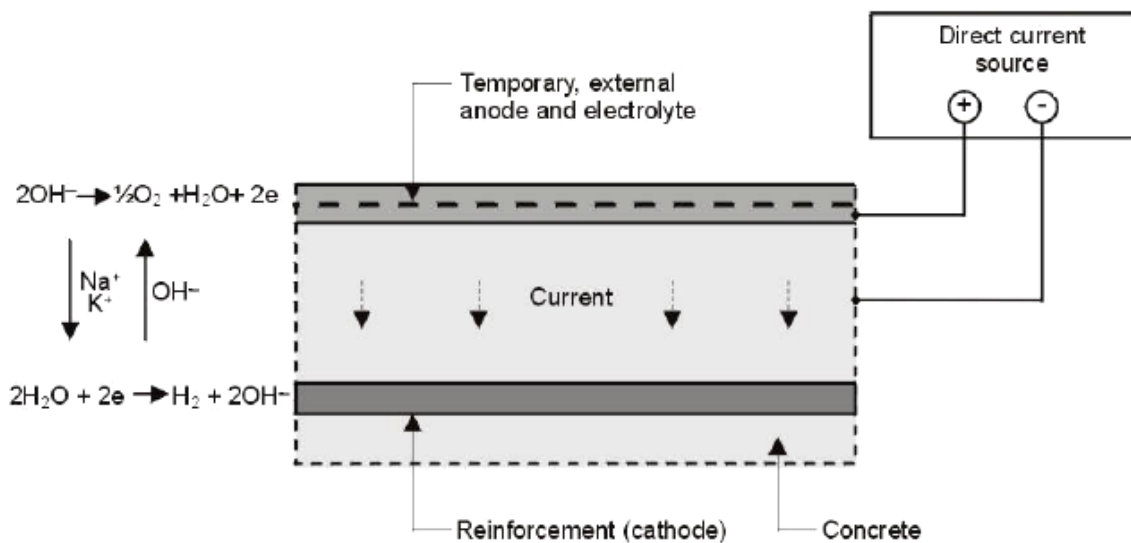

Figure 2.28 Principle of electrochemical re-alkalization [16]

The most common traditional and electrochemical techniques for the repair of deteriorated reinforced concrete due to chloride or carbonation attack are discussed above, but the challenge is to select which method is appropriate as there may be two or more repair methods for a single problem. Thus, the repair method to select depends on the following some factors:

- The cause of deterioration
- Conditions of the structure
- The cost of the repair
- Merits and limitations of techniques
- Etc.

The most common techniques for chloride and carbonation repair along with comparison considering merits, limitations and side effects are presented are shown in tables 2.6 and 2.7 below [16].

Table 2.6 Comparison of techniques for chloride repair

Technique	Effectiveness	Limitations	Side effects/Problems
Patch repair and coating	yes where patched	costs can rise if extra repairs needed	structural support may be needed
Patch repair and overlay/encase	Depends on chloride level and amount of concrete removed	Costs rise if more delaminations found	???
Cathodic protection	yes across treated area	Needs monitoring and maintenance	Can aggravate ASR
Chloride removal	yes across treated area	Lifetime not known	Can aggravate ASR
Inhibitors	yes across treated area	Rate of penetration to steel not known	Low dosing could cause pitting???

Table 2.7 Comparison of techniques for carbonation repair

Technique	Effectiveness	Limitations	Side effects/problems
Patch repair and anticarbonation coating	yes where patched	costs can rise if extra repairs needed	Structural support may be needed
Realkalization	yes across treated area	may need repeat after about 10years	Can aggravate ASR
Inhibitors	yes across treated area	Rate of penetration to steel not known	Low dose could cause pitting???

Future recommendation

The existing standards for calculating strength of reinforced concrete members do not account for the appreciable property degradation of the reinforcing steel bars due to the gradually accumulating corrosion damage. The safety factors for reinforcing steel that are stipulated in existing standards need to include the effect of corrosion.

2.5 Alkali aggregate reaction

In recent years increasing attention has been given to problems associated to alkali aggregate reaction due to a number of instances of ASR attack and the identification of reactive aggregates in many countries. As it is indicated before, the aggregates used in historic concrete absorb water and it was sensitive to alkali aggregate reactions.

In most concrete, aggregates are more or less chemically inert. However, some aggregates react with the alkali hydroxides in concrete, causing expansion and cracking over a period of many years. This alkali-aggregate reaction has two forms:

1. Alkali silica reaction (ASR) and
2. Alkali-carbonate reaction (ACR)

ASR is considerably more widespread and is of more significance. In the following sections, ASR will be discussed in detail.

2.5.1 Alkali silica reaction (ASR)

Aggregate silica reaction (ASR) is a reaction between alkalis (found in cement or added to concrete) and reactive siliceous mineral components of the aggregate (such as chert, quartzite, opal, strained quartz crystals) to form a solid nonexpansive calcium-alkali-silica complex or an alkali-silica complex. The reaction product is an alkali silicate gel which on absorption of water will expand and generate hydraulic or tensile stresses which may cause cracking [1], [2] and [13]. The reaction that takes place is the formation of sodium and potassium silicates by a slow and expansive reaction of the sodium and potassium hydroxides with the available silica [13].

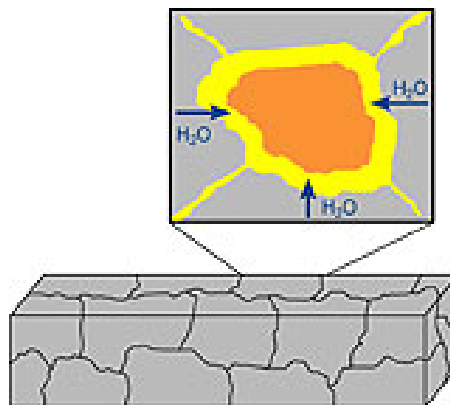

Figure 2.29 Expansion of aggregate silica complex in the presence of water [27]

The following factors insure the occurrence of ASR are [13]:

- High alkali content of the concrete, mainly contributed from the cement in the form of potassium oxide (K_2O) and sodium oxide (Na_2O)
- Water - ASR will not occur if there is no available water in the concrete, since alkali-silica gel formation requires water. The water source can be from the surrounding cement paste or the environment [27].
- The amount of reactive aggregates and the grain size of aggregates.

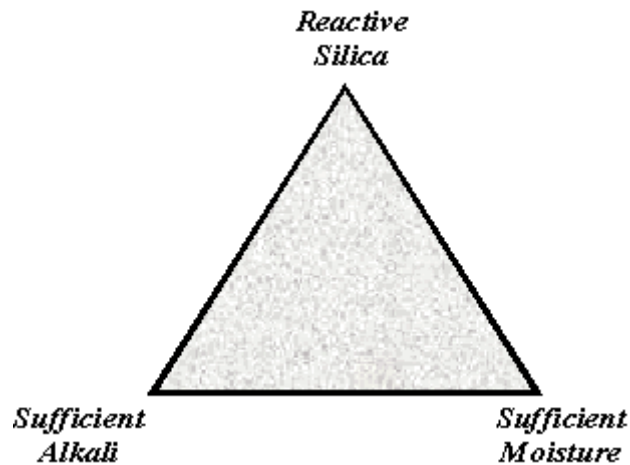

Figure 2.30 The Three Necessary Components for ASR-Induced Damage in Concrete [26].

The term reactive refers to aggregates that tend to breakdown under exposure to the highly alkaline pore solution in concrete and subsequently react with the alkali- hydroxides (sodium and potassium) to form ASR gel [26].

The alkali-silica reaction usually occurs much later, possibly years after the concrete was placed. Large aggregate particles generate a significant volume of gel which then takes up water and expands within the hardened, mature concrete [35].

Generally the following phenomena will be observed once the ASR is initiated [7]:

- Expansion of concrete
- Small crack formation at surface
- Spalling of concrete
- Expulsion of alkali-silica gel

2.5.2 Identification of ASR

The best technique for the identification of ASR is the examination of concrete in thin section, using a petrographic microscope. Alternatively, polished sections of concrete can be examined by scanning electron microscopy (SEM) as shown in figure 2.31 and 2.32 below) .

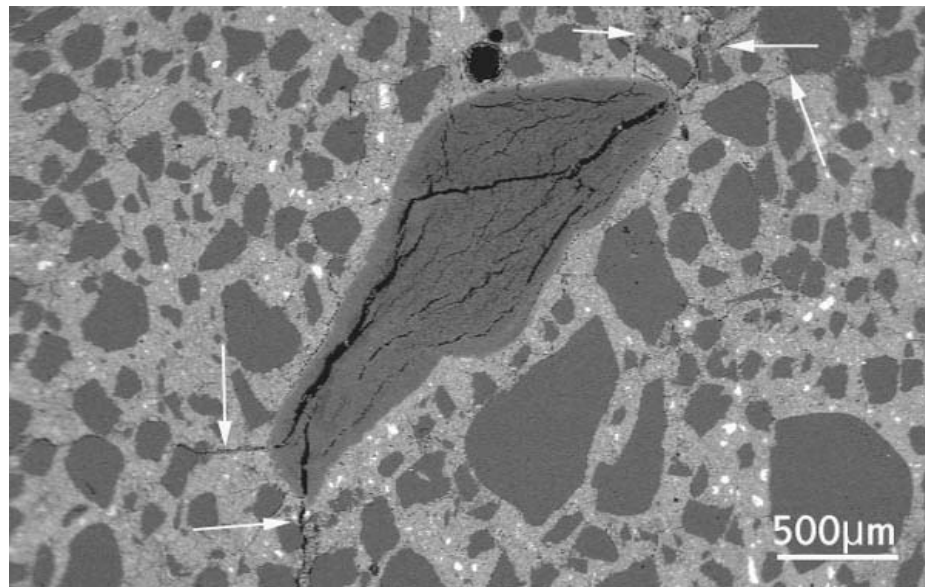

Figure 2.31 Polished section of concrete, viewed with a scanning electron microscope, showing a chert aggregate particle with extensive internal cracks due to alkali-silica reaction. The cracks extend from the aggregate into the nearby concrete (arrowed) [35].

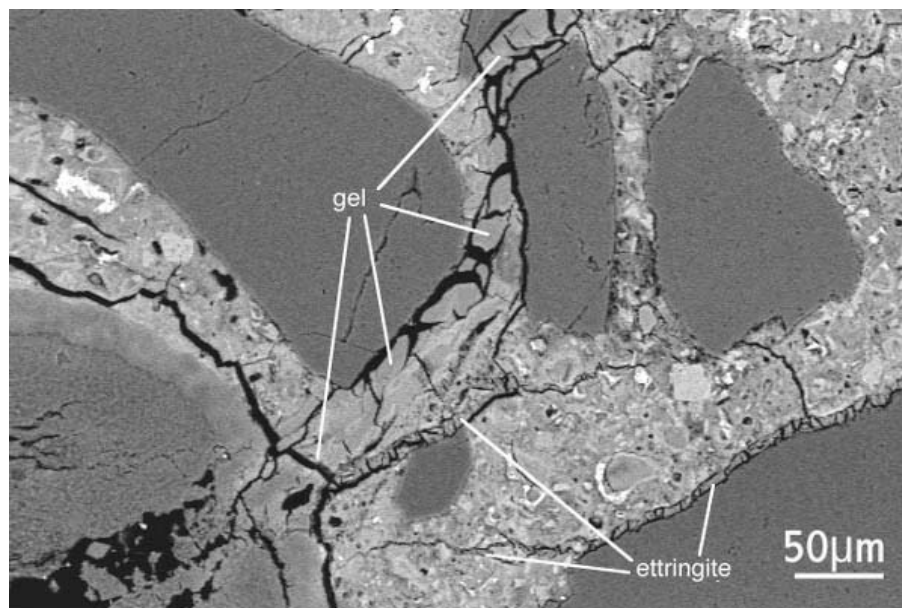

Figure 2.32 Detail of the chert particle in the previous image and adjacent cement paste, showing alkali-silica gel extruded into cracks within the concrete [35].

2.5.3 Symptoms or indications of ASR

The symptoms of ASR attacked reinforced concrete structures depends on the severity of the attack, exposure conditions, type of structure, amount and direction of restraint (internal or external), and other factors, the most important being role of restraint on subsequent crack patterns. The main symptoms of ASR are random cracking, map or pattern of cracking and

swelling of concrete. Figure 2.33 shows typical ASR-induced damage in unrestrained concrete, resulting in classic map-cracking. Figure 2.34 shows similar damage in restrained concrete structures, where cracking tends to align itself in the direction of the main reinforcement (i.e., principal stress direction) [26].



Figure 2.33 ASR-Induced Damage in Unrestrained Concrete Element. Uniform Expansion in all Directions Results in Classic Map-Cracking [26]



Figure 2.34 ASR-Induced Damage in Restrained Concrete Elements [26] and [27]

2.5.4 Mitigating ASR in existing concrete

There are some available techniques that can help extend the service life of the structure that is already attacked by ASR induced expansion. These techniques can be applied if the concrete surface is not spalled and deteriorated. To minimize future damage to such existing structures [26]:

- Provide adequate or improved drainage (to minimize availability of moisture).
- Apply claddings or coatings to further limit moisture ingress.
- Treat existing cracks to minimize future expansion (and direct moisture ingress, deicing salts, etc.).

- Avoid future use of deicing salts that will increase alkali content within the structure.
- Restrain or confine expansion of structural element.
- Chemically suppress ASR using lithium compounds

If the concrete surface is deteriorated or spalled due to alkali silica reaction, the deteriorated or spalled concrete should be removed and replaced by new concrete having the following properties [26] and [7]:

- Using non-reactive aggregates
- Limiting the alkali content of concrete
- Using supplementary cementing materials including fly ash, ground-granulated blast furnace slag, and silica fume.

2.6 Freeze thaw in concrete

Water has lots of ways entering in to the concrete volume; the main reason is being the permeability and porosity of concrete. Deterioration of concrete from freeze thaw actions may occur when the concrete is critically saturated, which is when approximately 91% of its pores are filled with water. The water already inside the capillary pore of cement paste and aggregate will change to ice in cold weather thereby increasing the volume of the ice; the ice occupies 9% more volume than that of water. This increase in volume of ice will lead to expansion of the surrounding concrete. During warm seasons, the ice so formed will melt in to water. This successive freezing (during cold weather) and thawing (during warm weather) of the concrete will lead to a cumulative expansion on the concrete volume leading to the scaling or disintegration of the concrete member when the expansion pressure is greater than the tensile strength of concrete [1], [7], [28] and [16]. This freeze thawing is a destructive weathering factor which depends on the temperature of the locality.

In cold climates, for example northern Europe and Canada, deicing chemicals (various salts and alcohols) are widely used to lower the freezing point of water thereby aiding the removal of ice from the concrete surface by melting the ice. Most common chemical deicers do not chemically attack concrete, but the use of these deicing chemicals on concrete surfaces may accelerate damage caused by freezing and thawing and may lead to pitting and scaling [1] and [28]. The effect of deicing chemicals is more pronounced on flat concrete surfaces. Deterioration of concrete by deicers is related to the complex process associated with physical and chemical alteration in cement paste, aggregates and aggregate-paste interface that aggravates the effect of freeze thaw in concrete volume [15].

The effect of freeze thawing depends on the exposure of the concrete member to the environment. Exposed areas such as tops of walls, piers, parapets, and slabs enhance the vulnerability of concrete to the harmful effects of the repeated cycles of freezing and thawing [1]. A simplified freeze thaw cycle model of a concrete surface is shown in Figure 2.35 below.

Freeze-Thaw Cycle

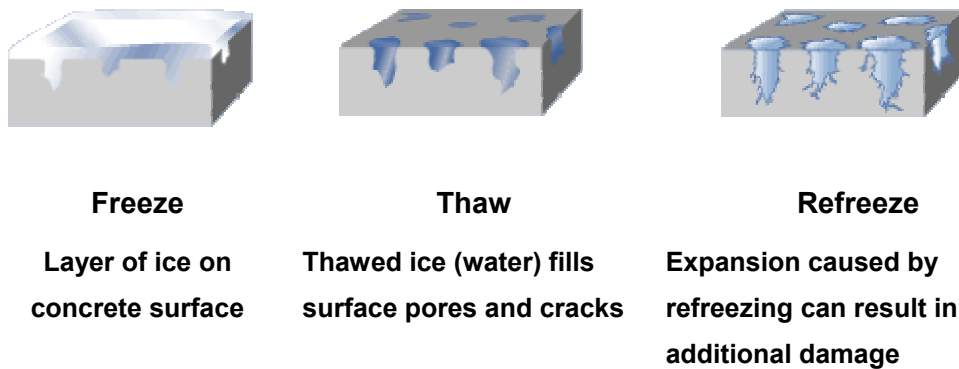

Figure 2.35 Freeze thaw cycle [36]

Figure 2.36 below shows the 1904 reinforced concrete tower (Battery Commander's Station, Fort Washington, Maryland) showing serious deterioration. Water has penetrated the slab, causing freeze-thaw spalling around the posts and corrosion of the reinforcing bars [33]



Figure 2.36 the 1904 reinforced concrete tower deteriorated due to freeze thaw and reinforcing steel corrosion [33]

2.6.1 Rehabilitation of freeze thaw damages

The symptom of freeze thaw in reinforced concrete structure varies from surface scaling to disintegration. Once the disintegration of the concrete has started, it may be difficult to stop it. There are some methods that are developed to reduce the impact of freeze thaw in new concrete [7]. Using these methods, the deteriorated part shall be removed and substituted with a new concrete having the following characteristics:

- Air-entrained concrete: the air bubbles larger than the cement pores will act as expansion vessels that will provide a space for the ice to expand freely without causing any surface deterioration.
- Surface treatment: the freeze thaw damage occurs if the concrete is wet. Therefore, the better solution is to prevent the ingress of water by applying a surface coat (hydrophobic agents) that will not affect the free evaporation of water from the surface of concrete.
- Low water/cement (w/c) ratio with good curing, but according to [7], this method is best for moderate climate regions.

According to [1], polymer coating is an effective way of repairing freeze thaw damage provided that the coating will not form a vapor barrier that will erupt the coating by freeze thawing cycles.

It should be kept in mind that freeze thaw may not be the only problem of the deteriorated concrete as the cracks caused by the freeze thaw can aggravate the ingress of chloride, carbon dioxide, water, oxygen and other aggressive agents that affects the steel reinforcement. Thus whenever a repair for freeze thaw is taking place, it is important to check the condition of the embedded steel reinforcement whether it is corroded or not.

2.7 Overloading of Reinforced concrete Heritages

Historic reinforced concrete structures were designed to meet the need of codes of their time. They were designed to give a service for a specific purpose, but as time passes the use of the structure as well as the demand they were designed for will change. This will create deterioration of structures by cracking of stressed structural members, deflection etc. In addition, at the beginning of the century, earth quake codes were not provided for the design of reinforced concrete structures. Nowadays, earthquake is becoming the major treat for the deterioration or collapse of historic reinforced concrete structures.

The overloading of reinforced concrete structures can be caused due to the following conditions:

- The change in use of the structure typically building
- The structure was designed using the previous available code that may be inadequate for current conditions
- The increased use or demand and loads for the structure, for example bridges
- Due to unlimited visitor or tourist access to the reinforced concrete heritage
- Seismic overloading of structures and etc.

2.7.1 Mitigation of overloading

There are some methods that are currently used for the repair and upgrading of concrete heritages. But they are in principle invented for modern constructions. The problems due to overloading can cause the following three typical stresses on the member:

- 1) Flexure or bending stresses in members
- 2) Shearing stresses in members
- 3) Punching stresses in members

The strengthening and upgrading of reinforced concrete structures/heritages are discussed in detail in section 4. It mainly includes the overlay of concrete, FRP applications, Steel plates and post-tensioning etc that are commonly applied in reinforced concrete structures.

3. PLANNING FOR REINFORCED CONCRETE HERITAGES/STRUCTURES REPAIR, RESTORATION AND PRESERVATION

3.1 Introduction

The restoration scheme for a deteriorated heritage reinforced concrete structure needs an in situ data for evaluating structural adequacy and for defining the scope of the restoration work. To enable the extent of the areas requiring repairs to be fully defined, analyzed and budgeted for, the condition and residual structural capacity of the various elements of the structure must first be thoroughly and accurately assessed , which in turn needs the gathering of in situ information on the state and material properties of the deteriorated structure. [10].

A thorough and logical evaluation of the current condition of the concrete in a structure is the first step of any repair or rehabilitation project. Before any intervention is decided on the heritage structures, the following steps shall be followed [1]:

1. Evaluating the condition of concrete in the structure
 - It may include the design and construction history, maintenance records, visual examination, nondestructive testing (NDT), and laboratory analysis of concrete samples, which helps to know the condition of the concrete and the causes of the damage.
2. Relating the existing condition of the concrete with the possible causes
 - The visual observations and other supporting data must be related to the mechanism or mechanisms that caused the damage. The basic cause of the deterioration should be identified as there may be many causes for a single problem.
3. Selecting appropriate repair material and method to mitigate the problem
 - Once the cause of the damage observed in a structure has been determined, appropriate repair materials and methods can be selected.
4. Preparation of plans and specifications
5. Execution of the work according to the plans and specifications, or appropriate application of the repair material and methods on the structure under consideration.

A thorough understanding of the causes of the concrete problem is essential to perform meaningful evaluations and successful repairs. If the cause of a problem is understood, it is much more likely that the correct repair method will be selected and that, consequently, the repair will be successful.

As there may be many possible causes for a single problem, the correct cause should be identified. For example, cracking is a symptom of distress that may have a variety of causes. The cracking might be caused by repeated freezing and thawing of the concrete, accidental loading, or some other cause. Only after the cause or causes are known can rational decisions be made concerning the selection of a proper method of repair and in determining how to avoid a repetition of the circumstances that led to the problem.

3.2 Condition Survey

A condition survey involves visual examination of exposed concrete for the purpose of identifying and defining areas of distress or problems. These problems of concrete can be expressed in terms of cracking, surface problems (spalling and disintegration), and joint deterioration. This condition survey will frequently include core drilling to obtain specimens for laboratory testing and analysis. The condition survey shall include the following steps [1]:

- 1. Visual inspection:** is the first step in any concrete condition survey. It is used to locate and define areas of distress or problem or deterioration of concrete. On visual inspection, the following conditions should be observed thoroughly:
 - Construction faults: due to poor workmanship such as bug holes exposed steel reinforcement, honeycombing etc.
 - Cracking: this can be expressed in terms of surface appearance, depth of cracking, width of cracking, current state of activity and structural nature of crack.
 - Disintegration: Disintegration of concrete is the deterioration of the concrete into small fragments or particles resulting from any cause, the most frequent causes being aggressive-water attack, freezing and thawing, chemical attack, and poor construction practices. Disintegration can be expressed in terms of spalling and dusting.
 - Distortion or movement: is a change in alignment of the components of a structure.
 - Erosion: in the form of abrasion and cavitations
 - Spalling: spalling is defined as the development of fragments, usually in the shape of flakes, detached from a larger mass. Spalling can be described in terms of popouts (shallow, typically conical depressions in a concrete surface due to the result of freezing of concrete that contains some unsatisfactory aggregate particles) or that caused by the corrosion of reinforcement or other non-corrosion-resistant embedded metal in concrete.

- **Delamination:** Reinforcing steel placed too near the surface or reinforcing steel exposed to chloride ions will corrode. The iron combines with the oxygen in water or air forming rust, or iron oxide, and a corresponding increase in volume up to eight times the original volume. The volume increase results in cracking over the reinforcing steel, followed by delamination along the mat of steel and eventually by spalling. Sounding of concrete with a hammer or chain dragging (for larger areas) provides a low-cost, accurate method for identifying delaminated areas. Infrared thermography is another effective method of detecting delamination.
2. **Cracking survey:** is the survey of the surface of the concrete structure for locating and marking of areas of distress or problem, identifying cracks and determining the relationship of the cracks with other problems or destructive phenomena. Crack widths should be measured either using crack meter or comparator card. Crack depth should also be recorded by observation of edges or insertion of fine wire or drilling or using pulse velocity method.
 3. **Surface mapping:** In parallel with crack survey, surface mapping of the deteriorated concrete surface is made using detailed drawings, photographs or movies.
 4. **Joint survey:** is the visual inspection of the joints in the structure to see the existing condition of the joint and to check the presence of any defects as spalling, chemical attack etc.
 5. **Core drilling:** This is a direct method of obtaining in-situ concrete strength of deteriorated concrete structures [10]. The core will be analyzed in the laboratory to obtain information on the condition of the concrete. The depth of core depends on the intended use and type of the structure. When drill hole coring is impractical or core recovery is poor, a bore hole camera or television is used to evaluate the interior of the concrete structure.

3.3 Laboratory investigation

After the sample is taken, laboratory analysis is performed. In this stage careful examination of the structure and detailed tests which will positively identify the cause and extent of the distress, and that allow prediction to be made about the remaining service life of the structure.

The laboratory analysis includes [1]:

- Petrographic analysis to describe and classify the hardened concrete;

- Chemical analysis to estimate the cement content, the original water-cement ratio, the presence and amount of chloride and other admixtures.
- Physical analysis to determine the density, compressive strength, modulus of elasticity, Poisson's ratio etc.

3.4 Nondestructive Testing (NDT)

The direct method of obtaining in-situ concrete strength of deteriorated concrete structures is core drilling, but it is not always feasible to core for specimens. The solution is therefore to use indirect non-destructive and partially destructive techniques which measure concrete properties other than strength in combination with testing core specimens [10].

Nondestructive testing is becoming very common nowadays to determine the various relative properties of concrete such as in-place strength, modulus of elasticity, homogeneity, and integrity, as well as conditions of strain and stress, yield strength, Young's modulus for the reinforcing steel, without damaging the structure [1] and [10]. Of these, the most important property for concrete is the compressive strength and for steel, the yield strength [10]. The NDT method to be used will depend on the information needed, size and nature of the project, site conditions and risk to the structure. The NDTs used commonly for concrete are summarized in Table 3.1 below.

3.5 Minor or partially destructive testing

Partially destructive testing involves mechanical equipment which contacts the concrete surface, applies an element of force and invariably destroys or removes a portion of the material in the process. The extent of damage caused depends on the type of equipment and the procedure used. In a deteriorating concrete structure, especially if the deterioration is on the surface or within a short distance from the surface, great caution is required in using those partially destructive test methods which penetrate only a short distance into the material. It is recommended that those tests be always correlated with compressive strength results obtained from drilled core samples [10]. The commonly used minor destructives techniques are listed in Table 3.2 below.

Almost all of these test methods and techniques (listed in Table 3.1 and 3.2 except the coring) measure properties of concrete other than strength. Therefore, a correlation has to be established in order to enable conversion of the results to concrete compressive strength, a necessary prerequisite for assessing structural adequacy. The test equipments and the interpretation of the results also need professional knowledge.

The results of NDT and MDT tests will provide good information that helps to [9]:

- Determine or confirm the cause of the deterioration
- Determine the extent of the deterioration
- Assess current and future performance(of deteriorated and apparently sound areas)
- Enable appropriate and cost-effective remedial measures to be selected

Table 3.1 Nondestructive techniques commonly applied on concrete structures [1] and [10].

NDT	Applications	Advantages	Limitations
Rebound(Schmidt) hammer	Rebound values can be used to estimate uniformity and quality of concrete and also to estimate the compressive strength of concrete	Simple and quick; inexpensive; doesn't need specialist; large coverage of area of concrete surface with minimum time	Does not provide reliable prediction of the strength of concrete; Measurements can be affected by smoothness of surface, moisture content of concrete, type of coarse aggregate, carbonation of the concrete surface etc.
Penetration resistance(Probe)	Penetration resistance can be used for assessing uniformity and quality of concrete and to estimate the compressive strength	Simple, durable, needs little training to use	Primarily measures surface and subsurface hardness; No precise measurement for insitu strength; the probe will leave a hole in concrete surface; coarse aggregates along the path of the probe affect the penetration
Ultrasonic pulse velocity(UPV) method	To determine the general condition and quality of concrete, to estimate concrete strength, to assess the extent and severity of cracks in concrete , and to delineate areas of deteriorated or poor quality concrete	Quick and portable; can penetrate about 11m of good continuous concrete	Does not provide precise estimate of concrete strength, Moisture variations and the presence of reinforcing steel can affect the results, needs skilled personnel to analyze the result
Ultrasonic pulse echo(UPE)	To detect foreign objects (steel and plastic pipe) or discontinuities in the concrete such as cracks, voids etc ; It can measure unknown thickness and presence of delaminations in the thickness	Can operate under water or in the dry	-----
Radar	To detect voids and steel reinforcement; To find deteriorated areas based on the amount of water present	It is a noncontact method having fast data acquisition	Needs highly trained personnel to operate the equipment and for data interpretation

Table 3.2 Common minor destructive techniques used [1] and [10]

Minor destructive tests	Applications	Advantages	Limitations
Pull off test	To estimate the nominal tensile strength of concrete which can be converted to compressive strength	Fast, Results are immediate and less sensitive to concrete ingredients and moisture content. It is used also to evaluate the bonding adequacy of overlays and repair patches	Misleading results for deteriorated concrete surface, damage to the surface
Pull out(CAPO) test[CAPO=cut and pull out]	The pull out force can be correlated with the compressive strength	Reliable correlation between the pull out force and compressive strength	Damage to the surface
Break off test	An in situ direct test measurement of flexural strength of concrete, the measured force then can be converted to compressive strength	Quick and reliable since it is not sensitive to surface defects and concrete condition such as moisture content; suitable for bond strength of overlays and repair patches	Hole is left after the test
Coring	Concrete: To estimate the compressive strength and other parameters from the test such as splitting and modulus of elasticity; to determine the composition , air content, freeze thaw resistance and the presence of internal damage	Visual inspection of the interior concrete possible;	A good knowledge of the structural system is required for locating holes to avoid highly stressed areas; the coring will leave a hole that should be filled with compatible concrete later
	Steel: To obtain samples of reinforcing steel for visual inspection and laboratory testing of small steel specimens		

4 METHODS FOR REPAIR AND REHABILITATION OF REINFORCED CONCRETE HERITAGES/STRUCTURES

4.1 Introduction

Due to the increasing deterioration of reinforced concrete heritage structures, the repair and strengthening industry has become a very hot business in most parts of the world. There are also various methods to prolong the service life of these deteriorated structures varying in their effectiveness and initial cost. There are also various repair principles from organizations, which are sometimes difficult to attain in the real world. These principles have a wide range of influence on reinforced concrete heritage structures which should pass from generation to generation.

In the previous sections the main problems of reinforced concrete structures and their determination using in situ tests are discussed in brief. In this section the techniques that are widely used in the strengthening, repair and rehabilitation of these deteriorated structures will be discussed.

Strengthening or repair of reinforced concrete heritage structures is important for the following reasons [17]:

- To eliminate or to minimize structural problems or distresses resulted from unusual loadings (such as explosion, earthquake etc) or exposure conditions (such as chemical attack, weathering etc), inadequate design, or poor construction practices.
- To conform to current standards and codes
- To change the use of the structure that it was designed for

To select an effective repair method for a deficient concrete member or structure, the effect or damage of the cause (figure 4.1) should be studied deeply using field and laboratory investigation techniques. If the cause of the damage is known, an appropriate strengthening technique can be selected. Mostly the damages are expressed in terms of cracks of a member or structure. Thus deep investigation of cracks should be made including location, crack patterns (horizontal, vertical, diagonal, eggshell, etc.), crack lengths, widths and depths, age or time of occurrence, and reinforcement details including the size and number of bars passing through cracks plus the concrete cover. In addition to these, the best determinant factor for selecting a repair method is to determine whether the crack is active or dormant.

- Active cracks: Active cracks are moving and growing. Examples include cracks resulting from continuing foundation settlement, or cracks acting as contraction and expansion joints. Active cracks require flexible repair materials and special design considerations to allow for future movements. Using a rigid repair material for active cracks typically results in cracking of the repair material and/or the adjacent concrete
- Dormant cracks: Dormant cracks are stable and future movements are not anticipated. Typically, cracking caused by drying shrinkage will be active cracks at the beginning but eventually stabilize and become dormant. Also, if there is enough reinforcing crossing through the crack, future movements are controlled and the crack can be considered dormant. For dormant cracks, use either rigid or flexible repair materials.

4.2 Objectives repair or strengthening

Every repair or strengthening scheme has specific or combination of problems to be addressed. The main objectives of repair and strengthening are:

1. To restore the structural soundness, integrity and load carrying capacity of deteriorated reinforced concrete structures thereby increasing the safety of the structure (Integrity repair).
2. To stop or seal the ingress of aggressive agents that will affect the embedded reinforcing steel(crack sealing)
3. To improve the appearance of the cracked or deteriorated concrete surface (cosmetic repairs).

The repairs have to match the appearance of the rest of the structure in terms of mechanical properties, colour, texture and finish. These days to match the appearance, painting both the old surface and the new patch are becoming common.

The repairing or strengthening techniques are applied to cater for the deficiencies of typical member or structure such as tensile capacity, shear capacity, flexural capacity, compressive capacity, member stability, strength or stiffness or both, exposure conditions such as chloride attack, carbonation, freeze thaw etc [17].

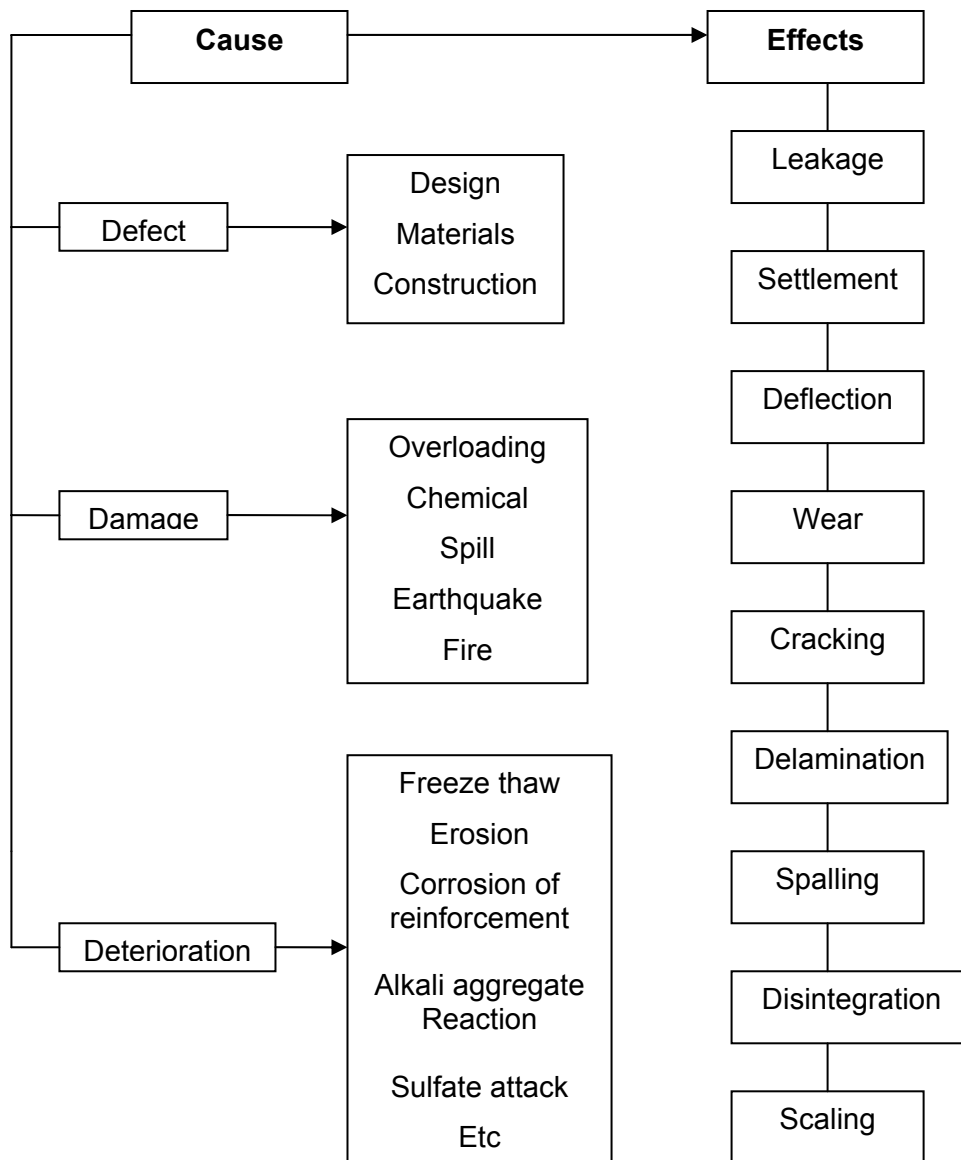

Figure 4.1 most common causes reinforced concrete deterioration and their causes [17]

4.3 Repair and strengthening methods

There are some techniques in reference materials about the repair and rehabilitation of reinforced concrete structures, even though all of them may not be applied for reinforced concrete heritages. But while they are presented separately here, in practice, preservation projects typically incorporate multiple treatments [33]. Heritage structures should pass from generation to generation, so we shouldn't make them extinct by applying incompatible or inappropriate repair methods. Below it is tried to select some techniques that are best fit for the restoration and repair of reinforced concrete heritages, but the challenge still is the heritage structure we are considering is a building, a tower or a bridge or any other structure.

4.3.1 Judicious neglect or do nothing

It is the repair method of taking no action. It needs a deep investigation of the severity of the damage. If the damage causes no operational problems for the structure and if it does not create any future problems and deterioration of concrete, the best way to maintain this structure is to neglect the damages on it. It should be kept in mind that, not all cracks require repair and monitoring the crack may be the best choice. If needed, the crack can be repaired later [30].

4.3.2 Repair of cracking

The method to repair cracks depends on the width, depth and nature of crack (active or dormant) of crack, varying from no repair to compatible patch repairs, injections and use of reinforcement to close the crack opening. The patch repair material should be compatible with the substrate concrete to avoid shrinkage and strength mismatch. Conventional methods for the repair of crack in reinforced concrete structures are presented below:

1. Routing and sealing

It is a nonstructural repair method that consists of enlarging the crack along its exposed face (routing) and filling and sealing it (see figure 4.2) with a suitable joint sealant such as epoxy compounds. This method is simple and economical to repair isolated, fine and large dormant cracks. This method is ideal for horizontal surfaces but can also be used for vertical, overheads and curved surfaces. This method is not effective for sealing active cracks as the crack reoccur after the sealing [1] and [30]. The purposes of the sealant are to prevent:

- Water from reaching the reinforcing steel,
- Hydrostatic pressure from developing within the joint,
- Concrete surface from staining, or
- Moisture problems on the far side of the member from developing.

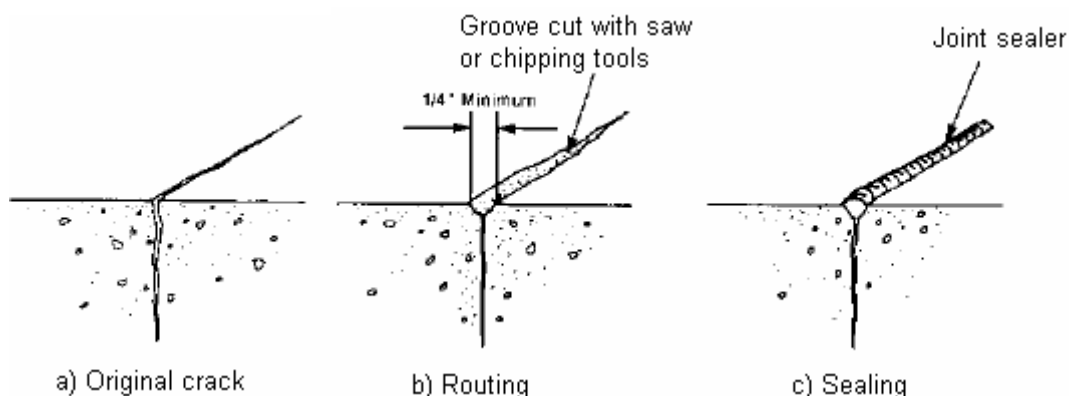

Figure 4.2 Repair of crack by routing and sealing [1]

2. Drypacking

It is a method for filling or repairing deep and dormant cracks(as shown in figure 4.3 below). It is a process of ramming or tamping in to a confined area with a low water-content mortar (minimize shrinkage, tight and durable). It is not generally used for patching shallow depressions, for patching areas requiring filling in back of exposed reinforcement and for patching holes extending entirely through the concrete section. Drypacking can also be used for filling narrow slots cut for the repair of dormant cracks [1] and [30].

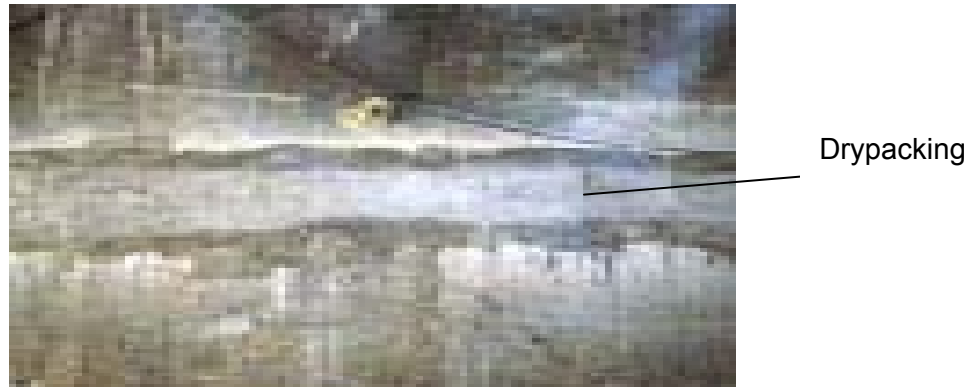

Figure 4.3 Dry packing a low-water cement mortar into a widened crack is an economical repair option for wide, dormant cracks [30].

3. Additional reinforcement

This is the provision of additional conventional (Figure 4.4) or prestressed reinforcing steel to repair a cracked concrete section due to tensile forces. Post-tensioning of the reinforcement is required if major portion of the member to be strengthened or when the cracks have to be closed (figure 4.5) [1].

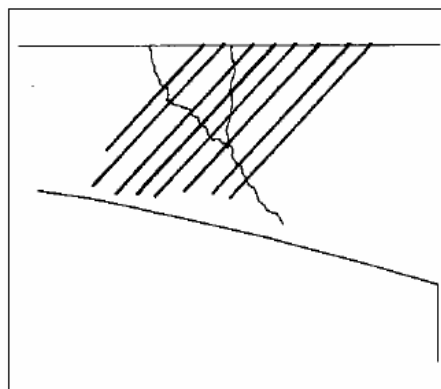

Figure 4.4 Crack repair using conventional reinforcement orthogonal to the crack plane[1]

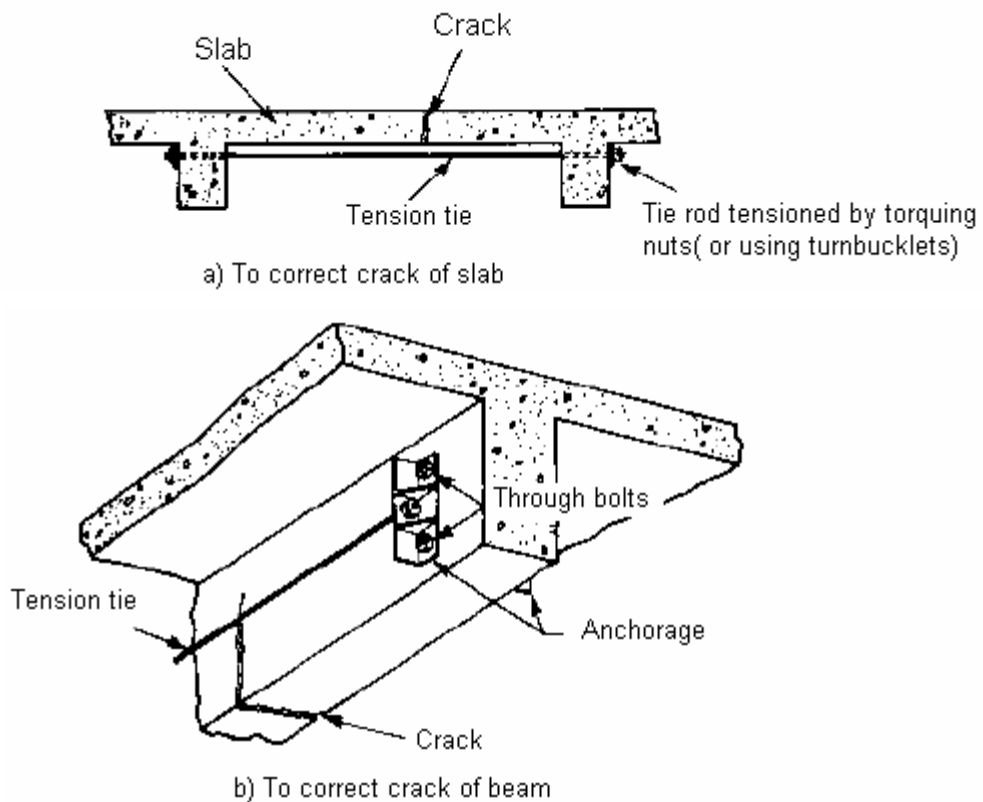

Figure 4.5 Crack repair with use of external prestressing strands or bars to apply a compressive force the close the crack [1].

4. Drilling and plugging

It consists of drilling down the length of the crack and grouting it to form a key as shown in figure 4.6 below. This technique is mostly used for repair of vertical cracks in walls, where the cracks run reasonably straight lines and are accessible from one side [1].

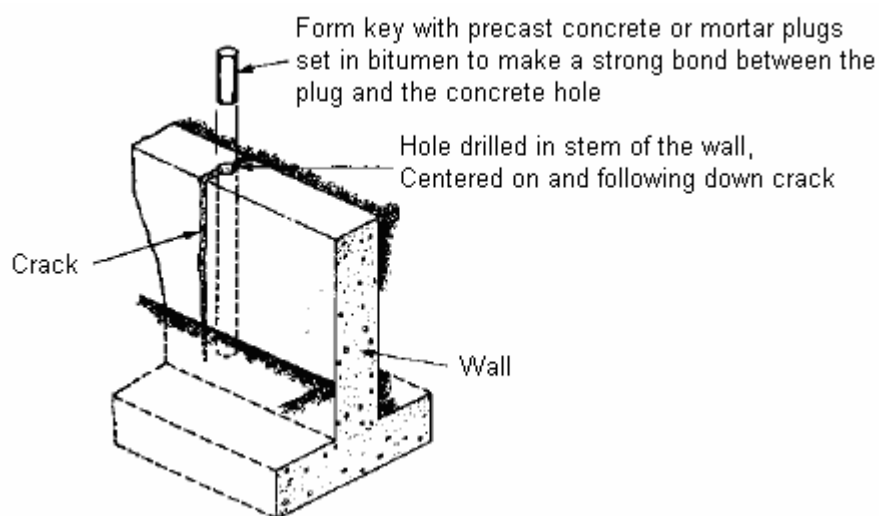

Figure 4.6 Repair of crack by drilling and Plugging [1]

5. Chemical Grouts

These chemical grouts are gel or solid precipitates used to fill voids or cracks in the concrete surface (figure 4.7). They can be applied in moist environments and in fine fracture areas. Their demerits include lack of strength; need skilled personnel, flammable etc [1].



Figure 4.7 Application of chemical grout [31]

6. Hydraulic-cement grouting

Hydraulic-cement grout is generally used to seal dormant cracks, to bond subsequent lifts of concrete that are being used as a repair material, or to fill voids around and under concrete structures. It consists of cleaning the concrete along the crack, installing grout nipples at intervals, sealing the cracks, flushing the crack to clean it and finally grout the entire area. The w/c ratio should be kept low to maximize strength and minimize shrinkage. The fluidity of the grout depends on the width of the crack [1].

7. Polymer impregnation

Polymer impregnation can be used for repair of cracks. If the cracked concrete is dried properly, the flooding of the polymer will repair the crack structurally. Large voids or broken areas can be filled with fine and coarse aggregate before flooding them with the polymer [1].

8. Polymer injection

Polymer injections typically of epoxies are widely used as a structural crack or joint repair method to form a monolithic structure as the tensile strength of epoxy is very high as compared to concrete [1]. The technique generally consists of drilling holes at close intervals along the cracks, in some cases installing entry ports, and injecting the epoxy under pressure (figure 4.8). This technique is effective for dormant cracks as cracking will reoccur after injecting an active crack (Rigid repair). To maintain its effectiveness, it should be used in dried cracks. If the cracks are active and it is desired to seal them with sealants while allowing continued movement at these locations, it is necessary to use a grout (such as

Water-activated polyurethane grouts) that allows the filled crack to act as a joint(Flexible repair) [30]. The epoxy injection repair has two important functions:

- it effectively seals the crack to prevent the damaging moisture and other aggressive agents entry,
- It monolithically welds the cracked reinforced concrete structure together, that is structural integrity.



Figure 4.8 Epoxy resin injection [32]

9. Stitching

Stitching involves drilling holes on both sides of the crack and anchoring U-shaped metal staples (stitching dogs) with short legs across the crack as shown in Figure 4.9. The cracks are created as the tensile strength of the concrete is small or negligible, so the stitching will restore the tensile capacity at the cracked section by minimizing further opening or propagation of the crack. Stitching a crack tends to stiffen the structure, and the stiffening may accentuate the overall structural restraint, causing the concrete to crack elsewhere. Therefore, it may be necessary to strengthen the adjacent section with external reinforcement embedded in a suitable overlay. Stitching should be applied on the tensile face of the member, where major cracks appear [1].

Note variable length, location, and orientation of the dogs so that tension across the crack is distributed in the concrete rather than concentrated on a single plane

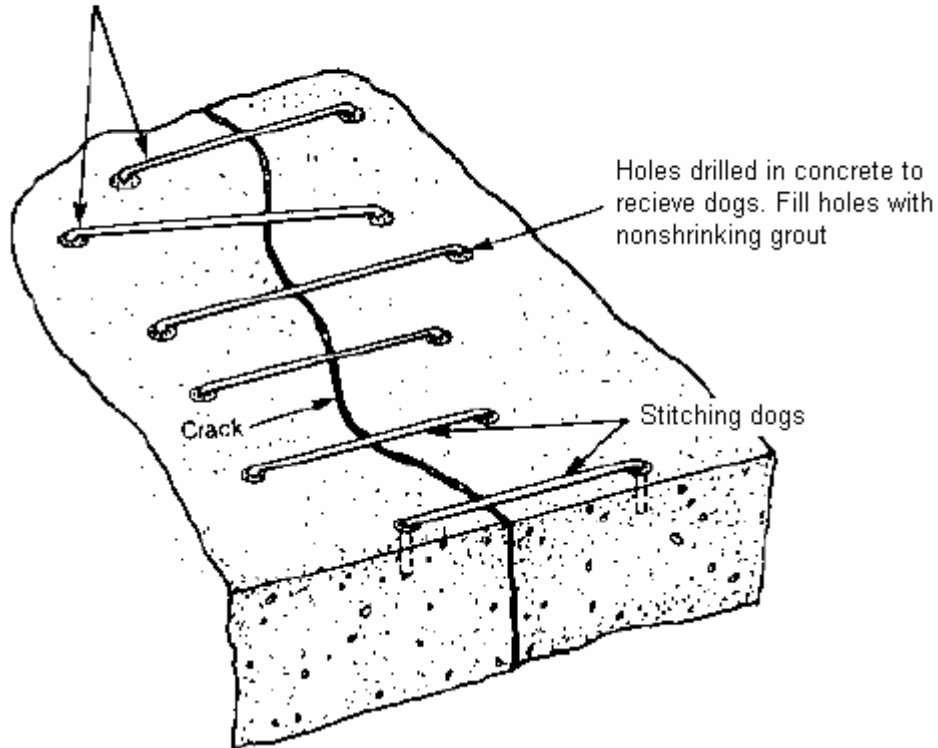

Figure 4.9 Repair of cracking by stitching [1]

4.3.3 Repair of spalling

Repair of spalled reinforced concrete involves the removal of the deteriorated concrete, cleaning and treatment of reinforcing bars, and placing compatible patch material with good bond between the substrate concrete and the repair material, that dovetails to the existing concrete surface. Compatible matching of patch material to the existing concrete is critical for both appearance and durability.

1. Conventional Concrete placement

After the cause of the deterioration of the concrete surface is surveyed, the defective concrete will be removed (see figure 4.10) and a new concrete that will minimize the cause of deterioration will be placed. The new concrete should have low w/c ratio and high percentage of coarse aggregate to minimize shrinkage cracking and that can prevent or reduce the cause of the original concrete [1].



Figure 4.10 Removal of defected concrete for replacement Genesee Hospital Doctor's Building - Rochester, New York [29]

2. High strength concrete

This method is an extension of conventional placement method but higher concrete strength. It is used where improved resistance to chemical attack, better abrasion resistance, improved resistance to freezing and thawing, and reduction of permeability is required [1].

3. Polymer concrete/mortar

Polymer concrete/mortar is widely used for patching and overlay of deteriorated reinforced concrete structures. Polymer concrete is quicker setting, has good bond characteristics, good chemical resistance, and high tensile, flexural, and compressive strength compared to conventional concrete [1].

4. Polymer Portland-cement concrete

Polymer Portland cement concrete has superior adhesive properties and can be used in thinner patches and overlays than conventional Portland-cement concrete. It has higher strength and adhesive property, excellent resistance to freeze thaw damage, high degree of permeability and improved resistance to chemical chemicals, abrasion etc [1].

5. Rapid hardening cements

Rapid hardening cements are widely used for patch repairs, cold weather embedment and anchoring. They are used when immediate strength gain of the repair material is needed.

6. Shotcrete or spraying concrete

This is the application or projection of concrete on prepared concrete surface at high velocity. The deteriorated concrete surface should be prepared before the application of shotcrete. It is an effective method, if applied properly, which is a structurally adequate and durable

material that creates excellent bond with the existing prepared concrete surface. Good surface preparation and application technique or skilled personnel are important for the effectiveness of the method. It is widely used in a repair project where thin repair sections and large surface areas with irregular contours are involved [1].



Figure 4.11 Application of shotcrete on external wall and inside of dome

7. Shrinkage compensating concrete

Shrinkage compensation concrete is used to repair drying shrinkage damaged reinforced concrete structures such as slabs. Shrinkage-compensating concrete will increase in volume after setting and during hardening. The expansion of the concrete will induce tension in the reinforcement and compression in concrete thereby preventing tension in concrete. It can be used as a bonded or unbonded topping over a deteriorated or cracked concrete slabs [1].

8. Polymer coatings

Polymer coatings are effective in protecting the concrete from abrasion, chemical attack and freeze thaw. Epoxy resins are used as protective coatings for concrete structures because of their impermeability to water and resistant to chemical attack. The coatings should not act as vapor barrier from inside that will cause the disruption of the coatings from freeze thaw cycles [1].

4.3.4 Repair of overloading and deflection (Strengthening and upgrading)

Deflection and overloading can indicate significant structural problems and often requires the strengthening or replacement of structural members. Deflection and overloading can lead to structural failure and serious safety hazards. Their effects are expressed mostly by cracking,

spalling and out of plane movement of the members. The problems due to overloading can cause the following three typical cases:

- 4) Flexure or bending stresses in members
- 5) Shearing stresses in members
- 6) Punching stresses in members

Most of the strengthening or upgrading methods are applications of materials different from the original concrete substrate. This leads to the incompatibility between the repair material and substrate if proper care is not taken, which affects the long-term performance of these methods. Every repair or strengthening method needs maintenance in the future, the frequency of maintenance depending on the location of the repair material or system and the type of repair material.

The applications of these strengthening or upgrading methods also include the damage of some part of the existing structure to apply the strengthening methods. This is mostly against the principles of conservation (minimum intervention etc). But these methods are invariably used in most parts of the world even though.

Some of the common methods used to repair structures damaged by deflection and overloading are presented below:

1. Overlays

This method is important if the structural elements such slab, wall, beam, column etc are found insufficient for the service and ultimate state conditions or if the structure is exposed to aggressive environments or agents. It consists of layering or increasing the thickness of the member by putting extra layer of concrete on the existing surface to restore a spalled or disintegrated concrete surface or to increase the load carrying capacity of the underlying concrete surface. The overlay can consist of latex-modified concrete, epoxy-modified concrete and epoxy mortar and concrete. The overlay material should have good bonding characteristics, higher strength, lower water and other aggressive agents' permeability [1] and [17]. The overlay material should avoid or minimize the cause of deterioration of the original reinforced concrete surface.

2. Fiber reinforced polymer(FRP)

Various types of Fiber reinforced polymer (FRP) products are widely used around the world especially in the repair and strengthening of reinforced concrete structures. Fiber-reinforced polymers (FRP) are composed of fibers and a polymer matrix. The fibers provide the primary strength and the matrix holds the reinforcement in its proper orientation for optimum

properties. The most widely FRP products used are made from glass fiber (GFRP), carbon fiber (CFRP) and aramid fiber (AFRP).

The various products of FRP include laminates (sheets), rods and tendons. The laminates are bonded external to the structure to be strengthened, and the rods and tendons are embedded in the concrete to replace the function of the reinforcing steel. They are used to reinforce existing structures, either to restore the minimum performance requirements or to extend the function of the structure [7]. This strengthening method has several advantages over the traditional ones, especially due to higher strength, low weight and improved durability of the composite material [18].

FRP as reinforcement in existing structures

The various products of FRP include laminates (sheets), rods and tendons. The laminates are bonded external to the structure to be strengthened, and the rods and tendons are embedded in the concrete to replace the function of the reinforcing steel. The most widely use of FRP in existing reinforced concrete structures is as external reinforcement where the FRP is externally bonded to the structural member.

They are used to reinforce existing structures, either to restore the minimum performance requirements or to extend the function of the structure [7]. This strengthening method has several advantages over the traditional ones, especially due to higher strength, low weight and improved durability of the composite material [18].

Applications of FRP include:

1. Reinforcement of concrete columns by wrapping FRP sheets around them to improve the structural integrity and to prevent buckling of the reinforcement
2. Flexural strengthening of beam and slab or deck of bridges and buildings by externally bonded reinforcement or near surface mounted FRP
3. Shear strengthening of beam
4. Wrapping damaged bridge piers to prevent collapse

The most widely uses of FRP include:

- Strengthening of deteriorated reinforced concrete structure due to load carrying capacity problems(bending, shear ...)
- To strengthen reinforced concrete structures that are not designed for earthquake actions
- To strengthen a structure (typically building and bridges) for the change of use of building for new live load requirements as shown in figure 4.12 and 4.13.



Figure 4.12 strengthening of the roof slab Kings College Hospital, London, UK [42]

- To guarantee future structural safety

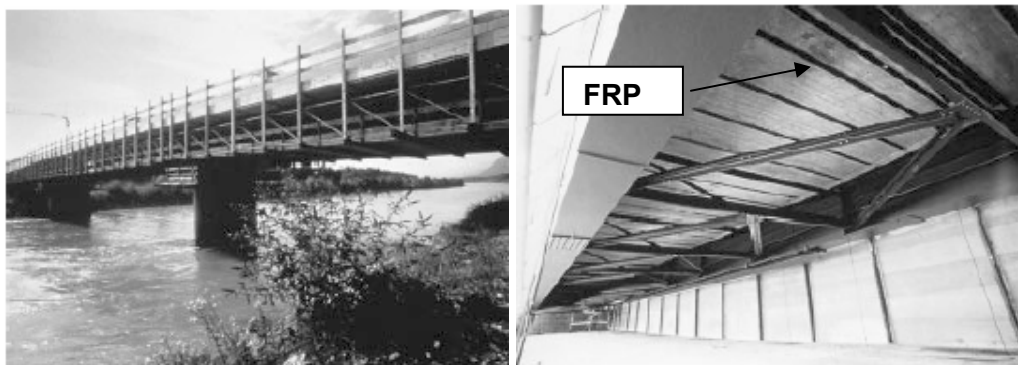

Figure 4.13 Strengthening of the Rhine Bridge Oberriet, Meiningen, Switzerland [42]

Even though these FRP products have lots of advantages over conventional methods of strengthening, their limitations and disadvantages should be considered when they are applied for a specific repair or strengthening project. The bond condition between the FRP and concrete surface, their exposure condition etc should be studied before their application to the structure to be strengthened.

3. Steel plates and Post-tensioning

Steel plates are applied to deficient structural members to strengthen or upgrade the capacity of the member. But as can be seen from the figures below, they need the destruction of the member by drilling to tie the plates in to the concrete and extra overlay material to cover them to similarize the member.

Post tensioning of members (typically in bridge members) is another strengthening and upgrading of members when they are found deficient for the demand. The reinforcement can be post-tensioned insider or outside of the member.

Flexural strengthening of members [17]

- a) **Concrete Overlays:** this can include the addition of extra reinforcement and concrete cover to the existing deficient member. It is mostly used for buildings and bridges.

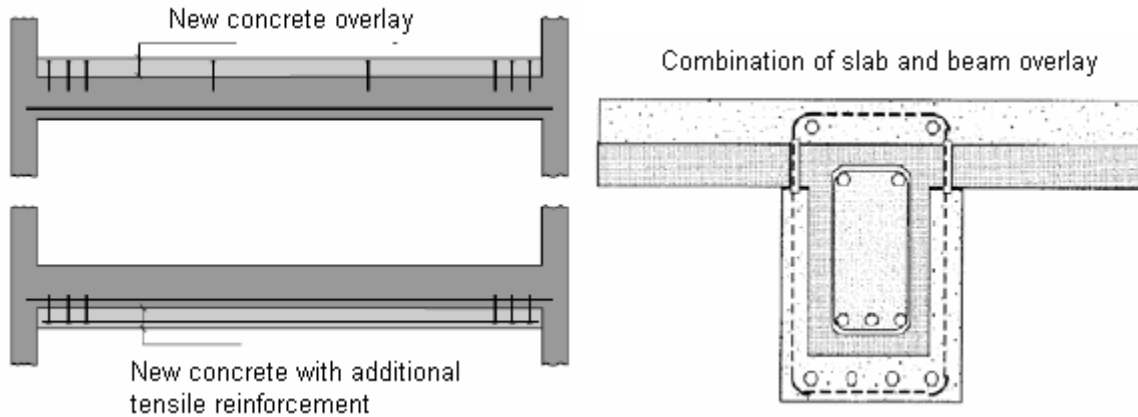

Figure 4.14 Slab and beam overlays [17]

- b) **Externally bonded reinforcement:** by using steel plates and Fiber Reinforced Polymers (FRP). Steel plates are mostly used in the repair and strengthening of bridges, but FRP is currently used for both bridges and buildings and other structures.

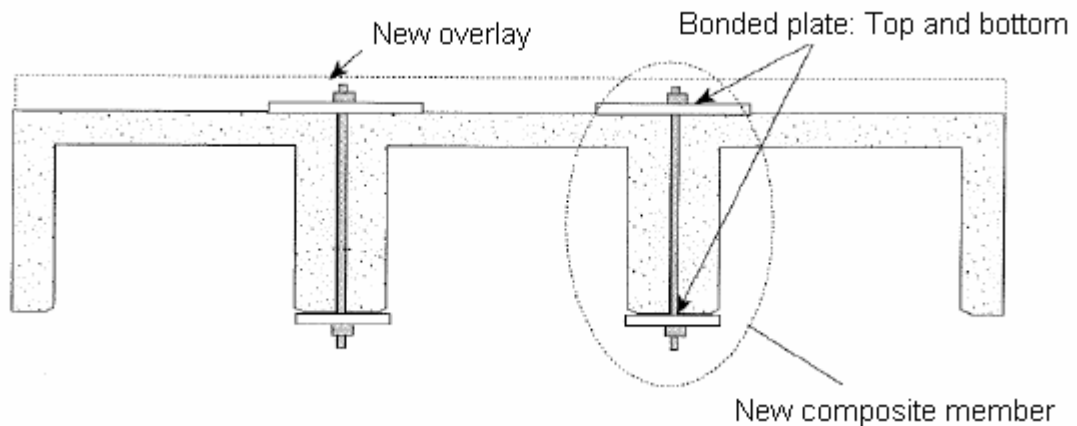

Figure 4.15 externally bonded plates using steel plates [17]



Figure 4.16 externally bonded plates using FRP [21]

c) **External post tensioning:** it is widely used in bridges.

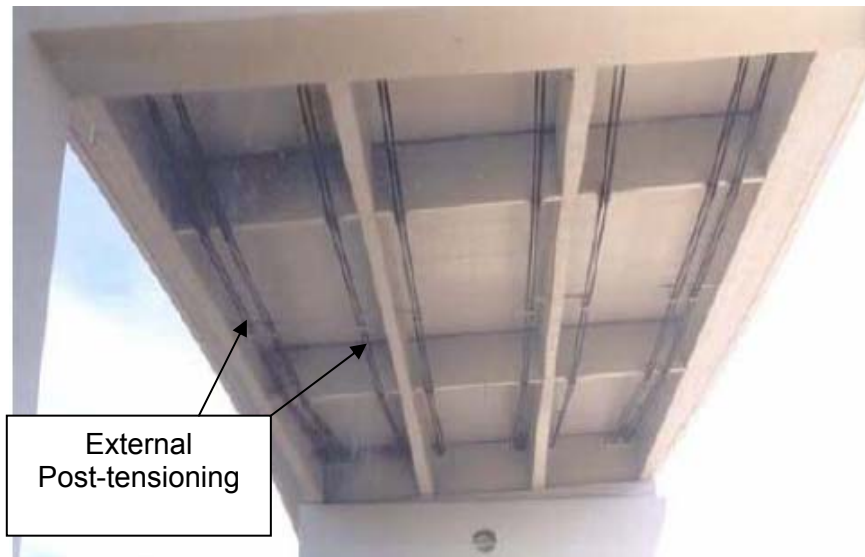

Figure 4.17 external post-tensioning of a bridge [17]

d) **Span length shortening:** this can create a negative moment at the new supports which can create tension on the upper side of the member, which can cause damage if provision at the new support is not provided.

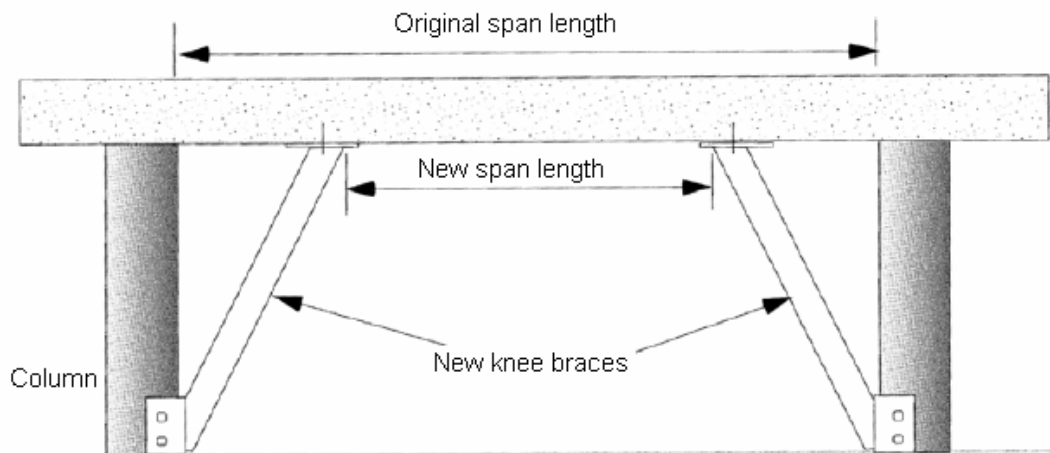

Figure 4.18 span length shortening [17]

Shear strengthening of members

- a) **Concrete overlays:** this can include the addition of shear reinforcements or stirrups and a cover concrete. It can be used both for buildings and bridges.



Figure 4.19 addition of steel reinforcement and concrete overlay [17]

- b) **Internally placed reinforcement:** It is common in bridges.

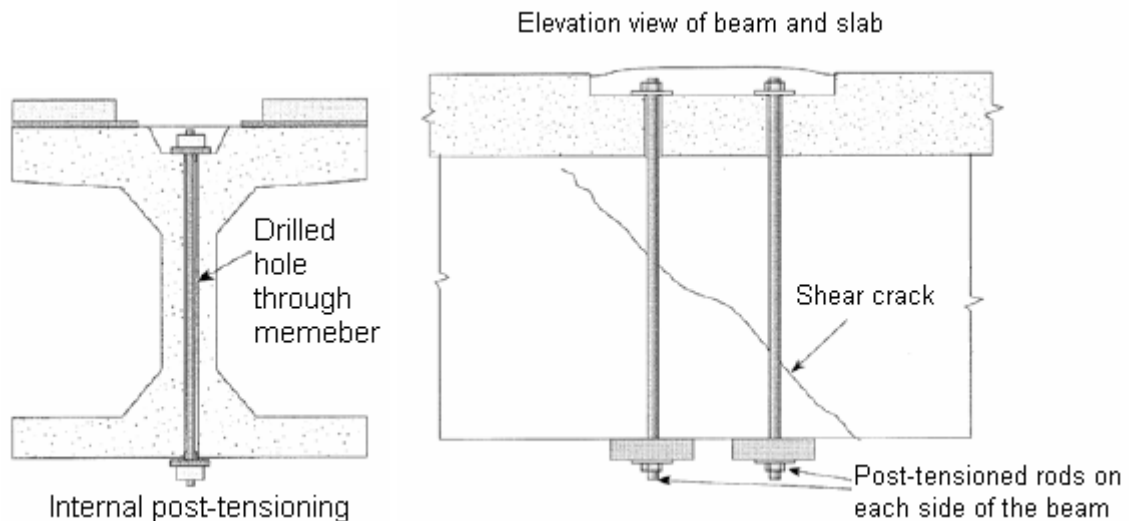

Figure 4.20 internally placed reinforcement of I-section beam and T-beam [17]

- c) **External post-tensioning:** it is mostly used for bridges

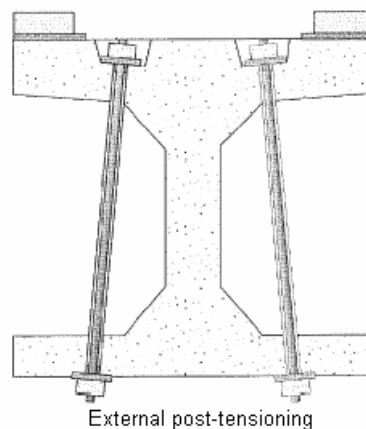

Figure 4.21 external post-tensioning [17]

Punching strengthening [17]

- a) **Increase the depth of the member or overlay:** this can include the addition of extra concrete layer on the member to increase the punching depth or the influence area of punching. This method is widely used both for buildings and bridge structures.

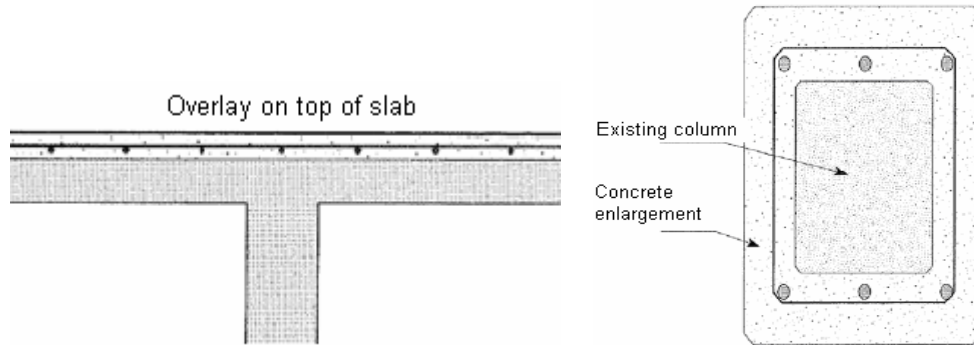

Figure 4.22 shear strengthening by overlay [17]

- b) **Transversal reinforcement**



Figure 4.23 shear strengthening using internal post-tensioning and using bolts [17]

- c) **Fiber reinforced polymers (FRP)**

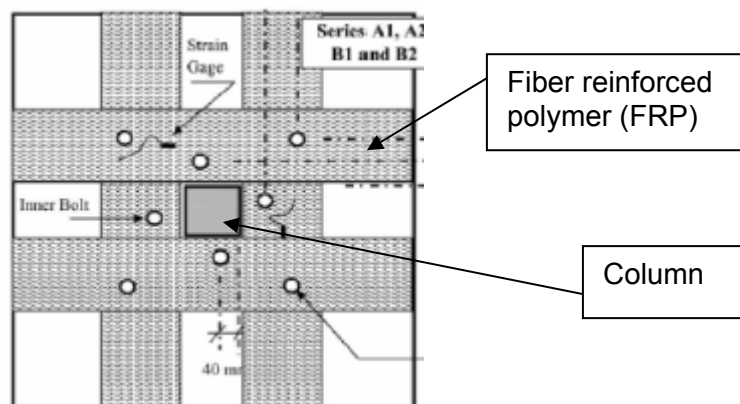

Figure 4.24 punching strengthening using FRP [17]

- d) **Enlarge the column head with concrete:** this method is used to increase the punching perimeter and depth.

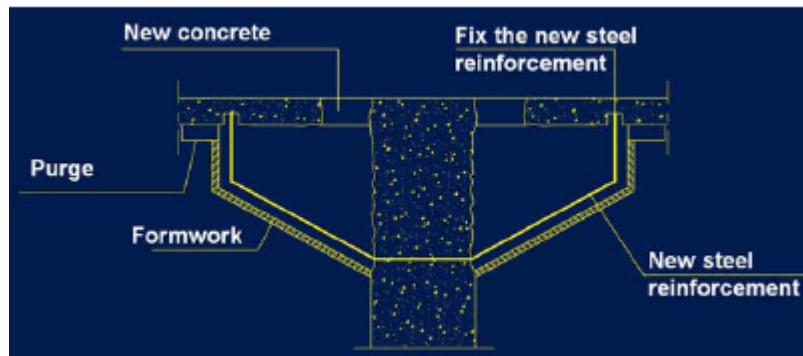

Figure 4.25 enlarging the column head of a column to increase punching resistance [17]

- e) **Enlarge the column head with steel:** steel plates and ribs are applied on the influence area of punching to resist the punching force.



Figure 4.26 enlarging column head with steel plates and ribs [17]

4.3.5 Seismic upgrading using shear walls

Reinforced concrete structures built in the early and middle 20th century were not designed for earthquake actions. If there is no reinforced concrete shear wall in the load bearing system to resist lateral loads and lend rigidity to the building, the effect of earthquake will be more. Due to frequent occurrence of earthquakes nowadays, these structures are becoming deteriorated. Recent developments have shown that is able to strengthen them using FRP and by introducing shear walls on the existing structure.

The use of external shear walls on the strengthening of Primary schools in Turkey against earthquakes is shown in figure 4.27 below [22].



Figure 4.27 shear wall strengthening of primary school building against earthquake [22].

4.3.6 Cathodic Protection and protective surface treatments

Cathodic protection and surface treatments are discussed in section 2.4.8 of this paper.

5. COMPATIBILITY OF REPAIR MATERIALS

5.1 Introduction

The repair of most reinforced structures is becoming a common market for contractors in most parts of the world. Most of these structures are in need of repair because of the aging and design life of the structures in addition to the aggressive environmental problems and unexpected loading conditions. Lots of repairs are also undertaken in the past, but it cannot be said that all the repairs were effective, mainly because of the difference in properties between the substrate (original concrete) and the repair material, that is compatibility. Compatibility of the repair material with the existing substrate is very important to get good repair of the deteriorated reinforced concrete structures. This forces the use of simple repair approach which uses repair material with properties close to the existing substrate.

Reinforced concrete repairs in the first half of the 20th century were relatively simple and used primarily replacement of damaged or deteriorated concrete with conventional Portland cement based concretes, mortars, grouts or gunites (sprayed mortars). But the use of Portland cement based repair materials showed unsatisfactory outcomes. Since after the 1960's new enhanced concrete repair materials such as polymer modifiers for Portland cement based products and pure polymers such as epoxy resins etc are introduced in to the repair industry [19].

To get an effective repair system, the following key factors about the repair material should be studied taking in to account the existing substrate concrete[1] and [19]:

- The properties of the repair material;
- The sensitivity and durability of the repair material;
- The physical and chemical exposure conditions to which the repair material will be subjected ;
- The physical and chemical compatibility of the repair material with the substrate concrete, before making a final selection as to which type of repair material to use.

5.2 Patch Repairs

The repair materials typically consist of plain cementitious mortar; polymer modified cementitious mortar and resin mortar, the main difference between these repair systems being their mechanical properties. The plain cementitious mortar has lower mechanical properties closest to most substrate concretes. But Polymer modified cementitious mortars and resin mortars are of higher strength and resistance and should be used if the following conditions exist [19]:

- If the substrate is deteriorated by aggressive exposure conditions such as chemical attack, which needs higher resistance
- If thin hand applied repairs are needed
- If the repair is required to be carried out in below freezing temperatures, or rapid setting and hardening and early strength gain characteristics are required.

Most of the factors that affect the compatibility of repair in reinforced concrete structures are shown in figure 5.1. [19] states that from all the factors, it is the dimensional compatibility that is very important and governing factor.

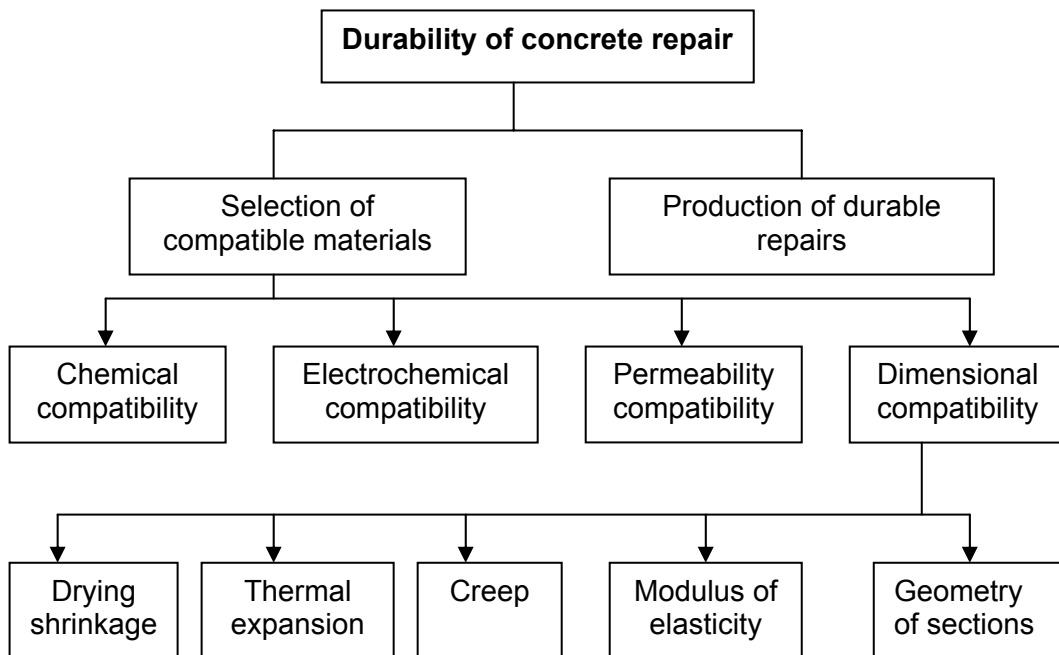

Figure 5.1 Factors affecting durability of concrete repairs [19]

5.2.1 Dimensional compatibility

Dimensional compatibility is the ability of the repaired area to withstand volume changes or restrained contractions without loss of bond and delamination; and includes the ability of the repaired area to carry its share of the applied load without distress. The loss of bond between the substrate and the repair material occurs due to the following factors [1] and [19]:

- Excessive shrinkage strains
- excessive expansion in certain shrinkage compensated repair materials;
- excessively high thermal expansions followed by cooling and shrinkage occurring during early setting and hardening reactions
- Excessively high thermal expansion in repair materials due to temperature changes.

The size, shape and thickness of the area being repaired, the amount of reinforcing and anchorage [if any], modulus of elasticity, strain capacity and creep of the repair material also affect the dimensional compatibility of reinforced concrete.

Thus, the repair material should neither shrink nor expand once installed and should have the same modulus of elasticity and thermal expansion characteristics with that of the substrate concrete. But to get absolute repair materials with these properties may be a challenge and thus repair materials which are as close in their properties as the substrate should be used so that they will not shrink or expand to the extent they crack. To minimize the cracks, steel or synthetic fibers can be incorporated in to the repair material.

5.2.2 Bond compatibility and durability

The performance of any concrete repair is highly dependent on the quality of bond of the repair material to the substrate concrete (bond compatibility) and how long it will be maintained (bond durability). When the repaired element or structure is subjected to excessive stresses, failure will occur in the weakest portion either in the repair material or in the substrate or the bond between them. The main causes of the stresses in the bond interface of repairs are:

- Plastic and drying shrinkage strains, creep etc in the repair material
- Heat generation from early heat of hydration or polymer reaction thermal stresses
- Dead loads and changing live loads, dynamic loads, impact loads, changes in moisture gradient in the repaired system
- Thermal stresses from temperature changes, or external heat sources.

Apart from the properties of the repair material, the bond compatibility and durability depends on:

1. Surface preparation of the substrate concrete and its roughness;
2. The optimal moisture condition of the substrate concrete, which depends on the repair material being used.
3. The temperature of the substrate concrete

5.2.3 Structural and mechanical compatibility

There are two kinds of repairs that are mostly done on reinforced concrete:

1. Non structural or cosmetic repairs: in which stress-carrying is not a major consideration for the repair,

2. Structural repairs: where the repair patch is required to carry the load originally carried by the removed concrete. There should be a property match between the patch repair material and the structural concrete.

In addition to repair compatibility of shrinkage and coefficient of thermal expansion, which can occur in nonstructural repair also, compatibility in modulus of elasticity and creep characteristics between the repair material and the substrate concrete is required for structural repairs. Such incompatibilities exist mostly in polymer modified concrete repair materials. Repair materials with excessively high stiffness (modulus of elasticity) should be avoided, as this may cause the repaired area to attract undue load.

The general requirements of patch repair materials ([1] and [19]) for structural compatibility are presented in table 5.1 below.

Table 5.1 General requirements of patch repair materials for structural compatibility [19]

Property	Relation of repair mortar(R) to concrete substrate(C)
Strength in compression, tension and flexure	$R \geq C$
Modulus in compression, tension and flexure	$R \sim C$
Poisson's ratio	Depends on modulus and type of repair
Coefficient of thermal expansion	$R \sim C$
Adhesion in tension and shear	$R \geq C$
Curing and long term shrinkage	$R \geq C$
Strain capacity	$R \geq C$
Creep	Dependent on whether creep causes desirable or undesirable effects
Fatigue performance	$R \geq C$

Even though polymer modified concretes show incompatibilities (as compared to Portland cement based concrete) with the substrate concrete, they have the following good advantages:

- low permeability to ingress of chlorides and other aggressive chemicals;
- ability to rapidly set and harden and for the structure to be quickly returned to service
- excellent chemical resistance to attack from many aggressive chemicals;
- Ability to be applied in much thinner layers/sections than Portland cement based repair concretes.
- They have better tensile, adhesive and bond strengths; low shrinkage values and the ability to redistribute stresses at the bond interface.

5.2.4 Electrochemical compatibility

If the deterioration of reinforced concrete is due to reinforcement corrosion, the repair includes the removal of deteriorated concrete and replacing it with a new patch repair. Electrochemical compatibility is the ability of the repair system to inhibit subsequent corrosion of reinforcement, both within the repair area and in the surrounding non-repaired reinforced concrete. Researches showed that the use of repair materials of similar composition, density and permeability to the surrounding concrete in the repair area will maximize electrochemical compatibility.

5.2.5 Permeability compatibility

The permeability compatibility of the repair material with the substrate concrete is very important. The repair material should have the following properties [1] and [19]:

- The repair material should prevent the diffusion or ingress of chloride ions, thereby maintaining electrochemical compatibility between the substrate concrete and repair material;
- The repair material should allow the substrate concrete to breath, as low permeable or impermeable repair material could cause saturation of the substrate concrete behind the repair which can cause failure at the bond line or due to freeze thaw if the substrate is nonair-entrained concrete.

5.2.6 Chemical compatibility

Chemical compatibility involves selection of a repair material such that it does not have any adverse effects on the repaired substrate component or structure. For example:

- The repair material shouldn't release chloride ions which could interfere with reinforcing steel corrosion inhibition in the substrate concrete
- The repair materials shouldn't add sodium or potassium ions in to the substrate concrete which will aggravate alkali-aggregate reactivity (AAR) in a substrate concrete made with an AAR susceptible aggregate.
- The repair material should not create electrochemical incompatibility that will induce corrosion of embedded steel reinforcement; and etc.

5.3 FRP and protective surface treatments

FRP is a good repair material that has good advantages in mitigating the deficiencies of reinforced concrete structures such as flexure, shear etc. Several studies show the debonding of FRP from the concrete surface due to strain incompatibility.

The incompatibility problem that occurs in protective surface treatments is the debonding and cracking of a coating system. In general, even when the concrete surface is well prepared,

the surface layer/concrete interface will still be very vulnerable. When the substrate is not prepared properly, the concrete itself is often the weak link in the system. The problem of cracking and debonding of concrete coatings is due to restrained stresses [7].

5.4 Corrosion Protection techniques

Most of the corrosion protection techniques are developed for new concretes and it is questionable to think that they can be absolutely effective in inhibiting corrosion in old concretes as the electrochemistry in a repair system differs from that occurring in new constructions.

- If the steel in the repair area is embedded halfway in existing, chloride-contaminated concrete and halfway in new repair material, strong corrosion cells may develop. The half of the bar in the existing concrete will become anodic and will corrode at a rapid rate, driven by the other half acting as a cathode [20].
- If concrete is removed completely from around the reinforcement and replaced by a repair material, reactions similar to those mentioned above can accelerate the corrosion of the steel at the perimeter of the repair in the surrounding existing concrete as shown in figure 5.2 [20].

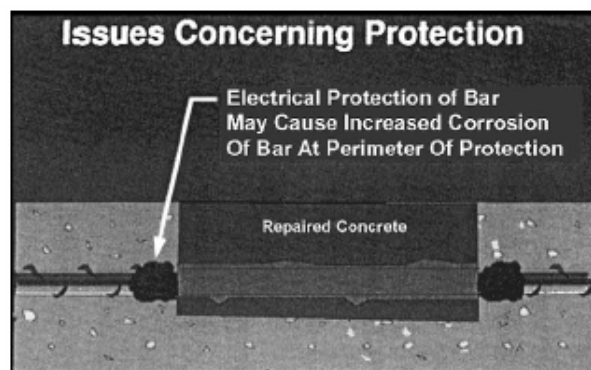

Figure 5.2 Corrosion of reinforcement at the repair perimeter [20]

According to [34], the risk of corrosion in concrete repair due to electrochemical incompatibility between “old” and “new” portions of the structure is always present.

6 PRINCIPLES FOR THE REPAIR OF REINFORCED CONCRETE STRUCTURES

6.1 Introduction

Still now there are no principles for the repair and protection of reinforced concrete heritage structures. But due to the controversy between modern and heritage structures, restorers are using the usual norms of repair and protection of European Standards EN 1504. The principles of repair and protection are set out in the European Standard EN 1504. These principles can be extended to historical structures, but it needs a deep investigation when the repair methods behind these principles of repairs are applied to the historic reinforced concrete fabric.

The structure of EN 1504 is as shown in figure 6.1 below.

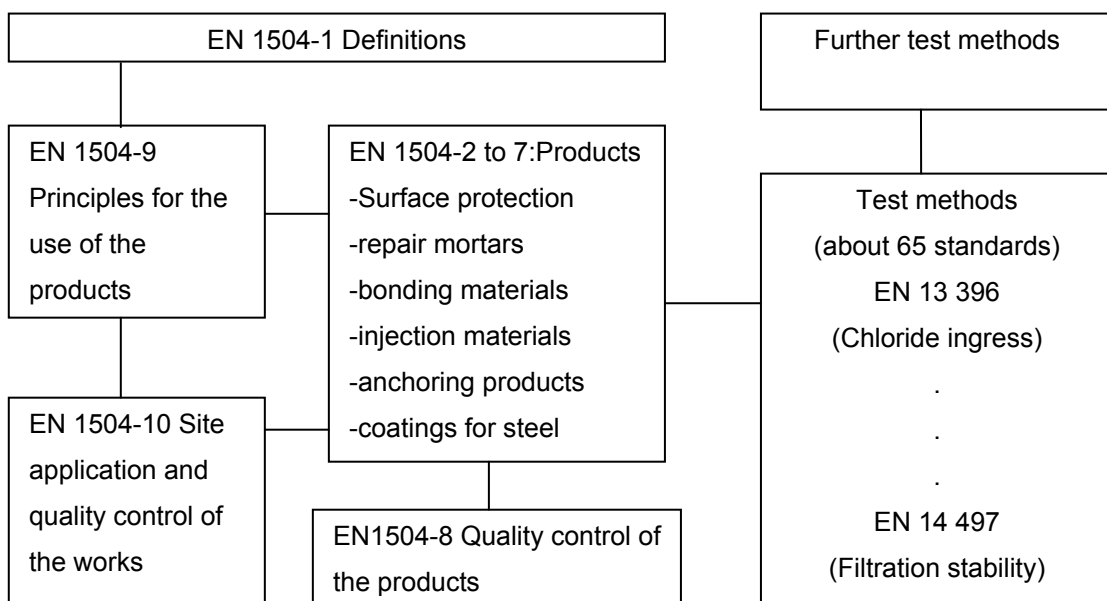
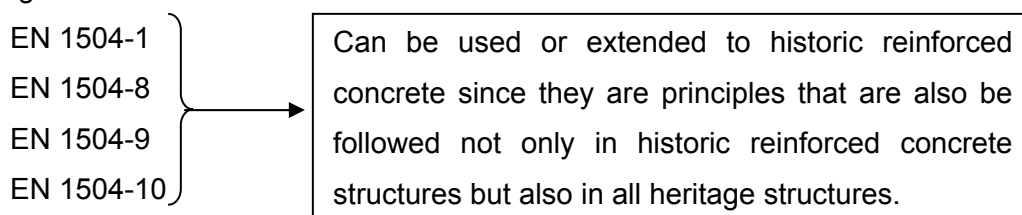

Figure 6.1 Structure of EN1504 [21]

From the structure of EN 1504, the principles can be extended to heritage reinforced concrete; but care must be taken when using principles related to repair materials and repair methods, that is EN 1504-2 to 7. The repair materials that will be used should have same properties to the substrate so as to act together after the repair material is placed. The repair methods should not be invasive and should not change the original appearance of the heritage.



Any repair and protection scheme of heritage structures follows certain principles that are used to maintain the well being of the heritage structure. The principle of repair and protection of reinforced concrete structures, EN1504-9(General principles for the use of products and systems), follow the steps in figure 6.2 :

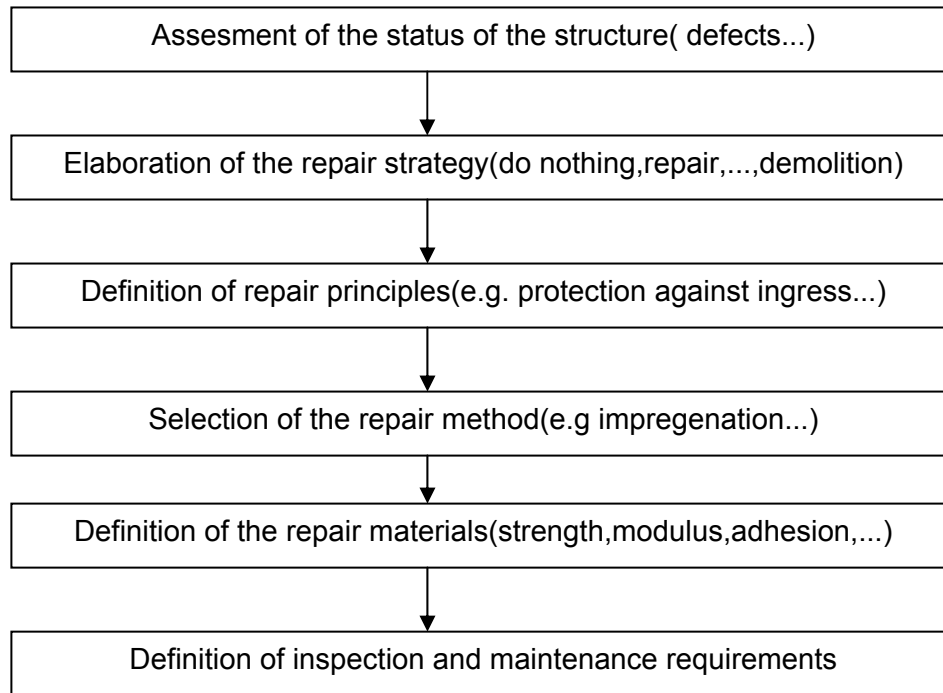

Figure 6.2 systematic planning of repair according to EN 1504-9 [21]

The principles of repair and protection steps indicated above in figure are also those principles that are mostly followed in any heritage structure repair. What usually matters in the repair of heritage structures are the appropriate repair materials to be used and the method of repair or repair materials application.

6.2 Defects in reinforced concrete heritage

The most common causes of deterioration/distress/defect of reinforced concrete heritages are discussed in previous sections. The common causes of defect of reinforced concrete structures are classified in to two according to EN1504 as shown in figure 6.3 [21]:

1. Defects in concrete
2. Defects caused by reinforcement corrosion

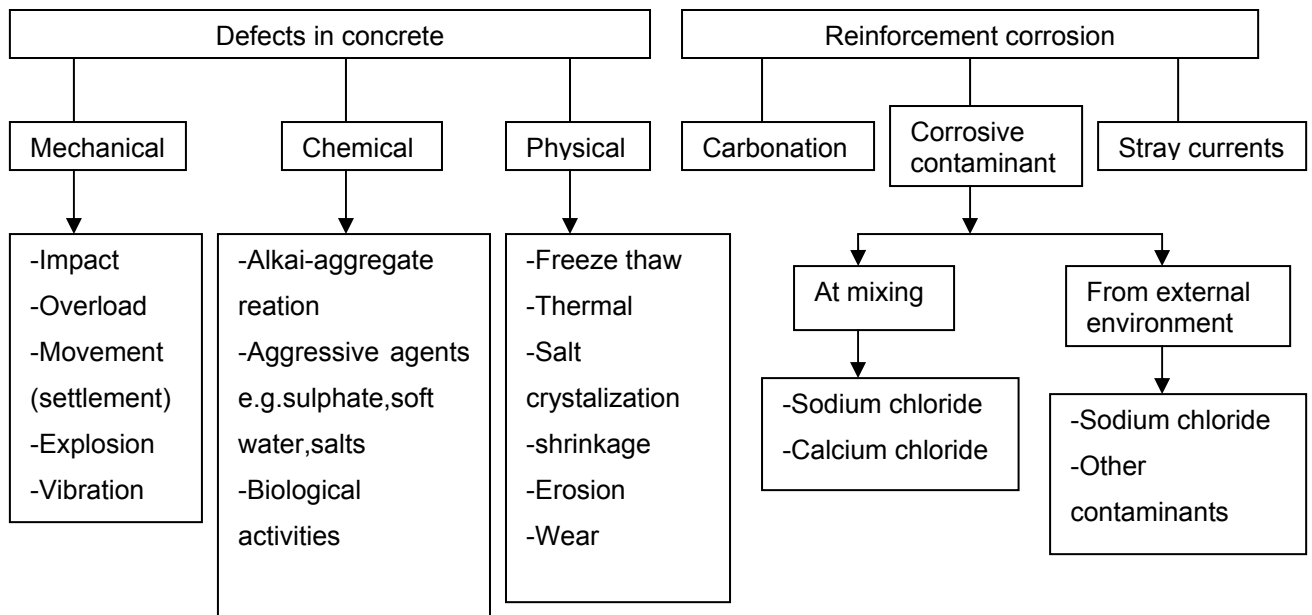

Figure 6.3 common causes of reinforced concrete deterioration [21]

6.3 Options, principles and methods

A thorough understanding of the repair method to be applied on historic reinforced concrete is needed before the repair is placed onsite not only to keep our heritage safe but also to select cost-effective method of repair. According to EN 1504-9 the following options shall be taken into account in deciding the appropriate action to meet the future requirements for the life of the structures [9] and [21]:

- a) Do nothing
- b) Do nothing for a certain time
- c) Re-analysis of structural capacity, possibly leading to downgrading of the function of the concrete structure
- d) Prevention or reduction of further deterioration, without improvement of the concrete structure
- e) Repair, protect or strengthen all or parts of the concrete structure
- f) Reconstruction of part or all of the concrete structure
- g) Demolition of part or all of the concrete structure.

6.3.1 Principles for the repair and protection of damages to the concrete

EN 1504-9 outlines the repair and protection of damages to the concrete (table 6.1) caused by factors indicated in figure 6.2 above.

Table 6.1 Principles for repair and protection for damages to the concrete [7 &21]

Principle No.	Principle and its definition	Methods based on the principle
Principle 1[PI]	Protection against ingress Reducing or preventing ingress of adverse agents, e.g. water, other liquids, vapour, gas, chemicals and biological agents	1.1 Impregnation Applying liquid products that penetrate the concrete and block the pore system. 1.2 Surface coating with and without crack bridging ability 1.3 Locally bandaged cracks^a 1.4 Filling cracks 1.5 Transferring cracks in to joints^a 1.6 Erecting external panels^{ab} 1.7 Applying membranes^b
Principle 2[MC]	Moisture Control Adjusting and maintaining the moisture content in concrete with in a specified range of values	2.1 Hydrophobic impregnation 2.2 Surface coating 2.3 Sheltering or over cladding^{ab} 2.4 Electrochemical treatment^{ab} Applying a potential difference across sections of the concrete to assist or resist the passage of water through concrete. (Not for reinforced concrete without assessment of the risk of inducing corrosion.)
Principle 3[CR]	Concrete Restoration Restoring the original concrete of a structural element to the originally specified shape and function. Restoring the concrete structure by replacing part of it	3.1 Applying mortar by hand 3.2 Recasting with concrete 3.3 Spraying concrete or mortar 3.4 Replacing elements
Principle 4[SS]	Structural Strengthening Increasing or restoring the structural load-bearing capacity of an element of the concrete structure	4.1 Adding or replacing embedded or external steel bars 4.2 Installing bonded rebars in preformed or drilled holes in the concrete 4.3 Plate bonding 4.4 Adding mortar or concrete 4.5 Injecting cracks, voids or Interstices 4.6 Filling cracks, voids or interstices 4.7 Prestressing – (post tensioning)^a
Principle 5[PR]	Physical Resistance Increasing resistance to physical or mechanical attack	5.1 Overlays or coatings 5.2 Impregnation
Principle 6[RC]	Resistance to Chemicals Increasing resistance of the concrete surface to deteriorations by chemical attack.	5.1 Overlays or coatings 5.2 Impregnation

^aThese methods may make use of products and systems not covered by the EN 1504 series

^bInclusion of methods in EN 1405 does not imply these methods have been approved

6.3.2 Principles for the repair and protection of damages due to reinforcement corrosion

The main causes and consequences, repair methods of reinforcement corrosion are discussed in section 2 of this report. The EN 1504-9 also develops principles for the repair of deteriorated reinforced concrete affected by reinforcement corrosion (table 6.2). In general, corrosion caused by chloride ingress is more difficult to counteract than corrosion by carbonation.

Table 6.2 Principles for repair and protection of damages due to reinforcement corrosion [7&21]

Principle No.	Principle and its definition	Methods based on the principle
Principle 7[RP]	Preserving or Restoring passivity Creating chemical conditions in which the surface of the reinforcement is maintained in, or is returned to, a passive condition.	7.1 Increasing the reinforcement cover with additional cementitious mortar or concrete 7.2 Replacing contaminated or carbonated concrete 7.3 Electrochemical re-alkalization of carbonated concrete^a 7.4 Re-alkalization of carbonated concrete by diffusion 7.5 Electrochemical chloride extraction^a
Principle 8[IR]	Increasing Resistivity Increasing the electrical resistivity of the concrete	8.1 Limiting moisture content by surface treatments, coatings, or sheltering
Principle 9[CC]	Cathodic Control Creating conditions in which potentially cathodic areas of reinforcement are unable to drive an anodic reaction.	9.1 Limiting oxygen content (at the cathode) by saturation or surface coating^b
Principle 10[CP]	Cathodic Protection	10.1 Applying electrical potential^a
Principle 11[CA]	Control of anodic areas Creating conditions in which potentially anodic areas of the reinforcement are unable to take part in the corrosion reaction	11.1 Applying reinforcement coatings containing active pigments 11.2 Applying barrier coatings to the reinforcement 11.3 Applying inhibitors to the concrete^{ab}

^aThese methods may make use of products and systems not covered by the EN 1504 series

^bInclusion of methods in EN 1504 Part 9 does not imply these methods have been approved

The principles, repair and strengthening methods behind the principles developed by EN1504-9 in tables 6.1 and 6.2 are commonly used in reinforced concrete structures and they are new techniques in nature, except some of the traditional repairs stated in section 2 and 3 of this report. The degree how we can apply them in heritage structures depends on their suitability to conservation principles of heritages and their compatibility with the original old concrete.

7 REPAIR AND STRENGTHENING PROPOSALS

7.1 Introduction

In this section, various aspects concerning the possibility of using conservation principles of heritages in reinforced concrete heritage structures, acceptability of repair and strengthening methods based on the conservation principles of heritage structures and the use of new materials in the repair and restoration of these heritage structures. Section 2.2 of this paper states some ideas and typologies eventhough the difference between modern and heritage reinforced concrete structures is an ambiguous issue until these days. The most common differences can be from:

- The material properties (cement, aggregate, steel, admixtures...). At the beginning of the 20th century, reinforced concrete structures were built with aggregates taken from the sea sides and not properly graded;Portland cement was widely used; steel reinforcements were mostly smooth and not resistant like the reinforcements nowadays etc.
- Technology at the time of construction: In old structures, mixers of concrete, vibrators to vibrate the fresh concrete to avoid air voids etc were not available that leads to the porosity of old concrete structures.
- Basis of design: the design codes and specifications available in the beginning of the century were not sufficient like the codes and provisions currently available.
- Intended uses: Modern structures are mostly designed for specific purposes and they will serve this function in the future, but old reinforced concrete structures faced variations in the use of the structure.
- Exposure conditions: the environmental exposure conditions at the beginning of the century and now are different, leading to the design of resistant structures based on the environmental conditions. This new environmental condition will pose problems for the old reinforced concrete structures.
- Other factors not listed here

But bot modern and heritage reinforced concrete structures share most of the common problems in reinforced concrete. Apparently, it can also be told that the repair and strengthening methods used for modern reinforced concretes can be used with limitations to reinforced concrete heritage structures. The limitations are being based on the principles of restoration of heritage structures.

The principles used for the restoration of heritage reinforced concrete heritages should combine the principles used for restoration of heritage structures (such as authenticity, minimum intervention etc) and principles for the repair or reinforced concrete structures according to the European Standard EN 1504 . EN1504 provides the steps to be followed in the repair and strengthening of reinforced concrete structures along with the materials and available repair and strengthening methods.

1.2 Possibility of use of conservation principles

Most of the time, following the principles of conservation in the repair and strengthening of reinforced concrete heritages is a very complex task that needs complete understanding of the cause of deterioration/distress and the correct meaning of the principle. The principles of conservation are so restrictive that sometimes can't be attained in reality. In the field, it is a common practice to set a principle in the paper or word and difficult to change it in to field applications.

Restoration, rehabilitation, repair and strengthening of 20th century heritage structures according to restoration principles is at an infant stage, especially for reinforced concrete heritage structures. But based on the experience on the restoration of other heritage structures (such as masonry structures), this paper investigates whether the available conservation principles of heritage structures can be extended to reinforced concrete heritage structures.

1.2.1 Conservation principles from recommendations

The planning of the repair, strengthening and restoration of reinforced concrete heritage structures are detailed in section 3 of this paper. These plans of restorations are mostly guided by the existing restoration principles from concerned organizations. There are some conservation principles drawn by organizations, such as the Venice charter, ICOMOS/ISCARSAH recommendations[46], to keep the heritage structures in their natural condition. These charters and recommendations are developed as past invasive and uncontrolled repairs cause the devastation of heritage structures. Thus, these charters and recommendations will pose regulations in minimizing the use of the repair materials and methods used to preserve the historic heritages thereby guarantying the future of the heritages. Some of the principles which are believed to act on reinforced concrete heritages are briefed below [23].

Authenticity

The value of the reinforced concrete heritage structure is in the originality of the materials and components of the of the reinforced concrete heritage. Repair and strengthening

interventions should, as far as possible, respect the original concept, construction techniques and historical value of the structure (including historical materials) and of the historical evidence that it provides [23]. Authenticity in reinforced concrete heritages repair depends on the repair material and method used to repair the structure. For example, the use of cementitious materials in the repair will keep the originality of materials as opposed to FRP or post-tensioning or steel plate applications that are not similar with the original concrete.

Minimum intervention

Intervention or repair of a heritage should be minimized based on the existing damage and the extent of the damage. Not all damages of structures need intervention, thus conservation principles pose to minimize repair or intervention. Depending on the cause and extent of deterioration of the reinforced concrete heritage, repair interventions should be undertaken provided that invasive repair methods such as post-tensioning, that will change the authenticity of the heritage, be minimized. Any deterioration /distress in reinforced concrete directly or indirectly affect the load bearing reinforcing steel embedded in the concrete. Therefore the principle of minimum intervention depends on the extent on deterioration in reinforced concrete structures.

Reversibility of repair

The principles of conservation recommend checking the possibility of dismantling the restoration in the future, with no damage to the original parts. Where possible, any measures adopted should be “reversible” so that they can be removed and replaced with more suitable measures if new knowledge or ideas of repair is acquired in the future. Where they are not completely reversible, interventions should not compromise later interventions [23]. The repair materials and methods should also respect the original concept, materials and construction techniques. For example, repair methods using FRP can be regarded as reversible and patching and concrete placements as irreversible.

A full understanding of the structural behavior and material characteristics

Every repair and restoration project begins with the understanding of material characteristics and over all structural behavior. It is essential to identify initially the techniques that were used and construction methods, on subsequent changes, on the phenomena that have occurred, and, finally, on its present state. This will lead to an effective selection of repair material and method, and reduces unnecessary costs in the restoration [23].

Assumption of new technologies

As the technology progresses, different repair materials and repair methods are being invented. Writers recommend the use of these new materials and techniques provided that their adequacy is scientifically proven. But only scientific proof is not enough, they should be

tested on real cases on deteriorated structures. For example, FRP is a strong repair material that complements the deficiency in load bearing capacity of reinforced structures, but how is it possible to guarantee whether it will act the way it was assumed when it is applied on deteriorated reinforced concrete structures?

Address the root causes instead of the symptoms

The design of any repair or intervention should be based on a full understanding of the real causes that have caused the damage or deterioration of the reinforced concrete heritage and of those that will act in the future [23]. For example, corrosion of reinforcing steel will cause crack near the surrounding concrete. Thus, the repair material and method should address to stop/ reduce the corrosion of the reinforcement not to close or patch the open crack. In addition, one symptom can be caused by combination of factors or causes, thus before intervention identification of the cause of deterioration of the reinforced concrete heritage is important to have appropriate repair material and method, and to minimize unnecessary repair expenses.

Compatibility of the repair material and original substrate concrete

The compatibility of the repair material and the original substrate concrete can be said the most governing factor in the effectiveness of the repair and restoration. The characteristics of materials used in restoration work (in particular new materials) and their compatibility with existing materials should be fully established. The repair material should be compatible, capable of providing the deficiency of the older concrete and it shouldn't create any long-term side effects on the repaired structure. The use of cementitious materials in the repair will at least provide the compatibility requirement, even though it depend whether polymer modified concretes are used or not. On the contrary, new repair materials such FRP or post-tensioning or steel plate applications are creating compatibility problems.

Less Invasive restorations

Before the principles for restorations and recommendations were drawn, repair and restorations were done on thumb rules and using the available techniques and materials. These invasive solutions caused the devastation of many heritage structures. It is essential to decide first whether the deterioration/ distress of concrete need an intervention, and the effective repair material and method to address the problem. Traditional repair materials and methods seem to be less invasive as experience modified them on the long run, but the newly developed systems are applied invariably in reinforced concrete heritages believing that they are effective since most of them are scientifically based. For example, the introduction of reinforced concrete/ steel column to support an overloaded slab seems invasive solution that will affect the aesthetics and original structure, the application of FRP

and overlay gives a less invasive solutions. Cathodic protection of the corroded reinforcement can be said the least invasive method of repair than other methods.

Durability of restorations

All the repair principles are applied to select appropriate and compatible repair material to restore a reinforced concrete heritage, the last thing being forecasting the durability of the restorations and repairs applied. Every repair material is not eternal and it certainly needs maintenance sometime in the future after its application. The repair system should not require “repair of the repair” with in few years of its applications. Thus, when a repair method is selected, it’s short-term and long-term performance of the repair should be understood before its application. For instance, the application of patch repair in some part of corrosion deteriorated concrete surface will aggravate the corrosion of reinforcement in the perimeter of patch repair, reducing the durability of the repair.

Repair is always preferable to replacement

To maintain the authenticity of the reinforced concrete heritage and to save unnecessary expenses in restoration, repair of the damaged concrete seems more viable than replacement but depending on the severity and cause of deterioration. Replacement of a structural member usually imparts another damage to near by structural members (by changing the load path during construction) and monolithicity can’t be guaranteed near the joints of the new and old members, which is the weak point in most structures.

Minimize subsequent intervention

Experience in the restoration of heritage structures showed that so many of the repairs made in the past are in need of another repair, i.e. “repair of the repair”. If an intervention is made on reinforced concrete heritage structures, adequate maintenance should be done to limit or postpone the need for subsequent intervention.

Monitoring of the repair

While the repair is on process, it is essential to control and monitor the repair. For example while repairing a crack, monitoring should be done on the repair to check whether the repair stabilized or closed the crack, and if not to opt other methods.

1.2.2 Acceptability or extent of repair and strengthening methods

Even though recommendations force to minimize restorations, restorations of reinforced concrete heritage structures are done invariably all over the world. There are so many repair materials and techniques that are widely used in the repair of reinforced concrete structures. Some repair methods in the past showed durability problems after they are applied due to the incompatibility and invasiveness of the methods.

Which methods are acceptable even though they are against conservation principles of heritage structures (incompatible, invasive etc)?

Do nothing

In masonry structures where the problems have sustained for centuries or long time without any collapse of the heritage structure, the “do nothing” option of repair may be good not to disturb the stable damage on the structure. But in reinforced concrete structure, this option of repair seems to be vague to apply. For example, once the corrosion of the structure is started/ initiated, waiting may aggravate the corrosion rate there by increasing the deterioration of the structure. This option of repair may lead to further deterioration and even collapse of the structures. The writer of this paper suggests the “do nothing for a certain time” option of repair to identify the cause of the damage and its progress.

Concrete placement

When the reinforced concrete heritage structure is deteriorated due to alkali aggregate reactions, it is barely possible to repair it with other methods of repair except placement of the deteriorated concrete with a new repair material, having special property, which will reduce the cause of deterioration in the future.

In addition, for freeze thaw damaged structures, the repair can be carried out depending on the severity of deterioration.

- If the deterioration is less, coating the surface may reduce further damage??? That will reduce the entrance of water and deicing salts.
- If the deterioration is severe, the affected concrete should be removed and replaced with a new non porous concrete with modified property than the original. But this method of repair is invasive and against the conservation principle of minimum intervention.

This method is not reversible and against minimum intervention, and thus should be minimized unless conditions force it to be the only repair method.

Patch repair

Patch repair can be effective for repair of deteriorated concrete if the deterioration cause is other than corrosion of reinforcing steel such as freeze thaw and alkali silica reactions. This method is an old and traditional, thus lots of experience in patch repairing.

- Matching colour between the new repair and the existing concrete substrate will create a great problem in most repair works. This has led to the painting of the repaired and old concrete surface.
- Mostly it is not a reversible repair method

- Should be minimized to repair corrosion caused deterioration of concrete as it creates corrosion on the perimeter of repair.
- Compatibility with minimum intervention depends on the amount to be applied.

Shotcrete or spraying concrete

When the area to be repaired is very large and repairing the member by patching is difficult (as in the case of the under side of thin shells and domes), shotcrete can be the sole solution of restoration and repairing. This repair method is:

- Not reversible
- Dependent on the compatibility between the original concrete and the repair material for its durability.

Polymer modified concretes

Polymer modified concretes are effective in fulfilling the deficiency of deteriorated concrete due to chemical attacks, alkali silica reactions and freeze thawing. Compatibility between the repair material and the substrate should be kept to reduce long term durability problems and subsequent repair needs.

- Invasive depending on the area to be repaired
- Not reversible
- Dependent on the compatibility between the original concrete and the repair material for its durability.

Injections

Injections should be used when the area and volume of deteriorated/distressed concrete is large. It should be kept in mind that this repair method will work if the cause of deterioration is not reinforcement corrosion as injecting deterioration caused by reinforcement corrosion will not stop or reduce further corrosion of the reinforcing bar and deterioration. Injections can close the cracks and bring about monolithicity of the deteriorated concrete.

- Not reversible
- Invasive
- Compatibility of the substrate concrete and the injection should be kept to get effective repair.

Overlays

They are commonly used in the repair of heritage buildings and bridges. Overlays are effective for overloading repairs and to increase the cover to the reinforcement there by preventing the ingress of aggressive agents at the reinforcing steel level.

- Compatibility of the overlay is crucial to guarantee effective repair and long term durability

- Repair is not reversible
- Against minimum intervention

FRP

These days the application of FRP is diverse in almost all reinforced concrete structures. FRP applications are common repair and strengthening methods for overloaded buildings and bridges. As compared to other strengthening and upgrading methods(such as post-tensioning), it is a better repair method due to the following reasons:

- Can easily be removed(reversibility of repair)
- Does not affect the substrate reinforced concrete fabric, it is just applied external to the surface
- Lower upgrade cost(economical repair method)
- Speed and ease of application(making the heriatge functional with in short time)
- It will not significantly change the dimension of the structure to be strengthened.

Thus FRP can be applied for buildings and bridges provided that the compatibility problems it has with substrate concrete have to be improved.

Cathodic Protection

Where reinforced concrete heritage structures are deteriorated/ distressed due to corrosion of reinforcing steel, cathodic protection will give effective protection measures as compared to other methods. Other repair methods such as patch repair will cause future reinforcing steel corrosion in the perimeter of the patch.

- It is less invasive method of repair
- Minimum intervention on the reinforced concrete fabric
- Cathodic protection acts all along the surface of the concrete surface that will ensure maximum protection as compared to other methods.

The writer of the paper suggests the use of cathodic protection whenever the cause of deterioration is corrosion of reinforcing steel provided that the continuity of the reinforcement in the old concrete shall be verified.

Post-tensioning

This method is widely used in the strengthening and upgrading of overloaded reinforced concrete bridges. In some cases it includes the drilling of members and inserting the reinforcement cable to be post-tensioned. This method is:

- Invasive as it sometimes may damage the original concrete to apply the method
- Against minimum intervention
- Not compatible with the substrate concrete

- Authenticity of the original structure will be affected

Though it has limitations of conservation principles, it is an effective technique for bridge repair and strengthening as other methods except FRP can't be applied for strengthening of bridge load bearing elements.

Shear wall applications

Previous reinforced concrete structures at the beginning of the century were designed without the consideration of earthquakes, thereby needing their upgrading these days. The use of internal or external shear walls is becoming common in some countries like Turkey to counteract the earthquakes. The application of internal or external shear walls on the strengthening of earthquake prone reinforced concrete structures/buildings may be essential whatever limitations it has. The method is:

- Invasive
- Reversible but will cause damage on the concrete fabric in the process
- Compatibility at the joint between the old concrete and new wall can be attained if appropriate repair material is selected
- Against authenticity and original concept

1.3 New materials and techniques

Nowadays a lot of new repair materials are available in the market and so does the repair techniques. This is due to the increased number of historic structures/monuments and the frequent occurrence of deterioration on them that needs immediate repair or strengthening. The increasing interest of preserving heritage all over the world makes the advancement of applied sciences and advanced technologies in the production of different repair materials. But for many of the products, the uncertainty in their effectiveness is a common question as they are only laboratory test products and their long-term effect can't be told surely. In addition, these new materials will be applied on historic constructions made from materials whose properties and production are not properly known (for example the ungraded aggregates in seas that were used). It is undeniable on the need to check the similarity in properties of these new repair materials and the existing historic concrete material.

The most important goal to achieve in using these new materials is to obtain a repaired structure that has identical appearance, colour, texture, elasticity, porosity etc with the original construction material, which is the compatibility between the new material and old concrete substrate. In the actual repair world, many repair materials and repair methods are effective for only short period of time because they can be affected by environmental factors

and incompatibility between materials, which needs the “repair of repair” with in few years after the repair is placed.

Most of the modern repair techniques are based on assumptions and they seem effective since they are scientifically based and tested in the laboratory where every condition is satisfied, but the condition on repair site is different from laboratory. For example, Cathodic protection is effective in protecting the corrosion of reinforcement, but how it is possible to check the reinforcements in the existing concrete are electrically connected to each other?

The assumptions on which the new repair materials and techniques are based needs deep study whether that assumption works for the existing deteriorated reinforced structure or not. Most of the tests for the repair materials are done on new concrete samples, not on historic concrete. Thus how can it be directly applied for historic concrete? The method should be modified using the properties of historic concrete that has a little bit different properties and concrete ingredients.

ICOMOS 20th Century heritage committee outlined the use of new materials in the repair of heritage structures as:

“The introduction of many new materials - plastics, different types of glass, fibreglass, synthetic rubber, fibreboard, metals and so on - the use of new component-based building systems and the use of traditional materials in new ways are characteristics of the modern-century building industry. This has, however, spawned some difficult conservation problems for these buildings that can be summarized as:

- the use of new materials with unproven performance records;
- the use of new materials without knowledge of best practice methods for use;
- the use of traditional materials in new ways, or in combination with new materials;
- poor workmanship and quality control (new materials chosen for reasons of economy);
- the use of prefabricated, component-based construction systems;
- the rapid development of materials and their equally rapid supersession;
- the effect of pollutants on modern materials;
- the use of materials now identified as hazardous;
- the lack of an established salvage industry for modern buildings.” [43].

In other historical structures, typically masonry, it is possible to wait without intervention as the damages on the structures sustain on the structures since centuries and still available without causing any collapse. On the contrary, in reinforced concrete heritages, if the

damage of the structure is observed, it is a must to intervene as the damage increase in magnitude and cause collapse of the structure. For example, if the reinforced concrete is attacked either by alkali aggregate reaction or freeze thaw, the concrete surface will start to deteriorate and cracking/spalling which facilitates the ingress of aggressive agents like chloride ions and carbon dioxide that will increase the magnitude of corrosion. In this case, there is nothing to wait, thus once the concrete structure deteriorates or spalls to higher magnitudes, it must be repaired. Now will come the question of the type of material and repair method to use. There are two options for this repair:

- Using available new repair materials to avoid any immediate failure
- Perform the analysis of substrate and look for a compatible materials and repair methods. But to attain this, it is a relatively complex task and it needs more time and specialists, which will aggravate the deterioration until restoration.

It is not the intention of this paper to criticize the new materials and techniques, but their effectiveness should be checked when they are applied on old reinforced concrete materials. Experience showed that some of the new repair materials and techniques showed effective repairs in existing reinforced concrete structures. But their compatibility with old reinforced concretes of the late 19th and early 20th centuries should be checked.

1.4 General proposals

The writer of the report recommends the following general repair comments on the existing repair materials and techniques.

- Before making a decision on structural intervention it is crucial first determine the causes of damage/deterioration of the reinforced concrete, and then to evaluate the present level of structural safety of the reinforced concrete heritage. It also provides whether immediate intervention is necessary or not.
- Traditional repair methods such as patch repairing should be used to repair deteriorations caused by factors other than corrosion of the reinforcement. They are effective in repairing spallings and pop-outs from the reinforced concrete fabric surface. In addition, they were used for long time and experience of the restorers can be used in the restoration of reinforced concrete heritages.
- When modern repair materials and methods are used for repair and strengthening of reinforce concrete heritage structures, it is better if they are based on similar past experience.
- Repair principles based on EN 1504 (for reinforced concrete structures) shall be extended for repair of reinforced concrete heritages with some limitations until further

research works are done specifically for the so called reinforced concrete heritage structures.

- Most modern repair materials and techniques are based on assumptions for their effectiveness. When they are used in the repair and strengthening of heritage structures, the substrate (deteriorated concrete) should fulfill some of the assumptions or requirements that the repair materials and techniques are based on.
- Instead of adding extra structural members, for example addition of column to support the overloaded slab, improve the existing member by increasing the cross-section of the member or by using modern strengthening techniques that will not affect the authenticity(originality) and aesthetics of the heritage structure.
- When the reinforced heritage structure is prone to earthquakes and it was designed previously without the consideration of earthquake, additional earthquake systems such as shear walls shall be included in the structure or by wrapping FRP in lateral load resisting members. The shear walls can be placed inside or outside of the structure depending on the easiness and aesthetics.
- When the reinforced concrete heritage structure is damaged by freeze thaw, chemical attacks and alkali aggregate reactions, it is sometimes not possible to repair the deteriorated concrete. Thus, the removal and placement of the deteriorated concrete by new resistant concrete for the deficiency of the structure is an effective method of repair instead of trying to stop further degradation.
- New technologies, materials and techniques can be used in the repair and restoration of reinforced concrete heritages provided that their adequacy is both scientifically and practically proven in the repair of modern reinforced concrete structures.
- No repair and strengthening action should be undertaken on the reinforced concrete heritage structure without ascertaining the likely benefit and harm of the repair materials and techniques to the reinforced concrete heritage structure. The long term performance/ durability of the repair/strengthening material and method should be studied before selection of repair options and interventions.
- When the area of deteriorated concrete to be repaired is very large and if the structure is of significant height (as in domes), shotcrete or spraying of concrete can give an effective and economical means of repair as compared to other methods.
- When the volume of deteriorated concrete to be repaired is very large, injection can be an effective method of repair to reunite the structure and maintain monolithicity of the overall structure.

- When a repair material is selected, it should first be checked by applying on a sample area of the deteriorated concrete surface to see whether it fulfils the basic considerations taken to select the repair material.
- Repair methods to be applied should not significantly change the dimension of the structures and the original structural system. For example, FRP can be applied without significant change on the shape of the member to be repaired.
- The restoration of reinforced concrete heritage structures should be done by contractors/qualified professionals having experience on the same field (repair and restoration of reinforced concrete heritages) and the quality of the contractor should be checked at initial stages before the restoration progresses. Faulty concrete repair can worsen structural problems and lead to further damage or safety hazards.
- The repair should sustain for longer period of time between maintenances, but in the actual world the opposite happens. The repaired structures need another repair within a few years of its applications, this may be due to the incompatibility of the repair materials and method or intervening without knowing the actual cause of deterioration or carelessness.
- The correction and elimination of concrete problems can be difficult, time-consuming, and costly. Yet the temptation to resort to temporary solutions should be avoided, since their failure can expose a building to further and more serious deterioration, and in some cases can mask underlying structural problems that could lead to serious safety hazards.
- As long as one continues to blindly use repair and protection methods applicable for newly constructed structures for reinforced concrete heritage structures repair and strengthening, the devastation of the heritage structures will progress and the cost of “repairing the repairs” will be on the rise. For example, concerning cathodic protection a broader understanding of the electrochemical differences between new and original substrate concrete is necessary for effective protection of reinforcement in repaired structures .
- Modern architecture should as much as possible reduce the use of new materials, whose long-term performances are not fully understood, and techniques in the repair and restoration of reinforced concrete heritage structures. To minimize the common problems of repairs, architects and engineers should work together to get an effective repair.

8 CASE STUDIES

8.1 Unity temple: Structural repair and Conservation [24]

The unity temple (fig. 8.1) in Oak park, Illinois was designed by Frank Lloyd Wright and completed in 1907. It is one of the well known early uses of reinforced cast-in-place concrete structure in USA [24].



Figure 8.1 west façade of unity temple: Worship temple (left) and Unity house for social gatherings (right) [24]

As the passage of time passes, this landmark reinforced concrete heritage suffers from material and system deterioration, which necessitates the repair of the heritage. The concrete is investigated and a historical structure report prepared in 1987. The investigation included the assessment of the condition of the roof slab structure on the west overhang of the temple.

Materials for construction of structural elements

At the time of construction, two types of concretes were used: light weight concrete and normal weight concrete;

- Elements of the building that resist compressive stresses such as foundations, walls and piers (see fig. 8.2) were constructed from normal weight concrete, composed of Portland cement, sand and lime stone aggregate.

- Elements that resist flexural stresses, such as roof and floor slabs and the temple overhangs were constructed from light weight concrete, composed of Portland cement, sand and soft coal cinders.

The original specifications for Unity temple included general criteria for bar placement for floor and roof slabs, but gave no indication of reinforcement size and placement with in the cantilever slab which forms the west overhand of the temple.

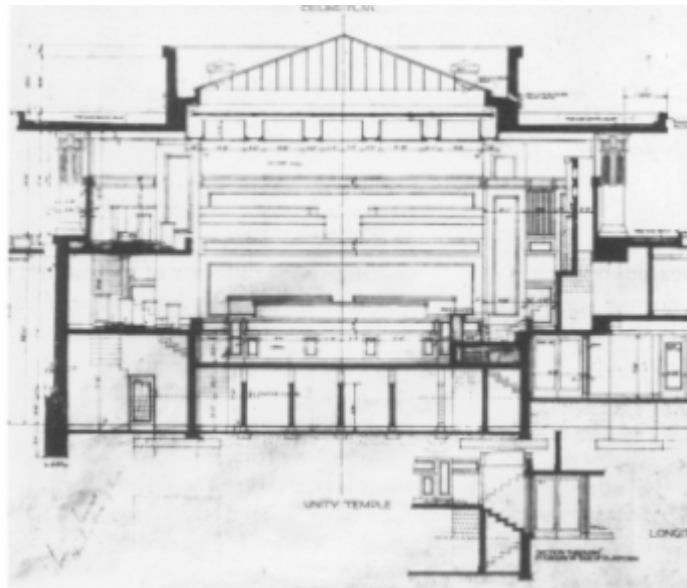

Figure 8.2 the longitudinal cross section of the Worship temple illustrating the floor and roof slabs, the overhang of the temple. The main structural supports of the building consist of four large, hollow concrete piers located near the four corners and cast-in-place concrete, load bearing walls

The necessary steps that were followed, compiled by the writer of this report, in accordance with the European Standard EN1504-9 are presented below.

Deterioration and causes

The light weight concrete is generally more permeable to water penetration and tends to carbonate at a faster rate than normal weight concrete, resulting the lowering of natural alkalinity of the concrete which can facilitate fast corrosion of the steel reinforcement.

On the soffit of the western temple overhang (see figure 8.3 below), delamination and spalling of the concrete and the exposed corroded reinforcing steel causes a safety hazard. In addition, sounding of the fascia on this west overhang indicated that large portions were delaminated. It was apparent that water had penetrated the fascia and the roof in these areas, or that condensation on the soffits migrated up ward to the bottom layer of the reinforcement, causing corrosion of the reinforcements.

Laboratory analyses of the concrete specimen from the west overhang also indicated that:

- The concrete used was of higher water-cement ratio, causing porous and weak concrete.
- Freeze thaw damage through out the depth of the specimen
- The concrete was fully carbonated and contain significant amounts of chloride

In the early 1970's, a rehabilitation program was performed by applying a shotcrete coating to the exterior of the building with the exception of these cantilever soffit overhang slabs.

The above integrated damages/ deterioration on the west overhang causes lost in strength of the overhang slab, which necessitate the repair of the overhang.

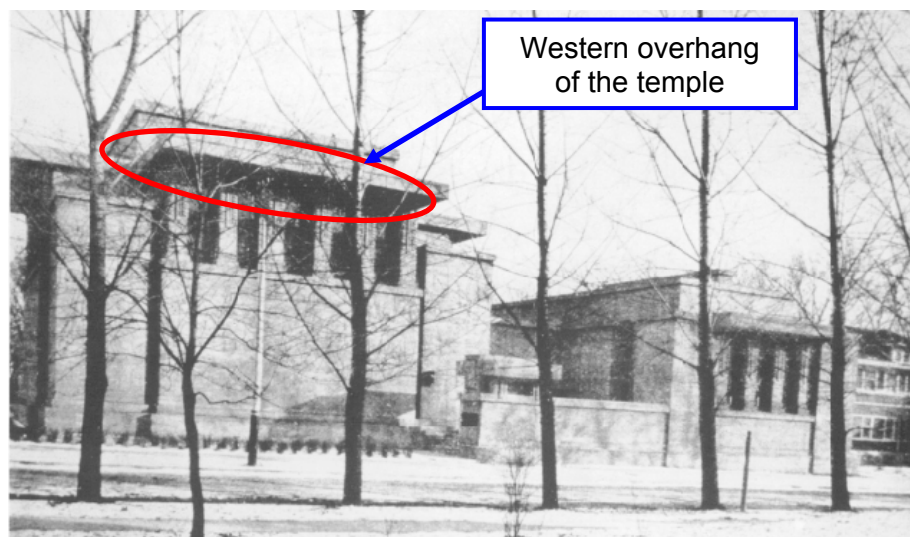

Figure 8.3 the deteriorated and spalled west overhang of the temple

Repair strategy/Options

Various repair schemes, with their drawbacks, were considered for the repair of the deteriorated west overhang temple:

1. Replacement of the fascia and repair of the original soffit surface
2. Addition of columns: have negative aesthetic impact
3. Suspension cables: they would set up alternate load paths for the cantilever loads and introduce unanticipated stresses in to other portions of the structure.
4. Replacement of the structural cantilever with materials other than concrete, but these schemes raised difficulty of implementation, drainage, susceptibility to future deterioration, and related long term problems.

Definition of repair principles

As it can be seen from the causes of deterioration, the repair material and system should avoid the ingress of moisture, chloride and carbon dioxide and should be resistant to freeze thaw cycles.

Selection of repair method

Replacement of the deteriorated concrete of the west cantilever overhang by using cast-in-place concrete offered a great advantage as compared to the above other options. The repair scheme includes the replacement of heavily damaged concrete and maintaining concrete that was in good conditions. The heavily corroded reinforcement also replaced to prevent future maintenance problems.

Definition of repair materials

The repair material selected for the replacement was of concrete having similar property or “in-kind” to the original substrate, to maintain the compatibility.

8.2 Rehabilitation and strengthening of an old industrial mill reinforced concrete building at Overijse, Belgium [25]

Vuurmolen, an old industrial steam mill at Overijse, is an early reinforced concrete building in Belgium built in 1902. In the first fifty years of its life, it was serving as a mill where the grain is treated and stored until the building is abandoned for the next fifty years.



Figure 8.4 Vuurmolen at Overijse, Belgium

After fifty years of disuse, the building is needed to serve a new function, as a new administrative center for the town Overijse since the old function became irrelevant. This in turn requires a rehabilitation of the existing building and a new part to be added.

Field researches are carried out to understand the structural behavior of the building and material properties. The building was found deficient to carry the new loadings to be assigned for the new use. As the building was regarded as a historical heritage in 1980, the rehabilitation and strengthening of the building was based on conservation principles of ICOMOS.

History of the building

The history of the building was studied from various literatures. The building was constructed in 1902, having five floors with a floor height of 3m. The construction consists of concrete slabs with a thickness of 10 cm supported by main and secondary beams, Figure 8.5. More detail of the history of the building can be obtained from [25].



Figure 8.5 Concrete floor slab, primary and secondary beams

Causes of deterioration

The long period of disuse and lack of maintenance causes water infiltration due to roof leakage and broken windows, which results in corrosion of the internal steel, spalling of the concrete and carbonation, freeze thaw actions in the interior of the building and growth of biological agents as shown in figure 8.6. Different shear cracks were observed both in the main beams and the secondary beams. This is due to a low concrete quality or insufficient shear reinforcement (spacing 250mm) used at the time, which were later confirmed after laboratory tests.



Figure 8.6 Damaged concrete (left) and moss growth on the structure (right)

Field research and laboratory testing

Field research and laboratory testing are carried out to gather more detailed information about the carbonation depth and concrete strength.

To quantify the magnitude and depth of carbonation, phenolphthalein (pH indicator) was used on the holes drilled on representative floor levels (fig.8.7). The result showed that the concrete was carbonated about 3cm from the top and from the bottom. The reinforcement cover is limited to 2 cm in the existing slabs; this means that no protection of the steel reinforcement is available.

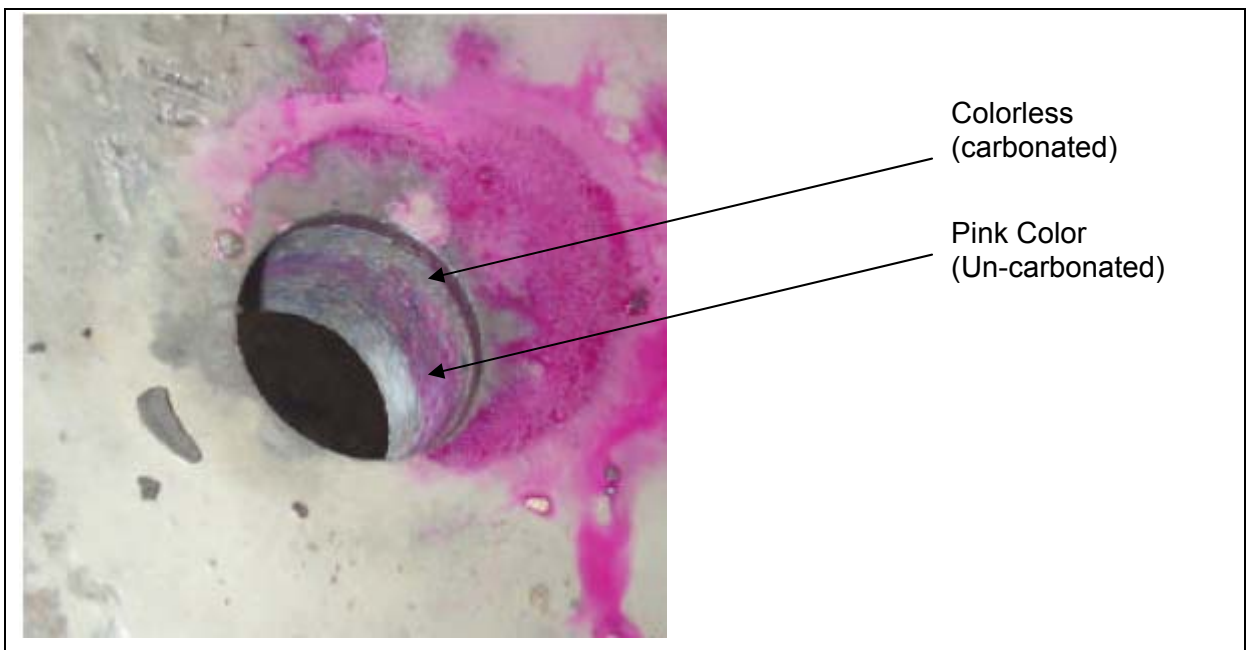

Figure 8.7 Test results of phenolphthalein test on the hole drilled on representative slab

To determine the concrete strength/ the load bearing capacity of the structural members such as beams, columns and slabs, non-destructive tests (NDT's such as ultra-sonic and sclerometer testing) and destructive tests (core drilling) were made. The experiment

confirmed the low quality concrete used at the time and the steel grade and the spacing of shear reinforcements (250mm).

Therapy

The repair includes two stages:

1. Rehabilitation of building materials to minimize future corrosion of reinforcement

The deteriorated concrete is removed and the surface cleaned by grit blasting. Steel rebars with a section loss of more than 25% are replaced; if the cross section loss remains limited (<25%), the steel rebars are treated. Rust is removed and a layer of anti-rust coating is applied. A repair epoxy mortar is applied to restore the original cross-section of the concrete element. Protective coating is provided to protect the reinforced concrete from future atmospheric contaminants and carbonation, see Figure 8.8.

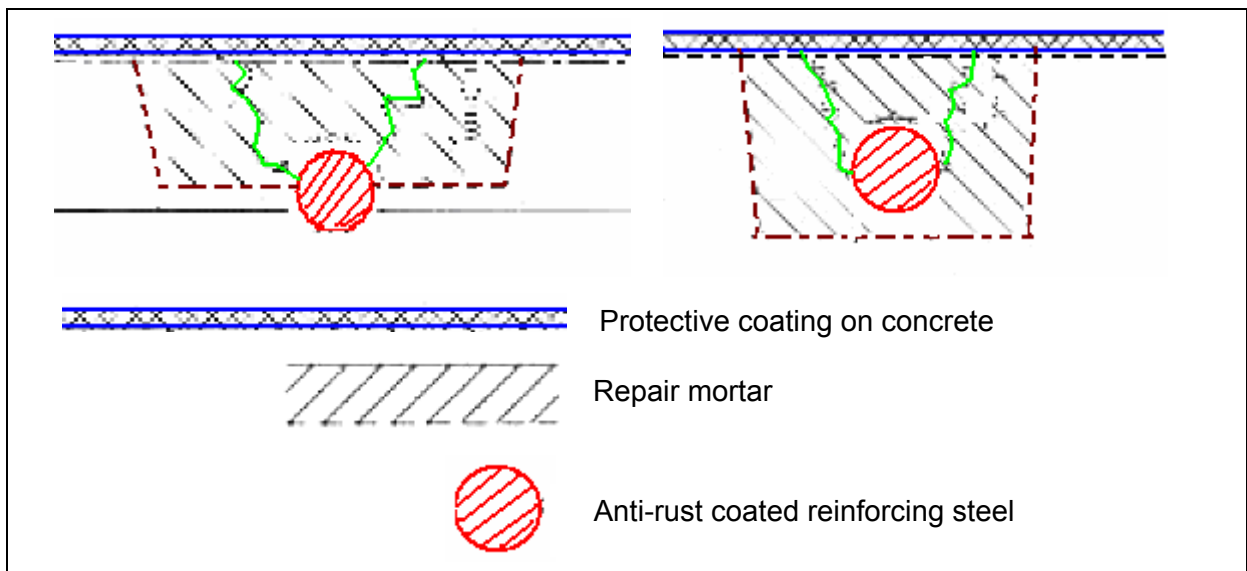

Figure 8.8 Rehabilitation of corroded steel depending on carbonation depth

2. Strengthening of the building for the new function, that is the upgrading of floor slab, beams and columns

Since the new use of the building is as an administrative seat of the government Overijssel, the load bearing elements need upgrading for the new function or live load requirement.

Slab: The original 10cm thick concrete slab is supplemented with additional 8cm concrete cover, which is fixed on top of the existing slab. This top layer will serve as an extended compressive zone for the total floor system, for which additional compressive reinforcement is required. Lightweight concrete is used to minimize the added permanent load. The floor is fixed to the main and secondary beams by means of dowels, Figure 8.9, to obtain a T-shaped section, requiring less strengthening.

Beams: Computations on the capacity of the beams for flexure shows that extra reinforcement is necessary in the mid spans of the main beam and of the secondary beams and extra shear reinforcement is required. Externally bonded reinforcement is added to the existing structure since the dimensions of the structure can only change slightly and the original structural system can be easily preserved (fig.8.10). To increase the flexural resistance of the beams, steel plate is introduced on the bottom sides of the beams, with the end of the plate bolted in to the concrete slab. To increase the shear resistance of the beams, two layers of CFRP are wrapped on the beams. No additional reinforcement is necessary at the support of the main beam or at the edge beam.

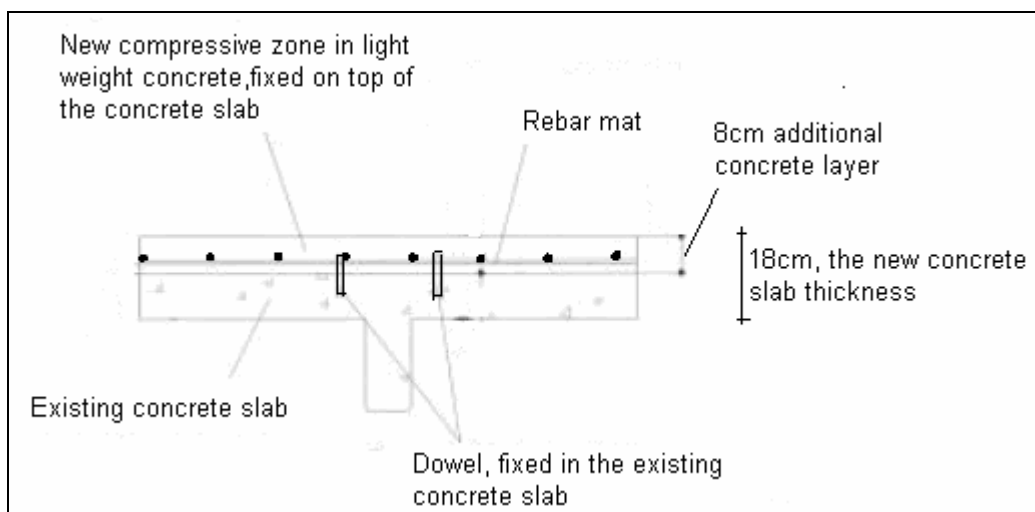

Figure 8.9 Dowels fixing the concrete slab to the beams

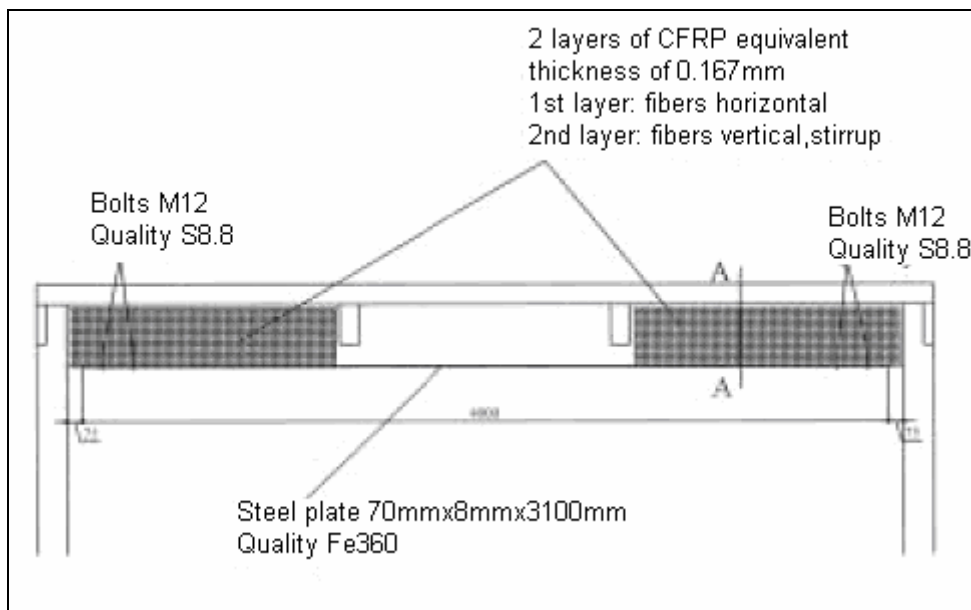

Figure 8.10 Required external reinforcement of the main and secondary beams

Columns

Columns are strengthened to both lateral loads and axial compression loads. Steel plates, fixed to the concrete by bolts, are provided on both sides of the column to resist bending stresses that will be caused by lateral loads (from wind loads etc). To increase the resistance of axial compression forces, different layers of CFRP are taking in to account the magnitude of compressive forces the column will support. For example, at the ground level where the compressive force is higher, 5 layers of CFRP are wrapped horizontally around the column and less number of layers in the successive upper layers.

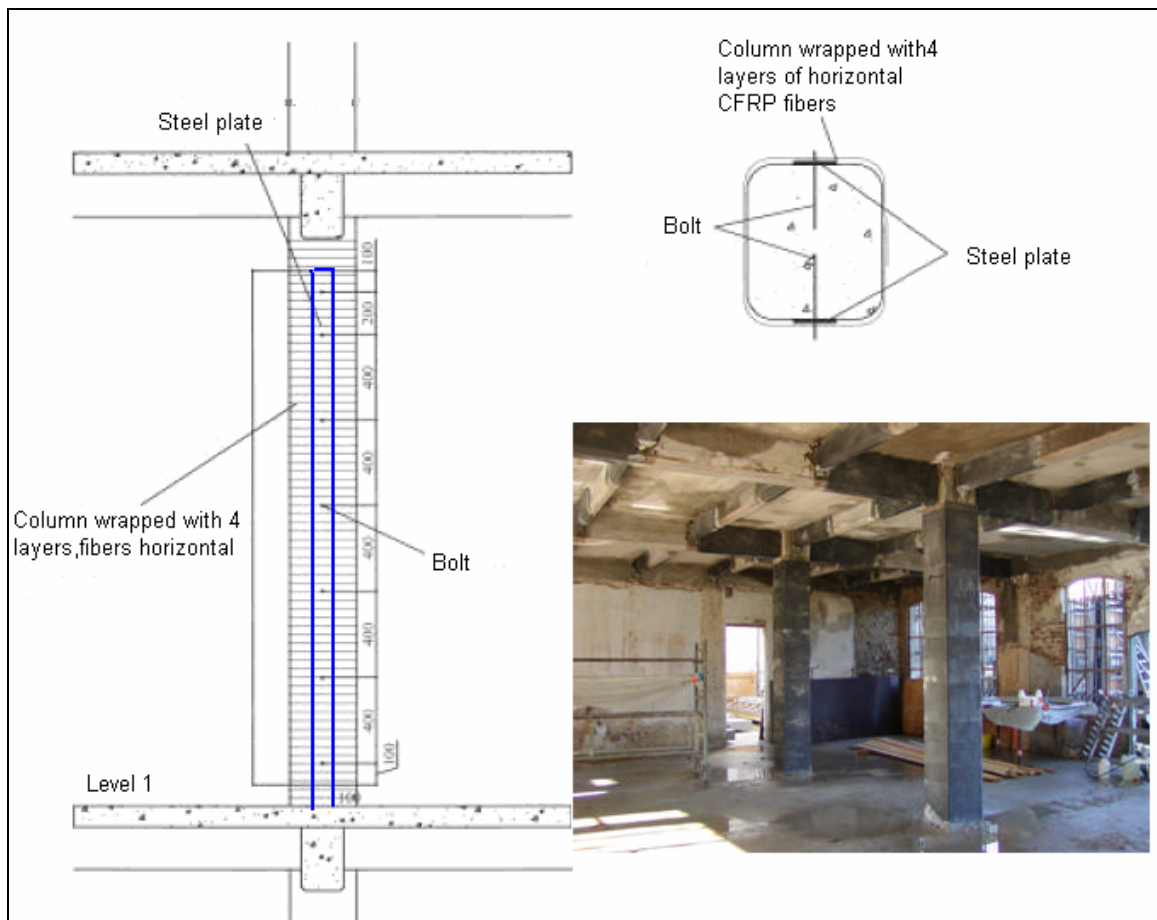

Figure 8.11 Strengthening of columns by wrapping CFRP horizontal fibers and steel plate

8.3 Cathodic protection repairs in multi-storey buildings on the Dutch coast[7]

This is the repair case study of two multi-story holiday resort buildings in Zantvoort (near Amsterdam), along the North Sea coast of Netherlands, to illustrate the protection of reinforcement corrosion by cathodic protection. The balcony slabs of these multi-storey buildings showed severe cracking due to chloride-initiated corrosion(see fig.8.12). The edges of the balcony slabs were affected particularly due to the protruding position of the edge rims and the presence of a water-hole at the ceiling of the balcony slab.

Reinforcements adjacent to this water-hole only had a cover of about 15 mm (see sketch in Figure 8.13). The buildings were built in 1970's, one of them with prefabricated slabs and the other one with cast on site concrete. The slabs were produced from Portland cement with 25mm cover to the reinforcement. Previous patch repairs failed and lead to the aggravation of reinforcement corrosion near the perimeter of the patch repair causing the cracking of the adjacent regions. Rebars that had been coated in previous repair work showed renewed corrosion.

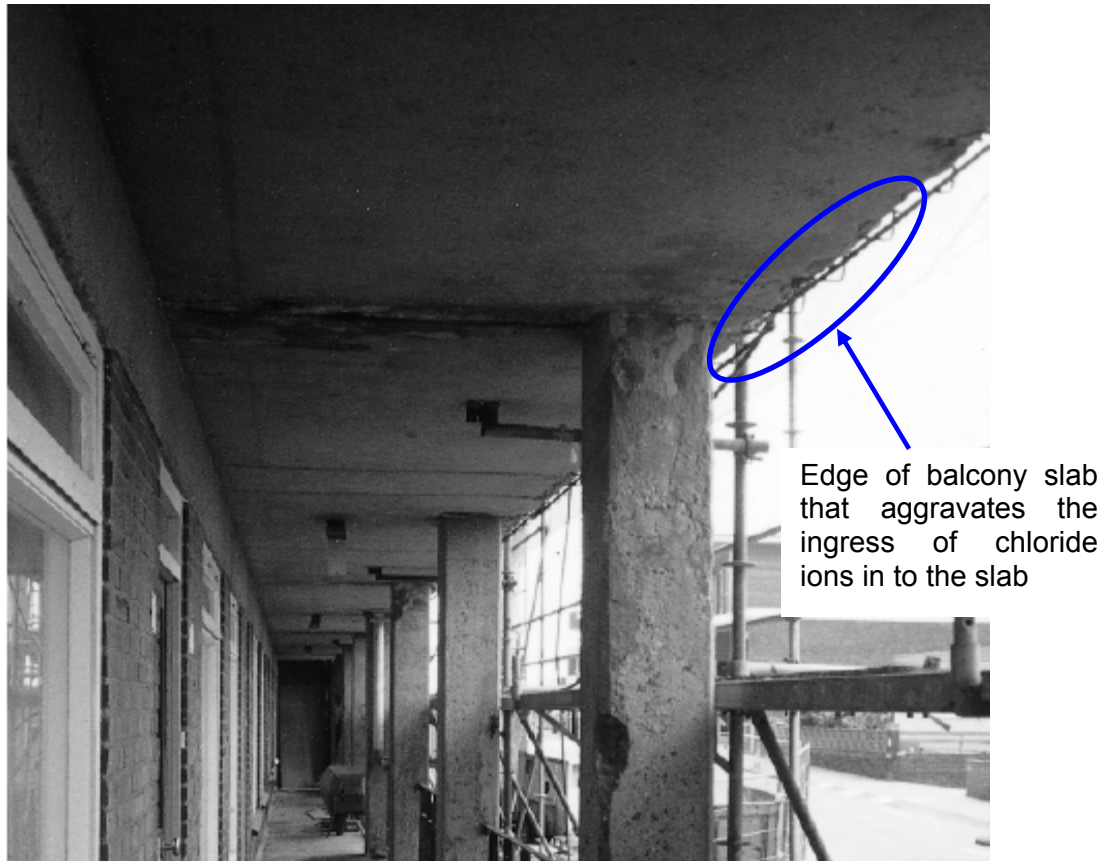

Figure 8.12 Balcony slabs of the holiday resort

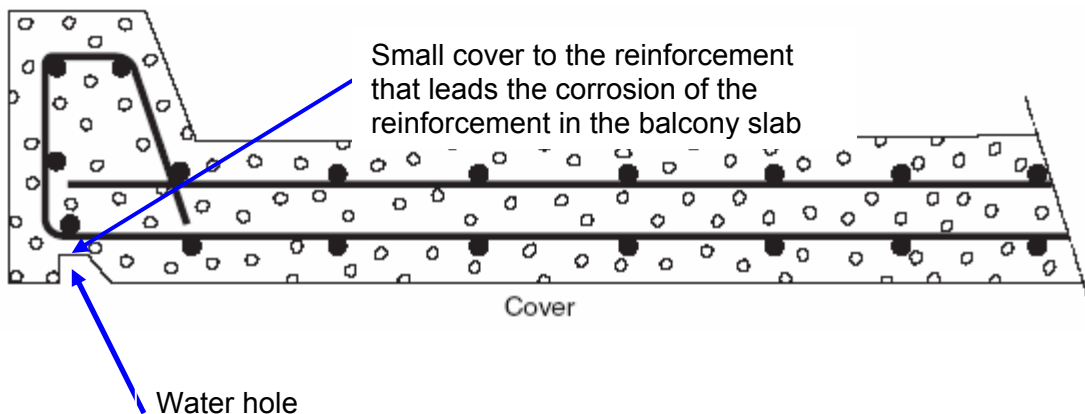

Figure 8.13 Water-hole in balcony slab ceiling causing locally reduced reinforcement cover.

Measurements showed that the chloride concentration at the reinforcement level exceeds the chloride contents needed for the initiation of corrosion.

Repair Options

Two repair options were selected:

- Conventional repair: consisting of removing of concrete, cleaning of the reinforcement and placing new concrete.
- Cathodic protection

Cathodic protection was selected due to the following reasons:

- Even though the initial cost of cathodic protection is more, its maintenance cost is lower as compared to conventional repair, which minimizes the total cost on the service life of the building.
- Cathodic protection causes less trouble to building users during repair work execution because noisy and dusty concrete removal could be avoided.
- The owner of the building had bad experience on patch repairs or conventional repairs.

Repair

All the cracked concrete at the edge rim of the balcony slab was removed and the corroded reinforcement at the edge cleaned up or replaced depending on the severity of corrosion of the reinforcement as shown in figure 8.14. Cables for connecting the DC current were attached to the reinforcement and the removed concrete replaced/cast by hand trowelling. The cables were connected to a rectifier supplying 1–2V DC. Finally, a topcoat was applied.

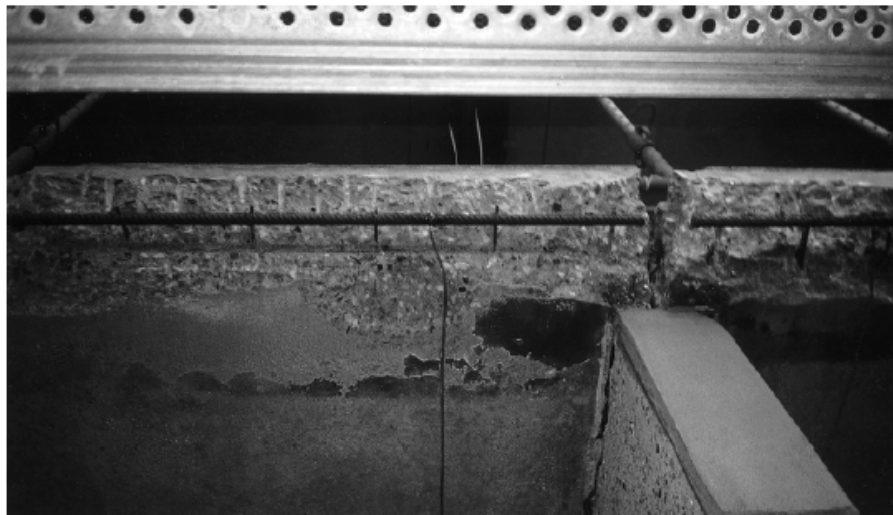

Figure 8.14 Removed concrete and replaced reinforcement at the edge of a balcony slab.

8.4 Palau Blaugrana

The Palau Blaugrana is the sports venue used for FC Barcelonas football, roller hockey and futsal training sessions and official matches. Inaugurated on October 23, 1971, it was designed by Catalan architects Francesc Cavaller and Josep Soteras (fig.8.15). Its main feature is its large dome, made of reinforced concrete. At the time, it was one of the most modern and impressive structure in Spain [38]. The large dome is made from a thin reinforced concrete shell structure of thickness 70mm and span of 80m [39].

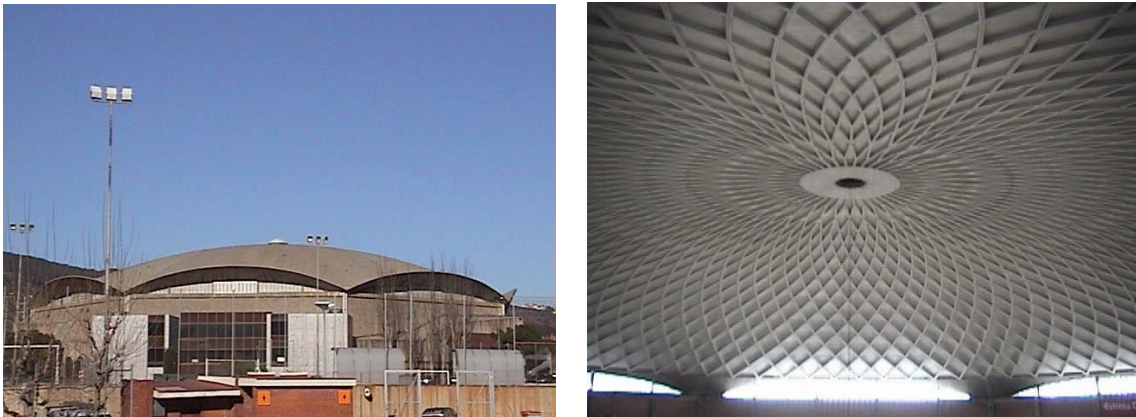

Figure 8.15 Palau Blaugrana external view (left) and inside view of the dome (right)

The roof dome is made of cast in-situ reinforced concrete ribs and pre-cast shell elements as shown in figures 8.16 and 8.17. The ribs are the main structural elements which will transfer the load along the rib axis to the supports.

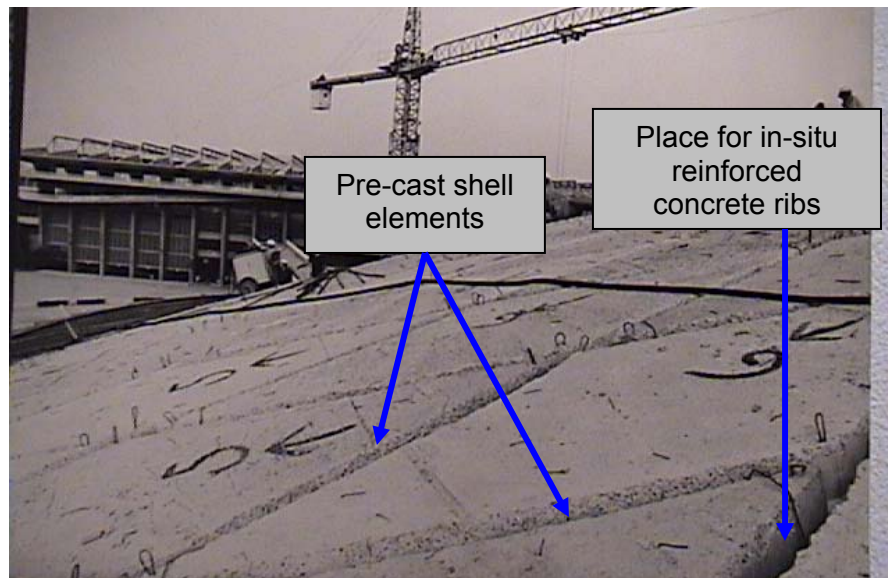

Figure 8.16 dome at construction stage

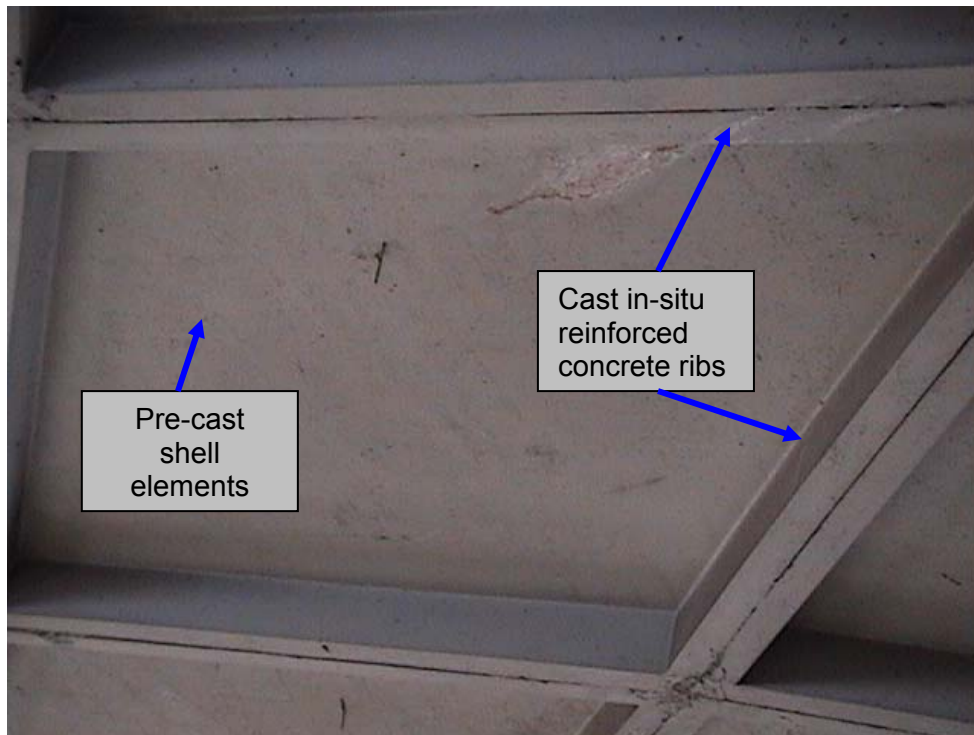

Figure 8.17 Pre-cast shell elements and ribs

Current condition of the roof dome

The underside of the pre-cast shell elements possesses small honey combs or perforations on the surface of the concrete as shown in figure 8.18. It can be told that the concrete mix used for the construction of the shell is of porous in nature. This can be further seen with the aggregates used in the concrete mix in other parts of the structure (figure 8.19).

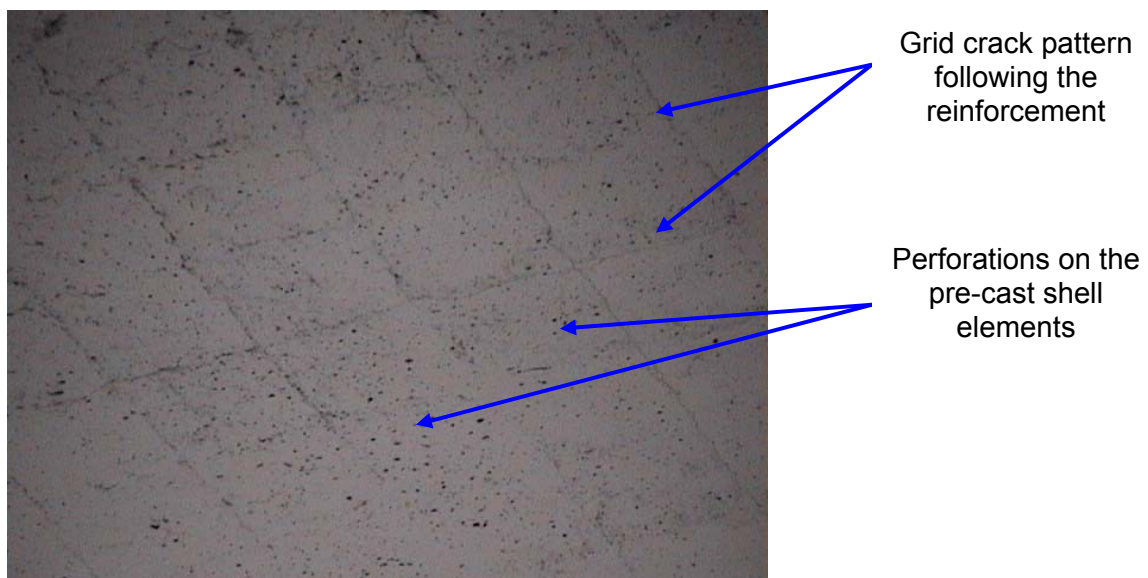

Figure 8.18 the honey combs or perforations on the concrete surface

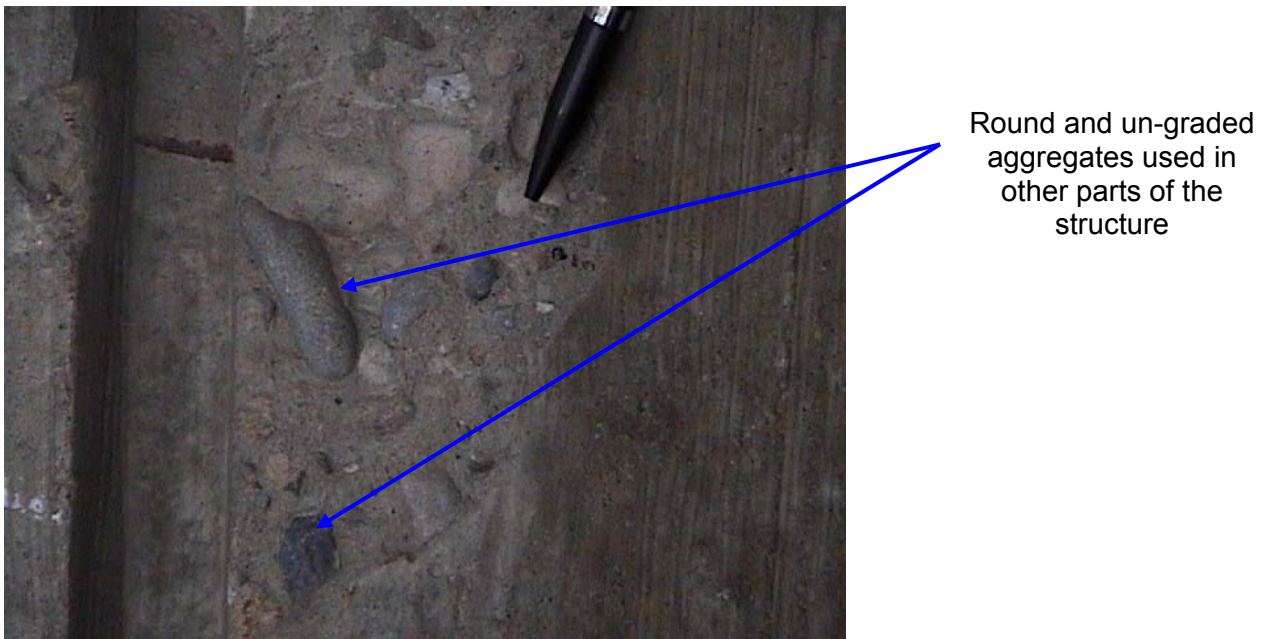

Figure 8.19 poor quality round aggregates used in the concrete mix

It is apparent that most shell and dome structures are made from thin reinforced concrete elements that provide only smaller cover to the reinforcement. Further more, to decrease the permanent loading on the roof, it is a usual practice to use light weight concretes, which are porous in nature most of the time. This leads the aggravation of the ingress of aggressive agents at the reinforcement level.

Figures 8.18 and 8.20 show that the under side of the thin pre-cast shell elements shows grids of cracks following the locations of the reinforcing steel. This is reasonably due to the corrosion of the reinforcing steel in the thin pre-cast shell elements. This may be due to:

- Inadequate cover to the reinforcement as the thickness of the shell is only 70mm, which cause the carbonation of the concrete to be facilitated
- Use of light weight concrete which is usually porous which is more permeable to water and carbon dioxide causing carbonation of concrete. The water vapor source can be from the spectators and athletes respiration or slight infiltration from the top of the dome if it was appropriately painted with water repellants.
- The use of low quality or round, un-graded aggregates used in the concrete mix causes the porosity of concrete.
- Inadequate curing as the pre-cast shell elements that makes the concrete porous.
- Inadequate compaction,



Figure 8.20 grid cracks of the under side of the thin reinforced concrete shell elements

Further studies on what the real cause of the problem, the current condition and safety level of this thin shell reinforced concrete should be made.

9. CONCLUSIONS

The decision on which modern reinforced concrete structures are heritage and should be preserved is a very difficult one and more studies are needed. It is generally can be told that, since reinforced concrete is a comparatively new construction material (~100 years old), most of the durability problems, testing methods, repair and strengthening methods etc of reinforced concrete structures shall be considered for heritage reinforced concrete heritages with certain limitations based on the principles of conservation of heritage structures (such as ICOMOS) and the repair principles of reinforced concrete structures such as EN1504.

There are comparatively many factors for the deterioration/distress of reinforced concrete heritage structures. Majority of the problems originate from the construction materials used at the time that helps the ingress of other environmental factors that aggravates the deterioration of concrete. Of all the factors that affect the durability of reinforced concrete heritage structures, reinforcement corrosion is the major factor. Further more, Alkali aggregate reactions and freeze thaw cycles. Overloading of the structures is also becoming very common these days due to the change in use of the structures and unexpected events such as earthquakes.

The assessment, design and repair of reinforced concrete heritage structures are more complex than for new construction. This needs a better understanding of the mechanism involved in concrete deterioration as they may relate to environmental conditions in which structures perform; of the effects of material modifications, and of the controlling parameters of new composites. The repair methods to be applied on the structure mostly combines two or methods of repair. Cathodic protection seems to be appropriate to repair corrosion caused deterioration of concrete, if it is combined with patching of the deteriorated concrete substrate. FRP can be used in the upgrading of load bearing reinforced concrete structural members, as it doesn't change the dimension of the structure and due to its higher strength. All other strengthening methods can be applied on the structure but taking in to account their preference and durability in the long run and their compatibility with conservation principles.

Compatibility of repair materials and substrate concrete is essential not only to prolong the durability of the repair but also to maintain the originality/authenticity and the aesthetics of the structure. Material property of the repair material and the substrate concrete, geometry etc should match to attain effective repair for long term with out frequent repairs of the repair.

Modern architecture should as much as possible reduce the use of new materials (e.g. FRP, repair mortars,...), whose long term performances are not fully understood, and techniques in the repair and restoration of reinforced concrete heritage structures. To minimize the common problems of repairs, architects and engineers should work together to get an effective repair.

Focusing on high performance/strength new repair materials may lead to unacceptable damage to the substrate concrete even though the new materials will address some of the durability problems in construction. The effectiveness of these new repair materials should be tested and maximized in the field applications on the existing structure instead of only laboratory tests.

The available new repair materials and techniques that are used in reinforced concrete structures can be applied to historic reinforced concrete provided that it is compatible with the old concrete and its long term performance is understood and the guidance and control is governed by the conservation principles of heritage and repair principles of reinforced concrete structures.

The conservation principles of heritage structures from recommendations are difficult to attain in reinforced concrete heritages structures. This means that some flexibilities on the principles should be made and it should be combined with the repair principles for the repair of reinforced concrete structures (EN 1504) to get a conducive principles for future repairs.

Durability problems of reinforced concrete did not sustain for long time like masonry heritage structures, and thus repair can't be delayed to see the causes of deterioration as the damage or deterioration or distress will propagate easily and reach the reinforcement level leading to corrosion of the reinforcement and further damages.

For any reinforced concrete heriatge structure, preventive maintenance is preferable to repair or replacements of part or all of the structure, which has shown bad experiences in the past. The preservation of reinforced concrete heritage needs deep understanding of the causes of the problems, thier repair methods and materials that thier performance are understood. Architects and engineers should work together to preserve the reinforced concrete heritage structures with out compromising thier identity to pass the heritage structures for the coming generations.

Reference:

- [1] Department of the army, U.S army corpse of Engineers, Engineering and design: Evaluation and repair of concrete structures, Washington DC, June 1995
- [2] M. Levitt, Concrete materials, problems and solutions, E & FN Spon, UK, 2003
- [3] Corrosion of steel in concrete, Book details not found but organized by organizations such as ACI, ASTM etc.
- [4] C.A. Apostolopoulos & P.G. Koutsoukos, Study of the corrosion of reinforcement in concrete elements used for the repair of monuments, University of Patras, Patras, Greece, Available online at www.sciencedirect.com
- [5] Shamsad Ahmad, Reinforcement corrosion in concrete structures, its monitoring and service life prediction—a review, Department of Civil Engineering, King Fahd University of Petroleum and Minerals, Dhahran, Saudi Arabia, December 2002
- [6] Dong Chen & Sankaran Mahadevan, Chloride-induced reinforcement corrosion and concrete cracking simulation, Cement & Concrete Composites 30 (2008) 227–238
- [7] Jan Bijen, Durability of engineering structures: Design, repair and maintenance, Woodhead Publishing Limited, England, 2003
- [8] Geoff Mays, Durability of concrete structures: investigation, repair, protection, E & FN Spon, UK, 2003
- [9] Report of a working party: the Concrete Society, Technical Report No.54, Diagnosis of deterioration in concrete structures: Identification of defects, evaluation and development of remedial action, The Concrete Society, 2000
- [10] D. C. K. Tay and C. T. Tam, in-situ investigation of the strength of deteriorated concrete, Elsevier Science Ltd, Construction and Building Materials, Vol. 10, No. 1, pp. 17-26, 1996, GB.
- [11] Emmanuel Roziere , Ahmed Loukili and François Cussigh, A performance based approach for durability of concrete exposed to carbonation, Construction and Building Materials xxx (2008) xxx–xxx, www.sciencedirect.com
- [12] C.A. Apostolopoulos and V.G. Papadakis, Consequences of steel corrosion on the ductility properties of reinforcement bar, www.sciencedirect.com
- [13] Alkali silica reaction, Elkem ASA Materials, Norway
- [14] R. Miguel, Advanced Masters in Structural Analysis of Monuments and Historical Constructions, SAHC 2007-2008, Course material SA6:Restoration and Conservation of Materials
- [15] HYOMIN LEE, ROBERT D. CODY, ANITA M. CODY, AND PAUL G. SPRY, Effects of Various Deicing Chemicals on Pavement Concrete Deterioration , Department of Geological and Atmospheric Sciences, Iowa State University, Ames, Iowa .

- [16] Luca Bertolini, Bernhard Elsener, Pietro Pedferri, Rob Polder, Corrosion of steel in concrete: Prevention, Diagnosis, Repair; WILEY-VCH, Germany, 2004
- [17] J. Sena Cruz, Advanced Masters in Structural Analysis of Monuments and Historical Constructions, SAHC 2007-2008, Course material SA5:Repairing and strengthening techniques
- [18] M.R. Esfahania, M.R. Kianoushb, A.R. Tajaria , Flexural behaviour of reinforced concrete beams strengthened by CFRP sheets, 2006, www.sciencedirect.com
- [19] D. R. Morgan, Compatibility of concrete repair materials Systems, Construction and Building Materials, Vol. 10, No. 1, pp. 51-61, 1996, Great Britain
- [20] Alexander M. Vaysburd & Peter H. Emmons , Corrosion inhibitors and other protective systems in concrete repair: concepts or misconcepts, Cement & Concrete Composites 26 (2004) 255–263
- [21] M. Raupach, Concrete Repair According to the new European Standard EN-1504, RWTH Aachen, ibac
- [22] M. Yasar Kaltakcia, M. Hakan Arslana, Ulku S. Yilmaza, H. Derya Arslan, A new approach on the strengthening of primary school buildings in Turkey: An application of external shear wall Strengthening of primary school in turkey, Building and Environment 43 (2008) 983–990
- [23] Pere Roca, Advanced Masters in Structural Analysis of Monuments and Historical Constructions, SAHC 2007-2008, Course material SA1:History of Construction and of Conservation
- [24] Stephen J. Kelley, The Role of the Engineer in Preservation, *APT Bulletin*, Association for Preservation Technology International (APT), 1991
- [25] Figeys, W., Schueremans, L., Van Gemert, D., Preservation of the RC-monument 'Vuurmolen' (1902) at Overijse, Belgium,
- [26] US Department of transportation, Federal Highway Administration, Alkali-silica Reaction, <http://www.tfhr.gov/pavement/pccp/pubs/03047/02.htm>
- [27] Portland cement association, Alkali aggregate reactions, Washington DC http://www.cement.org/tech/cct_dur_AAR.asp
- [28] Concrete Experts International ApS, Freeze - Thaw Deterioration of Concrete, Denmark, www.concrete-experts.com/pages/ft.htm
- [29] DRC associates, Concrete Repair and Reconstruction, Genesee Hospital Doctor's Building - Rochester, New York http://www.drc-associates.com/p_concrete_reconstruction.htm

- [30] Kim D. Basham, Concrete cracking, L&M Construction Chemicals, Concrete Engineering Specialists LLC, USA,
<http://www.lmcc.com/news/summer2006/summer2006-04.asp>.
- [31] Pier A Mid Rehabilitation Inc., Chemical Grouts, Houston, USA
<http://www.pier-a-mid.com/grouting.aspx>
- [32] Epoxy.com, A Division of Epoxy Systems Inc, Concrete epoxy ejection, Florida & Vermont, USA
<http://www.epoxysystems.com/injection.htm>
- [33] William B. Coney, Preservation of historic concrete Problems and approaches, Technical preservation services, National park service, U.S Department of the interior, USA
www.nps.gov/history/hps/tps/briefs/brief15.htm
- [34] Wikipedia, www.wikipedia.org
- [35] Understanding Cement, WHD Microanalysis Consultants Ltd, Alkali-silica reaction in concrete, UK,
<http://www.understanding-cement.com/alkali-silica.html>
- [36] Sure-Gro Inc., Ice melting solutions, Ontario, Canada www.icemelter.ca/traction/roofs_e.php
- [37] House of World Cultures, The Architecture, Berlin, Germany
www.hkw.de/en/hkw/gebauede/architektur/index.php
- [38] C.M. Hansson: "Concrete: The Advanced Material for the 21st Century", Metallurgical and Materials Transactions A, 1995, pp.1321-1341,
www.corrosion-club.com/concretehistory1.htm
- [39] Palau Blaugrana, Barcelona, Spain
http://www.fcbarcelona.com/web/english/club/club_avui/territori_barca/palau_blaugrana/palaublaugrana.html,
- [40] Nicolas Janberg ICS., Structurae, Palau Blaugrana
<http://en.structurae.de/structures/data/index.cfm?ID=s0034928>
- [41] International Council of Monuments and Sites (ICOMOS), International Charters for Conservation and Restoration, France,
<http://www.international.icomos.org>
- [42] L C Hollaway and M B Leeming, Strengthening of reinforced concrete structures: Using externally-bonded FRP composites in structural and civil engineering, Woodhead publishing limited, England, 1999
- [43] Susan Macdonald, ICOMOS:20th Century Heritage: Recognition, Protection and practical challenges, Australia
<http://www.international.icomos.org/risk/2002/20th2002.htm#>