

Non-Destructive Evaluation Using Ultrasonic Technique And Distributed Blackboard System

Patrick Wong



Intelligent Computer Systems Research Group

The Open University, 2002.

Goal

The ultimate goal is to prevent these incidents from happening:

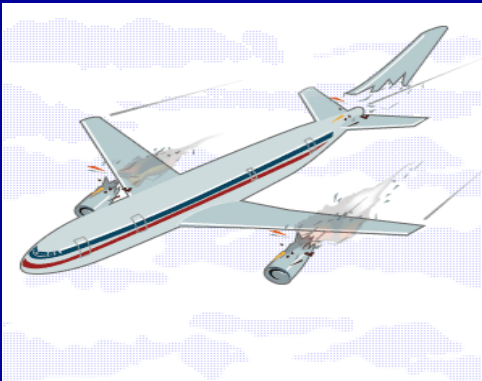

What do these have in common?

Plane Crash

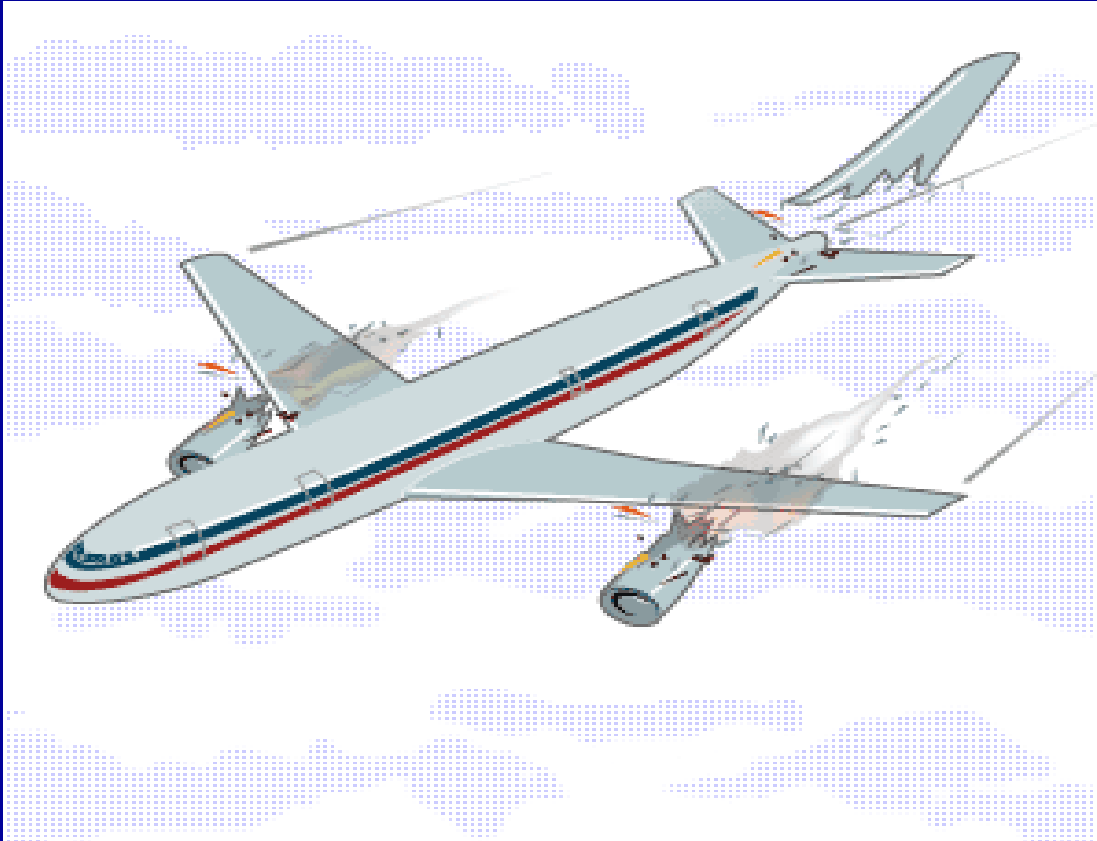

An American Airlines passenger jet (AA587) crashes near John F Kennedy airport killing at least 260 people in October 2001.

Metal failure is the suspected caused of the crash.

Rail Crash



Hatfield train crash killed four people and injured 70 in October 2000.

Crash caused by defected rail.

Sunken Tanker



Tanker Erika sank and released oil which caused serious pollution in December 1999.

Caused by structural weakness.

Causes

What is the main cause of these disasters?

Cracks

Non-destructive Evaluation

- **Ultrasonic Inspection**
can visualise the inside of a metal specimen without damaging it.
- **Image Creation**
record the ultrasonic data and produce an visible image.
- **Evaluation**
using AI techniques to evaluate the ultrasonic image.

Equipment

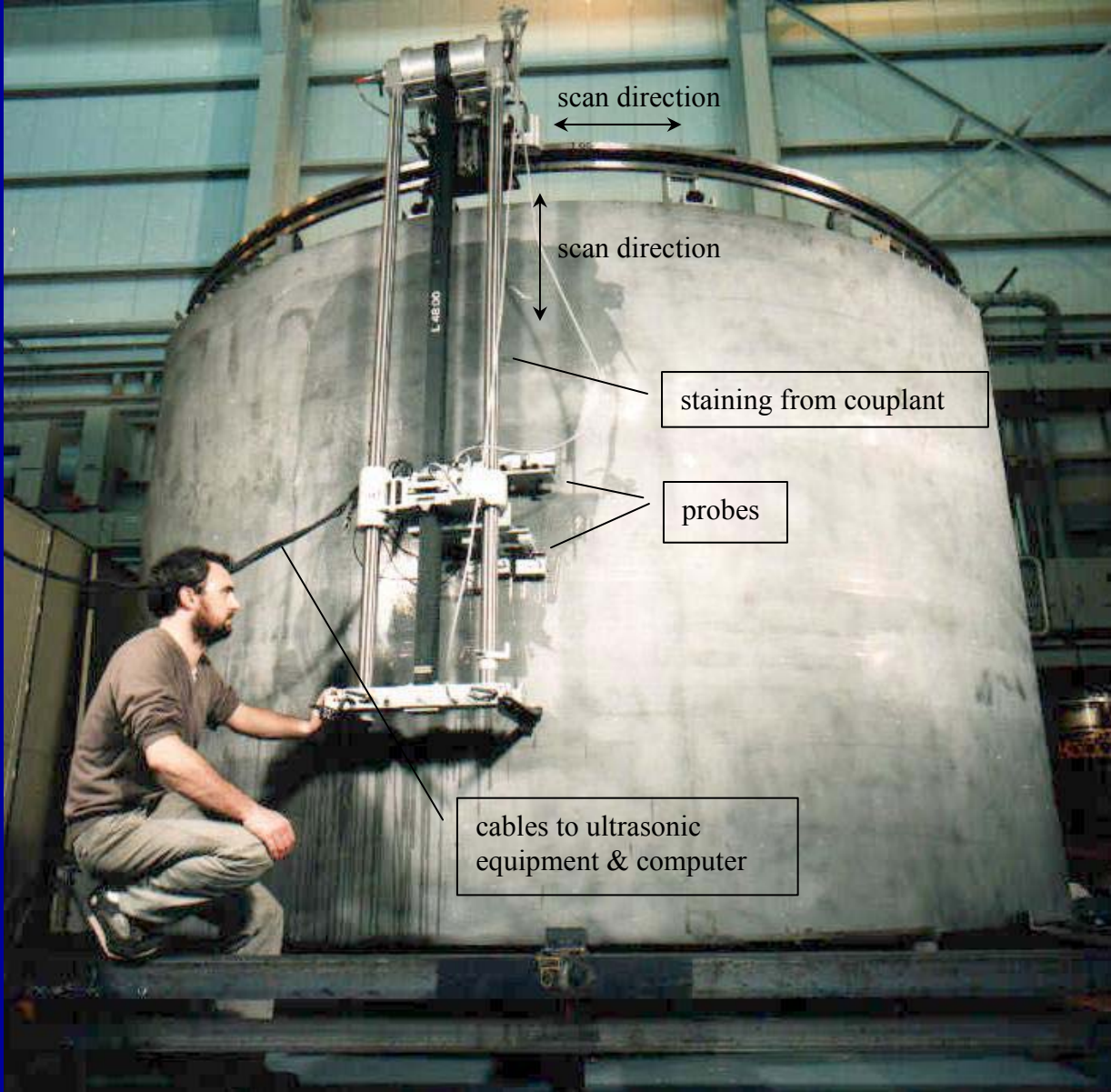

My Demonstration

- To find hidden cracks inside this ferritic steel plate.
- An array of ten transducers scanned across the surface of the plate in a raster fashion.

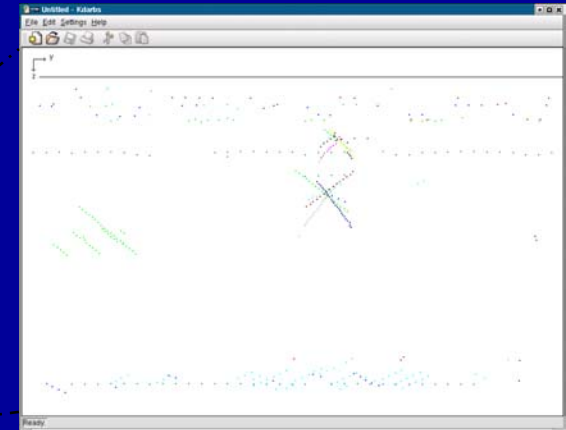
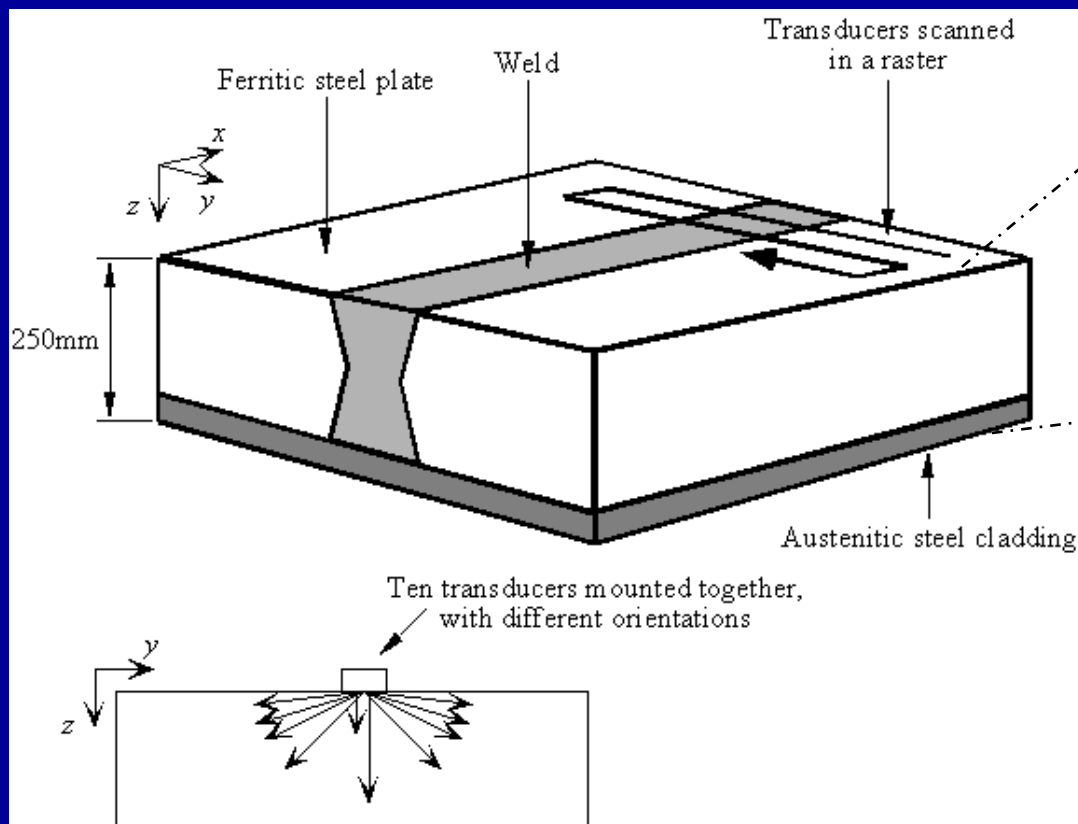

B-Scan:
Cross-section view

My Demonstration Continue

- A 2-D image of the cross-section view of the specimen is produced each pass of the probes across the surface of the plate.
- To reduce the effect of noise, only indications of intensity $> -30\text{dB}$ were recorded.
- Echoes caused by a defect in the specimen leads to a feature in the image, but features may also occur which are not directly associated with defects.

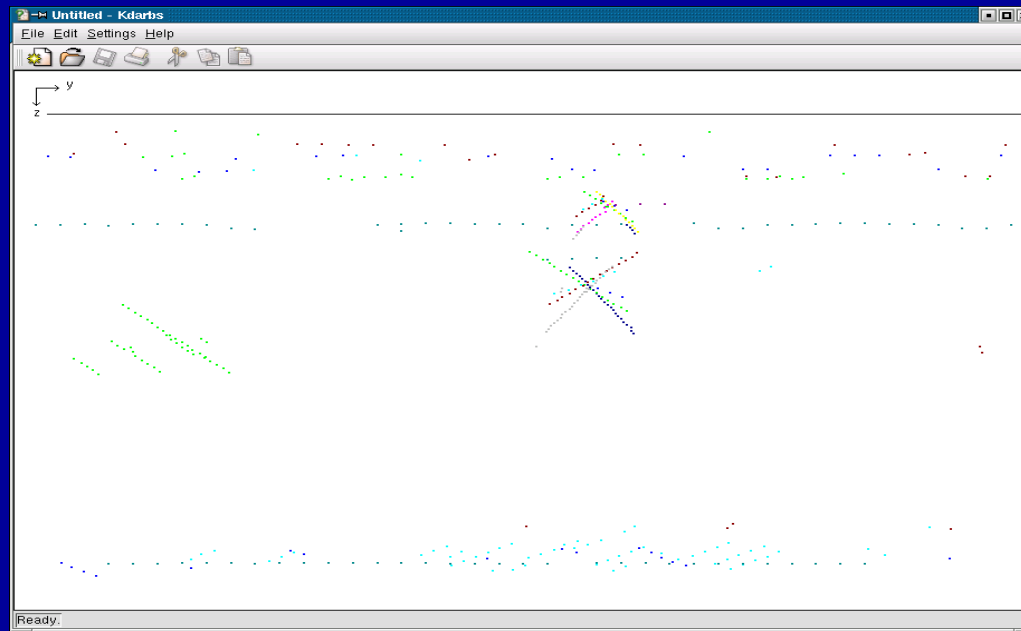

Stages of interpretation

- Find lines of indications

These lines are caused by echoes from a point in the sample detected by a transducer in contiguous positions.

- Extract readily identifiable features

Some features may be immediately identified, such as the “back wall” or the reverberations in the transducers.

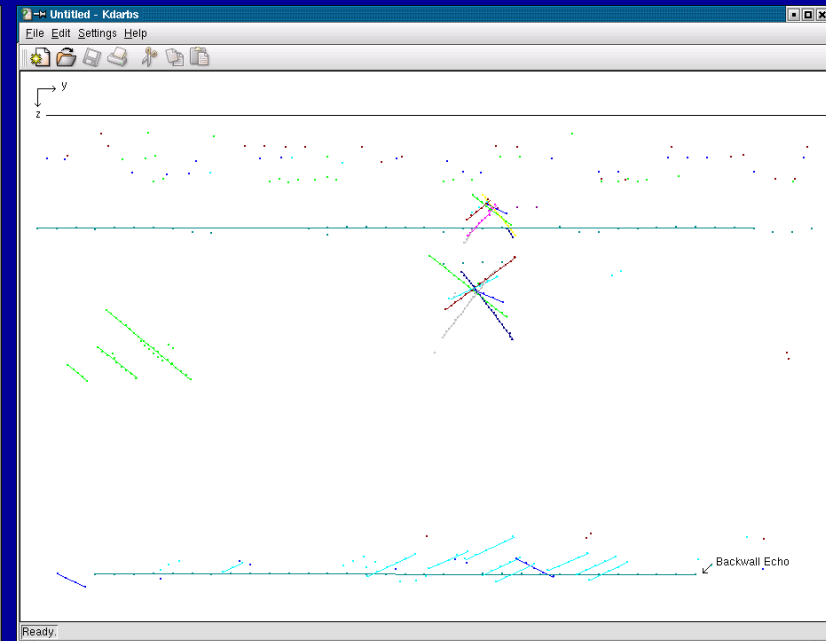
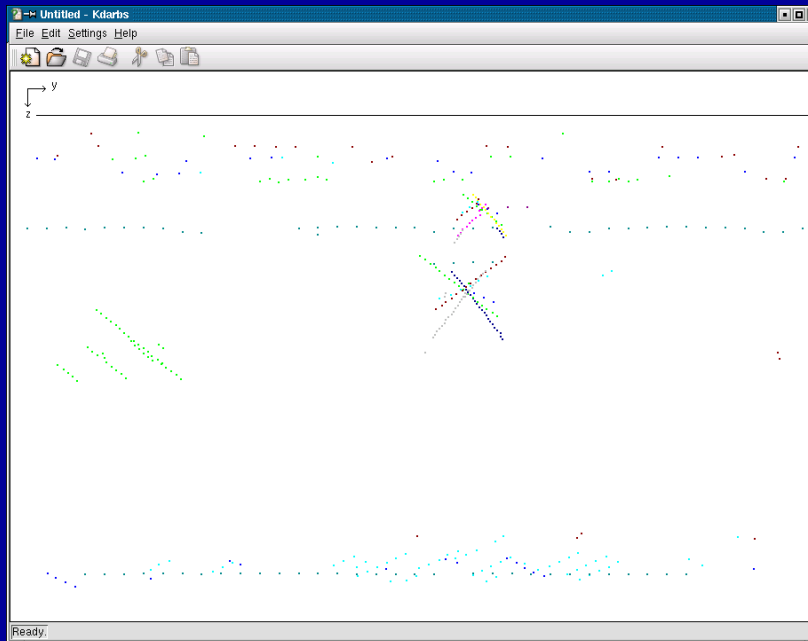

Stages of interpretation Continue

- **Locate and classify possible defect areas**
Areas of intersection of lines are often indicative of the presence of a defect. Local information can be used to classify defects.
- **Look for verification**
non-local factors such as the intensity profile of the back wall can be used to verify the defect.

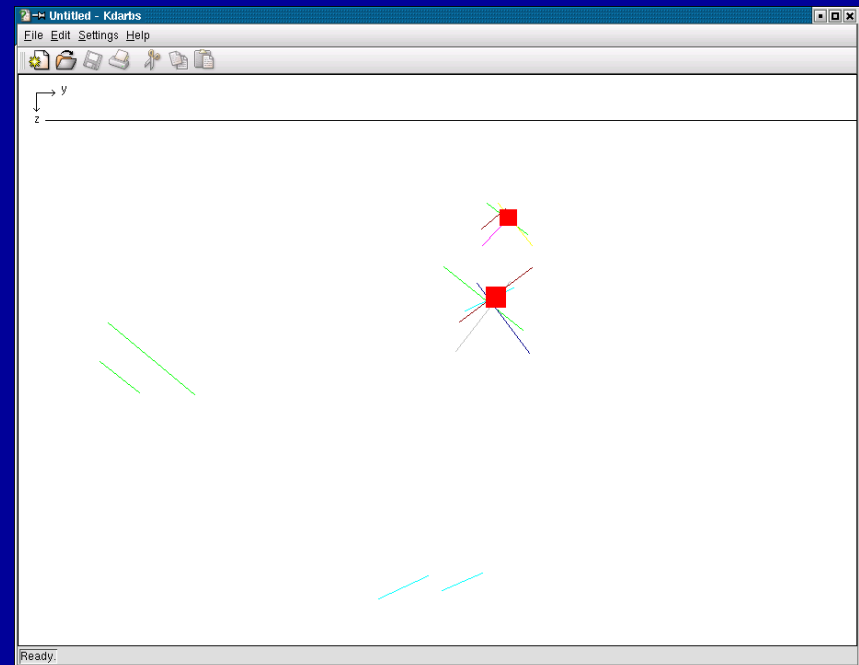
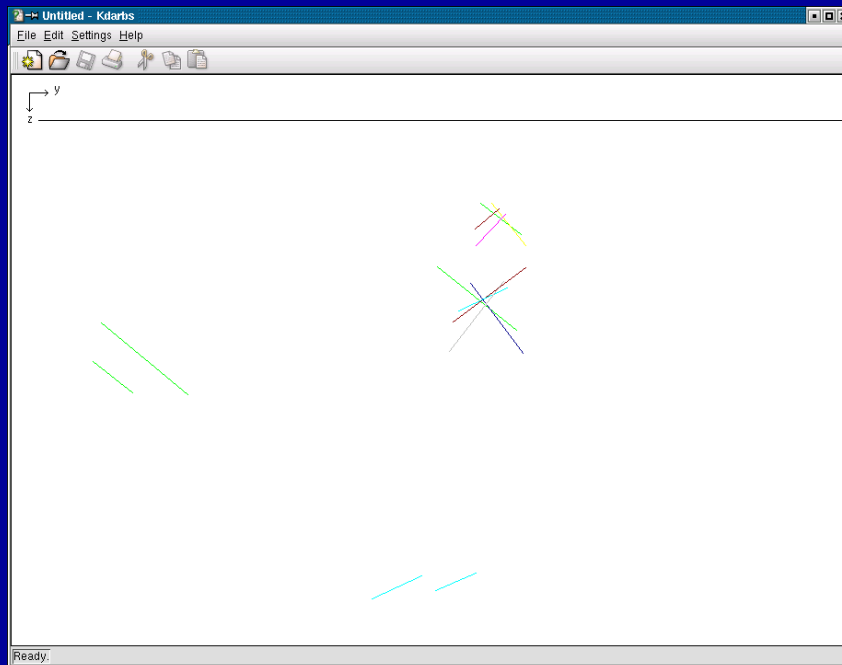

Stages of interpretation: 1

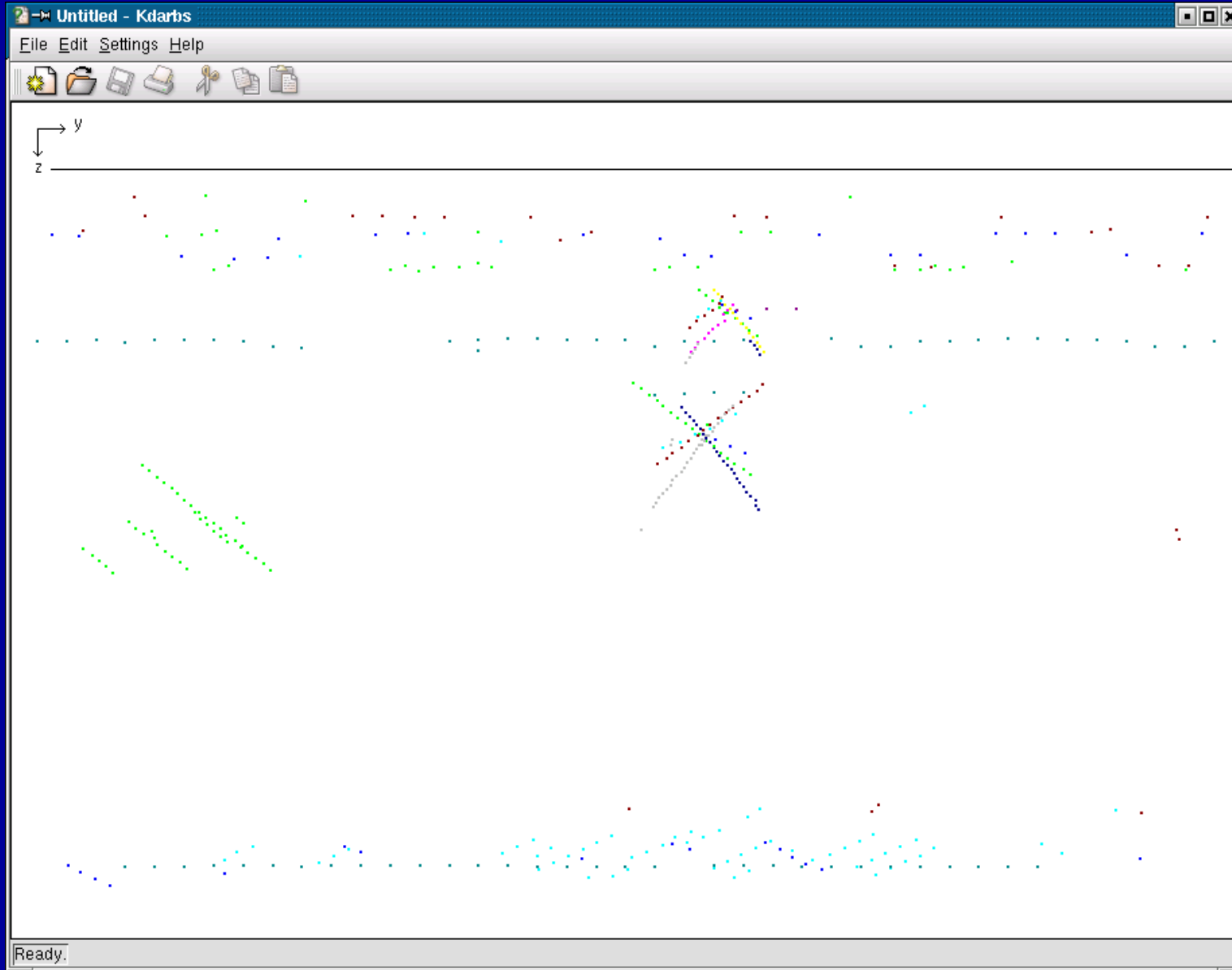

Stages of interpretation: 2

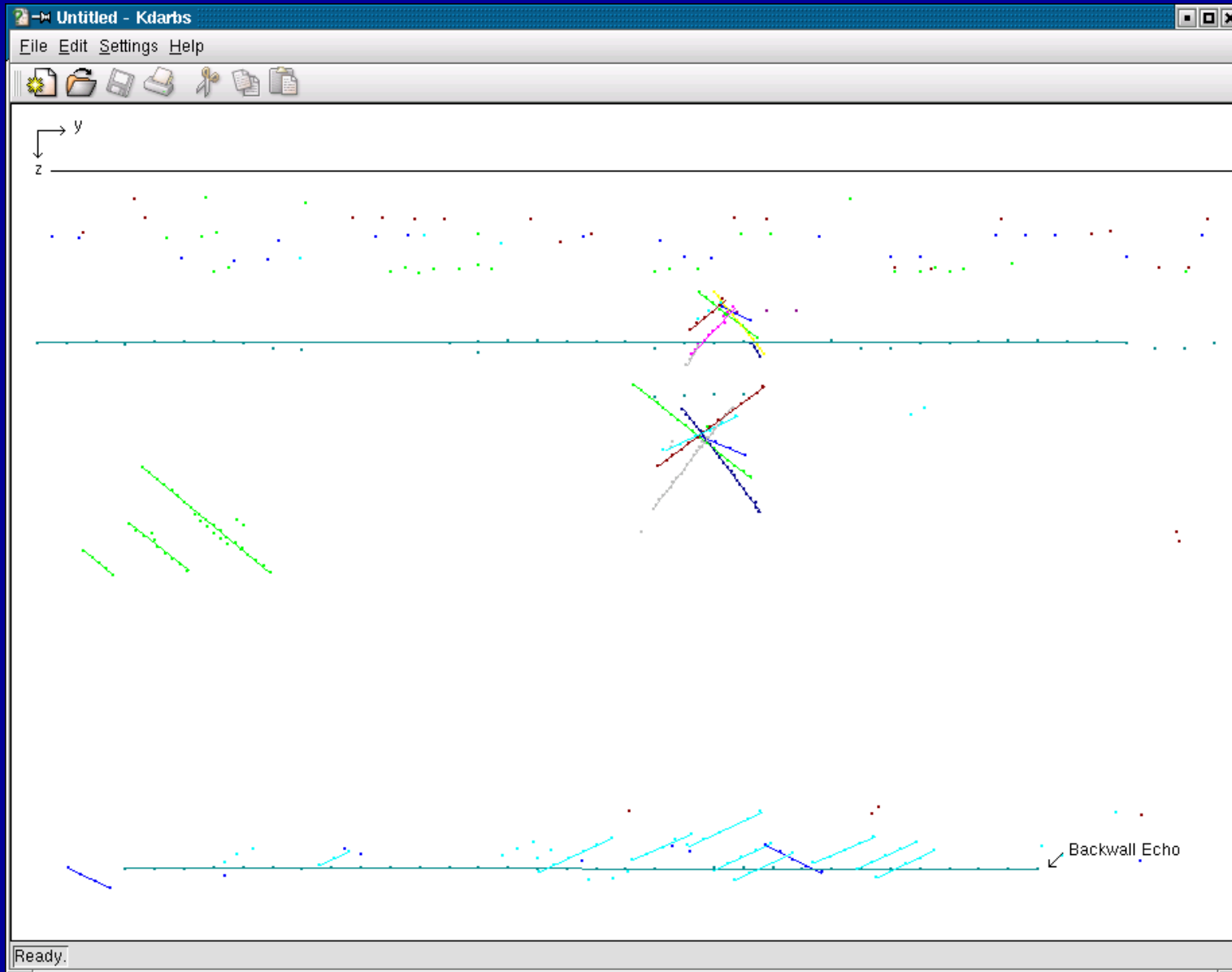

Stages of interpretation: 3

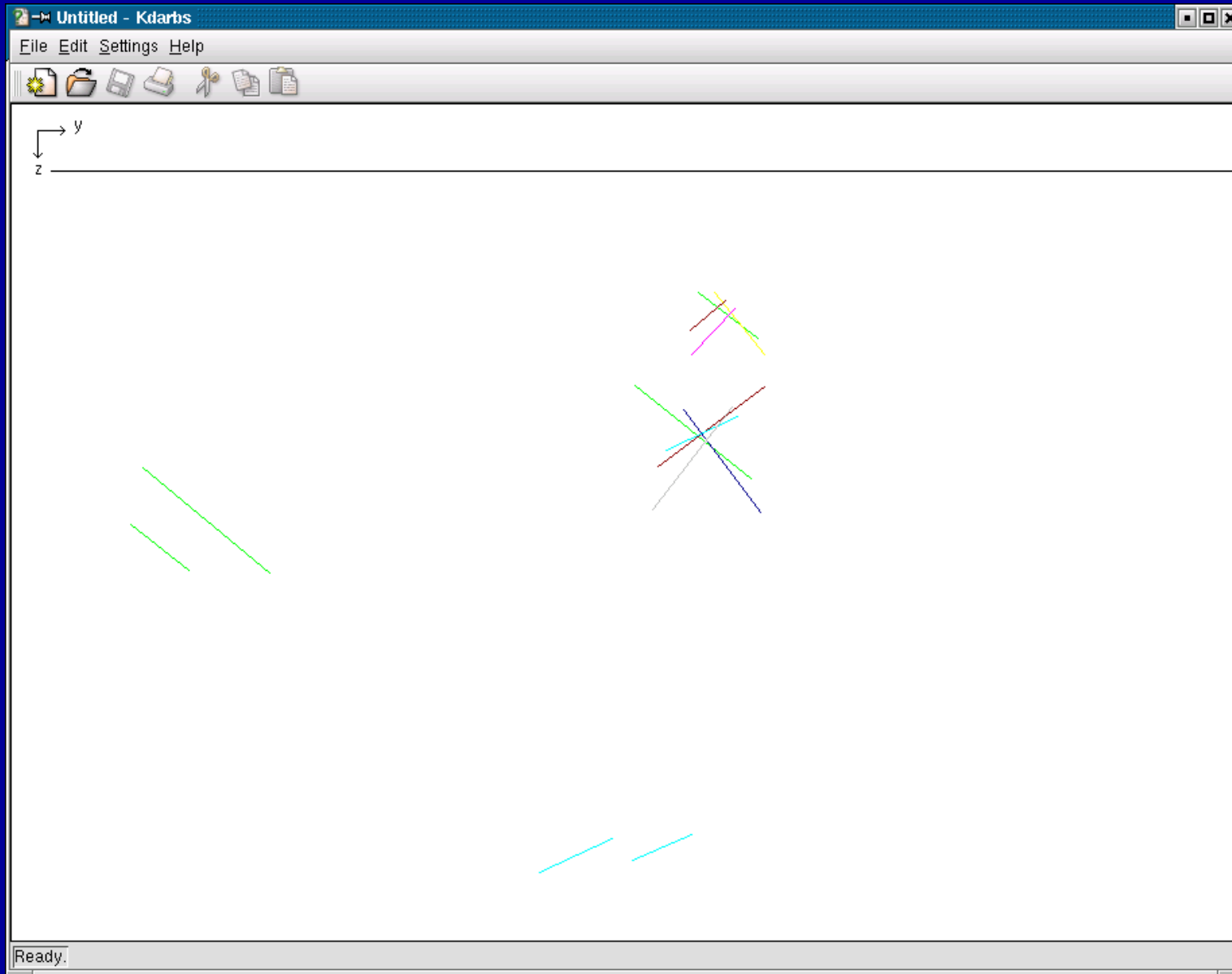

Stages of interpretation: 4

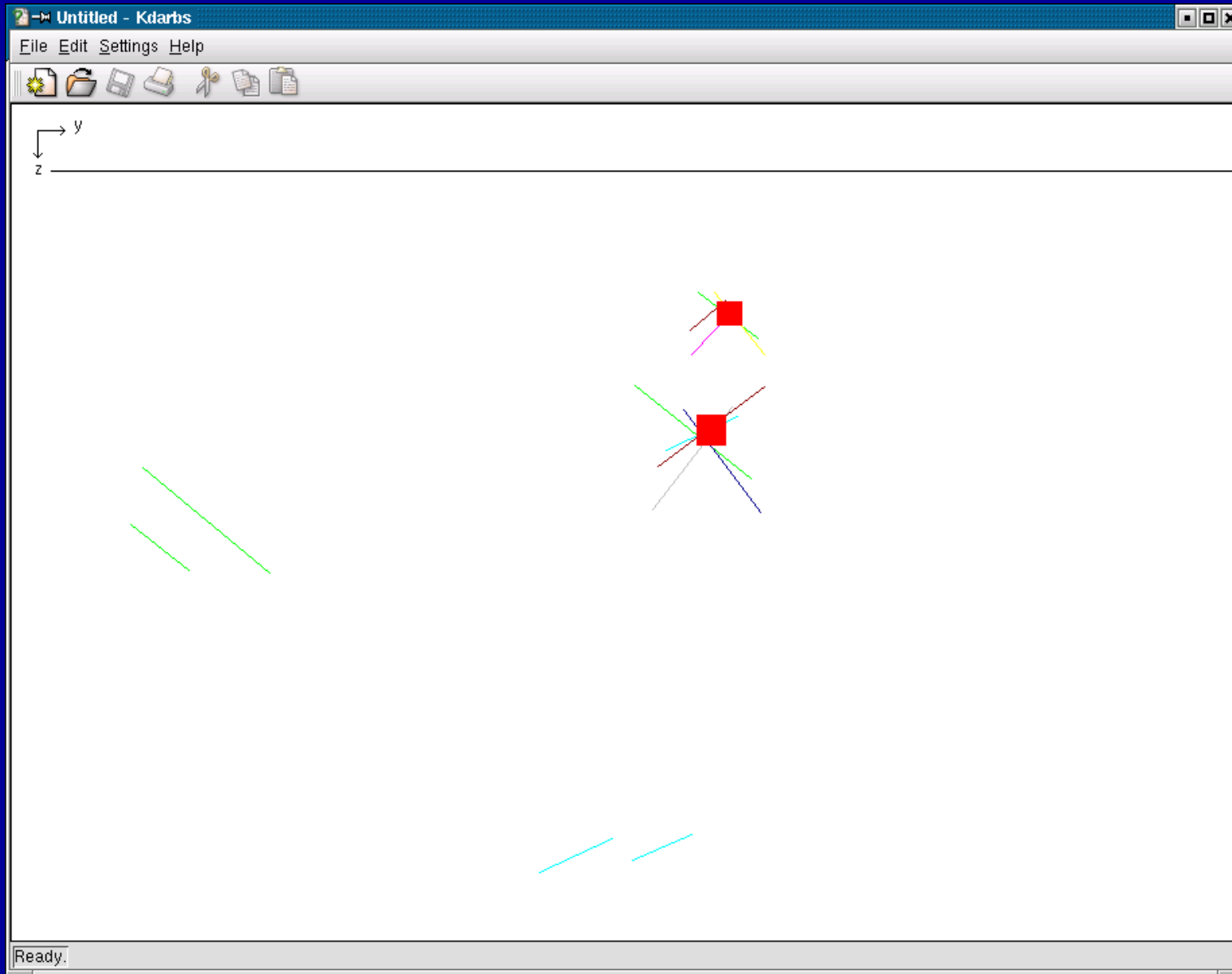

Demonstration

Which scan do you want to see?

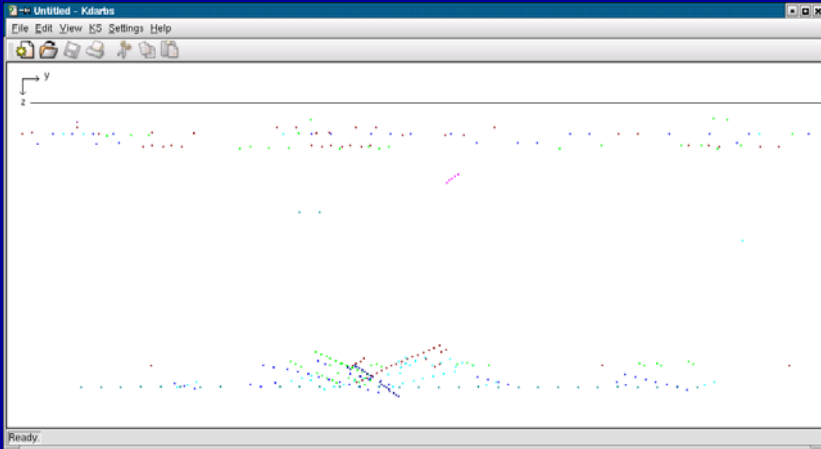

Scan Number 2

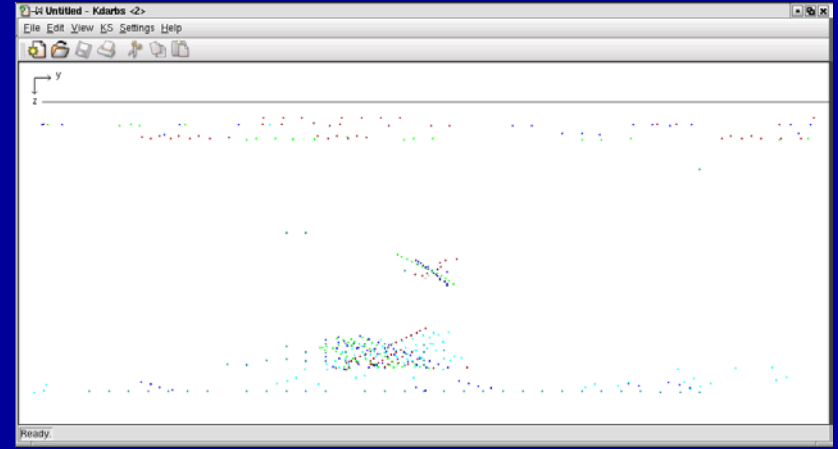

Scan Number 7

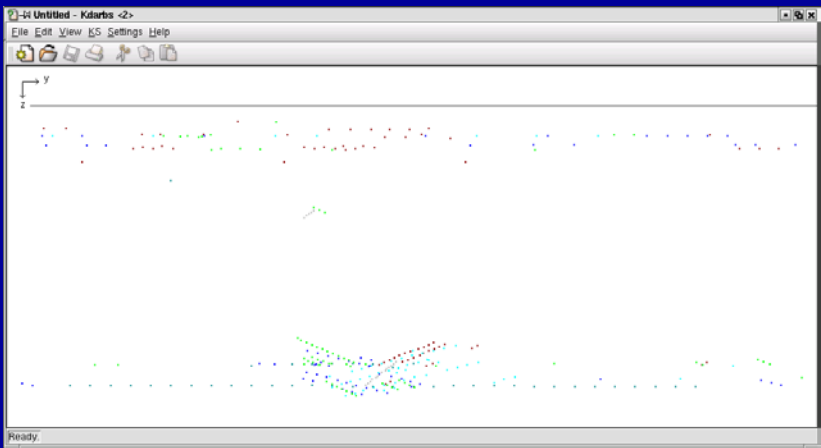

Scan Number 3

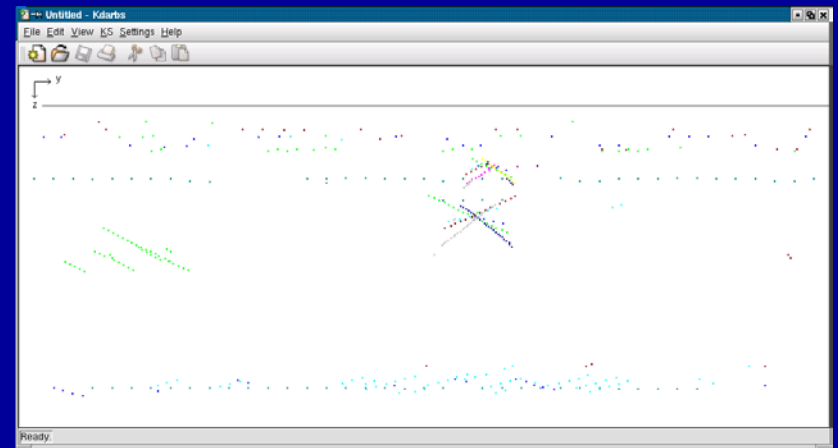

Scan Number 8

Acknowledgements

- ARBS & Ultrasonic phase 1
 - Neil Woodcock, Nicholas Hallam, Adrian Hopgood
- DARBS
 - Lars Nolle (Blackboard Server)